

Exploring design principles of biological and living building envelopes: what can we learn from plant cell walls?

Yangang Xing, Phil Jones, Maurice Bosch, Iain Donnison, Morwenna Spear & Graham Ormondroyd

To cite this article: Yangang Xing, Phil Jones, Maurice Bosch, Iain Donnison, Morwenna Spear & Graham Ormondroyd (2017): Exploring design principles of biological and living building envelopes: what can we learn from plant cell walls?, Intelligent Buildings International, DOI: [10.1080/17508975.2017.1394808](https://doi.org/10.1080/17508975.2017.1394808)

To link to this article: <https://doi.org/10.1080/17508975.2017.1394808>



© 2017 The Author(s). Published by Informa UK Limited, trading as Taylor & Francis Group



Published online: 21 Nov 2017.



Submit your article to this journal [↗](#)



View related articles [↗](#)



View Crossmark data [↗](#)

Exploring design principles of biological and living building envelopes: what can we learn from plant cell walls?

Yangang Xing^a, Phil Jones^a, Maurice Bosch^b, Iain Donnison^b, Morwenna Spear^c and Graham Ormondroyd^{c,d}

^aWelsh School of Architecture, Cardiff University, Cardiff, UK; ^bInstitute of Biological, Environmental and Rural Sciences (IBERS), Aberystwyth University, Aberystwyth, UK; ^cBioComposites Centre, Bangor University, Bangor, UK; ^dDepartment of Architecture and Civil Engineering, University of Bath, Bath, UK

ABSTRACT

A number of innovations in building envelope technologies have been implemented recently, for example, to improve insulation and air tightness to reduce energy consumption. However, growing concern over the embodied energy and carbon as well as resource depletion, is beginning to impact on the design and implementation of existing and novel building envelope technologies. Biomimicry is proposed as one approach to create buildings which are resilient to a changing climate, embedded in wider ecological systems, energy efficient and waste free. However, the diversity of form and function in biological organisms and therefore potential applications for biomimicry, requires a holistic approach spanning biology, materials science and architecture. It is considered timely to re-examine opportunities to learn from nature, including in the light of recent understanding of how plant form and function are determined at the cellular levels. In this article, we call for a systemic approach for the development of innovative biological and living building envelopes. Plant cell walls are compared to building envelopes. Key features of cell walls with the potential to inform the development of design principles of biological and living building envelopes are identified and discussed.

ARTICLE HISTORY

Received 9 August 2016
Accepted 24 September 2017

KEYWORDS

Adaptability; energy conservation measures; ecological design; intelligent building; green building; biomimicry; biomimetics; adaptable facade; plant cell wall

Introduction

The building envelope has been a significant element of human settlements since the rise of civilization. It plays a dominant role in the exchange of heat and fresh air, provides views and daylight, and protects the indoor environment and occupants against extremes of temperature, solar radiation, water and wind. Vernacular building envelopes relied on local resources such as earth, timber, bamboo or stones. However modern building envelopes have utilized iron and steel over the last century, and modified glass over the last few decades. Some materials have come into new eras, for example, while the Romans used cement to make concrete, and to achieve radical new structures such as domes, arches and vaults; modern Portland cement differs materially in several ways. For example, the change to hydraulic lime in Portland cement in the eighteenth century increased industrial efficiency of production (compared to Roman lime or gypsum alkali cements), a wider range of aggregate is used depending on application, and the use of steel reinforced concrete to increase tensile and

CONTACT Yangang Xing  xingy5@cardiff.ac.uk, xygnet@hotmail.co.uk

© 2017 The Author(s). Published by Informa UK Limited, trading as Taylor & Francis Group
This is an Open Access article distributed under the terms of the Creative Commons Attribution-NonCommercial-NoDerivatives License (<http://creativecommons.org/licenses/by-nc-nd/4.0/>), which permits non-commercial re-use, distribution, and reproduction in any medium, provided the original work is properly cited, and is not altered, transformed, or built upon in any way.

bending performance of the material has greatly extended the usefulness of concrete (Morgan 1977). Timber structures have also entered a new era utilizing modern manufacture methods such as glue lamination and cross-laminated timber (CLT) to allow new designs, long spans and tall timber buildings (Bjertnaes and Malo 2014; Epp 2016). In 1981, Davies proposed the concept of a 'polyvalent wall' with multiple layers of glass materials which can generate enough energy for the building (Davies 1981). Recently, building envelopes have been used to generate energy. Building integrated photovoltaic (BIPV) approaches have been developed as more affordable building wall solutions (Xing, Hewitt, and Griffiths 2011).

Recent changes in building regulations (such as Part L in the UK, and European directives such as the Energy Performance of Buildings Directive (2010/31/EU), and the Energy Efficiency Directive (2012/27/EU)) have promoted the use of more insulation materials and higher air-tightness of buildings (Jelle 2011; Xing, Hewitt, and Griffiths 2011). It is generally recognized that the operational energy performance of both new and existing buildings will be improved dramatically through the use of more insulation. However, what is often overlooked is the increased embodied energy and carbon of many building materials, including synthetic insulation products – mineral wool and plastic foams (Giesekam et al. 2014). Moreover, some researchers have argued that high insulation may have adverse effects during summer in certain climate conditions (Stazi et al. 2015). Resource intensive building design strategies (e.g. those containing over-sized insulation fabrics and service engineering systems) have a significant deficiency when considering embodied energy and carbon, which may lead to material depletion, unless a step change can be made in the sourcing of building materials from renewable sources. The current resource depletion coupled with an increasing demand for new buildings, due to rapid population growth and urbanization worldwide, is leading to a number of environmental, social and economic issues. Current research efforts into sustainable design practices are dominated by reductive approaches and hence their applicability to a complete holistic design approach within architecture remains elusive (Gamage and Hyde 2012).

The climate is changing at an unprecedented rate, and may impose tremendous challenges for future buildings (Xing, Lannon, and Eames 2013). Researchers have argued for a more holistic approach to the design of buildings, considering all energy and sources of impacts (including food and waste) (Vale and Vale 2010) using a whole ecosystem approach (Garcia-Holguera et al. 2016) as well as addressing societal changes (Xing 2013). The built environment has been considered as a key element in ensuring the health and wellbeing of the population, reducing energy consumption and carbon emissions. Therefore, new buildings need to be designed and constructed to be adaptable and resilient to future climate change and fluctuations, with the existing building stock retrofitted to achieve the same.

Through billions of years of evolution, nature has generated some remarkable systems and substances that have made life on earth what it is today. In order to remedy the destructive effects of buildings, researchers have argued that it is important to create buildings resembling ecosystems to increase resource efficiency and create cyclic resource loops (Benyus 2002; Pawlyn 2011; Gamage and Hyde 2012; Zari, Pedersen Zari, and Zari 2015). Such learning from nature, or biomimicry, provides a platform to create a new generation of environmentally friendly and sustainable materials and systems. It is therefore critical to change the views on the development of building technologies and regulations based on nature's wisdom to create buildings adaptable to the changing environment and closely linked to ecosystems (Zari, Pedersen Zari, and Zari 2015).

Plants are constantly exposed to different environmental conditions. Being essentially sessile organisms (i.e. fixed to the same habitat during their entire life cycle, with their only chance of dispersal through their seeds), plant survival is crucially dependent on adaptation to the changing environmental conditions over a day and also between days, seasons and years. Recent advances in plant science have uncovered the dynamic yet co-ordinated regulation of stress responses, processes of growth, development and reproduction (Satake, Sakurai, and Kinoshita 2015). Buildings can also be described as sessile (usually fixed to the same location). Both buildings and plants have to be resilient and adaptable to the surrounding environments; therefore, there are potential

opportunities to discover synergies between plants and buildings and identify potential biomimetic solutions.

Ultimately, a plant's adaptation to environmental stresses and conditions depends on responses taking place at the cellular level. Plant cell walls are one of the defining differences between plant and animal life forms, and the presence of these walls is a primary contributor to the evolution of land plants as sessile organisms. The cell walls provide support, act as defensive layers, are conduits for information, and are a source of signalling molecules and developmental cues. The cellular structure of plants was discovered by Robert Hooke in 1665, and since this time the structure and function of the cell walls have been studied in detail at cellular, genetic and molecular levels. Inspired by the structure of plant cells, which is defined by their cell walls, a 3D-printed soft chair was created using recyclable material (Martin 2014). In addition to the mechanical properties, plant biomass also exhibits good thermal insulation properties. The cellular structure of cork has long been recognized as a thermal and electrical insulator. The pith of many other plants can be used for similar purposes, such as panels derived from hemp or flax shiv for lightweight structural or insulation boards. Development of foamed insulation materials from either synthetic or bio-derived polymers is an attempt to improve upon foams demonstrated in nature, by increasing thermal insulation towards a conductivity of synthetic materials such as polyurethane foam or glass wool (25–45 $\text{mWm}^{-1}\text{K}^{-1}$; Papadopoulos 2005), for example, tannin foams have now demonstrated thermal conductivity of 75 $\text{mW m}^{-1}\text{K}^{-1}$ (Tondi et al. 2016). Other bio-based insulating materials rely on natural fibres to provide loft for a low density batt or mattress of randomly aligned fibres (Kymalainen and Sjoberg 2008). Not surprisingly, the use of cell wall biomass for developing energy efficient and low cost construction materials is an emerging field in building construction and civil engineering (Vo and Navard 2016).

Plant cell walls have remarkable similarities with building envelopes in terms of providing structural support and protection from the external environment. However, there is a lack of research into learning from plant cell walls to inform the philosophical debate of the development of resilient building envelopes. The authors argue that building envelope design research and practices need to learn from the adaptability and dynamic behaviour of plant cell walls. The key aim of this research is to develop a holistic biomimetic approach to facilitate transformation of the building envelope technologies. In this article, multiple functionalities of plant cell walls are reviewed; the analogy between plant cell walls and building envelopes and existing efforts to develop bio-inspired building envelopes technologies are identified; and a set of design principles for biomimicry transition is presented. The article concludes with opportunities and challenges for future development of living biological building envelopes.

A systemic biomimicry design framework: key components and a closed-loop learning process

There is a rich and long history of gaining inspiration from nature for the design of practical materials and systems. From the early nineteenth century, architectural designers and engineers have started to imitate the forms, and develop new methods, analogous to the processes of growth and evolution in nature and to apply aspects of biological thinking in innovative designs in general (Steadman 2008). Researchers have also formed concepts around innovative biomimetic designs for building applications (Vogel 2009; Vincent 2009). A number of terms have been used to describe the process of learning from nature, and they are often used interchangeably, each with a slightly different focus or starting point. For example, biomimicry promotes thinking of a building as a living entity (Benyus 2002). Biomimetics, on other hand, a term coined by Otto Schmitt in the 1950s, emphasizes the transfer of ideas and analogues from biology to technology (Schmitt 1969). A special branch of biomimetics is phytomimetics which deals with plant-inspired materials, structures and movements (Stahlberg 2009).

There are two general biomimetic design processes, that is, a top-down approach (technology pull), and a bottom-up approach (biology push). The top-down approach starts from defining human needs or a design problem and looking at ways in which ecosystems can provide solutions. The bottom-up approach starts from identifying a particular behaviour or function of an ecosystem and translating that into designs and products (Aziz and El sherif 2016). Researchers have argued that the linear approaches (i.e. top-down or bottom-up) of biomimetics may only be sufficient if the focus is on the abstraction of single functions (Knippers and Speck 2012). To design, construct and maintain a building is a complex process which cuts across many disciplines and practices requires systemic solutions.

Classifications of biomimetic design goals have also frequently focused on the outcomes obtained. A commonly used classification is comprised of three main fields: structural biomimetics (i.e. constructions and materials in nature), procedural biomimetics (i.e. processes in nature) and informational biomimetics (i.e. principles of evolution and information transfer in nature) (French 2014; Gebeshuber, Gruber, and Drack 2009). Mimicry of form or a single function are the most common biomimetic principles reported, but these will have un-intended consequences and limited impact for achieving the requirements of holistic building design. Mimicking biological processes and systems is harder to achieve, but will deliver greater impact (Garcia-Holguera et al. 2016).

We propose that the ideal biomimetic design process is to use an iterative closed-loop multi-disciplinary learning process (as presented in Figure 1). The key components of learning process include: (1) to identify biological analogies as a foundation of future biomimicry design; (2) to establish novel design principles, and related technologies; (3) to develop and test prototypes. In order to avoid following a linear and single function view, this iterative learning process (Figure 1) emphasizes the use of integrated biomimetic methods to stimulate biologists, architects and engineers to develop fundamentally new research strategies and actions identifying new analogies and new design principles and testing prototypes.

Inspirational biological analogies of living building envelopes – plant cell walls

One key element in the biomimicry research is to discover biological analogies of living building envelopes so that to stimulate the creation of the prototypes. Multiple functions of plant cell walls are explored in this article, which identify parallels for the future application of cell wall biomimetics within architecture. A number of plant survival strategies to cope with changing environmental conditions have been identified, such as adjustment of the timing of flowering in response to seasonal changes in day length, to transportation dynamics of essential micronutrients (Satake, Sakurai, and Kinoshita 2015). It is recognized that the multi-functionality of biological composite materials is usually achieved based on a complex hierarchical architecture from nano- to macro-scale (Dunlop

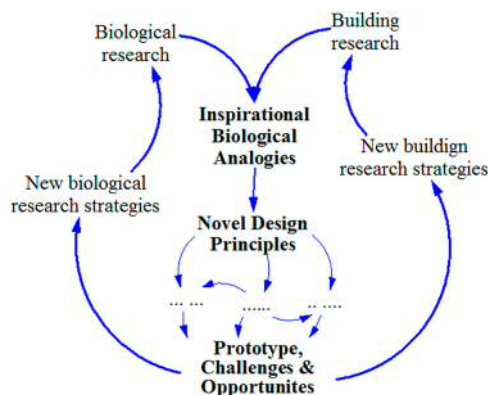

Figure 1. A systemic biomimicry design framework.

and Fratzl 2010). With the developments of micro-scale engineering in the physical sciences and advances in micro biology, (Sarikaya et al. 2003), we propose that great potential lies in the learning from plants at the micro levels (e.g. cellular level in this article), to inform future resilient building design.

The analogy between plant cell walls and building envelopes might at first appear to rely only on their common role as providers of protection and structural functions: strength, support, enclosing spaces, and resistance to dynamic load. Indeed, plant tissues can provide structural integrity by different routes. Examples include the structural optimization of cell wall components in xylem tissue for load-bearing applications (Cave 1968), or the optimization of parenchyma tissue in shape and cell wall structure to maximize control of turgor pressure, which provides a hydraulic function in plant stem support (Wainwright 1970).

In addition to their structural role (strength of materials, control of turgor pressure and the adhesion between cells which maintains plant integrity); plant cell walls also provide selective permeability of metabolites, enzymes and hormones, as well as facilitate cell to cell communication and recognition, and response to stimuli. All cells have to maintain a certain rigidity to keep their shape and to protect the elements inside. Although, plant cell walls and building envelopes have dramatically different operational principles and mechanisms, they have remarkably similar key functions as shown in Table 1. Here we argue that plant cell walls can provide an inspirational source of design thinking to develop future bio-inspired building envelopes.

Structure, composite, form and functions

Plant cell walls: structure and composition

Our knowledge of plant cell walls is based on an in-depth understanding of its biosynthesis, structure and molecular physiology. In his *Micrographia*, Robert Hooke discovered plant cells: more precisely, Hooke had been viewing the cells in cork tissue and described them as an ‘infinite company of small boxes’ saying that ‘these pores, or cells, were not very deep, but consisted of a great many little Boxes, separated out of one continued long pore, by certain Diaphragms’ (Hooke 1665). Nehemiah Grew and Marcello Malpighi carried out early studies on plant anatomy – revealing the diversity of plant cell types, however understanding of the primary and secondary wall did not emerge until the work of Kerr and Bailey in the twentieth century (Kerr and Bailey 1934). The plant cell wall

Table 1. Biological analogies: plant cell walls and building envelopes.

Analogy in key functions	Plant cell walls	Building envelopes
Protection again external elements	<ul style="list-style-type: none"> • Provide a mechanical protection barrier against biotic stresses (e.g. insects and pathogens) and helps to protect against abiotic environmental stresses (e.g. wind, drought, heat, cold). • Separate interior of the cell from the exterior environment. • Prevent water loss. 	<ul style="list-style-type: none"> • Provide protection against external elements, such as wind, pollution, noise, solar radiation, rain, and cold. • Maintain indoor climate.
Exchange of heat, air and water	<ul style="list-style-type: none"> • Enable transport of substances and information from the cell interior to the exterior and vice versa. • Aid in diffusion of substances into and out of the cell. • Design of pits for fluid flow and control of cavitation. 	<ul style="list-style-type: none"> • Conduits for plumbing, electrical and other services. • Fenestration, ventilation ducting, and passive air and moisture exchange.
To define shape and space	<ul style="list-style-type: none"> • Give the cell a definite shape and structure. • Provide structural support. • Prevent the cell from rupturing due to turgor pressure. 	<ul style="list-style-type: none"> • Define space and function. • Provide structural support and cultural identify.

is a highly complex structure that surrounds cells (as shown in [Figure 2](#)). It is located outside the cell membrane and has a ‘skeletal’ role in supporting the shape and structure of the cell; a defining role in differentiation of cell as one of the many cell types required to form the tissues and organs of a plant; a protective role as an enclosure for each cell individually; and a transport role helping to form channels for the movement of fluid in the plant ([Keegstra 2010](#)). A segment of a stem cross-section in maize shows the diversity of different cell types ([Figure 3](#)). Here sclerenchyma provide linear strengthening to the relatively wide xylem and phloem cells in vascular tissue which are involved in fluid transport. The parenchyma, with relatively shorter and broader cells provide a closed cell foam maintaining the internal shape of the cylindrical stem to resist buckling ([Alexander 2016](#)).

Plant biomass consists predominantly of cell walls, typically 60–70% based on dry matter yield. The cell wall consists of a sophisticated composite structure predominantly based on polysaccharides, the most characteristic component being cellulose (the most abundant organic polymer on earth). Microfibrils of crystalline cellulose, encapsulated in amorphous cellulose, are embedded in a matrix of pectic and hemicellulosic polysaccharides ([Keegstra 2010](#)). Lignin, a heterogeneous aromatic and hydrophobic polymer that lacks a repeat structure ([Boerjan, Ralph, and Baucher 2003](#)), may also be present in the cell wall of some plant tissues where it performs a bulking and an adhesive role. Thus, the wall is assembled into an organized composite of microfibrils and matrix, linked together by both covalent bonds and noncovalent bonds between macromolecules. It was recently shown that xylan, the main hemicellulose polymer in secondary cell walls, slots together with cellulose fibrils as a twofold helical screw ([Simmons et al. 2016](#)), revealing a previously unknown fundamental principle in the assembly of plant cell walls and improving our understanding of the molecular cell wall architecture that makes very strong cell wall structures.

The cell wall composition, architecture, thickness and porosity varies from species to species, and may also depend on cell type and developmental stage of the organism. Cell walls are a dynamic biological barrier that, together with the cell membrane (plasma membrane), separate the interior of all cells from the outside environment. The plasma membrane, mostly composed of lipid molecules, is selectively permeable to ions and organic molecules and controls the movement of substances into and out of the cell ([Furt, Simon-Plas, and Mongrand 2011](#)).

Plant cell walls: composite structure and performance

The cell wall composition and structure give remarkable mechanical performance. Cell shape and cell wall composition are optimized for the role of the cell within the plant. The arrangement of

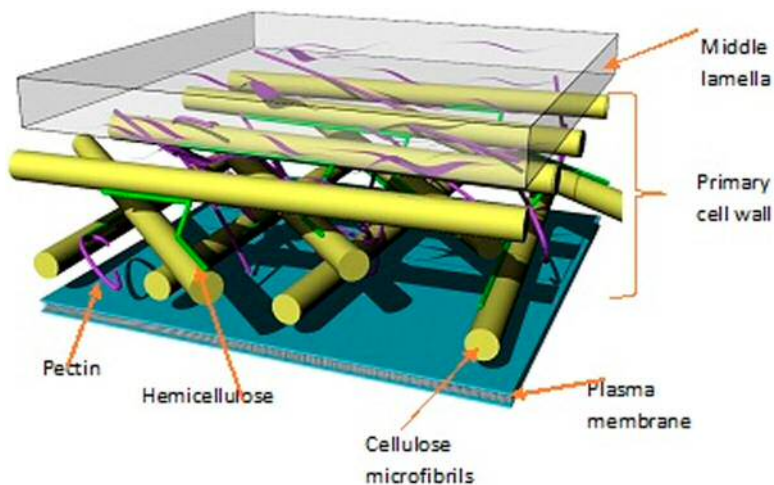

Figure 2. Highly simplified model of the primary plant cell wall (based on [McCann and Roberts 1991](#)).

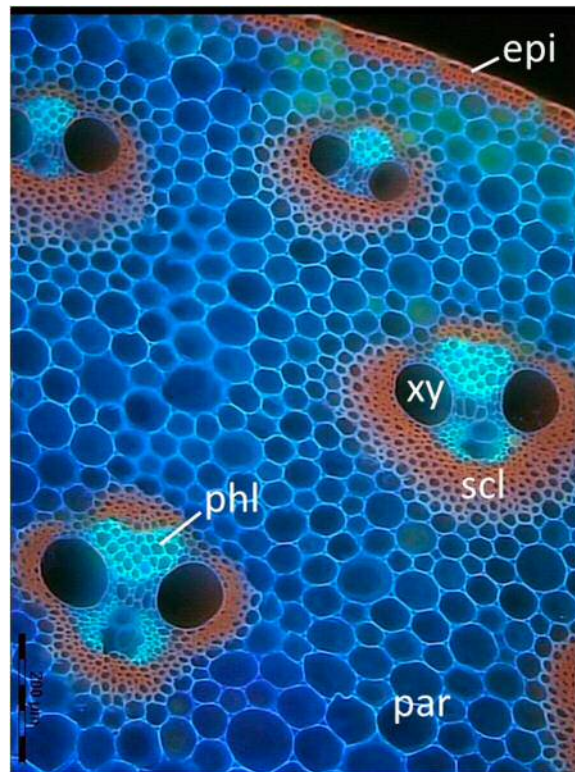

Figure 3. Histochemically stained segment of a stem cross-section of maize.

Notes: Epi, epidermis; xy, xylem; par, parenchyma; phl, phloem; scl, sclerenchyma. Left hand side scale bar is 200 μm .

the four basic building blocks of plant cell walls: cellulose, hemicellulose, lignin and pectin, can result in an exceptionally wide range of mechanical properties in plant tissues; and engineers have thus far failed to achieve the same micro-structural control of composites as that exhibited by plant cell walls (Gibson 2012).

In physical terms, the cell wall is a macro-molecular composite with some analogies to reinforced concrete (Davison et al. 2013), with the chemical complexity and compact organization of cell walls making it extremely resistant to deconstruction (Sarkar, Bosneaga, and Auer 2009). Thin crystalline microfibrils of cellulose provide a reinforcing element within an amorphous cellulose and hemicellulose matrix. Orientation of cellulose microfibrils within each layer of the cell wall is optimized. In most plant cells, the primary role of the cell wall is to act as a pressure vessel (Wainwright 1970), with the combined action of the cells acting as hydrostats to provide the elevation of the plant stem, leaves or flower heads (Ennos 2012). In primary cell wall of parenchyma, where the role of the wall is to provide resistance to hydrostatic pressure, the apparent amorphous alignment of microfibrils actually reflects optimal distribution to resist tension in all orientations, maintaining turgor pressure within the cell. In tracheids and sclerenchyma, where cells are elongated and secondary wall is significantly thicker, the alignment of microfibrils helically around the axis of the cell provides optimal resistance to longitudinal compressive forces, as well as enormous tensile strength. The multiple cell wall layers, and their unique microfibril orientations (Figure 4) combine to provide the mechanical properties of the composite cell wall structure.

Lignified tissues, such as the tracheids of the xylem in softwoods, have been well studied (Figure 4) and the contribution of microfibril alignment within each layer of the wood cell wall to the mechanical properties of the woody tissue as a whole modelled (Mark 1967) to gain insight into the

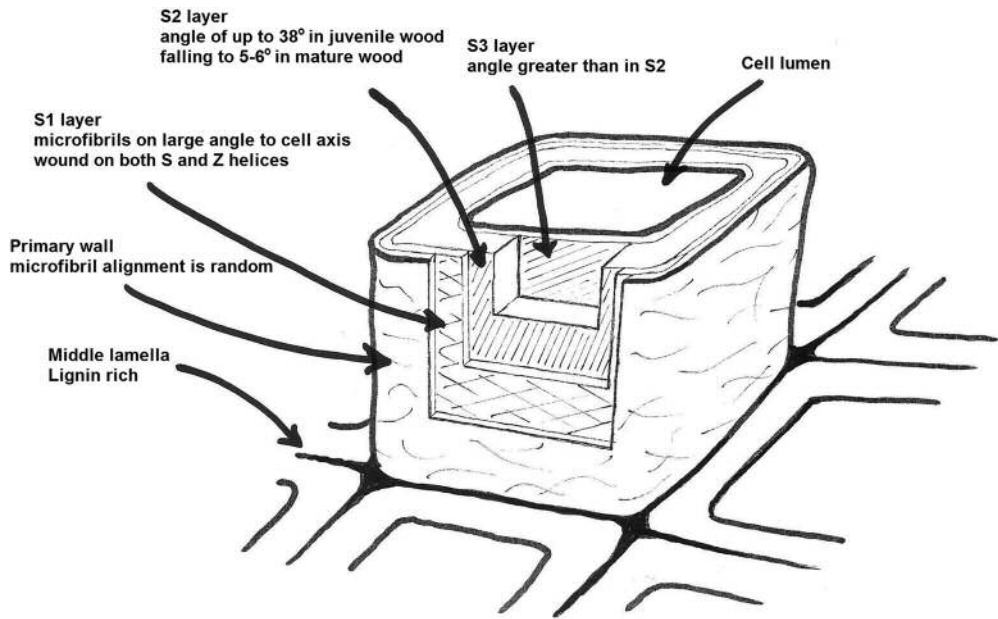

Figure 4. Schematic of a tracheid in softwood xylem, indicating microfibril alignment in the primary and secondary cell wall layers. Secondary cell wall comprises S1, S2 and S3 layers.

multiple functionalities of cell walls (Geirlinger et al. 2006; Cave 1968). The xylem provides a structure which is highly successful in resisting compressive loading, elevating the tree canopy tens of metres into the air. The xylem within branches is adapted to resist bending loads, utilizing compression wood (gymnosperms) or tension wood (angiosperms) in which the cell wall structure of tissue below or above the pith (cells of the central portion) respectively has been altered to enhance resistance to the named force. Despite this optimization, age, or extreme load can lead to failure, however mechanisms such as formation of compression creases act to absorb energy, limiting the extent of failure. Plants can also respond to their environment, especially when under stress, to alter the amount of cell wall polymers (Gall et al. 2015) and also cell wall and whole stem structure, for example, the production of tension wood or compression wood (Brereton et al. 2012). Such a responsive structure could inspire the development of dynamic biological building envelopes.

Analogues for the cell wall design can be found in plywood and in synthetic fibre-reinforced composites. The benefits of cross-laminating veneers of alternating grain direction were recognized by the ancient Egyptians, and have been used in modern structures and aircraft, as well as plywood itself. The design potential of angles other than 90° for the orientation of grain direction are well explored in synthetic fibre composites, allowing curved panels, conical forms and complex cross-sections to be formed from continuous fibres. In the plant cell wall, the adaptability of microfibril angle to contour around or reinforce apertures in cells provides numerous examples of bio-based design optimization. Modern CLT has revisited the high strength and orthotropic character of plywood, in a larger cross-section product suitable for construction of multi-storey buildings. The authors of the article also suggest that a return to the fibre composite bioinspired design may lead to creation of lightweight strong materials for use in walls, roofs and floors, potentially with combined secondary functions such as ventilation, trunking or piping for underfloor heating.

Plant cell walls: form and function

The many plant tissues within the stem, the root, leaves or flowers, provide numerous examples of differentiation in both form and function. Each tissue has a uniquely adapted assembly of cell wall

components, utilizing rapid growth and self-assembly processes to differentiate the tissue for its role. In each case, the alignment and optimization of location and angle of strong stiff cellulosic microfibrils, and the composition of the matrix in which they are embedded (proportion of hemicellulose, pectin, glycoprotein, and lignin) reflects the requirements of the cell wall in service.

Many structural tissues have cell walls which are optimized to resist turgor pressure. The firmness of a fresh apple or carrot is very different to the lignified woody material of timber which relates to lignification and thickness of cell wall secondary layers. Some other tissues have very specific roles in which temporal changes in osmotic pressure achieve movement, such as the guard cells of stomata on leaves, or the nastic movement in response to stimuli. The movement achieved is mainly governed by the cell shape and cell wall microfibril orientation. Thus while cell wall structure and cell turbidity have a structural role, providing the upright stance of plants, they also govern movement and will be considered further in the next section.

A brief overview of dynamic features of plant cell walls

Plant cell walls are highly dynamic and complex cellular structures supporting plant growth, development, physiology and adaptation. Based on the brief overview of the plant cell wall properties, the following three key features are introduced: porosity for filtration and communication, multi-functional and dynamic materials, and biosynthesis process.

Porosity for smart filtration and communication

There are up to three major layers that can be distinguished in plant cell walls: the primary cell wall, the secondary cell wall (where present), and the middle lamella. The middle lamella is the first layer formed during cell division. This outermost layer is rich in pectin and joins together adjacent plant cells. The thin, flexible and extensible primary cell wall is formed after the middle lamella while the cell is growing and is the major textural component of plant-derived foods.

The primary cell wall is highly porous, and permits soluble factors to diffuse across the wall to interact with receptors on the plant plasma membrane. Indeed, the primary wall contains up to 80% of its fresh weight as water. However, the cell wall is a selective filter that is more impermeable than the matrices surrounding animal cells. With a pore size of 5–10 nm (Carpita et al. 1979), water and ions can diffuse freely in cell walls, but diffusion of larger particles is reduced. The pectin network appears to be a major player in dictating water content and porosity of the primary cell wall (Mohnen, Bar-Peled, and Somerville 2008). Although secondary walls are typically much less hydrated than primary walls, not much is known about their porosity, but lignin is thought to be a key porosity gatekeeper in cells with lignified secondary cell walls. Many lignified tissues with secondary walls are designed for bulk flow, for example, xylem. In this case, the cell wall contains elaborate structures such as bordered pits, which regulate the flow of liquids and metabolites, while providing some filtration or trapping effect against air bubbles or large impurities. The apertures of the pits form during secondary cell wall development, sometimes with rearrangement of primary cell wall components to increase the permeability in the desired direction, such as the margo strands of bordered pits of conifer tracheids or the scalariform apertures in hardwood vessel cells (Wilson and White 1986). This macro-scale flow is outside the scope of this section.

Even though plant cells are enclosed by a cell wall, cell to cell communication throughout plant tissues is possible through structures called plasmodesmata, c. 50-nm-diameter plasma-membrane-lined channels that connect adjacent cells through the cell-wall barrier (Ding, Itaya, and Woo 1999). The presence of plasmodesmata allows for a continuous cytoplasmic connection within plant tissues called the symplast. There is a growing body of data showing associations of the cytoskeleton, a complex network of actin filaments and microtubules, with plasmodesmata (Aaziz, Dinant, and Epel 2001). Besides providing inner support for plant cells, the cytoskeleton, which extends throughout the cytoplasm, is involved in intracellular trafficking and closely associated with the plasma membrane.

Multiple functional and dynamic materials

In biology, the differences between material and system is blurred, and biological materials are often part of a structural system. In the past, the plant cell wall was often viewed as an inert and static exoskeleton. It is now recognized as a highly dynamic structure that, besides providing mechanical support, needs to respond to various environmental and developmental cues and fulfils important functions in signalling events, defence against biotic and abiotic stresses, and growth (Keegstra 2010). In addition, the structural shape of the plant is not solely reliant on the shape of its constituent cells, but able to grow, flex, open and close flowers or leaves, and to adjust angle or orientation to maximize sunlight. These functions are achieved by response to hormones, or following circadian rhythms, or the use of osmosis to alter turgor pressure in selected tissues. The dynamic nature of the wall, needing to be responsive and adaptable to normal processes of growth as well as to stresses such as wounding, attack from pathogens and mechanical stimuli, requires sensing, signalling and feedback mechanisms. The emerging view on the plant cell wall is one of a dynamic and responsive structure that exists as part of a continuum with the plasma membrane and cytoskeleton (Humphrey, Bonetta, and Goring. 2007; Baluška et al. 2003), although the exact linkages between these three components are still not well defined (Liu, Persson, and Zhang 2015).

In non-lignified plant tissues, it is the internal pressure of the cell contents that allows plants to maintain their upright stance. The cell wall enables plant cells to develop high turgor pressure (typically 0.3–1 MPa), important for the structural stability of the cells within plant tissues (Cosgrove 2009). The turgor pressure also influences the water relations and water economy of plants; the loss of turgor pressure, that is, when the rate of loss of water from the plant is greater than the absorption of water in the plant, for instance, due to drought stress, causes wilting. To resist internal hydrostatic pressure, the microfibril alignment in the primary cell wall is optimized to achieve hoop strength of the cell (Wainwright 1970). This is different to the load-bearing role of the secondary cell wall discussed in the section ‘Structure, composite, form and functions’. This combined action of the cells under hydrostatic pressure within a closed cell foam can provide significant hydraulic support to plant tissues. In addition, control of hydrostatic pressure by osmosis allows response to stimuli and nastic movements as mentioned above, with leaf angle or flower head tilting being a result of short-term alterations in the turgor pressure. The touch response of *Mimosa pudica* is a well-known example (Volkov et al. 2010). Here the shape and location of the parenchyma cells within pulvini govern the range of movement, and the electrical signalling mechanism allows rapid response by the leaflets. Tropic movement, by adjustment of cell growth in response to light or gravity, also overcomes some of the limitations of the sessile nature of plants, allowing growth into adjacent spaces as a response to changes in the canopy or competitor plants. These responsive structures provide inspiration for mechanical devices and actuators within buildings, as will be discussed in the section ‘Key novel design principles and related attempts’.

Biosynthesis process and programmed cell death

Self-assembly allows plants to accommodate the changing needs of the growing plant cells and the broad variety of cell shapes and functions. Being dynamic structures which are continuously synthesized and remodelled during plant development, it is probably not surprising that the biosynthesis of plant cell walls is a complex and highly regulated process (Guerriero, Hausman, and Cai 2014). To illustrate this, plants invest a large proportion of their genes (~10%) in the biosynthesis and remodelling of the cell wall (McCann and Carpita 2015).

Plant cell walls also contain structural proteins, enzymes, and other materials that can modify the physical and chemical properties of the cell wall. It has been estimated that more than 65 different enzymes are required to synthesize the pectic polysaccharides known to exist in plant cells (Harholt, Suttangkakul, and Scheller 2010). Figure 5 shows an example of a highly specialized plant cell, the pollen tube and highlights the polarized pollen tube growth process and shows the thickening of the cell wall at the apex induced by exposing the pollen tube to a particular enzyme that changes the mechanical properties (Bosch, Cheung, and Hepler 2005).

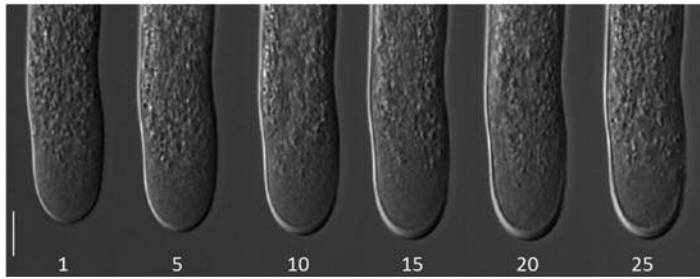

Figure 5. The pollen tube, a highly specialized plant cell with a dynamic cell wall at the apex. Microscopy images showing a time series of a *Lilium formosanum* pollen tube growing in *in-vitro* growth medium.

Notes: Numbers represent minutes after addition of an enzyme (pectin methylesterase) to the growth medium that changes the cell wall properties, leading to the arrest of pollen tube tip-growth. Scale bar = 10 μm . Adapted from Bosch, Cheung and Hepler (2005) and used with permission.

For plants to develop properly and survive, including in response to environmental challenges, they need to be able to make radical changes including to re-design and re-engineer their basic structure. Programmed cell death (PCD) provides an important response strategy to various internal and external cues (Lam 2004). PCD is a highly regulated process for the selective dismantling of unwanted cells and is essential for plant growth and survival as it plays a key role in embryo development, formation and maturation of many cell types and tissues, and plant reaction/adaptation to environmental conditions. For example, PCD as a final stage of differentiation in xylem tracheary elements results in a continuous system of adjoining hollow cells that function in water/solute transport. Here PCD accompanies the lignification of the cell wall, leaving dead tracheid cells as structural tissue optimized for fluid flow. The suicide of a cell through PCD involves the execution of a genetically encoded and actively controlled sequence of steps.

Our current understanding of PCD in plants is largely shaped by research on animal PCD, particularly apoptosis. However, it is often forgotten that the concept of PCD originated from plants (van Doorn et al. 2011). Although plant and animal PCDs share numerous characteristics (for instance, nuclear DNA degradation), several differences exist. The presence of a thick cell wall dictates that plant cells are not phagocytic (engulfment of cell corpses by another cell) and that corpse clearance is a cell autonomous process in plants. The dying cell synthesizes substances, including lytic enzymes, to break itself down and places them in the vacuole that ruptures as the cell dies (van Doorn et al. 2011). Within buildings the potential to form structural material or conduits for services in situ during construction would mimic the plant PCD mechanisms, whereas design for deconstruction at end of life requires a more radical animal PCD approach.

In summary, the brief overview of the plant cell wall characteristics demonstrates a number of interesting properties that merits further exploration for the design of bio-inspired building envelopes, further discussed in the following section.

Key novel design principles and related attempts

Based on the above review of plant cell wall characteristics, the following three key novel design principles of the biological and living building envelope are proposed: permeable, shape changing, and biosynthesis process. Nevertheless, learning from plant cell walls to inform the development of future biological building envelopes is in its infancy. However, a number of related attempts have been made to develop bio-inspired building envelopes (as is summarized in Table 2). Those existing attempts are not directly linked to the learning from the plant cell walls, but it may promote discussion and shed light on the future development of a potential technical pathway (as illustrated in Figure 6) to incorporate learning from plant cell walls into the design of biological building envelopes.

Table 2. Related attempts and demonstration examples of living building design principles.

Design principles	Building examples	Technologies	References
Permeable and multiple functional	Cellular envelopes Dynamic insulation materials Transpired solar collectors Porous reflective cool roof 'Polyvalent' wall Air filtration to improve air quality	Cellular structures serve as both a structure and a barrier Porous façade to allow heat exchange Perforated steel skins to provide heat exchange and air flows Porous roof structures with orientated holes which can re-radiate heat Multiple layers of glass materials and PV can generate energy Porous materials with capacity to absorb vapours and VOCs	Grobman (2013) Taylor and Imbabi (1999) Love et al. (2014); Shukla et al. (2012) Craig et al. (2008) Davies (1991) Stefanowski et al. (2015)
Adaptable shape changing	Hygromorphic materials Mechanical responsive facades Kinetic skin Shape changing materials Dynamic light transmittance glazing	Response driven by the shrinkage and swelling of wood triggered by moisture changes. Dynamic shape changing facades with mechanical actuators High tensile strength with low bending stiffness of lamellas allowing elastic deformations Shape changing polymers, alloys or hybrid materials, for example, EAPs, PZTs Electrochromic glazing materials	Holstov, Bridgens, and Farmer (2015) Loonen et al. (2013); Christoforou et al. (2013); Kirkegaard (2011) Knippers and Speck (2012) Fiorito et al. (2016); Bar-Cohen (2005) Mardaljevic, Waskett, and Painter (2015); Aldawoud (2013)
Biosynthesis process	Vegetated buildings Solidified granular materials Grow buildings using multiple functional biomaterials Cellophane house	Green roofs, green walls and 'tree houses' Cementation of sand dunes to create a network of sand dunes to prevent desertification Mycelium building materials blocks and slime mould to locate optimal space or routes Using discrete components in reversible process	Xing, Jones, and Donnison (2017) Larsson (2011) Imhof and Gruber (2015, 2017); Benjamin (2016) Kieran and Timberlake (2008)

Permeable and multiple functional building envelopes

Key permeable and multiple functional features of plant cell walls

The permeability of plant cell walls plays vital roles for filtration, sensing and communication, whereas, permeability of built walls is rarely considered in building design. The modern use of moisture barriers and other membranes has reduced permeability of structures overall. On the other hand, the plant cell wall together with the plasma membrane, the latter mostly composed of lipid

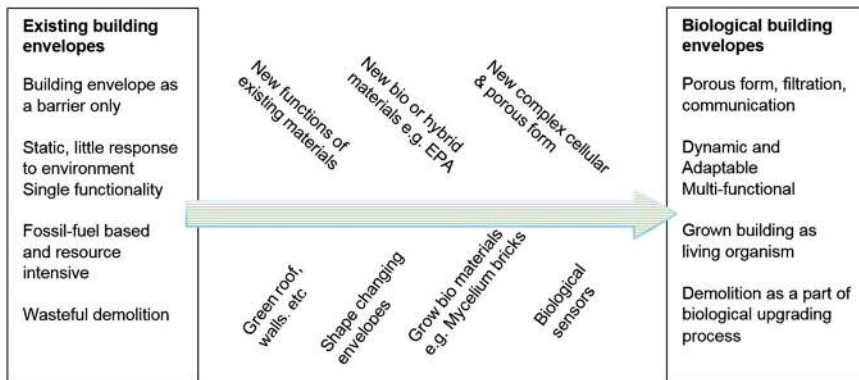

Figure 6. Transformation pathway.

molecules, is selectively permeable to ions and organic molecules and controls the movement of substances into and out of the cell (Furt, Simon-Plas, and Mongrand 2011). Plasmodesmata in the plant cell wall allow cell to cell communication, connecting with the cytoplasm to maintain a continuous symplastic pathway, as discussed earlier in the section 'Porosity for smart filtration and communication'.

Related attempts in creating permeable building envelopes

Vincent (2009) argued that 'functional' form is one of the most important parameters in biomimetic design. There have been few attempts to develop porous building envelopes. Inspired by cellular/spongy envelopes in nature, researchers have been developing a framework for creating new forms of building envelopes based on a complex cellular or sponge-like geometry and preliminary design experiments in which cellular envelopes serve as both a structure and a barrier (Grobman 2013). Taylor and Imbabi (1999) explored ideas of a porous façade to allow heat exchange as dynamic insulation. Craig et al. (2008) proposed porous roof structures with orientated holes which can re-radiate heat to the night sky and control temperature of a building. The design of the apertures was a critical factor, with not only orientation but also the pore dimensions being selected to allow loss of long wavelength infrared radiation while resisting convective heat loss. Several researchers argued that transpired solar collectors (perforated steel skins) can provide a number of functionalities, such as heating spaces, providing warm ventilation air, and supplying domestic hot water in summer (Love et al. 2014; Shukla et al. 2012).

Soar (2015) argued that traditional and natural materials (such as earth, wood and straw) have complex porous structures and are 'intelligent' in responding to the natural environment. For example, clay, whether used in adobe construction or termite mounds, responds to water vapour in remarkable ways and this interaction makes them natural phase change materials. Rapid developments in wood modification over the past decade has led to the improvement of dimensional stability, decay resistance or strength of timber, which is now also being developed in wood based composite panels (Ormondroyd, Spear, and Curling 2015). However, new materials and designs for the skin and core of structural and insulated panels need to be developed to improve their efficiency and robustness (Panjehpour et al. 2013; Chen and Hao 2015).

Sorption of vapours and volatile organic compounds (VOCs) from the environment is an important role in the mechanical ventilation or heat recovery systems of buildings, maintaining indoor air quality. This is frequently achieved with filters that show high sorption for pollutants and odour molecules. The ability of certain natural building materials to scavenge VOCs from the atmosphere has been demonstrated (Mansour et al. 2016; Stefanowski, Curling, and Ormondroyd 2016). Work has been undertaken on the assessment of nut shells for their ability to be used in wall panels to improve indoor air quality by the sequestering of VOCs from the atmosphere (Stefanowski et al. 2015). Further work to incorporate scavengers within the surfaces of building products, or deliver these within paints and coatings, will provide a passive control of odour and removal of undesirable VOCs.

Adaptable shape changing

In biology, the differences between material and system is blurred, and biological materials are often part of a structural system. In the past, the plant cell wall was often viewed as an inert and static exoskeleton. It is now recognized as a highly dynamic structure that, besides providing mechanical support, needs to respond to various environmental and developmental cues and fulfils important functions in signalling events, defence against biotic and abiotic stresses, and growth (Keestra 2010).

Key adaptable shape changing features of plant cell wall

The plant form (or plant shape) is the result of the combination of tissue types, which in turn are defined by adaptations in developing cell wall architecture during cell differentiation. Some of these features allow cells to be responsive during the life of the plant, for example, the opening

and closing of stomata is regulated by changes in turgor pressure. Others such as nastic and tropic responses may also result in alteration in cell wall to result in growth or movement towards or away from the stimulus.

A number of plant survival strategies to cope with changing environmental conditions have been identified, such as adjustment of the timing of flowering in response to seasonal changes in day length, to transportation dynamics of essential micronutrients (Satake, Sakurai, and Kinoshita 2015). Plant cell walls are highly dynamic structures offering dynamic and multiple functionality. Existing building envelopes are static and cannot adequately respond or connect to the surrounding ecological systems. There are two types of plant movements: one group is water-driven movements (growth, swelling/shrinking of cell wall) and the other group uses elastic instabilities to amplify the capacity to move. The second group includes the use of shape as well as material structure to create, for example, the snap closure of a Venus fly trap, or the explosive fracture of seed pods which provides a catapult action aiding dispersal (Skotheim and Mahadevan 2005). Researchers have argued that nastic structures of plants and their reversible movements represent a recurrent model to be mimicked (Guo et al. 2015; Fiorito et al. 2016). Plants do not directly rely on metabolism to produce motion and are able to produce 'muscle-less' movement and stiffness which offers a means of achieving a significantly advanced architectural material system (Jeronimidis 2009). These systems are particularly suitable as passive actuation which does not require active metabolism (Forterre 2013; Guo et al. 2015).

In each case, the alignment and optimization of location and angle of strong stiff cellulosic microfibrils, and the composition of the matrix in which they are embedded (proportion of hemicellulose, pectin, glycoprotein, and lignin) reflects the requirements of the cell wall in service. Significant tensile or compressive forces can be achieved by control of the angle of winding within cylindrical cells, as described by Fratzl, Elbaum, and Burgert (2008).

Related attempts to create adaptable shape changing building envelopes

There have been a number of attempts to create adaptable building envelopes. Stazi et al. (2015) examined external insulation layers that can be sealed in wintertime and ventilated in summer to improve energy efficiency of the buildings. Recently, a number of researchers have advocated movable shading devices powered by electrical actuators to reduce energy consumptions in buildings (Loonen et al. 2013; Christoforou et al. 2013; Kirkegaard 2011). However, most of the shape changing shells rely on mechanical actuators. Designs using shape memory alloy actuators for façade control have been discussed (Pesenti, Masea, and Fiorito 2015). Developments of hygromorphic or temperature responsive actuators could further improve passive building climate regulation. As an alternative strategy, researchers have demonstrated that electrochromic glazing can moderate solar heat gains and reduce, or even eliminate, the need for moveable internal shading (e.g. venetian blinds) and fixed external blinds (e.g. brise-soleil) (Aldawoud 2013; Mardaljevic, Waskett, and Painter 2015).

One potential application for responsive sensors within buildings would be in natural ventilation systems. A theoretical precedent can be taken from the timber wall structures of boat houses in Norway, in which the natural movement of plain sawn timber boards is harnessed to provide a naturally opening louvre driven by the shrinkage and swelling of wood triggered by moisture changes. Several research groups have recently developed hygromorphic (moisture-responsive) materials utilizing the anisotropic response of the wood cell wall to moisture or humidity uptake (Holstov, Bridgens, and Farmer 2015). This utilizes the difference in swelling between different orientations of wood veneers to create a flat or a curved section, using a two-layer structure in which the grain orientation of the wood is differently aligned. Here the significantly greater swelling of wood in its transverse direction than its longitudinal direction leads to differential swelling, and induces curvature in the component. The correct selection of wood growth ring orientation allows the board to flex to an open state in summer, in periods of low humidity, and to close due to moisture uptake within the wood in winter, relating to high humidity. The process is governed by the lateral

swelling of the wood being greater in the direction tangential to the growth rings than the radial direction, producing a cupping effect in the plank. Careful selection of plank orientation during installation allows the distortion to provide ventilation at the preferred time of year, and has been likened to the mechanism of a pine cone opening to release seeds when dry.

The difference between tangential and radial orientations can also be harnessed for more subtle effects. Complex forms can be created, inducing torsion rather than curvature in a mode which better models the seed pod movement mechanism (Ionov 2013). Examples of hygromorphic materials directly inspired by the pine cone, have been used in adaptive facades of prototype buildings, where they introduce passively controlled permeability (Menges and Reichert 2012), and have potential for use in other areas of engineering, design and medicine. The same principle has been used with hydrogels, polyelectrolyte layers and conducting polymers to create hygromorphic or thermally responsive actuators (Ionov 2013). The microstructure and orientation of fibrils within layers of the hygromorphic material governs the direction and magnitude of the response.

Researchers have attempted to develop new types of composite containing an integrated high density of small sensors that would enable sensing without compromising the structural integrity (Sagi 2005). Prototypes using materials with both sensors and actuators (e.g. alloys, polymers or hybrids) that respond to an external stimulus to provide shading effects have been reviewed (Fiorito et al. 2016). However, there are a number of challenges associated with sensorized composites, including electronics, mechanical integration, and data management. Kinetic skins are developed utilizing high tensile strength combined to a low bending stiffness of 108 lamellas allowing large elastic deformations (Knippers and Speck 2012). The variable lateral openings of the kinetic skins are used to control the lighting conditions of the interior spaces.

Conceptual models have been discussed to develop bio-sensing systems (Biggins, Hiltz, and Kusterbeck 2011). While research into developing bio-inspired sensing systems is in its infancy, several examples can be found where biomimetics has contributed to actuator development. New hybrid materials (bio and non-bio materials) are being developed. For example, a number of shape changing materials have been reviewed, such as electroactive polymers (EAPs), piezo-electrical material PZTs and shape memory alloys, polymers or hybrid materials, which have been used either as actuators or sensors (Fiorito et al. 2016). However, the materials are still limited in their ability to generate sufficient force to perform significant tasks, such as lifting heavy objects (Bar-Cohen 2005). Other new materials have been developed based on nanotechnologies to offer emerging functionalities, such as a prototype of new biosynthetic materials that function as self-healing membranes (Speck et al. 2006) and self-cleaning photocatalytic building materials (Pinho, Rojas, and Mosquera 2014).

The biosynthesis process of living building envelopes

Key biosynthesis features of plant cell wall: growth and disassembly

The plant cell wall forms an excellent example of how nature can use a few widespread natural constituents (usually C, H, O and N) to tailor molecules of diverse structures performing a wide variety of functions. Plant cells are continuously synthesized and remodelled during plant development to accommodate growth and cell differentiation. In addition, PCD allows plants to respond the changing requirements by terminating the function of cells once their role has been accomplished. Both concepts (growth and programmed death) can be transferred to the built environment.

Related examples of growing biological building envelopes

One good example of biological building envelopes is the green roofs/walls, which can be installed on most of existing buildings (Xing, Jones, and Donnison 2017). Researchers have also used traditional 'pleaching or grafting' techniques (Seymour 1976), which involve interweaving branches (living and dead) through a hedge or steel structure to create prototype green façades, for example, 'tree houses' (Joachim 2016), or 'Baubotanik' which combine steel scaffolding with living plants (Ludwig 2016). However, there is a need to improve the design and maintenance (e.g. choices of plants, substrates

and configuration) of green building envelopes to maximize the potential benefits (such as thermal comfort, biodiversity). Researchers have also argued for a radical shift in construction, towards the localized cementation of granular materials, for example, creation of a network of solidified sand dunes to prevent desertification (Larsson 2011). The growing of biological building envelopes has great potential in the future to further reduce or de-couple from consumption of fossil fuels based resources.

Compared to steel and cement, biological materials are often lightweight and can be generated at ambient temperature. Experiments have been set up to utilize mycelium (a fast-growing vegetative part of a fungus) as a scaffolding structure to consolidate fragmented matter producing solid building materials out of waste products from wood (Imhof and Gruber 2015; Benjamin 2016; The 3 Foragers 2013). Gruber and Imhof (2017) also introduced an experiment using slime moulds (a single cell organism) to show its space path-finding capacity. Researchers have proposed that architectural 'organ' systems might act as hubs of bio/chemical activity, flow and transformation (Spiller and Armstrong 2011; Armstrong 2016). Nevertheless, research activities exploring the concepts of growing buildings as a biological organisms are in very early stages (Gruber and Imhof 2017).

Related attempts in programmed demolition and retrofitting of building envelopes

Within buildings the potential to form structural material or conduits for services in situ during construction would mimic the plant PCD mechanisms, whereas design for deconstruction at end of life requires a more radical animal PCD approach. PCD in the biological kingdom can inform design for deconstruction, or for development of adaptable building spaces. The phagocytosis process may inspire design of building components which are readily removed or re-located, or components which are easily recycled, industrially composted or suitable for recovery of monomer for new materials production. Waste materials generated from building construction and demolition have become a great challenge to sustainable urban development (Xing et al. 2009; Xing, Lannon, and Eames 2014). Learning from PCD which serves fundamental functions during an organism's life-cycle, new perspectives in constructing regenerative building envelopes and developing sustainable demolition strategies can be developed. New research activities are needed to develop programmed building demolition or retrofitting as a part of a biosynthesis process. The cellophane house concept demonstrated by Kieran Timberlake at the Museum of Modern Art centred around this shift away from permanence in buildings – with multiple discrete components within panels held by quickly reversible processes. The integrity, reusability and upgradability of the components was central to the design (Kieran and Timberlake 2008).

A basic conceptual prototype, challenges and opportunities

In the light of the parallels between plant cell walls and the emerging architectural concepts and available bio-inspired materials, the challenge facing architects and engineers is to combine these technologies and concepts into a holistic solution. The concepts of wall permeability and regulation of interior conditions by passive motion offer potential for new structures. The authors now consider a conceptual design to integrate these features within a functional unit.

A basic conceptual design of a biological dome constructed using biological composite panels is presented in Figure 7 to illustrate that the three key design principles (i.e. permeability, shape changing, and biosynthesis process) can be realized through the changes of physical (e.g. hygrothermal or electrochemical) conditions of the panels which trigger the changes of the opening size, heat transfer coefficients, lighting transmittance, air exchanges, and solar gains to optimize energy performance of the buildings. The biological panels of this prototype can be generated using biomass waste to reduce the embodied energy. As shown in Figure 7, each of bio-panels can be changed individually.

However, there is also a trade-off in the potential shape changing behaviours. For example, higher daylight penetration can reduce electric lighting energy consumption but may also increase building heating or cooling energy consumptions. Furthermore, different bio-panels may require different

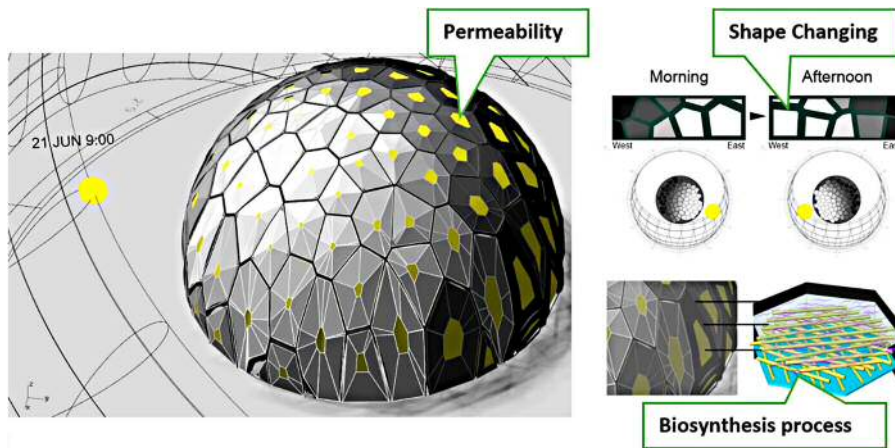

Figure 7. An illustration of the bio-dome concept.

behaviours during different time of the day in different climate zones. In order to determine the optimal shape changing behaviour of each panes in the bio-dome, a preliminary theoretical optimization algorithm was developed as part of an on-going project using computer simulations to develop most efficient adaptable bio-dome buildings designs. Based on the theoretical optimization algorithm, key theoretical physical characteristics of ideal materials can also be identified. The objective function of this model is to minimize total energy (operational and embodied) consumption.

The optimization objective is to identify:

$$\text{Min energy consumption} = \sum \{\text{heating, cooling, ventilation and lighting}\} + \sum \{\text{embodied energy}\}.$$

Optimization constraints are the maximum and minimum theoretical physical limitation of each bio panels, such as heat transfer coefficient, air infiltration rate, lighting transmittance, and embodied energy of the bio-panel:

$$U_{\min} \leq U_i \text{ (Heat transfer coefficients } U \text{ - value of bio - panel } i) \leq U_{\max},$$

$$\text{ACH}_{\min} \leq \text{ACH}_i \text{ (Air infiltration value of bio - panel } i) \leq \text{ACH}_{\max},$$

$$\text{LT}_{\min} \leq \text{LT}_i \text{ (Light transmittance value of bio - panel } i) \leq \text{LT}_{\max},$$

$$\text{EE}_{\min} \leq \text{EE}_i \text{ (Embodied energy of the bio - panel } i) \leq \text{EE}_{\max}.$$

A number of high performance passive engineering materials (as listed in [Table 2](#)) can fulfil some of the design goals of the living walls. For example, porous and reflective materials can provide dynamic insulation (Taylor and Imbabi 1999; Love et al. 2014, Craig et al. 2008) and improve air quality (Stefanowski et al. 2015); hygromorphic materials (Holstov, Bridgens, and Farmer 2015), elastic panels (Knippers and Speck 2012), mechanic actuators (Loonen et al. 2013) and electrochromic materials (Mardaljevic, Waskett, and Painter 2015) can regulate air flows and control daylight penetration and solar gain. The development and integration of shape morphing panels with adjustable shading via hygrothermal, EAPs, photochromic glazing and mycelium materials provide promising alternative materials, however some of these features conflict with one another – requiring innovative design to combine the elements effectively. To be able to optimize the system for solar gain, ventilation, thermal comfort and day lighting simultaneously a hybrid system must draw on more than one technology. This will require continued research to optimize effects on interior climate and development

of working prototypes. By identifying a conceptual structure and model system, it is possible to address the mutual interaction of competing insulation, permeability, daylighting and shading requirements. Furthermore, the future integration of self-assembly concepts and design for deconstruction requires a step change in building design theories and philosophies.

Building designs have generally evolved to have solid, impermeable envelopes and permeability is currently facilitated through openings and ducts for perfectly valid reasons; perhaps controlling permeability through mechanical means is easier and more controllable than a porous façade. However, as discussed previously current construction practices rely on mineral and fossil fuels based materials which are finite resources. Renewable biological materials which can be generated based on circular bio-economy may eventually replace current materials and building forms. Therefore, in the post-carbon societies (Xing 2013), we will have to design, use and maintain the buildings differently.

Future research investigating multiple functionalities of the materials at different scales in the hierarchy (from nano to macro and tissue and whole plants) is needed to develop and scale-up biomimetic design principles for district or urban planning. However, allometric scaling laws need to be considered (West, Brown, and Enquist 1997). Biological role models very often have to be scaled up to a much larger size than their original size, which leads to difficulty for functional requirements. Biological building envelopes might need to be constructed somewhat differently from the shape or form of the original plant cell walls. The biomimetic structure or material must therefore address differences relating to the change of target property which may be governed by a power law or allometric scaling rather than relationship to the altered dimension.

Integration of advanced wall constructions based on plant cell wall inspired materials and building control concepts requires further study, and building physics models need to be created in the context of architectural geometries for detailed analysis of energy flux and in service performance. The advances in architectural software tools will allow researchers to analyse materials and designs, and provide a visualization method to illustrate dynamic biological systems. Ultimately advanced computer tools, micro-robots and micro-mechanical systems, laser cutting, 3D printing and other digital design technologies can help researchers and practitioners to create and investigate future biological and living structures.

It is not a trivial task to establish different requirements, objectives and goals in the natural world for biomimicry research and practice. Clearly implementing biomimetic design methods can be difficult and involves a long period of adaptation, depending on many factors such as technology maturation, social acceptance and economic efficiency. The application of biomimetics in industrial design and product development requires a process of adaptation to traditional methods through simple models and a learning system. The key related technological solutions presented in this article are far from exhaustive. Future research will be needed to establish the best practices and assessment standards for implementation. Moreover, implementation of the new design principles needs to be supported by policymaking and community engagement to gain maximum benefit from sustainable and bio-inspired designs in buildings.

Conclusion

In this article, the authors have identified a series of analogies between the plant cell wall and the building envelope. The comparison of the static structural functions and the dynamic role of the wall during the lifespan of the cell reflects the vital functions, including definition of space, osmotic and physical protection, selective permeability barrier, immobilized enzyme support and cell-cell communication, recognition and adhesion, and PCD. Bringing together the disciplines of architectural design, plant biology and materials science, in this article, we promote the concept of biological building envelopes based on studies of the fundamental structure of plant cell wall. It is pertinent to identify opportunities to enable people from different disciplines to work together, to identify challenges and possible resolutions. This article explores what building designers can learn from plant cell walls at a cellular level and from evolutionary concepts for the transformative design of building envelopes.

Holistic biomimetics research is more than just a one-way knowledge transfer from biology to technology. There is also a valuable contribution to be made by engineers and designers to help biologists to resolve the design complexity and identify operational principles within and behind the natural world. In this holistic manner, the interdisciplinary research can bring mutual benefits to ecosystems, as well as to the development of diverse research disciplines and practices, such as biology, architecture, materials sciences and engineering. The cell wall composition, architecture, thickness and porosity varies from species to species, and may also depend on cell type and developmental stage of the organism. Plant cell walls are highly complex structures (Rafelski and Marshall 2008) and there is a lack of research activities investigating energy and mass transfer between cells and their environment. Thermal and mass transfer is a key research area established by building physics professions. Therefore, building physics tools may be able to contribute to the future development of plant cell wall studies in order to inform future biomimicry designs.

Several areas of bio-inspired design – either materials harnessing mechanisms demonstrated in plants, or the use of materials to achieve passive regulation of interior climate have been highlighted. Rapid research progress is underway within architecture, as typified by the adaptive building facades, use of bio-based materials, energy harvesting and selective energy re-release or optimization of passive ventilation. This article can present only a selection of highlights in this sphere in order to draw attention to future challenges. Key principles include the use of self-assembly in creation of cell walls with optimized fibril alignment to form composites with multiple functionality. The optimized pore dimensions allowing communication and filtration, and the use of PCD to create rigid structures for fluid transport. In the plant limited resources are used with maximum efficiency. The principles of nastic movements in plants are particularly discussed with relevance to passive control of interior climate and occupant comfort in buildings. The authors hope that building researchers can appreciate the complexity of plant cell walls and promote activities to seek the key features of future biological building envelopes and to develop the necessary technical pathways.

Current building practices are having an adverse effect on nature, for example, depleting resources, reducing biodiversity, and generating pollution and waste. The authors argue that there is a need to re-examine the fundamental concept of the building envelope which currently only serves as a barrier, and is not connected with its surrounding ecosystems and there is a need to develop new biologically inspired intelligent systems for buildings to support the processes of life rather than relying on fossil fuel-based construction process. Furthermore, fundamental changes of the design philosophies and technologies are needed to develop the next generation of building envelopes. In order to transform existing static building envelopes to biological, intelligent and living building envelopes, building designers need to take the lead in proposing new frameworks, leading to more ambitious architectural practices to develop ecologically responsive buildings as guardians for their inhabitants.

Disclosure statement

No potential conflict of interest was reported by the authors.

Funding

The Authors acknowledge the financial support of the Welsh Government and Higher Education Funding Council for Wales Funding Council for Wales through the Sêr Cymru National Research Network for Low Carbon, Energy and Environment.

Notes on contributors

Dr Yangang Xing is a building physicist investigating the interactions between plants and architecture (e.g. the nexus of green infrastructure and urban heat islands/air quality, energy crops, organic building materials, biomimicry and food) through development and innovative applications of building physics research tools and, in a broader context,

systemic modelling and assessment of future post-carbon building environment. Yangang is devoted to identify and develop new research applications to uncap the full potentials of multidisciplinary collaboration to tackle the grand challenges facing society on the horizon. Yangang completed his PhD in Dynamic whole system simulation for sustainability planning, and has done EPSRC-funded research focusing on methodological and technical innovations supporting building and urban sustainability.

Prof. Phil Jones is a building physicist with an interest in low-energy, low-carbon, and sustainable design in the built environment. His research interests include the development of computer models for energy and environmental prediction, urban scale sustainability, research through design, and building energy and environmental monitoring. He has worked on the use of plants to improve the micro-climate around buildings, and simulating their effect on reducing external temperatures. He is Chair of the Board of Directors of Warm Wales, a community interest company formed to install energy efficiency measures to existing fuel poor housing in Wales. He chairs the Welsh Government's Building Regulation Advisory Committee.

Dr Maurice Bosch is a plant scientist with an interest in plant cell wall dynamics and plant reproduction. His cell wall-related research focuses on the identification of the molecular and biological features underpinning cell wall recalcitrance to sugar release, and elucidating how different environmental conditions affect cell wall-related traits relevant for plant growth and development, biorefining, and ruminant digestion.

Prof. Iain Donnison is a plant scientist and the project lead for the Plants & Architecture NRN. His research interests span the biology and breeding of crops, the sustainable use of natural resources, the matching of feedstocks to different end uses, and the environmental impact of land-use change. He is also committed to working with industry to ensure that academic research is translated into products and processes to deliver economic and environmental benefits.

Dr Morwenna Spear is a materials scientist with an interest in forestry, wood science and natural fibre composites. She has worked on a wide range of projects in the bio-based materials field, ranging from wood modification by chemical, thermal and polymer impregnation methods, to the development of tailored microstructures in natural fibre reinforced polymer composites, controlling mechanical properties.

Dr Graham Ormondroyd is a materials scientist with an interest in BioBased Materials and a speciality in timber and timber-based products. His research is focused on the use of bio-based materials as a replacement for synthetics in various applications including construction and the valorisation of lignocellulosic waste materials.

References

- The 3 Foragers. 2013. "Real Art Ways Intimate Science Exhibition: Phil Ross and Mushroom Bricks." *The 3 Foragers BlogPost*. Accessed June 1, 2016. <http://the3foragers.blogspot.co.uk/2013/03/real-art-ways-intimate-science.html>.
- Aaziz, R., S. Dinant, and B. L. Epel. 2001. "Plasmodesmata and Plant Cytoskeleton." *Trends in Plant Science* 6: 326–330.
- Aldawoud, A. 2013. "Conventional Fixed Shading Devices in Comparison to an Electrochromic Glazing System in Hot, Dry Climate." *Energy and Buildings* 59: 104–110. <http://dx.doi.org/10.1016/j.enbuild.2012.12.031>.
- Alexander, D. E. 2016. "The Biomechanics of Solids and Fluids: The Physics of Life." *European Journal of Physics* 37: 053001.
- Armstrong, R. 2016. "Embodied Intelligence: Changing Expectations in Building Performance." *Intelligent Buildings International* 8 (1): 4–23.
- Aziz, M. S., and A. Y. El sherif. 2016. "Biomimicry as an Approach for Bio-Inspired Structure with the aid of Computation." *Alexandria Engineering Journal* 55: 707–714.
- Baluška, F., J. Samaj, P. Wojtaszek, D. Volkmann, and D. Menzel. 2003. "Cytoskeleton-Plasma Membrane-Cell Wall Continuum in Plants." *Emerging Links Revisited. Plant Physiology* 133 (2): 482–491.
- Bar-Cohen, Y. 2005. "Biomimetics: Mimicking and Inspired by Biology." In *Smart Structures and Materials*. pp. 1–8. <http://proceedings.spiedigitallibrary.org/proceeding.aspx?articleid=862028>
- Benjamin, D. 2016. "Project by the Living." Accessed June 1, 2016. <http://thelivingnewyork.com/hy-fi.htm>.
- Benyus, J. M. 2002. *Biomimicry: Innovation Inspired by Nature*. New York: William Morrow Paperbacks.
- Biggins, P., J. Hiltz, and A. Kusterbeck. 2011. *Bio-Inspired Materials and Sensing Systems*. Cambridge: RSC.
- Bjertnaes, M. A., and K. A. Malo. 2014. "Wind-Induced Motions of 'Treet' – A 14-Storey Timber Residential Building in Norway." World Conference on Timber Engineering, August 10–14, Quebec City, Canada, 8 pp.
- Boerjan, W., J. Ralph, and M. Baucher. 2003. "Lignin Biosynthesis." *Annual Review of Plant Biology* 54 (1): 519–546. <http://www.annualreviews.org/doi/10.1146/annurev.arplant.54.031902.134938>.
- Bosch, M., A. Y. Cheung, and P. K. Hepler. 2005. "Pectin Methyltransferase, a Regulator of Pollen Tube Growth." *Plant Physiology* 138 (July): 1334–1346.
- Brereton, N. J., M. J. Ray, I. Shield, P. Martin, A. Karp, and R. J. Murphy. 2012. "Reaction Wood – A Key Cause of Variation in Cell Wall Recalcitrance in Willow." *Biotechnology for Biofuels* 5 (1): 83. <http://www.pubmedcentral.nih.gov/articlerender.fcgi?artid=3541151&tool=pmcentrez&rendertype=abstract>.

- Carpita, N., D. Sabularse, D. Montezinos, and D. P. Delmer. 1979. "Determination of the Pore Size of Cell Walls of Living Plant Cells." *Science* 205 (4411): 1144–1147.
- Cave, I. 1968. "The Anisotropic Elasticity in the Plant Cell Wall." *Wood Science and Technology* 2: 268–278.
- Chen, W., and H. Hao. 2015. "Performance of Structural Insulated Panels with Rigid Skins Subjected to Windborne Debris Impacts – Experimental Investigations." *Construction and Building Materials* 77: 241–252. <http://dx.doi.org/10.1016/j.conbuildmat.2014.12.112>.
- Christoforou, E. G., A. Müller, M. C. Phocas, M. Matheou, and S. Arnos. 2013. "Towards Realization of Shape-Controlled Adaptable Buildings Following a Robotics Approach." In *ASME 2013 International Design Engineering Technical Conferences and Computers and Information in Engineering Conference*. American Society of Mechanical Engineers.
- Cosgrove, D. 2009. "Expansion of the Plant Cell Wall." In *The Plant Cell Wall. Annual Plant Reviews*. Vol. 8., edited by J. K. C. Rose, 237–263. State College, PA: Pennsylvania State University.
- Craig, S., Harrison, A. Cripps, and D. Knott. 2008. "BioTRIZ Suggests Radiative Cooling of Buildings Can Be Done Passively by Changing the Structure of Roof Insulation to Let Longwave Infrared Pass." *Journal of Bionic Engineering* 5 (1): 55–66.
- Davies, M. 1981. "A Wall for all Seasons." *RIBA Journal* 88 (22): 55–57.
- Davison, B. H., J. Parks, M. F. Davis, and B. S. Donohoe. 2013. "Plant Cell Walls: Basics of Structure, Chemistry, Accessibility and the Influence on Conversion." In *Aqueous Pretreatment of Plant Biomass for Biological and Chemical Conversion to Fuels and Chemicals*, edited by C. E. Wyman, 23–38. New York: Wiley.
- Ding, B., A. Itaya, and Y.-M. Woo. 1999. "Plasmodesmata and Cell-to-Cell Communication in Plants." *International Review of Cytology* 190: 251–262.
- Dunlop, J. W. C., and P. Fratzl. 2010. "Biological Composites." *Annual Review of Materials Research* 40 (1): 1–24.
- Ennos, A.R. 2012. *Solid Biomechanics*, 264 pp. Princeton, NJ: Princeton University Press.
- Epp, G. A. 2016. "Timber Awakening in America." World Conference on Timber Engineering, August 22–25, Vienna Austria, pp. 24–28.
- Fiorito, F., M. Sauchelli, D. Arroyo, M. Pesenti, M. Imperadori, G. Masera, and G. Ranzi. 2016. "Shape Morphing Solar Shadings: A Review." *Renewable and Sustainable Energy Reviews* 55: 863–884.
- Forterre, Y. 2013. "Slow, Fast and Furious: Understanding the Physics of Plant Movements." *Journal of Experimental Botany* 64 (15): 4745–4760.
- Fratzl, P., R. Elbaum, and I. Burgert. 2008. "Cellulose Fibrils Direct Plant Organ Movements." *Faraday Discussions* 139: 275–282.
- French, J. R. J. 2014. "Biomimetics – A Review." *Environment and Planning B: Planning and Design* 223 (August): 66–71. <http://sdj.sagepub.com/lookup/10.1243/09544119JEIM561>
- Furt, F., F. Simon-Plas, and S. Mongrand. 2011. "The Plant Plasma Membrane." In *Lipids of the Plant Plasma Membrane*, edited by S. Murphy, B. Schulz, and W. Peer, 3–33. Berlin: Springer.
- Gall, H., F. Philippe, J.-M. Domon, F. Gillet, J. Pelloux, and C. Rayon. 2015. "Cell Wall Metabolism in Response to Abiotic Stress." *Plants* 4 (1): 112–166. <http://www.mdpi.com/2223-7747/4/1/112/htm>.
- Gameau, A., and R. Hyde. 2012. "A Model Based on Biomimicry to Enhance Ecologically Sustainable Design." *Architectural Science Review* 55 (3): 224–235.
- Garcia-Holguera, M., O. G. Clark, A. Sprecher, and S. Gaskin. 2016. "Ecosystem Biomimetics for Resource use Optimization in Buildings." *Building Research & Information* 44 (3): 263–278. <http://www.tandfonline.com/doi/full/10.1080/09613218.2015.1052315>
- Gebeshuber, I. C., P. Gruber, and M. Drack. 2009. "A Gaze Into the Crystal Ball – Biomimetics in the Year 2059." *Proceedings of the Institution of Mechanical Engineers, Part C: Journal of Mechanical Engineering Science* 1 (1): 1–20. [papers2://publication/doi/10.1243/09544062JMES1563](https://doi.org/10.1243/09544062JMES1563).
- Geirlinger, N., M. Schwanninger, A. Reinecke, and I. Burgert. 2006. "Molecular Changes During Tensile Deformation of Single Wood Fibres Followed by Raman Spectroscopy." *Biomacromolecules* 7: 2077–2081.
- Gibson, L. 2012. "The Hierarchical Structure and Mechanics of Plant Materials." *Journal of The Royal Society Interface* 9 (76): 2749–2766.
- Giesekam, J., J. Barrett, P. Taylor, and A. Owen. 2014. "The Greenhouse gas Emissions and Mitigation Options for Materials Used in UK Construction." *Energy and Buildings* 78: 202–214. <http://dx.doi.org/10.1016/j.enbuild.2014.04.035>.
- Grobman, Y. J. 2013. Cellular Building Envelopes. In *ICoRD'13*. pp. 951–963. https://link.springer.com/chapter/10.1007/978-81-322-1050-4_75
- Gruber, P., and B. Imhof. 2017. "Patterns of Growth – Biomimetics and Architectural Design." *Buildings* 7 (2): 32. <http://www.mdpi.com/2075-5309/7/2/32>
- Guerrero, G., J.-F. Hausman, and G. Cai. 2014. "No Stress! Relax! Mechanisms Governing Growth and Shape in Plant Cells." *International Journal of Molecular Sciences* 15 (3): 5094–5114.
- Guo, Q., E. Dai, X. Han, S. Xie, and C. Z. Chao E. 2015. "Fast Nastic Motion of Plants and Bioinspired Structures." *Journal of the Royal Society Interface* 12 (110): 20150598.
- Harholt, J., A. Suttangkakul, and H. Scheller. 2010. "Biosynthesis of Pectin." *Plant Physiology* 153 (2): 384–395.

- Holstov, A., B. Bridgens, and G. Farmer. 2015. "Hygromorphic Materials for Sustainable Responsive Architecture." *Construction and Building Materials* 98: 570–582. <http://linkinghub.elsevier.com/retrieve/pii/S0950061815303536>.
- Hooke, R. 1665. *Micrographia: Or Some Physiological Descriptions of minute Bodies Made by Magnifying Glasses*. London: Martin and Allestry.
- Humphrey, T. V., D. T. Bonetta, and D. Goring. 2007. "Sentinels at the Wall: Cell Wall Receptors and Sensors." *The New Phytologist* 176 (1): 7–21.
- Imhof, B., and P. Gruber. 2015. Built to Grow: Blending Architecture and Biology, Birkhäuser. http://www.growingasbuilding.org/index.php?option=com_content&view=article&id=67:book-built-to-grow-outnow&catid=8&Itemid=108
- Ionov, L. 2013. "Biomimetic Hydrogel-Based Actuating Systems." *Advanced Functional Materials* 23 (36): 4555–4570.
- Jelle, B. P. 2011. "Traditional, State-of-the-Art and Future Thermal Building Insulation Materials and Solutions – Properties, Requirements and Possibilities." *Energy and Buildings* 43 (10): 2549–2563.
- Jeronimidis, G. 2009. "Biodynamics." *Architectural Design* 74 (3): 90–95.
- Joachim, M. 2016. *Fab Tree House*. <http://www.archinode.com/bienal.html>.
- Keegstra, K. 2010. "Plant Cell Walls." *Plant Physiology* 154 (2): 483–486.
- Kerr, T., and W. Bailey. 1934. "The Cambium and Its Derivative Tissues, X. Structure, Optical Properties and Chemical Composition of the So-Called Middle Lamella." *Journal of the Arnold Arboretum* 15: 327–349.
- Kieran, S., and J. Timberlake. 2008. "Cellophane House – Kieran Timberlake." *Architectural Design* 78 (1): 114–119.
- Kirkegaard, P. H. 2011. "Development and Evaluation of a Responsive Building Envelope Development and Evaluation of a Responsive Building Envelope." In *International Adaptive Architecture Conference, Building Centre*, pp. 1–9. London.
- Knippers, J., and T. Speck. 2012. "Design and Construction Principles in Nature and Architecture." *Bioinspiration & Biomimetics* 7 (7): 15002–15010. <http://iopscience.iop.org/1748-3190/7/1/015002>.
- Kymalainen, H. R., and A. M. Sjöberg. 2008. "Flax and Hemp Fibres as raw Materials for Thermal Insulations." *Building and Environment* 43 (7): 1261–1269.
- Lam, E. 2004. "Plant Cell Biology: Controlled Cell Death, Plant Survival and Development." *Nature Reviews Molecular Cell Biology* 5 (4): 305–315. <http://www.nature.com/doi/10.1038/nrm1358>.
- Larsson, M. 2011. "Dune: Arenaceous Anti-Desertification Architecture." In *Macro-engineering Seawater in Unique Environments. Environmental Science and Engineering (Environmental Engineering)*, edited by V. Badescu, and R. Cathcart, 431–463. Berlin: Springer.
- Liu, Z., S. Persson, and Y. Zhang. 2015. "The Connection of Cytoskeletal Network with Plasma Membrane and the Cell Wall." *Journal of Integrative Plant Biology* 57 (4): 330–340.
- Loonen, R. C. G. M., M. Trčka, D. Cóstola, J. L. M. and Hensen. 2013. "Climate Adaptive Building Shells: State-of-the-art and Future Challenges." *Renewable and Sustainable Energy Reviews* 25: 483–493.
- Love, C. D., S. B. Shah, J. L. Grimes, and D. W. Willits. 2014. "Transpired Solar Collector Duct for Tempering air in North Carolina Turkey Brooder Barn and Swine Nursery." *Solar Energy* 102: 308–317. <http://dx.doi.org/10.1016/j.solener.2013.11.028>.
- Ludwig, F. 2016. "BAUBOTANIK – Designing with Living Material." In *Materiality and Architecture*, edited by S. K. Loschke, 182–191. London: Routledge.
- Mansour, E., S. Curling, A. Stéphan, and G. Ormondroyd. 2016. "Absorption of Volatile Organic Compounds by Different Wool Types." *Green Materials* 4 (1): 1–7. <http://dx.doi.org/10.1680/jgrma.15.00031>.
- Mardaljevic, J., R. K. Waskett, and B. Painter. 2015. "Electrochromic Glazing in Buildings: A Case Study." In *Electrochromic Materials and Devices*, edited by R. J. Mortimer, D. R. Rosseinsky, and P. M. S. Monk, 571–592. Weinheim: Wiley-VCH Verlag GmbH & Co. KGaA.
- Mark, R. E. 1967. *Cell Wall Mechanics of Tracheids*. New Haven: Yale University Press.
- Martin, S. 2014. "Biomimicry: A Soft 3D-Printed Seat Inspired by Plant Cell Structures." *SolidSmack*. Accessed May 15, 2016. <http://www.solidsmack.com/fabrication/biomimicry-3d-printed-soft-seat-inspired-plant-cell-structures-made-single-material/>.
- McCann, M., and N. Carpita. 2015. "Biomass Recalcitrance: A Multi-Scale, Multi-Factor and Conversion-Specific Property." *Journal of Experimental Botany* 66 (14): 4109–4188.
- McCann, M., and K. Roberts. 1991. "Architecture of the Primary Cell Wall." In *The Cytoskeletal Basis of Plant Growth and Form*, edited by C. W. Lloyd, 109–130. London: Academic Press.
- Menges, A., and S. Reichert. 2012. "Material Capacity: Embedded Responsiveness." *Architectural Design* 82 (2): 52–59.
- Mohnen, D., M. Bar-Peled, and C. Somerville. 2008. "Biosynthesis of Plant Cell Walls." In *Biomass Recalcitrance*, 94–187. Oxford: Blackwell.
- Morgan, W. 1977. *The Elements of Structure: An Introduction to the Principles of Building and Structural Engineering*, 2nd ed. London: Pitman.
- Nemat-Nasser, Sia, Syrus Nemat-Nasser, Thomas Plaisted, Anthony Starr, and Alireza Vakil Amirkhizi. 2005. "Multifunctional Materials." In *Biomimetics: Biologically Inspired Technologies*, 309–341. Boca Raton, FL: CRC Press.

- Ormondroyd, G., M. Spear, and S. Curling. 2015. "Modified Wood: Review of Efficacy and Service Life Testing." *Proceedings of the ICE – Construction Materials* 168 (4): 187–203. <http://www.icevirtuallibrary.com/content/article/10.1680/coma.14.00072>.
- Panjehpour, M., A. Ali, A. Abdullah, and Y. L. Voo. 2013. "Structural Insulated Panels: Past, Present, and Future." *Journal of Engineering, Project, and Production Management* 3 (1): 2–8.
- Papadopoulos, A. M. 2005. "State of the art in Thermal Insulation Materials and Aims for Future Developments." *Energy and Buildings* 37 (1): 77–66.
- Pawlyn, M. 2011. *Biomimicry in Architecture*. London: RIBA.
- Pesenti, M., G. Masea, and F. Fiorito. 2015. "Shaping an Origami Shading Device Through Visual and Thermal Simulations." *Energy Procedia* 78: 346–351.
- Pinho, L., M. Rojas, and M. J. Mosquera. 2014. "Ag-SiO₂-TiO₂ Nanocomposite Coatings with Enhanced Photoactivity for Self-Cleaning Application on Building Materials." *Applied Catalysis B: Environmental* 178: 144–154. <http://dx.doi.org/10.1016/j.apcatb.2014.10.002>.
- Rafelski, S. M., and W. F. Marshall. 2008. "Building the Cell: Design Principles of Cellular Architecture." *Nature Reviews. Molecular Cell Biology* 9 (8): 593–602.
- Sarikaya, M., C. Tamerler, A. K. -Y. Jen, K. Schulten, and F. Baneyx. 2003. "Molecular Biomimetics: Nanotechnology Through Biology." *Nature Materials* 2 (9): 577–585.
- Sarkar, P., E. Bosneaga, and M. Auer. 2009. "Plant Cell Walls Throughout Evolution: Towards a Molecular Understanding of Their Design Principles." *Journal of Experimental Botany* 60 (13): 3615–3635.
- Satake, A., G. Sakurai, and T. Kinoshita. 2015. "Modeling Strategies for Plant Survival, Growth and Reproduction." *Plant and Cell Physiology* 56 (4): 583–585. <http://pcp.oxfordjournals.org/cgi/doi/10.1093/pcp/pcv041>.
- Schmitt, O. 1969. Some Interesting and Useful Biomimetic Transforms. In Proceedings of the 3rd International Biophysics Congress, Boston, MA, USA, 29 August–3 September 1969.
- Seymour, J. 1976. *The Complete Book of Self-Sufficiency*. London: Faber.
- Shukla, A., D. N. Nkwetta, Y. J. Cho, V. Stevenson, and P. Jones. 2012. "A State of art Review on the Performance of Transpired Solar Collector." *Renewable and Sustainable Energy Reviews* 16 (6): 3975–3985. <http://www.sciencedirect.com/science/article/pii/S1364032112001232>.
- Simmons, T. J., J. C. Mortimer, O. D. Bernardinelli, A.-C. Pöppler, S. P. Brown, E. R. deAzevedo, R. Dupree, et al. 2016. "Folding of Xylan Onto Cellulose Fibrils in Plant Cell Walls Revealed by Solid-State NMR." *Nature Communications* 7: 13902. <http://www.nature.com/doi/10.1038/ncomms13902>.
- Skotheim, J. M., and L. Mahadevan. 2005. "Physical Limits and Design Principles for Plant and Fungal Movements." *Science* 308 (5726): 1308–1310.
- Soar, R. 2015. "Part 1: A Process View of Nature. Multifunctional Integration and the Role of the Construction Agent." *Intelligent Buildings International* 8 (2): 78–89.
- Speck, T., R. Luchsinger, S. Busch, M. Rüggeberg, and O. Speck. 2006. "Self-Healing Processes in Nature and Engineering: Self-Repairing Biomimetic Membranes for Pneumatic Structures." *WIT Transactions on Ecology and the Environment* 87: 105–114.
- Spiller, N., and R. Armstrong. 2011. "It's a Brand New Morning." *Architectural Design* 81 (2): 14–25.
- Stahlberg, R. 2009. "The Phytomimetic Potential of Three Types of Hydration Motors That Drive Nastic Plant Movements." *Mechanics of Materials* 41 (10): 1162–1171. <http://dx.doi.org/10.1016/j.mechmat.2009.05.003>
- Stazi, F., C. Bonfigli, E. Tomassoni, C. Di Perna, and P. Munafo. 2015. "The Effect of High Thermal Insulation on High Thermal Mass: Is the Dynamic Behaviour of Traditional Envelopes in Mediterranean Climates Still Possible?" *Energy and Buildings* 88: 367–383. <http://dx.doi.org/10.1016/j.enbuild.2014.11.056>
- Steadman, P. 2008. *The Evolution of Designs – Biological Analogy in Architecture and the Applied Arts – A Revised Edition*. Oxon: Routledge.
- Stefanowski, B. K., S. F. Curling, E. Mansour, and G. A. Ormondroyd. 2015. "Development of a Rapid Screening Method to Determine the Susceptibility to Mould Growth of Novel Construction and Insulation Products." In *Proceedings of the IRG Annual Meeting*, Viña del Mar, Chile, May 10–14, 18 pp.
- Stefanowski, B. K., S. F. Curling, and G. A. Ormondroyd. 2016. "Evaluating Mould Colonisation and Growth on MDF Panels modified to Sequester Volatile Organic Carbons." *International Wood Products Journal* 7 (4): 118–194.
- Taylor, B., and M. S. Imbabi. 1999. "Dynamic Insulation in Multistorey Buildings." *Building Services Technol* 20 (4): 179–184.
- Tondi, G., M. Link, C. Kolbitsch, J. Gavino, P. Luckeneder, A. Petutschnigg, R. Herchl, and C. Van Doorslaer. 2016. "Lignin-Based Foams: Production Process and Characterization." *Bioresources* 11 (2): 2972–2986.
- Vale, B., and R. Vale. 2010. "Domestic Energy Use, Lifestyles and POE: Past Lessons for Current Problems." *Building Research & Information* 38 (March 2012): 578–588.
- van Doorn, W. G., E. P. Beers, J. L. Dangl, V. E. Franklin-Tong, P. Gallois, I. Hara-Nishimura, A. M. Jones, et al. 2011. "Morphological Classification of Plant Cell Deaths." *Cell Death and Differentiation* 18 (8): 1241–1246. <http://www.pubmedcentral.nih.gov/articlerender.fcgi?artid=3172093&tool=pmcentrez&rendertype=abstract>.
- Vincent, J. 2009. "Biomimetic Patterns in Architectural Design." *Architectural Design* 79 (6): 74–81.

- Vo, L. T. T., and P. Navard. 2016. "Treatments of Plant Biomass for Cementitious Building Materials – A Review." *Construction and Building Materials* 121: 161–176. <http://linkinghub.elsevier.com/retrieve/pii/S0950061816308613>.
- Vogel, S. 2009. "Nosehouse: Heat-Conserving Ventilators Based on Nasal Counterflow Exchangers." *Bioinspiration & Biomimetics* 4 (4): 46004. <http://www.ncbi.nlm.nih.gov/pubmed/19920310>.
- Volkov, A. G., J. C. Foster, K. D. Baker, and V. S. Markin. 2010. "Mechanical and Electrical Anisotropy in *Mimosa pudica* Pulvini." *Plant Signalling & Behavior* 5 (1): 1211–1221.
- Wainwright, S. A. 1970. "Design in Hydraulic Organisms." *Naturwissenschaften* 57: 321–326.
- West, G. B., J. H. Brown, and B. J. Enquist. 1997. "A General Model for the Origin of Allometric Scaling Laws in Biology." *Science* 276 (5309): 122–126. <http://www.sciencemag.org/cgi/content/abstract/276/5309/122>.
- Wilson, K., and D. J. B. White. 1986. *The Anatomy of Wood: Its Diversity and Variability*. London: Stobart & Son. 309 pp.
- Xing, Y. 2013. "Researching Sustainable Living Styles in Post-carbon Societies." *Materials Architecture Design Environment (MADE)*, 7/8.
- Xing, Y., N. Hewitt, and P. Griffiths. 2011. "Zero Carbon Buildings Refurbishment – A Hierarchical Pathway." *Renewable and Sustainable Energy Reviews* 15 (6): 3229–3236.
- Xing, Y., R. M. W. Horner, M. A. El-Haram, and J. Bebbington. 2009. "A Framework Model for Assessing Sustainability Impacts of Urban Development." *Accounting Forum* 33 (3): 209–224.
- Xing, Y., P. Jones, and I. Donnison. 2017. "Characterisation of Nature-Based Solutions for the Built Environment." *Sustainability* 9 (1): 149. <http://www.mdpi.com/2071-1050/9/1/149>
- Xing, Y., S. Lannon, and M. Eames. 2013. "Developing a System Dynamics Based Building Performance Simulation Model – SdSAP to Assist Retrofitting Decision Making." In *Proceedings of BS2013: 13th Conference of International Building Performance Simulation Association*, Chambéry, France, pp. 226–233.
- Xing, Y., S. C. Lannon, and M. Eames. 2014. "Exploring the Use of Systems Dynamics in Sustainable Urban Retrofit Planning." In *Urban Retrofitting for Sustainability: Mapping the Transition to 2050*, edited by T. Dixon, 49–70. Abingdon: Routledge.
- Zari, M. P., M. Pedersen Zari, and M. P. Zari. 2015. "Mimicking Ecosystems for Bio-Inspired Intelligent Urban Built Environments." *Intelligent Buildings International* 8975 (February): 1–21. <http://www.tandfonline.com/doi/abs/10.1080/17508975.2015.1007910>.

Appendix: A brief glossary

HYPOCOTYLS

The stem region of a seedling below the cotyledons (seed leaves).

MIDDLE LAMELLA

The thin layer that connects two plant cells and is rich in pectin.

MATRIX POLYSACCHARIDES

Complex polysaccharides found in the space between cellulose microfibrils. They are traditionally divided into pectins and hemicelluloses.

POROSITY

Property that indicates how readily gases, liquids and other materials can penetrate an object.

PECTINS

Group of complex polysaccharides that are extracted from the cell wall by hot water, dilute acid or calcium chelators. They include homogalacturonan, rhamnogalacturonans I and II, galactans, arabinans and other polysaccharides.

PRIMARY CELL WALL

The flexible extracellular matrix that is deposited while the cell is expanding.

SECONDARY CELL WALL

The flexible extracellular matrix that is deposited while the cell is still expanding is known as the primary cell wall. When expansion ceases, a secondary wall is sometimes laid down inside the primary wall, making it stronger.

TURGOR PRESSURE

Force generated by water pushing outward on the plasma membrane and plant cell wall, that results in plant rigidity. The loss of turgor pressure causes wilting.

TRACHEARY ELEMENTS

Specialized cells in the xylem of vascular plants that are responsible for the conductance of water as well as providing mechanical support.

VACUOLE

A membrane-bound cellular compartment, usually filled with a dilute watery solution. Mature plant cells often have very large central vacuoles.

XYLEM

A tissue that comprises a group of specialized cells that are involved in the transport of water and solutes in vascular plants. Mature xylem vessels essentially contain only the cell wall.