

**THE POTENTIAL OPTIMUM COOLING EFFECT OF VEGETATION WITH
GROUND SURFACE PHYSICAL PROPERTIES MODIFICATION IN
MITIGATING THE URBAN HEAT ISLAND EFFECT IN MALAYSIA**

Mohd Fairuz Shahidan

A THESIS SUBMITTED TO
CARDIFF UNIVERSITY FOR THE DEGREE OF
DOCTOR OF PHILOSOPHY

2011

DECLARATION

This work has not previously been accepted in substance for any degree and is not concurrently submitted in candidature for any degree

Signed (candidate) Date

STATEMENT 1

This thesis is being submitted in partial fulfilment of the requirements for the degree of Doctor of Philosophy.

Signed (candidate) Date

STATEMENT 2

This thesis is the result of my own independent work/investigation, except where otherwise stated.

Other sources are acknowledged by explicit references.

Signed (candidate) Date

STATEMENT 3

I hereby give consent for my thesis, if accepted, to be available for photocopying and for inter-library loan, and for the title and summary to be made available to outside organisations.

Signed (candidate) Date

STATEMENT 4 – BAR ON ACCESS APPROVED

I hereby give consent for my thesis, if accepted, to be available for photocopying and for interlibrary loans **after expiry of a bar on access approved by the Graduate Development Committee.**

Signed (candidate) Date

ACKNOWLEDGEMENTS

First and foremost, all praises be to Allah (S.W.T) for giving me the strength, courage and guidance in the accomplishment of this study. With His Grace and Blessing, I received a remarkable knowledge out of millions from Him through a challenging journey of my own PhD.

I would like to offer my sincerest gratitude to my supervisor, Professor Phillip Jones, who has supported me throughout my thesis with his patience and knowledge whilst allowing me the room to work in my own way. I attribute the level of my PhD degree to his encouragement and effort and without him this thesis, too, would not have been completed or written. One simply could not wish for a better or understanding supervisor. In Cardiff, I was also very fortunate to be among staff of WSA which very helpful and patience in supporting during my study here. Special appreciations are dedicated to Dr Donald Alexander, Dylan Dixon, Dr. Mike Fedeski, Dr. Julie Gwilliam, Katrina Lewis, Simon Lannon, Huw Jenkins, Anne Evans and Susan Bowden. My deepest gratitude to Dr. Mohd Johari Mohd Yusof, Edinburgh University, in guiding and providing me with the knowledge of satellite imagery. To all WSA PhD students especially Shiyu Jiang and Badran Al-Znafer, who were supported me throughout my study in WSA, Cardiff.

In Malaysia, I would like to convey my deepest thanks to Ministry of Higher Education of Malaysia (MOHE) and Universiti Putra Malaysia for financial sponsorship and scholarship throughout my years of study. Special gratitude to every personnel and individual in Perbadanan Putrajaya for granted permission and provide affirmative commitments in providing details information within my site study in Persiaran Perdana, Putrajaya. Not forgetting to Malaysian Remote Sensing Agency (ARSM), Malaysian Meteorological Department (MMD) and Ministry of Science, Technology and Innovation (MOSTI) for their unlimited help and provision of data and official documents. Many thanks to staff of FRSB, Universiti Putra Malaysia especially Professor Dr Mustafa Kamal Mohd Shariff for his sincere support and Professor Elias Salleh for later introduced me to my supervisor.

Last but not least, my great deep gratefulness to my lovely wife, Asa Naim Rusli who blessed me with his love, patience, support and understanding in completing this study. I am really respectful to her for sacrificing her PhD for my success. Later, it is my turn to sacrifice my time for your success, dear! To my beloved baby, Adam Fariz, your cry and smile were my medicines throughout this tough journey. I extend my great sincere thanks to my beloved fathers and mothers, Shahidan Mat Daud, Hasidah Awang, Rusli Ahmad and Siti Rawan Baharum for giving courage and blessing. Not forgotten thousand of thanks to my brothers and sisters for their motivations. I pray that someday, Allah S.W.T. will repay the care all of you have provided me.

Excerpt from Surah Al-KAHF (Verses 15-16)

"When you turn away from them and the things they worship other than Allah betake yourselves to the Cave: your Lord will shower His mercies on you and dispose of your affair towards comfort and ease." Thou wouldst have seen the sun, when it rose, declining to the right from their Cave, and when it set, turning away from them to the left while they lay in the open space in the midst of the Cave. Such are among the Signs of Allah..

This thesis is dedicated to,

*My beloved wife, children
& family*

*Thank you very much
for all your love, sacrifice
and patience*

ABSTRACT

This study focuses on the optimum cooling effect of vegetation and ground surface albedo modification at street level in mitigating urban heat island (UHI) in Persiaran Perdana, Putrajaya and benefits towards outdoor human thermal comfort and building energy performances. The modification of vegetation and ground surface materials were focused on both physical properties – i.e. tree canopy density and materials albedo values. Several methodologies phases through remote sensing satellite imagery, computer simulation, field measurement and surveys programmes were developed and conducted in order to achieve the aim and objectives of study. Particularly, ENVI-met surface-plant-air microclimate model was used to predict the impact of modification according to three proposed scenarios – i.e. (i) $LAD < 0.5$, (ii) $LAD > 1.5$; and (iii) $LAD > 1.5$ and albedo > 0.8 . The model was successfully validated and reliable to present the actual urban microclimate condition of Persiaran Perdana through the correlation of measured and computed experiments. Four local species were measured and simulated based on variation in leaf area index (LAI) and leaf area density (LAD) to measure per-tree cooling effect performances and used as a reference in final simulation of proposed scenarios. The outcome was used in evaluating the impact of modification and used to assess later its benefits towards human thermal comfort and building energy performances. The outdoor thermal comfort was assessed based on site questionnaire and the outcome developed local physiological equivalent temperature (PET) as reference to evaluate modification benefits towards outdoor comfort level. Then, the building energy performances were evaluated using validated HTB2 model that based on site field measurement outcome and one selected building as a reference.

It is revealed that UHI occurrence in Persiaran Perdana was due to vegetation loss, replacement of new built-up areas and lower albedo ground surface materials that lead to increased in hot spots in this new urban area. Currently, the study measure on the average of one month UHI intensity found to be at 2.6°C as compare to other old city in Malaysia. In mitigating the impact, the study has revealed the potential of high density trees of *Ficus benjamina* with LAD of 1.5 in offering better cooling impact towards urban microclimate. The optimum performance of cooling that refers to high quality of shading and evapotranspiration process was found to be within the hottest period of the day at 15:00 hours. Besides, the cooling effect becomes greater with larger quantities in cluster planting. On the other hand, the impact of cool materials with higher albedo values (i.e. > 0.8) was

recommended in optimizes the impact of cooling. Ultimately, the model predict that by modification of larger quantities of high tree density (i.e. LAD > 1.5) supported with cool materials, the largest urban air temperature improvement was found in average of 2.7°C and 3.5°C during the peak hours of the day comparing to current condition. This improvement was proved to mitigate the impact of current UHI in Persiaran Perdana. In reflect to this improvement, the study revealed that the outdoor thermal comfort in Persiaran Perdana was improved from ‘hot’ and ‘warm’ to ‘comfortable’ zone in almost 75% of the areas. On the other hand, the building total cooling load was saved up to 29.4% due to the modification and well correlated with tree quantities values. The study also revealed that the optimum improvement can be influenced from four major physical factors – i.e. larger tree quantity, higher tree canopy density, cool materials and tree distances. Finally, the conclusion from the potential in optimum cooling from physical properties of trees and ground materials modification can be implemented as additional guidelines in mitigating UHI and influence the bio-climatic factors in urban tropical climate.

TABLE OF CONTENTS

Acknowledgments	i
Dedication	ii
Abstract	iii
Table of Contents	v
List of Figures	xi
List of Tables	xxii
1.0 INTRODUCTION	
1.1 Background and Problem Statement	1
1.2 Aim and Objectives	4
1.3 Hypotheses and Research Questions	5
1.4 Scope and Limitations of the Research	6
1.5 Research Framework	8
1.6 Summary	11
2.0 REVIEW OF URBANISATION AND THE UHI EFFECT	
2.1 Urbanisation and Climate	12
2.2 Urban Heat Island (UHI): Definition	23
2.3 Types of UHI Intensity	24
2.3.1 Measuring UHI in Air Temperature	25
2.3.2 Measuring UHI in Surface Temperature	27
2.4 UHI Studies	29
2.4.1 Non-Tropical UHI Studies	30
2.4.2 Tropical UHI Studies	34
2.5 Climate and UHI Studies in Malaysia	39
2.5.1 Climate Background	39
2.5.1.1 Temperature and Relative Humidity Distribution and Variation in Malaysia	39
2.5.1.2 Wind Flow Distribution in Malaysia	40
2.5.1.3 Solar Radiation and Sunshine Distribution in Malaysia	41
2.5.2 UHI in Malaysia	43
2.6 Effect of UHI	45
2.6.1 Human Thermal Comfort	45
2.6.2 Human Health	46
2.6.3 Pollution	47
2.6.4 Building and Energy Usage	48
2.6.5 Meteorological and Climatological Effects	49
2.7 UHI and Urban Microclimate Mitigation Strategies	50
2.7.1 The Role of Vegetation in the Urban Microclimate	51
2.7.2 Thermal Reflectivity (Albedo) and Cool Urban Surfaces	54
2.8 A Review of the UHI Mitigation Strategies and Measures Studies through Vegetation and Ground Surface Material Influences	59
2.8.1 UHI Mitigation Using Meteorological Data and Satellite Images at Macro-Level	59
2.8.2 UHI Mitigation Using In-Situ Field Measurement at Micro Level	62
2.8.3 UHI Mitigation Using Numerical Calculation and Modelling	67

2.9	Summary	78
3.0	REVIEW OF VEGETATION AND ALBEDO MODIFICATION: TOWARDS ACHIEVING OPTIMUM COOLING EFFECTS IN TROPICAL URBAN MICROCLIMATE	
3.1	Urban Trees and Ground Surface Effects in Urban Microclimates	80
3.2	Microclimate Modification	83
	3.2.1 Solar and Terrestrial Radiation Modification	84
	3.2.2 Wind Modification	87
	3.2.3 Air Temperature and Humidity Modification	89
3.3	Implementation of Tree Physical Characteristics for Optimum Cooling Effect	92
	3.3.1 Tree Canopies, Leaf Area Index (LAI) and Leaf Area Density (LAD)	93
	3.3.2 Urban Trees Types, Tree Shade and Coverage	95
3.4	Implementation of Cool Paving Material for Optimum Cooling Effect	100
	3.4.1 Ground Surface Physical Characteristics Modification	102
	3.4.2 Construction and Material Texture	102
	3.4.3 Colour	103
	3.4.5 Cooling Effect Performance based on 'Cool' Material Characteristics	104
3.5	Combination of Tree and 'Cool' Materials towards Optimising Cooling Effect	105
3.6	Bio-climatic Influences of Trees and Cool Paving Modification	107
	3.6.1 Human Outdoor Thermal Comfort	107
	3.6.2 Building Energy Savings	113
3.7	Summary	116
4.0	RESEARCH METHODOLOGY	
4.1	Introduction	117
4.2	Research Methodology Framework	117
4.3	UHI Mitigation Strategies Methods	121
	4.3.1 Objectives	121
	4.3.2 Study Site Location and Climatic Descriptions	121
	4.3.3 Remote Sensing Satellite Imagery Method	123
	4.3.4 Field Measurement Programme	126
	4.3.4.1 Measurement Locations	127
	4.3.4.2 Descriptions of Measurement Point Location and Landscape Conditions	129
	4.3.4.2.1 Taman Wawasan (<i>Wawasan Park</i>)	129
	4.3.4.2.2 Mahkamah	130
	4.3.4.2.3 Perbadanan	130
	4.3.4.2.4 Dataran Putra (<i>Putra Square</i>)	131
	4.3.4.2.5 P3P Road	132
	4.3.4.2.6 Dataran Rakyat (<i>Rakyat Square</i>)	132

4.3.4.2.7	Open Space	133
4.3.4.2.8	P2N Road	134
4.3.4.2.9	Perdana Boulevard	135
4.3.4.2.10	Wisma Tani Entrance	135
4.3.4.2.11	Wisma Tani's Pedestrian Area	136
4.3.4.2.12	Tunku Abdul Rahman Road	136
4.3.4.3	Preliminary work	137
4.3.4.4	Field Measurement Instrumentations	138
4.3.4.5	Measurement Procedures	141
4.3.4.6	Determining Weather Type and Cloud Cover (Rainy or Clear Days)	143
4.3.5	Computer Simulation Programme	144
4.3.5.1	ENVI-met 3.1 numerical modelling	144
4.3.5.2	Relevance of ENVI-met to the present study	145
4.3.5.3	General Structure of ENVI-met 3.1	147
4.3.5.4	Simulation course and boundary conditions	148
4.3.6	Simulation Development of Current Condition and Mitigation Strategies Scenarios	151
4.3.6.1	Local tree development and determination of per-tree cooling effect performance	151
4.3.6.2	Development of Current Condition and Proposed Scenarios	154
4.3.6.2.1	Development of base model of site conditions simulation	154
4.3.6.2.2	Development of proposed scenarios	157
4.4	Outdoor Thermal Comfort Survey Methods	160
4.4.1	Determining times and dates of field survey	160
4.4.2	Measurement Location	161
4.4.2.1	Green Spaces	161
4.4.2.2	Open Spaces	161
4.4.2.3	Outdoor Building Spaces	162
4.4.3	Instrument: Questionnaire survey	163
4.4.4	Instrument: Microclimate variables monitoring	163
4.4.5	Subjective Measurement Procedures	165
4.4.6	Data calculated from monitoring data and observation details	168
4.4.6.1	Calculation of mean radiant temperature (MRT)	168
4.4.6.2	Metabolic rate (met) and Clothing level (clo)	168
4.4.6.3	Calculation of PET	169
4.5	Building Energy Savings Methods	170
4.5.1	Direct Effect Field Measurement Method	171
4.5.2.1	Field measurement location and times	171
4.5.2.2	Building Selections and Environment	172
4.5.2.3	Instrumentations	175
4.5.2.4	Measurement Procedures	177
4.5.3	Computer Simulation Programme	179
4.5.3.1	HTB2 Software	179
4.5.3.2	Determine tree shading effect in HTB2 software	180
4.5.3.3	Simulation Arrangement and Procedures	184
4.6	Summary	187

5.0	UHI MITIGATION STRATEGIES: FINDINGS AND DISCUSSION	
5.1	Remote Sensing Satellite Imagery	188
	5.1.1 Land Cover Distribution in Years 1994-2005	188
	5.1.2 Hot and Cool Spots Distribution	191
5.2	Field Measurement Programme Results	196
	5.2.1 Current Condition of Air Temperature in the Persiaran Perdana	196
	5.2.2 Average, Maximum and Minimum of Air Temperature at 13 Measurement Points	199
	5.2.3 Average, Maximum and Minimum Relative Humidity	203
	5.2.4 Average, Maximum and Minimum Surface Materials and Grass Surface Temperature	204
	5.2.5 Average Surface temperature on Six Major Ground Surface Materials	206
	5.2.6 Discussion: Current Condition of Persiaran Perdana	207
5.3	Computer Simulation Programme Results	208
	5.3.1 Validation of ENVI-met model: Computed and Measurement Comparisons	208
	5.3.2 Tree Cooling Effect Performance Results	212
	5.3.2.1 Air Temperature	212
	5.3.2.2 Relative Humidity	216
	5.3.2.3 Absolute Humidity	220
	5.3.2.4 Ground Surface Temperature	224
	5.3.2.5 Thermal Radiation Filtration	227
	5.3.2.6 Radiant Temperature	230
	5.3.2.7 Wind Speed	234
	5.3.2.8 Discussion: Per-Tree Cooling Effect Performance	237
	5.3.3 Comparison of Current Condition, Three Modification Scenarios and Results	238
	5.3.3.1 Air Temperature	239
	5.3.3.2 Relative Humidity	246
	5.3.3.3 Absolute Humidity	250
	5.3.3.4 Ground Surface Temperature	256
	5.3.3.5 Radiant Temperature	261
	5.3.3.6 Wind Speed	265
5.4	Discussion: The Optimum Cooling Effect from Modification Scenarios	267
5.5	Summary	269
6.0	OUTDOOR THERMAL COMFORT: FINDINGS AND DISCUSSION	
6.1	Results of Subjects' Personal Details and Observations	271
6.2	Comparison of Green Spaces, Open Spaces and Outdoor Building Spaces in Outdoor Comfort Perceptions and Preferences	272
	6.2.1 Air Temperature and Mean Radiant Temperature	272
	6.2.2 Relative Humidity	276
	6.2.3 Wind Movement	278
	6.2.4 Light Intensity	281
	6.2.5 Green and Shaded Area Perception	283

6.2.6	Thermal Comfort Satisfaction	284
6.3	Overall Thermal Comfort Satisfaction	284
6.3.1	Air Temperature	285
6.3.2	Mean radiant temperature	286
6.3.3	Relative Humidity	287
6.3.4	Wind Speed	288
6.3.5	Physiological Equivalent Temperature (PET)	289
6.4	Comparisons of PET based on Modification Scenarios in Persiaran Perdana	291
6.5	Discussion	293
6.6	Summary	295

7.0 BUILDING ENERGY SAVINGS: FINDINGS AND DISCUSSIONS

7.1	Field Measurement Programme Results	297
7.1.1	A Comparison of the Influence of Six Different of Outdoor Environmental Conditions on Buildings' Indoor Environments	297
7.1.1.1	Comparison of Outdoor and Indoor Air Temperature	297
7.1.2.1	Comparison of Outdoor and Indoor Wall Surface Temperature	300
7.1.2	Discussion: Outdoor versus Indoor Environment	302
7.2	Computer Simulation Programme Results	303
7.2.1	Validation of HTB2 Simulation Results in Two Selected Outdoor Environments	303
7.2.2	Tree Shading Mask Result	303
7.2.3	Building Ventilation Rate Result	306
7.2.4	Comparison of Measured and Computed Indoor Air Temperature Results	307
7.3	Comparisons of Cooling Load Influence according to Tree Cooling Effect	308
7.4	Comparisons of Cooling Load Influence by Tree Distance from Building Wall	311
7.5	The Indirect Effect of Outdoor Air Temperature Modification on Indoor Air Temperature in Selected Location Points in Persiaran Perdana	312
7.6	Indirect Effect of Outdoor Modification on Building Energy Savings on Six Selected Location Points	316
7.7	Discussion	318
7.8	Summary	320

8.0 CONCLUSIONS AND RECOMMENDATIONS

8.1	Introduction	322
8.2	Conclusion based on Thesis Aim and Objectives	322
8.2.1	Review of UHI and Cooling Modification Potential of Vegetation and Albedo	322
8.2.2	UHI Mitigation Strategies	325

8.2.2.1	Hot and Cool Spots through Thermal Satellite Images Assessment and Field Measurement	325
8.2.2.2	ENVI-met Model Validation	327
8.2.2.3	Tree Cooling Effect and Optimum Cooling Potential with Different Scenarios through ENVI-met Model Prediction	328
8.2.3	Outdoor Thermal Comfort Perception and Impact of Outdoor Modification towards their Comfort Level	330
8.2.4	Influence of Outdoor Environment Modification towards Building Energy Saving	331
8.3	Guidelines for Improving UHI Mitigation Strategies for a Tropical Climate in Putrajaya, Malaysia	334
8.4	Outline for Possible Future Research	335
8.5	Limitation and Suggestion of the Study	338
8.6	Contributions of the Study	338

References

List of Acronyms and Abbreviations

Appendices

List of Figures

Figure 1.1: The research framework	10
Figure 2.1 The electromagnet spectrum of the sun	14
Figure 2.2 Radiation arriving at the surface will be reflected, absorbed and transmitted through the surface	14
Figure 2.3 Example: Shading and radiation filtration by trees reduces the surface temperature of the ground surface	16
Figure 2.4 The heat storage process in buildings surface at day and night-time	17
Figure 2.5 Typical partitioning of energy over different landscape surfaces at noon and during the evening.	18
Figure 2.6 Wind velocity profiles: depth of boundary layers at difference topography – Urban centre, rough wooded country and open country, sea	19
Figure 2.7 The energy balance of the earth	21
Figure 2.8 Schematic presentation of the energy fluxes in the urban environment	22
Figure 2.9 Generalized cross-section of typical UHI	24
Figure 2.10 The vertical structure of the urban atmosphere over an urban region at the scale of the whole city	25
Figure 2.11 Surfaces' definitions in measuring surface UHI	28
Figure 2.12 Example of satellite images and thermal satellite images superimposed at the city scale (left); Visible (up) and thermal infrared (down) images of NUS campus in Singapore. The yellow and red areas are hot – corresponding with roads and buildings; blue and green areas are cool and indicate water and vegetation	29
Figure 2.13 Absolute temperature differences between urban stations and the reference station in Athens, 1996 on summer days (left) and during summer nights (right)	33
Figure 2.14 Temporal variations of the day time surface UHIs in Tokyo (temperate) particularly found higher in summer seasons (left) and Bangkok (tropical) found higher in the dry season	34
Figure 2.15 The temperature difference in urban-rural areas in Singapore	34
Figure 2.16 The typical temperature distribution in the Kuala Lumpur area during (a) 14:00-15:00h; and (b) 21:00-22:00	35
Figure 2.17 Urban radiation balance in the tropics: Ibadan, Nigeria	35
Figure 2.18 Annual average daily solar radiation in Malaysia	42

Figure 2.19 Comparing monthly average daily solar radiation in Malaysia in the month of; (a) February and (b) December	42
Figure 2.20 Maximum, minimum and average value of the monthly average daily solar radiation for Malaysia	43
Figure 2.21 Annual energy consumption by enduse in the tropics	49
Figure 2.22 Ecological qualities of trees	52
Figure 2.23 The process of and the benefits of vegetation and tree shading towards buildings and environment	53
Figure 2.24 The three types of standard deviation of air temperature in the four types of land cover	57
Figure 2.25 Dependence of pavement surface temperature on albedo	58
Figure 2.26 Cooling rate for rural, park and urban sites in Mexico City	60
Figure 2.27 Temperature difference across Valencia for two transects (a) This transect is through the city centre including large buildings area (b) through park and river garden 'green' areas	61
Figure 2.28 The graph shows the transaction of temperature and relative humidity istribution in four different areas	61
Figure 2.29 The graph shows the different impact of ground surfaces inside the park and at the parking lot in the commercial area	64
Figure 2.30 The graph shows the different impact on shaded (thin line) and unshaded area (thick line) between physical parameters regarding the air and wall surface temperatures; the heat exchanges between the wall surfaces and the surrounding environment; the wind speed and the humidity of the air	65
Figure 2.31 The significant relationship of tree canopy density and branching structure vs. thermal radiation filtration in tropical climate	66
Figure 2.32 (Above) The correlation analysis between solar radiation and air temperatures at all locations in Clementi Wood Park , (Below) The LAI measurements in seven location within Clementi Wood Park (CWP)	67
Figure 2.33 Spatial contours of normalized temperature during windward wall heating using predicted model	72
Figure 2.34 Simulated patterns and measured in situ values of diurnal air temperature at the sites - cluster with and without trees	75
Figure 3.1 The solar (shortwave) radiation received by the earth and terrestrial (long-wave) radiation emitted by the earth	84
Figure 3.2 Leaf absorption, transmission and reflection	85
Figure 3.3 The differentiation on the impact of the shading with low and high albedos	87

Figure 3.4 The impact of air layers movement influenced by tree and shrubs (left), Air temperature reduction under shade during free air movement (right)	88
Figure 3.5 Of the four main microclimate factors that affect the streams of energy into and away from a person, only radiation and wind can be significantly modified by a landscape	89
Figure 3.6 The cycle of transpiration and evaporation process on single tree supplied with water	90
Figure 3.7 ECOTEECT results show that, starting at 1200 hours the sun is overhead and the shade is concentrated directly around the tree canopy	97
Figure 3.8 The sun path diagram shows position and sun angle at one hour time intervals (Lat. 03°N, Long. 101°E)	97
Figure 3.9 Comparison of the amount shade created by broad/wide canopied trees in contrast to tall canopied tree	98
Figure 3.10 Relationship between shade and height/width of tree canopy	99
Figure 3.11 Comparisons of construction material based on colour	103
Figure 3.12 Comparisons of construction material based on surface colour and surface temperature	104
Figure 3.13 ‘Cool’ and ‘Warm’ material definitions based on physical characteristics and albedo values	105
Figure 3.14 Thermal exchanges between the human body and surrounding environment	109
Figure 4.1 Research methodology frameworks	118
Figure 4.2 The overall site plan of 4200m x 100m areas (left); The site that comprises of three precincts – Precinct 2, 3 and 4 (left)	122
Figure 4.3 The location of Wawasan Park and pocket park in Persiaran Perdana area	123
Figure 4.4 The Landsat 5 TM images (A) was analyzed using eCognition and ArcMap and produced the final output images and percentage of land cover distribution (B)	125
Figure 4.5 The temperature distribution map produced by ENVI 4.1	126
Figure 4.6 Twelve location points for field measurement with different landscape environments and one weather station location point	128
Figure 4.7 Overview of Wawasan Park at Persiaran Perdana, Putrajaya	129
Figure 4.8 The location for the measurement point at Wawasan Park, dominated by high density trees and hard and soft ground cover	129
Figure 4.9 The Istana Kehakiman building with pocket park	130
Figure 4.10 The pocket park with averagely dense of <i>Samanea saman</i> trees (left); the combination of grass and polished white granite	130

Figure 4.11 The pocket space in front of Perbadanan Putrajaya building with an area of sparse greenery	131
Figure 4.12 Pocket space <i>Samanea saman</i> trees with large turf area (left); Ground surface with combination of lawn and polished white granite provided with sitting bench	131
Figure 4.13 The overview of Dataran Putra area (left); the Putra Square dominated with hard paving (right)	132
Figure 4.14 The P3P road fully asphalted due to its current function as a parking lot (left); the area was fully occupied with vehicles during office hours (right)	132
Figure 4.15 The Dataran Rakyat located in front of Ministry of Finance building (left); the measurement area where there was a combination of grass and pavement (right)	133
Figure 4.16 Open space with grass and bare soil representing bare land in the Persiaran Perdana area	134
Figure 4.17 The P2P Road measurement point located near a body of water within a mixed landscape environment	134
Figure 4.18 The measurement location was located 2.5m from the water's edge	134
Figure 4.19 The Perdana Boulevard areas with hard landscape of pavement and asphalt	135
Figure 4.20 The Wisma Tani building (left); the measurement point in front of Wisma Tani Entrance	136
Figure 4.21 The pedestrian area in front of the Wisma Tani building (left); the pedestrian area provided with dense shady trees and a walkway	136
Figure 4.22 The Tunku Abdul Rahman Road with waterfront and walkway landscape environment	137
Figure 4.23 Tiny Tag TGP-4500 Ultra and TGU-4500 Plus portable data logger with Stevenson Screen	139
Figure 4.24 Meterman IR608 Infrared Thermometer	139
Figure 4.25 Nikon CoolPix 990 with fish eye lens	139
Figure 4.26 The weather station was set up at the edge of the 10m-high rooftop	141
Figure 4.27 Eltek 1000 Series Squirrel data logger	141
Figure 4.28 Vaisala temperature and humidity probe HMP35DGT with Stevenson screen	141
Figure 4.29 Vector Instruments Switching Porton Anemometer A100 and Encoder Windvane W200G	141
Figure 4.30 Pyranometer with base and screen model CM – CM 5	141

Figure 4.31 Tiny Tag installed in Stevenson screen attached to (left) lighting post, and (right) tree trunk	142
Figure 4.32 Installation of Tinytag instruments attached to lighting post at a height of 3m	142
Figure 4.33 The reading taken from handheld Meterman IR608 Infrared Thermometer (left); and measurement procedure during measurement taken at 1m chest height	143
Figure 4.34 General ENVI-met model's structure including the boundaries	148
Figure 4.35 <i>Malaleuca leucadendron</i> or Cajeput (ml)	151
Figure 4.36 <i>Filicium decipiens</i> or Fern Tree (fd)	151
Figure 4.37 <i>Mesua ferrea</i> or Ironwood Tree (mf)	152
Figure 4.38 <i>Ficus benjamina</i> or Weeping fig (Fb)	152
Figure 4.39 Sectional diagram showing procedures in measuring h , z_p and LAI_z	153
Figure 4.40 Each of the selected trees was simulated in the ENVI-met model basic setting for predicting per-tree cooling effect	154
Figure 4.41 The 1D main model domain of Persiaran Perdana in a grid cell	155
Figure 4.42 Three dimensional model outputs in four different conditions of environment (A) vegetation coverage and (B) mean LAI for environmental condition A to D	159
Figure 4.43 The measurement area for green spaces areas – i.e. (left) Perbadanan (right) Wawasan Park	161
Figure 4.44 The measurement area for open space areas (left) Rakyat Square (right) Putra Square	162
Figure 4.45 The measurement area for outdoor building spaces (left) Perbadanan corridor area (right) building passageway	162
Figure 4.46 Lutron LM-8000 Portable 4 in 1 Anemometer, Hygrometer, Lux Meter and Thermometer	165
Figure 4.47 AIRFLOW hotwire thermo-anemometer	165
Figure 4.48 Tinytag Talk Globe Thermometers	165
Figure 4.49 The location of Universiti Putra Malaysia 5.4 km from Persiaran Perdana	172
Figure 4.50 Studio 3 Industrial Design Building	174
Figure 4.51 MPIL Building	174
Figure 4.52 Swimming Complex	174

Figure 4.53 Student Centre 1 Building	174
Figure 4.54 Student Centre 2 Building	175
Figure 4.55 Academic Building	175
Figure 4.56 Plant Canopy Analyzer Licor LAI-2000	176
Figure 4.57 Lux meter Lx-101	176
Figure 4.58 Compass type MC-Series	176
Figure 4.59 Nikon Digital Camera COOLPIX 8700	176
Figure 4.60 The diagram shows the typical measurement procedures for direct effect field measurement methods	178
Figure 4.61 Example installation of Tiny Tag at outdoor and indoor wall	179
Figure 4.62 Sky dome and diagram viewed the sky dome with patches from the ground	180
Figure 4.63 Shading mask with colour coded intensity from black (0.0, blocked) to white (1.0, clear)	181
Figure 4.64 The implementation of instrumented photograph in constructing 3D modelling	182
Figure 4.65 The 3D model tree and vertical plane for comparison purposes	183
Figure 4.66 Comparisons of shading mask values for trees on site and vertical planes in distance variation	183
Figure 4.67 The basic layout of Studio 3, Industrial Design building	184
Figure 4.68 The wall slabs layer properties	185
Figure 5.1 Land cover classification with thermal satellite images within 10 km radius of the Persiaran Perdana area from years 1994 to 2005	188
Figure 5.2 Land cover classification with thermal satellite images area in 2005	190
Figure 5.3 Diagram representing land cover classification in the Persiaran Perdana area	190
Figure 5.4 Map and overlaid Persiaran Perdana maps with hot and cool spot distribution	192
Figure 5.5 Putra Square (above), Rakyat Square (middle) and Putrajaya Square (below) hot and cool spot distribution	194
Figure 5.6 Wawasan Park (left), green area and pocket park (right) hot and cool spot distribution	194
Figure 5.7 Promenades and water front hot and cool spot distribution	195

Figure 5.8 Average urban and rural temperatures during one month measurement period	196
Figure 5.9 Comparison of average Persiaran Perdana (urban) and Pusat Pertanian Serdang (rural) temperatures during one month measurement period	197
Figure 5.10 Mean hourly air temperature at 13 measurement points in a typical clear day	199
Figure 5.11 Average, maximum and minimum air temperature in 13 measurement points	201
Figure 5.12 Average, maximum and minimum relative humidity in 13 measurement points	203
Figure 5.13 Average, maximum and minimum of ground surface temperature in 12 measurement points	205
Figure 5.14 Average surface temperatures of ground surface materials in the Persiaran Perdana	206
Figure 5.15 Comparison between measured and computed air temperature for 12 location points	209
Figure 5.16 Comparison between measured and computed surface temperature for 12 location points	211
Figure 5.17 Comparison of hourly temperature reductions for four different tree species in 24-hours period	212
Figure 5.18 Correlation of average air temperature and tree densities (LAI) of four different tree species	213
Figure 5.19 Comparison of hourly temperature reductions for one, four and ten trees in a 24-hours period	215
Figure 5.20 Correlation of average air temperature and tree quantities of <i>Ficus benjamina</i> tree species	216
Figure 5.21 Comparison of hourly relative humidity increase for four different tree species in 24-hours period	216
Figure 5.22 Correlation of average increase of relative humidity and tree densities (LAI) of four different tree species	218
Figure 5.23 Comparison of hourly relative humidity increase for one, four and ten trees in a 24-hours period	219
Figure 5.24 Correlation of average relative humidity and tree quantities of <i>Ficus benjamina</i> tree species	220
Figure 5.25 Comparison of hourly absolute humidity increase for four different tree species in 24-hours period	220
Figure 5.26 Correlation of average increase of absolute humidity and	222

tree densities (LAI) of four different tree species	
Figure 5.27 Comparison of hourly absolute humidity increase for one, four and ten <i>Ficus benjamina</i> tree in a 24-hours period	223
Figure 5.28 Correlation of average absolute humidity and tree quantities of <i>Ficus benjamina</i> tree species	223
Figure 5.29 Comparison of hourly ground surface temperature reduction for four different tree species in 24-hours period	224
Figure 5.30 Correlation of average ground surface temperature reduction and tree densities (LAI) of four different tree species	225
Figure 5.31 Comparison of hourly ground surface temperature reduction for one, four and ten <i>Ficus benjamina</i> tree in a 24-hours period	226
Figure 5.32 Correlation of average ground surface temperature reduction and tree quantities of <i>Ficus benjamina</i> tree species	227
Figure 5.33 Comparison of hourly thermal radiation filtration for four different tree species in daytime period	228
Figure 5.34 Correlation of average thermal radiation filtration and tree densities (LAI) of four different tree species	229
Figure 5.35 Comparison of hourly thermal radiation filtration for one, four and ten <i>Ficus benjamina</i> tree species in a 24-hours period	229
Figure 5.36 Correlation of average thermal radiation filtration and tree quantities of <i>Ficus benjamina</i> tree species	230
Figure 5.37 Comparison of hourly mean radiant temperature for four different tree species in daytime period	231
Figure 5.38 Correlation of average mean radiant temperature and tree densities (LAI) of four different tree	232
Figure 5.39 Comparison of hourly mean radiant temperature reduction for one, four and ten <i>Ficus benjamina</i> tree species in 24-hours period	233
Figure 5.40 Correlation of average mean radiant temperature reduction and tree quantities of <i>Ficus benjamina</i> tree species	233
Figure 5.41 Comparison of hourly wind speed reduction for four different tree species in 24 hours period	234
Figure 5.42 Correlation of average wind speed reduction and tree densities (LAI) of four different tree	235
Figure 5.43 Comparison of hourly average wind speed reduction for one, four and ten <i>Ficus benjamina</i> tree species in a 24-hours period	236
Figure 5.44 Air temperatures at four different conditions; current condition (A) and modified environments (B) to (D) compared at 15:00 in three metres height	239

Figure 5.45 Predicted air temperatures in condition (D) where larger cooling effect can be found throughout Persiaran Perdana area due to trees and ground materials modifications (right) at 15:00; (left) at 03:00	241
Figure 5.46 Air temperatures at four different conditions, i.e. current condition (A) and modified environments (B) to (D) compared at 03:00 in three metres height	242
Figure 5.47 Average air temperatures for 12 location points from condition A to D	243
Figure 5.48 Maximum air temperatures for 12 location points from condition A to D	244
Figure 5.49 Relative humidity at four different conditions; current condition (A) and modified environments in condition (B) to (D) compared at 15:00 in three metres height	246
Figure 5.50 Relative humidity at four different conditions; current condition (A) and modified environments in condition (B) to (D) compared at 03:00 in three metres height	248
Figure 5.51 Average relative humidity for 12 location points from condition A to D	249
Figure 5.52 Minimum relative humidity for 12 location points from condition A to D	250
Figure 5.53 Absolute humidity at four different conditions; current condition (A) and modified environments in condition (B) to (D) compared at 15:00 in three metres height	251
Figure 5.54 Absolute humidity at four different conditions; current condition (A) and modified environments in condition (B) to (D) compared at 03:00 in three metres height	253
Figure 5.55 Average absolute humidity for 12 location points from condition A to D	254
Figure 5.56 Maximum absolute humidity for 12 location points from condition A to D	255
Figure 5.57 Ground surface temperature at four different conditions; current condition (A) and modified environments in condition (B) to (D) compared at 15:00 at ground level	257
Figure 5.58 Ground surface temperature at four different conditions; current condition (A) and modified environments in condition (B) to (D) compared at 03:00 at ground level	258
Figure 5.59 Average surface temperatures for 12 location points from condition A to D	259
Figure 5.60 Maximum surface temperatures for 12 location points from condition A to D	260
Figure 5.61 Mean radiant temperature at four different conditions; current condition (A) and modified environments in condition (B) to (D) compared at 15:00 at 1 meter height	261
Figure 5.62 Average mean radiant temperature for 12 location points from condition A to D	263

Figure 5.63 Maximum mean radiant temperature for 12 location points from condition A to D	264
Figure 5.64 Wind speed at four different conditions; current condition (A) and modified environments in condition (B) to (D) were compared at 15:00 at 3 meter height	266
Figure 5.65 Average wind speeds for 12 location points from condition A to D	267
Figure 6.1 Frequency distribution between thermal perception and preference with air temperature readings for three different space conditions	273
Figure 6.2 Frequency distribution between thermal perceptions and preference with mean radiant temperature readings for three different space conditions	274
Figure 6.3 Frequency distribution between humidity perception and preference with relative humidity readings for three different space conditions	277
Figure 6.4 Frequency distribution between wind perception and preference with wind velocity readings for three different space conditions	280
Figure 6.5 Frequency distribution between light intensity perception and preference with light intensity (lux) readings for three different space conditions	282
Figure 6.6 Correlation between mean thermal sensation votes (MTSVs) and air temperature at the peak hours in Persiaran Perdana	285
Figure 6.7 Correlation between mean thermal sensation votes (MTSVs) and mean radiant temperature at the peak hours in Persiaran Perdana	286
Figure 6.8 Correlation between mean humidity sensation votes (MHSV) and relative humidity at the peak hours in Persiaran Perdana	287
Figure 6.9 Correlation between mean wind sensation votes (MWSV) and wind speed at the peak hours in Persiaran Perdana	288
Figure 6.10 Correlation between mean thermal sensation votes (MTSVs) and PET at the peak hours in Persiaran Perdana	289
Figure 6.11 Summary of the effect of each microclimate factor towards PET in Persiaran Perdana	290
Figure 6.12 Comparison of PET based on the effects of modification on outdoor thermal comfort in Persiaran Perdana	293
Figure 7.1 Summary of the differences of average and peak outdoor and indoor air temperature for six selected environmental conditions	298
Figure 7.2 Summary of the differences of average and maximum outdoor wall and ground surface temperature and indoor wall surface temperature for six selected environmental conditions	301
Figure 7.3 Results on the indoor air temperature affected by external wall and tree canopy shading	304

Figure 7.4 Comparison of external wall and tree canopy on average (left) and maximum (right) indoor air temperature at distance variation	305
Figure 7.5 Ventilation rate results based on the comparison of measured and computed indoor air temperature in three outdoor environmental conditions (i.e. hard surface – without trees, indirect effect of tree – without tree shading, direct effect of tree – with tree shading)	306
Figure 7.6 Comparison between measured and computed results for indoor air temperature in three different outdoor environments	307
Figure 7.7 Comparison of indoor air temperature with air-conditioned space in three different outdoor environments	309
Figure 7.8 Comparison of indoor air temperature with air-conditioned space in three different outdoor environments	309
Figure 7.9 Comparison of total cooling load and reduction of energy usage in three different outdoor conditions	310
Figure 7.10 Comparison of total cooling load and reduction of energy usage based on tree distances	311
Figure 7.11 Summary of the comparison of outdoor air temperature modification in six selected location points in Persiaran Perdana	313
Figure 7.12 Summary of the comparison of indoor air temperature modification in six selected location points in Persiaran Perdana	313
Figure 7.13 Correlation between average outdoor and indoor air temperature and tree quantities in six selected location points	314
Figure 7.14 Correlation between maximum outdoor and indoor air temperature and tree quantities in six selected location points	315
Figure 7.15 Summary of the comparison of total cooling based on each modification in six selected location points in Persiaran Perdana	317
Figure 7.16 Correlation between total cooling load percentage reduction and tree quantities at six selected location points	318

List of Tables

Table 2.1 Typical roughness length z_0 of urbanised terrain	20
Table 2.2 Possible urban factors and effects on the urban environment	20
Table 2.3 Simple classification scheme of UHI types	25
Table 2.4 Air Temperatures UHI max of different cities worldwide	30
Table 2.5 Seasonal variation for UHI intensity (record from 1965-1987) Standard deviation shown below in parenthesis	31
Table 2.6 Reduction in heating degree-days and increase in cooling degree-days (base 18.3°C) due to urbanisation and heat island effects from 1941-1970	31
Table 2.7 Recent Tropical UHI studies	36
Table 2.8 Comparison on the impact of UHI based on urban climatic parameters for both regions	38
Table 2.9 UHI studies in several urban centres in Malaysia	44
Table 2.10 Categorised albedo on typical urban materials and areas	55
Table 2.11 Categorised albedo and emissivity values for selected surfaces	55
Table 2.12 Selected urban albedo values	58
Table 2.13 The differences between asphalt and turf air temperature, vapour pressure and surface temperature	63
Table 2.14 Comparison of cooling loads for different locations	69
Table 3.1 Monthly evapotranspiration (ET) for different land-cover types and for entire urban surfaces	91
Table 3.2 Relationship of PMV, PET and thermal sensation votes for temperate and tropical climate	112
Table 4.1 Major landscape environments and selected location points for measurement	128
Table 4.2 Typical inputs' configuration of a Persiaran Perdana current condition simulation as used in this study	155
Table 4.3 Correlation coefficients between the measured and the computed air and surface temperatures for each location in selected day for a 24 hours period	157
Table 4.4 Summarise table on the changes made in each scenario condition proposed	158
Table 4.5: Activity during last half hours listed in questionnaire	166
Table 4.6: Individual Clothing listed in questionnaire	167

Table 4.7: Description of questions in thermal comfort section	167
Table 4.8: Description of questions in vegetation and shaded area section	168
Table 4.9: Description of questions in overall thermal comfort satisfaction section	168
Table 4.10: Review on typical Clothing Types with clo values (ISO7730, 2006)	169
Table 4.11: The parameter for building selection	173
Table 4.12: The building names and outdoor landscape environment character	173
Table 4.13: The lighting and small power data information	186
Table 5.1 Land cover classification in areas and percentages from year 1994 to 2005	189
Table 5.2 Details of land cover classification in the Persiaran Perdana area	191
Table 5.3 Correlation coefficients between the measured and the computed air temperatures for each location in a 24 hours period	209
Table 5.4 Correlation coefficients between the measured and the computed surface temperatures for each location in a 24 hours period	210
Table 5.5 Results of tree area density and leaf are index for four different tree species	212
Table 5.6 Results of tree area density (LAI) and average temperature reduction for four different tree species	213
Table 5.7 The relation of tree quantities and average temperature reduction	215
Table 5.8 Results of tree density (LAI) and average relative humidity increase for four different tree species	217
Table 5.9 The relation of tree quantities and average humidity increase	219
Table 5.10 Results of tree density (LAI) and average absolute humidity increase for four different tree species	221
Table 5.11 The relation of tree quantities and average increase of absolute humidity	223
Table 5.12 Results of tree density (LAI) and average ground surface temperature Reduction for four different tree species	225
Table 5.13 The relation of tree quantities and average increase of surface temperature reduction	226
Table 5.14 Results of tree density (LAI) and thermal radiation filtration for four different tree species	228
Table 5.15 The relation of tree quantities and average thermal radiation filtration	230
Table 5.16 Results of tree density (LAI) and average mean radiant temperature reduction for four different tree species	232

Table 5.17 The relation of tree quantities and average mean radiant temperature reduction	233
Table 5.18 Results of tree density and average wind speed reduction for four different tree species	235
Table 5.19 The relation of tree quantities and average wind speed reduction	236
Table 5.20 The summary table of per-tree cooling effect performance for four different tree species	237
Table 5.21 Summary table on the optimum cooling effect made by modification of vegetation and cool materials	267
Table 6.1 Summary results of mean subject's clo value and met rate in Persiaran Perdana	271
Table 6.2 Results for thermal sensation perception and preference for peak hours in Persiaran Perdana	272
Table 6.3 Results for humidity perception and preference for peak hours in Persiaran Perdana	276
Table 6.4 Results for wind perception and preference for peak hours in Persiaran Perdana	279
Table 6.5 Results for light intensity perception and preference for peak hours in Persiaran Perdana	281
Table 6.6 Results for intensity perception and preference for peak hours in Persiaran Perdana	283
Table 6.7 Results in terms of thermal comfort satisfaction for peak hours in Persiaran Perdana	284
Table 6.8 Comparisons of subjects' PET on current and modification scenarios in Persiaran Perdana	291
Table 7.1 The differences in the average and peak outdoor and indoor air temperature for six selected environmental conditions	297
Table 7.2 The differences in the average and maximum outdoor wall and ground surface temperature and indoor wall surface temperature for six selected environmental conditions	300
Table 7.3 Comparison of external wall and tree canopy effect on indoor air temperature at distance variation	305
Table 7.4 Correlation coefficient of ventilation rate with outdoor conditions	306
Table 7.5 Correlation coefficients between the measured and the computed air temperatures for each outdoor condition in a 24 hour period	308
Table 7.6 Comparison of total cooling load and reduction of energy usage in three different outdoor conditions	310

Table 7.7 Comparison of total cooling load and reduction of energy usage influence by tree distance from building wall	311
Table 7.8 Comparison of outdoor air temperature modification in six selected location points in Persiaran Perdana	312
Table 7.9 Comparison of indoor air temperature modification in six selected location points in Persiaran Perdana	312
Table 7.10 Comparison of total cooling based on each modification in six selected location points in Persiaran Perdana	316

CHAPTER 1

INTRODUCTION

1.1 Background and Problem Statement

An eagerness to explore better living habitats and create new settlements transformed to better suit human needs has resulted over time in villages, towns and cities prioritising the needs of their inhabitants in terms of society, economics, culture and comfort. Cities have evolved on ever larger scales in order to meet human needs. As a result, huge areas of urbanisation occupied by new building structures and materials have altered the climatic characteristics of urban spaces. In addition, man-made urbanized developments have imposed significant undesirable changes on the natural ecosystem and landscape.

Such changes have a direct effect on the local climate of urban spaces and indirectly cause air and surface temperatures to become hotter than those in rural surroundings; this effect is referred to as the 'urban heat island' or UHI (Landberg, 1981; Emmanuel, 2005; Gartland, 2008). The UHI effect has been explored extensively worldwide (Landsberg, 1981; Oke, 1973, 1978, 1988, 1999; Santamouris et al, 2001; Streutker, 2003; Tran, 2006; Gartland, 2008). According to these studies, the main causes of the UHI phenomenon result from improper design planning, increased urbanisation and abrupt changes to the outdoor environment (Roth, 2002). Further to this there are concerns about climate change worldwide, which report the UHI effect to be one of the main contributors to this phenomenon. This temperature rise in the urban environment is largely a result of the changes of street surface materials and a reduction in green areas (Papadakis et al, 2001; Shashua-Bar and Hoffman, 2004; Takahashi et al., 2004; Wong et al., 2007). The variety of urban grids and buildings generates a wide range of different streets, squares, courts and open spaces that further modify local climates into urban microclimates (Scudo, 2002). In addition, rising concrete buildings have crowded out vegetation and trees (Santamouris et al, 2001). Consequently, heat islands can be identified as contributing to human discomfort, health problems, higher energy bills and increased pollution (Gartland, 2008).

In a temperate climate, the maximum UHI effect can be noted only during the summer season (Yague et al., 1991; Swaid et al., 1993; Taha, 1997; Santamouris et. al., 2001). However, in the tropics it can be experienced during hot dry seasons and year round due to the constant high exposure to solar radiation in these areas (Grimme and Laar, 2005 and Tran et. al, 2006). This phenomenon has become serious in the tropics where lack of shading and green spaces has led to a failure to balance the heat from direct solar gains. In addition, the use of dark materials in buildings and pavements collects and traps more of the sun's energy. This leads to air and surface temperature increases and negatively influences human thermal comfort and increases building energy consumption in the tropics.

Nieuwolt's (1966) study was one of the earliest tropical urban microclimatic studies; it was conducted in Singapore's urban south (Tso, 1996; Wong and Yu, 2005; Emmanuel, 2005). This was followed by numerous studies on heat island intensity in tropical cities around the globe, which have been presented widely, and contributed to the understanding of the phenomenon's behaviour (WMO, 1986; Givoni, 1989; Monteiro, 1986, Nichol, 1996; Emmanuel, 2003). However; in the case of Malaysia specifically, research in this field was initiated by Sham (1973, 1986, 1987, and 1990/91) who investigated UHI intensity in selected cities in Malaysia finding heat island intensity ranges from 2 to 7°C. In a Kuala Lumpur heat island intensity study, he found about a 6°C difference on clear days. Since then various studies have been undertaken to assess the UHI in other urban centres in Malaysia (Lim, 1980; Zainab 1980; Shahrudin, 1994; Sin & Chan, 2004, Elsayed, 2006). However, there is a lack of studies on those newer city areas that have been developed over recent years. This information is crucial to an understanding of the effect of UHI behaviours when designing and planning contemporary urban developments.

For this reason Putrajaya is considered here, as it is a new city that has been planned to enable the relocation of several government offices to gain relief from the overcrowding and congestion in the Kuala Lumpur city area. The city was established recently and it is still undergoing minor development. Deterioration of the outdoor environment from a result of heat island effects and similar phenomena has become a serious problem. This aggravation of the thermal environment threatens urban sustainability. According to Krisnan (2007) reported in The Star newspaper, *"...Putrajaya, is 5 °C hotter than other cities in the country such as Kuala Lumpur, Penang and Johor Baharu. Rapid development and the lack of trees are turning these cities into urban heat islands (UHI) that are hot even at night. It also reported*

that scientifically, Putrajaya and the other cities are termed as UHIs, a phenomenon where concrete surfaces trap heat during the day and release it during the night...Putrajaya is a planned garden city with 1,826.5ha or 37.0 % of the land area dedicated to green and open spaces but it wasn't spared the UHI phenomenon...". This problem largely occurs at the heart of the city in the federal administrative centre area within the 4.2 km long and 100m wide public thoroughfare in Persiaran Perdana, Putrajaya. Therefore, due to lack of detailed evidence and studies, this issue has become significant for this study, which aims to investigate further the causes of urban heat island phenomenon, taking Persiaran Perdana as a case study.

Evidently, it is unhelpful to merely discuss the causes of UHI, it is vitally necessary to also consider mitigating strategies to manage and reduce these raised temperatures. In order to mitigate the impact of the UHI effect and improve the microclimate in tropical urban environments, two main strategies have been proposed at street level: more vegetation and higher albedo (Shashua-Bar and Hoffman, 2000; Santamouris, 2001; Akbari et al. 2001; Emmanuel, 2005, Solecki et al., 2005). According to Akbari (2001) the majority of the summer heat islands are created by the lack of vegetation and the high solar radiation absorptions of urban surfaces. Therefore, to reverse or redress this tendency, urban trees and high-albedo surfaces should be incorporated into the town planning (Jauregui, 1990/91; Shashua and Hoffman, 2000; Akbari et al., 2001; Solecki et al., 2005; Yu and Wong, 2006; Wong et al., 2007). According to Taha's (1997) study, numerical studies and field measurements indicate that increasing albedo and vegetation cover can be effective in reducing surface and air temperatures near the ground. A further result from meteorological simulations suggests that cities can possibly reverse heat islands and counterbalance their impact on energy use simply by increasing the albedo of roofing and paving materials and reforesting urban area (Taha, 1997).

A single tree can measurably moderate the climate and the impact of a large numbers of urban trees can improve urban thermal comfort in warmer climates (Jauregui, 1990/91 and Akbari, 2002). Indeed, in tropical climate conditions the cooling effect of urban trees is most prominent (Shashua and Hoffman, 2000). Tree shading and the evapotranspiration process are important factors contributing to this cooling effect (Brown and Gillespie, 1995; Santamouris, 2001; Gartland, 2008). In addition to moderating the urban microclimate and human outdoor thermal comfort, Givoni (1989) has claimed that the type and features of the

plants around buildings can affect the cooling effect. However; the effect varies from tree species to tree species as well as from tree to tree within the same species. Species based studies have been lacking in tropical regions, either based on field measurement or modelling approaches. Variation in cooling effects from different type of trees needs to be determined in order to understand the absolute cooling effect on the urban environment.

In the enhancement of cooling effect from trees into urban environment, additional strategy promoting cool pavements by increasing the albedo have a significant effort on maximizing impact. In urban areas, using high albedo materials can reduce the absorption of solar radiation through urban ground surface and building envelopes, keeping their surfaces cooler (Brown and Gillespie, 1995; Taha, 1997; Santamouris, 2001; Emmanuel, 2005). Simultaneously, it will cool the air in urban areas (Gartland, 2008). The effect will be greater when tree shading affects the radiative exchange process of ground and wall surfaces by intercepting radiant energy. More latent heat will be released, promoting evaporative cooling to the air (Dimoudi and Nikolopoulou, 2003). Therefore, it is important for this study to focus on both combination modifications in order to create an optimum cooling effect at street level aiming to effectively mitigate the UHI in tropical region. However, some questions can be raised here; how can these entities be improved and modified to promote a significant cooling effect? How significant will the air and surface temperature reduction be? How much will this combination modification influence human outdoor thermal comfort and building energy saving? This study will address these questions through a case study of Persiaran Perdana, Putrajaya.

1.2 Aim and Objectives

The aim of this study is to examine quantitatively the potential of the cooling effect in combination of trees with ground surface albedo modification at street level in mitigating UHI effects in the city environment. It will assess the potential for and predict the optimum cooling measures for outdoor urban spaces based principally on the physical properties of trees and ground surface material. It will include measurement of how much the combination modification will reduce the urban air temperature, and improve human outdoor thermal comfort and building energy performance. This study will highlight the tropical climate city environment by using as a case study the area of Persiaran Perdana, Putrajaya, Malaysia. To achieve this aim, the following objectives were derived:

1. To review the literature on the UHI effect phenomenon, especially in tropical regions and how it can be mitigated, and to strategically review the combination cooling and modification potential of vegetation with albedo.
2. To assess the current environment conditions regarding the UHI effect in the Persiaran Perdana, Putrajaya area by identifying 'hot' and 'cool' spots using satellite images evaluation and field measurements.
3. To apply the three dimensional microclimate model ENVI-met to simulate and assess Persiaran Perdana's current condition and compare this with field measurement results.
4. To determine the per-tree cooling effect for different densities, and to predict optimum cooling potential by comparing the Persiaran Perdana's current condition and different proposed modification scenarios using ENVI-met.
5. To assess users' outdoor thermal comfort perception in Persiaran Perdana by means of a questionnaire survey and to assess the influence of scenario modification results on their comfort level.
6. To assess the influence outdoor environments on indoor environments by means of field measurements, and to assess, using the HTB2 building thermal model, the energy saving of a building as the result of lower ambient temperatures due to the improvement of outdoor environment modification.
7. To propose guidelines for improving UHI mitigation strategies based on the case study of Persiaran Perdana, Putrajaya.

1.3 Hypotheses and Research Questions

In accordance with the background to this study, the following hypotheses were instigated:

- i. Trees and ground surfaces' albedo can be modified and combined to promote a significant optimum cooling effect.
- ii. Variations in tree density can create a different cooling effect to that observed in the surrounding microclimate.
- iii. Urban air and surface temperature conditions vary as combination of tree densities with ground surface albedo values increase.
- iv. Modification of the outdoor environment influences human outdoor thermal comfort, the indoor environment and consequently building energy savings.

So as to better understand the hypotheses, this study also generated a requirement to answer the following research questions:

- i. How can trees and ground surfaces' albedo be modified and combined to promote a significant optimum cooling effect?
- ii. How does per-tree cooling effect differ due to variations in tree densities and tree species?
- iii. How much does the microclimate environment differ in terms of air temperature, ground surface temperature, relative humidity and other microclimate variables after combination modification has been made?
- iv. How much is human outdoor thermal comfort and building energy performance influenced after outdoor combination modification has been made?

1.4 Scope and Limitations of the Research

This research focused on the combination effect of trees with ground surface albedo modification at street level on improving the outdoor environment through air and surface temperature reduction in Persiaran Perdana, Putrajaya, Malaysia. The improvement of the outdoor environment was focused on mitigating the heat island effect that has been found to occur in this particular urban area. As the focus of the study is on street level, this investigation does not include building rooftops. This allows for a better understanding of the horizontal impact and behaviours of cooling from tree with ground surfaces on the surrounding outdoor environment, people and buildings. Therefore, the investigations incorporated in the influence of the cooling impact on outdoor thermal comfort and building energy performance.

Field measurements to investigate UHI mitigation strategies and the outdoor thermal comfort survey were conducted at the same time. Due to time constraints, cost and equipment limitation; building energy performance field measurements were taken in a separate month of the year. However, this will not influence much on the results as the weather condition in tropical climate of Malaysia is relatively constant throughout the year.

The analyses were conducted in three parts, and limitations are listed according to the individual investigations as follows:

Investigation of UHI strategies

1. In order to compare changes in land cover distribution using thermal satellite images between the years 1994 and 2005, satellite images from Landsat-5 TM were used due to problems with acquiring advanced satellite images such as Landsat-7 ETM+ pre-1999.
2. In the field measurement investigation, there were found to be limited number of Tinytag data loggers and Infrared Thermometers available for data collection. These were needed in order to make the data collected more representative of the different outdoor landscape environments across the boulevard. Therefore, 12 significant location points with different outdoor landscape characters were observed and then selected in order to represent the environment of Persiaran Perdana.
3. ENVI-met simulation were limited to three proposed scenarios due to time and hardware constraints as the simulation generally takes 10 times longer than that of pilot study area (i.e. 246 m x 284 m) as the size of the site study is larger (i.e. 4200 m x 2200 m area).

Human outdoor thermal comfort

1. Thermal investigation consisted of measuring air temperature, globe temperature, and relative humidity and wind speed. Thermal measurements were performed simultaneously with the questionnaire survey in order to ascertain an immediate respondent's impression to their thermal comfort conditions. Therefore, mobile handheld instrumentation was used for completing this task.
2. There were limited numbers and types of instruments for field measurement. Thus, the measurement was taken according to instrumentation limitation and availability.

Building Energy Savings

1. In order to provide a measure of the absolute reduction of indoor air temperature influenced by outdoor landscape conditions, buildings without air conditioning systems were needed for field measurements. Due to the full air conditioning of buildings in Persiaran Perdana during working hours and regulations forbidding the researcher from turning off the systems during the period of measurement, the

nearest potential building area without an air conditioning system was chosen in order to perform this task. The area is within six kilometres of Persiaran Perdana and there are mostly identical in climatic condition between the two areas. As part of this work is to obtain a general idea of variation effect in outdoor environment towards indoor environment, the UHI effect in this area is not comparable to the site study area, thus not considered as a significant parameter. However, there were limitations and constraints regarding finding a single building with different outdoor landscape conditions. Thus, five buildings with six identifiable outdoor environmental conditions were selected in the Universiti Putra Malaysia area. The selection of these buildings was made based on similarity of site and boundary conditions, buildings' types, height, construction and orientation.

1.5 Research Framework

In answering the research questions and achieving the research aim, the following tasks were identified and carried out. The research framework is divided into four phases (Fig. 1.1). In the first phase, a literature review was carried out in two chapters (Chapters 2 and 3). The first of these chapters discusses those urbanisation factors that affect the formation of the UHI. References to previous UHI studies were differentiated according to non-tropical and tropical regions. Focus on UHI studies in Malaysia was carried out for a better understanding of current issues before evaluating the findings of the case study UHI discussed in Chapter 5. At street level, there are two potential UHI mitigation strategies and both strategies are discussed through the role of vegetation and cool urban surfaces in urban climates. A review of existing studies into UHI mitigation strategies was also investigated.

The second review chapter assesses trees with ground surface albedo modification in promoting optimum cooling effects. The potential for promoting optimum cooling effect is discussed based on the physical characteristics of trees and ground surface materials. In this chapter, the combination potential for tree with ground surface materials to modify urban microclimates is investigate based on their influence towards four major microclimatic components; namely, solar radiation, wind, air temperature and relative humidity. The bioclimatic benefits of the tree cooling effect and usage of cool materials on human outdoor thermal comfort and building energy performance are also discussed in this chapter.

In the second phase, the practical research methods are explained further in chapter 4. The research method is divided into three parts of methodology, namely, UHI mitigation strategies method, outdoor thermal comfort surveys and the building energy savings method. The method undertaken for UHI mitigation in Persiaran Perdana is explained in three parts; namely, remote sensing satellite imagery method, field measurement programme and computer simulation programmes. Next, the outdoor thermal comfort survey is explained based on the survey, questionnaire and measurement procedures. Finally, the last part is an explanation of the field measurement and computer simulation programmes used for assessing the building energy savings, as influenced by outdoor environment modification. A review from each pilot test is also discussed in this chapter.

Results from all methodology outputs were gathered in phase three wherein findings and the discussion chapter were discussed. Results from the UHI mitigation strategies, outdoor thermal comfort and building energy savings assessments are discussed separately in individual chapters in order to provide in depth explanation of each assessment, namely, in Chapter 5, 6, and 7, respectively. However, the discussion regarding thermal comfort and building energy savings assessment continually reference the UHI mitigation strategies findings in order to understand the effects of outdoor modification on both subjects.

In phase four, conclusions are drawn from this study. The outline from the previous three chapters are gathered and evaluated in order to propose guidelines for improving UHI mitigation strategies based on a case study of Persiaran Perdana, Putrajaya. This is followed by proposals for further research on the subject of mitigating the heat island effect through combination of trees with ground surface albedo modification.

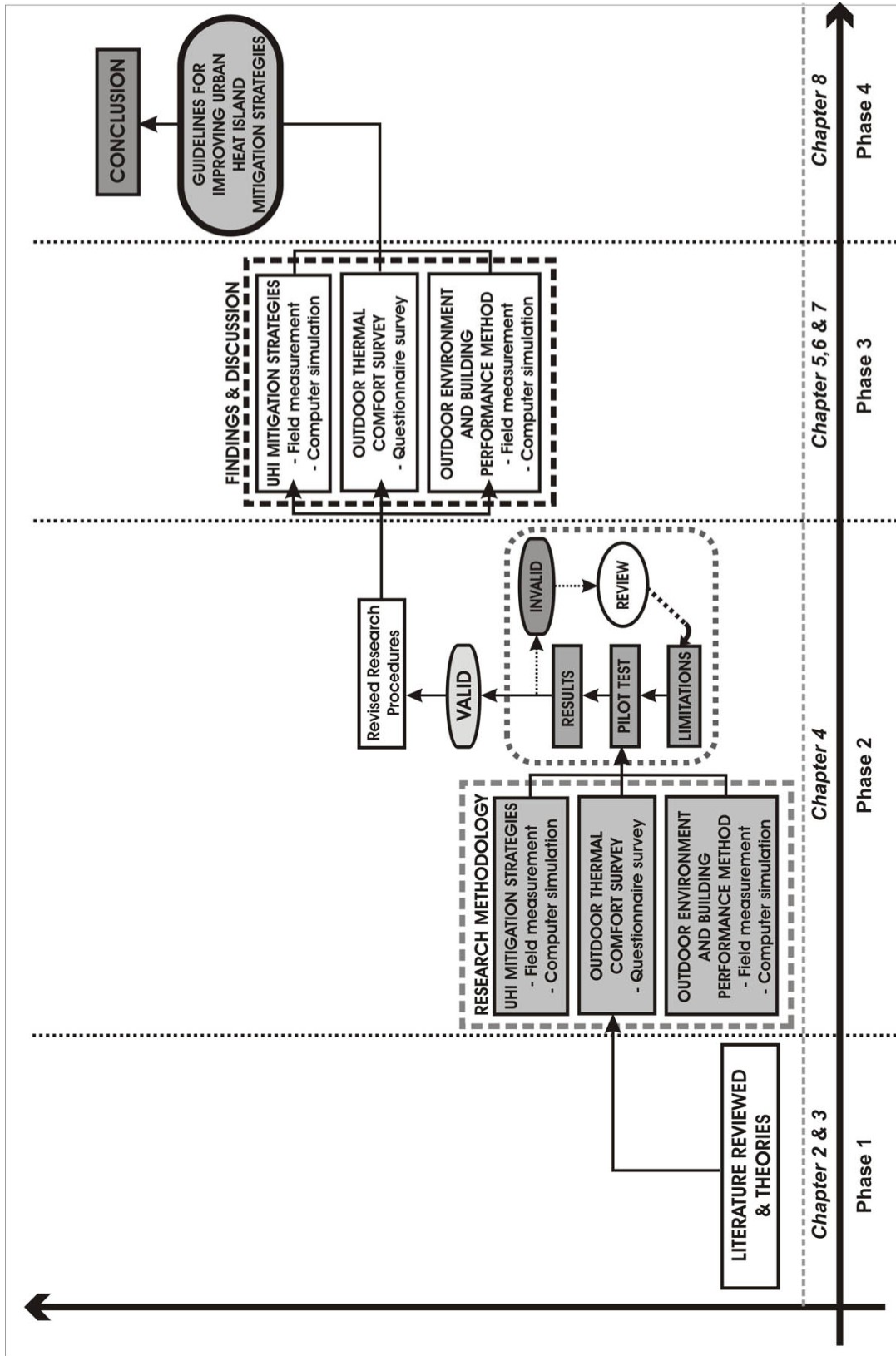

Figure 1.1: The research framework

1.6 Summary

This chapter highlights the need of this study to improve the outdoor urban climate conditions by improving heat island mitigation strategies to ensure satisfactory user comfort in the tropical country of Malaysia. Focus was given to the Persiaran Perdana boulevard area in the city of Putrajaya. In order to further understanding of the current scenario relating to the research, literature supporting the research scope and theory are reviewed in Chapters 2 and 3.

CHAPTER 2

REVIEW OF URBANISATION AND THE UHI EFFECT

2.1 Urbanisation and Climate

According to the Dictionary of Landscape Architecture and Construction (Christensen, 2005), urbanisation can be defined as: *the process of covering a significant portion of a land area with buildings or impervious pavements*. Based on the same source, urban climate can be defined as: *the climate in and near urban areas. It is often warmer, more or less humid, shadier, and has more reflected light than the climate of the surrounding land areas*. It also has been defined by the Dictionary of Environment and Conservation (Park, 2007) as: *a local climate that is affected by the presence of a town or city, which can include lower relative humidity, lower wind speeds, and higher rainfall*. Based on the above definitions, we can clearly see how climate affecting scenarios happen in most areas of the world that are influenced by urbanisation. The changes to landscapes, land forms and ground surfaces as a result of the introduction of new materials and buildings development result in a huge modification to urban climate.

The residential, commercial and industrial developments, which are the main components of urbanisation, have created the most dramatic human-induced change to a natural ecosystem or landscape through the creation of a largely impervious landscape consisting of stiff and sharp-edged rough building blocks (Roth, 2002). This environment that results from fast growing urbanisation and industrialisation has caused deterioration to the urban environment. In addition, the increasing numbers of buildings have crowded out vegetation and trees (Santamouris et al., 2001).

For example, Karaca et al. (1995) found an upward trend occurs in the urban temperatures of Southern Istanbul, which is the most highly populated and industrialized part of the city. Urbanisation and industrialisation in this particular area have been shown to have a negative impact on regional cooling. In another example, Mochida et al. (1997) found that rapid urban development had significantly changed the regional climate in the Tokyo area, leading to various environmental problems due to the replacement of previous land-uses (e.g.

green vegetation area, river and pond) with non-ideal ground surface conditions (e.g. asphalt road, pavement and artificial heat release). Furthermore, Ichinose et al. (1999) claimed that urbanisation has created a warm bias of 2.8°C regarding the lowest air temperatures seen in the 135 years climate record for Tokyo (Tran et al. 2006). In downtown Los Angeles, USA, it has been clearly demonstrated that the maximum temperatures are now about 2.5°C higher than they were in 1920; moreover, Washington DC saw a similar phenomenon where temperatures increased by around 2°C between 1871 and 1987 (Akbari et al., 2005). Based on this evidence, it can be said that the changes resulting from urbanisation have led to major changes to the urban climate in every city around the globe.

Fundamentally, the impact of the urban environment can be identified as resulting from several factors such as implementation of the new surface materials (e.g. concrete, asphalt, tiles and etc.), the construction of buildings and the emission of heat, moisture and pollutants. Urbanisation significantly alters the major properties of the surface and the atmosphere in urban areas, affecting radiative, thermal, moisture, roughness and emissions (Oke et al., 1991; Roth, 2002).

(i) Firstly, **radiative** changes will occur due to the introduction of new surface materials, which have a larger range of **albedo** and **emissivity** values than vegetation. Lack of shading elements (e.g. vegetation) in urban area allows the radiative changes to become higher and uncontrollable. This may cause higher ground surface and wall temperature, thus affecting the surrounding microclimate.

Normally, solar radiation provides nearly all the energy that is needed from the climate system. The rate at which heat is added to the system is of primary importance to the overall structure of the environment. Recent measurements indicate that the solar constant, S_0 (defined as the solar energy per unit time per unit area perpendicular to the mean Earth-Sun distance), is about 1365-1372 Wm^{-2} (Santamouris, 2001). If there are any changes, these can be caused by forces external to the climate system. Of the sun's radiation; 7 % is in the ultraviolet region ($\lambda \leq 0.4 \mu\text{m}$), 44% is in the visible region ($0.4 \leq \lambda \leq 0.7 \mu\text{m}$) and 37% is in the near infrared region (Figure 2.1) (Oke, 1978; Santamouris, 2001).

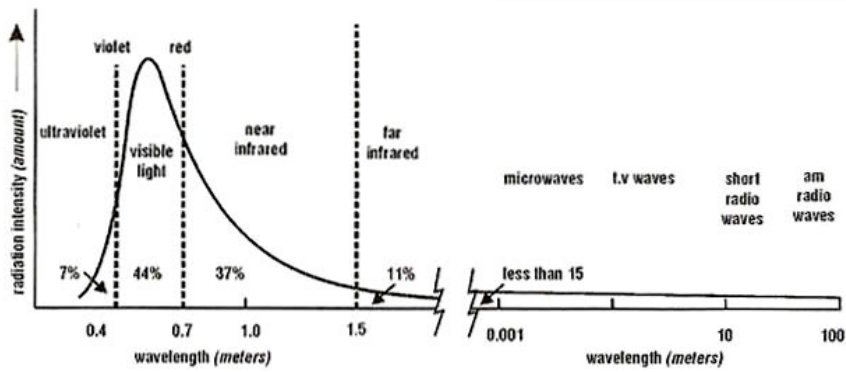

Figure 2.1 The electromagnetic spectrum of the sun (Source: Santamouris, 2001)

Therefore, when radiation arrives (travels from its source in straight line) at any urban surface, some of it may be reflected, some may be absorbed, and some may be transmitted through the object, thus, preventing anything else from happening to it (Figure 2.2). This important concept demonstrates that some of the radiation that reaches a surface is normally reflected and this is a function of the surface’s reflectivity. This is also referred to as the albedo of a material.

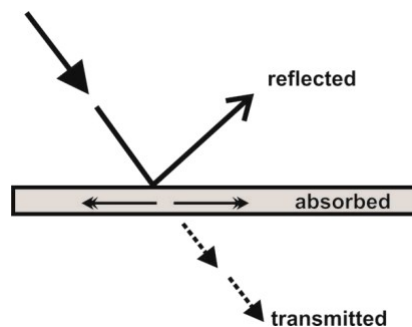

Figure 2.2 Radiation arriving at the surface will be reflected, absorbed and transmitted through the surface (After: Brown and Gillespie, 1995)

The albedo (α) of a surface is defined by its hemispherically and wavelength-integrated reflectivity for any simple uniform surfaces and for heterogeneous and complex ones (Taha, 1997, Santamouris, 2001). It is the ratio of the reflected part of the incoming radiation on a medium of finite thickness to the total incoming radiation (Alexandri, 2005).

$$\alpha = \frac{\text{reflected part of incoming radiation}}{\text{total incoming radiation}} \quad \text{Eq. 1}$$

The wavelength of the incoming radiation, the elevation of the sun and the character of the surface define the albedo value. There is a range of values for most materials. This is due to the variability of natural elements. It calculates the amount of solar energy absorbed

and this indicates the thermal property of a substance. Usually, some portion of the radiation reaching the surface is absorbed into the substance and the energy is then transferred to the molecules of the materials. The energy excites the molecules and subsequently increases the temperature of the material (Brown and Gillespie, 1995). It is noted that the higher the albedo of the surface the lower the energy absorbed by the medium; when the lower value is used the energy absorbed will be higher. Therefore, it is believed that because most of the ground surfaces and walls in urban area consist of materials with lower albedos the surface temperature becomes higher. As a result of this, the surrounding air temperature will be affected and the surrounding environment becomes hotter.

Another important aspect in radiative changes to the urban environment is the emissivity value of substance. Emissivity (ϵ) is the ability of a body to emit thermal radiation. The maximum possible thermal radiation at any given temperature is the one emitted by a black body (Alexandri, 2005). Emissivity of a surface can be defined as:

$$\epsilon = \frac{\text{energy emitted from a surface}}{\text{energy emitted from black surface at same temperature}} \quad \text{Eq. 2}$$

Therefore, all terrestrial objects (any surface from urban ground and wall) emit long-wave radiation at a rate controlled by their temperature. Therefore, the higher emissivity value is correlated to the larger the thermal radiation emitted by the body. The range of urban materials may have low (e.g. bright aluminium foil 0.13 and bright galvanized iron) or high emissivity (e.g. concrete 0.94 and asphalt 0.95); vegetation has generally high emissivity (0.94-0.99). The interaction on the heat exchange is dependent on the distance between the surface or body. The radiated heat exchange could be insignificant if the body is distant (Brown and Gillespie, 1995).

It should also be noted that the warming of the urban environment in the radiative exchange context (emissivity) depends also on the geometry of the urban structure, specifically on the sky view factors. Oke et al. (1991) claimed that the role of emissivity is more minor during the night in the urban environment when compared to rural areas. There is a temperature increase of 0.4K only as emissivity increased from 0.8 to 1.0 (in conditions such as very tight canyons there is almost no change for higher view factors), representing

only very small differences and changes to urban air temperature. However, the combination of higher emissivity and the albedo value of materials will allow for greater changes in the air temperature of urban areas.

Shade is another important factor when it comes to the radiative exchange process of ground and wall surfaces. Shading is responsible for limiting heat from direct solar gains by causing a reduction of urban surfaces. By having shade, we can manipulate the total radiation absorbed at a site by shading, or by changing the solar reflectivity (albedo) of objects. This will decrease the intercepted solar radiation, but will increase the incoming longwave radiation (since trees and other shading object are better emitters than the sky). However, the net result is still a decrease in total radiant energy input (Brown and Gillespie, 1995). Lack of this component in city areas will lead to a surface and air temperature rise. Therefore, shading by trees and other shading devices are of prime importance in reducing the surface temperature in the case of any artificial surfaces in urban built-up areas (Figure 2.3).

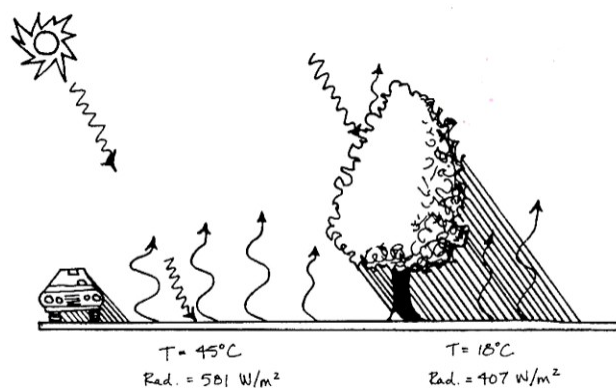

Figure 2.3 Example: Shading and radiation filtration by trees reduces the surface temperature of the ground surface (Source: Brown and Gillespie, 1995)

(ii) Secondly; when the **thermal mass** of buildings is larger compared to natural surfaces thereby providing a massive reservoir for **heat storage** in the daytime and release at the night time, this significantly affects the higher night time temperatures in urban areas. Furthermore, it will reduce the potential to decrease ambient temperatures through evapotranspiration.

Heat capacity (heat storage) is the ability of a body to store heat. It can be defined as the amount of heat needed to elevate the temperature of a given mass by 1K (Alexandri, 2005). Most urban structures have a high thermal capacity. Generally, the urban mass has its own thermal capacity and conversely the thermal capacity of vegetation is almost negligible. The high thermal capacity of buildings' tends to delay the heat transfer to the interior of the building by soaking up excessive heat for several hours. Later, during the night when the external temperature is lower, the stored heat is slowly expelled to the environment via radiation and convection (Figure 2.4). Therefore, the night-time temperatures will increase due to this heat transfer process. However; there is practically no heat storage in vegetated surfaces, therefore regional differences in air temperature can be found in urban and rural environments.

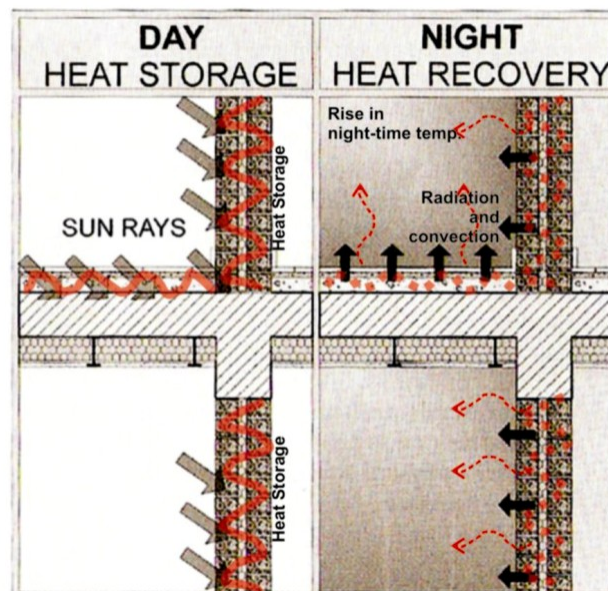

Figure 2.4 The heat storage process in buildings surface at day and night-time (After: Santamouris, 2001)

(iii) Thirdly, the reduction of **moisture** for **evapotranspiration** caused by effective “sealing”, due to the replacement of surface materials (e.g. concrete, asphalt and pavement) from natural soil and vegetation, will reduce the humidity of the urban environment.

Evapotranspiration (the combination of evaporation and transpiration) from soil-vegetation systems is another moderator and can contribute significantly to reducing urban temperature (Taha, 1997; Santamouris 2001). This is because vegetation produces more latent heat flux and so can modify the local climate. If vegetation is removed extensively and

replaced by water proofed material, the latent heat will decrease and most of the radiation will be converted into sensible heat. As a result, the moisture content in the city will reduce and the air will be drier and hotter than in rural areas.

The process involved can be explained through the *energy budget process*, where there is a balance between the radiant energy supplied and the energy removed by all consumers. The four major consumers are long-wave radiation by object at the site, conduction (λ) of heat into objects, evaporation of water, and convection of heat from the object into the air by wind (Brown and Gillespie, 1995). The energy budget can be defined as:

$$\begin{aligned} &\text{Radiant energy supplied} - \text{Long-wave radiation emitted} \\ &- \text{Conduction} - \text{Evaporation} - \text{Convection} = 0 \quad \text{Eq. 3} \end{aligned}$$

Due to the high porosity of vegetation and soil, which can absorb more water, more of the latent heat can be released into the atmosphere through the evaporation process. However, urban material with waterproof textures channel the rainwater away from the city through sewers preventing latent heat flux from the surface (Alexandri, 2005). It is clearly shown in figure 2.5 that there is difference in typical energy partitioning in vegetation and asphalt surfaces at noon and during the evening.

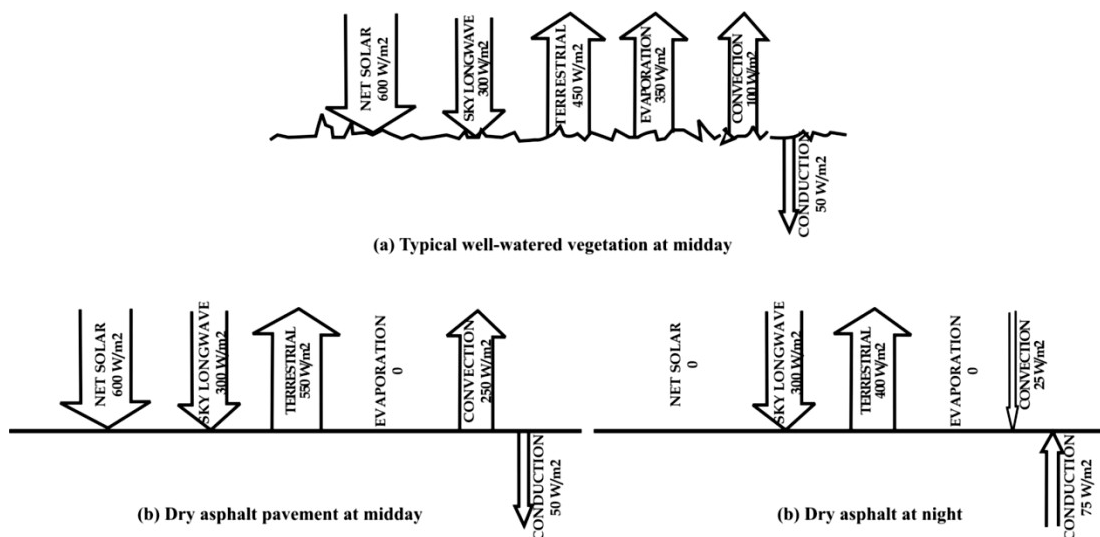

Figure 2.5 Typical partitioning of energy over different landscape surfaces at noon and during the evening. (After: Brown and Gillespie, 1995)

(iv) Fourthly; the rapid development of obstacle elements such as buildings that act as bluff bodies due to their impermeability, inflexibility, and sharp edges will create strong positive and negative pressure differences over their surface, leading to flow separation and vortex shedding when exposed to **urban airflow**. As a result, this affects the transport of energy, mass and momentum to and away from the city surfaces. Therefore, the turbulence in the city area will be **rougher** than the homogenous atmosphere over rural surroundings.

The urban layer can be divided into two parts: the urban boundary layer (UBL) and the urban canopy layer (UCL). Wind flows in the UBL could be considered as “undisturbed” wind, where it is not influenced by urbanisation. However, this flow is modified by topography as well as by the presence of water bodies. This “undisturbed” wind is called the “gradient wind” and its velocity is “gradient velocity” and it typically flows at a height of a few hundred meters above ground (Emmanuel, 2005).

Meanwhile, at near ground level the wind experiences friction, drastically changing wind speed which is increased within the short distance affected by topography and the urban form (Figure 2.6).

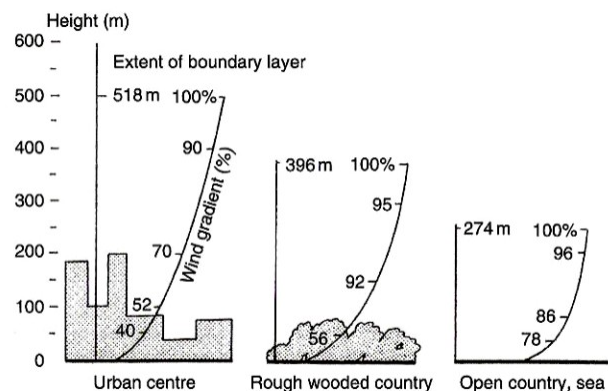

Figure 2.6 Wind velocity profiles: depth of boundary layers at different topography – Urban centre, rough wooded country, open country and sea (Source: Szokolay, 2004)

This occurs because of elements of the buildings (roughness etc.) retarding the wind flow. Due to the sharp angled bodies of buildings the wind becomes retarded, but at the same time the turbulence of the flow is greatly enhanced. Therefore, this affects the energy transport to and away from the city surface. Oke (1978) has listed the typical roughness length z_0 , of urbanized terrain (Table 2.1).

Table 2.1 Typical roughness length z_0 of urbanized terrain (After: Oke, 1978)

Terrain	z_0 (m)
Scattered settlement (farms, villages, trees, hedges)	0.2-0.6
<i>Suburban</i>	
Low-density residences and gardens	0.4-1.2
High density	0.8-1.8
<i>Urban</i>	
High density, <five-storey row and block buildings	1.5-2.5
Urban high density plus multi-storey blocks	2.5-10

(iv) Finally; the **emission** from aerosols and greenhouse gases affects radiative transfer by acting as condensation nuclei, thus, waste heat and water vapour from combustion is added to the urban atmosphere. In addition, **anthropogenic heat**, i.e. that released by the combustion of fuels from either movable systems (e.g. cars, buses, transportation etc.), or stationary sources (e.g. power generation), as well as from human or animal metabolism will act as excessive heat, warming the urban atmosphere and increasing air temperature (Roth, 2002). Table 2.2 below summarises all the possible urban factors and their effect on the urban environment.

Table 2.2 Possible urban factors and effects on the urban environment (After: Oke, 1991)

<i>Factors</i>	<i>Effects</i>
1. Canyon radiative geometry (Urban geometry and radiation)	<ul style="list-style-type: none"> i) Contributes to the decrease in long-wave radiation loss from within the street canyon due to the complex exchange between buildings and the screening of the skyline. ii) Infrared radiation is emitted from the various buildings and street surfaces within the canyons. iii) Buildings replace a fraction of the cold sky hemisphere with much warmer surfaces, which receive a high portion of the infrared radiation emitted from the ground and radiate back an even greater amount.
2. The thermal properties (albedo) of materials	<ul style="list-style-type: none"> i) Increased storage of sensible heat in the fabric of the city during the daytime and release of the stored heat into the urban atmosphere after sunset. ii) Replacement of natural soil or vegetation by materials, such as concrete and asphalt, used in cities reduces the potential to decrease ambient temperature through evaporation and plant transpiration.
3. Anthropogenic heat	<ul style="list-style-type: none"> i) Released by the combustion of fuels from either mobile or stationary sources, as well as from animal metabolism
4. The urban greenhouse effect	<ul style="list-style-type: none"> i) Increases in the incoming long-wave radiation from the polluted urban atmosphere. This extra radiative input to the city reduces the net radiative drain.
5. Canyon surfaces and radiation	<ul style="list-style-type: none"> i) Decrease in the effective albedo of the system because of the multiple reflection of short-wave radiation by canyon surfaces.
6. The reduction of evaporating surfaces	<ul style="list-style-type: none"> i) The city puts more energy into sensible heat and less into latent heat.
7. Reduction in turbulent transfer	<ul style="list-style-type: none"> i) Reduced transfer of heat from within streets.

These changes in atmosphere and the urban climate are reflected in an altered energy balance (figure 2.7).

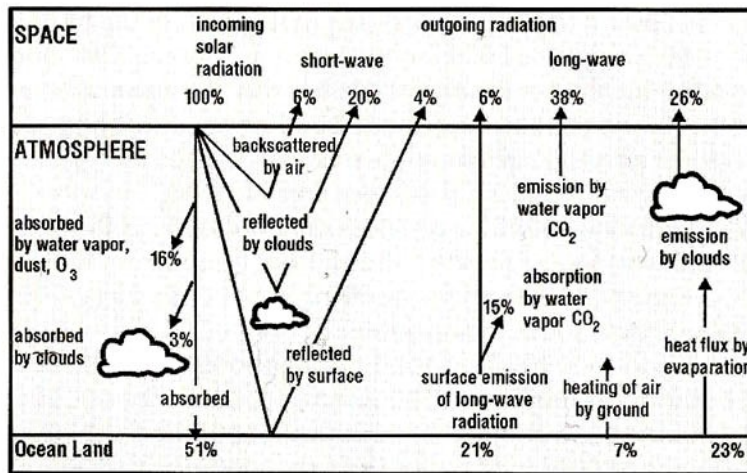

Figure 2.7 The energy balance of the earth (Source: Santamouris, 2001)

In the urban environment, the energy balance of the ‘Earth surface’s ambient air’ system is governed by energy gains and losses. It is also influenced by the energy stored in solid components in the urban area, mostly buildings and streets (Santamouris, 2001). In general:

$$\text{Energy gains} = \text{Energy losses} + \text{Energy storage.} \quad \text{Eq. 6}$$

This can be explained (Oke, 1978 and Santamouris, 2001) by; energy gains involve the sum of the net radiative flux Q_r (in the form of both solar radiation and long wave radiation emitted by solid components). It also involves the anthropogenic heat Q_t that gains from urban transportation systems, power generation and other heat sources.

On the other hand, sensible heat Q_E or latent heat Q_L resulting from heat convection between solid surfaces and the air, as well evapotranspiration, resulted in energy losses. Thus, it should also be noted that the advective heat flux between urban and surrounding environments can also produce energy losses. Therefore, this can be written as:

$$Q_r + Q_t = Q_E + Q_L + Q_S + Q_A \quad \text{Eq. 7}$$

where, the energy storage that consists of Q_S is the stored energy and Q_A is the net energy transferred to or from the system through advection in the form of sensible or latent heat. However, the advective term can be ignored in central urban areas with high building density, although, it may be important in boundary areas where the urban and the rural environments meet (Santamouris, 2001) (Figure 2.8).

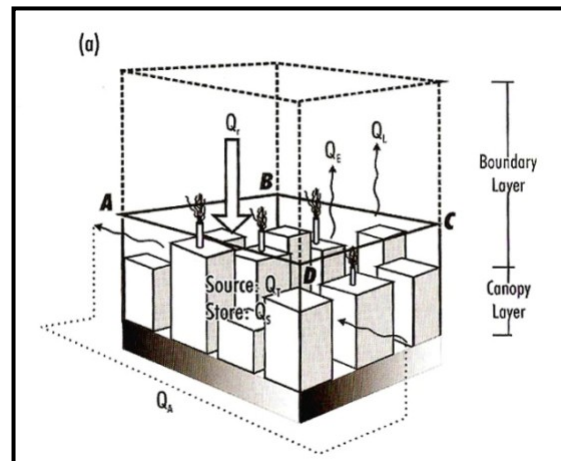

Figure 2.8 Schematic presentation of the energy fluxes in the urban environment (Source: Oke, 1978 and Santamouris, 2001)

According to the above explanation of the dynamic process, a new set of environmental conditions is created, generating a significant differentiation from the surrounding “undisturbed” rural areas (Oke, 1978; Santamouris, 2001; Tran et al. 2006). In addition, as consequence of changes in the heat and energy balance, air temperature in densely built urban areas is higher than the temperature of the surrounding country. This phenomenon is the UHI effect, or UHI described below (Oke, 1978; Landsberg, 1981; Santamouris, 2001; Emmanuel 2005; Tran et al., 2006; Yu and Wong, 2006; Bonacquisti, 2006; Wong et al., 2007; Sailor and Dietch, 2007).

2.2 Urban Heat Island (UHI): Definition

Before we proceed to a thorough understanding of the phenomenon of the heat island, it is valuable to define the term ‘heat island’. According to the Dictionary of Landscape Architecture and Construction (Christensen, 2005), it can be defined as: *the microclimate, area, or patch of warmer air that forms in and over urbanised areas because of paved or impervious surfaces, reflection from upright structures, and buildings gathering heat or generating it and then releasing it.* In another definition in the Dictionary of Environment and Conservation (Park, 2007) it is referred to as: *a dome of raised air temperatures that lies over an urban area and is caused by the heat absorbed by buildings and structures.* This definition is supported by Emmanuel (2005) who describes a heat island as best visualised as a dome of stagnant warm air over the heavily built-up areas of cities. Based on the definitions and previous section explanation, it is clear that the condition of urbanisation and related climatic components are the major components leading to the creation of the UHI phenomenon.

As reported by Roth (2002) and Emmanuel (2005); interest in urban climates study began almost 200 years ago when Luke Howard, in the year 1833, first documented that cities appear to be warmer than surrounding rural areas (Landsberg, 1981). He compared the temperature records of a London city weather station with a rural station in Kew Gardens and found that the city station was warmer. This UHI effect was coined as the phrase ‘UHI’, according to Landsberg (1981), by Gordon Manley in 1958. According to Landsberg (1981), a UHI effect can be observed in every town and city and it can be considered the most obvious climatic indicator of urbanisation (Wong et al., 2007).

The heat island phenomenon may occur during the day or night. However, heat islands are most intense at night, occurring a few hours after sunset, under clear skies in the presence of light winds (Santamouris, 2001; Emmanuel, 2005). In large city areas, the boundary between rural and the urban areas demonstrates a steep temperature curve; there may be several ‘plateaus’ characterized by a weak gradient of increasing temperatures, valleys and finally the peak at the city centre, where the maximum temperature is found (see figure 2.9).

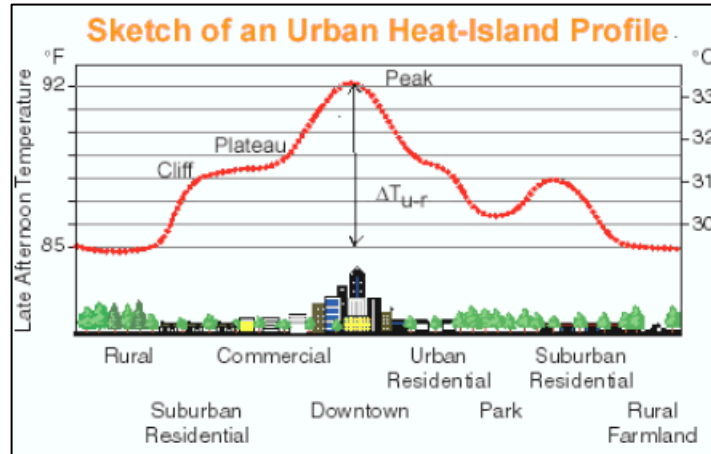

Figure 2.9 Generalized cross-section of typical UHI (Source: Roth, 2002)

However, it should be pointed out that heat island patterns and time ranges are significantly determined by the individual characteristics and local climate conditions unique to each city (Taha, 1997; Santamouris, 2001; Roth, 2002). The intensity of a UHI is generally determined by the thermal balance of the urban region, which can sometimes affect the temperature with a difference of up to 10 degrees (Santamouris, 2001). UHI intensity $\Delta T_{urban-rural}$, or UHI max, defines the condition where there is a maximum difference in the urban peak temperature and the rural background temperature (Oke, 1978; Yague et al., 1991; Karaca et al., 1995; Tso, 1996; Santamouris, 2001; Roth, 2002; Wong et al., 2005; Bonacquisiti et al., 2006; Velazquez-Lozada et al., 2006).

2.3 Types of UHI Intensity

In order to understand more fully the UHI phenomenon, it is important to note that numerous types of UHIs can be identified depending on their location and height within the urban environment. There are two common types of UHIs that have been classified by Oke (1995) and simplified by Roth (2002), namely, Air temperature UHI and Surface Temperature UHI and these can be defined depending on their location and height within the urban atmosphere (Table 2.3).

Table 2.3 Simple classification scheme of UHI types (after Oke, 1995 and Roth, 2002)

UHI type	Location
1) Air Temperature UHI:	
- Urban canopy layer heat island	Found in the air layer beneath roof-level
- Urban boundary layer	Found in the air layer above roof-level; can be affected downwind with the urban plume
2) Surface temperature UHI	Found at the urban horizontal surfaces; such as ground surface, rooftops, vegetation and bare ground. Normally this depends on the definition of a surface {True 3-D (Complete); Bird's-eye 2-D (aircraft, satellite); Ground Road}

2.3.1 Measuring UHI in Air Temperature

Air temperature in the UHI is divided into two different locations based on the understanding of the conception of the urban atmosphere system in the urban energy balance (Oke, 1999) and composed in two distinct layers: the urban canopy layer (UCL) and the urban boundary layer (UBL). The UBL is the overall atmospheric system that extends for many miles above cities, whilst the UCL is the layer of atmosphere where most life occurs: from ground level up to the mean height of the roof (Figure 2.10). Understandably, the majority of the climatic effects are predominantly felt in the UCL (Emmanuel, 2005). Therefore, in general, most of the air temperature UHI studies investigate factors and environments at the UCL level in order to understand the overall phenomenon effecting air temperature differences in the city.

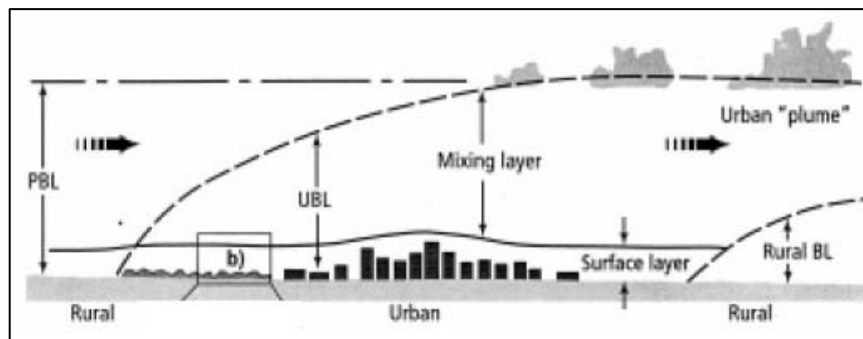

Figure 2.10 The vertical structure of the urban atmosphere over an urban region at the scale of the whole city (Source: Roth, 2002)

Normally, the UHI has air temperatures that are warmer than temperatures in surrounding rural areas. The intensity of UHI air temperature varies throughout the day and night (Wong and Yu, 2005; Gartland, 2008). Generally, the smallest urban-rural air temperature difference can be found in the morning. However, the difference grows during

the day as urban surfaces heat up and consequently warm the air. Thus, the difference is based on the urban surface area heating the air. The heat island intensity is usually largest at night, since the urban surfaces continue to transmit heat after sunset and slow the rate of night-time cooling (Gartland, 2008).

In order to measure the air temperature UHI intensity, ground based measurements, namely, from fixed stations and mobile traverses are the methods that have been commonly used in most of the studies for monitoring air temperature UHI (Sham, 1990/91; Magee et al, 1999; Unger, 2001; Kim and Baik, 2005; Wong and Yu, 2005; Giridharan et al., 2007). Fixed station is the simplest method to use when comparing existing weather data from two or more fixed stations. It has been suggested that the data from fixed stations is commonly used in three different ways: (i) comparing data from a single pair of urban and rural weather stations; (ii) studying data from multiple stations to find regional, two-dimensional impacts and; (iii) investigating a large set of historical data to evaluate heat island trends overtime as a region develops (Gartland, 2008). As most of the ‘urban’ weather stations are located on tops of buildings, and so do not reflect the canopy layer condition, it is important to choose a suitable location for any research weather station in order to compare between urban-rural climates. In rural areas, weather stations are typically positioned at airports and so may not accurately represent historical conditions. The majority of the airports are not sheltered from wind and natural vegetation may have been eliminated in favour of runway space. In addition, airport weather station are often located on towers, therefore, the measurements may not represent ground-level conditions (Gartland, 2008). Thus, the selection of all weather stations’ locations is most important in order to represent urban-rural air temperature conditions.

The second common and most economical method that can be used in monitoring air temperature UHI is through a mobile traverse. This method requires travelling on a predetermined trail throughout the city or region stopping at representative locations to take readings using a single set of weather instrumentation. There are various methods of transport available to cover smaller areas of the study, i.e. walking or cycling between measurement locations (Spronken-Smith and Oke 1998), to those for covering a larger area using public transport or a car (Chandler, 1960; Hutcheon et al, 1967; Yamashita, 1996; Stewart, 2000; Wong and Yu, 2005). Measurement can be undertaken at any time of day or night; however, most of the studies perform traverses at night during calm and clear weather in order to

measure maximum heat island intensities. However, there several drawbacks to using the mobile traverse method to measure heat islands such as the inability to record simultaneous measurement at different locations and the influence of sources of heat along roadways from engines, pavement heat or wind generated by traffic (Gartland, 2008).

2.3.2 Measuring UHI in Surface Temperature

The second type of UHI, is the so-called, surface temperature UHI; which in contrast to air temperature UHI, is greatest during daytime with the highest temperature likely to occur in areas filled with large buildings or paved surface areas, with a minimum at night (Roth, 2002). Surface temperature can be found in differences which peak soon after solar noon (Outcalt, 1972; Pease et al., 1976; Emmanuel, 2005). During this hour, many urban surfaces, such as roofs and pavements, are routinely heated by the sun to temperatures ranging from 27°C to 50°C hotter than the air (Gartland, 2008). Voogt and Oke (2003) claimed that the surface temperature is of key importance to the study of urban climatology. It transforms the air temperature of the lowest layers of the urban atmosphere and it also helps to determine the internal climates of buildings. In addition, it will affect the energy exchanges that influence the overall comfort level of city dwellers (Voogt and Oke, 2003). The parameters that quantify the magnitude of surface temperature are surface albedo, moisture content, and land use or land cover conditions (Xian, 2007).

Therefore, in contrasts to ground-based observations or in situ measurements of air temperature UHI, satellite images from thermal remote sensing offer the ability to assess urban-rural differences and provide an incorporated value for the urban 'skin' temperature at regional or local scales levels (Figure 2.12) (Roth, 2002; Voogt and Oke, 2003; Dousset and Gourmelon, 2003; Xian, 2007; Wong et al., 2007). Remote sensing can be used to find temperatures and other characteristics of surfaces such as roofs, pavement, vegetation and bare ground, by sensing long-wave or thermal infrared radiation to estimate surface temperature (Voogt and Oke, 1997). The advantage of using this technology is its power to visualize temperatures over large areas. However, it depends on definition of the surface. Surface definitions are important to the remote sensing of UHI (sensors see the surface directly) and for comparing remote sensing to other measurements or model outputs (Voogt and Oke, 1997). Figure 2.11 explains four different surface definitions in measuring UHI using remote sensing. Normally, bird's-eye or plan view is used in measuring surface UHI as

viewed by a nadir remote sensor. It shows only a plan view of ground surfaces, vegetation top canopy and roof top surfaces, thus, omitting temperatures of vertical building walls and temperatures under trees. Since satellites are constantly circling the Earth, they do not record continuous information over a daily period, thus, daytime and night-time data is recorded separately (Gartland, 2008). In addition, clear weather is needed in order to capture a clear image.

However, remote sensing technology can help to explore the UHI effect from following the following perspectives: (i) the spatial structure of urban thermal patterns and their relation to urban surface characteristics; (ii) the application of thermal remote sensing to the study of urban surface energy balances; and (iii) the application of thermal remote sensing to the study of the relationship between atmospheric heat islands and surface UHI (Wong and Yu, 2008). Remote sensing instrumentation typically takes measurements at five different energy wavelengths. Thus, these measurements can be used to determine how hot or cold a surface is, and to show what it looks like and how reflective it is (Gartland, 2008).

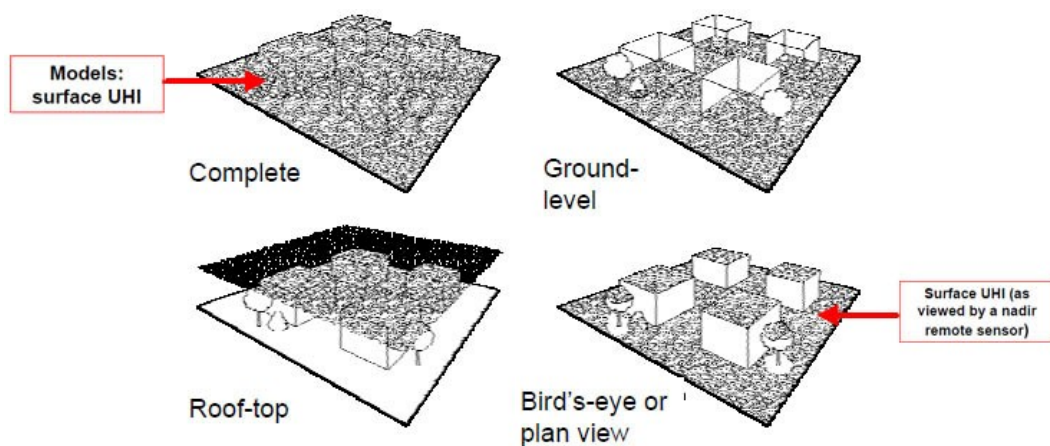

Figure 2.11 Surfaces' definitions in measuring surface UHI (Source: Voogt and Oke, 1997)

Remote sensing technologies has been utilised for studies of UHI extensively during the past two decades (Wong and Yu, 2005). An interesting study by Wong et al. (2007) indicated that the exchange process between urban surfaces and the atmosphere are governed by surface heat fluxes and therefore interactions of this physical process are difficult to monitor with in situ instruments. As a result, the study used satellite images as a tool in order to get the entire view of the environment.

The study used the superimposed and zoomed thermal satellite images at the campus level of NUS (Figure 2.12). Then, this data was analysed to determine the “hot” and “cool” spots in the campus area, with a range from red to represent hot temperatures to blue for cool temperatures. The results clearly show that the locations of red colour distribution (hot spots) in the thermal image are almost always the locations of buildings in the real image and the green colour distribution (cool spots) occur mainly in proximity to large areas of dense greenery. The spatial structure of urban thermal patterns and their relation to urban surface characteristics as revealed in this study, suggest that this method can be considered useful in order to determine hot and cool spots in urban areas.

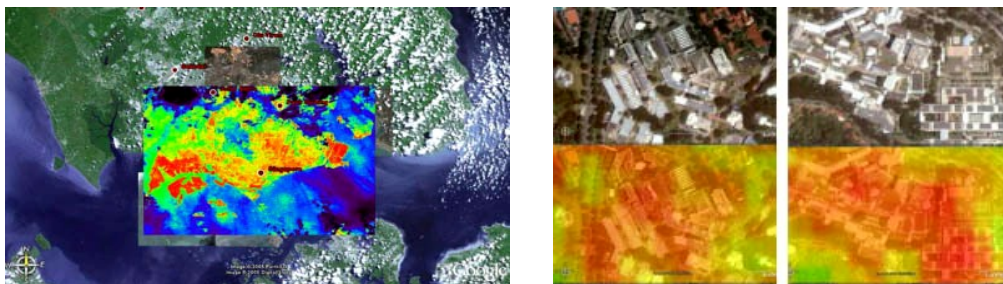

Figure 2.12 Example of satellite images and thermal satellite images superimposed at the city scale (left); Visible (up) and thermal infrared (down) images of NUS campus in Singapore. The yellow and red areas are hot – corresponding with roads and buildings; blue and green areas are cool and indicate water and vegetation (Source: Wong et al., 2007)

2.4 UHI Studies

As mentioned previously in section 2.1, urban climate studies were first of interest almost 200 years ago when Luke Howard (Howard, 1833) was credited to have carried out the first scientific study into inadvertent urban climate modifications (Landsberg, 1981; Roth, 2002; Emmanuel, 2005). He observed and recorded the phenomenon that urban areas are warmer than the surrounding rural area. Since then, a number of observational studies throughout the world have been carried out (Table 2.4). Landsberg (1981) believed that the UHI phenomenon can be found in every town and city as the most obvious climatic manifestation of urbanisation. It can be observed from the table that the UHI effect can be found not only in temperate cities but also in tropical ones. The UHI studies in each climate case is discussed and explained under the next sub heading.

Table 2.4 Air Temperatures UHI max of different cities world wide

<i>Study Area</i>	<i>Reference Study</i>	<i>Approach</i>	<i>Climate Zone</i>	<i>UHI Intensity (°C)</i>
Tokyo, Japan ²	Tran et al. (2006)	Remote sensing	Temperate	+12.0
Bangkok, Thailand ²	Tran et al. (2006)	Remote sensing	Tropical	+8.0
Seoul, Korea ²	Tran et al. (2006)	Remote sensing	Temperate	+8.0
Shanghai, China ²	Tran et al. (2006)	Remote sensing	Temperate	+7.0
Mexico City, Mexico ¹	Jauregui et al. (1997)	Weather Station Data	Tropical	+7.0
Manila, Philippines ²	Tran et al. (2006)	Remote sensing	Tropical	+7.0
8 cities, India ¹	Padmanabhamurty (1990,91)	Weather Station Data	Tropical	+0.6-10
Kuala Lumpur, Malaysia ¹	Elsayed (2006)	Weather Station Data & Site Survey Data	Tropical	+7.5
San Juan, Puerto Rico ¹	Velazquez (2002)	Modelling	Tropical	+8.0 (estimated by 2050)
London, UK	Watkins et al. (2002)	Weather Station Data	Temperate	+8.0
Athens, Greece ¹	Santamouris (2001)	Weather Station Data	Temperate	+10.0
Ho Chi Minh City, Vietnam ²	Tran et al. (2006)	Remote sensing	Tropical	+5.0
Szeged, Hungary ²	Unger et al (2001)	Site Survey Data	Temperate	+2.6
Hong Kong, China	Giridharan et al. (2007)	Site Survey Data	Temperate	+3.4
Lodz, Poland	Klysik and Fortuniak (1999)	Weather Station Data	Temperate	+12.0
Rome ¹	Bonacquisti et al. (2006)	Modelling	Temperate	+4.2
Singapore ¹	Wong and Chen (2005)	Site Survey Data	Tropical	+4.01
New York ²	Gedzelman et al. (2003)	Weather Station Data	Temperate	+5.0
Madrid ¹	Yague (1991)	Weather Station Data	Temperate	+2.23

¹Air-temperature based, ²Surface-temperature based

2.4.1 Non-Tropical UHI Studies

UHI studies in temperate climates have been widely explored by numerous researchers in Europe, America and Mediterranean and Asia Pacific regions. They have investigated the intensity of heat islands during both summer and winter seasons. However, for the purposes of this study, the interest lies more with the summer season when the UHIs max effect on the temperate climate is typically found.

In the case of Europe, various studies have been documented the intensity of heat islands. According to Santamouris (2001); reporting a UHI study in Europe, undertaken in London from June to July 1976, Lyall (1977) noted that, the magnitude of the nocturnal heat island averaged 2.5°C for over two months. The range is not far below the daily limits found by Chandler (3.1°C) in 1960.

This result has been further investigated by other researchers within this region; including Eliasson's (1996) in Gothenburg, Sweden showing a UHI magnitude of 5°C with the night-time nocturnal heat island greater by 0.5°C. Based on limited data in Essen, Germany (Swaid and Hoffman, 1990) the heat island intensity was found between 3 and 4°C

for both day and night. Another study in the small town of Stolberg, Germany found a high excess temperature difference of about 6°C at night, due to the profoundly built-up town centre situated in a narrow valley which obstructs the potential for air flow to break through into the urban area.

In Madrid, Spain a UHI study by Yague et al. (1991) found that the highest UHIs intensity can be found in the summer months. In the month of September the UHI intensity was found to show the highest peak of temperature of 2.23°C, while in April the lowest was 1.72°C. He noted that this is consistent with other studies carried out in the U.S. and Canada (Table 2.5). The lowest value shown is in spring, which might be related to the fact that the season has more turbulent nights than in other seasons.

Table 2.5 Seasonal variation for UHI intensity (record from 1965-1987). Standard deviation shown below in parenthesis (Source: Yague et al., 1991)

Jan	Feb	Mar	Apr	May	Jun	Jul	Aug	Sep	Oct	Nov	Dec
1.90	1.73	1.96	1.72	1.89	2.10	2.22	2.18	2.23	1.95	2.15	2.03
(0.27)	(0.18)	(0.18)	(0.14)	(0.19)	(0.13)	(0.15)	(0.17)	(0.27)	(0.24)	(0.23)	(0.22)

Several studies have been performed in the USA, mostly by NASA and the Lawrence Berkeley Laboratory (LBL). Taha (1997) in his study performed under the Lawrence Berkeley National Institute claimed that the actual impact of urban climates and heat islands depends on local climate characteristics. He listed the increase in the cooling and heating degree days for selected North America urban areas locations from 1941-1970 (Table 2.6).

Table 2.6 Reduction in heating degree-days and increase in cooling degree-days (base 18.3°C) due to urbanisation and heat island effects from 1941-1970 (Source: Taha, 1997)

Location	Heating degree-days			Cooling degree-days		
	Urban	Airport	€%	Urban	Airport	€%
Los Angeles	384	562	-32	368	191	92
Washington DC	1300	1370	-6	440	361	21
St. Louis	1384	1466	-6	510	459	11
New York	1496	1600	-7	333	268	24
Baltimore	1266	1459	-14	464	344	35
Seattle	2493	2881	-13	111	72	54
Detroit	3460	3556	-3	416	366	14
Chicago	3371	3609	-7	463	372	24
Denver	3058	3342	-8	416	350	19

As can be seen in the table, the urban areas have fewer heating degree-days but more cooling degree-days in respect to rural surrounding. Thus, the increase in the cooling degree days has a tremendous impact on the energy consumption of buildings for cooling purposes.

Taha has listed the possible causes of the impact that can be seen, such as surface albedo, evapotranspiration from vegetation and anthropogenic heating from transportation and stationary sources. He discovered that the causes most relevant to heating and UHI problems are due to two indications which are surface albedo and vegetation cover. Higher albedo surface and low vegetation cover tend to increase the heat and cause the air temperature to rise. This explains why the percentage of urban areas cooling degree-days is much higher than in rural areas.

Another study by Streutker (2003), supported by NASA, compared two sets of heat island measurements in Houston, Texas taken 12 years apart using satellites' radiative temperature map data in (i) 82 night-time scenes from the years 1985 and (ii) 125 night-time scenes taken between 1999 and 2001. He determined that these two sets of interval data show a mean UHI growth with a magnitude of 0.8°C , or 35% in the city area. The main reason for this occurrence is that the population of the city grew by 20% per annum. This caused the changes to the heat island signature of the city. Therefore, he noted that Houston's UHI intensity could possibly be monitored in relation to population density in an attempt to control or mitigate UHI.

One of the key studies of interest was conducted in a hot Mediterranean climate by Santamouris et al. (1996), assessing the heat island characteristics and the explicit distribution of the ambient temperature in the city of Athens. Twenty automatic temperature and humidity stations were installed in the major Athens area during spring 1996 (later this was increased to thirty). The measurement points were selected to cover all five major city criteria; including: (i) the boundary conditions around the basin; (ii) densely built up areas with heavy traffic; (iii) low traffic areas; (iv) green areas in the city; and finally (v) medium built-up areas. The study indicated that the central areas of Athens recorded the higher temperatures for both summer and winter periods, particularly during the daytime. In summer the daily heat island intensity for the central area may reach values of up to 10K but in rural areas there are much lower ranges, between 6K and 2K (Figure 2.13). However, urban green areas show 2°C to 3°C lower than the central station, which is between 2°C and 5°C during the night-time. The study leads to an interesting conclusion when compared to the summer period results as it shows that the cooling degree hours in the central area of the city are around 350% greater than in suburban areas. Additionally, in the west Athens area, the study determined that the area was characterized by low vegetation, high building density and a

high anthropogenic emission rate and so presents 40% fewer cooling degree hours than other nearby urban stations.

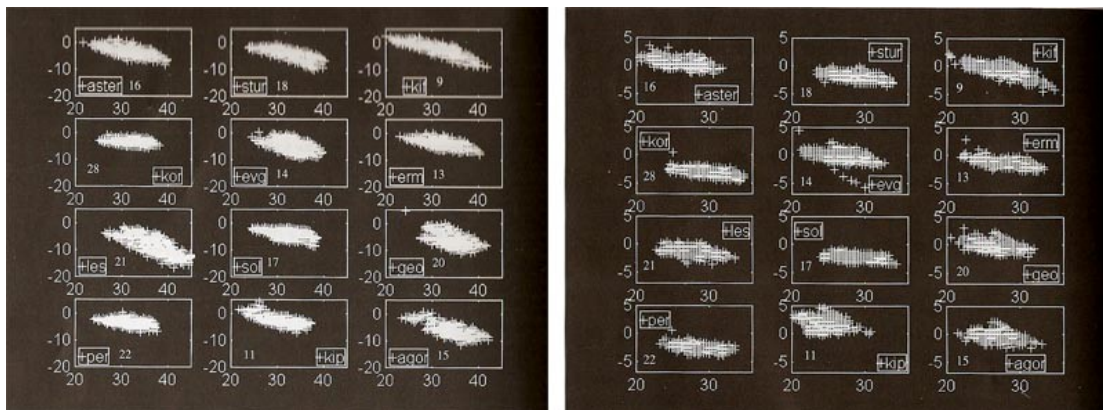

Figure 2.13 Absolute temperature difference between urban stations and the reference station in Athens, 1996 on summer days (left) and during summer nights (right) (Source: Santamouris, 2001)

The UHI max in the very central Athens area is close to 16°C while the mean value is close to 12°C for the major central area of Athens. However, the central Athens park area shows a lower UHI intensity, which is close to 6.1K and the park presents almost 40% fewer cooling degree hours than nearby urban stations.

Another significant study in Asian countries, by Tran et al. (2006), specifically assesses surface UHIs in two different climate regions, temperate and tropical respectively, using Terra/Modis Thermal remote sensing satellite images. Tokyo, Beijing, Pyongyang and Seoul City represent the temperate regions and Bangkok, Manila and Ho Chi Minh City the tropical climate regions. The study indicated that all selected temperate climate cities were experiencing significant surface temperature UHIs in summer 2001, with Tokyo having the most severe UHI in both magnitude (up to 12°C) and extent (up to 8067 km²) and Pyongyang having the lowest with 4°C and 549 km² respectively. In contrast, selected tropical cities experienced intense surface temperature UHIs in the range of 5-8°C in the dry season of 2001-2002. Most of the causes were due to the urban surface properties and land cover, particularly in terms of vegetation cover and built-up density. In example, Bangkok and Ho Chi Minh City showed a relationship between surface properties and UHIs, indicating the importance of vegetation in partitioning of sensible and latent heat fluxes in a humid environment (Figure 2.14).

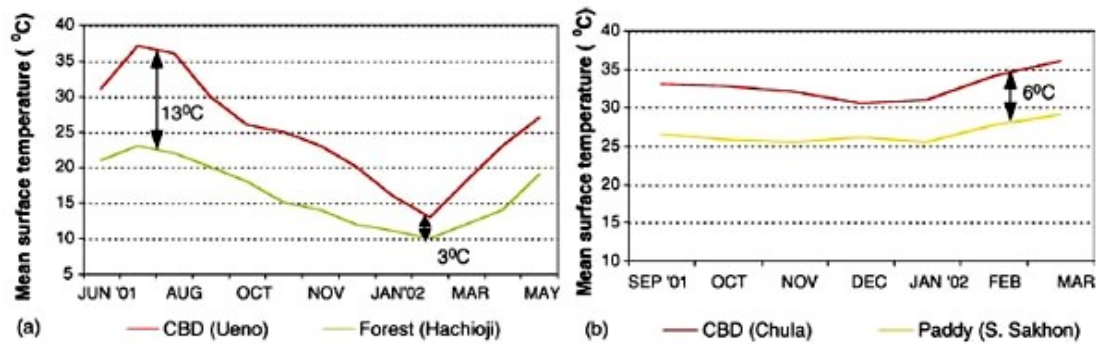

Figure 2.14 Temporal variations of the day time surface UHIs in Tokyo (temperate) particularly found to be higher in summer seasons (left) and Bangkok (tropical) found to be higher in the dry season (Source: Tran, 2006)

2.4.2 Tropical UHI Studies

Nieuwolt's (1966) study conducted in the urban south of Singapore was one of the earliest tropical urban microclimatic studies (Tso, 1996; Wong and Yu, 2005; Emmanuel, 2005). By recording the city air temperatures and humidity at nine points in the city centre and comparing these with the single meteorological station located at Paya Lebar airport (representing a “countryside” setting), they found out that the city was significantly warmer and drier than the airport; with the differences of up to 3.5°C (Figure 2.15). In particular, the weather conditions showing the highest temperatures and lowest humidity were found in narrow streets in the urban area. The air temperature differences in both areas are believed to be due to the higher absorption of solar radiation and lack of evapotranspiration in urban areas.

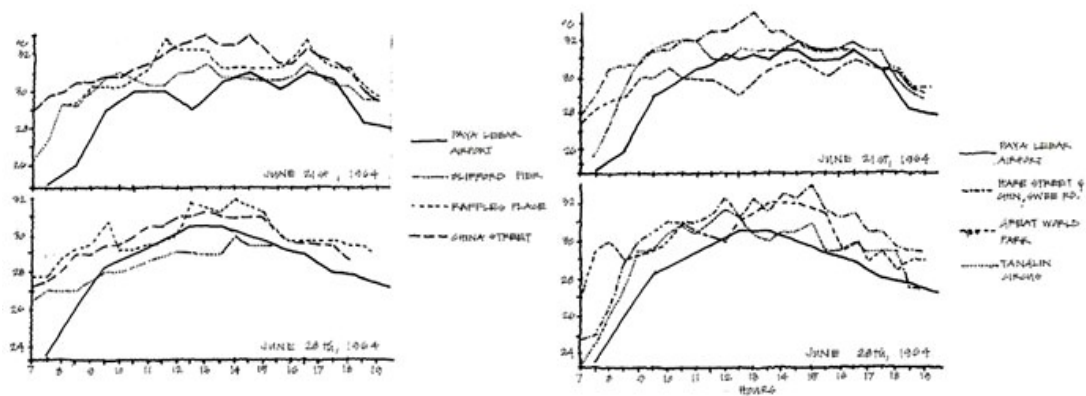

Figure 2.15 The temperature difference in urban-rural areas in Singapore (Source: Emmanuel, 2005 adapted from Nieuwolt, 1966)

Another study, by Sani (1990/91), in agreement with Nieuwolt's findings was conducted in Kuala Lumpur Malaysia. However, he found out that the city-country temperature difference (CCTD) was related to cloud cover. The results indicated that on clear days the CCTD was 4.4 to 5.0°C nevertheless on cloudy days it was 2.0 to 2.2°C respectively (Figure 2.16). This was characterised as due to the additional dark-coloured surfaces in the city and the trapped hot air (lack vertical air mixing) at 1.5m level.

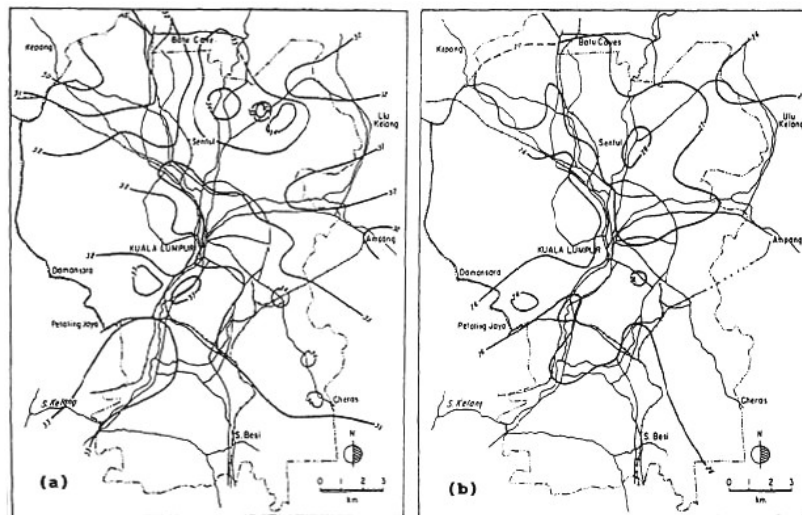

Figure 2.16 The typical temperature distribution in the Kuala Lumpur area during (a) 14:00-15:00h; and (b) 21:00-22:00 (Source: Sani, 1986)

The work by Adebayo (1987, 1990, 1990/91, 1990) (adapted from Emmanuel (2005) in Ibadan, Nigeria) involved UHI studies in tropical Africa (Figure 2.17) where he indicated that the temperature differences in urban-rural areas were caused by following factors: (a) reduction in albedo values where more heat exchanges from the earth's surface, (b) trapped net radiation as a result of urban canyons, and (c) the existence of pollution coverage.

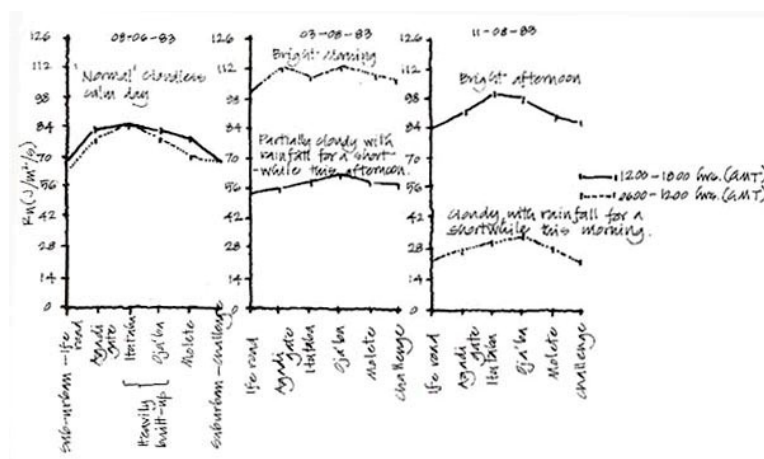

Figure 2.17 Urban radiation balance in the tropics: Ibadan, Nigeria (Source: Adebayo, 1990, adapted from Emmanuel, 2005)

Therefore, most of the recent and existing studies (Table 2.7) propose that there are extensive microclimatic modifications due to urbanisation in the region, even though the urban climate studies in tropical cities have not been widely studied (Emmanuel, 2005).

Table 2.7 Recent Tropical UHI studies

<i>Author/s</i>	<i>City</i>	<i>Parameters</i>	<i>Major findings</i>
Tso (1995)	Singapore and Kuala Lumpur	Air temperature	The city-rural temperature differences were due to the greater absorption of solar radiation and to reduced evapotranspiration in the city. The peak values of maximum temperature occur at 13:00 to 14:00 h. Besides, the location and urbanisation pattern of the cities is expected to give rise to a difference in air environment.
Jauregui et al. (1997)	Mexico City	Air temperature	The warming trend is mainly the result of the growing heat island effect usually observed on clear nights during the dry season. It is expected that estimates of heat island intensity in a tropical city are more dependent on the land use characteristics of the rural/suburban control.
Nichol (1996a,1996b)	Singapore	Remotely sensed surface temperature	Horizontal surface temperatures are more representative of urban air temperatures in the tropics due to high solar azimuth. Tropical cities do not have a single UHI; rather a collection of small UHIs separated by cooler areas (vegetation)
Jauregui and Romales (1996)	Mexico City	Convective precipitation	Wet season rainfall appears to have increased over the city, as well as the frequency of intense rainfall (>20mm/hr). The latter is related to daytime UHI.
Jauregui et al. (1997)	Mexico City	Air temperature	It is noted that a nocturnal heat island was more frequent (75%) than a day-time heat island (25%). Daytime heat islands may have been caused by differences in evaporative cooling in the wet season.
Oke et al. (1999)	Mexico City	Net radiation, sensible and latent heat fluxes	The heat storage in buildings is so large that convective heating is rigorously concealed in the city with massive stone walled buildings during daytime. Thus, the heat release at night is equal to or larger than the net radiation.
Emmanuel (2003)	Colombo	Air temperature and relative humidity	Mostly in suburban area, thermal comfort patterns (THI) are significantly correlated to hard land cover changes.
Wong and Yu (2005)	Singapore	Air temperature and relative humidity	The air temperatures within different land uses are quite relevant to the density of greenery. On the other hand, places with fewer plants always have a higher temperature. Thus, large green areas absolutely have positive effect on mitigating UHI effect.
Velazquez et al. (2006)	Puerto Rico	Air temperature and numerical UHI simulation	The urban-rural temperature difference is due to urban sprawl. In addition, the thermal inertia is the most important factor that affects the local urban climate.
Tran et al. (2006)	Bangkok, Manila and Ho Chi Minh City	Satellite data and remotely sensed surface temperature	The tropical cities experiencing intense surface UHIs in the dry season and it was associated with heavily built-up areas in city centre. The night time UHI magnitude was lower than that of day time due to moisture availability and surface cooling rates.

Therefore, from all the studies listed, it is possible to say that UHI anatomy in non-tropical (temperate climate) tends to have close similarity to in tropical ones (Oke, 1982). The similarity can be recognized by several features that characterise the microclimate (Emmanuel, 2005). There are four urban microclimate features characteristic of the city climate in all places (e.g. tropical and non-tropical region):

- (i) It is noted that the day and night-time UHIs are two different cases. The downtown-centered UHI exists at night while the day-time records a mixture of cool spots and heat islands. The magnitude of the temperature differences declines as the background climate becomes hotter.
- (ii) The second characteristic relates to nocturnal UHI, where the downtown-centred UHI at night is highly correlated with urban tree cover characteristics. The importance of tree cover characteristics to city-wide night-time UHIs is confirmed by numerous urban climatologists, including Niewolt (1966) in Singapore, Sham (1973) in Kuala Lumpur, Malaysia and Kawashima (1994) in Tokyo.
- (iii) The changes to lower albedo materials in urban surfaces are strongly correlated with higher temperature intensity in the day time and greater at night-time. Heat storage from wall and ground surfaces tends to be dispersed at night and create a higher nocturnal UHI in urban areas.
- (iv) The fourth feature of UHI relates to the utility of extensive tree cover in street canyons where complete vegetation cover with extensive canopy cover showed minimal difference from cooling by building shade in respect to thermal comfort comparison (Nichol, 1996a). Therefore, broad and larger numbers of canopy cover are required in order to give the full advantage of thermal comfort in urban areas.

However, both regions have several differences between those climatic parameters affected by numerous causes relating to the UHI max and these can be recognized by the effect on each climatic variable such as temperature, humidity, precipitation, wind and solar radiation (Table 2.8).

Table 2.8 Comparison on the impact of UHI based on urban climatic parameters for both regions

<i>Climatic Parameter</i>	<i>Typical Effect</i>	<i>Possible Causes from urban areas in Both Regions</i>
Temperature	<p>-Rise in daily minimum temperature: some change in maximum temperature</p> <p>- Max UHI : <u>In the temperate climate</u> - During summer season <u>In the tropics</u> - During dry and hot season</p>	<p>Replacement of natural soil or vegetation by materials, such as concrete and asphalt, used in cities reduce the potential to decrease ambient temperature through evaporation and plant transpiration.</p> <p>The city puts more energy into sensible heat and less into latent heat (lack of vegetative cover).</p> <p>Lack of shade cover.</p>
Humidity	<p>Reduction in daytime humidity, but increase in night-time values.</p> <p>- Max UHI : <u>In the temperate climate</u> - During summer season – low humidity level During winter season – high/medium humidity level <u>In the tropics</u> - During dry season – critical/low humidity During wet season – medium humidity level</p>	<p>This pattern results from smaller vapour input, due to the result of a reduction in vegetation and hence smaller transpiration rates in the city compared to the greater rural evapotranspiration during the day.</p> <p>At night, a more humid environment is maintained in the urban area, due to weak evaporation when the moisture content of the lower layers of rural air are depleted by dewfall.</p> <p>Lack of water bodies and water availability.</p> <p>Lots of water-proof surface materials (Lack of evaporation).</p>
Precipitation	<p>In <u>temperate</u> climate - Larger increases in summer (up to 21 percent) and smaller increases in winter (5-8 percent) In the <u>tropics</u> – the increase is attributed more to air pollution than heat emission.</p>	<p>Released by the combustion of fuels from either mobile or stationary sources, as well as by animal metabolism.</p> <p>Emission from the aerosols and greenhouse gases affects the radiative transfer and act as condensation nuclei, thus, waste heat and water vapour from combustion is added to the urban atmosphere.</p>
Wind	<p>Increases in the number of calm periods observed. Up to 20 percent reduction in wind speeds are known. The effect is greater upon weaker winds (Emmanuel, 2005).</p>	<p>Rapid development of obstacle elements such as buildings that act as bluff bodies due to their impermeability, inflexibility, and sharp edges characters that influence the air movement and velocity.</p> <p>Changes in urban topography.</p>
Solar radiation	<p>Though incoming radiation values are not changed, the apparent values are high due to the containment of reflected radiation by the heat dome (Emmanuel, 2005).</p> <p><u>In the temperate climate</u> - During summer season due to long hour exposure in daytime. <u>In the tropics</u> - Throughout the year.</p>	<p>Introduction of new surface materials which have a larger range of albedo and emissivity values compared with vegetation.</p> <p>Canyon surfaces and radiation will decrease the effective albedo of the system because of the multiple reflection of short-wave radiation by the canyon surfaces.</p> <p>The decrease in long-wave radiation loss from within the street canyon due the complex exchange between buildings and the screening of the skyline.</p>

2.5 Climate and UHI Studies in Malaysia

2.5.1 Climate Background

The characteristic features of the climate of Malaysia are uniform temperature with high humidity, copious rainfall and light winds. Malaysia is situated in the south east part of Asia on the equatorial lines at 2° 30' North latitude and 112° 30' East longitude; it is extremely rare to have a full day with completely clear sky even during periods of severe drought. In contrast, it is also rare to have a stretch of a few days with completely no sunshine except during the northeast monsoon seasons (MMD, 2010).

2.5.1.1 Temperature and Relative Humidity Distribution and Variation in Malaysia

Malaysia has uniform temperature throughout the year with an annual variation of less than 2°C; except for the east coast area due to the northeast monsoon influence, where the variation is still less than 3°C. The daily range of temperature is large, from 5°C to 10°C at coastal stations and from 8°C to 12°C at inland stations. Even though the daytimes are frequently hot, the nights are reasonably cool everywhere with the average usually being between 21°C and 24°C. February-May are the months with the highest average temperature due to the hot and dry seasons in most places and December-January are the months with the lowest average monthly temperature due to the wet seasons. As mentioned earlier, Malaysia has high humidity. The mean monthly relative humidity is between 70 and 90%, varying from place to place and from month to month. In Peninsular Malaysia, the minimum range of mean relative humidity varies from a low of 80% in February to a high of only 88% in November.

It is observed that in Peninsular Malaysia, the minimum relative humidity is normally found in the months of January and February, due to the hot and dry season occurrence during these months; except for the east coast states of Kelantan and Terengganu which have the minimum in March. The maximum is however generally found in the month of November. As in the case of temperature, the diurnal variation of relative humidity is much greater when compared to the annual variation. The mean daily minimum can be as low as 42% during the dry months (January and February) and reaches as high as 70% during the wet months (November and December). The mean daily maximum, however, does not vary significantly from place to place and is always 94%. It may reach as high as 100%. Based on

the facts, maximum UHI in Malaysia may occur during the dry and hot season with higher monthly air temperature and lower humidity. These conditions can be found during the months of February to May (MMD, 2010).

In this respect, however, air temperature variation studies have become interested in describing details more about Malaysia's climate. Sham's (1984) study examined annual mean minimum temperatures for Subang Airport and the Petaling Jaya city area for the period 1969 to 1983 and found an overall increase of temperatures of about 0.9°C over that period of time. A subsequent study by Yassen (2000), assessing mean maximum, mean and mean minimum for both locations from 1983-1997 revealed that overall average temperatures changes for mean maximum, mean and mean minimum were small for Subang Airport, whilst the values were higher in Petaling Jaya. In general, it is noted that the city area in Malaysia shows a significant temperature variation from rural areas from time to time.

Another study by Ahmad (2003), studied the impact of urbanisation on urban climate trends in Malaysia for the period between 1970 and 2000. The study used data from 55 climate stations located in urban areas with population sizes ranging from about 2,000 to 1.5 million and found that the annual air temperatures vary with the changing size of urban areas. As urbanisation was measured by an increase in population over time, the study found the annual air temperature for the 30 year period was significantly correlated to the changes of population in urban areas with slope (*b*) coefficients from as low as 0.01 to as high as 0.12 . Thus; urbanisation taking place over those 30 years will have, to some extent, played a significant role in changing the urban air temperature patterns. It is believed that the trends of urban air temperature patterns in Malaysia's new and old urban areas may be worse in the future due to the population increase and changes to the existing urban environment.

2.5.1.2 Wind Flow Distribution in Malaysia

Although the wind over the country is generally light and variable, there is a time where there are some uniform periodic changes in wind flow patterns based on monsoon seasonal changes. From May or early June until September, the prevailing wind flow is generally south-westerly and light, below 7.5 m/s due to the southwest monsoon. During the northeast monsoon season, steady easterly and north-easterly winds of 5-10 m/s can be found

from early November, ending in March; but the wind movement is still weak and sometimes can be static. However, during the two inter-monsoon periods, weak or static air movement, together with high and relative humidity can be found and this condition can cause thermal discomfort (MMD, 2010).

2.5.1.3 Solar Radiation and Sunshine Distribution in Malaysia

In general, solar radiation received in the tropics is very high. Being a maritime country close to the equator, Malaysia naturally has abundant sunshine and thus solar radiation. However, it is extremely rare to have a full day with completely clear sky even in periods of severe drought. The cloud cover cuts off a substantial amount of sunshine and thus solar radiation. On average, Malaysia receives about 6 hours of sunshine per day (MMD, 2010). Although the region (between 15° to 35° latitude north and south) where the greatest amount of solar radiation is received is partially beyond the tropical climate, the equatorial region, between 15° north and 15° latitude south in which Malaysia is located still receives the second highest amount of radiation. In that case, the amount of diffused radiation is very high due to high humidity and the cloud cover (Wong and Yu, 2009).

According to Azhari et al (2008), Malaysia receives about 4.96 kWh/m² of average solar radiation in a year. The maximum solar radiation received is 5.56 kWh/m²; mostly occurring in the Northern region of the Peninsular Malaysia and the Southern region of East Malaysia (figure 2.18). A study by Kamaruzzamn and Mohd Yusof (1992) indicated almost the same results, but showed a slight increase in the minimum value from 3.375 kWh/m² in 1992 to 4.21 kWh/m² in 2006.

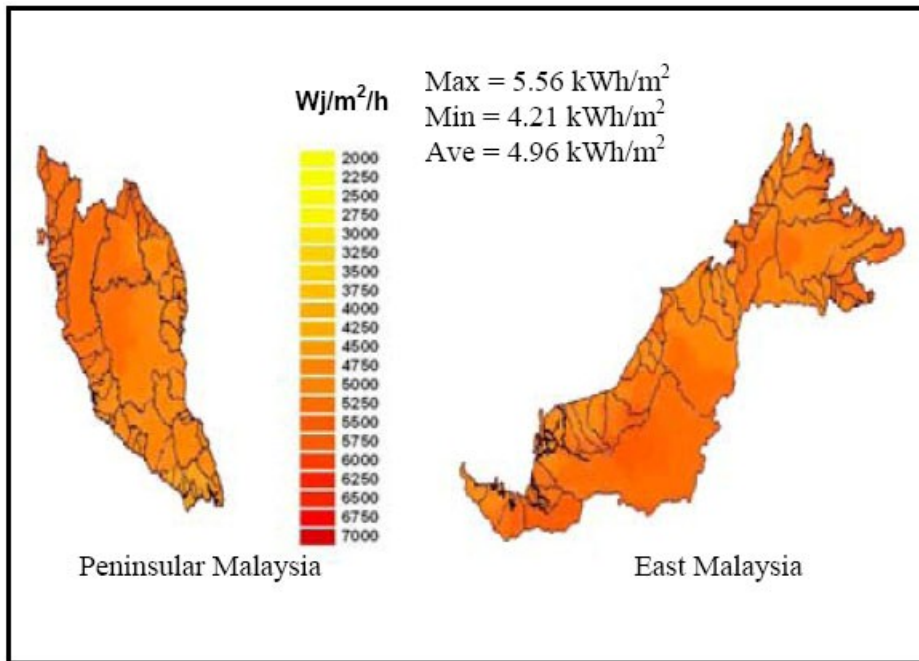

Figure 2.18 Annual average daily solar radiation in Malaysia (Source: Azhari et al., 2008)

Based on monthly average solar radiation the highest average solar can be found in the month of February, at 6.23 kWh/m², in almost all the regions in Peninsular Malaysia and East Malaysia. However, in December, the lowest average solar radiation can be found throughout the west and east coast of Peninsular Malaysia and some parts of East Malaysia, with 0.61 kWh/m² (Figure 2.19 and 2.20).

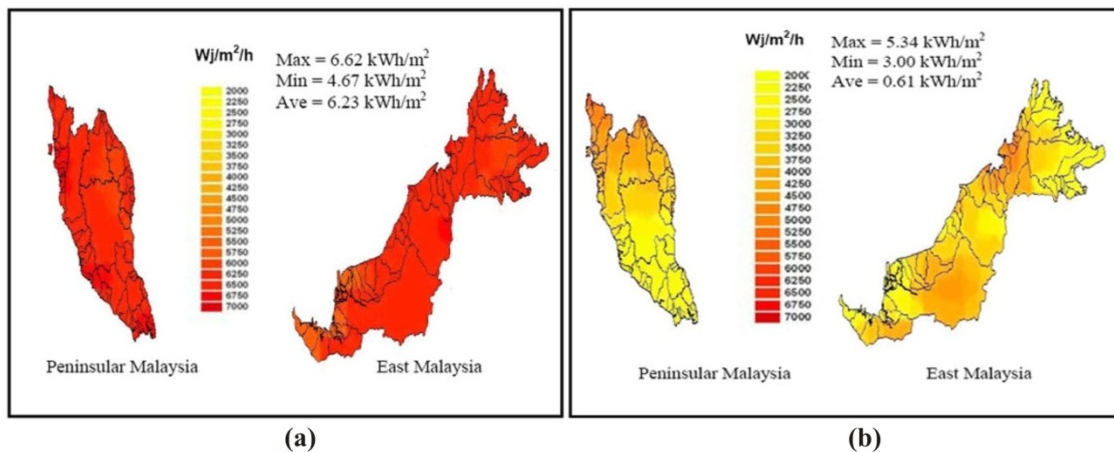

Figure 2.19 Comparing monthly average daily solar radiation in Malaysia in the month of; (a) February and (b) December (Source: Azhari et al., 2008)

The maximum average daily solar radiation is as high as 7.0 kWh/m² in the months of February, March, May, August and November (Figure 2.20). Whereas in the month of April,

July, September and December, the maximum monthly average solar radiation is lower than 6.0 kWh/m² (Azhari et al, 2008).

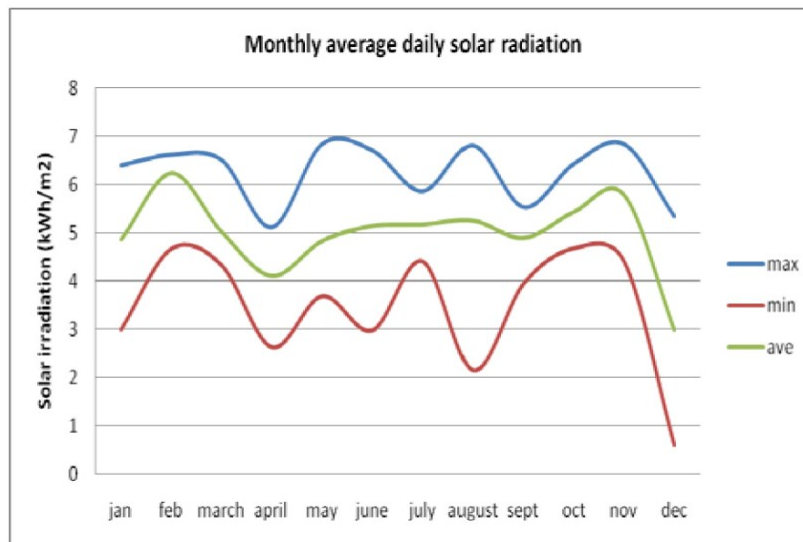

Figure 2.20 Maximum, minimum and average value of the monthly average daily solar radiation for Malaysia (Source: Azhari et al., 2008)

Based on the above facts and figures, it can be seen that Malaysia received a very high solar radiation throughout the whole year. In fact, the highest average solar radiation was found in the month of February and this condition will lead to excessive solar radiation in urban areas. This condition can become worse when there is high air temperature with low relative humidity and low wind speed at this time. As one of the important energy supplies responsible for changing the climate, higher solar radiation with hot and dry weather can greatly promote maximum heat island effect occurrence in urban areas throughout every region in the country.

2.5.2 UHI in Malaysia

The first study on urban climate in Malaysia was carried out by Sham (1972, 1973) and then followed by Jahi (1974). In Sham's (1972) earlier research, he used temperature traverse methods to study the urban microclimate in Kuala Lumpur and found that temperatures were normally higher in the central district than in rural areas around the city and that heat island intensity was normally greatest during calm and clear nights as compared to the intensity during the day. In another study using the same methods, Jahi (1974) found the existence of UHI intensity in Kuala Lumpur typically ranged between 2°C to 3°C at mid-

day. In a much later study by Sham (1973) it was noted that the maximum heat island intensity for Kuala Lumpur and Petaling Jaya, twin cities, was between 6°C and 7°C. Since then, other studies of UHI intensity have been carried out in other urban centres in Malaysia (Table 2.9).

Table 2.9 UHI studies in several urban centres in Malaysia

<i>Authors</i>	<i>Location of Urban Areas</i>	<i>UHI Intensity</i>
Lim (1980)	Georgetown, Penang	4°C
Zainab (1980)	Johor Bahru, Johor	3°C
Sham (1983)	Kota Kinabalu, Sabah	3°C
Sham (1984)	Kuala Lumpur-Petaling Jaya	6-7°C
Sham (1986)	Several urban centres in the Klang Valley	2-5°C
Shaharuddin (1992)	Kuala Lumpur	3-5°C
Sin & Chan (2004)	Several urban centres in Penang	2-5°C
Elsayed (2006)	Kuala Lumpur	7.5°C

Shaharuddin (1992) studied some effects of urban parks on air temperature variations in Kuala Lumpur. He employed the technique of mobile traverse across the area during clear and cloudy skies. In the study he found that the maximum UHI intensities of from 3° to 5°C were mostly established under partly cloudy skies or clear skies. Further, the lowest UHI intensity of about 1°C was mostly associated with rain prior to data collection. Another study by Sin & Chan (2004) used a sling psychrometer to observe temperatures at 65 stations on Penang Island three times a day; at 0900-1000 hours, 1400-1500 hours and 2100-2200 hours. They found that most of the major urban areas; such as the city of Georgetown, Air Itam, Bandar Bayan Baru and Bayan Lepas, experienced the UHI both during the day and at night time and that UHI intensity varied from 2° to 6°C depending on the size of urban areas.

One of the most significant studies by Elsayed (2006); identifying the relationship between the level of urbanisation and the intensity of the UHI of Kuala Lumpur, found that the level of urbanisation is directly proportional to the intensity of the UHI of Kuala Lumpur City. By using a combination of weather station networks and traverses survey method, he found that the intensity of the UHI in Kuala Lumpur City has increased to 1.5°C since 1985. The study also indicated that a temperature variation can be seen clearly from weekdays to weekends due to the impact of traffic etc. during weekdays. On the other hand, it is difficult to relate relative humidity with working or non working hours, therefore, the study indicates that the relative humidity is more related to green or non green areas, as well as to location and human activities in the areas. The study concludes that intensity of UHI in Kuala Lumpur

City is proportional to land use, population density and numbers of vehicles.

Based on previous studies, the intention of UHI studies in Malaysia are more focused on air temperature UHI in the older and larger cities around the country. However, none of the studies are focused on new city developments that have potential for increasing the number of UHI occurrences in Malaysia. Therefore, new city areas such as Putrajaya need to be studied via investigation of the UHI effect which causes and relates to this phenomenon. A surface temperature UHI study that relates to urban thermal patterns and their relation to urban surface characteristics is needed in order to understand the relationship in both cases. Finally, due to the lack of studies regarding mitigating the UHI effect in Malaysia, either from theories or modelling point of views, it is important for this study to evaluate different mitigation measures in order to minimize the impact of UHI based on the local tropical climate such as Malaysia.

2.6 Effect of UHI

Before we proceed to possible applications for mitigating the UHI effect, it is important to understand the effects of UHI on humans and the surrounding environment. These effects can be classified into five major consequences, namely; human thermal comfort, human health, pollution, architecture and energy usage, meteorological and climatic effects.

2.6.1 Human Thermal Comfort

Thermal comfort can be defined as the condition in the mind that expresses satisfaction with the thermal environment (Wong and Yu, 2009). In order to acquire such a sensation of comfort, human body temperature has to be maintained at a constant level internally (about 98.6 °F/ 37°C). The constant temperature is achieved by continuous heat exchange between the human body and its ambient environment (Wong and Yu, 2009). Due to the UHI effect increasing the surrounding air temperature during the day and at night time, urban dwellers may experience extreme thermal discomfort compared to those living in a rural environment. It can be experienced through outdoors and can influence the indoor environment as well. This is due to excessive heat from the high albedo of ground surfaces, building façade materials and lack of vegetation that tremendously increase the surrounding

air temperature. Stark and Miller (1977) conducted a study to ascertain summer-time thermal comfort in urban areas. This study found little evidence for thermal discomfort due to urban variations in air temperature and wind speed. Significant differences in comfort, however, were found to be related to surface characteristics. Urban sites with substantial views to the sky and/or green surfaces had the lowest thermal stress. In contrast, the view with manmade surfaces experienced the highest thermal load.

In tropical regions, it can be seen that radiant temperature is critical to human comfort (Lewis et al, 1971 and Plumley, 1977). The primary human discomfort in the tropics is closely related to the radiation regime (Emmanuel, 2005). Due to the high level of solar radiation throughout the year, urban dwellers will experience extreme discomfort and this will become worse during hot and dry seasons where a UHI maximum can be found in extreme conditions. It can be seen that in the urban environment the radiant temperature varies according to shading, urban canyon geometry, vegetation availability and the seasons. The variation is largely due to the differences in the amount of solar radiation received by the person and partly due to the amount of terrestrial radiation received from the ground surface. Therefore, influence and lack of these factors will generate a UHI effect and this appears to cause greatest variation in human thermal comfort in the tropics.

2.6.2 Human Health

In addition to the human discomfort experienced as a result of the excessive heat from UHI, this effect can potentially increase the magnitude and duration of heat waves within cities through increased temperatures. This influences the health and welfare of urban residents. Changnon et al. (1996) has reported that in the United States alone, an average of 1,000 people die each year due to extreme heat. In a study by Buechly et al. (1972) it was found that the mortality rate during a heat wave increases exponentially with the maximum temperature, an effect that is exacerbated by UHI. Besides, the night time experience can be harmful during a heat wave, as it deprives urban dwellers of the cooler relief found in rural areas during this time.

In the summer of 2003, much of Europe experienced a persistent heat wave. In France, it lasted two weeks and during that time the maximum daily air temperature in Paris (the most severely affected area) was over 35°C for ten consecutive days (Dhainaut et al.,

2004). Throughout the month of August, mortality increased by 60% on that expected, giving a total of 14,800 excess deaths. At the same time, in England, 2,100 excess deaths (11%) were attributed to the heat wave (Johnson et al., 2005). However in the tropics, urban dwellers tend to be acclimated to hot weather conditions and are therefore less vulnerable to heat related deaths. However, higher environmental temperatures increase chemical reactivity of airborne pollutants (NO_x, PAN, etc.) and this leads to a rise in the concentration of respiratory or eye irritants. This will also affect vulnerable individuals, e.g. asthmatics, in a more serious way than healthy individuals, and may be life threatening (Watkins et al., 2007).

2.6.3 Pollution

Air and water pollution can be found in every city. However, it can become worse with the presence of UHI, which increases urban temperature. Elevated temperature can directly increase the rate of ground-level ozone formation. It is believed that ground-level ozone is formed when nitrogen oxides (NO_x) and volatile organic compounds (VOCs) react in the presence of sunlight and hot weather. Normally, the NO_x arise mainly from the combustion of fossil fuels in urban areas (Emmanuel, 2005). In fact more ground-level ozone will form as the environment becomes sunnier and hotter (EPA, 2010). In the tropics, this pollution is one of the major problems, due to the ultraviolet sunlight and moisture that cause this photochemical reaction (NO_x and VOC) (Wong and Yu, 2009).

Another effect is accumulation of smog. It is believed that in the tropics atmosphere pollution can be aggravated by the accumulation of smog related to the combination of the higher temperature and the presence of air pollutants (Wong and Yu, 2009). Due to weak wind at the macro levels in tropical cities, pollution dispersal is difficult. A large scale survey of air quality in 20 of the world's megacities found that particulates (PM₁₀) were the most serious urban air-quality issue. It has also been found that the level of suspended particulate (SPM) often exceeded the World Health Organization (WHO) guidelines by a factor of two and the concentration level of SPM often exceeded the guidelines by a factor of four (Emmanuel, 2005). Besides, the discharge of storm water in tropical cities, due to high temperature and the pollutants carried, can increase biological oxygen demand, which is a threat to aquatic life (Wong and Yu, 2009).

2.6.4 Building and Energy Usage

Collectively, dark surfaces and reduced vegetation warm the air over urban areas, leading to the creation of UHI; these factors are believed to affect the outdoor climate and building energy use. At the building scale, dark roofs and facades heat up more and, thus, raise the summertime cooling demands of buildings (Akbari et al., 2001). As well as having a direct impact on comfort, the urban environment alters the need for energy to modify indoor conditions (Watkins et al, 2007). However, patterns of energy use differ among nations. Energy consumption in the developing world has grown tremendously over the past two decades (Emmanuel, 2005). The World Bank reported that the developing world, which accounted for 20 percent of the total global consumption in 1970, increased its share to 33 percent in 1988. This trend is expected to grow for at least the first three decades of the present century (Imran and Barnes, 1990). Even though many factors are cited as causes for the increase in consumption, it is generally agreed that urbanisation, with the presence of UHIs in the region is the primary cause; particularly so in areas where increasing income has resulted in greater demand for transportation and home appliances – especially space-conditioning devices (de Dear and Fountain, 1994).

In this respect, it is believed that in the tropical environment, air conditioning systems are the principal consumer of energy, due to the higher outdoor temperature (Wong and Yu, 2009). Normally, for a commercial building in the tropics, the air conditioning system alone would account for more than 50 percent of the total energy consumption of a building (Figure 2.21).

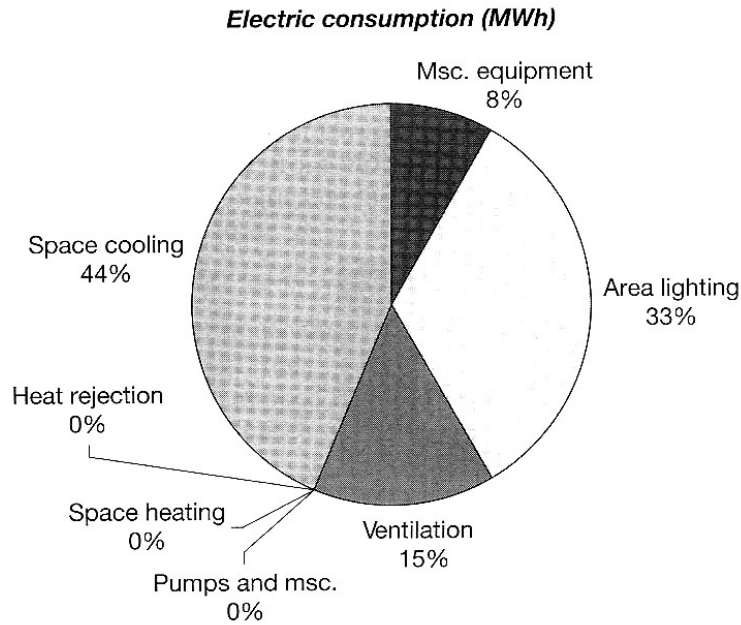

Figure 2.21 Annual energy consumption by enduses in the tropics (Source: Wong and Yu, 2009)

As reported by Wong and Yu (2009), the use of air conditioning is becoming pervasive as the society becomes more affluent, and this has resulted in a drastic increase in the demand for electricity consumption. Another study by Akbari et al. (2001) found that peak urban electric demand rose by 2 to 4 percent for each 1°C rise in daily maximum temperature above a threshold of 15 to 20°C. Thus, the additional air-conditioning used as a result of this urban air temperature increase, was responsible for 5 to 10 percent of urban peak electric demand, at a direct cost of several billion dollars annually. It is believed in the tropics, the annual cost will be higher than in temperate countries for climate based reasons. This has been reported in Singapore, where the electricity consumption increased from 25,858 GWh in 1998 to 41,017 GWh in 2007. This represents an annual increase of 5.3 percent (Wong and Yu, 2009). Thus, it suffices to say that building energy use is one of major problems resulting from the UHI effect in the tropical environment.

2.6.5 Meteorological and Climatologically Effect

In local meteorology, apart from the effect on air temperature, UHIs can produce secondary effects due to alteration of local wind patterns and humidity, the development of cloud and fog, and the rates of precipitation. It is believed that the excessive heat provided by the UHI leads to greater upward motion promoting additional showers and thunderstorms. In the tropics, excessive shower and severe thunderstorm as a result of the UHI effect have

become major problems. As reported in Embi and Dom (2004); the increasing frequencies of extreme event rainfalls and total annual rainfalls are due to the microclimate changes of weather in urban areas. The numbers of times the long term mean value for 3 hour rainstorms has exceeded the 8.3 mean value rose 9% from 1971 to 2002. The result also shows that there is an increasing trend for flash floods, especially in Kuala Lumpur due to the climate changes in urban areas.

Another major effect of UHI on climatic conditions is the increase in tornadoes. Most of this effect can be found in United State of America and is currently a serious problem. A study by Niyogi (2009) indicated a connection between the intensity of the 2008 urban Atlanta tornado and the heat island effect; suggesting that hot, dry urban conditions may have led to a larger discrepancy with the surrounding atmospheric conditions, enhancing stability and thus intensifying the storm as it approached the city. It was also reported that beyond the 2008 Atlanta tornado, violent tornadoes have recently also impacted other large urban centers in USA and caused tremendous damage and death (Michaels, 2009).

Based on the above discussion, it should be noted that UHI phenomenon can cause a negative impact on human thermal comfort, human health, pollution, building energy use and the world's climate. These five major effects can be worsened if mitigating strategies are not applied to minimise the impacts. On the other hand, suffice to say here that urban climate mitigation is crucial to the improvement of these five major consequences and therefore must be the linchpin of urban physical environment improvement programs. This is further explained in the next section in order to clarify the mitigation strategies and program measures. However, it is relevant to this study's area of interest to investigate the impact of mitigation strategies on outdoor human thermal comfort and building energy use; as these factors are believed to be of prime significance from the architecture and urban planning standpoint. Therefore, both these issues are further discussed in Chapter 3 to better understand their relationship with UHI mitigation strategies.

2.7 UHI and Urban Microclimate Mitigation Strategies

As a result of the findings illustrated above, we can now evaluate the most common UHI mitigation strategies; predominantly from tropical thermal comfort and building energy point of view. In order to mitigate the UHI effect by improving microclimates in tropical

urban environment, two main strategies have been proposed: more vegetation and higher albedo surfaces (Rosenfeld, 1995; Shashua-Bar and Hoffman, 2000; Santamouris, 2001; Akbari et al. 2001; Emmanuel, 2005, Solecki et al., 2005).

According to Akbari et al. (2001) most of the summer heat islands are created by the lack of vegetation and the high solar radiation absorptions of urban surfaces. It was clearly concluded from the previous section (2.4.2) that the main causes of UHI are due to these particular problems. It has also been claimed that urban trees and high-albedo surfaces can offset or reverse the heat island effect (Jauregui, 1997; Akbari et al., 2001; Shashua and Hoffman, 2000; Solecki et al., 2005; Yu and Wong, 2006; Wong et al., 2007).

Taha's (1997) study using numerical and field measurements indicated that increasing albedo and vegetation cover can be effective for reducing surface and air temperatures near the ground. In another result meteorological simulations suggested that cities can possibly reverse heat islands and counterbalance their impacts on energy use simply by increasing the albedo of roofing and paving materials and reforesting urban areas (Taha, 1997).

Akbari et al. (2002) indicated that mitigation of UHI can potentially minimize US national energy use in air conditioning by 20%, saving over \$10B per year in energy use and improving air quality. In addition, the albedo of a city may be increased at least cost if high-albedo surfaces are chosen to replace darker materials for roofs and roads. The cost of planting trees is also cheaper than the cost of extra energy usage through air conditioning systems in buildings. Therefore, modification to vegetation cover and thermal reflectivity (albedo) of urban surfaces should be highlighted and the roles for each mitigation component need to be clarified.

2.7.1 The Role of Vegetation in the Urban Microclimate

Planting of vegetation is one of the main strategies to mitigate the UHI effect (Jauregui, 1990/91; Wong et al., 2007; Yu and Wong, 2006). Vegetation is defined as *any plant, or growing of plants* (Christensen, 2005). Vegetation can be considered one of the effective measures at both the macro and micro-level where such natural components can create an 'oasis effect' and so mitigate urban warming (Akbari, 2001). It should be noted that

trees and green spaces contribute significantly to cooling cities and saving energy use (Santamouris, 2001).

A single tree can moderate the climate well. However, such impacts are limited only to the microclimate (Jauregui, 1990/91). Thus, urban trees are predominantly effective for altering the climate of a city and improving urban thermal comfort in hot climates (Figure 2.22) (Akbari, 2002). However, the ability of urban trees to improve thermal comfort conditions in their surroundings is a function of the seasons, climate condition, dimension of green area, type of surface over which trees are planted, and the amount of leaf cover (Givoni, 1991, Emmanuel, 2005). Barradas et al. (1999) undertook a study in sub-tropical Mexico City and discovered that during the dry season trees dissipate nearly 70% of the net radiation through sensible heating and only 25% via latent means, on the other hand, the numbers are reversed in the wet season.

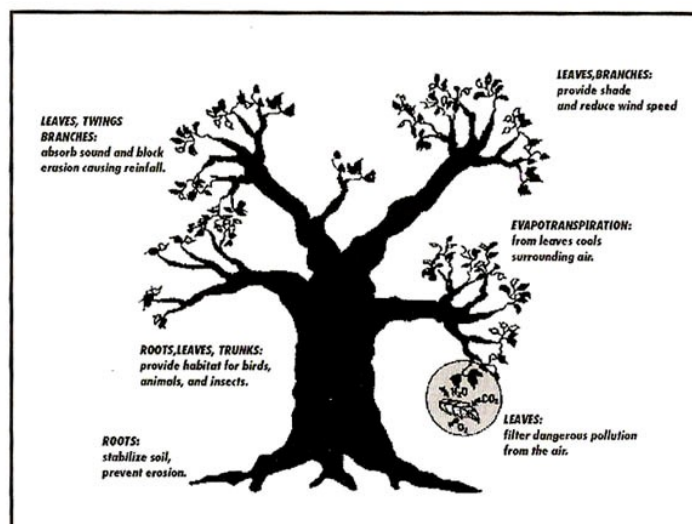

Figure 2.22 Ecological qualities of trees (Adapted from Akbari and Taha, 1992)

Correspondingly, with warmer climate conditions, the cooling effect of urban trees is more prominent (Shashua and Hoffman, 2000). Furthermore, trees planted over turfing or vegetated cover are more effective in transpiration than those planted over asphalt areas (Kjellgren and Montague, 1998). Therefore, evapotranspiration of plants is more effective. Additionally, when the amount of leaf cover or density of trees is higher, this makes the filtration of radiation more effective, the quality of shade become significant and the radiant heat underneath the canopy becomes lessened (Shahidan et al., 2010).

In tropical climates, the energy balance and cooling energy requirements can be altered by vegetation planted around buildings sheltering windows, walls, and rooftops from strong solar radiation and radiation reflected from surroundings (Figure 2.23) (Robinette, 1968; Brown and Gillespie, 1995; Akbari, 2002; Wong et al., 2007; Yu and Wong, 2006). Givoni (1991) claimed that the type and features of the plants around a building can affect the cooling effect, despite its exposure to the sun and the wind, its indoor comfort atmosphere and heating through energy uses.

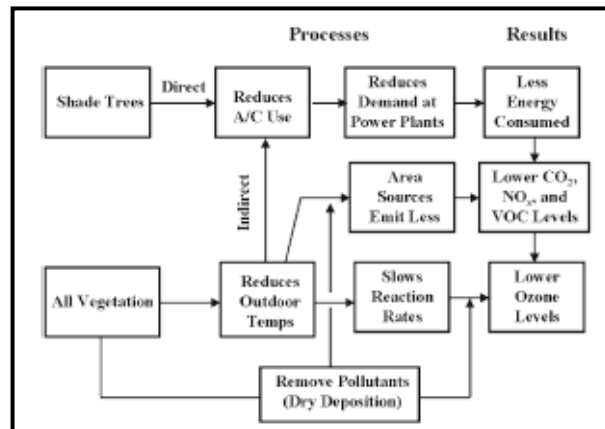

Figure 2.23 The process of and the benefits of vegetation and tree shading towards buildings and environment (Source: Akbari, 2002)

Givoni (1991) has listed several aspects affecting indoor temperatures and the cooling and building heating loads using plants that planted around buildings. Covering vines climbing over walls, shrubs and high canopy trees that provide radiation and wind ‘insulation’ to potential locations for trees that protect against solar heat in the summer shows how plants can effectively lower the air and radiant temperature and the cooling load in hot regions or climate. Thus, these effects would have a great impact on contributing to mitigate UHI’s impact in urban areas.

Another important role of urban trees is evaporative cooling. The term evapotranspiration refers to *the process of water loss from soil by both evaporation and by transpiration through plants growing in the soil* (Christensen, 2005). This means, how the water content of plants can ‘cool’ the air through the transpiration process. On hot summer days, a tree can perform as a natural “evaporative cooler” using up to 100 gallons of water a day, reducing the surrounding ambient temperature as a result (Akbari, 2002). Thus, the effect is much greater if there is a large amount of vegetation such as in an urban park.

Large urban parks can extend positive effects to the surrounding built environment. Yu and Wong (2006) stated that the energy balance of a whole city can be altered by adding more evaporating surfaces so that green spaces (e.g. urban parks, neighbourhood parks, rooftop gardens, pocket parks, etc.) are arranged throughout the city in the form of nature reserves. Plant life provides more sources of moisture through evapotranspiration; therefore, more absorption of radiation can be dispersed in the form of latent heat rather than sensible heat. As a result, the urban temperature can be reduced automatically. Based on the study by Taha (1997), a decrease of 2°C to 4°C in air temperature can be found when there is an increase in vegetation in urban areas. In Kuala Lumpur (Sham, 1990/91), a hot and humid city, parks are 4 to 5°C cooler than in nearby commercial areas during the afternoons, while in the evening there is only a 1°C difference between well-treed parks and their urban surroundings.

Simpson (2002) explained that urban forests and parks can alter microclimate and building energy use via (i) shading (reducing the amount of radiant energy absorbed and stored by ground and building surfaces; (ii) evapotranspiration, cooling the air with the liquid water-vapour conversion process in plants; and (iii) wind speed reduction, which can reduce infiltration of outside air, is effective in ventilation and convective cooling of building surfaces.

Therefore, it is clear that vegetation plays an important role in reducing, improving, moderating and cooling the air temperature and microclimate in the city areas to achieve a better and more comfortable environment. Thus, it is apparent that this component has considerable ability to mitigate the UHI in city areas.

2.7.2 Thermal Reflectivity (Albedo) and Cool Urban Surfaces

As mentioned in chapter 2.1, the albedo (α) is defined as the reflective power of a material indicated by the percentage of incident radiation reflected by a material (Christensen, 2005), and emissivity (ϵ) is the ability of a body to emit thermal radiation in the urban environment, simple homogeneous materials are categorized by various albedo and emissivity values and these can determine the complex reflectivity of urban areas. Therefore, Table 2.10 shows the albedo of various typical urban materials and areas, while Table 2.11

shows the reflectivity and emissivity of selected materials in urban surfaces (Santamouris, 2001). In urban areas, using high albedo value materials can reduce absorption of solar radiation through building envelopes and urban structures and so keep surfaces cooler (Brown and Gillespie, 1995; Taha, 1997; Santamouris, 2001; Emmanuel, 2005).

Table 2.10 Categorized albedo on typical urban materials and areas (Adapted from Santamouris, 2001)

Surface	Albedo	Surface	Albedo
<i>Streets</i>		<i>Paints</i>	
Asphalt	0.05-0.2	White, white wash	0.50-0.90
<i>Walls</i>		Red, brown, green	0.20-0.35
Concrete	0.10-0.35	Black	0.02-0.15
Brick/Stone	0.20-0.40	<i>Urban areas</i>	
Whitewashed stone	0.80	Range	0.10-0.27
White marble chips	0.55	Average	0.15
Light-coloured brick	0.30-0.50	<i>Other</i>	
Red brick	0.20-0.30	Light-coloured sand	0.40-0.60
Dark brick and slate	0.20	Dry grass	0.30
Limestone	0.30-0.45	Average soil	0.30
<i>Roofs</i>		Dry sand	0.20-0.30
Smooth-surface asphalt	0.07	Deciduous plants	0.20-0.30
Asphalt (weathered)	0.10-0.15	Deciduous forests	0.15-0.20
Tar and gravel	0.08-0.18	Cultivated soil	0.20
Tile	0.10-0.35	Wet sand	0.10-0.20
Slate	0.10	Coniferous forests	0.10-0.15
Thatch	0.15-0.20	Wood (oak)	0.10
Corrugated iron	0.10-0.16	Dark cultivated soils	0.07-0.10
Highly reflective roof after weathering	0.6-0.7	Artificial turf	0.50-0.10
		Grass and leaf mulch	0.05

High α
 Medium α
 Low α

Table 2.11 Categorized albedo and emissivity values for selected surfaces (Adapted from Santamouris, 2001)

Material	Albedo	Emissivity
Concrete	0.3	0.94
Red brick	0.3	0.90
Building brick	-	0.45
Concrete tiles	-	0.63
Wood (freshly planted)	0.4	0.90
White paper	0.75	0.95
Tar Paper	0.05	0.93
White Plaster	0.93	0.91
Bright galvanized iron	0.35	0.13
Bright aluminium foil	0.85	0.04
White pigment	0.85	0.96
Grey pigment	0.03	0.87
Green pigment	0.73	0.95
White paint on aluminium	0.80	0.91
Black paint on aluminium	0.04	0.88
Aluminium paint	0.80	0.27-0.67
Gravel	0.72	0.28
Sand	0.24	0.76

High α/ϵ
 Medium α/ϵ
 Low α/ϵ

Table 2.10 and 2.11 show that materials with white and green pigments (e.g. gravel, aluminium, white marble chips; light-coloured brick, tile and sand; lime stone, artificial turf and etc.) have higher albedos and emissivity values and so could be considered for lowering the UHI effect in urban environments. Based on Taha et al. (1992), who measured the albedo and surface temperatures of various surfaces in the field, white elastomeric coatings ($\alpha = 0.72$) were 45°C cooler than black coatings ($\alpha = 0.08$) in the early afternoon of a clear day in summer season. They also discovered that a white surface ($\alpha = 0.61$) was only 5°C warmer than the ambient air whereas conventional gravel ($\alpha = 0.09$) was 30°C warmer than air.

Although plants, soils and grass surfaces are categorized as having lower albedo values, it should be noted that these elements have higher porosity and can absorb more water and release more latent heat into the atmosphere. Unlike other materials with waterproof behaviour (low porosity), the surface temperature cannot be changed through the water absorption process.

A study by Huang et al. (2008) measured microclimate and air temperatures of four types of land cover spots in Nanjing, China. In general, there were found to be significant differences among different observation sites and showed a heating order during day time of: bare concrete cover > lawn > water areas > woods or under shade of trees; with reversed order during night-time when the air temperature of the lawn became the lowest. The result also shows that three types of land cover (lawn, water areas and woods) demonstrated the effect of dropping air temperatures ranging between 0.2 and 2.9°C. Given in detail, there were some instant dynamic features in temporal series (24-hr time) among these there were four types of land cover at the different observation sites. Thus, this shows a significant effect of high porosity in vegetation and soil, as compared to the waterproof surface of concrete, in lowering urban air temperature (Figure 2.24).

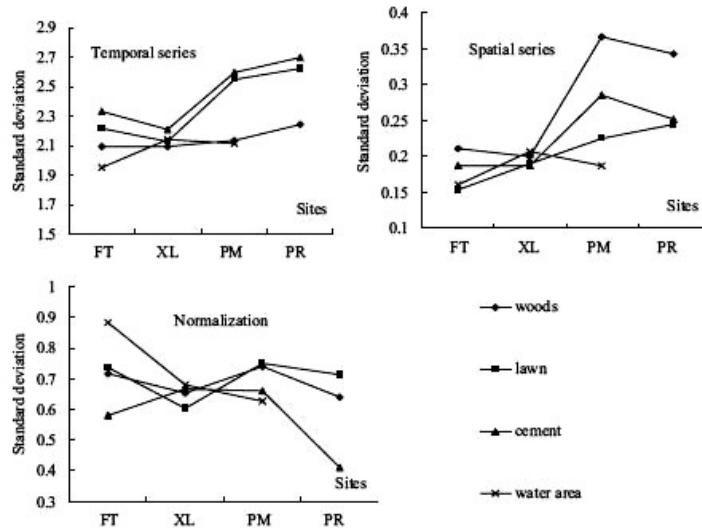

Figure 2.24 The three types of standard deviation of air temperature in the four types of land cover. Significant effect found in temporal series (FT: Fuzi Temple, XL: Xuanwu Lake site, PM: Purple Mountain site, PR: Pukou rural site) (Adapted from Huang et al., 2008)

According to Asaeda et al. (1996) (adapted from Santamouris 2001), they experimented on the thermal performance of some materials commonly used in urban pavements and streets during summer period. They found that the surface temperature, heat storage and the subsequent emission of heat to the atmosphere is significantly greater for asphalt than for concrete and soil. They also reported that in the maximum condition the asphalt pavement emitted an additional 150 W/m^2 in infrared radiation and 200 W/m^2 in sensible heat compared to a bare soil surface. Additionally, the absorption rate of infrared by the lower atmosphere over an asphalt pavement was greater by 60 W/m^2 than over a soil surface or concrete pavement.

Another study by Taha (1997) suggested that sensible increases in urban albedo can achieve a decrease of up to 2°C in air temperature. Thus, up to 4°C of localised decreases in air temperature can be found with extreme increases in albedo. Therefore, he suggested that the amount of solar radiation absorbed through building envelopes and urban structures can be reduced by using high albedo materials to maintain cooler surfaces. Akbari et al. (2001) provided measurements for the effects of albedo on pavement temperature at 3 P.M. in Berkeley and San Ramon, California (Figure 2.25). The data significantly indicated that modification of the pavement temperature can be achieved by 10°C decrease in temperature for a 0.25 increase in albedo.

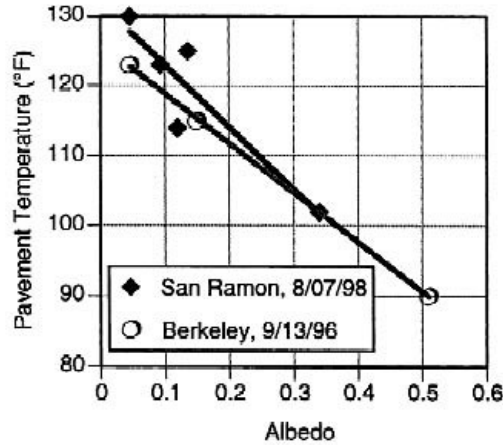

Figure 2.25 Dependence of pavement surface temperature on albedo. Data readings were taken at about 3 p.m. in Berkeley, California, on new, old, light-colour coated asphalt pavements. The data from San Ramon, California, were taken at about 3 p.m. on four asphalt concretes and one cement concrete (albedo = 0.35) (Source: Akbari et al., 2001)

Generally, urban albedos are in the range 0.10 to 0.20 but in some urban or city areas these typical values can be exceeded. Taha (1997) has listed values of snow-free urban albedos for numerous cities. It gives the difference between urban and rural albedos, where available. He highlighted the example of Lagos which is interesting because the city is built on a complex mesh of bays and lagoons that cause albedo to decrease as one gets closer to the suburbs (the albedo of water is lower than that of the light-coloured buildings (Table 2.10).

Table 2.10 Selected urban albedo values (Adapted from Taha, 1997)

Urban area	Albedo	Δ (urban-rural)
Los Angeles (city core)	0.20	0.09
Madison, WI (urban)	0.15-0.18	0.02
St. Louis, MI (urban)	0.12-0.14	
St. Louis, MI (center)	0.19-0.16	0.03
Hartford, CT (urban)	0.09-0.14	
Adelaide, AUS (commercial)	0.27 (mean)	0.09
Hamilton, Ontario	0.12-0.13	
Munich, West Germany	0.16 (mean)	-0.08
Vancouver, BC	0.13-0.15	
Tokyo	0.10 (mean)	-0.02
Ibadan, Nigeria	0.12 (mean)	0.03
Lagos, Nigeria	0.45	0.25

* Measured from low altitude aircraft flights (< 200m above ground level) in summer 1993.
 * Limited shortwave sensitivity of sensors.

Research by Taha (1997), based on one-dimensional meteorological simulations, shows that localized afternoon air temperature on summer days can be lowered by as much as 4°C by modifying the surface albedo from 0.25 to 0.40 in a typical mid latitude warm climate. Hence, it clearly explains that the albedo values and surface temperature in urban area can be changed and modified in order to mitigate the UHI effect.

2.8 A Review of the UHI Mitigation Strategies and Measures Studies through Vegetation and Ground Surface Material Influences

Studies on the impact of vegetation and ground surface materials influencing a moderating microclimate have been conducted widely across the globe. These can be divided into three major groups: (i) studies that focused on meteorological data and satellite images at the macro-level; (ii) studies focused on in-situ field measurements at the micro level; and (iii) studies that focused on numerical calculations and simulations to predict the thermal benefits of green areas, tree plantings, cool surfaces and pavements.

2.8.1 UHI Mitigation Using Meteorological Data and Satellite Images at Macro-Level

Studies using meteorological data and satellite images as tools are focused more on performance of vegetation and surface material at the macro level in order to minimize the impact of UHI. However, this method is limited to measures of the mitigation performance and potential of vegetation and ground surface material. Therefore, these studies can only provide guidelines of performance based on the results obtained from databases and satellite imagery analysis.

A study by Jauregui (1990/91) measured the influence of a large urban park in terms of temperature and convective precipitation (using 1961- 1987 range of meteorological data). The case study was carried out in Chapultepec Park, Mexico City and found that the park was approximately 500 ha and was 2 to 3°C cooler with respect to its boundaries, representing a cooling effect influencing a distance of as much as 2 km the same as its width. The graph demonstrated the cooling rate for rural, park and urban sites in Mexico City and showed that the Botanical Garden Park has a higher cooling rate than the other areas of the city (Figure 2.26). Therefore, it shows that park has a significant cooling effect and can exert influence on a certain radius throughout the city area.

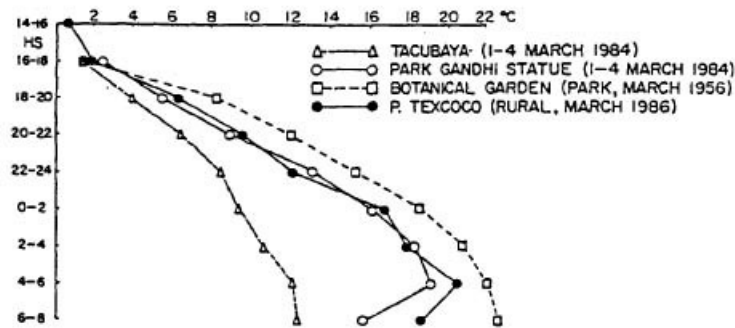

Figure 2.26 Cooling rate for rural, park and urban sites in Mexico City (Source: Jauregui, 1990/91)

Another study by Saito (1990/1991) conducted a series of field measurements in summer time to investigate the thermal effect of green areas in Kumamoto City in Japan. Meteorological data were measured at Kumamoto City and two smaller areas within the city on foot and by using automobiles and aeroplanes. Through field measurements the study indicated that the air temperature in the suburb area was 3°C (daytime) and 2°C (night) respectively, however, the high temperature regions were found in the more densely built environment. It was found that, the greater the ratio of green area, the more the air temperature will reduce. It was also noted that there is a significant cooling effect with a maximum difference of 3°C found between the inside and the outside of the small green area (60m x 40m). It indicated that green areas can significantly alter the thermal environment in the city even where they consist of smaller spaces.

A further study by Gomez et al. (1998) on UHIs and the effect of green spaces was based on the popular method of making transects crossing the city of Valencia, Spain by car. They observed that in green areas of the city, there was a drop of 2.5°C with respect to the city's maximum temperature in conditions did not encourage the forming of heat islands (Figure 2.27).

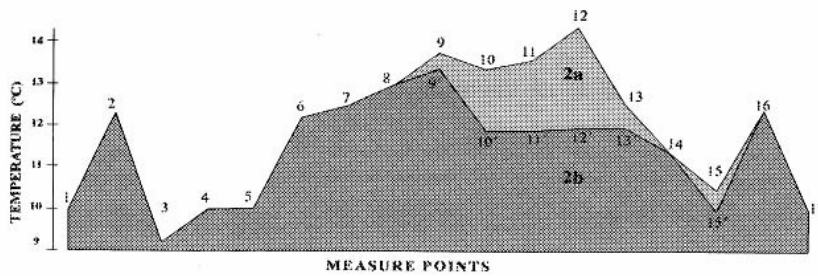

Figure 2.27 Temperature difference across Valencia for two transects (a) This transect is through the city centre including large buildings area (b) through park and river garden ‘green’ areas (Source: Gomez, 1998)

Using the same conventional method, Wong and Yu (2005) conducted a mobile survey to detect both the severity of UHI and the cooling impact of green areas at the macro-level in Singapore. This study strongly supported the statements by Jauregui (1990/91) and Gomez (1998), which showed a strong correlation between decreases in temperature and the appearance of large green areas in the city. It showed a mean temperature difference of 3.07°C with 25.01°C in open area/recreation and 28.08°C in the Central Business District (CBD) area. In addition the humidity level was found to be higher in green areas where the evapotranspiration process becomes significant (Figure 2.28). It can be concluded that large green areas have the ability to cool the city area and definitely have a positive effect on mitigating the UHI effect in the city, especially in tropical climates.

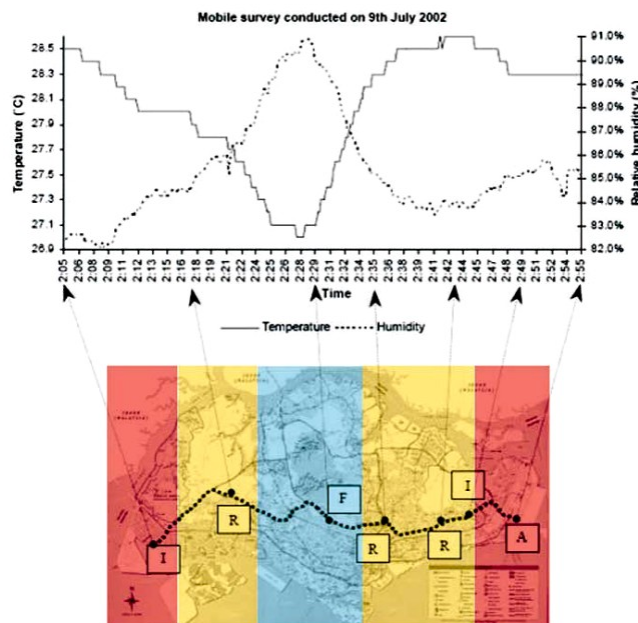

Figure 2.28 The graph shows the transaction of temperature and relative humidity distribution in four different areas (I-industry area; R-residential area; F-forest area; A-airport). The forest area (blue mark) had lower air temperature and higher humidity level due to vegetation in green spaces (Source: Gomez, 1998)

In the study using satellite images as a tool, Kawashima (1990/91) studied the effects of vegetation quantity on the surface temperatures in urban and rural areas of Tokyo. According to his observation, lower surface temperature was generally observed in green areas while higher temperatures were found on the soil and buildings during the daytime. However, the effect of vegetation on reducing surface temperature in the urban area is smaller relative to that in suburbs. In the urban area, the surface temperature ranged from 1.4 to 2.7°C in the green area while it ranged from 2.0 to 3.4°C in buildings and 2.3 to 4.9°C on the soil. In the rural area, the surface temperature ranged from 2.6 to 2.8°C in forests while it ranged from 3.3 to 4.2°C in buildings and 5.1 to 5.9°C on the soil. The lower surface temperature was observed in green areas in the urban environment at night-time, while higher surface temperatures were found in forests in the suburbs. Therefore; the daily variation of surface temperatures was large in planted areas but small on urban surfaces and built up areas in the urban environment, whereas it was small in both the built environment and forests in the suburbs.

A study by Nichol (1996a) applied the same method, but using high-resolution thermal data obtained from Landsat's thematic mapper, to investigate the cooling effect of green areas on central business district and housing development areas in Singapore. The study found out that the mean surface temperatures for tree canopies; grass and concrete surfaces were 32.9°C, 35.6°C and 40.7°C respectively. It noted through field measurements; that the lowest temperature, of about 28.7°C, was detected under tree canopies and a 1.5 to 2°C surface temperature difference was found between tree canopies and surrounding areas. This is due to tree shading properties that filter most of the solar radiation before it reaches the ground surface. Nichol believed that this small difference would affect human comfort and micro surroundings in tropical climates. Thus, trees play a prime role in giving shade and protecting ground surfaces from becoming hotter in urban areas.

2.8.2 UHI Mitigation Using In-Situ Field Measurement at Micro Level

The studies using the in-situ field measurement method at micro level focused on details of each entity in order to understand the individual performance of trees or/and surface materials. These studies provide comprehensive results on the performance and capability of certain trees or ground materials in moderating the impact of UHI. Results from the studies also provided guidelines regarding each individual tree or ground surface, but were limited to

certain sample selections and also by the scope of the studies.

Kjelgren and Montague's (1997) study involved measuring the effect of urban tree transpiration over turf and asphalt surfaces in Illinois and Utah, USA in summer seasons. They used in depth field measurements and a two-layer canopy model to study the effect during several dawn-to-dusk periods. The study pointed out that the afternoon asphalt surface temperatures (T_s) were 20-25°C higher than of the turf T_s in all studies (Table 2.12). The results also showed that trees over asphalt had consistently higher leaf temperature (T_l) than those over turf, apparently due to interception of the greater upwards long-wave radiation flux from higher T_s and less water loss due to higher T_l over asphalt, causing prolonged stomatal closure. In consequence, trees lost more water and the process of evapotranspiration was not so effective over asphalt surfaces due to its high thermal capacity characteristics.

Table 2.12 The differences between asphalt and turf air temperature, vapour pressure and surface temperature (Adapted from Kjelgeren and Montague, 1997)

Date	Air temperature (C)		Vapour pressure Deficit (kPa)		Surface Temperature	
	Asphalt	Turf	Asphalt	Turf	Asphalt	Turf
July 17	31.0	29.2	3.87	3.34	55.3	30.3
July 23	28.8	29.1	2.80	2.81	54.7	29.2
August 13	34.7	35.1	4.69	4.84	59.8	32.6
<i>Significance^a</i>						
July 17		**		**		***
July 23		Ns		Ns		***
August 13		Ns		Ns		***

^a Comparison of means between asphalt and turf surfaces significantly vary at 1% (***) , 5% (**), 10% (*) level of probability or non significant (ns)

A further study by Victor et al. (1999), in the south of Mexico City measuring a series of energy balance measurement, indicated that the change to the energy balance in a vegetated area may not always have a positive impact on surroundings; in addition as a result of the lack of adequate evapotranspiration the planted area may not offer a significant cooling effect to surrounding areas during the dry season. This is indicated from the result wherein the net radiation was mainly dissipated by sensible heat during the dry season, whereas it was mainly dissipated by latent heat during the wet season. Therefore, the cooling effect will occur when there is sufficient evapotranspiration from the vegetation in respect to specific environmental conditions.

Ca et al. (1998) took some field measurements to determine the cooling influence of a park in the surrounding area of the Tama New Town, a city in the west of Tokyo. The observations indicated that vegetation could certainly alter the climate of the town. The surface temperatures measured in the afternoon on the grass field in the park (max temp. 40.3°C) were much lower than those measured on the asphalt (59.3°C) and on the concrete surfaces (55.3°C) in the parking area and commercial areas respectively. Simultaneously, air temperatures measured at 1.2m above the grass land were more than 2°C lower than those measured above hard surfaces in commercial and parking areas. At a size of 0.6 km², a park can reduce air temperature by up to 1.5°C at noon time in a leeward commercial area at distance of 1 km (Figure 2.29). Therefore, turfing and ground cover vegetations play an important role in generating effective evapotranspiration, creating a cooling effect in green spaces and park areas.

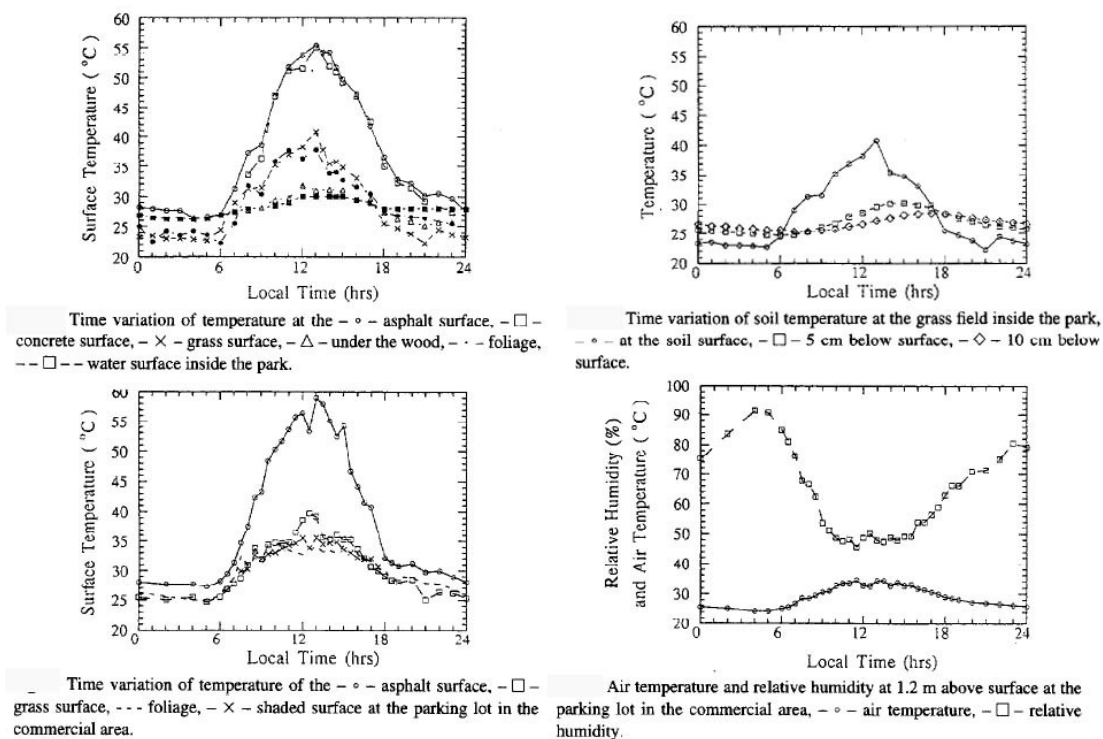

Figure 2.29 The graph shows the different impact of ground surfaces inside the park and at the parking lot in the commercial area (Source: Ca et al., 1998)

Another study (Papadakis et al, 2001) focused on analysing the effect of using trees for solar control of buildings by shading. Parameters in the study were measured according to field measurements and an in-situ survey. Several parameters were measured based on two situations - high trees shaded one area; the other was clear from any shadow.

Comparisons were made in a hot summer period, on the Agricultural campus at the University of Athens, between the physical parameters regarding the air and wall surface temperatures, the heat exchanges between the wall surfaces and the surrounding environment and the wind speed and the humidity of the air. The result showed that the evaporative cooling effect of the plants resulted in a lower air temperature around the shaded wall. It is an efficient passive method for the solar control of buildings and provides a significant conventional artificial sunscreen (Figure 2.30). Additionally, the study shows the ability of trees to act as natural solar device in reducing surrounding surface temperature on outdoor building façades.

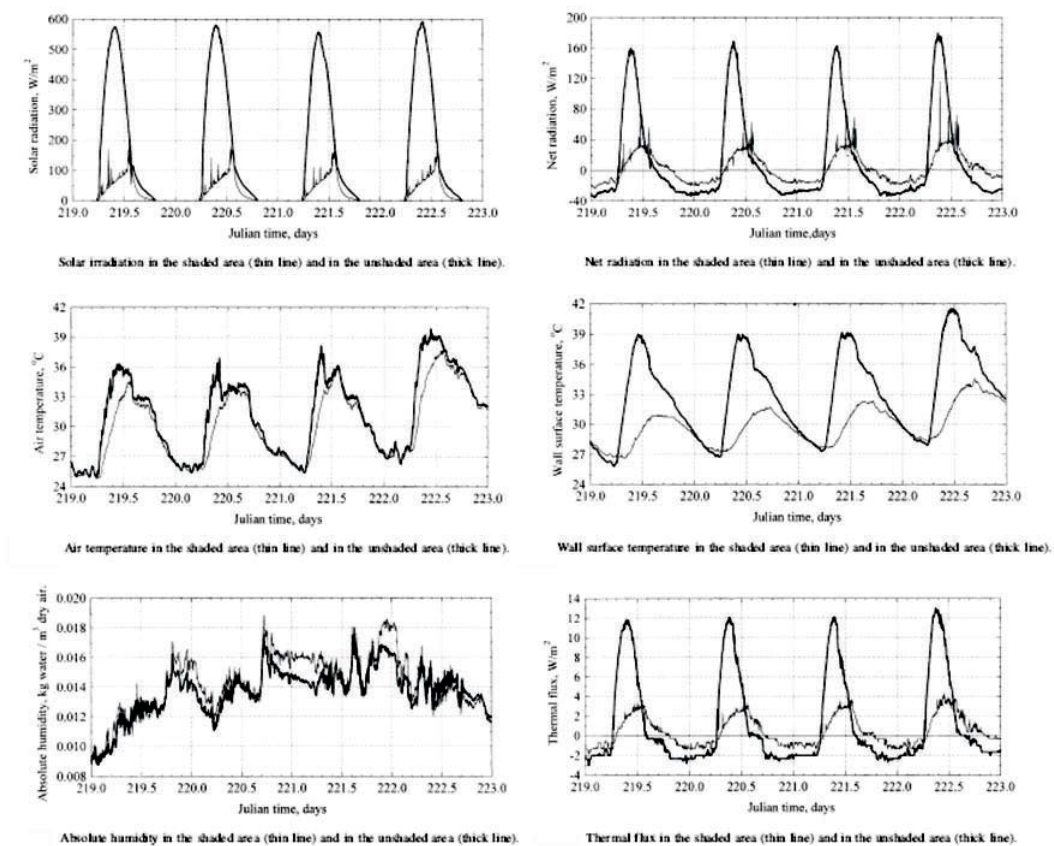

Figure 2.30 The graph shows the different impact of shaded (thin line) and unshaded area (thick line) between physical parameters regarding the air and wall surface temperatures; the heat exchanges between the wall surfaces and the surrounding environment; the wind speed and the humidity of the air (Source: Papadakis et al., 2001)

In the same area as Papadakis (2001), Shahidan (2010) also conducted a study comparing the effectiveness of two types of tree structural forms regarding filtering thermal radiation. The trees are *Mesua ferrea L.* and *Hura crepitans L.*, representing roundhead trees and horizontal shape species respectively. This study focused on three variables that influence solar radiation filtration; namely, transmissivity, leaf area index and shade form.

Two evaluation methods were employed in this study; (i) a field measurement programme using a modified net radiometer and other related instruments, and (ii) Ecotect - a computer-based sun-shading analysis system.

Results from the study indicated that both *Mesua ferrea L.* and *Hura crepitans L.* contribute significantly to direct thermal radiation modification below their canopies. The average heat filtration beneath the tree canopy for *Mesua ferrea L.* was found to be 93% with 5% canopy transmissivity, 6.1 of leaf area index, and 35% of shade area. Meanwhile for *Hura crepitans L.* the average heat filtration under the canopy was 79% with canopy transmissivity of 22%, leaf area index of 1.5 and 52% of shade area. Therefore, the study found that *Mesua ferrea L.* was better than *Hura crepitans L.* at filtering thermal radiation (93% and 79% respectively). This was attributed to the density and branching habit of *Mesua ferrea L.* (i.e. roundhead with high density) with a leaf area index of 6.1 it allows only 5% transmissivity as compared to the *Hura crepitans L.* foliage density and branching system (leaf area index of 1.5 and 22% transmissivity) (Figure 2.31). Finally, the study also determined that the density and branching system of the trees can improve the efficiency of the thermal filtration; by improving the quality of the shade so that it becomes significant and lessening the radiant heat beneath the canopy.

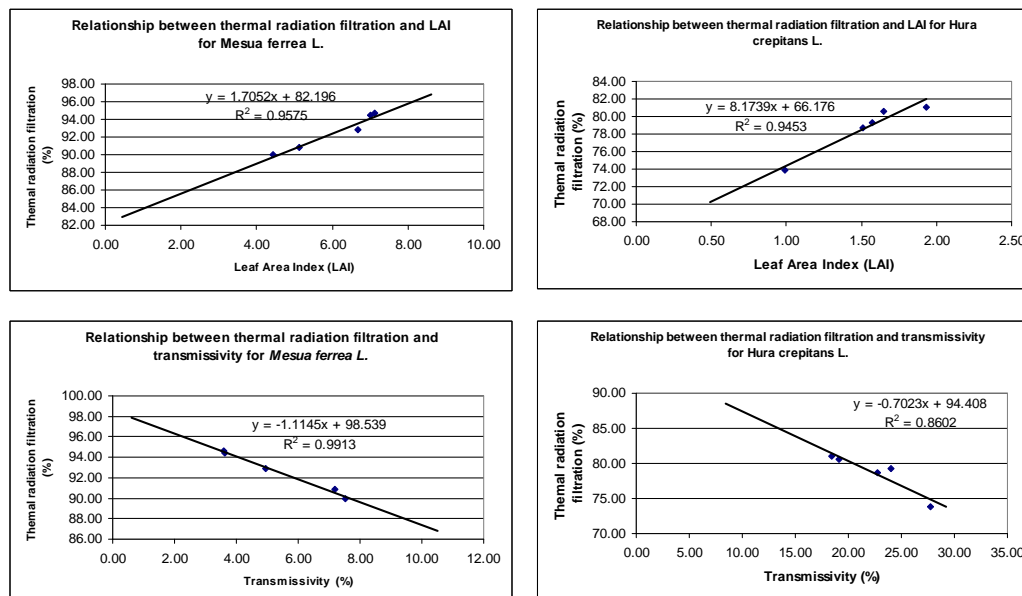

Figure 2.31 The significant relationship of tree canopy density and branching structure vs. thermal radiation filtration in tropical climate (Source: Shahidan et al., 2010)

In support of Shahidan et al's (2010) study regarding density of trees; an earlier field measurement study conducted by Yu and Wong (2006), to explore and predict the benefits of city parks and the cooling effects of city greens, proved that large urban parks can expand the positive impact to the urban surrounding area. This was shown in the study through the field measurement in the surrounding urban area which had a lower average temperature of 1.3°C when it was near to the park. As a result, the higher the number of parks built in an urban area, the lower the urban temperature will be. However, there is a variation in intensity of cooling effect within a typical park which can be explained by the arrangement of plants and their LAI values. Yu and Wong (2006) identified that the density or LAIs of plants has a strong correlation with the ambient temperature measured within parks. Plants with higher LAIs may be accepted to cause lower ambient temperatures (Figure 2.32).

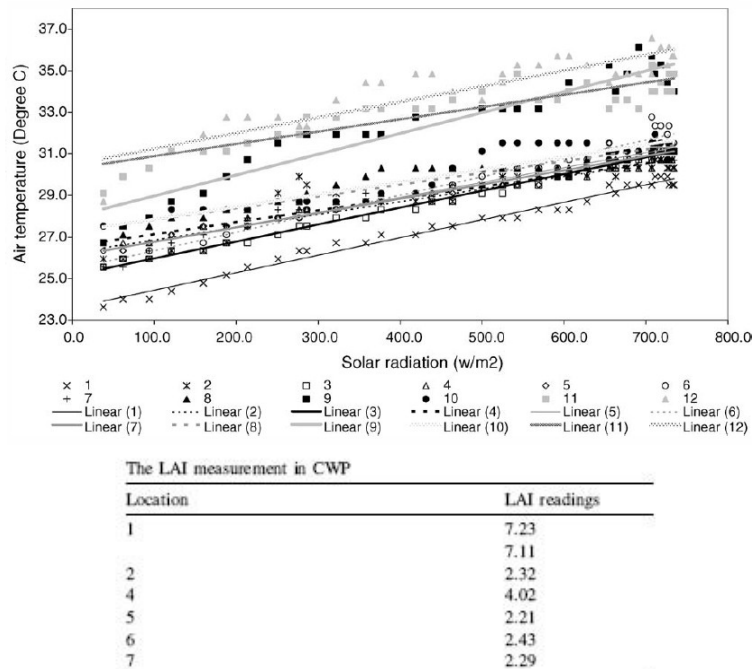

Figure 2.32 (Above) The correlation analysis between solar radiation and air temperatures at all locations in Clementi Wood Park; (Below) The LAI measurements in seven location within Clementi Wood Park (CWP) (Source: Yu and Wong, 2006)

2.8.3 UHI Mitigation Using Numerical Calculation and Modelling

The studies using numerical calculation and modelling simulations are focused to assist understanding of how the heat island works so as to estimate how effective it would be to apply different mitigation measures. A number of models exist from which to evaluate the heat island's effects on individual buildings, a single street or neighbourhood, or/and an entire region. Currently, there are four main types of model used to evaluate the heat island

phenomenon; one model to evaluate the energy efficiency measures and those factors that will potentially result in its alleviation; these are: (i) building energy models, (ii) canyon and comfort models, (iii) ecosystem models, (iv) urban microclimate models, and (v) regional models (Gartland, 2008). The majority of these models will provide predictable results that cannot be obtained using other tools and can be manipulated according to different mitigation measures. However, there are strengths and limitations to each model that need to be highlighted.

(i) Building Energy Models

Building energy models are used to predict how much energy a building will use for heating and cooling. These models are relatively sophisticated and account for a building's location, geometry, construction, lighting and appliances, heating and cooling systems, and daily patterns of operation, in order to estimate the energy consumed. These models are used to evaluate numerous energy efficiency measures; however, for heat island mitigation they are used to evaluate the effects of installing a cool roof, planting trees for shade or putting cool paving around a building (Gartland, 2008).

The most commonly used building energy model is the DOE-2, a program developed over a decade ago by the US Department of Energy. However, the DOE-2 does suffer from some limitations that underestimate the savings from cool roofing. The program has some limitations: it does not correctly calculate convective heat transfer from the roof due to wind; nor does it account for radiative heat transfer in an attic or plenum space; it also assumes that roof insulation properties stay constant with temperature. It has been found to under-predict the energy savings of a cool roof by as much as 50 percent (Gartland et al, 1996). However, the final DOE-2.1E version of DOE-2 has many user interfaces available to simplify its use; so it still serves as the basis of calculations for the majority of energy conservation work (Gartland, 2008). Indeed, this program has served as the basis for many estimates of building energy savings due to heat island mitigation. One example is a study by Akbari and Konopacki (2005) to estimate the potential of heat-island reduction (HIR) strategies (i.e. solar-reflective roofs, shade trees, reflective pavements and urban vegetation) to reduce cooling-energy use in buildings. In the study, they used a DOE-2.1E model to simulate the effects of HIR strategies on building cooling, and heating energy use, and peak power demand, supported by 240 locations of weather data. The simulation included the effect of;

(i) solar-reflective roofing material on buildings (direct effect), (ii) placement of deciduous shade trees near south and west walls of buildings (direct effect), and (iii) ambient cooling achieved by urban reforestation and reflective building surfaces and pavements (indirect effect). The results from their simulation showed that over 75% of total savings manifested as a result of direct effects of cool roofs and shade trees.

In contrast, EnergyPlus is another tool with a comprehensive simulation engine for better temperature and comfort prediction. This program was developed by the U.S. Department of Energy in collaboration with Lawrence Berkeley National Laboratory, National Renewable Energy and several universities. The level of expertise required to use the tool is rather high and any definition can result in a significant impact on the results obtained. In particular a high definition of the mechanical system is required. Thus, the tool is more suitable for the final design stages where a good level of detail can be provided. As reported, text input may make it more difficult to use than graphical interfaces (Crawley et al, 2005; Yezioro et al, 2008). However, one of the advantages of using this software is the accuracy and detailed simulation capabilities through complex modelling capabilities (USDE, 2010).

Another building energy models that can be used for the purpose of evaluating the thermal analysis of buildings is the TAS software package. TAS is a complete package for the thermal simulation of a building and design tool in the optimisation of a building's environmental, energy and comfort performance. It has an excellence level of responsiveness and is an accurate tool for concept development. However, the model is not intended for detailed services layout design (USDE, 2010). One interesting study using TAS simulation for evaluating the impact of trees on a buildings energy saving capacity was done Yu and Wong (2006). Results from the study using TAS simulation (which simulate the dynamic thermal performance of buildings and their system) indicated that the energy of the building may be saved when it is built closer to parks, and this shows a maximum 10% reduction in the cooling load (Table 2.13).

Table 2.13 Comparison of cooling loads for different locations (Adapted from Yu and Wong, 2006)

	Cooling Load (kWh)	Energy Savings (compared with 400m) %
In the park	9077	10
100 m from the park	9219	9
200 m from the park	9383	7
300 m from the park	9672	4
400 m from the park	10123	0

Another building energy model that can be used for evaluating building energy is HTB2 (Alexander, 1996). HTB2 is a finite unique model developed at Cardiff University that is intended to simulate the energy and environmental performance of buildings. It is a revised version of the Heat Transfer through Building program (HTB) that was developed in 1971 (Alexander and Jones, 1996). Being an investigative research tool rather than a simple design model, HTB2 can be used to demonstrate comprehensive operating predictions for internal environmental conditions and the energy demand of a building, during both the design stage and its occupancy period (Li et al, 2007). In contrast to a TAS simulation, the model evaluation includes the building services input in the analysis calculation. It can predict the influence levels of fabric, ventilation, solar gains, shading, occupancy, ground surface and outdoor environment with external meteorological data being provided on the thermal performance and the energy use of a building (Jones and Alexander, 1999). One of the strengths of HTB2 in a research environment is the ability to easily alter or replace all input components (i.e. meteorological conditions, ventilation, building construction, space heat balance and transfer etc.) (Alexander, 1996). Based on Li et al's (2007) study, the use of HTB2 for justifying the substitution and alteration of building materials is based on how easily it can predict future levels of energy consumption based on the improved external wall and the changing construction method. In the study he used the seasonal weather data in Xi'an city to provide the different outdoor environments for the model. By changing the construction and material properties, the traditional housing's heating energy reduced from 14 to 15 percent and this could predict improvements to the outdoor environment after modification has been made. Thus, there is a possibility afforded to this model to provide the range of building energy consumption data through the understanding of the influence of the different outdoor environments towards the improvement of internal building energy environments.

(ii) Canyon and Comfort Models

The next step resulting from studying individual buildings is to study the configuration of buildings surrounding a street, so called, as urban canyon models. Essentially, the model is based on energy balance equations that represent the heat transfer between pavement and building walls (Gartland, 2008). Canyon geometry, wind patterns and solar loads are taken into account for shade during certain parts of the day. These models were first used to help clarify the mechanisms responsible for heat islands (Oke, 1981 and

Arnfield, 1982). They have also been used to evaluate how the geometry of urban areas affects urban climate (Sakakibira, 1996; Masmoudi and Mazouz, 2004; Kruger et al, 2009), and how urban climate affects the energy use of buildings (Santamouris, 2001; Georgakis, 2002; de la Flor and Dominguez, 2004).

Although there is limited work on how best to estimate the effects of cooling surfaces or adding vegetation, consideration of the urban canyon seem ideally suited in this kind of study (Gartland, 2008). One interesting study by Alexandri and Jones (2008) used urban canyon models as a tool to see what the effects of cool roofing and vegetated walls were on conditions at the base of urban canyons in Athens, Greece. In the study, the landscaping of walls was found to have a dominant effect, but the cooling of the roof and walls together reduced air temperature in the canyon by 6 to 8°C.

Another significant study by Memon et al. (2010) aimed to simulate the characteristic roles of building aspect ratio (AR) and wind speed, on air temperature during different street canyon heating situations. The model is employed to predict air temperatures in idealized street canyons with aspect ratios (building-height-to-street-width ratio) of 0.5-8, and ambient wind speeds of 0.5-4 m/s. Thus, the study found that the air temperature rose when there is low wind speed and high and low building aspect ratio are also revealed during different diurnal situations in the night-time and UHI daytime temperature closely resemble one another closely (Figure 2.33).

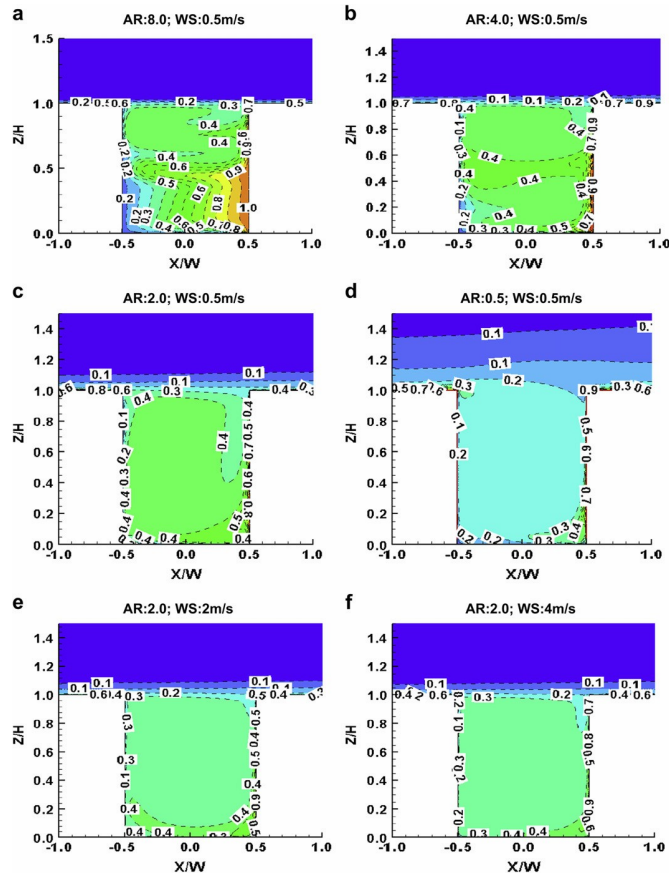

Figure 2.33 Spatial contours of normalized temperature during windward wall heating using predicted model (Source: Memon et al., 2010)

(iii) Ecosystem Model

The Ecosystem model looks at the effects of vegetation in urban areas at the macro level. There are two models available: CITYgreen, developed by American Forests, and i-Tree, from the US Department of Agriculture (USDA) Forest Service. CITYgreen, a GIS-based modelling application developed by the American Forests (American Forestry Association, 1996) evaluates how a region's trees and vegetation reduce storm water run-off, improve air quality, decrease energy use and store carbon. Urban planners, regulatory agencies, urban foresters, developers and others use CITYgreen to assess the economic benefits of urban vegetation (Solecki et al, 2005 and Gartland, 2008). A similar application is CITYgreen but is limited in application; i-Tree is a suite of tools for assessing the costs and benefits of urban trees. It can assist urban foresters in compiling field data, inventorying trees and estimating tree management costs and the value of trees in terms of energy conservations, air quality improvement, CO₂ reduction, storm water control and property values. One significant study by Solecki et al (2005) used a CITYgreen model so as to for the purposes of estimating the potential benefits of urban vegetation and reflective roofs as UHI mitigation

strategies for case study sites in and around Newark and Camden, New Jersey. The urban vegetation was found to reduce health hazards associated with the UHI effect by removing pollutants from the air. In addition, urban vegetation is an effective and economically efficient way to reduce energy consumption and costs at specific sites.

(iv) Urban Microclimate Models

Urban microclimatic models can be used to evaluate the interactive effects of urban design or UHI mitigation strategies (i.e. vegetation, ground surface and buildings) in urban areas; regarding microclimate components such as air temperature, relative humidity, wind flow, solar and terrestrial radiation and evaporation. Put simply, the model combines the calculation of fluid dynamics parameters such as wind flow or turbulence with the thermodynamic processes taking place at ground level, on walls and roofs or on plants. There are significant microclimate models that can be used for predicting urban microclimates, such as the ENVI-met model, developed by Prof. M. Bruse, University of Mainz, Germany; and the CTTC model, developed by M.E. Hoffman and colleagues. Although the PHOENICS CFD model (developed by CHAM, a company located in Wimbledon, England) is not categorised as a microclimate model, however, the application can be utilised for environmental evaluation purposes.

A PHOENICS CFD package model simulates processes involving fluid flow, heat or mass transfer, chemical reaction and combustion in engineering equipment and the environment. It can simulate fluid movement and heat transfer for a wide variety of applications, from the individual pipes to urban blocks. Indeed, one of these applications is useful for environmental impact studies. Although very comprehensive, it requires additional HVAC objects and capabilities for specific use in building services design and for the effect on vegetation some additional parametric modelling and collection of tree data is necessary before running the program. A significant study was carried out by Dimoudi and Nikolopoulou (2003) to investigate the microclimatic effects of vegetation with respect to reducing the air temperature, therefore mitigating the heat island effect. The study using parametric studies in two different forms; mathematical plant: transpiration model, on the immediate scale of the plant and CFD analysis, PHOENICS programme, on the scale of the urban block. In parametric studies using CFD, generic urban textures were tested with and without vegetation of different sizes for typical climatic conditions. Vegetation characteristic were collected based on an extensive bibliographic survey, such as the evapotranspiration

rate, transmission, albedo and permeability. The study indicated that vegetation can greatly influence the area within the park as well as the surrounding area, particularly on the leeward side of the green area. The study also suggested that an average temperature reduction of around 1 K can be expected for every 100m² of vegetation added to the park. On the other hand, the higher the ratio of green to built areas in an urban texture; the greater the air temperature reduction to be expected in the area.

The Cluster Thermal Time Constant or the CTTC simulation model is another model used to predict urban temperatures as a function of basic urban geometry. This CTTC model has been used in a number of studies to predict urban air temperature variation (Swaid and Hoffman, 1990). Although satisfactory results were reported for periods of one or two days, the original CTTC model was fairly limited in its application, due to the imposition of several restrictive requirements and assumptions; such as, (i) the effects of vegetation and moisture content are not included, (ii) the effect of anthropogenic heat contribution to the urban canopy layer is not modelled, (iii) the air in the urban canopy layer is well-mixed, with no temperature differentials occurring within it, (iv) prevalence of fair-weather conditions, i.e. clear skies and light-to-moderate winds (Williamson and Erell, 2001). Shashua and Hoffman (2000) devised a study to predict the air temperature variations within urban clusters with trees. Their model is based on the statistical analysis carried out with 714 experimental observations gathered hourly from the 11 sites on calm days, when urban climate is apparent. The study was based on summertime data for four major control elements: trees, albedo modification of the walls, thermal effect of deepening the cluster, and orientation. Due to the limitations listed above, the cooling effect of the vegetation was measured according the relationship in linear regression models of air temperature and the humidity effects measured inside and outside the site. The study discovered a significant difference in temperature level, of 0.5 K at 15:00h in summer, when both cluster types (urban streets and attached outdoor canyon-type courtyards) were compared with and without trees (Figure 2.34).

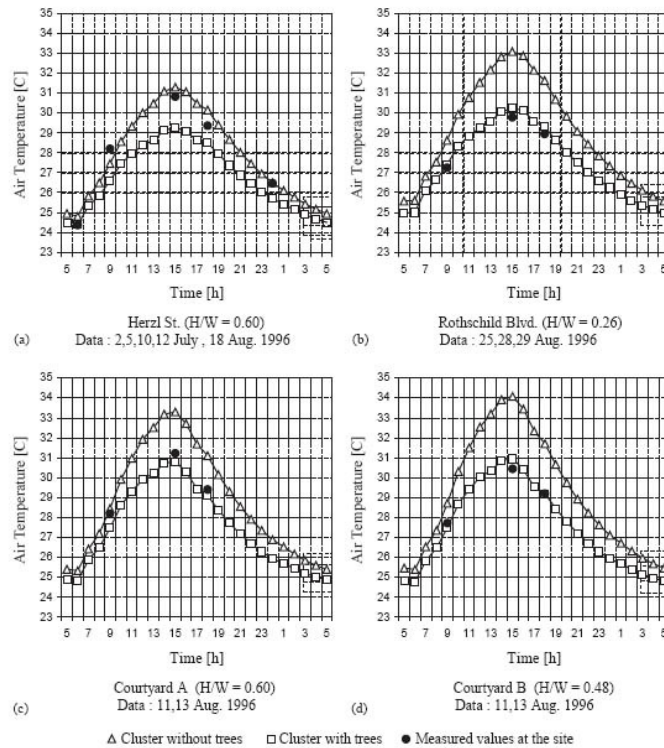

Figure 2.34 Simulated patterns and measured in situ values of diurnal air temperature at the sites - cluster with and without trees (Source: Shashua and Hoffman, 2000)

The cooling effect of shaded trees in streets and courtyards in Tel-Aviv was found to depend on tree density (tree shade coverage – PSA level) and on the cluster geometry (streets or courtyard). Albedo modification from 0.5 to 0.7 has a cooling effect of as much as 1.2K. It was also noted that with more shade coverage, the indoor AC energy and outdoor conditions can be saved and improved through a 4.5 K cooling in the UCL air temperature. The study shows that tree shade and the density of trees is an important aspect in determining maximum cooling effect through the urban streets and courtyards. In addition it is recommended that the modification of ground surface albedo should be highlighted as such changes significantly improved the microclimate.

ENVI-met is another alternative microclimate model for use in measuring heat island mitigation. ENVI-met is a three-dimensional numerical model that can simulate the surface-plant-air interactions of urban environments with a typical resolution of 0.5-10 m in space from a single building up to a neighbourhood providing 250 grids as a maximum (Bruse, 2008). It is a non-hydrostatic prognostic model based on the fundamental laws of fluid dynamics and thermodynamics in a much improved package than the CFD which is only a package for fluid dynamics' simulation (Ali-Toudert and Mayer, 2006; Fahmy et al, 2010). It is almost completely capable of simulating built environments from a microclimate scale to a

local scale at any location. This is regardless of overestimations, resulting from miscalculations of soil heat storage (Spangenberg, 2008) and global radiation overestimations by day (Ali-Toudert, 2005), and under estimations of both the average air temperature and the diurnal amplitude due to the high sensibility of wind speed (Spangenberg, 2008). However, the strength of this model is that ENVI-met has implemented a soil-plant-air sub-model and its plant database, which depends on the plant numerical physiological representation using height, albedo, leaf area density, stomata resistance, leaf surface temperature water content etc. in addition to the main model shows complete meteorological outputs (Fahmy et al, 2010, Maerschallck et al, 2008). For the latter the CFD-model is coupled to a simplified soil model where the energy budget is calculated at the ground surface. Thus, the albedo of the surfaces can be manipulated in order to evaluate the impact on the environment.

There are two significant studies that relate to the ENVI-met model to describe the impact of vegetation in a large and small scale area. In a large scale area, Wong et al (2007) did a study on the impact of greenery at the National University of Singapore (NUS) campus. Combinations of methodologies were employed using satellite images, field measurement and simulation via ENVI-met. The result indicated that the location of buildings near or surrounded by greenery have lower ambient temperature than those located away from the green area, and it is believed to be one effectual way to lower the ambient temperature. The same model was used to predict different scenarios and the results show that by adding denser greenery to the NUS environment, the campus would become markedly cooler than it is at present. Another small scale and more detailed study was conducted by Fahmy et al (2010) to investigate the thermal performance based on leaf area index (LAI) in distinguishing trees for Cairo's urban developments. By using an ENVI-met model, the study evaluated two different tree species; namely, *Ficus elastica* and *Pelthophorum pterocarpum* in two urban sites with one having no trees, whilst the second has *Ficus elastica* trees. The study indicates that *Ficus elastica* performed better than the *Pelthophorum pterocarpum*. Generally, *Ficus elastica* performed better, with 0.1-0.3 K reductions from both cases, although there is reduced wind speed and a lack of soil in the water preventing evapotranspiration effects. Both studies can be summarised by determining that the ENVI-met model provides more detailed features for evaluating trees and ground surface effects by mitigating the heat island; thus, providing a better prognostic evaluation than other similar models.

(v) **Regional Models**

Regional models can be used to evaluate the effects of heat island mitigation on regional air temperature and air pollution. Researchers have been able to model heat island effects using a combination of meteorological and photochemical modelling techniques. There are two types of regional models commonly used for this type of study, namely, the MM5-CAMx model, developed by Pennsylvania State University and the National Centre for Atmospheric Research; and MIST, developed by Sailor and Dietsch (2007).

The MM5 regional climate model is a non-hydrostatic model that dynamically simulates the interactions between a range of land-surface coverings and climate variables (Grell et al, 1994). MM5 and similar regional atmospheric models use a fluid dynamics approach to simulate the flow of heat, moisture and momentum over different land surface types including urban areas. Buildings are not explicitly represented in the MM5 model, however, their presence is assumed through the boundary layer structure, which controls the surface transport of heat and moisture (NYSERDA, 2006). In the second part of the model, the comprehensive air quality model with extensions (CAMx) is used to simulate the air quality of a region (Gartland, 2008). In order to evaluate the effects of heat island mitigation measures, input for these models must be extensively manipulated. Therefore, both models need to be run iteratively due to some of the input being very interdependent. This can be considered as leading to increased difficulties with modelling the effects of UHI mitigation. However, most researchers are making improvements in terms of providing evidence as to how UHI mitigation measures can reduce temperature, smog formation and pollution in various urban areas (Douglas et al, 2000; Sailor, 2003; Taha, 2005). One significant study by New York State Energy Research and Development Authority (2006) used the MM5 model in combination with observed meteorological, satellite and GIS data to determine the impact of urban forestry, living (green) roofs, and light-coloured surfaces on near surface air temperature and the UHI in New York. The study showed that based on mitigation strategies results, vegetation cools surfaces more effectively than increases in albedo. Maximizing the amount of vegetation in New York City by planting trees along streets and in open spaces, as well as by building living roofs (ecological infrastructure), offered more potential cooling than any other individual strategy.

In contrast to complicated meteorological and photochemical modelling, a much simpler tool has been developed to predict the potential regional impacts of heat island mitigation. The Mitigation Impact Screening Tool or MIST (Sailor and Dietsch, 2007) is a web-based tool that can approximate how increasing a region's solar reflectance and vegetation will reduce temperature, smog and energy consumption. Thus, there with limitation in this model to visualize the mitigation impact since the model can only provide qualitative results. As reported in Sailor and Dietsch (2007), MIST should not be used as the basis for regulatory decision-making. It should only form the basis of a feasibility assessment as a more detailed analysis using traditional methods needs to be carried out in order to evaluate the mitigation impacts.

2.9 Summary

In conclusion, UHI caused by urbanisation extensively impacts on all world cities, regardless of location. Most of the impact due to the built-up character of the urban environment, which influence the five major microclimate components: air temperature, humidity, wind, radiation and precipitation. It has been found that air temperature, humidity and radiation are the variables most responsible for changing the urban climate, especially in tropical regions. In combination with other reasons, the lack of vegetation and lower albedo values are the major causes that are affecting the deterioration of urban environments. These two components can be modified in order to mitigate the UHI. Due to current UHI issues, and in conjunction with new city developments in Malaysia, Persiaran Perdana in Putrajaya has been selected as a case study.

Therefore, the actual UHI phenomenon in this area needs to be investigated. The surface temperature distribution that determines surface temperature UHI can be evaluated using thermal satellite images which allow cool and hot spots to be identified. Then, based on the highlighted areas, field measurement can be prepared in order to understand more about their relationship. Subsequently, from both results it would then be possible to spot those critical areas in the city in need of further attention in the form of heat island mitigation strategies.

The majority of the UHI's mitigation strategies studies claimed that by increasing the quantity of vegetation and albedo values there will be a resulting decrease in air temperature;

the suggestions was that this impact is truly significant even when only implemented within a small area. The cooling effect of vegetation can influence the immediate surroundings to a specified distance, which can be greater when the evapotranspiration process is higher. It primarily influences the air temperature and humidity level in urban environments. Importantly, previous studies indicate that performance of trees' cooling is depending on tree species and canopy density. These factors need to be further assessed in finding the optimum cooling from trees. The cooling process from different types of trees needs to be highlighted in order to distinguish the performance from each tree.

In addition; the cooling effect of trees can be enhanced by the variables in ground surface materials, i.e. types and colour of the materials, the values of emissivity and albedo surfaces. It is significant for the modification of both variables that there may be a greater influence of the air temperature, ground surface temperature, and cooling loads of the building, as well as on outdoor thermal comfort in urban areas. However, studies that focus on the modification of a combination of both vegetation and albedo physical properties in the context of tropical climate such as in Malaysia is still lacking, either from the human outdoor comfort perspective or from the building energy consumption point of view. Regardless, these types of studies have been performed in other climatic region (LBL, 1990). Moreover, implementation of actual trees physiology leads to mitigation measures in order to evaluate the actual per-tree cooling effect, especially in tropical regions, since there remain a lack from the measurement and modelling point of view. This despite a measurement study by Shahidan et al (2010) and a modelling study by Fahmy et al (2010). Therefore, both vegetation and albedo properties leading to optimum cooling need to be reviewed in order to enhance potential to optimise the impact of mitigation, and this will be further explained in the next chapter. Moreover, UHI measurement and mitigation with the integration of application measures using different methodologies are focused on and will be further explained in Chapter 4.

CHAPTER 3

REVIEW OF VEGETATION AND ALBEDO MODIFICATION: TOWARDS ACHIEVING OPTIMUM COOLING EFFECTS IN A TROPICAL URBAN MICROCLIMATE

3.1 Urban Trees and Ground Surface Effects in Urban Microclimates

The major climatic influences governing the distribution, abundance, health and function of plants are sunlight, temperature and precipitation. However, the impact of these factors varies according to scale; correspondingly vegetation itself exerts an influence on the climate (Wong and Yu, 2009). Therefore, it is necessary to explain the differences between macroclimate, mesoclimate and microclimate before further discussing microclimates and influence of vegetation. Stoutjesdijk and Barkman (1992) state that:

Macroclimate, which we may define as the weather situation over a long period (at least 30 years) occurring independently of local topography, soil type and vegetation ... The mesoclimate, or topoclimate is a local variant of the macroclimate as caused by the topography, or in some cases by the vegetation and by human action ... influences are strongest in the lower 2 m of the atmosphere and the upper 0.5 to 1 m of the soil. The climate in this zone is called microclimate (Wong and Yu, 2009, pg. 82).

In general, there is no contradicting the claim that the macroclimate governs the distribution patterns of vegetation all over the world. Types, species, growth rates and survival rates of vegetation are closely related to localised climate. However, the biological importance of microclimate over vegetation cannot be ignored. Normally, vegetation will adapt to the conditions (Wong and Yu, 2009); conditions determined by the microclimate conditions, which vary according to location and are defined by radiation, air temperature, humidity and wind factors. The microclimate governs the heat and water budget, the rate of evaporation and transpiration, and the texture and structure (leaf size, consistency, inclination, etc.) of vegetation. The growth of vegetation is

directly related to the microclimate in which it is planted. Therefore, microclimate conditions are the most important aspect of climate when determining how vegetation affects the urban environment and human comfort.

As predicted, research reveals that vegetation can have a positive impact on an urban microclimate. According to Katzshner and colleagues, the 'ideal' urban climate can be achieved by reducing air pollution and thermal stress by means of increased shadow, ventilation and wind protection (Katzshner et al, 2004). In particular; vegetation, especially trees, has great potential to minimise environmental problems such as thermal stress (Shahidan et al, 2010). Many studies have been conducted to measure and evaluate how trees can provide a significant impact on landscape character, as well as improving the microclimatic performance of built environments, adapting patterns to climate change, and reducing energy consumption and temperature control (Heisler, 1985; Akbari et al., 1997; Scott et al., 1999; Dimoudi and Nikolopoulou, 2003; Picot, 2004). The majority of these studies have found the physical aspect of trees (e.g. density, height, form and types of species) to be one of the paramount factors to consider when moderating microclimates for user comfort.

There are two mechanisms by which trees can offer cooling benefits in a city; i.e., direct shading and evapotranspiration (Wong and Yu, 2009). However, the effect does not result from cooling the air but from reducing the warming of the air (Kurn et al, 1994 and Dimoudi and Nikolopoulou, 2003). The shading effect of trees very much depends on the density of those trees (Brown and Gillespie, 1995 and Wong and Yu, 2009). Since the radiation factor is the most affected microclimate variable in a tropical climate, shade created by a tree canopy's foliage geometry could reduce glare and block the diffuse light from the sky and surrounding surfaces, thereby altering the heat exchange between building and ground surfaces. This condition will moderate solar heat gain through the evapotranspiration process of plants and the conversion of incident solar radiation to latent heat. In addition, the resulting lower radiation interception leads to reduced long-wave radiation emissions to the ground and a lower surface temperature, thus subjecting humans to a reduced radiant load (Dimoudi and Nikolopoulou, 2003; Wong and Yu, 2009; Shahidan et al, 2010). As a result, not only the shaded hard surfaces, but also the ambient temperature can be relatively low. This means that the UHI effect, with which

this research is most concerned, can be mitigated through these two simple yet effective mechanisms.

In this respect, the ability of shade trees to improve tropical outdoor environments is focused on the reduction in downward energy flow, particularly of visible light and solar infrared waves. This assists in radiation filtration by absorbing, reflecting and transmitting radiation (Brown and Gillespie, 1995 and Kotzen, 2003). This shade is created by two shading properties: large and small branches/limbs and leaf cover. However, the percentage of limbs and leaf cover varies across tree species and from tree to tree within the same species. It is noted that the shade performance of each species is different, and their effectiveness in filtering radiation will influence microclimate modification (Shahidan et al, 2010). Thus, it is important to investigate how a tree's physical characteristics can modify all microclimate factors; i.e., solar and terrestrial radiation, wind, air temperature, humidity and precipitation; especially during the hot season. For the purposes of this study, knowledge of how best to modify factors affecting the microclimate according to variations in the physical characteristics of trees (dependant on species) is of primary importance in promoting optimum cooling effects.

It is also relevant to consider here how the physical property of the street materials (i.e. albedo and emissivity values) could enhance the cooling effects of trees. Earlier studies have shown that use of appropriate materials, the so-called 'cool' materials, can improve thermal comfort conditions during summer or hot periods (Doulos et al., 2004). These keep surfaces cooler due to the lower absorption of solar radiation. They are good emitters of long wave radiation and release the energy that has been absorbed as short wave radiation (Doulos et al., 2004). The use of 'cool' materials in urban environmental planning contributes to lower surface temperatures that affect the thermal exchanges with the air (Akbari et al., 1992, 1997; Bretz and Akbari, 1997; Doulos et al., 2004). However, the ultimate cooling effects of both combinations on temperature reduction need to be investigated and further reviewed. Therefore, it is important for this study to consider both entities' physical characteristics, how they can influence microclimate modification, how far it can be modified and how each microclimate factor is affected.

3.2 Microclimate Modification

Microclimate is defined as the condition of solar and terrestrial radiation, wind, air temperature, humidity, and precipitation in an outdoor space (Brown and Gillespie, 1995). Microclimates usually occur in the layer near the ground that is affected by the ground surface and are normally created on each side of a building facing a different direction in areas protected by trees, or in a building's courtyard (Christensen, 2005 and Allaby, 2006). The microclimate can have a significant effect on the energy required to heat and/or cool buildings in the landscape and, in turn, influences the thermal comfort of people inside the buildings and within the landscape. All six microclimate components are important in creating and generating the ambience of a microclimate. Thus, the main reason for considering microclimates in urban landscapes is to create comfortable habitats for humans (Robinette, 1972; Brown and Gillespie, 1995; Kotzen, 2003). All components can be modified in order to create this vital environmental condition and to fulfil human comfort needs. Thus, 'microclimate modification' can be defined as manipulating or changing the energy of microclimate component by blocking, transmitting or adjusting the balance between the energy supplied and the energy that is needed by the consumers. Consequently, it can be significantly modified through such landscape components as vegetation in order to achieve a thermally comfortable outdoor environment (Brown and Gillespie, 1995 and Shahidan, 2008).

However, there are four main ways of modifying the microclimate through soft landscape elements, especially trees. Firstly, a microclimate can be adapted through wind modification. Secondly, it can be modified by changing the relative humidity. Thirdly, through management of incoming solar radiation and finally by controlling the terrestrial radiation released by the ground and other surfaces (Brown and Gillespie, 1995; Kotzen, 2003). Trees can have some effect on all these modifications; however, their most important effect is in modifying solar radiation and terrestrial radiation from the ground through the creation of shade (Brown and Gillespie, 1995; Kotzen, 2003; Shahidan et al, 2010). This being the case, tree radiation modification is a key factor in enhancing the cooling effect and surrounding air temperature reduction in urban areas. In fact, while other microclimate factors will also result in changing levels of radiation, a more detailed explanation of the modification effects of trees is needed so as to maximise their cooling effect in urban environments.

3.2.1 Solar and Terrestrial Radiation Modification

Solar radiation can be defined as radiation from the sun, whilst terrestrial radiation is radiation emitted by objects on earth (Brown and Gillespie, 1995). Solar energy arrives on earth over a range of wavelengths: ultraviolet, visible light and solar infrared (Figure 3.1). Ultraviolet wavelengths (10^{-8} m) are too short for our eyes to see and many of these photons are consumed by ozone in the stratosphere (Schmidt, 1979).

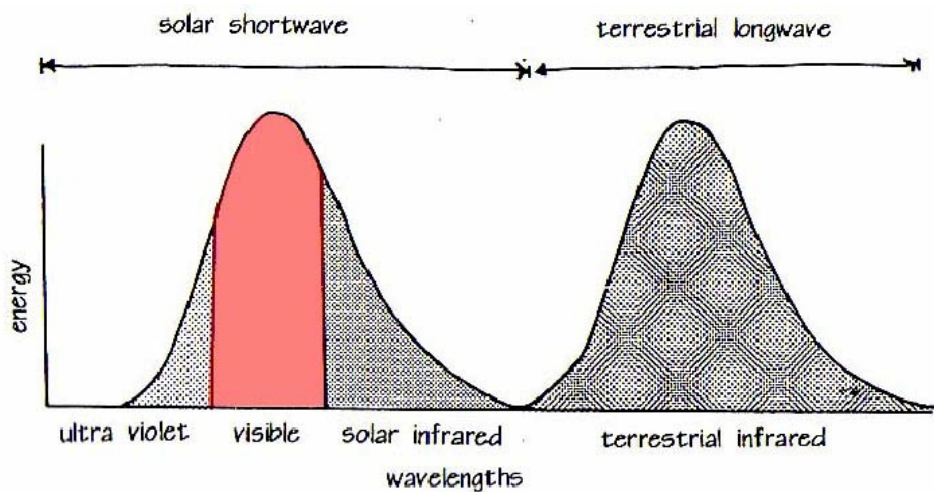

Figure 3.1 The solar (shortwave) radiation received by the earth and terrestrial (long-wave) radiation emitted by the earth (Source: Brown and Gillespie, 1995)

Much of the solar energy we receive is in the form of visible light and solar infrared. The wavelength or energy, which is termed 'light' (10^{-7} m) and can be seen, is also absorbed by the leaves of plants for photosynthesis. Solar infrared (10^{-5} m) is beyond the red end of visible light spectrum. Leaves cannot use this for photosynthesis and they therefore reject it via reflection or transmission. However, solar infrared does affect the energy budget for humans and buildings (Schmidt, 1979; Kotzen, 2003).

Single layers of leaves will generally absorb 80% of incoming visible radiation, whilst reflecting 10% and transmitting the other 10% (Figure 3.2). Approximately 20% of infrared is absorbed, with 50% reflected and 30% transmitted (Brown and Gillespie, 1995). Therefore, the percentage absorption for visible and infrared radiation is approximately 50%, with 30% reflected and only 20% transmitted. In addition, all trees can filter approximately 80-90% of incoming radiation depending on their leaf density, arrangement and type (Shahidan and Jones, 2008).

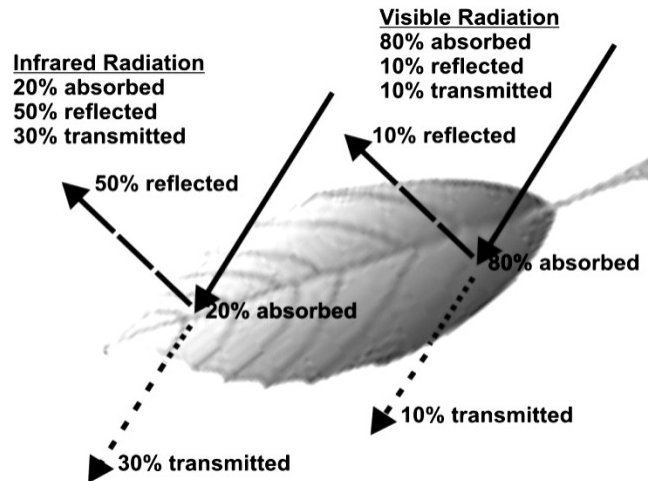

Figure 3.2 Leaf absorption, transmission and reflection (modified from Brown and Gillespie, 1995).

As indicated by Brown and Gillespie (1995), the amount of radiation intercepted depends on the density of the canopies, and may vary across species. Hence, this element would contribute to filtering the amount of light and radiation (Shahidan et al., 2010). It has been proven by Kotzen (2003) that light is reduced up to 95% in areas of shade caused by higher canopy density, especially in shaded areas or close to tree trunks. This is termed the transmissivity value of a plant. Specifying this value allows the identification of trees with a heavy or a light shade that is influenced by branching and leaf cover. The intensity of the shade and glare are influenced by light transmission underneath the canopy after absorption and reflection from the tree. Thus, the quality of tree shade can be determined through the solidness of shadow and the actual light transmitted underneath the canopy can be directly evaluated.

In addition, a previous background study has shown that high density foliage cover and a multiple layer arrangement of branches and twigs is important in providing the best radiation filtration in a tree canopy; typically up to 93% radiation interception (Shahidan et al., 2010). In fact, types, sizes and arrangements of leaves play an important role in improving efficiency in radiation absorption and reflection. This is commonly related to the leaf area index (LAI), which is defined as a dimensionless value of the leaf area per unit of ground area. It is the key measure used to understand and compare plant canopies (Steven et al., 1986 and Meir et al., 2000). By calculating this value, plant canopies across tree species, and across trees within a species, can be compared and evaluated. In addition, incoming radiation filtration is well correlated with both

transmissivity and LAI values and these evaluation methods can be used in determining the density of a tree canopy.

In respect to LAI values, the study found that the impact of trees, especially those with larger LAIs, were remarkable. Trees with high density (LAI = 6.1) produced only 7% radiant heat underneath the canopy, whilst trees with low density (mean LAI = 1.5) produced 21% of radiant heat. Thus, a higher density tree canopy that produces a low amount of radiant heat will result in the lowest amount of terrestrial radiation underneath the canopy. This condition will promote evapotranspiration, and the production of more latent heat helps decrease the surrounding air temperature and increase relative humidity. By warming the air less, cooling benefits can be obtained through high quality shade creation and incoming solar radiation interception. In other words, trees with high foliage density and multiple layers of branching are recommended to maximize the radiation interception and greatly modify the thermal heat underneath the canopy.

In addition, the cooling effect will be much greater when the amount of incoming solar radiation that reaches the ground can be controlled by any materials underneath the canopy. The incoming solar radiation reaching the earth's surface is subjected to reflection, absorption and transmission, dependant on the nature of the receiving surface. Generally, there are two significant factors of equal importance: the albedo, the ratio of the amount of light reflected from a material to the amount of light shining on the material, and the emissivity, the ratio of heat radiated by a substance to the heat radiated by a blackbody at the same temperature (Wong and Yu, 2009). The former factor governs the absorption of solar radiation and the latter controls the release of long-wave radiation to the surroundings. Note that an object with a high albedo (near 1) is very bright and an object that has a low albedo (near 0) is dark. The 'cool' materials that are characterized by high reflectivity and high emissivity values can very perceptibly optimise the cooling effect in the urban environment. Firstly, the 'cool' material can reduce the temperatures of urban hard surfaces by absorbing less incident solar radiation. In fact, less long-wave heat will be released back to the surroundings and lower ambient temperatures can be achieved. Second, the generation of smog can be reduced due to the lower temperature induced by 'cool' materials and finally, buildings can experience extended lifetimes because they are not so readily stressed by excessive heat (Wong and Yu, 2009).

In the case of maximising the cooling effect, the reduction of temperatures due to less absorption of solar radiation underneath the canopy is of prime importance. In this respect, high quality shade trees are an important factor in the radiative exchange process of ground surfaces. Shading that can intercept and store heat from direct solar gains can lead to significant reductions in urban surface temperatures. The total radiation absorbed at a site can be manipulated by shading or changing the solar reflectivity (albedo) of objects. However, it can be noted that a combination of shading and the high reflectivity of a material could improve the cooling effect. As a result, this will decrease the intercepted solar radiation, reducing the absorption of excessive radiation and finally lowering the surrounding air and surface temperature.

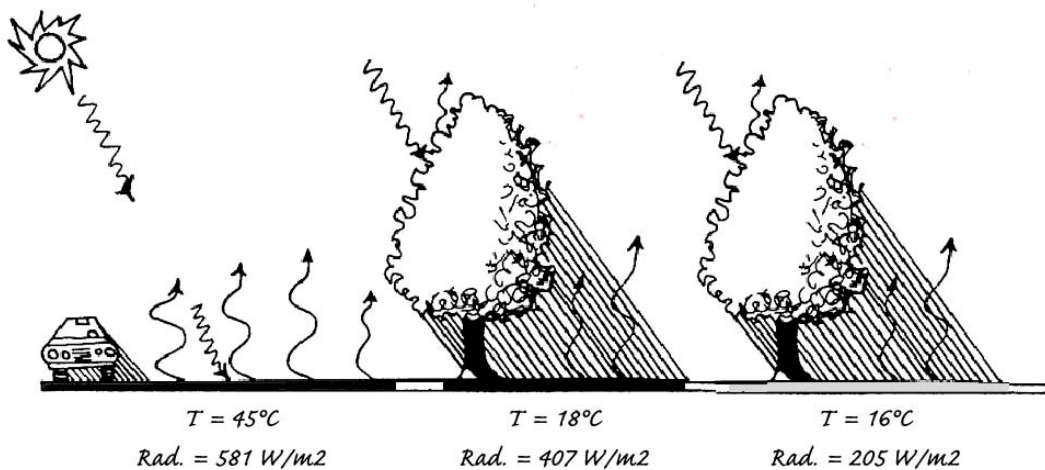

Figure 3.3 The differentiation on the impact of the shading with low and high albedos (Modified from Brown and Gillespie, 1995)

3.2.2 Wind Modification

Wind is one microclimate indicator that can be significantly modified by landscape components and, as such, it also strongly affects human thermal comfort, energy use of buildings, and the surrounding temperature in urban areas. It is a very important consideration in tropical outdoor environments. Although in a hot, humid tropical climate wind would carry heat away from people and buildings and thus strongly influence their energy budget, it is extremely difficult to visualize and even more difficult to control (Robinette, 1972; Brown and Gillespie, 1995). In contrast to radiation modification, wind velocity is more difficult to manage in urban areas compared to open landscape wind speeds; especially in the case of tree clusters, due to the drag force of plant canopies and variations in urban wind profiles (Brown and Gillespie, 1995; Dimoudi and Nikolopolou, 2003; Yoshida et al, 2006; Fahmy et al., 2010).

Generally, trees reduce the wind velocity and produce a sheltered area on the leeward side and, to a smaller extent, on the wind side of the screen. This reduction in wind velocity brings about a lowering of the rate of thermodynamic exchanges between air layers, with the result that protection from the wind generally permits a higher temperature to prevail in the protected zone. In different conditions, where there is free air movement, there is little or no difference between actual air temperatures in sun or shade. Nevertheless, under trees flanked by shrubs reflecting air currents upward, there will be cooler temperatures in the shade (Figure 3.4) (Robinette, 1972).

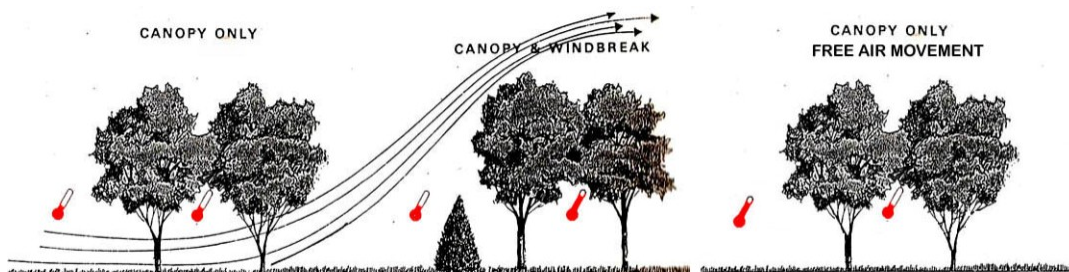

Figure 3.4 The impact of air layers movement influenced by trees and shrubs (left), Air temperature reduction under shade during free air movement (right)

In some cases, the effect of vegetation can be extended to the end of the site boundaries at the leeward side. In the case of a study by Dimoudi and Nikolopoulou (2003), wind was found to carry cool air from the park causing the air temperature to drop steadily, particularly in those areas parallel to the park. However, it can be noted that in urban areas with a higher building density the cooling effect will be decreased due to the immediate effects of the mixture of hot air from the buildings and cool air from the park. Respectively, within a dense urban texture the absolute minimum temperature is found inside the park, whilst for a loose urban texture it is found at the rear of the park. In contrast, when the speed is increased from 1 m/s at 1.5m above the ground (1 m/s to 2.4 m/s at the upper limit to the boundary layer) the effect of vegetation appears to be decreased due to the high wind movement above the ground. Although, the microclimate wind speed reduction is a disadvantage for the urban tree, this study shows that the existence of wind could enhance the distribution of a cooling effect from one area to another and is physically dependant on the density of the urban texture.

3.2.3 Air Temperature and Humidity Modification

Air temperature and atmospheric humidity cannot normally be significantly modified by landscape elements (Figure 3.5). The atmosphere is such an efficient mixer that any temperature or humidity differences that may occur are normally dissipated very quickly by air movement (Brown and Gillespie, 1995).

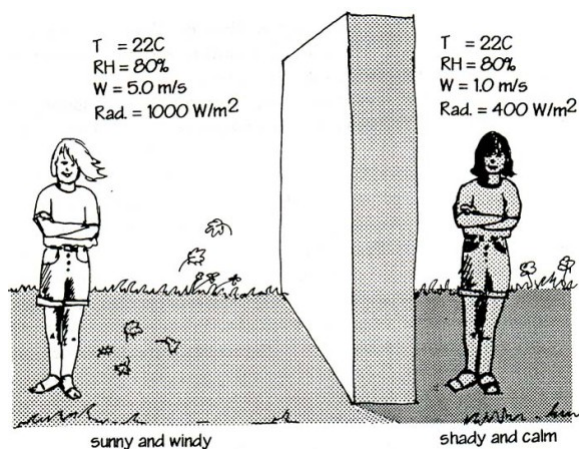

Figure 3.5 Of the four main microclimate factors that affect the streams of energy into and away from a person, only radiation and wind can be significantly modified by a landscape (Source: Brown and Gillespie, 1995)

However, humidity can be adjusted through the other microclimate components such as radiation and wind modification. As these modifications take place, trees can alter a microclimate through shading, wind shielding, evapotranspiration and photosynthesis (Robinette, 1972; Dimoudi and Nikolopoulou, 2003; Wong and Yu, 2009). As presented in section 3.2.1, high density can intercept and capture most of the incoming radiation. Despite a very small portion that is transformed into chemical energy through photosynthesis, most of the absorbed solar radiation can be modified to latent heat which converts water from liquid to gas. This condition, results in lower leaf temperature, lower surrounding air temperature and higher humidity through the process of evapotranspiration (Kurn et al, 1994; Wong and Yu, 2009)

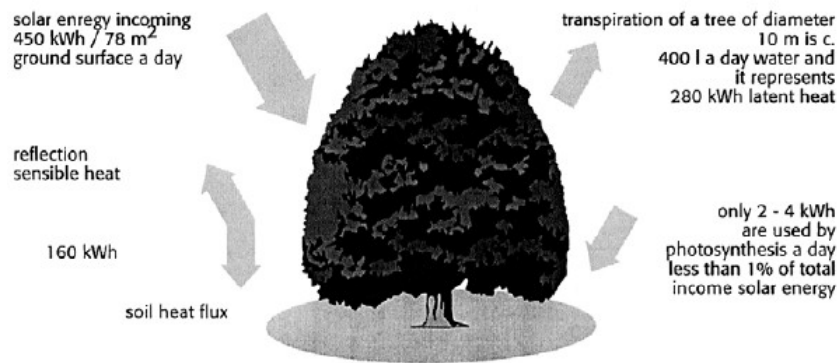

Figure 3.6 The cycle of transpiration and evaporation process on a single tree supplied with water

Generally, evapotranspiration (ET) (evaporation and transpiration) from soil-vegetation systems is another effective moderator of near-surface climates, particularly in a hot, warm and dry climate (Figure 3.6). Evaporation takes place from leaf surfaces and ground surfaces to the air (Dimoudi and Nikolopoulou, 2003), and transpiration from the soil through leaf stems due to the photosynthesis that circulates this system (Jacobs et al, 2003). The whole process can be explained through the energy budget of a plant (Jones, 1991) as follows:

$$\Phi_n - C - \lambda E = M + S \quad \text{Eq. 8}$$

where,

Φ_n = net radiation gain from radiation (short-wave radiation and long-wave radiation).

This is often the largest and drives many other energy fluxes.

C = net sensible heat loss, which is the sum of all heat loss to the surroundings by conduction or convection

λE = net latent heat loss, which is that required to convert all water evaporated from the liquid to the vapour state and is given by the product of the evaporation rate and the latent heat of vaporization of water ($\lambda = 2.454 \text{ MJ kg}^{-1}$ at 20°C)

M = net heat stored in biochemical reactions, which represents the storage of heat energy as chemical bond energy and is dominated by photosynthesis and respiration.

S = net physical storage of thermal energy, which includes energy used in heating the plant material as well as heat used to raise the temperature of the air.

Essentially, the energy transferred to latent heat through plants can be very high (Wong and Yu, 2009). For example, a study by Moffat and Schiler (1981) found that an average tree during a sunny day can evaporate 1460 kg of water and consume about 860 MJ of energy. Besides, a large tree with a crown diameter of 10 m (ground area 78 m²) is easily able to transpire 400 l day⁻¹ and afford latent heat exchange of about 278 kWh, if evaporation is calculated at 5 l m⁻² (Pokorny, 2001). The average cooling efficiency of a single tree transpiring water for about 12 h is 23 kW during 1 day. The perfect control system, such as a tree with 50-100 stomata on each mm² of leaf surface, can react individually to both internal water system and external microclimate condition. One large tree has several billion stomata, as its leaf area is several times greater than the tree's projected ground area (a typical leaf area index of 3-6). However, the evapotranspiration contributions of each plant varies and can be determined using estimates based on Reference Evapotranspiration, ET₀, which is the evapotranspiration rate of a reference crop under specific climatological conditions (Kurn et al, 1994). The evapotranspiration from a given vegetation type, ET_C, is determined by multiplying ET₀ by a crop coefficient, K_C:

$$ET_C = K_C * ET_0$$

Eq. 9

However, it should be noted that the use of crop coefficients in urban areas is complicated. Nevertheless, rough estimates were made using estimates of urban land cover and average crop coefficients (Kurn et al, 1994). Based on 13 Basin cities in Los Angeles, the evapotranspiration amounts were determined by multiplying the average crop coefficients by the average ET₀ (Table 3.1).

Table 3.1 Monthly evapotranspiration (ET) for different land-cover types and for entire urban surfaces (Source: Kurn et al, 1994)

Cover Type	K _C	Percentage	ET (inches/month)		
			July	August	Sept.
Turf	0.80	13	5.8	5.6	4.4
Trees	0.50	10	3.6	3.5	2.8
Shrubs	0.40	4	2.9	2.8	2.2
Non-vegetated	0.00	73	0	0	0.9
Total	0.17	100	1.2	1.2	0.9
Specific Humidity (g/kg)*			6 – 24	6 – 23	5 – 19

* Specific humidity, if the water evaporated over one day, were confined in a column of air 500-2000 metres high. Actual contribution to specific humidity depends on mixing height and the rate of moisture depletion through advection and condensation.

Based on these findings; the contribution of evapotranspiration to specific humidity ranges between 5 and 24 g/kg. In this case, without considering the interaction of the removal effect on water vapour in the air; advection (horizontal transfer of heat by air) and evapotranspiration comprise the two dominant sources of urban moisture. In fact, the presence of vegetative cooling may be effectively determined through measurements of specific humidity or absolute humidity (Kurn et al, 1994, Spangenberg et al, 2008). Specific humidity is defined as weight of moisture in a given weight of air (g/kg), whilst absolute humidity is the weight of moisture in a given volume of air (g/m^3) (Konya, 1980). Both terms are used to express the moisture content of the air. Thus, the variation contribution of evapotranspiration for each plant can be easily determined by measuring the increased moisture content in the air. In fact, this measurement will determine the effect of trees on microclimates and the greater effect will decrease the urban temperature and increase the relative humidity.

Considering other factors; ground surfaces that are covered with plants have a different Bowen ratio, which is the ratio of the sensible heat flux to the latent heat flux, compared to a mineral surface (Barradas et al., 1999; Wong and Yu, 2009). According to Santamouris (2001), the ratio in planted areas ranges from 0.5 to 2 when compared to a built environment, and is typically around 5 and up to 110 in a desert area. A lower Bowen ratio means that lower ambient air temperatures can be experienced when similar incident radiation is received by an area (Wong and Yu, 2009). This is due to the larger area of leaves that are effectively transforming solar heat gain. LAI can lie at up to ten times the surface values (Wilmers, 1990/91). In this case, LAI not only determines the incoming radiation interception through shading, but is also important in measuring the effectiveness on the urban cooling of different ranges of tree species through the evapotranspiration process. Therefore, the oasis effect (opposite to heat island effect), characterised by low ambient temperature, can be observed over an area covered with extensive plants and a variation of tree species.

3.3 Implementation of Tree Physical Characteristics for Optimum Cooling Effect

From the review presented in the previous sections, it is appropriate to assert here that the physical characteristics of trees are a key factor to be considered for the purposes of enhancing the cooling of urban environments. Tree canopy density, including foliage

cover, branching and twig characteristics, types of tree species and the height and width of the trees are all factors that need to be considered when modifying the microclimate and, ultimately, introducing optimum cooling effects. These factors need to be furthered explained from the implementation and measurement perspective as this knowledge is important for the research implementation and methodology.

3.3.1 Tree Canopies, Leaf Area Index (LAI) and Leaf Area Density (LAD)

As mentioned in the earlier section, thermal performance, shade effectiveness and evapotranspiration are based on the density of a tree canopy. The thermal performance and shade effectiveness depend on the foliage characteristics as well as a tree's mature shape; i.e. total height and canopy geometry (Scudo, 2002; Fahmy et al, 2010; Shahidan et al, 2010). On the other hand, evapotranspiration is dependent on the quantity of foliage that can absorb and transfer the energy to latent heat (water vapour). Both are closely related to Leaf Area Density (LAD) and Leaf Area Index (LAI); which are considered as conceptual environmental canopy modelling parameters for studying a tree's heat exchanges with environment, as they have significant role in urban heat balances (Jonckheere et al, 2004; Montes et al, 2007; Spangenberg et al, 2008; Fahmy et al, 2010, Shahidan et al, 2010). The modification in this value is believed to influence all microclimate factors (i.e. temperature, surface temperature, humidity, wind speed), thermal comfort, the energy performance of buildings and ultimately mitigate the UHI effect in urban area (Kotzen, 2003; Jonckheere et al, 2004; Montes et al, 2007; Wong and Yu, 2009; Shahidan et al, 2010; Fahmy et al, 2010).

As explained in the previous section, LAI is the key measure used to understand and compare plant canopies (Steven et al, 1986; Meir et al, 2000). By knowing this value, tree canopies across tree species and across trees within a species can be compared and evaluated. In this case, LAI can be measured, manually or by instruments. For example Kotzen (2003) used a scanner for LAI measurement, whilst the Plant Canopy Analyser (type Licor LAI-2000) and many other methods have been reported by others (Jonckheere et al, 2004 and Shahidan et al, 2010). Based on the previous background study, instruments such as Plant Canopy Analyser (type Licor LAI-2000) was used in evaluating LAI in two different tree species and the results are well correlated with

thermal performance of the trees (Shahidan et al, 2010). In this case, the instruments can be used later in this study to determine the LAI for selected tree species.

Besides, these values are important in determining the LAD of trees. LAD is a key parameter needed to model the radiation through a tree canopy and between a tree and its environment (Fahmy et al, 2010). It can be defined as the total one sided leaf area (m^2) per unit layer volume (m^3), in each horizontal slice along the height of a tree, providing an idea of vertical leaf distribution (Meir et al, 2000, Law et al, 2001). LAD modelling can be estimated by means of field measurements or using instrumentation in combination with empirical models (Jonckheere et al, 2004). For example, Mier et al (2000) and Pierce and Running (1988) used instrumentation for finding the LAD, whilst Stadt and Loeffers (2000), Lalic and Mihalic (2004) and Fahmy et al (2010) used an empirical model to determine LAD values. However, in this study the actual LAD values can be determined by actual LAI values from the field measurement based on Bruse (2008) and Lalic and Mihalic (2004) in simplified equations presented below:

$$LAI = LAD_z * dz \quad \text{Eq. 10}$$

where, LAD_z is the total LAD in one tree;

dz is the total height of the tree;

Therefore, in finding the actual LAD in z -height for one tree, Eq. 10 can be converted into:

$$LAD_z = LAI_z / dz \quad \text{Eq. 11}$$

This equation can also be useful in determining the vertical distribution of LAD for each height of LAD slice, z_p , and can be calculated by applying actual LAI values obtained from optical measurements (Bruce, 2008). In this case the intention is to use an analytical approach through the assumption value of LAI by Lalic and Mihailovic (2004) and Fahmy et al (2010). Therefore, each LAD slice, z , is divided according to 10 LAD profiles of $h/10$, where h is the total height of tree. Thus, Eq.11 can be rewritten as:

$$z_p = LAI_z / (h/10) \quad \text{Eq. 12}$$

Where, z_p , is the LAD value at height of LAD slice;

LAI_z , is the leaf area index at selected height, z ;

h , is the total height of tree;

Nevertheless, the value in each LAD slice, z_p , can be confirmed by summing up the difference LAD levels and compare with total LAI values of tree.

Based on the equations above, the LAD distribution and values of any type of tree can be estimated, providing requisite data required for any simulation based study. Thus, the knowledge of leaf area density identification will determine the thermal performance of each tree type and how much cooling effect it can offer to the environment.

3.3.2 Urban Trees Types, Trees Shades and Coverage

To understand further the physical characteristics of trees, knowledge of tree types is required to ensure implementation of the right selection of urban tree species. As mentioned in Wong and Yu (2009), urban greenery can be divided into two types, namely, natural formation and artificial formation. Natural formation in urban areas is found more on natural reserves, such as urban forest, whilst artificial formation is divided into two groups, i.e. landscape on buildings and landscape on the ground. However, as the main concern of the study is more on landscape at street level, landscape on the ground is the major focus. Landscape on the ground can be divided into city parks, neighbourhood parks and other green areas. According to the scale, city parks are features with a big area and they are normally owned and maintained by local government. Neighbourhood parks, normally smaller in size, are more flexible green areas in between developments (Wong and Yu, 2009). Other green areas, classified as smaller areas of landscape, occur in between urban spaces in forms such as plants in pocket spaces and courtyards and trees along roadsides. Except for aesthetic considerations, they are commonly created to protect specific locations (e.g. roads, pedestrian walkways, building spaces and public spaces), from excessive solar exposure, noise and wind etc.

In this case, implementation of small parks and green areas is a suitable solution to providing additional urban green spaces in existing cities and urban areas. It has been proven from previous studies that for every 100m² vegetation added to a park there results an average temperature reduction of around 1K (Dimoudi and Nikolopoulou,

2003). In addition, the increase of tree cover from 25% to 40% in the small pocket parks could reduce daytime UHI by a further 0.5°C (Giridharan et al, 2007). Thus, a modification of the quantity of trees could reduce the effect of UHI and therefore become an important mitigation strategy factor. However, in addition to tree quantity factors, the details of tree species and characteristics have not been explored widely, regardless of a study by Fahmy et al. (2010) in a semi-arid environment that introduced *Pelthophorum pterocarpum* (Yellow Poinciana) and *Ficus elastica* (Indian rubber plant). However, the data is limited to local climate conditions as the physical character of a tree is closely related to the localised climate under which it thrives (Wong and Yu, 2009). In this study, knowledge of tree characteristics in a tropical climate condition is of prime importance in offering the optimum thermal performance for the tropical urban environment.

A tropical environment, which is warm and humid and experiences excessive rainfall and considerable sunshine, provides ideal growing conditions for luxuriant tropical plants and tropical rainforests. Evergreen trees are in the majority in these climate regions. These types of trees, in comparison to deciduous trees, are in full leaf year round. Therefore, trees in this category will deliver the same thermal performance throughout the year. However, it depends on the climate conditions whether the performance is maximised. In other words, the sun angle, cloud condition, location and soil condition need to be taken into consideration to achieve the best effect. In addition, types of tree species and their physical form need to be considered for effective delivery of a greater amount of shading. It is evident from the previous background study that a tree's shadow production would involve the length and breadth of the canopy (Shahidan et al, 2010). This depends on the form of the canopy and branching of the species, growing location, the amount of leaf cover and the angle of the sun (Kotzen, 2003; Shahidan et al, 2010). In fact, in the tropics, the shade coverage condition is important during the middle of the day when the solar position is overhead and at its hottest. During this time, the shade is concentrated directly around the tree canopy. This contributes to an improvement in human comfort and the surrounding environment, especially in tropical regions where the sun is overhead for longer.

In reference to ECOTECH results, Shahidan et al. (2010) showed that from 12:00 to 13:00 hours (Lat. 03°N, Long. 101°E), the sun is overhead and the shade is concentrated directly around the tree canopy (Figure 3.7). At this point in time, the

shadow area will be almost equal to the planting area due to the solar height angle being close to 90°. This condition will lead to denser shadow due to higher filtration of incoming radiation, a decrease in light transmission and a reduction in surface temperature, and will thus encourage more evapotranspiration underneath the canopy. The effect will continue up to 14:00 hours as the shadow is still in the range of planting area with sun angle of 70° to 80° throughout the year (Figure 3.8).

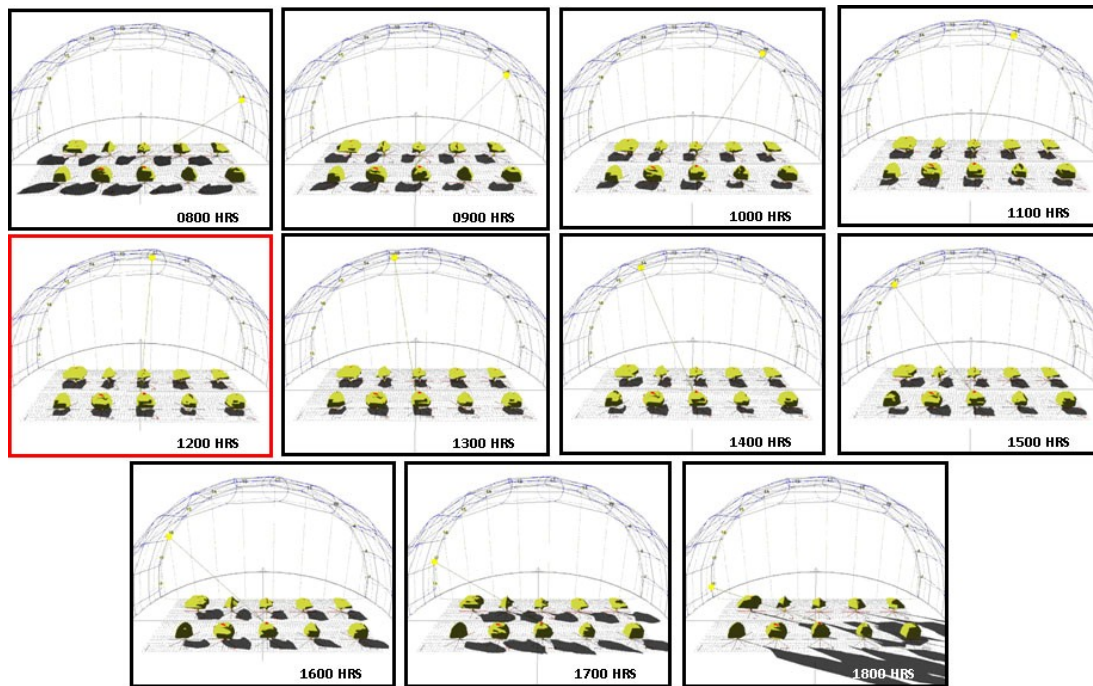

Figure 3.7 ECOTECT results show that, starting at 1200 hours the sun is overhead and the shade is concentrated directly around the tree canopy (Source: Shahidan et al., 2010)

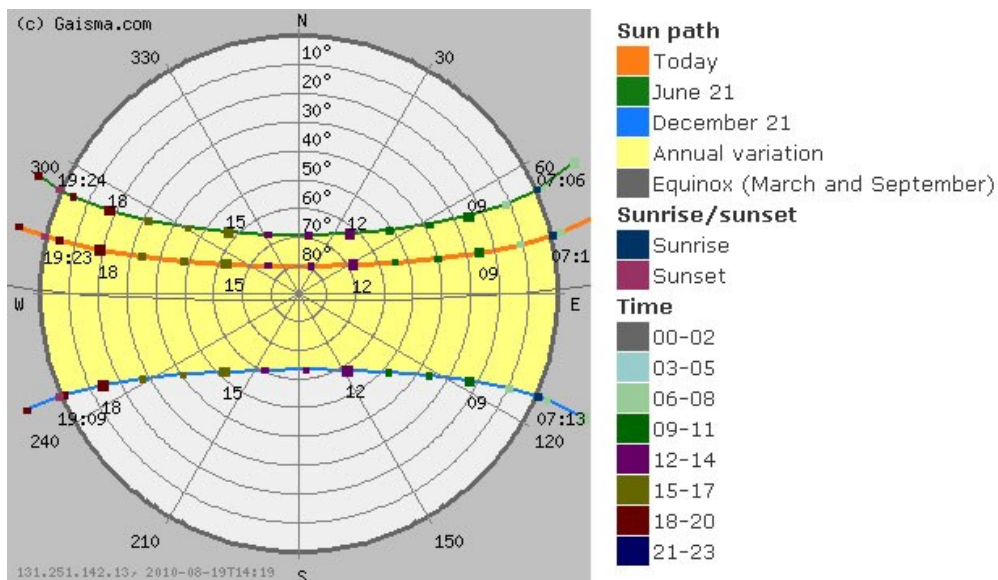

Figure 3.8 The sun path diagram shows position and sun angle at one hour time intervals (Lat. 03°N, Long. 101°E). (Source: Tukiainen, 2010)

However, the effects will be much greater when types and forms of the tree canopy are selected according to width rather than the height. This is due to the larger width of the canopies (e.g. ellipsoids – a geometric surface, all of whose plan sections are either ellipses or circles) (Mifflin, 2009) creating more shadowed areas and a wider shaded area that will increase the mitigation effect. This has been proven by Kotzen (2003) and a later study by Shahidan et al (2010) indicated that during the hottest parts of the day, i.e. when more shade is likely to be required, broad canopied trees create significantly more shade. As illustrated in Figure 3.9 and 3.10 broad/wide canopied trees generally provide more shade than a tall canopied tree. It also shows that generally broad shaped canopies create more shade throughout the whole day, especially at midday during summer months when the angle of the sun reaches almost 90°. When the sun is high in the sky the shade effect is concentrated directly around the canopy, thus this condition actually provides more shade during the hottest parts of the day when it is most needed (Kotzen, 2003).

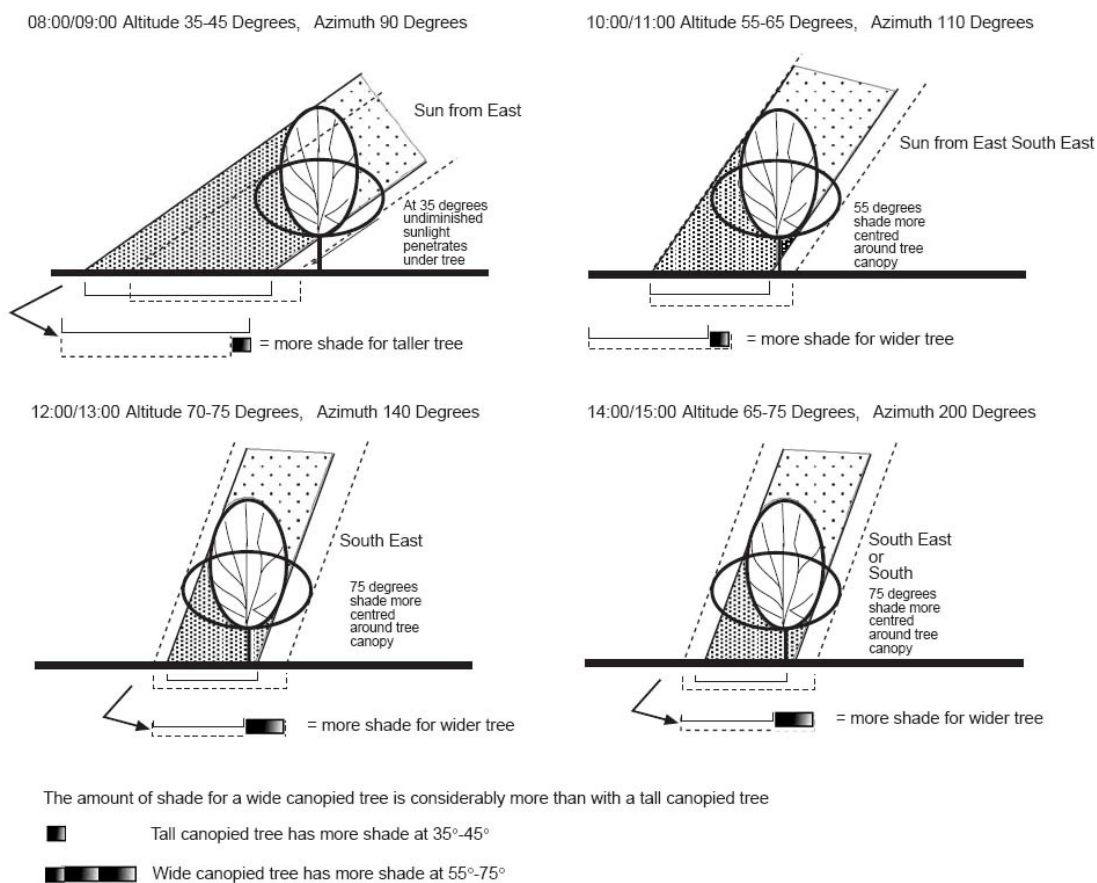

Figure 3.9 Comparison of the amount of shade created by broad/wide canopied trees in contrast to tall canopied tree (Source: Kotzen, 2003)

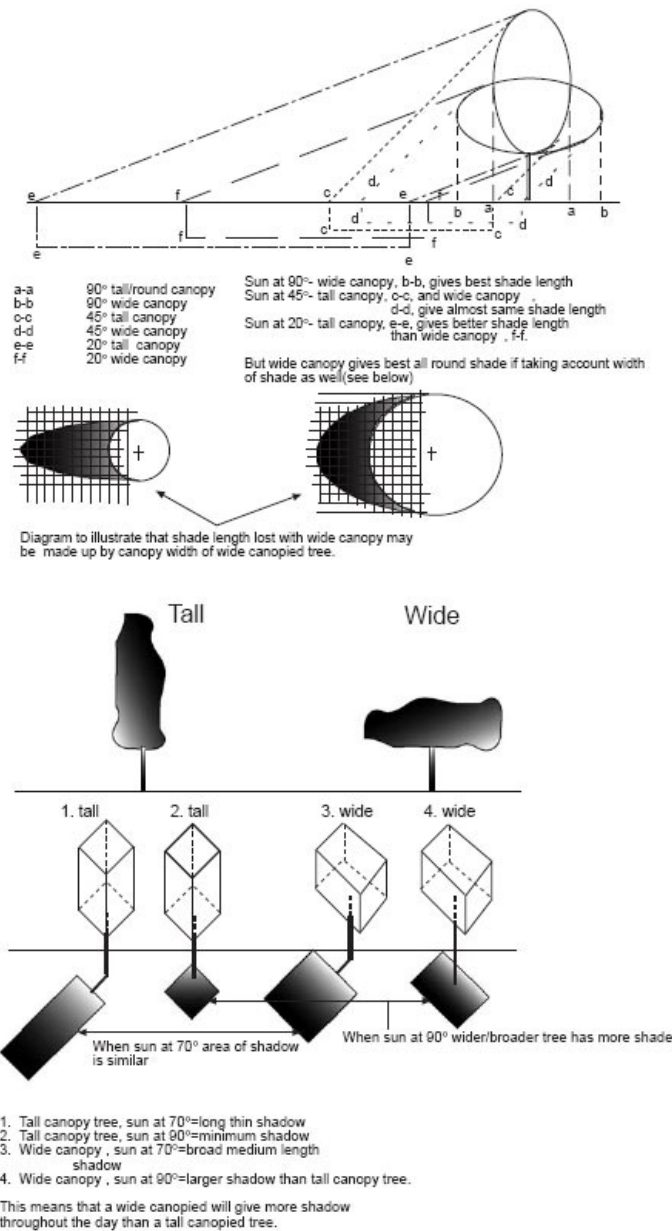

Figure 3.10 Relationship between shade and height/width of tree canopy (Source: Kotzen, 2003)

Trees with broad canopies provide a significantly better shade effect and this factor will influence the reduction in air warmth due to the larger shaded area effectively reducing ground surface temperature. In fact, the increase in area of latent heat production will also promote greater evaporation at ground surface level. Although this factor is one of the important aspects in promoting a better cooling effect, it has to be noted that tree density is the primary factor that needs to be considered before selecting a tree. Therefore, it can be concluded that tree species with high tree density (i.e. high foliage and branching density with multiple arrangement) and broader shape (e.g.

ellipsoids) are required to promote optimum cooling effects and these factors are of prime importance in selecting the right tree to mitigate the heat island effect.

3.4 Implementation of Cool Paving Material for Optimum Cooling Effect

As mentioned in the previous chapter, high albedo ground material is one major factor that contributes to the UHI phenomenon. Most of the previous studies have shown that urban areas have a very high percentage of paving and low amounts of trees and vegetation. One way to identify the percentage of hard surfaces in urban regions is by studying satellite images to identify land cover (Taha, 1997; Akbari and Rose, 1999; Rose et al, 2003). By using this method, we can describe and identify the percentage of hard surfaces, vegetation coverage, built-up area and bare lands quantitatively. For example, studies done using satellite images as a tool in four different land coverage patterns in Chicago, Houston, Salt Lake City and Sacramento revealed the average of land cover for all cities (Akbari and Rose, 1999; 2001a, 2001b; Rose et al, 2003). Looking down from above the trees, solid surfaces are found to cover more than half of these cities. The study found a total 56% of the land is covered by impervious surfaces, whilst trees cover only 12% and grass another 22%; thus, only 34% of the average city is covered by vegetation. As described above, pavement covers 25% to 50% of cities and is often the dominant feature in urban environments. Thus, the thermal characteristics of pavement have a lot of influence on the formation of heat islands and the material's physical properties at street level become a major concern in promoting an optimum cooling effect.

As described in section 2.1, the thermal performance of materials is mainly determined by their optical and thermal characteristics, namely, the albedo due to solar radiation and the emissivity due to long wave radiation being the most significant factors. Thus, the use of appropriate materials such as 'cool' materials, can improve thermal comfort conditions during summer and hot periods (Doulous et al, 2004). The properties of this type of material will reduce the amount of solar radiation absorbed by the building envelopes and urban structures and maintain cooler surfaces (Doulous et al, 2004).

However, based on the Oke et al.'s (1991) study that simulated the effect of the optical and thermal characteristics of urban materials on the heat island intensity during

the night period, the role of emissivity was minor. Specifically, they found that as the emissivity increased from 0.85 to 1.0 there was a slight increase of 0.4°C of temperature difference between the urban and rural environment for very tight canyons. However, the effect of the optical properties (i.e. albedo) of the materials was found to be much more important. In their study, Taha et al. measured the albedo and surface temperatures of a variety of materials used in urban structures during the early afternoon of a clear day in summer. They found that white elastomeric coatings with an albedo of 0.72 were 45 K cooler than black coatings with an albedo of 0.08. Meanwhile, the materials with white surfaces with an albedo of 0.61 were only 5 K warmer than ambient air, whereas conventional gravel with an albedo of 0.09 was 30 K warmer than the air. Thus, suffice to say that the albedo of materials is important in distinguishing the effect and defining the appropriate 'cool' material's characteristics.

The use of appropriate material in reducing UHI effect has gained interest and many research works have been carried out to identify the benefits when light coloured surfaces are used (Taha, 1997; Akbari et al., 1992; Santamouris, 2001; Doulous et al., 2004). Robinette (1968) reported relative air temperatures of 38°C over grass, 61°C, over asphalt and 73°C over artificial turf. In addition, Santamouris (2001) reported asphalt temperatures close to 63°C and white pavements close to 45°C. Berg and Quinn (Doulous et al., 2004) reported that in mid-summer white painted roads with an albedo close to 0.55 have almost the same temperature as the ambient environment, whilst unpainted roads with albedo close to 0.15 were approximately 11°C warmer than the air. Doulous et al. (2004) in their study proved that the physical characteristics of the material affecting its albedo (with almost all material emissivity are close to 0.9) are the colour, the surface texture and the construction material. The rough and dark coloured surfaces tend to absorb more solar radiation than the smooth, light coloured and flat surfaces. Thus, dark coloured surfaces are warmer than light coloured ones. Based on these reports, it is clearly shows that 'cool' materials properties are determined by their physical characteristics of colour, surface texture and construction material. Thus, these three factors are the major variables in surface materials that can be modified in changing the effect of an urban microclimate and, in combination with trees, will enhance thermal comfort and buildings' energy heat gain.

3.4.1 Ground Surface Physical Characteristics Modification

Generally, a ground surface with a 'cool' materials definition can be determined by its physical characteristics, for example its colour, texture and construction material. Thus, it is worth mentioning that these criteria can be modified accordingly in urban planning and implementation and planners should be more specific about which types of ground materials are to be used; e.g. ground pavements that can be determined as 'cool' materials based on these three factors. Indeed, one landmark study by Doulous et al. (2004) was used in this study to elaborate more on each of the 'cool' material characteristics, to determine what types of 'cool' materials can be used in modifying the microclimates by providing optimum cooling effects by reducing urban air and surface temperatures.

3.4.2 Construction and Material Texture

It can be observed that several construction materials commonly used in urban structure are asphalt, concrete, pebble and pavestone. These types of construction materials are used in roads, walkways, pavements, parking lots, greenways, parks, etc. Based on usage, the majority of construction materials can be defined as lower albedo or 'warm' construction materials. Based on the Doulous et al.'s (2004) study differentiating construction materials according to colour and material, it was shown that white coloured materials, specifically marble presented the lowest value of the mean daily surface temperatures. It can also be noted that the differences in the measured surface temperatures for the white coloured materials are due to surface texture. The smoother surfaced materials present lower surface temperatures than those with rough surfaces. In the case of black materials, asphalt had the largest surface temperature because of its rough surface. In addition, the same condition in surface temperatures can be observed in tiles made of pebbles due to similar level of roughness. In contrast, light coloured surfaces made of marble, mosaics and stone were found to be cooler than other materials (Figure 3.11).

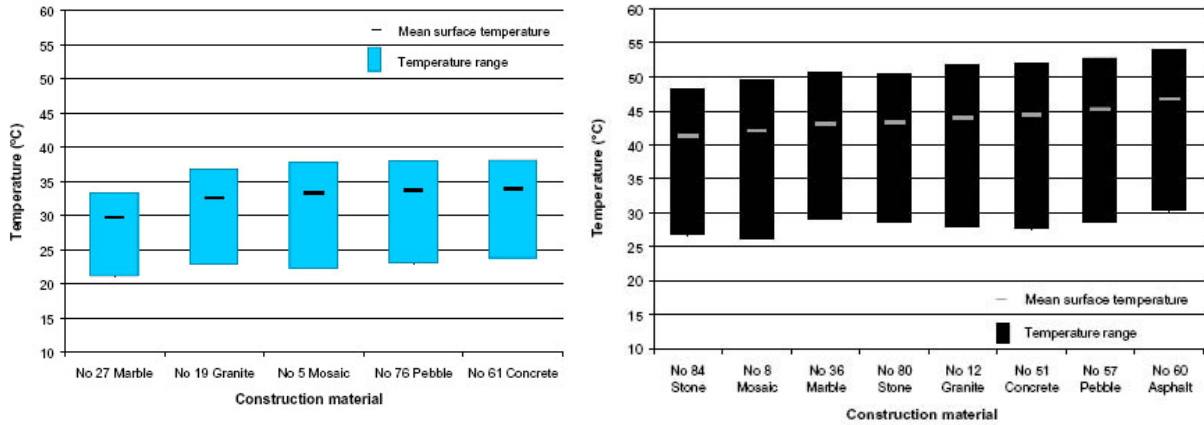

Figure 3.11 Comparisons of construction material based on colour shows marble is the coolest of the light coloured materials (left) and; asphalt and pebbles have among the highest surface temperatures for dark materials (right) – mean surface temperature and temperature range (Source: Doulos et al., 2004)

3.4.3 Colour

In observing the surface colour of materials, it can be seen that most of the colours that are used in urban materials are black, white, gray, red, brown and green. Material's colour can have similar reflectance; however, the performance is also dependent on its reflectance capability according to the lighter to darker range of colour. Dark coloured surfaces tend to absorb more solar radiation than light coloured material (Doulos et al, 2004, Akbari et al, 2006). Based on Doulos et al (2004) study, it can be seen that the mean daily surface temperature for white coloured material (i.e. marble) was 29.7°C and dark coloured material was 46.7°C (i.e. asphalt). In addition, they found that the absolute maximum temperatures were 33.4°C and 54°C for the same corresponding materials. Therefore, surface colour plays a significant role in reducing the higher range of surface temperature in an urban area. It can obviously be seen from the study that white coloured materials deliver the lowest surface temperature of any construction material. It gives a temperature range from 21°C to 38°C for materials with a white coloured surface, whilst materials with black coloured surfaces ranged from 26°C to 53°C. However, it is worth mentioning again that white marble was the lowest in surface temperature than any other materials within the surface temperature range of 21°C to 34°C (Figure 3.12).

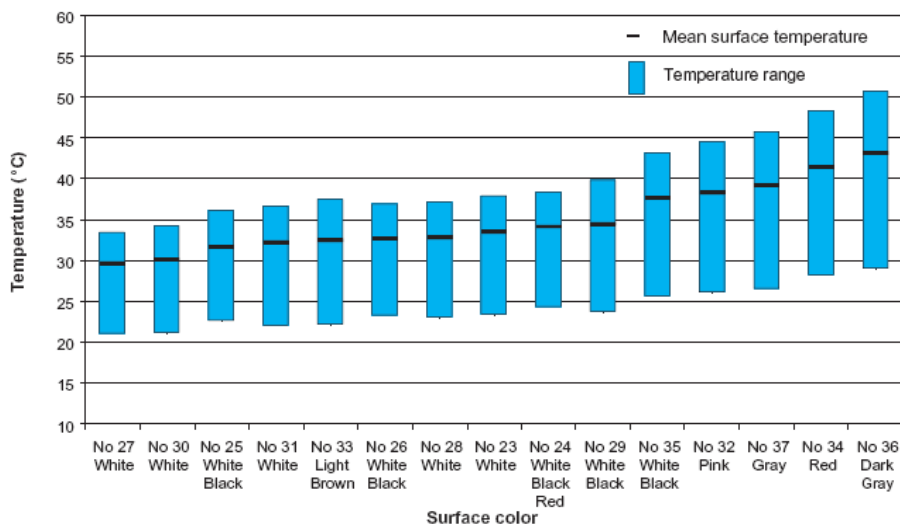

Figure 3.12 Comparisons of construction material based on surface colour and surface temperature (Source: Doulos et al., 2004)

3.4.5 Cooling Effect Performance based on ‘Cool’ Material Characteristics

As shown above, those ‘cool’ materials that can be characterized as those having a smooth and light coloured surface, and construction materials made of marble, mosaic and stone can be considered to enhance the cooling effect. The use of ‘cool’ materials contributes to the reduction of the air temperature due to the heat transfer phenomena (Doulous et al, 2004). These physical conditions will lead to lowering the surface temperature due to this type of material tending to reflect more heat than absorbed by its body mass. The reduction in surface temperature also reduces the intensity of long wave radiation. Local and downwind ambient temperatures would be lowered because of smaller convective heat fluxes from cooler surfaces. Such temperature reductions can have significant impacts on cooling energy consumption in urban areas, especially in urban tropical climates (Taha, 1997). In theory, the effect will much greater when these materials are used in combination with the planting of trees (Akbari et al., 1992). Alternatively, it should be noted that a combination of these materials with grass could enhance the effect of evaporation and maximise the cooling effect (Huang et al., 2008; Shashua-Bar et al, 2009). Although, grass has a lower albedo (i.e. 0.2-0.3) and the effect is only a smaller reduction in air temperature (Shashua-Bar et al, 2009), it can consume a large amount of water. This allows more water to be stored in the soil and, during dry

conditions, stored water evaporates and cools the pavements. Finally, it can be summarised that smooth and light coloured surface and construction materials made of marble, mosaic and stone can be considered to enhance the cooling effect. Thus, based on Doulos et al. (2004) the ‘cool’ materials can be easily selected according to the figures below (Figure 3.13).

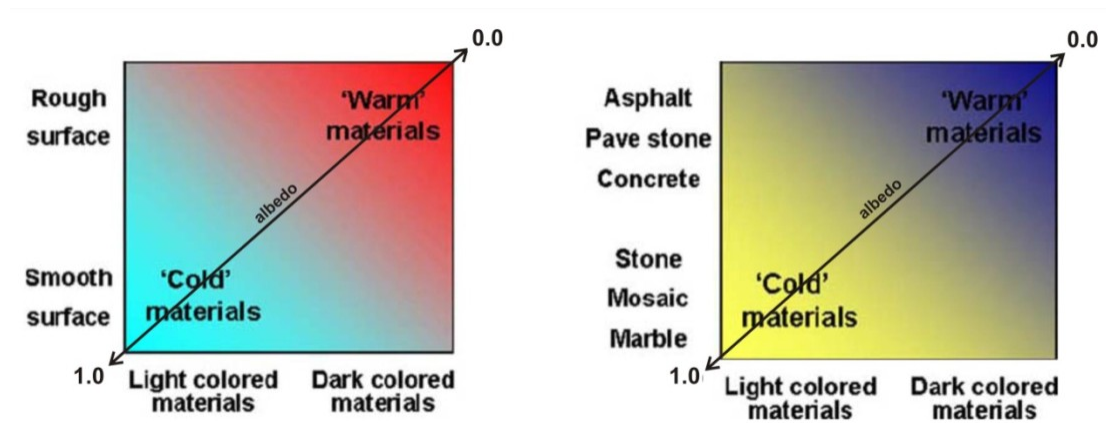

Figure 3.13 ‘Cool’ and ‘Warm’ material definitions based on physical characteristics and albedo values (Modified from: Doulos et al., 2004)

3.5 Combination of Tree and ‘Cool’ Materials towards Optimising Cooling Effect

As presented in the above literature, on the individual potential of tree and cool materials to maximise the cooling effect performance based on both physical properties that modify microclimate to a better environment, a combination effect from both entities is recommended for optimising the cooling effect. Thus; it can be summarised from the above findings that implementation needs to be taken into consideration in order to achieve desired optimum cooling in urban environments, as presented below:

1. As the radiation regime is the most important factor to be minimised in urban tropical climate environment, tree shading is most prominent in minimising the effect. Broad canopy with higher canopy density with consideration of LAI index values is recommended in providing large areas and a high quality of shade. Shading from trees could prevent direct radiation reaching building and ground surfaces. Thus, as mentioned in section 3.32, it is important to choose a tree species from a broad and high canopy density category to achieve the desired effect. By

choosing the right trees, the effect of radiation on the ground and building walls could be minimised to the optimum.

2. A combination of high density trees with cool materials placed beneath the tree will provide a significant reduction in surface temperature, due to the larger tree canopy allowing only smaller amounts of radiation to be absorbed by the cool materials. In addition, the physical characters of cool materials such as marble, granite or stone with a light colour and a smoother surface; representing higher albedo values will reflect more heat than that absorbed. The lower surface temperature will also allow reducing reduction in long wave radiation. The impact of cooling from cool materials will be much greater when larger types of tree coverage, of high tree canopy density, allow larger and higher quality of shading and radiation interception. Thus, cluster planting can be implemented for the purpose of maximising this impact. As a result, lower surface temperature and radiant heat beneath the trees will leading to a significant reduction in surrounding air temperature, improve the human energy budget and improve building energy consumption. Alternatively, the lower albedo materials can be replaced by cool materials in the open area; however, the impact is believed to be relatively smaller than when there is a combination with high canopy density trees.
3. Moreover, the above combination will allow more evaporation and transpiration from ground surfaces and trees leaves. The largest effect from the evapotranspiration process can be obtained due to the cooling effect of latent heat and evaporation from the ground, being affected by a lower absorption of radiation which could maintain the soil's moisture content during the hottest period of the day. Meanwhile, the larger leaf area of the higher density canopy will allow more transpiration, thus increasing the moisture content in the air. As a result, it is believed that higher absolute humidity could be achieved when both processes are operating. As higher humidity can be obtained from this condition, lower air temperature can also be achieved due to the higher moisture content of cool air mixed with reduced excessive heat in urban area.
4. As both tree and ground materials are considered for optimising the cooling effect, implementation on a larger scale of high density trees and cool materials could

modify the microclimate sufficiently. The implementation of this could cause extreme modification to all microclimate factors such as air temperature, relative humidity, wind speed, solar radiation and terrestrial radiation. However, a positive modification should be obtained from a combination of tree and cool material physical properties. Modification may also, therefore, mitigate UHI effectively and influence human outdoor thermal comfort and reduce cooling energy consumption in urban tropical climates.

3.6 Bio-climatic Influences from Trees and Cool Paving Modification

Generally, trees and cool paving affect urban microclimates on two levels: human thermal comfort and building energy budget (Miller, 1988; Santamouris, 2001; Emmanuel 2005a; Wong and Yu, 2009). According to Oke (1989), the important matter is not only what vegetation does, but also what it prevents; this being the heating up of urban canyons. Previous studies have shown that the reduction of urban temperature from the addition of trees and cool material modifications has a significance influence on both humans and buildings (Taha et al, 1988, 1994; Akbari et al, 1989; Rosenfeld, 1998; Akbari and Konopacki, 2005; Lin et al, 2010). The primary reasons for this are shading, radiation control and evapotranspiration from trees and cool materials. Improvement of microclimate factors, especially air temperature and radiation, via the planting of trees with the modification of cool materials in a tropical climate is a key strategy for providing better outdoor thermal comfort and improvements in building energy budget. Thus, it is also the intention of this study to measure the impact of both modifications on human outdoor thermal comfort and building's energy budgets in the tropical climate in question.

3.6.1 Human Outdoor Thermal Comfort

The American Society of Heating, Refrigerating and Air conditioning Engineers (ASHRAE) first introduced a definition of thermal comfort in 1966 as 'a condition of mind that expresses satisfaction with the thermal environment'. The factors which affect human thermal comfort can be physical, physiological and psychological adaptation. Adaptation can be defined as 'gradual decrease of the organism's response to repeated exposure to a stimulus, involving any action that makes them survive in such

environment' (Nikolopoulou and Steemers, 2003). Theoretically, physiological adaptation is a measure of the physiological responses due to repeated exposure to a stimulus, leading to a gradual decrease in strain from such exposure. This can be referred to as physiological adaptation in the environment context, whilst physiological adaptation refers to how different people perceive the environment in a different way and this adaptation influences the thermal perception of a space and the changes occurring in it (Nikolopoulou and Steemers, 2003). Aside from the psychological factors, thermal comfort is very much influenced by physical factors, including air and radiant temperature (i.e. air temperature is the degree of hotness or coldness of a body or environment, whilst radiant temperature is the uniform temperature of an imaginary enclosure in which radiant heat transfer from the human body equals the radiant heat transfer in the actual non uniform enclosure); wind speed and solar radiation towards their comfort levels. These factors are also considered to be dominant in a system's energy balance (Alexandri, 2005). From the perspective of physical adaptation, measurements typically investigate the changes that people make to either their environments or themselves in order to be comfortable (Nikolopoulou and Steemers, 2003). For example in personal reaction including changes of clothing level, posture and position or even metabolic heat with food and drinks consumption, meanwhile, in adaptation to environment they might alter their comfort by opening a window, turning a thermostat. In order to experience a sensation of comfort, human body temperature has to be maintained at a constant level internally (about 98.6°F/37°C). A constant human body temperature is achieved by continuous heat exchange between the body and its ambient environment. Generally, a thermal balance can be reached by releasing excess metabolic heat from the human body to the environment. This heat exchange process is based on five principles: conduction, convection, long wave radiation exchange, respiration and evaporation (Figure 3.14) (Wong and Yu, 2009). Based on Fanger (1970), the steady-state heat flow per unit area per unit time can be shown by the following equation:

$$H - E_d - E_{sw} - E_{re} - L = K = R + C \quad \text{Eq. 14}$$

where,

H = Internal heat production in the human body

E_d = Heat loss by water vapour diffusion through the skin

E_{sw} = Heat loss by sweat evaporation

E_{re} = Sensible heat loss by evaporation

L = Latent heat loss by respiration

K = Conduction from outer surface of the clothed body

C = Convection heat from outer surface

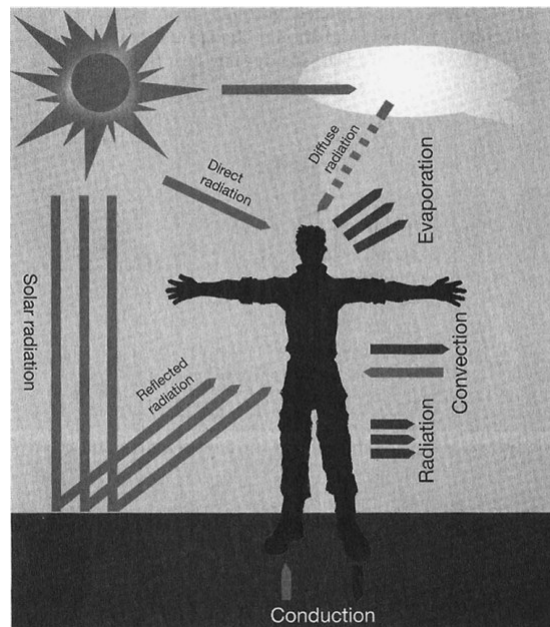

Figure 3.14 Thermal exchanges between the human body and surrounding environment
(Source: Wong and Yu, 2009)

In tropical conditions, due to high ambient air temperatures and relative humidity, certain parameters, such as E_d and L , are low or negligible. Conduction loss is also small unless the body is in a reclined position (Wong and Yu, 2009). Moreover, long-wave radiation exchange is considered insignificant for heat loss in most conditions when the temperature rises to 35 °C. In fact, this condition is closely related to the incoming radiation in the tropics, which is much higher than that experienced in temperate zones throughout the year; this situation increases the human energy budget in the outdoor environment (Shahidan et al, 2010).

Human discomfort in the tropics is closely related to the radiation regime. On a typical clear sunny day a person can receive as much as 1000W/m² of radiation; in the tropics this figure is obviously much greater (Brown and Gillespie, 1995; Grimme and Laar, 2005). In overheated periods, solar radiation can be quite extreme and create a significant strain on a person's energy budget. Thus, solar radiation needs to be controlled to significantly improve thermal comfort. In addition to modification to convection

processes by wind, changes in metabolic rate or clothing worn by the individual, landscape elements such as trees can influence the amount of solar and terrestrial radiation energy thus affecting energy budgets (Brown and Gillespie, 2005). In the urban environment, radiant temperatures varying according to shade, urban geometry, vegetation and the time of the year appear to cause the greatest variations in human thermal comfort (Emmanuel, 2005a, Shahidan et al., 2010). This variation is largely due to differences in the amount of solar radiation received by the person and partly due to the amount of terrestrial radiation received from the ground surface. In fact, these two conditions are mostly related to mean radiant temperature and the air temperature of the space. This is supported by Nikolopoulou's (1998) study that measured outdoor thermal comfort measurements in Cambridge concluding that both '*air and globe temperature have the biggest impact on the Actual Thermal Sensation Vote*' when these temperatures, wind speed and solar radiation are '*the most important parameters of comfort outdoors*' (Alexandri, 2005, pg. 433).

In the latter study in assessing thermal comfort models for open urban spaces in the RUROS project, Nikolopoulou (2004) pointed out that for a microclimatic comfort index, - shading conditions, radiative heat and vegetation distribution are the most important factors. As shade can block incident solar radiation, some studies have confirmed the importance of shading effect for outdoor thermal comfort on the urban environment. For example, street orientation and the height/ width (H/W) ratio have been measured to assess the shading levels in some studies (Johansson, 2006; Toudert and Mayer, 2006, 2007; Emmanuel et al, 2007), whereas the sky view factor (SVF) represents the shading levels in others (Dimoudi and Nikolopoulou, 2003; Giridharan et al, 2005, 2007; Hamdi and Schayes, 2007). In fact, in terms of people's behaviour in outdoors, 93% of people visiting a public space in summer in Taiwan chose to stay under the shade of trees or buildings, indicating the importance of shade in outdoor environments (Lin et al, 2010). Thus, it is believed that modification of thermal radiation influenced by tree and ground material modification could yield significant positive effects on human thermal comfort in tropical climates; in combination with changes to air temperature, humidity, solar radiation distribution and wind flow pattern. The assessment of outdoor thermal comfort before and after modification is important in order to best understand the impact of the improvements.

In the tropics, it is believed that people are able to tolerate much higher temperatures and humidity than those in the temperate region because of adaptation and acclimatisation (Wong and Yu, 2009). However, tolerance of outdoor thermal environments also varies for people in different climates, thus, individuals would not feel the same in the same thermal environment (Cheng and Ng, 2006; Nikolopoulou and Lykoudis, 2006; Lin and Matzarakis, 2008). It has been proven from previous studies that thermal comfort of people is based on the local climate they experience, even within the same tropical regions. For example, in Emmanuel's (2005b) study variations in indoor 'comfort' level conditions were found in the tropics. This research included figures based on Ellis (1952, 1953), who recorded 'neutral' temperature to be 26.1°C – 26.7°C in Singapore, Webb (1959) who recorded a comfort temperature of 27.2°C also in Singapore, Rao (1952) in Calcutta who recorded 26°C, and Nicol (1974) who recorded 31.1°C in Roorkee, India. Although all these studies have been performed in the indoor context, they provide evidence that the assessment of outdoor thermal comfort perception needs to be assessed based on local conditions and climate. In fact, a standard thermal comfort index for expressing the effects of radiation and air temperature on thermal comfort for outdoor spaces should also be used in order to assess local thermal comfort conditions.

In general, there are several integrating thermal environmental factors and heat balances that are applied to the human body to assess thermal comfort; e.g. predicted mean vote (PMV) (Fanger, 1972), standard effective temperature (SET*) (Gagge et al, 1986), OUT_SET* (Spagnolo and de Dear, 2003), physiologically equivalent temperature (PET) (VDI, 1998). However, whilst the PMV and SET* indices have a solid basis for indoor use, the OUT_SET* and PET indices have been primarily designed for outdoor use (VDI, 1998; Lin et al, 2010). PET is defined as the temperature at which, in a typical indoor setting (air temperature = mean radiant temperature, relative humidity = 50%, wind speed = 0.1 m/s), the heat budget of the human body is balanced with the same core and skin temperature as that found under complex outdoor conditions (Hoppe, 1999; Nikolopoulou and Lykoudis, 2006; Matzarakis, 2007; Lin et al, 2010). Therefore, PET enables a person to compare the integral effects of complex thermal conditions outside with his or her own experience indoors (Hoppe, 1999). Unlike other thermal indices, which are obtained from the human energy balance, e.g. OUT_SET*; PET offers the advantage of a widely known unit (degrees Celsius), which makes results more

comprehensible (Matzarakis et al, 1999). PET in different climate can be differed according to climate and geographical reason (Matzarakis and Mayer, 1996), as shown in Table 3.2. Thus, it worth mentioning that thermal sensation classification for summer in temperate and hot and humid in tropical climate could be subject to variation due to the different local adaptation and acclimatisation (Scudo, 2002).

Table 3.2 Relationship of PMV, PET and thermal sensation votes for temperate and tropical climate.
(Source: Scudo, 2002)

PMV	PET °C	THERMAL SENSATION European climate	THERMAL SENSATION Tropical climate	GRADE OF PHYSIOLOGICAL STRESS
		Very cold	Extremely cold	Extremely cold stress
-3,5	4			
		Cold	Very cold	Strong cold stress
-2,5	8			
		Cool	Cool	Moderate cold stress
-1,5	12			
		Slightly cool	Cool	Slight cold stress
-0,5	16			
		Neutral		No thermal stress
0,5	20			
			Neutral	
		Slightly warm		Moderate heat stress
1,5	24			
		Warm	Slightly warm	Strong heat stress
2,5	28			
		Very hot	Warm	
3,5	32			
			Hot	
			Very hot	

This can be expressed as a linear relationship with urban characteristics such as air temperature, mean radiant temperature (MRT), wind speed, vapour pressure, short and long wave radiation from the upper and lower hemisphere. This study shares interest with Alexandri's (2005) study focusing on air and radiant temperature; PET was derived from experiments during sunny, summer days in Freiburg, Germany (Matzarakis et al, 2002), as:

$$PET(T_a) = 1.354T_a - 5.0 \quad \text{Eq. 15}$$

$$PET(T_{mrt}) = 0.519T_{mrt} - 6.8 \quad \text{Eq. 16}$$

where T_{mrt} (Matzarakis, 2001; Nikolopoulou, 2004) is the mean radiant temperature, the uniform temperature of a surrounding surface emitting as a black body, which results in the same radiation gain of a human body as the prevailing radiation fluxes, which usually vary significantly in open spaces (Alexandri, 2005, pg 435). The radiant heat can be measured by using a globe thermometer and mean radiant temperature can be obtained from this result if air and velocity is known. By calculating the mean radiant temperature,

and thus PET, one is able to evaluate the direct effects of trees and cool material modification on thermal comfort in urban spaces. In fact, the Rayman model (a free software package) generated accurate predictions of thermal environments that can estimate PET directly based on the six most important factors: air temperature (T_a), relative humidity (RH), wind speed (v), human clothing and activity, mean radiant temperature (T_{mrt}) (Matzarakis et al, 1999; Gulyas et al, 2006; Lin et al, 2006; Matzarakis et al, 2007). PET factors can be estimated by importing the observed value of global radiation (Gr) or by importing the date and year, time, location and cloud cover (Cd). Thus, the evaluation of PET using the RayMan model (2007) is very flexible and practical (Lin et al, 2010).

In conclusion, the effect of tree shading and lighter albedo can be observed quantitatively by using the PET index to explain the consequences on human thermal comfort in the tropics. With further evaluation the results could be used to provide further understanding of the importance of tree and ground material physical characteristic modifications in respect of bioclimatic benefits, especially regarding the outdoor comfort of urban dwellers in the tropics.

3.6.2 Building Energy Savings

The impact of trees and cool materials on the energy consumption of buildings is very significant (Santamouris, 2001). Apart from creating a comfortable environment, especially in hot climates, trees and cool surface materials can also prove beneficial for indoor thermal conditions due to their microclimatic modifications that can significantly decrease cooling load demands inside the building. Generally, the building energy savings effect can be classified into two categories– i.e. (i) direct effect, and (ii) indirect effect. Direct effects refer to the cooling effect on individual buildings, whilst indirect effects refer to cuts in the air conditioning load as all buildings as the temperature of the surrounding area drops (Rosenfeld et al 1998).

As mentioned in chapter 2.6.4, in the tropical environment, air conditioning systems are the main consumer of energy due to the higher outdoor air temperature that influences the indoor temperature and human comfort. Direct effect from tree shading contributes by significantly decreasing the energy required for cooling. Shaded surfaces

have a much lower temperature and thus decrease the rate of heat convection. In the tropics, shading from trees is essential for reducing the impact of high radiation exposure on walls. Simulations studies, using limited numbers of building and tree configurations for cities across the USA indicate that shade from a single well placed, mature tree of about 8 m crown diameter, can reduce annual air conditioning use by 2 to 8% and the peak cooling demand by 2 to 10% (Huang et al, 1990; Akbari and Taha, 1992; Mcpherson et al, 1992, Simpsons et al, 1994). Parker (1983, 1987) reported that the average temperature of walls shaded by trees or by a combination of trees and shrubs was reduced by 13.5K to 15.5 K. In a later study by Papadakis et al. (2001) by using actual measurements it was found that plants shading buildings proved to be an efficient passive method of solar control and the evaporative cooling effect of the plants resulted in lower air temperature around the shaded wall with an increase of absolute humidity of about 1 to 2 kg water per m³ dry air.

In another study by Akbari et al (1992) the results of a computer simulation aiming to study the combined effect of shading and evapotranspiration of vegetation on the energy use of typical one-storey buildings in various US cities were presented. It was found that by adding one tree the energy savings ranged from 12% to 24%, whilst by adding three trees the effect ranged 17% to 57%. However, according to this study, the direct effect of shading accounts for only 10% to 35% of the total cooling energy, whilst the remaining result from temperatures was lowered by the indirect effect of evapotranspiration. On a larger scale, Wong et al (2007) proved that the indirect effect of dense compared to sparse greenery reduces buildings' energy usage by up to 5.43% when varying tree quantities. It can be seen that the effect of appropriate landscape modifications may be very important for the temperature regime around a building and that this effect could reduce the external temperature drastically when there is an understanding applied.

In addition, an increase in the surface albedo has a direct impact on the energy balance of a building. Large scale changes in urban albedo may have noteworthy indirect effects at the city scale. Numerous studies have been performed to evaluate the direct effects of albedo change and mostly demonstrate the benefits of using reflective surfaces. However, measurements of the indirect energy savings from large scale changes to urban albedo are almost impossible. Nevertheless, with an appropriate computer simulations

package a possible change in the urban climatic conditions can be evaluated. For example, Taha et al (1988, 1994) used one dimensional meteorological simulations to show that the localised afternoon air temperature on summer days can be lowered by 4 K by changing the surface albedo from 0.25 to 0.40 in a typical mid latitude warm climate. In a subsequent study, he used three-dimensional mesoscale simulation effects of huge scale albedo increases in Los Angeles to show that an average decrease of between 2 and 4 K may be possible by increasing the albedo by 0.13 in urbanised areas. In addition, the temperature due to these changes could reduce the electricity load from air conditioning by 10% (Akbari, 1989).

A combination of trees and albedo alteration has been studied for the purposes of quantifying the effect of both changes on the urban environment. Rosenfeld et al. (1998) simulated the impact of the use of increased urban albedo and tree planting in Los Angeles with the assumption that the city albedo increase by 7.5% when 5% of the area was covered with ten millions trees. The study found that the effect could benefit people by lowering the need for air conditioning by 18%, or 1.04 billion kWh, for the buildings directly affected by the roofs and tree shading. In addition, the indirect effect due to lighter roofing and the evapotranspiration effect from trees reduced the building's energy load by an additional 12% or 0.7 billion kWh, although the buildings were not shaded or with had a dark-coloured roof.

Akbari and Taha (1992) investigated the potential for using vegetation and high-albedo materials in several cities in Canada to modify the microclimate and ultimately save on residential heating and cooling energy use by using parametric computer simulations. Their study found that increasing the tree per house ratio by 30% and increasing the albedo from moderate-dark to medium-light colour by 20% would reduce the cooling energy by average of 30% to 40%. Both studies show that the effect on building energy's saving will be much greater with a combination of modifications.

However; most of the studies are literally focused on tree and materials quantities modification, whereas this study is focused on physical characteristics, density and quantities of trees and types of ground surfaces affecting the direct and indirect effects towards building energy savings in the tropics. Thus; as referred to in earlier studies, it is important for this study to use a suitable computer simulation package when evaluating

both effects (i.e. direct and indirect) on individual buildings and large cities. In fact, the simulation package has to consider tree shading effects and the affect of external-internal temperature. It is believed that by understanding the effect on buildings' energy savings as a result of the physical characteristics modification, new guidelines mitigating the urban heat island effect can be validated and developed for future use, especially in hot climate such as in the tropics.

3.7 Summary

Theoretically, it has been proven that trees and ground materials can be modified and that these modifications affect the urban microclimate environment, potentially mitigating the UHI effect by lowering air temperature and positively influencing human thermal comfort and reducing building energy consumption. By using tree physical characteristics; i.e. Leaf Area Index (LAI) and Leaf Area Density (LAD), together with more suitable forms of trees, the cooling effect will be much greater than simply randomly adding more trees to the urban environment. Besides, a combination of 'cool' materials with higher albedo values categorised based on physical properties; i.e. construction, types of surface and colour material could enhance the effect of cooling. The overall effect of both modifications will be to provide better radiation filtration, shading quality and promote significant increases in the evapotranspiration. Significant changes to the microclimatic conditions promoting the 'oasis effect' in cities will lead to better outdoor thermal comfort and energy savings. This chapter has summarised on how trees and ground material can be modified and combined in promoting optimum cooling effect. These combination modifications need to be further evaluated and quantified to confirm the impact towards the urban environment especially in the tropics. In addition to the actual bioclimatic influence, microclimate improvement needs to be fully justified in order to understand the importance of having combination of trees with ground materials physical properties modification to mitigate the UHI effect. Thus, to evaluate the overall effect, further research methods have been constructed based on previous work and this literature review.

CHAPTER 4

RESEARCH METHODOLOGY

4.1 Introduction

This chapter discusses the methods used to gather data for further analysis. In order to achieve the objectives of this study, the methodology was divided into three main sections: (i) UHI Mitigation Strategies Method; (ii) Outdoor Thermal Comfort Survey Method and (iii) Building Energy Savings Method. In the first section, the site study and climatic description was introduced to explain the current and climatic condition of the site. It was then divided into three sub-sections that discuss (i) the Remote Sensing Satellite Imagery Method; (ii) the Field Measurement Programme and (iii) the Computer Simulation Programme. The second section focuses on the description of the Outdoor Thermal Comfort Survey Method that includes the questionnaire survey, instrumentations and procedures. The third section examines the Building Energy Savings Method, divided into two sub-sections: (i) the Field Measurement Programme and (ii) the Computer Simulation Programme, which discussed the direct and indirect effect on a building's energy saving procedures.

4.2 Research Methodology Framework

The research methodology framework was designed to gather data systematically, using several of methods from field measurements to computer simulation programmes. All research methods were compiled in one complex framework that summarises the overall processes and procedures employed to achieve the research objectives and goals of this study (Figure 4.1). The research methodology framework was divided into four phases that were then integrated into one complex research methodology.

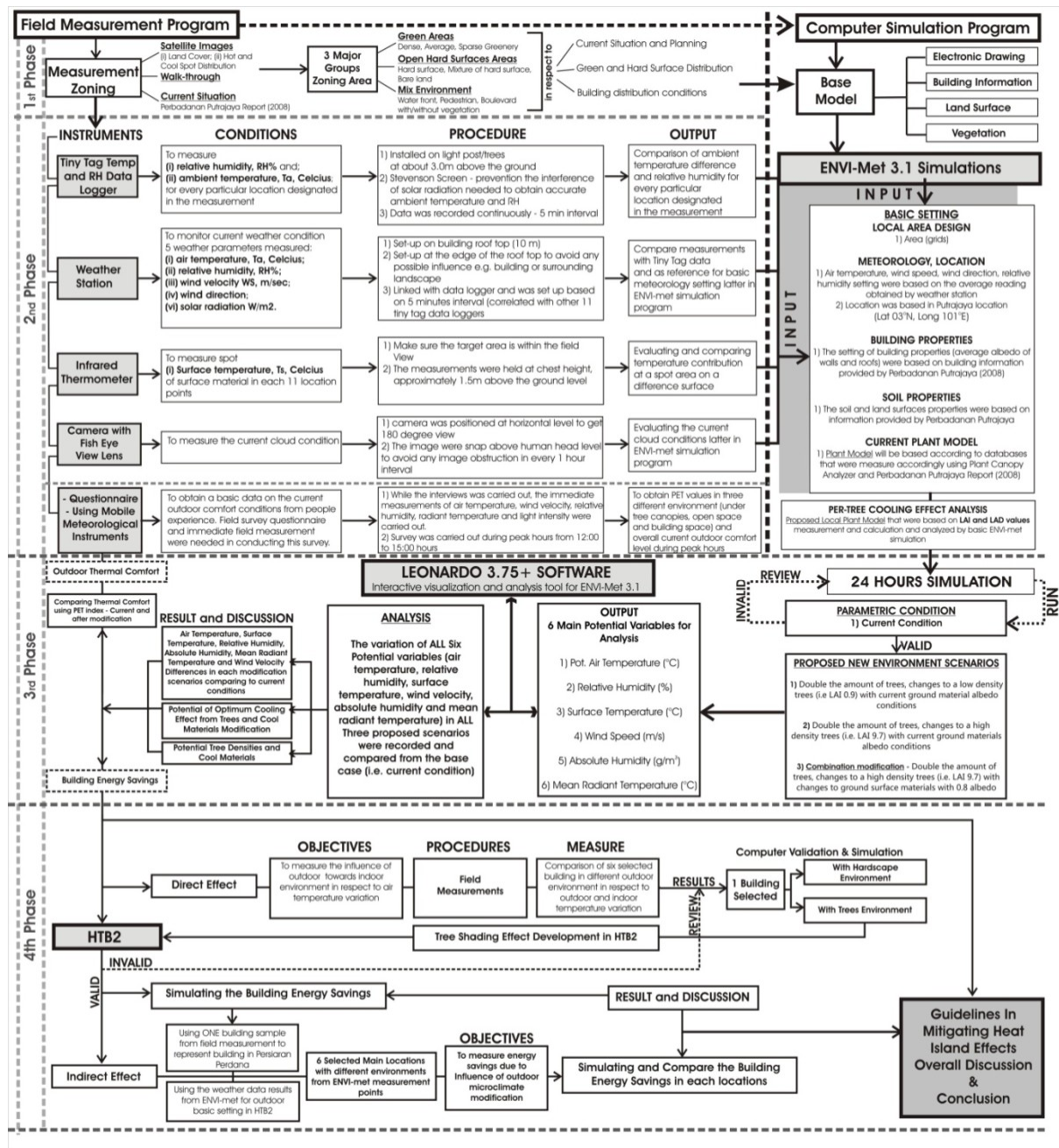

Figure 4.1 Research methodology frameworks

In the first phase, primary data collection was conducted by gathering information on the study site; such as satellite images, observation (i.e. walk-through), meteorological data, reports, building and electronic documents. Based on this data, a general idea of the current site conditions was generalised and categorised into three major groups with regard to the current situation and planning, green and hard surface distribution; and building properties and distribution. All information gathered in the first phase was therefore used later in the field measurement programme and the computer simulation programme conducted in Phase two.

In the second phase, the main process was divided into two programmes in which the first programme consisted of field measurements of current site conditions (meteorological measurement and an outdoor thermal comfort survey). The area in which measurements were made was divided into 12 location points based on the previous first phase's outcome. Meteorological data gathered in the field measurement programme and primary data from the first phase were used in the development of a computer simulation programme, which refers to second programme, using ENVI-met software. The base model domain was developed using electronic drawings, building information, vegetation and a land (ground surface) observation survey. The basic meteorological, plant, soil and building properties settings were based on the outcome from both field measurements and data gathering. A local plant model was developed during this phase in order to provide the actual plant conditions according to the local species and climate. In addition, the per-tree cooling effect prognosis measurement using the ENVI-met basic setting was used to predict the cooling performance of local species. All information set-up in ENVI-met was used in simulating Persiaran Perdana's current environment as a main model in predicting the later simulation of proposed different scenario conditions in Phase three.

In the third phase of the process, the main model domain in ENVI-met was simulated and validated to provide a reliable simulation output by comparing the measurement results from the field measurement in the previous phase. After the simulation was validated, the same main model domain was used to simulate three different proposed scenario conditions based on vegetation and ground albedo physical properties modification. The outputs from current conditions and three proposed scenarios were compared and analysed in order to discuss the outcome from each modification result. In confirming the benefit from the modification, beyond mitigating the heat island effect, the meteorological outputs from each simulation result were used in analysing the impact on the outdoor thermal comfort of Persiaran Perdana's users and building energy savings in Persiaran Perdana. The questionnaire results obtained from the outdoor thermal comfort survey conducted during the first phase were thus used to understand the outdoor thermal comfort level during the peak hour period in the Persiaran Perdana area. The outcome was subsequently used as a reference when comparing the outdoor thermal comfort level during the current conditions and after modification that was based on the meteorological output from the ENVI-met simulation. Besides outdoor thermal comfort analysis, the meteorological output was also used in

analysing the influence of outdoor microclimate modification towards building energy savings in Phase four.

In the final phase, the process was divided into two main methods, namely the direct effect method and the indirect effect method. In the direct effect method, the objective was to measure the influence of the actual outdoor landscape conditions on the indoor environment by means of field measurements. Field measurements were conducted in six different buildings with six different environments ranging from hard landscape (tarmac and paving) to extensive soft landscape (i.e. trees and grass). All six building measurement outcomes were compared in order to understand the influence of each landscape environment on indoor surroundings with regard to air temperature variations. One building was then tested and simulated with different outdoor landscape environments (i.e. 100% hard landscape and 100% trees and grass) using HTB2 model. During this stage, a tree shading mask was developed in order to assess the direct effect of tree shading on indoor environment using HTB2. The outcome was then compared with field measurements to validate the model. After the simulation was validated, the building was set up with services and operating input data and simulated to obtain the outcome in the building's energy savings performance. The building was then tested with the tree environment and further evaluated with trees at different distances in order to understand the direct effects of tree shading. To continue the process, the same building was used to evaluate the indirect effect of the outdoor landscape environment in Persiaran Perdana. By using the meteorological data output from current conditions and conditions in the modification scenarios, six significance points were selected from the previous 12 measurement points to simulate and measure the impact of microclimate modification on building's energy savings. The outcome was compared in terms of the percentage of savings by comparing each modification scenario to current conditions.

All results and discussions were compiled and summarised as guidelines for mitigating the UHI effect in Persiaran Perdana, drawing on findings obtained in each research phase and presented in the research framework.

4.3 UHI Mitigation Strategies Methods

4.3.1 Objectives

UHI Mitigation Strategies consist of three main methods: (i) remote sensing satellite imagery; (ii) the field measurement programme; and (iii) the computer simulation programme. The objective of remote sensing satellite imagery is to map the land cover classification of Persiaran Perdana and its surrounding area by means of satellite imagery. A temperature distribution map was subsequently produced to identify the 'hot' and 'cool' spots in the area of Persiaran Perdana. The field measurement programme was designed to measure the current microclimate conditions and the outdoor thermal comfort perception of Persiaran Perdana. The outcome from the field measurement was later used to provide a basic setting in a computer simulation programme and an outdoor thermal comfort assessment. The computer simulation programme was designed to simulate and validate the actual current conditions and to predict the modification effects from three different proposal scenario conditions by using ENVI-met modelling as a tool.

4.3.2 Study Site Location and Climatic Descriptions

This study was carried out on Persiaran Perdana, a public thoroughfare or boulevard measuring 4.2km long and 100m wide in the new federal administrative centre, Putrajaya, Malaysia. It is surrounded by a huge man-made lake that creates an island and is divided into three major precincts – i.e. Precinct 2, 3 and 4 (Figure 4.2). The area is located 25km south of the capital city of Malaysia, Kuala Lumpur (Lat. 2°55' N, Long. 101°42'E). The climate is hot and humid with an annual average temperature of 27.5 °C (with an average maximum of 33°C and minimum 22°C), annual average relative humidity of 62.6%, an average of 6.1 hours of sunlight per day and an average of 4.96 kWh/m² per year. Generally, the wind is light and variable with speeds ranging from 0.5 to 7.5 m/s, but wind movement is still weak and sometimes can be static (MMD, 2010, Azhari et al, 2008).

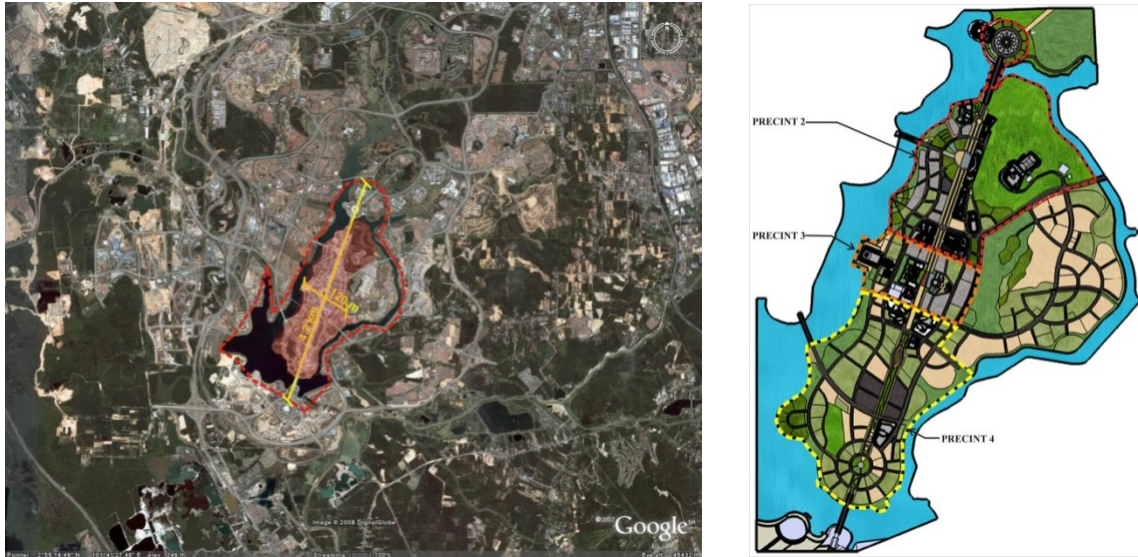

Figure 4.2 The overall site plan of 4200m x 100m areas (left); The site that comprises of three precincts – Precinct 2, 3 and 4 (left) (Source: Google Earth, 2009; PPJ, 2008)

Persiaran Perdana was only established in 2005 and is still undergoing minor development. It is currently dominated by five to 30-storey buildings built in hard surfaces along the boulevard surroundings. Most of the areas were designed with hard pavements and asphalts to provide a wide thoroughfare and the large spaces required for parades, public occasions and special events. Based on standard material albedo values from ENVI-met (Bruse, 2008) and supporting data from Perbadanan Putrajaya Annual Report (PPJ, 2008), the average albedo for Persiaran Perdana area ranged from 0.3 to 0.4 and was dominated by asphalt road and concrete pavement with average albedos of 0.2 and 0.4 respectively. This is due to the large open area in which asphalt materials are used for parking spaces. However, there are also public areas, i.e. squares and open spaces designed with higher albedo pavements such as white/grey granite and polished white granite with albedos of 0.65 and 0.8 respectively. Furthermore, for building properties the average albedo for walls is 0.3 and the average albedo for a roof is 0.5 (PPJ, 2008).

There is one major designated urban park located in Precinct 2 (Wawasan Park) with a land area of 52 hectares that acts as a major green lung within the core island of this area (PPJ, 2008). There are also small pocket parks, for example in the Mahkamah and Perbadanan area, designed as breathing spaces for the users in Precinct 3 and 4 (Figure 4.3).



Figure 4.3 The location of Wawasan Park and pocket park in Persiaran Perdana area (Source: Google Earth, 2009)

Most of the vegetation is dominated by drought tolerant trees on an ascending scale (6 to 15 metres) with an average age of 5 to 8 years. The vegetation comprises an estimated 30 to 40 main species. A mean leaf area index of the site was 2.4 (range 0.78 to 8.9, $n = 360$) as measured with the plant canopy analyser Licor LAI-2000 (LI-COR, 1992; PPJ, 2008). The main species in this area are *Mesua ferrea*, *Fragrea fragrans*, *Eugenia oleracea*, *Samanea saman*, *Mimusops elengi*, *Cassia fistula*, *Pongamia pinnata* and *Dalbergia oliveri*. As reported, root depth ranges from 1 to 2m with an average root zone depth of 1.5m (FAO, 1984; PPJ, 1999). Approximately 80% of soils in the area are classified by the Bungor series as fine sandy loam. The water field capacity of this soil is 216.7 mm/m with a wilting point of 66.7 mm/m. The difference between field capacity and wilting point gives the figure of available water of 150 mm/m for this soil (PPJ, 1999). However, a few areas are unsettled and have remained as bare land covered with grass or bare soil.

4.3.3 Remote sensing satellite imagery method

The land cover classification and temperature distribution of Persiaran Perdana and its surrounding areas (i.e. a 10 km radius) were analysed and mapped using satellite imagery.

Mapping was carried out to understand the impact of recent physical developments on the land cover distribution caused by changes of vegetation, building density and the use of the new materials on this site between 1994 and 2005. However, due to the limitations encountered in obtaining higher resolution and more recent satellite images (such as Landsat-7 ETM+), Landsat-5 TM satellite imagery acquired from the Malaysian Centre for Remote Sensing (MACRES) was used in this study. This satellite imagery was also used for temperature distribution mapping in order to visualise the 'hot' and 'cool' spot areas along the Persiaran Perdana area.

Land cover classification was developed along Persiaran Perdana and its surrounding area using an object-oriented classification method. This object-oriented approach involves two consecutive steps - firstly, a segmentation of the image, which breaks it down into a series of smaller image objects; secondly, classification of the objects recognised. Both of these steps were conducted using Definiens eCognition software. These land cover classification results were then further refined and mapped by using ArcGIS 9.3 (ArcMap) software.

Segmentation is the process of grouping adjacent pixels with similar spectral and textural characteristics. These groups of pixels represent meaningful entities or objects. As shown in Figure 4.4, there are five parameters influencing the result of image segmentation: scale, colour, shape, smoothness and compactness (Definiens 2007). This segmentation task was then followed by classification analysis using the object-oriented approach. This approach assigns image objects recognised during the segmentation process into user-defined classes. Meaningful classes therefore need to be developed before the image classification process can begin.

In this study, the steps described above were carried out and the following discussion highlights the procedures:

- (i) After undergoing several processes of trial and error and after examining numerous segmentations with different scale and shape parameters, the scale parameter of 10 was chosen based on how clearly and accurately the segments delineated the boundaries of the small and large objects visible in the image.
- (ii) Then, a simple class hierarchy was developed comprising three main classes of bare ground/built-up, vegetation and water.

- (iii) Based on the class hierarchy created, a rule-set for each class was developed in order to assign image objects to the appropriate class. An object-oriented approach was used within these rules.
- (iv) The result of this satellite imagery classification was then imported (in a polygon shape) into ArcGIS 9.3 (ArcMap) for further refinement and mapping. Figure 4.4 B shows the final output of the land cover classification along Persiaran Perdana and its surrounding areas.
- (v) The results were then merged with a report on quantification of areas and the land classification of Persiaran Perdana and were quantified in detail according to the percentage of land area.

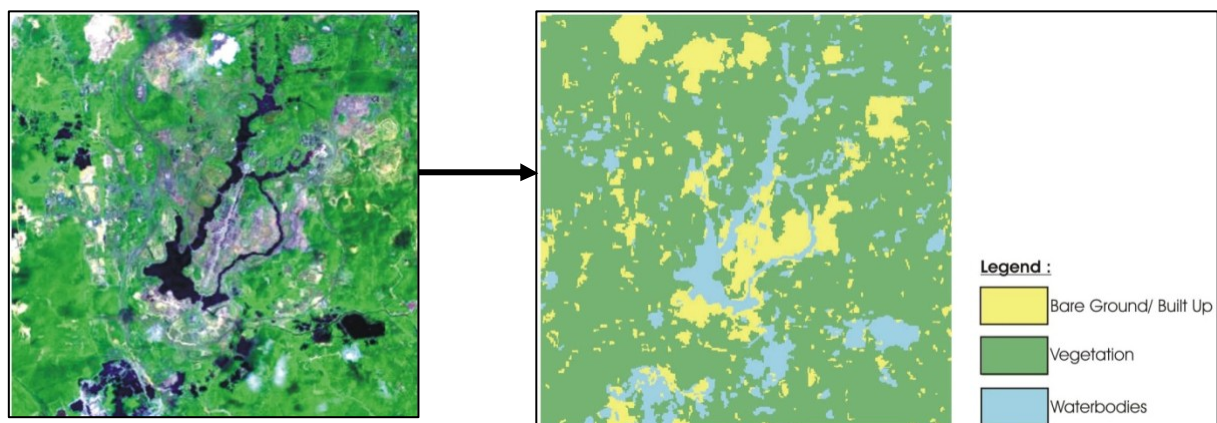

Figure 4.4 The Landsat 5 TM images (A) was analysed using eCognition and ArcMap and produced the final output images and percentage of land cover distribution (B)

The same satellite image was mapped using ENVI 4.1 which follows certain steps in obtaining the ‘hot’ and ‘cool’ spot distribution. The following steps highlight the procedures:

1. The satellite images were installed in ENVI 4.1 software and the images transferred to the colour mapping tool.
2. In this section, the input information about the colour mapping band according to layer properties was loaded by the author. The type of band (i.e. Band 5) and layer properties of 3: 4: 1 with standard colour scheme were chosen (i.e. red, green and blue) for temperature distribution classification.
3. The temperature distribution was then classified according to the variation in pixel information obtained from the satellite images. These groups of pixels represent meaningful entities or objects. The gradients of colours signified the variation of temperature range with ‘blue’ representing ‘cool’ to ‘red’ representing a ‘hot’ spot.

4. A temperature distribution map for Persiaran Perdana area was generated (Figure 4.5).
5. Lastly, the temperature distribution map was overlaid with the map of Persiaran Perdana (from Google maps) in order to gain a clear orientation of the overall temperature distribution in this area.

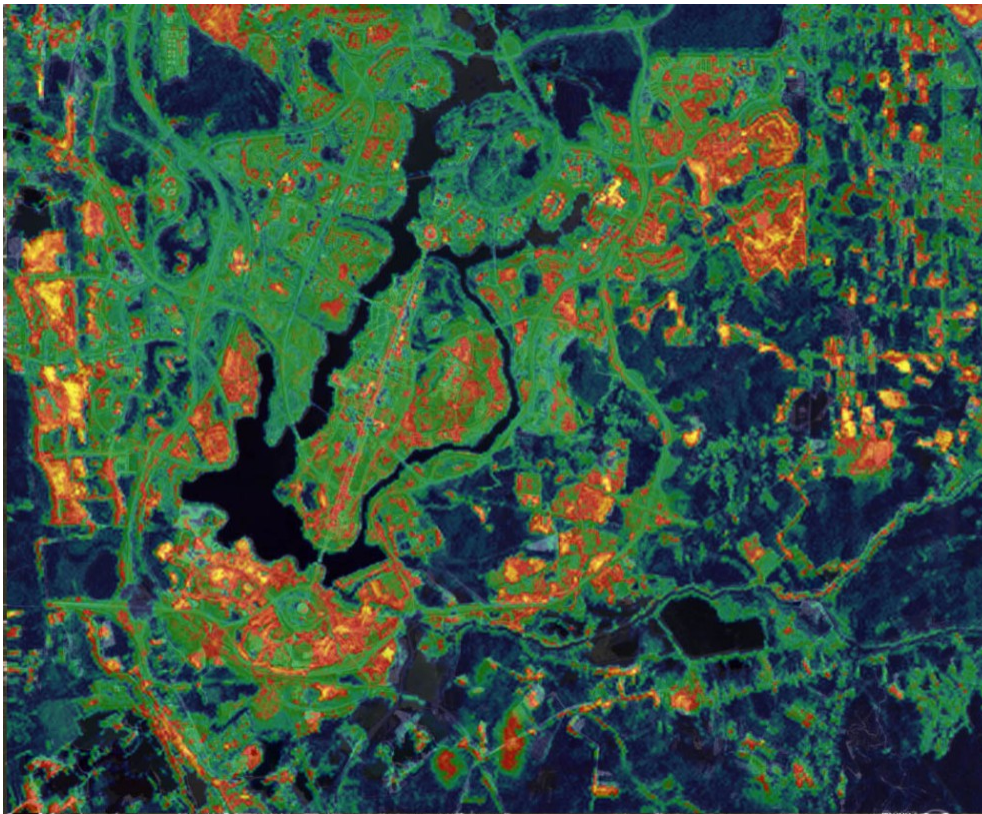

Figure 4.5 The temperature distribution map produced by ENVI 4.1

4.3.4 Field Measurement Programme

The field measurement programme was carried out to assess current air temperature (T_a), surface temperature (T_s) and relative humidity (RH%) at street level in selected points on Persiaran Perdana from February 1 to March 3 2009 in order to understand the current microclimate conditions at each point within the different landscape environments. The data were compared with data obtained from a temporary weather station located on the 10m-high roof top that acts as a reference for local weather and climatic conditions. As the Putrajaya area lacks a weather station, a temporary weather station was used to compare the urban-rural air temperature conditions in the Persiaran Perdana area over one month. Output from the weather station was subsequently required as a basic local meteorological input in simulating current climate conditions using the ENVI-met computer package. The results obtained from

each selected point were used to validate and in comparisons with the computer simulation output.

4.3.4.1 Measurement Locations

Based on the satellite image data from Perbadanan Putrajaya (2008) and walk-through carried out on 15 January 2009, the entire Persiaran Perdana area was divided into three major landscape environment conditions with regard to green, hard surface and building distribution conditions – i.e. (i) Green Areas; (ii) Open Hard Surface Areas and; (iii) Mixed Environment Areas. Each major landscape environment condition was divided into several location points representing different characters of landscape environment. These divisions were made to compare and understand the influence of different landscape characteristics on microclimate conditions, particularly air temperature, surface temperature and relative humidity distribution in Persiaran Perdana.

As shown in Table 4.1, the Green Area, representing areas dominated by vegetation, was divided into three location points – (i) area of dense greenery (Wawasan Park); (ii) area of averagely dense greenery (Mahkamah) and; (iii) area of sparse greenery (Perbadanan). In contrast, Open Hard Surface Areas represent areas were fully dominated by hard landscapes (e.g. pavement, asphalt) or bare land (grass or soil) that lacked any vegetation. They were divided into four location points – (i) high density hard surface (Putra Square); (ii) high density hard surface – parking area (P3P Road); (iii) mixture of surface area – pavement and grass (Rakyat Square) and; (iv) grass and bare land (Open Space). Finally, the Mixed Environment Areas, a mixture of vegetation, hard surfaces and water bodies, were divided into five location points – (i) near a body of water (P2N Road); (ii) boulevard – pedestrian area without vegetation (Perdana Boulevard); (iii) building entrance without vegetation but influenced by the building's shade (Wisma Tani Entrance); (iv) boulevard – pedestrian area with vegetation (Wisma Tani Building's Pedestrian Area) and, (iv) promenade with hard surfaces (Tunku Abdul Rahman Road) (Figure 4.6). One location for a temporary weather station pointed at the rooftop of the Perbadanan Putrajaya building. This building was selected for the measurement due to its location at the centre of Persiaran Perdana and its height of 10 m from the ground (correlated with the requirement of height for air temperature input in the ENVI-met simulation). These 12 location points were thus assumed to represent

the actual current microclimate distributions in Persiaran Perdana and weather stations the actual climate conditions in this area.

Table 4.1 Major landscape environments and selected location points for measurement

Location Number	Name of Area	Landscape Environment and Location Points
		I - Green Areas
1	Wawasan Park	Dense greenery area
2	Mahkamah	Averagely dense greenery area
3	Perbadanan	Sparse Greenery Area
		II - Open Hard Surface Areas
4	Putra Square	High density hard surface
5	P3P Road	High density hard surface (parking area – asphalt)
6	Rakyat Square	Mixture of surface area (Grass and Pavement)
7	Open Space	Grass and bare land
		III - Mixed Environment Areas
8	P2N Road	Near water body
9	Perdana Boulevard	Boulevard – pedestrian area (no vegetation)
10	Wisma Tani Entrance	Building Entrance (no vegetation but with building shade)
11	Wisma Tani Building's Pedestrian Area	Boulevard – pedestrian area (with vegetation)
12	Tunku Abdul Rahman Road	Waterfront and hard surfaces
13	Weather station	Rooftop

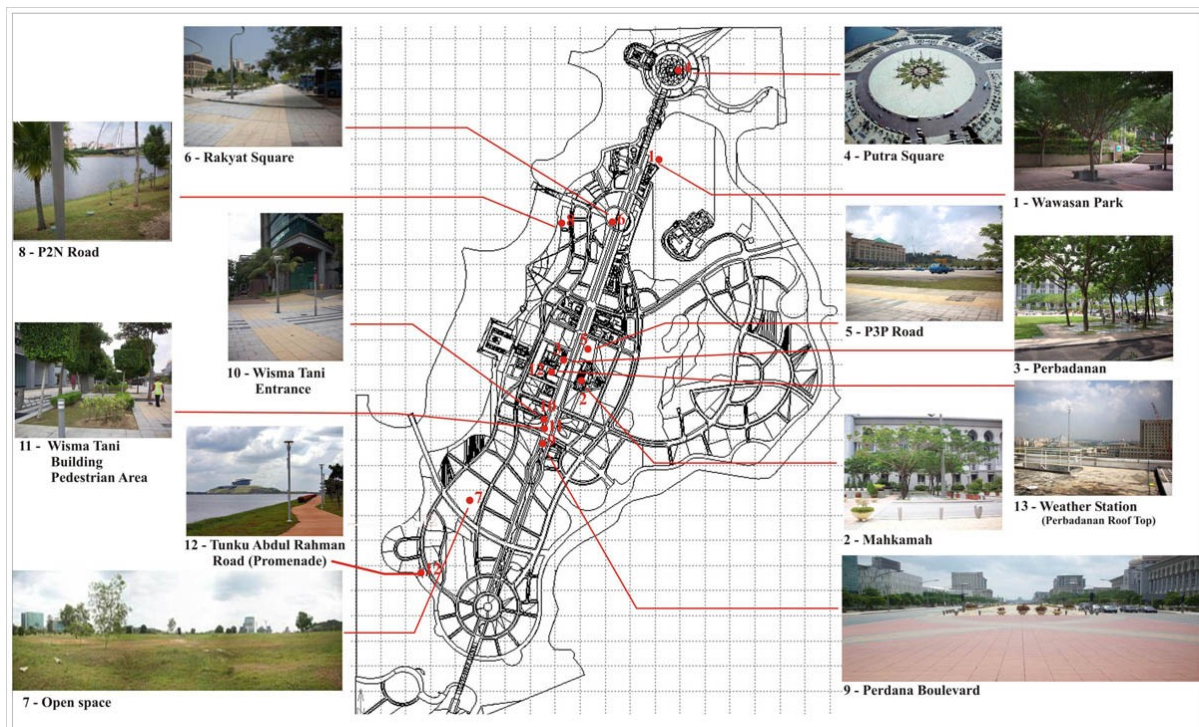

Figure 4.6 Twelve location points for field measurement with different landscape environments and one weather station location point

4.3.4.2 Descriptions of Measurement Points Locations and Landscape Conditions

4.3.4.2.1 Taman Wawasan (*Wawasan Park*)

The Wawasan Park area is dominated by high density trees with a quarter of the ground surface covered by red and white concrete pavement and the remainder with natural grass (Figure 4.7). The area was designed for recreational purposes; trees are therefore the major landscape element covering the entire 52 hectares of land. The LAI index for this area ranged between 4.5 and 8.9 LAI values due to its maturity and types of plants. Due to the large size of Wawasan Park, the location most closely representing this green area was chosen (i.e. near to the roadside) to complete the one hour surface temperature measurement cycles in each location point. Thus, in the location of the measuring point, the area was dominated by high density trees with a mean LAI of 6.1, with 50% of the ground surface covered by concrete pavement and the other half natural grass (Figure 4.8). The building adjacent to the park is the Kastam Diraja Malaysia (Malaysian Immigration) building with a 10 to 12-storey office block. The Tinytag instrument was installed on a tree trunk at a height of three metres.



Figure 4.7 Overview of Wawasan Park at Persiaran Perdana, Putrajaya

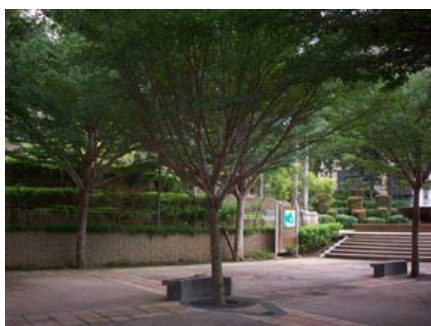

Figure 4.8 The location for the measurement point at Wawasan Park, dominated by high density trees and hard and soft ground cover

4.3.4.2.2 Mahkamah

The Mahkamah area was chosen as its location provides an area of averagely dense greenery. It was designed as a pocket space in front of the Istana Kehakiman (Palace of Justice) building (Figure 4.9). The area is dominated by 10 to 15-metre high *Samanea saman* trees (Rain tree). The mean LAI value in this area is 3.9. The ground surface of the area is covered with a red concrete imprint and polished white granite pavements with 1 m x 1 m and 3 m x 3 m grass underneath the canopy (Figure 4.10). The area provides seating for users underneath the tree canopy.



Figure 4.9 The Istana Kehakiman building with pocket park



Figure 4.10 The pocket park with averagely dense of *Samanea saman* trees (left); the combination of grass and polished white granite

4.3.4.2.3 Perbadanan

The Perbadanan location point was chosen due to its sparse greenery. Conditions were similar to Mahkamah but differed due to the sparse density of *Samanea saman* trees with a mean LAI value of 3.3. The area is dominated by a large area of lawn measuring 3136 m²

(Figure 4.11). It was designed as a pocket space with a seating area provided for users at the front of the Perbadanan Putrajaya building. The ground surface of the area is also covered with a red concrete imprint and polished white granite pavements with 1 m x 1 m and 3 m x 3 m grass underneath the canopy (Figure 4.12).



Figure 4.11 The pocket space in front of Perbadanan Putrajaya building with an area of sparse greenery



Figure 4.12 Pocket space *Samanea saman* trees with large turf area (left); Ground surface with combination of lawn and polished white granite provided with sitting bench

4.3.4.2.4 Dataran Putra (*Putra Square*)

The 300m circular Dataran Putra adorned with light and water features provides the centrepiece for Precinct 1. Dataran Putra is surrounded by Perdana Putra, Masjid Putra, Putra Bridge and the Promenade. The Dataran Putra area is mainly dominated by a high density of hard surfaces with a combination of white granite, red concrete imprint, yellow concrete pavement and tarmac with a 10% grass area (Figure 4.13). The area was designed as a square to complement the Masjid Putra (*Putra Mosque*) building and has become one of the main tourist attractions in Putrajaya. The location was conceived as a wide expanse of open space available to the public with a small number of trees planted around the area.



Figure 4.13 The overview of Dataran Putra area (left); the Putra Square dominated with hard paving (right)

4.3.4.2.5 P3P Road

The P3P Road is an open parking space currently used for visitor parking to Persiaran Perdana and is considered as high density hard surface. This area was 100% asphalt and located besides the Istana Kehakiman (*Palace of Justice*) building. There is no vegetation and no trees have been planted around the area, which is fully occupied with vehicles during office hours (Figure 4.14).



Figure 4.14 The P3P road fully asphalted due to its current function as a parking lot (left); the area was fully occupied with vehicles during office hours (right)

4.3.4.2.6 Dataran Rakyat (*Rakyat Square*)

Dataran Rakyat (*Rakyat Square*) is an informal plaza, conceived as a green breathing space situated in front of the Kementerian Kewangan (*Ministry of Finance*) building. The area was dominated by a combination of grass and pavement. The pavements were a

combination of white granite, yellow and red concrete pavement, and asphalt. A small number of trees were planted around Dataran Rakyat. However, the measurement location was focused on the area with mostly ground surface (i.e. grass and paving) in order to understand the contribution this makes to UHI formation in this area (Figure 4.15).

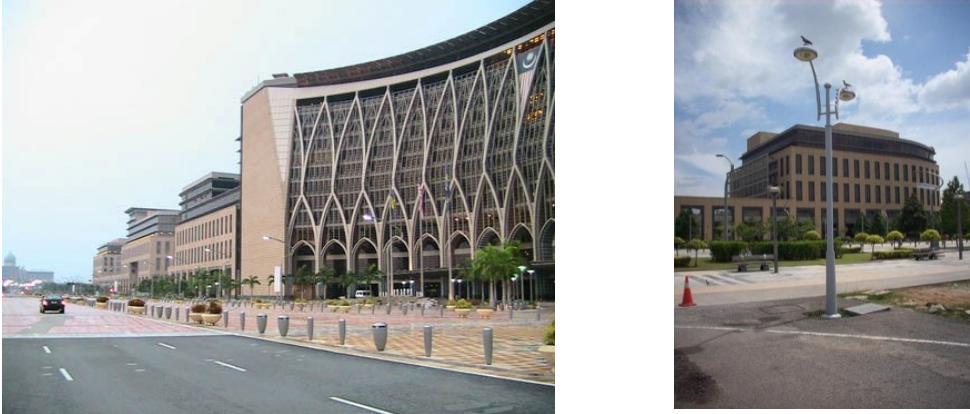

Figure 4.15 Dataran Rakyat located in front of Ministry of Finance building (left); the measurement area where there was a combination of grass and pavement (right)

4.3.4.2.7 Open Space

The open space was considered in the measurement location to represent bare land in the Persiaran Perdana area. It was dominated by a mixture of grass and bare soil. During the observation, field survey and satellite images, it was found that bare land in the Persiaran Perdana area dominated the land cover distribution (Figure 4.16). This was due to the currently undeveloped land that remained bare and was classified as private and waiting for buyers. According to the Perbadanan Putrajaya report, the land will be developed after it has been purchased by private buyers (PPJ, 2008). At the moment, most of the buildings in Persiaran Perdana are government buildings. It was therefore significant to obtain measurements at this location in order to understand the contribution of bare land to the formation of a UHI.



Figure 4.16 Open space with grass and bare soil representing bare land in the Persiaran Perdana area

4.3.4.2.8 P2N Road

The P2N was categorised as a mixed environment area due to its soft and hard landscape characteristics. The area was near to a body of water (Putrajaya Lake) with waterfront characteristics (Figure 4.17). The area consists of a hard landscape of asphalt and red concrete imprint pavement, with a soft landscape of grass and lone trees along the lake embankment. The site was chosen due to the fact that Persiaran Perdana was designed as an island surrounded by a man-made lake; thus, it was worth measuring whether the presence of large amounts of water could influence the cooling effect in Persiaran Perdana. The measurement location was 2.5 meters from the water's edge to measure the actual effect of the body of water within the measured area (Figure 4.18).



Figure 4.17 The P2P Road measurement point located near a body of water within a mixed landscape environment



Figure 4.18 The measurement location was located 2.5m from the water's edge

4.3.4.2.9 Perdana Boulevard

The Perdana Boulevard location point was chosen to represent the 4.2km public thoroughfare in the middle of Persiaran Perdana. The area was a mixture of hard landscape ground materials such as asphalt, yellow and red concrete pavement, white granite and polished white granite throughout the 40m–road’s width. The albedo value in this area was therefore lower due to the type and condition of ground surfaces. The area was designed without trees in the middle of the road due to the flexibility it requires both as a main road and stage for public events such as the National Day parade (Figure 4.19).

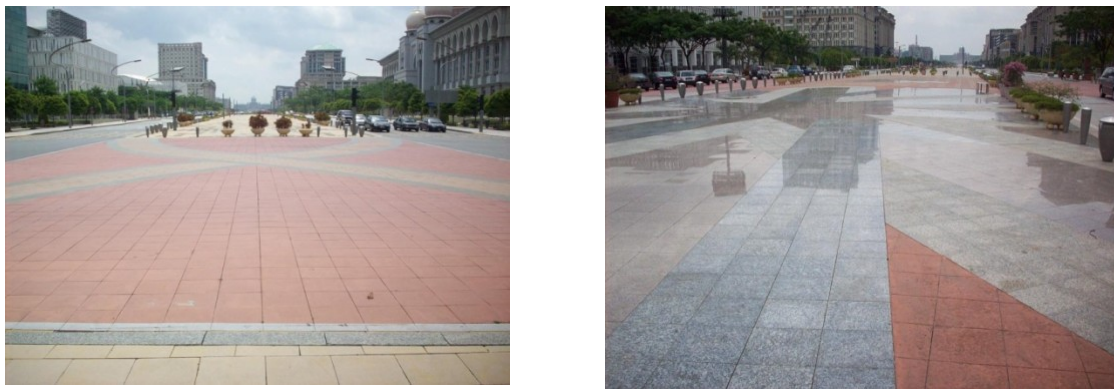

Figure 4.19 The Perdana Boulevard areas with a hard landscape of pavement and asphalt

4.3.4.2.10 Wisma Tani Entrance

The Wisma Tani Entrance was chosen due to its location near a building entrance and subject to building shade. Measurements were taken in an area without any vegetation was selected in order to measure the actual affect of building shade and the experience of the building users when entering and exiting the building. It was shadowed by the building from 14:00 hours onwards. The area was covered with yellow and white granite in front of the building entrance (Figure 4.20).



Figure 4.20 The Wis ma Tani building (left); the measurement point in front of Wisma Tani Entrance

4.3.4.2.11 Wisma Tani’s Pedestrian Area

This area was located at the corridor of Wisma Tani and Kementerian Pertanian dan Industri Asas Tani Malaysia (Ministry of Agriculture and Agro-Based Industry) buildings. This pedestrian area was designed with vegetation and a paved walkway in order to provide a shaded area for users. A seating area was also provided. Ground materials were dominated by white granite, polished white granite and red concrete pavement. The 20m-wide walkway with trees and grass around it had a mean LAI value of 4.8. The area was shadowed by buildings from 14:00 hours onwards (Figure 4.21).



Figure 4.21 The pedestrian area in front of the Wis ma Tani building (left); the pedestrian area provided with dense shady trees and a walkway

4.3.4.2.12 Tunku Abdul Rahman Road

This area was chosen due to its location at the waterfront and function as a public recreational area. The measurement point was located in an area of hard surfaces without any

influence of tree shade in order to measure the effect of water elements with hard surfaces along the water's edge. The walkway was designed with a red concrete imprint pavement with some areas covered with grass (Figure 4.22).



Figure 4.22 The Tunku Abdul Rahman Road with waterfront and walkway landscape environment

4.3.4.3 Preliminary work

A pilot study was conducted prior to the actual field measurement. The objectives were: (i) to determine the appropriate measurement spots and duration; (ii) to provide the author with hands-on experience with the measurements; and (3) to run a reliability test of ENVI-met by comparing the actual measurements and ENVI-met results. The pilot study, which took place from 27 August to 10 September 2008, was carried out around the Bute Building at Cardiff University. This building was chosen due to its variety of outdoor environments (i.e. soft and hard landscapes) and as it has its own weather station. Five locations were determined within each different outdoor landscape environment.

In general, the pilot study served its purpose as an exercise to gain familiarity with field measurements and computer simulation procedures before conducting the actual field measurements in Malaysia. Several amendments and considerations were undertaken. The revised procedures are described as follows:

- i. The Tinytag instruments need to be placed in a solar cover such as a Stevenson screen when installed in outdoor areas due to their sensitivity to heat for temperature measurements and precipitation for humidity measurements.

- ii. Rather than a height of 2m for the Tinytag installation point, it was decided to install 1m higher than the previous height (i.e. 3m) due to allow for more interaction between the ground surface and air and tree canopy influence.
- iii. Tinytag instruments need to be calibrated with the weather station's temperature and relative humidity probe in order to obtain consistent results.
- iv. Instead of measuring surface temperature using an infrared thermometer at the closest distance, a consistent 1m chest height from the targets was recommended and only one instrument was used during the entire measurement session in order to obtain a consistent result.
- v. In terms of ENVI-met simulation, there was a significant correlation between measured and computed results. However, the test of reliability had to be done in Malaysia due to climate variation.

4.3.4.4 Field Measurement Instrumentations

In order to achieve field measurement objectives by assessing air temperature, relative humidity and ground surface temperature at location points at street level, three main instruments were used:

1. Twelve (12) units of Tinytag TGP-4500 Ultra and TGU-4500 Plus portable data logger were used together with Tinytag Explorer software (Figure 4.23). This data logger was chosen due to its high accuracy (Ta: $\pm 0.4^{\circ}\text{C}$ at 20°C to 38°C ; RH: $\pm 3.0\%$ at 25°C) in measuring air temperature and relative humidity at the same time. These data loggers are self-monitoring recorders that can measure and operate automatically without manual supervision. Both data loggers have an operating range from -25°C to $+85^{\circ}\text{C}$ and 0-100% RH and can be operated using 1/2AA 3.6V Lithium (Li-SOCI₂) batteries. They can also be used collectively with additional instruments such as a Stevenson screen as a solar cover. A Stevenson Screen was used to hold the loggers inside the screen in order to shield the probe against precipitation and direct heat radiation from outside sources, while still allowing air to circulate freely around them.
2. One unit: Handheld Meterman IR608 Infrared Thermometer was used in measuring ground surface temperature in each measurement location point (Figure 4.24). This instrument can measure a range of targets from -1°C to 400°C with accuracy of $\pm 2\%$.

2°C of reading. The emissivity of targets was preset by the manufacturers to 0.95. It is a portable handheld instrument operated using 9V Alkaline or NiCd batteries. The specification distance to Spot Size was 8:1; the measurement is therefore suitable for use at approximately 1 m chest height from targets.

3. One unit: Nikon CoolPix 990 with Nikon FC-E8 fisheye lens was used in capturing images of the sky to determine the type of weather (i.e. rainy or clear days) and cloud conditions in the Persiaran Perdana area (Figure 4.25).



Figure 4.23 Tiny Tag TGP-4500 Ultra and TGU-4500 Plus portable data logger with Stevenson Screen



Figure 4.24 Meterman IR608 Infrared Thermometer



Figure 4.25 Nikon CoolPix 990 with fish eye lens

In measuring current climate conditions in Persiaran Perdana Putrajaya, a temporary weather station was set up on the Perbadanan Putrajaya building's 10m-high rooftop with five (5) main instruments to measure air temperature, relative humidity, wind velocity, wind direction and solar radiation (Figure 4.26). The output from the weather station was later used for basic meteorology input settings in a computer simulation programme. The instruments used for the weather station were as follows:

1. One unit: 1000 Series Squirrel data logger together with Darca Windows software was used for data storage (Figure 4.27). Sensors connected to Eltek consisted of air temperature and relative humidity probes, a wind speed anemometer, a wind direction Wind vane and solar radiation Pyranometer instruments. This data logger was chosen due to its high accuracy with $\pm 0.1\%$ of reading, $+0.2\%$ of range span), rapid memory download at 38400 baud, up to 99 logging 'runs' storage space and the ability to operate it using six 1.5V batteries. The data logger was stationed inside the building as the logger is not waterproof. Ten-metre cables were attached to each instrument at the rooftop and connected to the data logger station in the building.
2. One unit: Vaisala temperature and humidity probe HMP35DGT was used to measure air temperature and relative humidity (Figure 4.28). This probe is 260mm in length and 25mm in diameter. The humidity sensor is a solid-state device which changes its electrical characteristics in response to extremely small changes in humidity. The temperature sensing system also uses integrated circuit technology. A Stevenson screen was used as an additional instrument to hold the probe inside the screen in order to shield it against precipitation and direct heat radiation from outside sources, while still allowing air to circulate freely.
3. One unit: Vector Instruments Switching Porton Anemometer A100 was used to measure wind speed with 0.2% to 2% accuracy of reading for a speed range of 0.2Kts to 150Kts (Figure 4.29). The instrument was operated with an additional power supply of 4.75V using six 1.5V batteries. The wind speed recorded in knot pulse is then translated into metres per second (m/s) for standard measurement of wind speed and later used in a computer simulation programme.
4. One unit: Vector Instruments Encoder Windvane W200G was used to measure wind direction with $\pm 3^\circ$ accuracy obtainable following averaging (20° max. instantaneous error ref. to vane position) (Figure 4.29). The W200G is a windvane which uses a reed-switch/diode encoder to convert the wind direction as sensed by the position of the F20 series fin into a Gray-coded parallel digital output suitable for loggers. The reed-switch encoder offers the advantage of virtually zero power consumption together with good sensitivity at low wind speeds. While the relatively coarse resolution of the encoder (16 sectors) precludes accurate instantaneous measurements, the random nature of wind fluctuations together with the oscillatory response of the vane allows accurate determination of the average wind direction from multiple samples. The instrument bearing point was calibrated with Compass (type MC-series) to determine the north point

before it could be operated. Both instruments (i.e. Anemometer and Windvane) were stationed on an 8m metal tripod to avoid any obstruction from any surrounding sources.

5. One unit: Kipp and Zonen pyranometer with base and screen model CM 5 was used to measure irradiance on plane surfaces resulting from direct solar radiation and from the diffuse solar radiation incident from the hemisphere above (Figure 4.30). It complies with the specifications for a ‘first class’ pyranometer (WMO, 1983) with sensitivity ranging from 9 to 15 $\mu\text{V}/\text{Wm}^{-2}$ and maximum irradiance of 2000 W/m^2 .



Figure 4.26 The weather station was set up at the edge of the 10m-high rooftop



Figure 4.27 Eltek 1000 Series Squirrel data logger



Figure 4.28 Vaisala temperature and humidity probe HMP35DGT with Stevenson screen



Figure 4.29 Vector Instruments Switching Porton Anemometer A100 and Encoder Windvane W200G

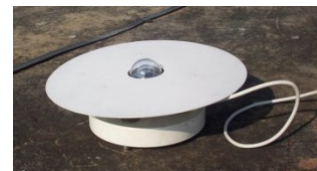

Figure 4.30 Pyranometer with base and screen model CM – CM 5

4.3.4.5 Measurement Procedures

The instruments for measuring air temperature and relative humidity, namely the Vaisala temperature and humidity probe HMP35DGT and Tinytag TGP-4500 Ultra and TGU-4500 Plus portable data logger, were calibrated in order to provide a reliable and consistent measurement output. The calibration factor uses the Vaisala Temperature probe as a reference. This was done before all the instruments were set up at every station.

After calibration factors were recorded, two units of Tinytag data loggers were installed on the tree trunk (i.e. Wawasan Park and Open Space location points) as only trees could act as poles in these areas. The remaining ten units of Tinytag data loggers were installed at a height of three metres on street lamps (Figure 4.31 and 4.32). This specific height was determined in the pilot study to allow heat from ground surfaces and other vertical surfaces to mix with the surrounding air in order to confirm that temperature and humidity

were not only influenced by heat from the ground. The author was also advised by the Perbadanan Putrajaya management to set up the instruments at a height of three metres for security reasons and their policy of not allowing any object at 1.5 to 2.0m in height to cause obstruction to pedestrians. The three-metre specified height was thus chosen with respect to these reasons.



Figure 4.31 Tiny Tag installed in Stevenson screen attached to (left) lighting post, and (right) tree trunk



Figure 4.32 Installation of Tinytag instruments attached to lighting post at a height of 3m

The temporary weather station was set up at a height of 10m on the rooftop of Perbadanan Putrajaya building. This location was chosen due to its location at the centre of the overall Persiaran Perdana and the author assumed that this location was representative of the local climate for Persiaran Perdana area (Figure 4.26). All weather instruments were set up in the open area at the edge of the rooftop to avoid any possible influence from surrounding sources (i.e. a building wall or roof). All Tinytag data loggers and weather station instruments were configured and calibrated at five-minute intervals over a 24 hour-period from February 1 to March 3, 2009. This measurement duration was chosen as average solar radiation peaks in February, leading to the highest air temperature causing a UHI effect in Persiaran Perdana (Azhari et al. 2008). The output from each instrument was downloaded at the end of the measurement period.

During this measurement period, the ground surface temperature for the 12 location points was measured using a handheld Meterman IR608 Infrared Thermometer to understand the surface temperature behaviour of different surface materials in each location. All measurements were taken at 1m chest height using the same instrument unit from the target objects in each location in order to obtain a consistent and reliable measurement output (Figure 4.33). The readings were collected at hourly intervals for every location. This interval was chosen to provide the author with ample time to record all surface temperature at all 12

location points as the location points are located at some distance from each other (i.e. within a 4.2 km area). The readings were recorded manually.

Finally, after all measurements were taken during the specified period, one day was chosen for subsequent computer programme validation and simulations. The day was selected according to weather type over a 24 hour-period (i.e. Rainy or Clear Days), data error, reliability and a sufficient amount of data output from the field measurement.



Figure 4.33 The reading taken from handheld Meteman IR608 Infrared Thermometer (left); and measurement procedure during measurement taken at 1m chest height

4.3.4.6 Determining Weather type and Cloud Cover (i.e. either Rainy or Clear Days)

In this study, information on weather types and cloud conditions in Persiaran Perdana was needed to identify the best day for later computer simulation and meteorological basic setting in ENVI-met software (i.e. cloud cover). Sky conditions were determined using images captured using a Nikon CoolPix 990 digital camera fitted with a Nikon FC-E8 fisheye lens (Figure 4.25). Sky view factor (SVF) in the images was captured were observed to be in the range of 0.9 to 1.0, where the value '1' shows no foliage or obstruction visible in the photograph (Oke, 1978; Grimmond, 2001; Svensson, 2004; Chapman, 2007).

In order to identify the weather types for each measurement day, weather conditions and cloud patterns determined by fisheye images of the case study locations were monitored. Cloud patterns were monitored at hourly interval from 09:00 to 18:00 based on sky condition images. Images for the selected date are presented in Appendix 1. The cloud cover condition (Cd) was set at 0 (no cloud) to 8 octas (full cloud cover) (Lin et al., 2010). Heavy overcast sky with signs of precipitation was classed as a 'Rainy Day', whilst clear sky with little to no

cloud distribution was classed as a 'Clear Day'. Information on weather types and cloud cover conditions were later used in the basic meteorology setting in the computer simulation programme.

4.3.5 Computer Simulation Programme

The computer simulation programme method was developed to simulate current microclimate conditions in the Persiaran Perdana area and later to predict changes in microclimate due to vegetation and ground albedo modification in three different scenarios proposed in this study. In this study, the model ENVI-met was chosen to achieve the objectives, The details regarding on the model relevancies to the study, general structure of the model, pre-testing and development of actual local tree has also been explained in this section

4.3.5.1 ENVI-met 3.1 numerical modelling

ENVI-met (Bruse, 2008) is a three-dimensional numerical model capable of simulating surface-plant-air thermal interactions based on fluid dynamics; thermodynamics and heat transfer fundamentals with a typical resolution of 0.5 to 10m in space, from a single building up to an urban scale, with a maximum of 250 grids. ENVI-met is a non-hydrostatic prognostic model based on the fundamental laws of fluid dynamics and heat transfer in a package considerably improved from sole use of a CFD package for simulation of fluid dynamics (Ali-Toudert and Mayer, 2006). It has the almost complete ability to simulate built environments from the microclimate to local climate scale at any location, regardless of overestimation due to un-calculating soil heat storage (Spangenberg, 2008), global radiation overestimation by day and underestimation of nocturnal cooling by night (Ali-Toudert, 2005). Moreover, ENVI-met's combination of biometeorological outputs provides an in-depth understanding of climate in the urban canopy layer (Fahmy and Sharples, 2010). The ENVI-met model was used in this study rather than, for example, the CTTC model introduced by (Swaid et al., 1993) which despite its improvements (Shashua-Bar et al., 2004) is more empirical in nature and based on equations derived from few available measured data, making them context-specific. Moreover, many of these models deal with the urban canyon volume as a whole - i.e. all calculations are made for one point at street level - and spatial differences within a canyon are not considered.

ENVI-met was considered preferable as it applies a soil-plant-air sub-model. Its plant database includes numerical physiological representations of plant species, using leaf area density, height, albedo, stomata resistance, foliage temperature, heat exchange, vapour exchange, water interception, ground surface fluxes, in addition to complete meteorological outputs in the main model. ENVI-met vegetation model provide the actual technical process in single trees and is formed of four sub-models (Fahmy et al., 2010). It includes in solving the interactions of temperature, humidity and air movement between air and tree foliage using turbulent fluxes of heat and vapour sub-model. Secondly, the model calculated the interaction of evaporation and transpiration of water from soil through plant that depending by number of stomata and its resistance through leaves. Thirdly, the process of foliage control on net short-wave radiation absorbed by plant that enhanced the course in plant radiation interception that calculated by steady state leaf energy budget sub-model depending on light transmission factor and foliage albedo. Fourthly, the calculation in mass of water from soil through leaf that controlling by soil hydraulic diffusivity mechanisms that allows the occurrence evapotranspiration effect, provided with tolerance from stomata resistance and soil water condition (Bruse, 2009). These factors were mostly required in order to fulfil the aims of this study. ENVI-met is competently used in literature and has been validated for assessing the built environment (Wong et al, 2007, Ali-Toudert and Mayer, 2007a, 2007b; Bourbia and Mansouri, 2008; Fahmy and Sharples 2009). The production of outputs with high spatial and temporal resolutions in comparison to other models provides a better understanding of the microclimate at street level. It also requires few input parameters and calculates important microclimate factors such as air and surface temperatures, humidity, wind speed and direction, short-wave and long-wave radiation fluxes (Ali-Toudert and Mayer, 2006).

4.3.5.2 Relevance of ENVI-met to the present study

In this study, the three-dimensional model ENVI-met, version 3.1, was used (Bruse, 2008). The major advantage of ENVI-met is that is one of the first models that seeks to reproduce the major processes in the atmosphere that affect the microclimate on a well-founded physical basis, namely the fundamental laws of fluid dynamics and thermodynamics (Ali-Tourdert, 2005). Based on the objectives of the present work, ENVI-met presents several advantages:

1. This model simulates microclimatic dynamics within a 24-hour cycle with in-stationary and non-hydrostatic and predicts all exchange processes including temperature and humidity, wind velocity, radiation fluxes, turbulence and mean radiant temperature.
2. Vegetation is considered not only as a porous obstacle to wind and solar radiation; rather, the model also includes the physiological processes of evapotranspiration, photosynthesis and sensible heat flux from vegetation into the air. The used of LAI and LAD values in defining tree canopy properties was of relevance to present and previous work. Various types of vegetation with specific properties can be used and users are able to develop new tree properties according to actual trees present on site as the LAI/LAD values are known. Soil is also considered as a volume composed of several layers and the ground can be various types. Water and heat exchange inside the soil system are also calculated.
3. As the study focused on surface-plant-air interaction, it is possible for the model to handle the energy budget at the ground surface. Outputs are surface temperature and humidity as well as fluxes of sensible and latent heat. The ground surface and the walls are used as boundary conditions for the atmospheric model (ground surface and walls) and for the soil model (ground surface) (see section 4.3.5.3).
4. It is possible to design and develop a large area of complex urban structures; for instance, buildings can be designed with shapes and heights according to actual site conditions, particularly relevant for the present work.
5. The model requires a limited number of inputs and provides a large number of outputs including calculation and output of mean radiant temperature, T_{mrt} , as a key variable in outdoor comfort and absolute humidity in determining the effect of the evapotranspiration process.
6. The high spatial resolution (up to 0.5m horizontally) and the high temporal resolution (up to 10s) allow a fine reading of the microclimatic changes, especially with regard to ground and plant interaction with the environment and pertinent for comfort issues. The receptors provided in the model allow users to design and provide numerous points in the model area where processes in the atmosphere and the soil are monitored in detail.

4.3.5.3 General Structure of ENVI-met 3.1

By understanding the basic knowledge of the model, it is important to describe the general structure of ENVI-met in order to obtain an overview on how the model works. ENVI-met is composed of a 3D core model that includes atmospheric, vegetation and sub-models and a 1D border model (Figure 4.34). The function of the 3D model is to simulate all the processes inside the actual model area. The upper horizontal boundary and the vertical windward boundary act as interfaces of the 1D border model and the 3D core model. The purpose of the 1D model is to extend the simulated area to the height $H = 2500\text{m}$ (considered as an average depth of a boundary layer in allowing accurate simulation boundary). It transfers all start values to the upper limits of the 3D volume needed for the actual simulation (Bruse, 2008).

In the core area, the entity simulated is a volume of the horizontal dimensions of X, Y and one vertical dimension, Z, plotted into grid modules. In the Z dimension, it is determined by the maximum height H_{max} of the urban elements within the model. In the main model, each module (Δx , Δy , Δz) can be a part of the typical elements in the area of interest – e.g. buildings, vegetation, streets and different types of surfaces have to be approximated in steps. To use a numerical model, the area of interest must be reduced into grid cells. The smaller a single grid cell, the finer the resolution of the model. On the other hand, making the grid cells small means that more cells are needed to cover a certain area. In other words, a large model will influence the consumption of simulation time; it thus requires a good amount of CPU time.

At street level, the first grid is vertically subdivided into five equal parts in order to thoroughly record the microclimate near the surface (Bruse, 2009). The soil model provides the system with the surface temperatures and humidity. All the soil model grids are considered as 1D with the exception of the ground surface grids which are connected in 3D to ensure homogeneity. In the models, nesting grids act as a ‘buffer zone’ to offset the actual edges of the model area to avoid numerical disturbances (the so-called boundary effect). Extension of the nesting grid further away from the central model is thus required to allow more space for the inflow and outflow boundary to react with the grids. In addition, the nesting grids ensure a representative 3D profile of the wind at the windward boundary by

adjusting the initial 1D profile. These grids get progressively larger as their distance from the core model increases and are composed of two soil types. The nesting area extends to at least twice the height of the highest obstacle in the model area ($2H_{max}$) beyond the actual modelled area.

The equations that govern ENVI-met are too numerous to be presented thoroughly here since the model is well documented (Bruse and Fler, 1998; Bruse, 1999) and is also regularly updated and available as freeware (Bruse, 2009). However, the most important databases reported in Appendixes 2 and 3.

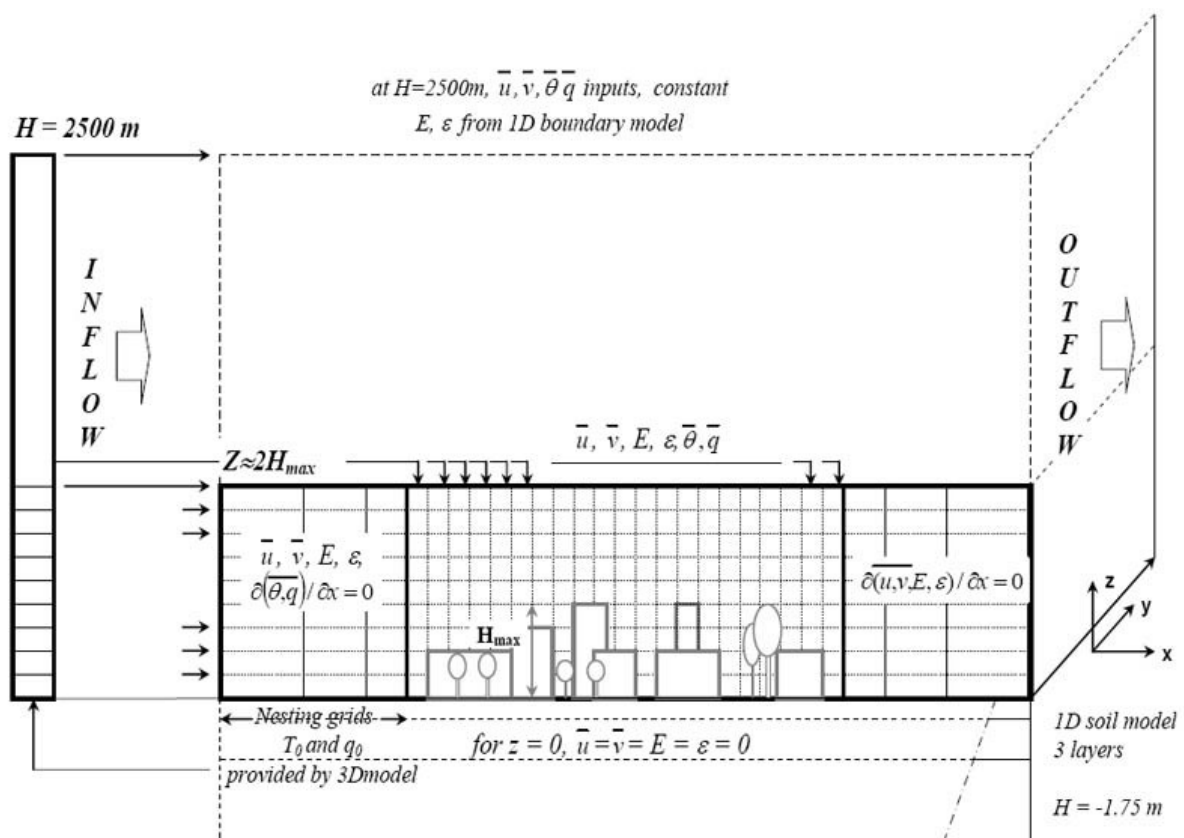

Figure 4.34 General ENVI-met model's structure including the boundaries (Source: Bruse, 2009 and Ali-Toudert, 2005)

4.3.5.4 Simulation course and boundary condition

In simulating the model, the description of the steps and boundary conditions are important to an understanding of the process behind it. Based on Figure 4.16, which illustrates the whole process in the ENVI-met mode, it can be divided into two main simulation procedures, namely, setting up the model and running the model. In setting up the

model phase, all input information was collated and loaded based on the basic setting configuration model requirements; such as area definition, basic meteorology, building properties, soil properties, plant properties and biometeorology, as presented in detail in section 4.3.6.2. Then, the Area Input file was used for the purpose of specifying the geometry of the model environment such as buildings, plants or soils in detail and visualising the information in a one dimensional image. The information stored in the Area Input files related to the position and height of buildings, the position of plants, the distribution of surface materials and soil types, the position of sources and receptors, the database link and the geographical position of the location on earth (Bruse, 2009) All inputs were required for simulating the complete model. After the first step was completed, the next step i.e. running the model was implemented.

The boundary model, used a simplified form of the 1D equation, as opposed to that used in the 3D model where some parameters needed to be set. Firstly, the boundary up to 2500m for vertical inflow profile was calculated with the 1D model by applying a logarithmic law based on the input values of the horizontal wind (u, v) at a 10m height on the roughness length z_0 given in the basic meteorology setting. Then, the potential temperature (θ_{start}) was given as an input parameter at a height of 10m in respect of the whole vertical profile, assuming start conditions of neutrality. A vertical gradient forms if the initial surface temperature differs from the initial air temperature. In providing the surface temperature to the 1D model, the sub-soil model is then calculated on the basis of three input values of soil temperatures and soil humidity included in the soil properties setting. The linear humidity profile was calculated by means of input values at 2500 m (i.e. \bar{q}_{2500m}), and functioned as local friction velocity u_* . Then, the surface temperature and humidity provided from the 3D model are used as the mean values for the nesting area related values. The initialization of the 1D model took place over a period of 8 hours with a time step of $\Delta t = 1s$ until the interactions between all start values reach a stationary state (Bruse, 2009). Then, the atmospheric equations were solved with a combination of the variables based on the following sequence: $\bar{u}, \bar{v}, \bar{\theta}, \bar{q}, E$ and ε and the exchange coefficients K_m, K_h and K_q .

Subsequently, in the 3D model, the start values at the *inflow boundary* are provided by the 1D boundary model calculation results as a vertical profile. However, this transition scheme from 1D to 3D needs an adjustment into a non-homogenous boundary urban

environment. Thus, this is solved by the use of the 3D nesting area. In contrast, homogeneity is assumed on the horizontal boundary. In the model area, wall and roof temperatures are calculated at all physical boundaries. The wind speed components at building grids are set following a *no-slip* condition, where, $u=v=w=0$. Then, the wind field is adjusted gradually during the initializing phase (*diastrophic* phase) according to the existence of the obstacles. On the other hand, at the ground surface where $z = 0$ and on the walls, E and ε are calculated as a function of u_* from the flow components tangential to the surface the model assuming that no gradient exists between the two last grids is close to the outflow border (Ali-Toudert, 2005). Based on these processes, the actual 3D simulation was comprised based on the following sequence; the calculation of soil parameters (T , η), surface quantities (T_0 , q_0 , a_s), radiation update, the update of wind components $(\bar{u}, \bar{v}, \bar{w})$, pressure perturbation p' , turbulence quantities E , ε , K_m , K_h , K_q and air temperature and humidity θ , q . Subsequently, the cycle of this process is repeated once the 1D model is re-updated.

Based on the model's numerical aspects, all differential equations are approximated using the finite difference method and solved looking forward-in-time (Bruse, 2009). Thus, there is difference in the variation of time steps implemented based on the quantity that needs to be calculated. Apparently, a 10 minute (600 seconds) main time step is required for the wind flow calculations. Whereas, smaller time steps are used for E - ε system to obtain a numerically stable solution, i.e. 3 minutes (900 seconds), whilst, 30 seconds time steps are used for surface such as surface temperature and humidity (Bruse, 1999). In microscale simulations obstacles creating steep pressure gradients require very small time steps to solve the set of wind field equations. Thus, in ENVI-met the wind field is not treated as a 'normal' prognostic variable, however, it is updated in accordance with the interval time, provided that considerations in changes, turbulence and thermal stratification occur. A larger simulation time is required if the wind field is treated as a normal variable. In this respect, the model needs a quick and implicit solution for the equations. Thus, in solving the advection-diffusion equation, the dynamic pressure is then removed from the equations of motion (Eq. 17 and 19) and supplementary flow components are calculated. Subsequently, this is corrected by integrating dynamic pressure, which has been independently defined by means of the Poisson equation (Bruse, 2004). Finally, the whole circle of calculations is re-updated until the final time steps according to time range of simulation (e.g. 24 hrs or 48 hrs).

4.3.6 Simulation Development of Current Condition and Mitigation Strategies Scenarios

4.3.6.1 Local tree development and determination of per-tree cooling effect performance

The selected trees were chosen based on a determination of LAI and LAD values from information provided from the local tree database, and then coordinated with the ENVI-met model in terms of their cooling performance. Thus, the sample of trees was selected according to their characteristics, i.e. types and locality of tree, height of the tree and densities of the canopy. Due to the availability of tree species and time limitations, only four trees were chosen to represent variation of densities from LAI 0.9 to 9.7. The selected tree species with LAI values: (i) *Malaleuca leucadendron* or Cajeput – ml (LAI = 0.93); (ii) *Filicium decipiens* or Fern Tree – fd (LAI = 4.8); (iii) *Mesua ferrea* or Ironwood Tree – mf (LAI = 7.9), and (iv) *Ficus benjamina* or Weeping fig, Fb (LAI = 9.7) (refer Fig. 4.35 to 4.38). Trees studied in this work are planted successfully in Malaysia as local species for their shading and ornamental values. Fb and ml is dominantly used as urban street trees while mf and fd are widely. All of four trees are evergreen trees can reach up to 12-20 m mature height, 6-10 m corresponding height and 2-4 m trunk height (Corner, 1997; Russell et al., 2006). However, in order to distinguish the performance from each tree, 8 m overall height and 8 m crown width was selected. Thus, field measurements to determine the actual LAI and LAD distribution values for each tree were made during a month of January, 2009. Then, the data accrued was transferred and calculated using Eq. 10 to 13 to develop a new tree database based on local climate conditions and species.



Figure 4.35 *Malaleuca leucadendron* or Cajeput (ml)



Figure 4.36 *Filicium decipiens* or Fern Tree (fd)



Figure 4.37 *Mesua ferrea* or Ironwood Tree (mf)



Figure 4.38 *Ficus benjamina* or Weeping fig (Fb)

In the LAI and LAD field measurement, certain procedures were conducted to find the actual LAD distribution for each tree. The measurement of LAI was based on the Isolated Plants Method (LI-COR, Inc., 1992). The calculations of the LAI using LAI-2000 required measurements above (A) and below (B) the vegetation using a 90° view cap as presented in the earlier author research (Shahidan et al, 2010). However, in order to determine LAD distribution in each layer of the canopy or LAD slice, z_p , an advanced procedure was conducted based on the previous method (Shahidan et al, 2010). For measurement purposes a Plant Canopy Analyzer LAI-2000 was used for determining the LAI values at each layer of the canopy. The procedures leading from field measurement to data storage in the ENVI-met plant database were conducted as follows:

1. The selected tree was measured using a tape measure to find the total height, h , from the ground to the highest peak of the canopy.
2. In order to determine the total LAI ($LAI_{(t_0)}$) for the tree, the same procedures as those in previous research were used (Shahidan et al, 2010).
3. After the total LAI was determined, the tree total height was divided into 10 sections and each section was measured according to the Plant Canopy Analyzer LAI-2000 for obtaining the LAI_z (Figure 4.39).
4. The same method as that used in previous research procedures was used for measuring the LAI_z of each tree section.
5. Then, the results from each section were used in calculating, the z_p , for each section of the tree using the equation below (as presented in section 3.3.1):

$$z_p = LAI_z / (h/10)$$

where, z_p , is the LAD value at height of LAD slice;

LAI_z , is the leaf area index at selected height, z ;

h , is the total height of tree;

6. The results of z_p from each section were added to find the sum of LAD, and then this value was compared with the $LAI_{(to)}$ measured earlier (at step 2) to ensure the accuracy of the measurement (Bruse, 2008).
7. Then, the results from each tree was transferred and stored into ENVI-met model plant database PLANTS.DAT as a local database, based on each LAD layer's distribution (LAD1 to LAD10) (refer to Appendix 4).
8. Finally, all trees were then simulated in the basic setting of the ENVI-met model within a 50m x 50m domain to predict and compare per-tree cooling effect by comparing the outside-underneath tree canopy's meteorological parameters (Figure 4.40).

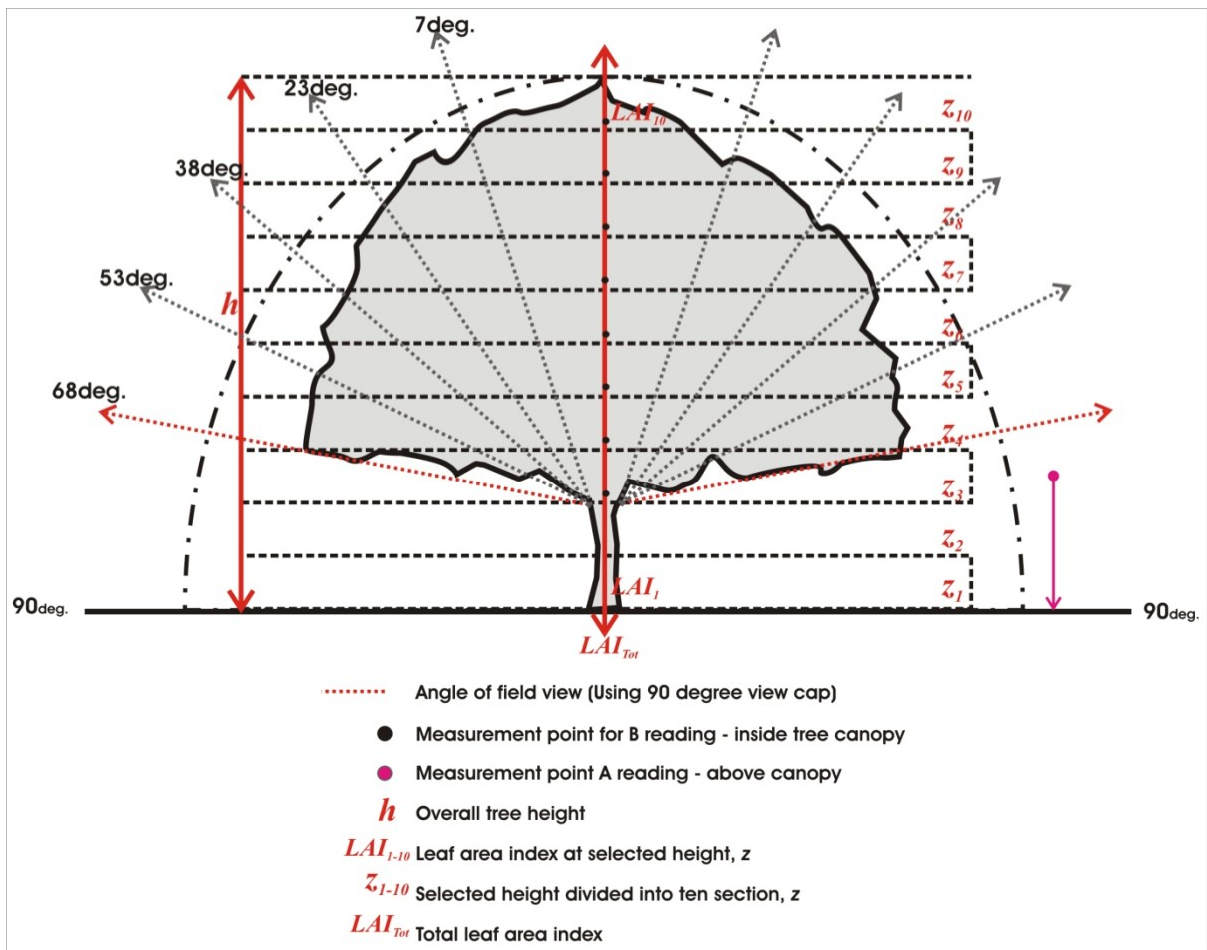

Figure 4.39 Sectional diagram showing procedures in measuring h , z_p and LAI_z

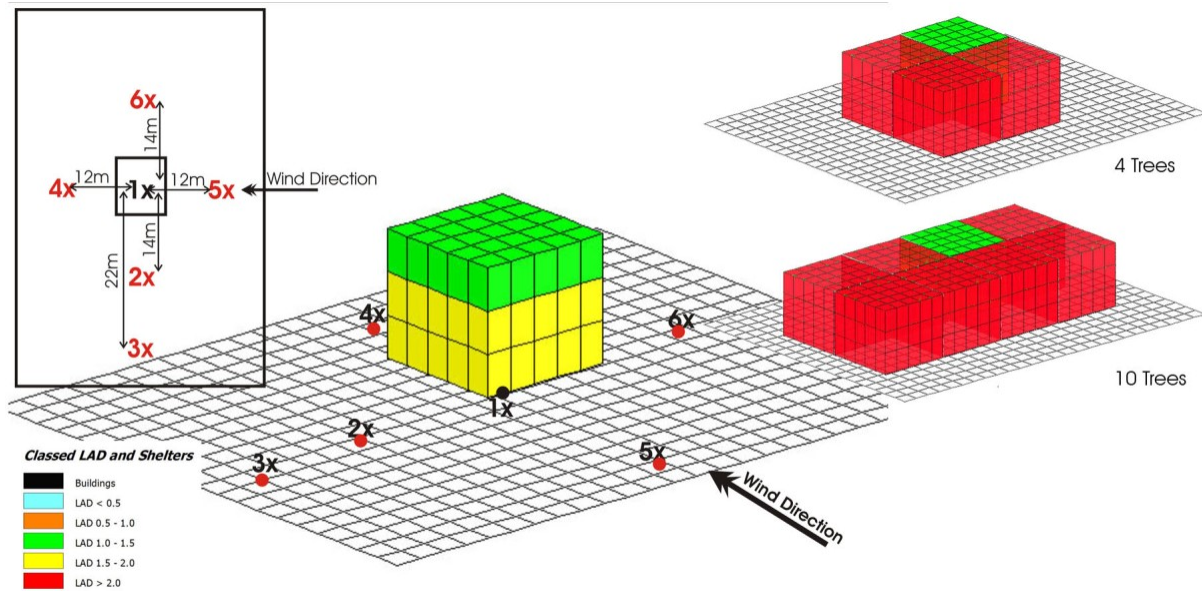

Figure 4.40 Each of the selected trees was simulated in the ENVI-met model basic setting for predicting per-tree cooling effect

4.3.6.2 Development of Current Condition and Proposed Scenarios

4.3.6.2.1 Development of base model of site conditions simulation

To allow for the completion of the field measurement data and climate conditions within a 24 hour time span, a single clear day was selected randomly (i.e. February 28, 2009) in order to carry out the simulations. The main simulation conditions were based on the field measurement on that day, whilst plant database and building properties used for the case studies reported in this work are based on data obtained from Perbadanan Putrajaya (2008) (Table 4.2). The base model domain simulated is constructed based on satellite images, building documents and data from Perbadanan Putrajaya (2008). The domain was representative of the current conditions of the 4.2 km Persiaran Perdana and designated within 250 x 250 x 30 grids input dimension and dx , dy and $dz = 20\text{m}$ grid cell size due to the large scale of the area (Figure 4.41).

Table 4.2 Typical inputs' configuration of a Persiaran Perdana current condition simulation as used in this study

```

%----- Basic Configuration File for ENVI-met version 3 -----
% ---- MAIN-DATA Block ----
Name for Simulation (Text):           = Putrajaya test 05_aft4_280209
Input File Model Area                 = [INPUT]\TEST044_1.in
Filebase name for output (Text):      = Putrajaya TEST05edit4
Output Directory:                     = [OUTPUT]
Start Simulation at Day (DD.MM.YYYY): = 28.02.2009
Start Simulation at Time (HH:MM:SS):  = 06:00:00
Total Simulation Time in Hours:        = 24.00
Save Model State each ? min           = 60
Wind Speed in 10 m ab. Ground [m/s]  = 1.1
Wind Direction (0:N..90:E..180:S..270:W..) = 270
Roughness Length z0 at Reference Point = 0.1
Initial Temperature Atmosphere [K]    = 304.15
Specific Humidity in 2500 m [g water/kg air] = 7.8
Relative Humidity in 2m [%]           = 60.3
Database Plants                       = input\Plants.dat
( -- Following: optional data. The order of sections is free. --)
[POSITION]
Longitude (+:east -:west) in dec. deg: = 3.8
Latitude (+:northern -:southern) in dec.deg: = 101.42
Longitude Time Zone Definition:         = 08.0
[SOILDATA]
Initial Temperature Upper Layer (0-20 cm) [K] = 301
Initial Temperature Middle Layer (20-50 cm) [K] = 305
Initial Temperature Deep Layer (below 50 cm) [K] = 305
Relative Humidity Upper Layer (0-20 cm) = 50
Relative Humidity Middle Layer (20-50 cm) = 60
Relative Humidity Deep Layer (below 50 cm) = 60
[TIMING]
Update Surface Data each ? sec         = 30.0
Update wind field each ? sec           = 900
Update Radiation and Shadows each ? sec = 600
Update Plant Data each ? sec           = 600
[TURBULENCE]
Turbulence Closure ABL (0:diag.,1:prognos.) = 1
Turbulence Closure 3D Model1 (0:diag.,1:prog) = 1
Upper Boundary for e-epsilon (0:clsd.,1:op.) = 0
[BUILDING]
Inside Temperature [K]                 = 293
Heat Transmission walls [w/m²K]         = 1.7
Heat Transmission Roofs [w/m²K]        = 2.2
Albedo walls                            = 0.3
Albedo Roofs                            = 0.5
[PLANTMODEL]
Stomata res. approach (1=Deardorff, 2=A-gs) = 2
Background CO2 concentration [ppm]     = 350
    
```

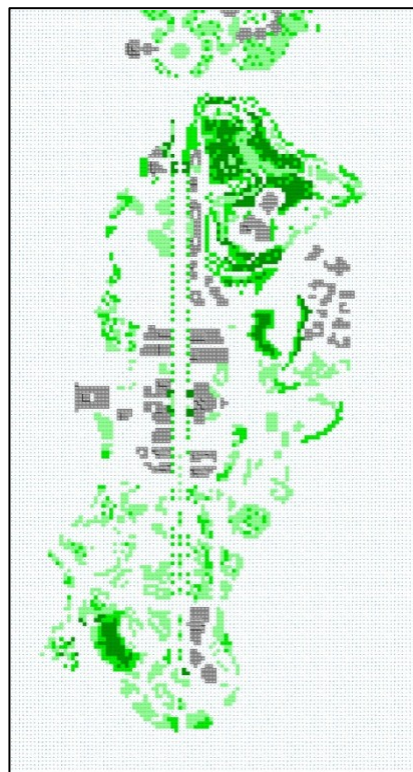

Figure 4.41 The 1D main model domain of Persiaran Perdana in a grid cell

U-values for 'standard' building materials (i.e. $1.7 \text{ w/m}^2\text{K}$) were used (Koenigsberger et al., 1973, Markus and Morris 1980) and the typical albedo of walls and roof data were reported from Perbadanan Putrajaya (2008). The simulations started preferably at 6:00 AM when most atmospheric shifts are slow. Input start values were not obvious so set and test simulations were often necessary. In some cases, these are based only on theory (follow Ali-Toudert, 2005), e.g. the ground surface temperature was set a few degrees lower than T_a (Asaeda and Ca 1993) and a roughness length of z_0 is chosen as a typical value for urban areas (Oke, 1978). However, the wind speed condition is set to 1.1 m/s at a 10 m height, lower than the actual weather station measurement. In the preliminary simulations, both the average air and surface temperature were underestimated. Thus, some of the input data from the weather station had to be calibrated in order to achieve a better correlation with the measured results. The results showed that air temperature and surface temperature was influenced by wind speed. Based on the model interpretations, this may be due to the high wind speed causing high volume of cool energy, simultaneously cooling the surrounding air. Thus, this shows that diurnal amplitude tends to increase with decreases in wind speed. This is similar to adjustment problems experienced in Spangenberg's (2008) study where it became necessary to find a better correlation with measured results due to the wind speed input. It is noted that the measured wind speed varied strongly in direction and speed throughout the whole day. Therefore, in order to adjust the air and surface temperature curve, the average mean wind speed measured was changed from 2.1 m/s to 1.1 m/s . The initial temperature was increased by 2°C in order to obtain a better correlation between measured and computed temperature. Simulations are run for 24 hours in order to obtain day and night time results. Approximate similar daytime surface temperature curves were achieved and the comparison between the calculated correlation coefficient, R^2 , in measured and simulated air temperature on February 28, 2009 from 12 measurement points is tabulated in Table 4.3. Further simulation validation results were presented in detail in Chapter 5.

Table 4.3 Correlation coefficients between the measured and computed air and surface temperatures for each location on the selected day for a 24 hour period

Environment		
February 28, 2009		
Location points	AIR TEMPERATURE Correlation coefficient (R²)	SURFACE TEMPERATURE Correlation coefficient (R²)
1. Wawasan Park	0.956	0.919
2. Mahkamah	0.975	0.860
3. Perbadanan	0.972	0.972
4. Putra Square	0.970	0.973
5. P3P Road	0.958	0.973
6. Rakyat Square	0.970	0.969
7. Open space	0.965	0.952
8. P2N Road	0.923	0.972
9. Perdana Boulevard	0.959	0.971
10. Wisma Tani Entrance	0.933	0.972
11. Wisma Tani's Pedestrian Area	0.905	0.969
12. Tunku Abdul Rahman Road	0.957	0.970

4.3.6.2.2 Development of Proposed Scenarios

Besides the current condition, three scenarios were designed in order to compare and predict the optimum cooling potential from vegetation and ground material modification. Thus, the basic input configurations, as presented in Table 4.2 were used throughout all simulations to confirm that the cause of modification was genuinely attributable to the vegetation and ground materials. The scenarios were as follows:

- (A) Current condition;
- (B) Double the amount of trees and changes to a low canopy density trees (i.e LAI 0.9) with current ground material albedo conditions;
- (C) Double the amount of trees and changes to a high canopy density trees (i.e. LAI 9.7) with current ground materials albedo conditions;
- (D) Double the amount of trees and changes to a high canopy density trees (i.e. LAI 9.7) with changes to ground surface materials with 0.8 albedo value.

In order to predict the varying effects of vegetation and albedo modification in different conditions, three environmental conditions - i.e. condition B, C and D were designed and focused at the high problematic area. Based on the previous satellite images and field measurement findings, more trees were added in areas that were identified as hot spots and high temperature areas, namely, Putra Square, P3P Road, Rakyat Square, Perdana Boulevard, P2N Road and Tunku Abdul Rahman Road. Tree quantities were doubled from current conditions (A) from 5,100 to 10,136 additional trees. Due to time and hardware

constraints, based on the previous simulation pre-testing that takes four to eight weeks per-simulation time, the simulation was limited to two types of tree densities. Thus, in order to differentiate and compare the effect, the study generalised the use of trees with LAI 0.9 as low density; LAI 2.4 as medium density (i.e. current LAI values) and; LAI 9.7 as high density. Thus, trees studied in this work to replace the existing situation in case study site are *Maleleuca leucadendron* (ml) and *Ficus benjamina* (Fb) to represent low and high tree canopy density. The lowest and highest densities were chosen to compare a smaller to a larger value of differences in cooling performance of trees. As referred to literature section 3.5, the proposed trees were arranged in cluster planting to evaluate the optimum effect of tree performance based on this arrangement. Thus, trees are allocated 4 m distance from the tree trunk with the same specification of trees mentioned in section 4.3.6.1. Table 4.4 summarises the changes made in each scenario in comparison to the current condition (A), and Figure 4.42 visualises the three dimensional model output in four different environmental conditions (i.e. A to D).

Table 4.4 Summarise table on the changes made in each scenario condition proposed

Conditions	A	B	C	D
	CURRENT MEDIUM DENSITY TREE	LOW DENSITY TREE	HIGH DENSITY TREE	HIGH DENSITY TREE WITH HIGH ALBEDO
Tree Mean LAI	2.4	0.9	9.7	9.7
Mean Albedo Values	0.3 - 0.4	0.3 - 0.4	0.3 - 0.4	0.8
Tree Quantities	Current	Add Tree		Increase (%)
1. Wawasan Park	90	0		0
2. Mahkamah	28	0		0
3. Perbadanan	36	0		0
4. Putra Square	20	30		60%
5. P3P Road	0	124		100%
6. Rakyat Square	64	22		35%
7. Open space	4	288		98%
8. P2N Road	28	36		56%
9. Perdana Boulevard	0	4		100%
10. Wisma Tani Entrance	0	0		0
11. Wisma Tani's Pedestrian Area	10	0		0
12. Tunku Abdul Rahman Road	10	30		75%
13. Other Areas	4810	4502		94%
TOTAL	5,100	5,036		99%

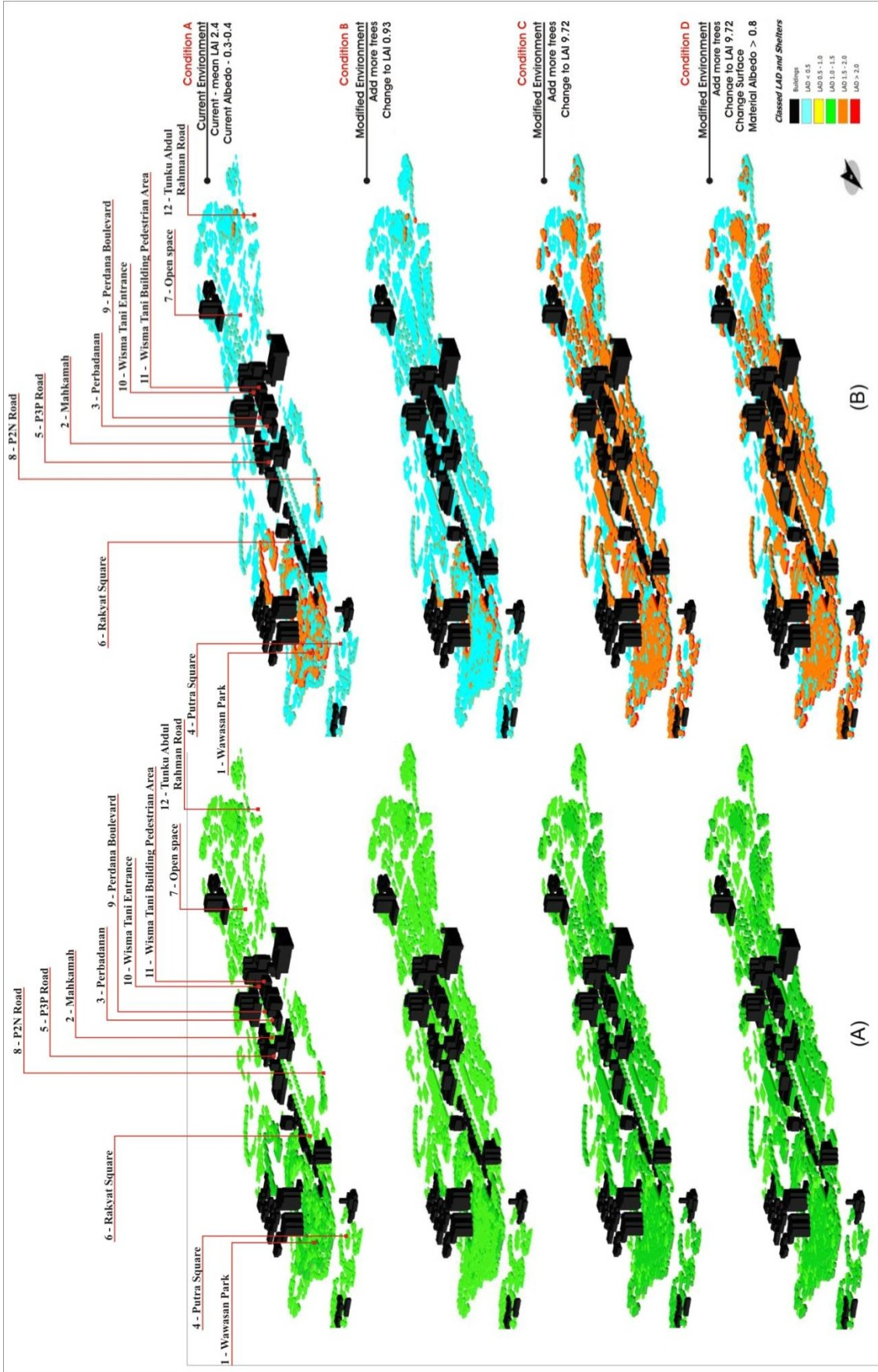

Figure 4.42 Three dimensional model outputs in four different conditions of environment (A) vegetation coverage and (B) mean LAI for environmental condition A to D

4.4 Outdoor Thermal Comfort Survey Methods

The outdoor thermal comfort field survey was conducted in order to assess current users' outdoor thermal comfort perception in Persiaran Perdana by means of a questionnaire. This was intended to provide immediate measurements of microclimate parameters and to assess the influence of vegetation and albedo modification to improve users' comfort level. Firstly, the field survey was conducted within three different landscape environments; i.e. green spaces, open spaces and outdoor building spaces, so as to understand the thermal comfort perception of the users towards the spaces and the variation of microclimate variables, particularly with regard to air temperature and radiant temperature, as these two parameters are significantly important in defining the comfort level in outdoor environments (Nikolopoulou, 1998). Then, the summary of users' comfort level perception in Persiaran Perdana was analysed based on the results from the overall field surveys. The Rayman model was used to determine the comfort level index in PET values and finally the modification results from the ENVI-met were compared to the current users' comfort range as obtained from the summary of the field survey.

4.4.1 Determining times and dates of field survey

The work schedule for the field survey duration was simultaneously conducted with the two separate months of field measurement programme and began on January 1 continuing until March 3, 2009. The highest average solar radiation, and therefore temperature, is found during the month of January to February every year in this region, thus it was selected as offering the most potential for an extreme UHI effect in Persiaran Perdana (Azhari et al, 2008). However, in order to assess the users' outdoor thermal comfort in Persiaran Perdana as influenced by vegetation and albedo modification, the hours of peak temperature from 12:00 until 15:00 were chosen. It is also the case that the shading effect of trees and buildings, and the interaction of ground surface and the air, were most apparent during these hours (Shahidan et al, 2010). At this point of time, the sun is overhead and the shade is concentrated directly on the canopy/building. The shadow was almost equal to the planting/building area, due to the solar height angle being close to 90° (Kotzen, 2003, Tukiainen, 2010). The whole interaction process of filtration, evapotranspiration and microclimate improvement were found to operate during this time. Additionally, based on observation and Perbadanan

Putrajaya's management, the majority of Persiaran Perdana's users were among government and private workers who actively used outdoor spaces during their lunch break from 12:00 to 15:00 hours.

4.4.2 Measurement Location

4.4.2.1 Green Spaces

The green space location was selected according to the existence of a cluster of trees that provide shade to people beneath the canopies. The areas that were considered to be green spaces were Wawasan Park, Mahkamah and Perbadanan pocket parks. Thus, these areas were selected as suitable measurement locations to represent green spaces in Persiaran Perdana (Figure 4.43).

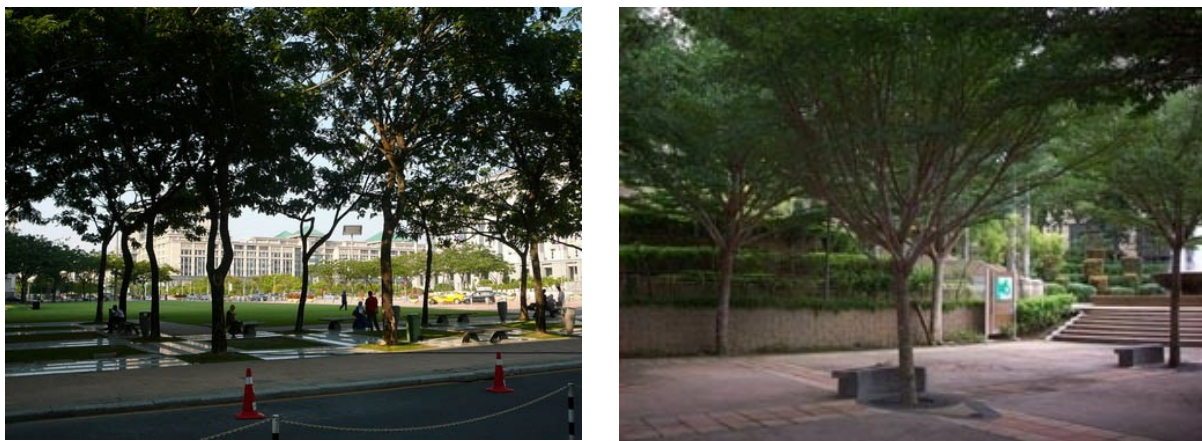

Figure 4.43 The measurement area for green spaces areas – i.e. (left) Perbadanan (right) Wawasan Park

4.4.2.2 Open Spaces

The open space area was selected based on the existence of a majority of hard surfaces exposed to the sun without any obstacles to create shading, such as trees or building. The area selected to represent open spaces in the Persiaran Perdana area were Putra Square and Rakyat Square, which are mostly surfaced with hard pavement and tarmac (Figure 4.44).



Figure 4.44 The measurement area for open space areas (left) Rakyat Square (right) Putra Square

4.4.2.3 Outdoor building spaces

The outdoor building spaces were defined as those areas located near building perimeters that benefit from building shading, such as building corridors, lobbies or passageways. The area was selected due to its being an alternative shaded area and an outdoor space; offering people in Persiaran Perdana an alternative to green space shading(Figure 4.45).

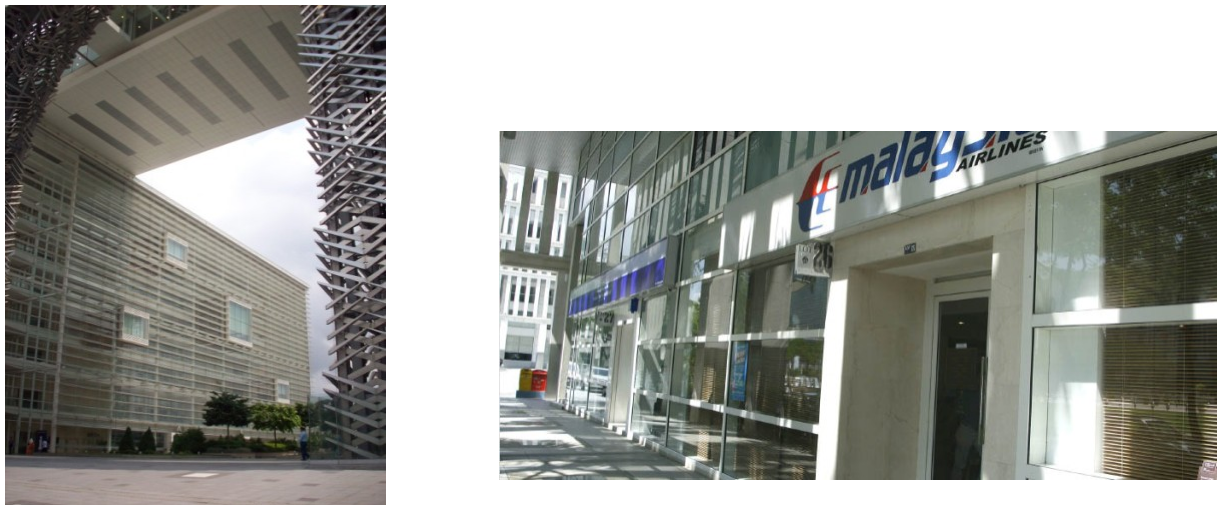

Figure 4.45 The measurement area for outdoor building spaces (left) Perbadanan corridor area (right) building passageway

4.4.3 Instrument: Questionnaire survey

In this study, the questionnaire was developed to support one of the research objectives and to suit the goals of this research. To aid subjects, the questionnaire was prepared in English, referring to a glossary of comfort terminologies. Terminologies used in the questionnaire were translated in Bahasa Malaysia according to the *Kamus Dwibahasa: Bahasa Inggeris-Bahasa Malaysia* (Bilingual Dictionary: English- Bahasa Malaysia) (Dewan Bahasa dan Pustaka, 1989) (refer to Appendix 5).

Subjects' comfort perception and preferences towards outdoor thermal comfort in Persiaran Perdana were measured via a two-section questionnaire form; i.e. Section A: Personal Details and Observation; and Section B: Perception and preference on thermal comfort rating. Questions from section A and B were based on their actual current experience whilst the survey was being conducted. Questions in section B were arranged in pairs asking respondents to rate thermal comfort and current readings of microclimate parameters (elaborated on by the author during questioning as required).

The analysis for the survey was obtained from these two sections (i.e. A and B). Section A was dedicated to identifying the subject's personal details, activity and clothing etc. Whilst Section B was divided into three sub-sections, where the first section (questions B1 to B8) were designed for the purpose of identifying users' comfort perceptions and preferences based on individual microclimate variables, i.e. thermal, wind, humidity and light. In the second sub-section (questions B9 to B12) asked respondents their perceptions and preferences regarding the current amount of vegetation and shaded area in order to measure the current quantity of these elements from the users' perspective. Finally, the third sub-section (questions B13 to B14) asked the subjects for their overall outdoor comfort satisfaction rating and any additional comments to conclude the survey.

4.4.4 Instrument: Microclimate variables monitoring

In monitoring and obtaining the immediate microclimate parameters during the questionnaire survey activity, portable mini-weather stations instruments were used to allow the author full mobility whilst conducting the survey. During the survey, environmental parameters were measured and recorded, namely, air temperature, relative humidity, wind

speed, light intensity and globe temperature. Due to the availability and limited instrumentation for conducting this survey, four main instruments were selected as compatible for monitoring:

1. The Vaisala temperature and humidity probe HMP35DGT was used to measure air temperature and relative humidity (Figure 4.28). This probe is 260 mm in length and 25 mm in diameter and attached to a data logger. The humidity sensor is a solid-state device which changes its electrical characteristics in response to extremely small changes in humidity. Meanwhile, the temperature sensing system also uses integrated circuit technology.
2. The Lutron LM-8000 (Figure 4.46) is a 4 in 1 handheld measuring instrument consisting of an Anemometer to measure air velocity, a hygrometer to measure relative humidity, a lux meter for measuring light intensity and a temperature probe (Type K) to measure temperature. The Lutron LM-8000 has a humidity measurement range from 10 to 95% RH and an accuracy of $<70\% RH: \pm 4\% RH, \geq 70\% RH: \pm (4\% rdg + 1.2\% RH)$. The light measurement range from 0 to 20,000 lx with accuracy $\pm 5\% rdg \pm 8 dgt$ and a temperature measurement range from -100 to 1300°C with accuracy $\pm (1\% rdg + 1^\circ C)$.
3. AIRFLOW hotwire thermo-anemometer (Figure 4.47); 20 to 6000 fpm (0.1 to 30 m/s), Accuracy: $\pm 2\%$ of reading was used for measuring wind speed. Instantaneous reading was obtained in order to provide immediate wind data. As the instrument was limited to one directional air flow measurement, it was placed facing towards the wind direction and placed at the abdomen level of the subjects during the interview session.
4. The Tiny Talk globe thermometer was used together with TinyTag Explorer software (Figure 4.48) for measuring globe temperature. Due to the availability of instruments, a black globe thermometer was used. However, it should be noted that there are limitations and assumptions that need to be considered in the context of a comfort study outdoors. When black globe thermometers are used, it is assumed that the subject being considered is wearing black clothing and has darker skin in the case of exposure to shortwave radiation (e.g. the sun). Thus, the mean radiant temperature reading calculation was taken into account the absorptivity of the clothing worn.



Figure 4.46 Lutron LM-8000 Portable 4 in 1 Anemometer, Hygrometer, Lux Meter and Thermometer



Figure 4.47 AIRFLOW hotwire thermo-anemometer



Figure 4.48 Tinytag Talk Globe Thermometers

4.4.5 Subjective Measurement Procedures

When conducting the survey, procedures were taken into account to obtain reliable data from subjects. The procedures were as follows:

1. Firstly, subjects were chosen randomly and should be located at the specific outdoor area in Persiaran Perdana (i.e. green spaces, open spaces, around building area). The field survey was conducted from 12:00 and 15:00 during a clear day. Both genders were consulted during the survey.
2. Secondly, subjects were informed by the author that this survey was voluntary and they had the freedom to accept or reject the survey and that all the data taken for the survey was fully confidential. Subjects were also informed that during the session they were being observed on their personal characteristics (i.e. age, clothing, activity location etc).
3. Thirdly, subjects were asked by the author about their personal details and characteristics (refer to section A).
4. Fourthly, subjects were asked on their thermal perception and preference (i.e. thermal, wind, humidity, light) while meteorological parameters were monitored and placed near to the subjects at abdomen level, then recorded concurrently by the author in the 'office use' box during the session (refer to section B).
5. Fifthly, subjects were asked about their vegetation and shaded area perceptions and preferences (i.e. vegetation and shaded amount).
6. Sixthly, subjects were asked about their overall comfort at time of sampling.

7. Finally, subjects were asked if they have any suggestion or comments, particularly in regard to their comfort in outdoor spaces.

In total there were 22 questions in questionnaire form and the duration was approximately 3 to 4 minutes. A summary of each section is shown as follows:

1) **Section A: Personal Details and Observation (8 questions):** in this section, subjects were asked for user's locality, location, outdoor usage time, activities, clothing and food and drink consumption. Three age groups were given, namely, 20 to 30; 31 to 40; 41 to 50; 51 to 60> years old. The age group from 41-60 was chosen using a rationale based on the pilot study where most of the subjects in the age bracket 40 and above years of age were not committed to tell interviewer their exact age, especially women. The age question was sensitive for them. Thus, the author assumed and categorised this range of age to become one category within 20 years of range from 41 to 60> years old. Two types of users were given, namely, locals or outsiders and if subjects were local, four types of local users were given, namely, working persons, visitors, students or others in Persiaran Putrajaya. The subjects' location was specified as in sun or out of sun and the outdoor location were observed by the author (i.e. green, open or outdoor building spaces) and recorded in 'office use' box of the questionnaire. The subject's frequency of usage of outdoor areas was determined according to duration of time, namely, morning (8:00 to 12:00); afternoon (12:00 to 17:00) and evening (17:00 to 19:00). Six types of recent main activity were identified for the subjects and shown in Table 4.5., 13 types of daily outdoor wear were listed individually, as shown in Table 4.6. The food and drink consumption was divided into five conditions, namely, none, hot food, cold food, hot drink or cold drink and a sixth option was given at this point, i.e. smoking.

Table 4.5: Activity during last half hours listed in questionnaire

No.	Activity type
1	Sleeping
2	Sitting
3	Standing
4	Walking
5	Running
6	Other

Table 4.6: Individual Clothing listed in questionnaire

No.	Clothing Type
1	Short sleeved shirt
2	Long sleeved shirt
3	Blouse
4	Baju Kurung
5	Vest/Jacket/Suit
6	T-shirt
7	Long Pants
8	Jeans
9	Long Skirt
10	Short Skirt
11	Shoes and socks
12	Sandal or Thongs
13	Other

1) **Section B:** The questions consisted of thermal comfort rating (8 questions), current vegetation and shaded area rating (4 questions), overall comfort rating (1 question) and comments and suggestions (1 question). Subjects' thermal comfort perception were given according to the 7-points Fanger scale ranging from 'cold' (-3) to 'hot' (3) (Fanger, 1970). On subjects' preference and on the microclimate variable such as wind, humidity and light were given according to ASHRAE 7-point scales ranging from 'much cooler' (-3) to 'much warmer'; 'no wind' (-3) to 'too strong' (3); 'much less' (-3) to 'much more' (3); 'very dry' (-3) to 'too damp' (3); 'much dryer' (-3) to 'much damper' (3); 'too dark' (-3) to 'too bright' (3); 'much darker' to 'much lighter' (Hwang and Lin, 2007). Table 4.7 shows the description of thermal comfort questions in Section B:

Table 4.7: Description of questions in thermal comfort section

Code	Question	Scale type	Environmental Parameters
B.1	At the moment, what do you feel?	Thermal comfort ('cold' to 'hot')	Air temperature (°C) and radiant temperature (°C)
B.2	What would you prefer?	Thermal comfort ('much cooler' to 'much warmer')	
B.3	At the moment, what do you feel about the wind movement?	Wind speed ('none' to 'too strong')	Wind Velocity (m/s)
B.4	What would you prefer the amount to be?	Wind speed ('much less' to 'much more')	
B.5	At the moment, what do you feel about the humidity?	Humidity ('very dry' to 'too damp')	Relative Humidity (RH%)
B.6	What would you prefer the amount to be?	Humidity ('much dryer' to 'much damp')	
B.7	At the moment, what do you feel about the light?	Light intensity ('too dark' to 'too bright')	Light Intensity (lx)
B.8	What would you prefer the amount to be?	Light intensity ('much darker' to 'much lighter')	

The same 7-points scale rating was used in subjects' green and landscape perception and preference; and in their overall thermal comfort satisfaction rating. The scale used ranged from 'too little' (-3) to 'too much' (3) and 'much less' (-3) to 'much more' for green and landscape perception and preference. The overall comfort satisfaction was scaled from 'very uncomfortable' (-3) to 'very comfortable' (3). Table 4.8 and 4.9 shows the description for both questions.

Table 4.8: Description of questions in vegetation and shaded area section

Code	Question	Scale type
B.9	At the moment, what do you think about the overall amount of vegetation in this area?	Vegetation quantities ('too little' to 'too much')
B.10	What amount of vegetation would you prefer?	Vegetation quantities ('much less' to 'much more') in the scale of '-3x' to '3x'
B.11	At the moment, what do you think about the overall amount of shaded area in this area?	Shaded areas ('too little' to 'too much')
B.12	What amount of shaded area would you prefer?	Shaded area ('much less' to 'much more') in the scale of '-3x' to '3x'

Table 4.9: Description of questions in the overall thermal comfort satisfaction section

Code	Question	Scale type
B.10	In overall, how satisfied are you with your thermal comfort?	Overall thermal comfort satisfaction ('very uncomfortable' to 'very comfortable')

Finally, this section was concluded with an open-ended question asking the subjects if they had any additional comments regarding their comfort at that time.

4.4.6 Data Calculated from monitoring data and observations details

4.4.6.1 Calculation of mean radiant temperature (MRT)

As presented in Chapter 3 section 3.4.3.1, mean radiant temperature can be obtained when globe temperature, air temperature and velocity are known. Based on environmental data obtained from the field survey, a mean radiant temperature for each subject was calculated using ASHRAE formula:

$$T_{mrt} = \sqrt[4]{(t_{globe} + 273)^4 + 1.1 \times 10^8 \times wind_sp^{0.6} \times (t_{globe} - t_{air}) \div (0.95 \times 0.038^{0.4})} - 273 \quad \text{Eq. 17}$$

Thus, in this field survey study the mean radiant temperature was obtained from the above calculation. Later, the information was used for evaluating subjects' thermal comfort indices or PET.

4.4.6.2 Metabolic rate (met) and Clothing level (clo)

The subject's metabolic rate assessment, in addition to the subjects' activities, were assumed in this study and the subject's metabolic rate was also influenced by food, drink and smoking (Nikolopoulou et al., 2001) and the rate changed as follows:

1. Cold food and drink – decrease by 10%
2. Hot food and drink/smoking – increased by 5 %

Thus, the actual subject's metabolic rate was re-evaluated by the author before further analysis according to subjects' activities and food/drink consumptions. The clothing level was reviewed and grouped by the author based on data obtained from field survey. It was divided into seven typical male and female clothing preferences with Clo values that were estimated from ISO7730 as shown in Table 4.10 (ISO7730, 2005).

Table 4.10: Review on typical Clothing Types with clo values (ISO7730, 2005)

No.	Review on Typical Clothing Type	Clo value
1	Men - Office Attire 1 (Short Sleeved Shirt, Long Pants, Shoes/Socks)	0.57
2	Men - Office Attire 2 (Long Sleeved Shirt, Long Pants, Shoes/Socks)	0.61
3	Men - Formal Dress (Suits/Jacket/Vest, Long Pants, Shoes/Socks)	0.96
4	Women - Office Attire 1 (Blouse, Long Skirt/Short Skirt, Shoes/Sandal)	0.54
5	Women - Office Attire 2 (Baju Kurung, Shoes/ Sandal)	0.4
6	Men & Women - Casual Attire 1 (T-shirt, Jeans, Shoes/Sandal/Thongs)	0.5
7	Men & Women - Casual Attire 2 (T-shirt, Long Trousers/Long Skirt,	0.45

4.4.6.3 Calculation of PET

The PET of each subject was estimated using the free software package RayMan 1.2 (2000) which has been used in urban built-up areas with complex shading patterns and generated accurate predictions of thermal environments (Matzarakis et al., 1999, Gulyas et al, 2006; Lin et al, 2006; Matzarakis, 2007). The evaluation of PET using RayMan model is very flexible and practical (Lin et al, 2010). PET was calculated directly using RayMan when all the factors that need to calculate PET – i.e. air temperature (T_a), relative humidity (RH), wind speed (v), mean radiant temperature (t_{mrt}) subject's clothing value (clo) and metabolic rate

(met) were obtained from field survey through environmental monitoring data and observation details. The thermal comfort range for the PET in the Persiaran Perdana area were obtained through analysis of the regression model using SPSS software package version 12.0.

Later, the environmental output from ENVI-met simulation at 1 m receptor point (i.e. T_a , RH, v , T_{mrt}) was used in calculating each subject's PET using RayMan based on current environment and each of the three different modified scenarios. The clo and met values were based on the actual field survey observation data. The PET's results from the field survey and each of the modification scenarios were compared in order to assess the influence of scenario modification towards users' outdoor thermal comfort level.

4.5 Building Energy Savings Methods

The building energy savings methods were divided into two sections, namely, direct effect method and the indirect effect method. The objective of the direct method was focused into individual building assessment to measure the actual influence of the different outdoor environment on the indoor environment by means of field measurements, and to compare the result for validation with HTB2 software package. Later, by using the building selected from the field measurement, the indirect effect was focused into a large scale effect for the purpose of measuring the energy saving of each individual building using the HTB2 model as a result of outdoor microclimate modification in Persiaran Perdana's.

In the building direct effect method, a direct field measurement was conducted involving six selected buildings measuring the outdoor and indoor environment simultaneously. The building was selected according to different outdoor landscape environments (refer to 4.5.2.2) in order to understand the actual direct effects influencing variables from the outdoor environment in respect of air temperature and other microclimate variables. The outdoor landscape environments were selected as follows:

1. 100% of hard landscape; i.e. asphalt and concrete pavement
2. 80% of asphalt with 20% grass and a single small tree
3. 90% of pavement with 10% grass and a tree cluster

4. 100% grass with a tree cluster (mean LAI 4.73) and a single tree (LAI 5.49)
5. 100% grass with a single tree (mean LAI 3.89)
6. 100% grass

Based on the result, two building were tested and simulated with two major different environments (i.e. 100% grass with tree cluster and single tree and 100% of hard landscape) using the HTB2 model and the results were compared with field measurement findings. After the validated results were obtained, one single building selected was used for later indirect simulation using HTB2 software.

In the indirect effect method, the ENVI-met simulation's meteorological output for Persiaran Perdana's current and other three modification scenarios were used to provide the outdoor meteorological condition input for the HTB2 model. All the meteorological output for the 12 location points in the ENVI-met simulation were used and simulated to compare the building's energy savings for each environmental scenario. Subsequently, the result from each modification was determined to confirm the effect of modification on building energy savings.

4.5.1 Direct Effect Field Measurement Method

4.5.2.1 Field measurement location and times

Based on the nature of field measurement methodology procedures for assessing the direct effect on individual buildings that specifically require non-air conditioned and natural ventilated buildings, there is a 24 hour assessment period, involving installation of instruments and free access to the building, creating some limitations to the author in terms of conducting the measurements in Persiaran Perdana, Putrajaya. According to correspondences with Perbadanan Putrajaya management in June 2009, the application for conducting the survey was declined due to their rules and regulations disallowing the air-conditioning to be switched off during office hours, in addition to restrictions on granting 24 free access to the building and building regulations not permitting any temporary installation inside or outside the buildings for security and safety reasons.

Due to these limitations, the nearest location within the same Persiaran Perdana's climate parameters was identified by the author within 5.4 km of the Persiaran Perdana area

(Lat 2°59' N, Long 101°42'E). It was an institutional campus area (Lat 2°55' N, Long 101°42'E), namely, Universiti Putra Malaysia (UPM), Serdang, Selangor campus (Figure 4.49), which is dominated by one to fifteen-storey building built in green field surrounding, located between Kuala Lumpur and the Putrajaya area. The site was chosen due to its proximity affording a similar climate condition to that observed in the Persiaran Perdana area. In addition, it was suitable because the university's management agreed to follow the measurement procedures and granted permission to the author to conduct the field measurements within university grounds. However, the permission was granted with the condition that the author was permitted access to the building only during office hours (08.00 to 17:00). Additionally, the field measurements were only to be taken on weekdays for safety reasons.

Information about the buildings and a site survey was conducted previous to completing the survey; from August 11 to the 18, 2009. The measurement was conducted from August 19, 2009 until September 29, 2009, over a total of 42 days. During this period of time, field measurements were conducted only on clear days and within the permitted access duration. Thus, only air and humidity measurements were conducted throughout the whole day, whilst surface temperature measurement was conducted within the office hour period from 08.00 to 17:00.

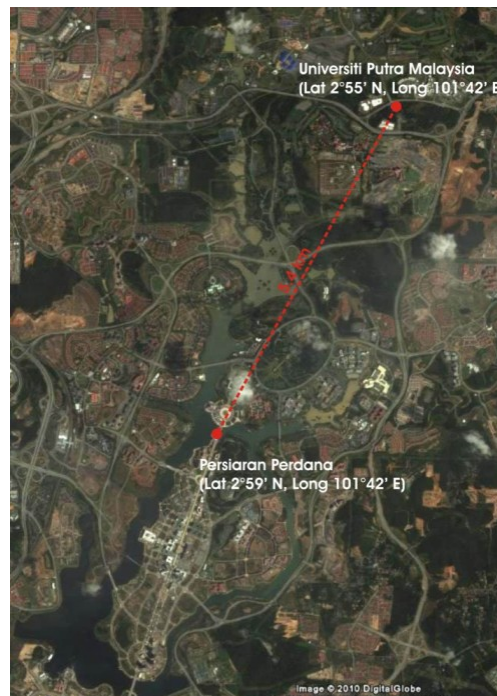

Figure 4.49 The location of Universiti Putra Malaysia 5.4 km from Persiaran Perdana (Source: Google Earth, 2009)

4.5.2.2 Building Selections and Environment

Based on the limitations and the availability of the building and site conditions, six buildings were selected for conducting the field measurement. The selection parameter was based on the building construction material, wall orientation, building height from single to two-storey building (Table 4.11). However, the colour of building facades was not taking into consideration due to difficulty in finding buildings within the same colour range. The following Table 4.12 gives the name of the selected building with its individual outdoor landscape environmental character. Figure 4.50 to 4.56 shows the images of the site conditions for each selected building.

Table 4.11: The parameter for building selection

Name of building	Wall Materials	Wall Orientation	Height (Storey)
Studio 3, Industrial Design Building	Brick wall	East	Single
MPIL Building	Brick wall	East	Single
Swimming Complex	Brick wall	East	Single
Student Centre 1 Building	Brick wall	East	Two
Student Centre 2 Building	Brick wall	West	Two
Academic Building	Brick wall	East	Two

Table 4.12: The building names and outdoor landscape environment character

Name of building	Outdoor landscape environment character
Studio 3, Industrial Design Building	100% of hard landscape – i.e. asphalt and concrete pavement
MPIL Building	80% of asphalt with 20% grass and a single small tree
Swimming Complex	90% of pavement with 10% grass and a tree cluster
Student Centre 1 Building	100% grass with a 9m tree cluster and (LAI 4.73) a single tree with 2m away from wall (mean LAI 5.49)
Student Centre 2 Building	100% grass with a single tree 2m away from wall (mean LAI 3.89)
Academic Building	100% grass



Figure 4.50 Studio 3 Industrial Design Building



Figure 4.51 MPIL Building



Figure 4.52 Swimming Complex



Figure 4.53 Student Centre 1 Building



Figure 4.54 Student Centre 2 Building



Figure 4.55 Academic Building

4.5.2.3 Instrumentations

In the field measurements of direct effect, the main environmental parameters measured were outdoor and indoor air temperature, relative humidity and wall and ground surface temperature. Besides, temporary weather stations were allocated at the building's rooftop for monitoring the local weather parameters, such as temperature, relative humidity, wind speed and direction, and solar radiation. For the field measurement, the instruments were used as follows:

1. Fourteen (14) units of Tinytag TGP-4500 Ultra and TGU-4500 Plus portable data logger were used together with TinyTag Explorer software (Figure 4.5). This data logger was opted for due to its high level of accuracy ($T_a: \pm 0.4^\circ\text{C}$ at 20°C to 38°C ; $\text{RH}: \pm 3.0\%$ at 25°C) in measuring air temperature and relative humidity at the same time. In addition to these data loggers were self monitored recorders that could be used to measure and operate automatically without human manual supervision. Both data loggers have an operating range from -25 to $+85^\circ\text{C}$ and 0 - 100% RH and can be operated using $1/2\text{AA}$ 3.6V Lithium (Li-SOCI₂) batteries. As for outdoor measurement, the Tinytag was used collectively with additional instruments such as a Stevenson screen as solar cover. Where

in use for indoor purposes the Tinytags were uncovered and exposed to the indoor environment.

2. One unit Handheld Meterman IR608 Infrared Thermometer was used for measuring ground and building's wall surface temperature (Figure 4.6). This instrument can measure within a range of targets from -1°C to 400°C with accuracy of $\pm 2\%/ 2^{\circ}\text{C}$ of reading. The emissivity of targets was manufactured pre-set to 0.95. It is a portable handheld instrument that operated using 9V Alkaline or NiCd batteries. The specifications distance to Spot Size was 8:1, thus, the measurement is suitable for approximately 1 meter chest height from the targets.
3. Li-Cor Plant Canopy Analyzer LAI-2000 (Figure 4.56) was used to measure LAI of trees within the building's perimeter. It is attached to a control unit that contains necessary electronics to measure, record, and compute final results (LI-COR, INC, 1992).
4. Lux meter Lx-101 (Figure 4.57) was a handheld instrument that was used to measure the transmissivity of trees. The meter can measure three ranges of measurement from 0 to 50,000 lux. It has an accuracy of $\pm (5\% + 2d)$ for all three ranges of measurement. It has a dimension of 108 x 73 x 23 mm with sensor probe of 82 x 55 x 7 mm and uses a CC 9V battery.
5. A Compass type MC-Series (Figure 4.58) was used to determine bearings for measurement points and building orientation.
6. A Nikon Digital Camera COOLPIX 8700 (Figure 4.59) was used to capture the images of tree samples during the field measurement. It was also used to get clear digital photographs for 3D modelling purposes (Shlyakter et al, 2001)



Figure 4.56 Plant Canopy Analyzer Licor LAI-2000



Figure 4.57 Lux meter Lx-101



Figure 4.58 Compass type MC-Series



Figure 4.59 Nikon Digital Camera COOLPIX 8700

The temporary weather station used the same instruments as those for Persiaran Perdana's field measurements (refer section 4.3.4.4). In addition, the same installation procedures were applied during this field measurement. The instruments that were used for

the weather station were: 1000 Series Squirrel data logger together with Darca Windows software, Vaisala temperature and humidity probe HMP35DGT for air temperature, Vector Instruments Switching Porton Anemometer A100 for wind speed, Vector Instruments Encoder Windvane W200G for wind direction and Kipp and Zonen pyranometer with base and screen model CM 5 for solar radiation.

4.5.2.4 Measurement Procedures

Due to the limited availability of Tinytag instruments, the measurement was limited to two buildings per day. Thus, three days were required for measuring the six buildings' perimeters. However, during the 42 days period of measurement, only clear days were counted for field measurement. The measurement procedures were as follows:

1. Buildings were selected according to its east or south orientation with suitable outdoor landscape conditions. A compass was used for determining the buildings' orientation and point of measurement. The east and south facing were determined and all points of measurement were selected and confirmed. Two buildings with different environments were selected and measured concurrently for one day of field measurements.
2. After buildings and point of measurement was determined and selected, the instruments were installed at the indoor and outdoor building walls.
3. In outdoor installation, the east or west facing wall were installed with two Tinytag instruments with the screen at the height of 2.5 meters from the ground. The installation of two numbers of Tinytag was done to determine if there was any significant variation between both locations measurements. One Tinytag with a screen was installed at north or south facing wall for control measurement as absolute temperature and humidity during the period of measurement. The control measurement was ensured to be located away from sunlight exposure or other objects that might influence the absolute measurement of Tinytag instruments (Figure 4.59).
4. In indoor measurement, the locations points were parallel to, and at the same height as, the outdoor Tinytag locations. The indoor Tinytag for east or west and north or south location were installed at the wall without the screen and exposed to indoor surroundings (Figure 4.60).
5. Temporary weather stations were installed at the Design and Architecture Faculty's rooftop at 10 meters in height. All weather instruments were set-up in open area at the

edge of the roof top to avoid any possible influence from surrounding sources (i.e. building wall or roof).

6. All Tinytag data loggers and weather station's instruments were configured and calibrated at set-up time and at an interval of every 5 minutes for 24 hours a day from 08:00 finishing at 08:00 the following day.
7. During the measurements of air temperature and relative humidity, wall and ground surface temperatures were measured simultaneously, using a Handheld Meterman IR608 Infrared Thermometer. The measurements were taken at 1 hour intervals from 08:00 until 17:00 during office hours. The targeted points were measured at 10 cm from the Tinytag instruments in order to measure wall surface temperature near the Tinytag measurement area. The same procedures were applied also to indoor measurements. During the measurement period, all surface temperature measurements were recorded manually.
8. As for the area with present of trees, the LAI index was measured using a Plant Canopy Analyzer LAI-2000 in order to identify the tree canopy density in that area. Besides, the Lux meter Lx-101 was used to determine plant transmissivity (Shahidan et al, 2010). In the case of a light intensity measurement, the measurements were conducted at two hourly intervals starting from 10:00 until 15:00. Both data were recorded manually and later used in a computer simulation programme.
9. After all measurements were done, Tinytags' data was downloaded to the computer using Tinytag Explorer software to obtain data for the next steps in the computer simulation programme.

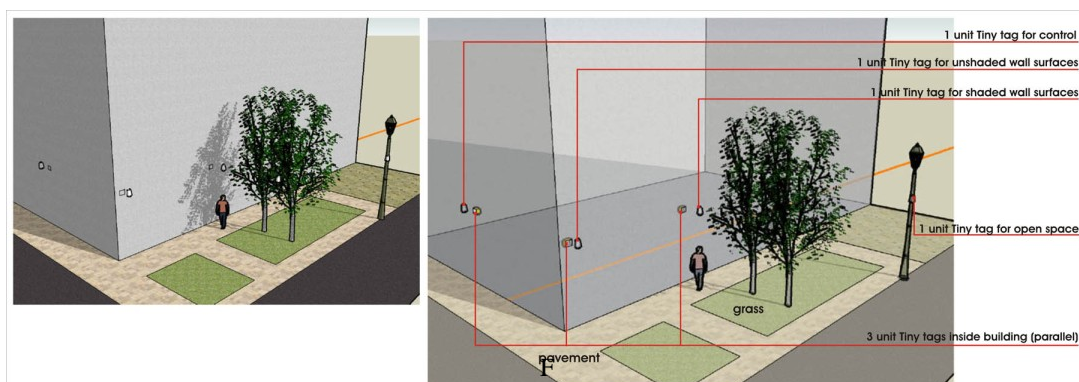

Figure 4.60 The diagram shows the typical measurement procedures for direct effect field measurement methods



Figure 4.61 Example installation of Tinytag at outdoor and indoor wall

4.5.3 Computer Simulation Programme

The computer simulation programme was designed to simulate and measure the actual influence of the outdoor and indoor environment according to the following objectives:

1. To compare and validate the field measurement and simulation results by using one selected buildings with different environments (i.e. with trees and hard landscape environments), in two measurement parameters (i) natural ventilation (ii) energy saving (air-conditioned influence)
2. To simulate and use a building selected from the above findings as the representative for the Persiaran Perdana area, in order to predict the indirect effect of building energy savings based on the current, and three different environmental scenarios modification resulting from ENVI-met.

4.5.3.1 HTB2 Software

As refer to section 2.8.3 on the strength and limitation of HTB2 model, the thermal performance of a building can be predicted when it is subject to the influence of outdoor temperature, solar gain, shading, ventilation and infiltration. Thus, one of the strengths that was applied for this study was the ability of this model to easily alter or replace all input components; for example meteorological conditions, ventilation, building construction and shading properties in order to assess building energy performances. Based on this flexibility, a comparison between different outdoor microclimate conditions which have influenced the

indoor environment of buildings can be predicted and simulated using this model. Besides, this also allows the user to define complex heating and cooling schedules, occupancy, lighting, and internal load intensity patterns, and to vary control settings during run-time, to mimic realistic occupation conditions (Bojic and Yik, 2005). Similar to other simulation models, HTB2 assumes that the air temperature within each of the simulated zones is uniform and, when predicting the cooling load that the cooling plant is able to maintain the indoor air temperature steadily at the set-point value. HTB2 has been shown to be capable of providing predictions that matched well with measurements in the buildings (Lomas et al, 1997, Bojic and Yik, 2001; 2005).

4.5.3.2 Determine tree shading effect using HTB2 software

In general, HTB2 accepts descriptions of shading devices as a numerical map or 'shading mask', illustrating the amount of energy that is able to reach the surface (i.e. building wall, facade or window etc.) in question from each part or sector of the sky vault. It was quantified with the values that specified ratios of the estimated shaded radiation to unshaded radiation; in effect the transmissivity of the shading device for a particular sector (Alexander, 1996). In measuring the shading effect, HTB2 uses 10 degree sectors and the sky dome was divided into patches at 10 degrees steps; 36 in azimuth, 9 in altitude, as in the diagram below (as if viewed from ground looking up) (Figure 4.61 and 4.62). Each sky segment has a specified transmission value ranging from 0.0 is 'blocked' to 1.0 is 'clear' (Alexander, 1996). In HTB2, both items of mask data was used to determine the attenuation of the direct beam (should the sun be in a particular sector at the given time), and the attenuation of the diffuse sky with an assumption of uniform distribution. However, the ground reflected component is not affected by an HTB2 shade mask.

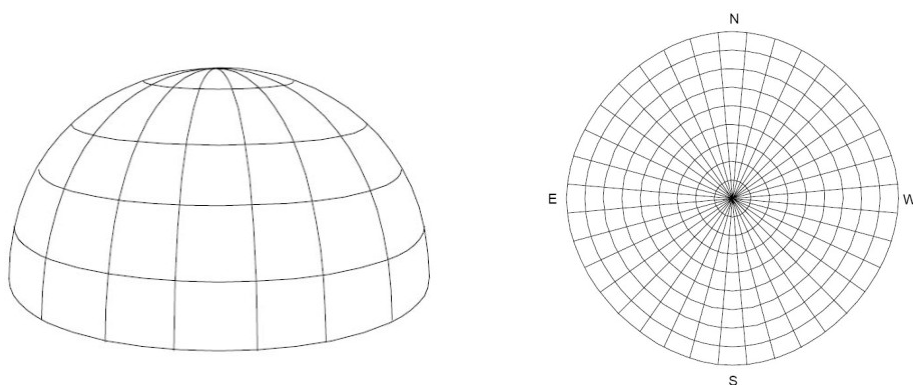

Figure 4.62 Sky dome and diagram viewed the sky dome with patches from the ground (Source: Alexander, 1996)

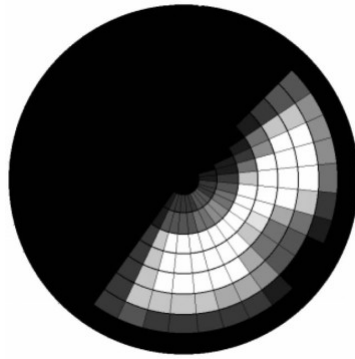

Figure 4.63 Shading mask with colour coded intensity from black (0.0, blocked) to white (1.0, clear) (Source: Alexander, 1996)

HTB2 adopted this scheme due to the flexibility it offers (Alexander, 1996). The flexibility was determined by the use of the mask to specify both real and theoretical devices of all types, and can include the effect of external obstructions. Thus, the masks in HTB2 can be programmed; for instance, the seasonal shading effect of trees could be simulated. However, currently the derivation of the mask data is left to the user. Therefore, in considering the tree shading effects towards building facades in the HTB2 software, specific measurements and procedures were taken into account for obtaining significant shading effects that influence the direct effects of the building. The measurement was conducted based on Student Centre 1's building condition where the area was covered with 10 m height high density *Filicium decipiens* tree (LAI 5.49). The required measurement steps and procedure were as follows:

1. The data providing LAI value and transmissivity of tree canopies was obtained from the direct effect field measurement, where the transmissivity of the plants was determined by measuring the light intensity during the daytime measurement (i.e. 08:00 until 18:00).
2. By using a Nikon Digital Camera a photograph was taken 10m away from the centre of the tree (Shlyakhter et al, 2001). The camera was held at the eye level of the photographer. All photographs taken must be at a defined and equal distance and height in the case of all specimens. Snap points were taken either from north, northwest or northeast points or vice versa according to the site conditions. A one-metre ruler was used for determination of scale in the photographs. The photographs were converted onto planes through silhouette extrusion in the AUTOCAD 2004TM format. The image was then transferred to a computer, and AUTOCAD 2004TM software was used to generate the skeleton of the tree. This skeletal image was then transferred to the ECOTECHTM version

5.50 to generate a 3D image of the tree form. The ECOTECT™ software was also used to conduct Shadow Analysis on the building's wall (Figure 4.63).

3. The simulation using ECOTECT™ was set-up at one hour intervals from 8:00AM until 6:00 PM according to the latitude and longitude of the site. The orientation and distance of the tree from the wall was determined according to the actual conditions on site. In order to compare the shading effect made by trees, solid walls (or vertical planes) with the same height as trees were put next to the tree. This was due to the reason that in HTB2, the only vertical plane shading mask was set as a standard value. Based on this comparison, the standard vertical plane shading mask was used as a reference for determining the shading mask of a tree (Figure 4.64).
4. The results from the Shadow Analysis were used in developing a shading mask in HTB2.
5. The patches values were determined according to the form of shadow generated onto the wall and ranged according to the value from 0.0 (i.e. blocked) to 1.0 (i.e. clear); based on the transmissivity value measured during the field survey (Figure 4.65).

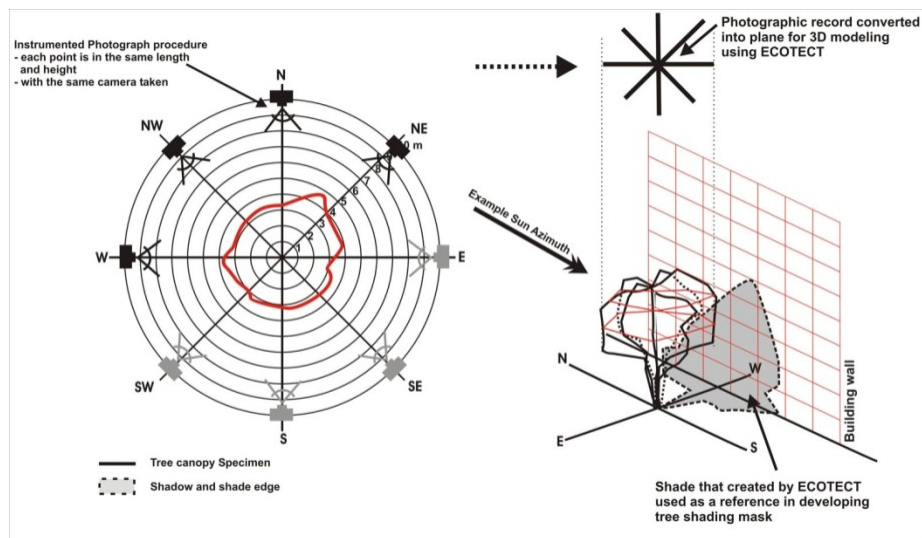

Figure 4.64 The implementation of instrumented photographs in constructing 3D modelling

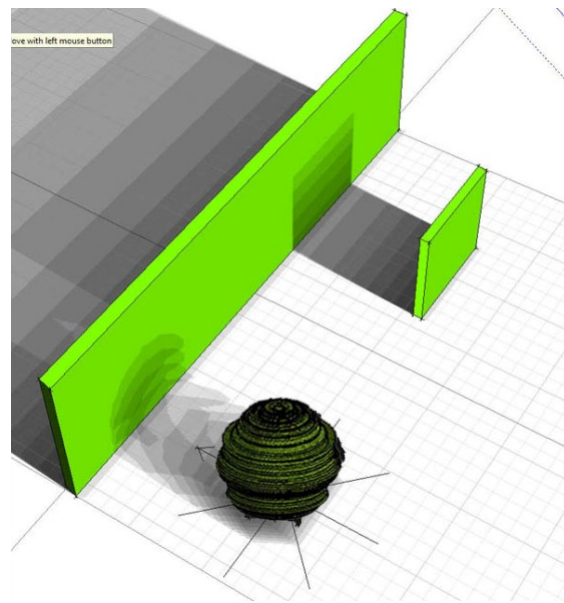

Figure 4.65 The 3D model tree and vertical plane for comparison purposes

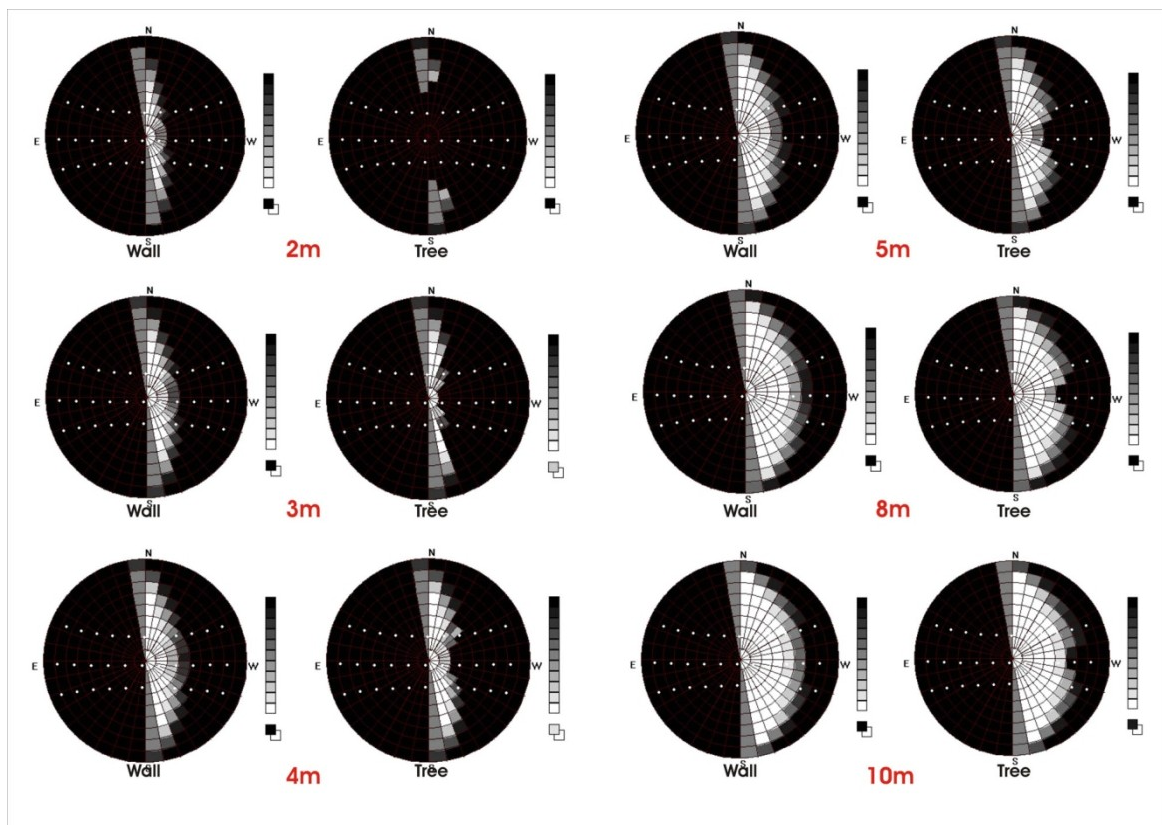

Figure 4.66 Comparisons of shading mask values for trees on site and vertical planes in distance variation

4.5.3.3 Simulation Arrangement and Procedures

Figure 4.66 shows the layout of the Studio 3, the Industrial Design building, which was formed and selected as a basis for this energy savings study. The building was selected due to its simplicity to outdoor environmental conditions (i.e. fully hard pavement), which allowed for significant comparisons with different environments (e.g. existence of tree), which can be applied to further simulations. This single-storey building has a simple layout with major facades (entrance and second entrance) facing west and east, whereas the other two facades have windows facing north and south. The whole floor comprises one main floor with an open plan studio of 624 m² sized area.

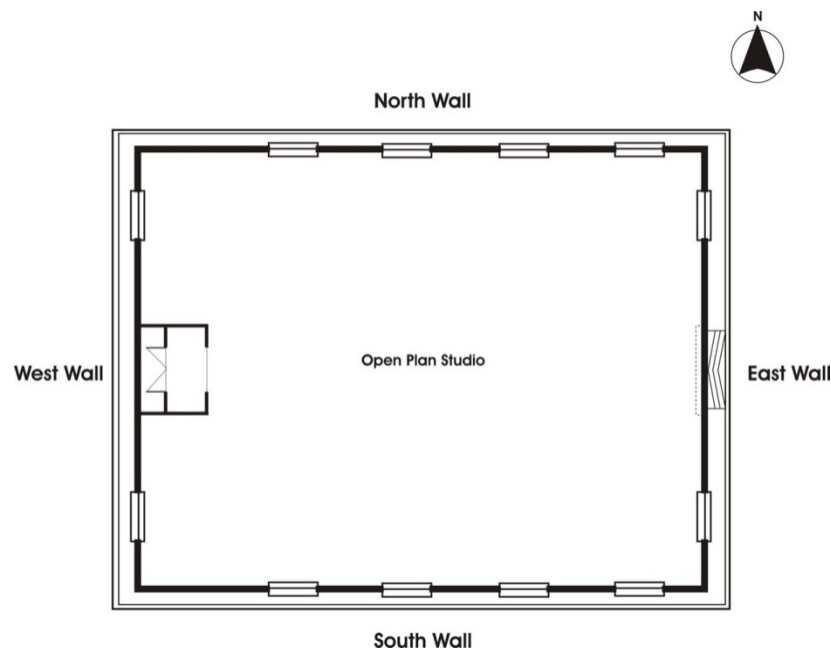

Figure 4.67 The basic layout of Studio 3, Industrial Design building

Input for HTB2 were prepared according to the characteristics of the original construction and referred to as the baseline model. The original outdoor wall slabs are each composed of three layers: a 20 mm thick plastered layer and paint at the outdoor side, a 110 mm brick wall layer, and a 20 mm thick plastered layer and paint at the indoor side (Figure 4.68). There are 12 windows in the building and the construction was based on a single glazing window with glass 6mm wide. A solid ground floor was used with two layer properties: concrete with a 100 mm depth and a 1600 mm of earth layer. The roof was identified as a flat roof composed of three layers: a 100 mm concrete layer as an outside rooftop layer, a normal cavity of 65 mm thickness, and 9 mm plasterboard on the indoor side. All this information formed the basis for every simulation in this study. However,

meteorological input becomes a variable in each simulation as scenarios are influenced by different outdoor conditions. The information was gathered and obtained from the field measurements and temporary weather station. The input data provided was external dry bulb temperature, external humidity, wind speed, wind direction and total horizontal solar irradiation and direct normal irradiance. In addition, the ground surface temperature was set in HTB2 according to surface temperature measurements during the field measurements on site.

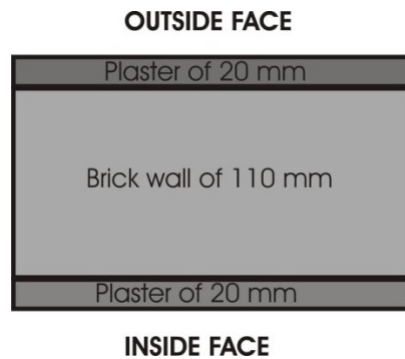

Figure 4.68 The wall slabs layer properties

For the first simulation to compare and validate the two different environments (i.e. (i) with hard landscape and (ii) tree environment), the setting listed above was used with two different meteorological files. Basically, the meteorological file for hard landscape environment was obtained from Studio 3, Industrial building measurement, whilst the ‘with tree’ environment was obtained from Student Centre 1’s building measurement. Two meteorological file were obtained from Student Centre 1 based on two set that represent a single tree and cluster of trees measurements. However, this simulation only considered natural ventilation in order to compare the computed and actual temperature contribution from each different outdoor environment. After undergoing several processes of simulation to determine the suitable ventilation rate of the building, 0.5 air changes per hour (ach) (refer section 7.22 for ventilation rate determination results). This is due to all windows being shut during the field measurement to allow for the determination of the actual influence of outdoor conditions on the indoor environment. Apart from that, in simulating the building’s with tree environment, the additional information regarding the shading mask was obtained from tree shading analysis result and loaded in HTB2. After the consecutive simulation a validation result was obtained (refer Chapter 7), the energy savings simulation was conducted with additional input information for further prognosis simulations in HTB2.

The additional information needed and gathered in the HTB2 input file was services data consisting of occupancy, lighting, small power, heating and ventilation. The whole area sized at 624 m² is occupied by 26 students and 2 lecturers during office hours from 09:00 to 17:00 hours in weekdays. These occupancy patterns were assumed to be applicable on all days throughout the measurement period. These details enabled the HTB2 software to calculate heat gains from the users of the building. The light was assumed to be turned on from 09:00 to 12:30, turned off during the lunch hour and then turned on again from 14:00 to 17:00 (Table 4.13). This information is used by HTB2 to determine the internal heat gains from lighting the building. This table also summarises the assumed profiles of energy loads in the building caused by small computers. Thus, the information would enable the HTB2 software to calculate the internal heat gains from these devices. The air conditioners were installed in the building. The air conditioners in the building served the whole areas from 08:00 to 17:00 hours. Full time running of the air conditioning was chosen in order to determine those energy savings that can be obtained from the influence of the outdoor environment during office hours. When the building was air conditioned with windows shut, the assumed infiltration rate for this room was 0.5 ach. Additionally, the diary file was used for a method of scheduling events within a simulation run in HTB2. All this information was used as a basis for information services setting for further indirect simulation using this building. In fact, these setting were correlated with average building service activity in every building in Persiaran Perdana, regardless of the assumption of the occupancy in the building.

Table 4.13: The lighting and small power data information

Time (h)	Unit electricity load for lighting (W/m ²)	Unit energy load (W/m ²)
	34 nos 65 W Standard fluorescent light	22 nos Computers (150 W)
09:00 – 02:00	2210	3300
12:30 – 02:00	0	0
02:00 – 05:00	2210	3300

For the prognosis simulation study of energy saving, a further model was devised for the simulation study by changing the meteorological information in each outdoor environment set. Firstly, the simulation was based on the actual meteorological information (i.e. with hard landscape and tree environment) to understand the energy savings from both outdoor environments. In the tree energy saving simulation, additional simulation that involved variation of tree distance from 2 m to 10 m was conducted in order to determine the direct effect of tree shading on building energy savings. After the direct effect simulation

results were obtained and compared, a further prognosis simulation was conducted in order to predict the indirect effects of building energy savings based on current conditions and three different environment scenario modifications in the Persiaran Perdana area. The meteorological information was obtained from ENVI-met simulation results. Six main locations that signify a divergence of environments were chosen in order to differentiate the indirect effect of energy savings influenced by microclimate modification in the Persiaran Perdana area. Finally; a comparison of building energy savings, both current and after modification of the conditions, was made in order to assess the energy saving to the building.

4.6 Summary

In this chapter, the research methodologies employed have been discussed. Measurement procedures and instrumentation used in field measurement was further explained individually according to three main sections in terms of UHI Mitigation Strategies, Outdoor Thermal Comfort Survey and Building Energy Savings methods. In the main computer simulation programme (i.e. under UHI Mitigation Strategies method) general structure of ENVI-met was used as a tool and this has been explained thoroughly in order to define the capability of, and simulation procedures for, the model. Besides, the discussion of the HTB2 model that was used as a tool in assessing building energy savings is included in this chapter. The research methodologies used to gather the data for further analysis according to each individual method sections were also presented.

Results for each type of assessment are explained in three subsequent chapters. These are, Chapter 5: UHI Mitigation Strategies Findings and Discussion; Chapter 6: Outdoor Thermal Comfort Findings and Discussion; and Chapter 7: Building Energy Savings Findings and Discussion.

CHAPTER 5

UHI MITIGATION STRATEGIES FINDINGS AND DISCUSSION

5.1 Remote Sensing Satellite Imagery

5.1.1 Land Cover Distribution in Years 1994-2005

The land cover classification and temperature distribution of Persiaran Perdana and its surrounding areas (i.e. a 10 km radius) were analysed and mapped using satellite imagery. Mapping was carried out to understand the impact of recent physical developments on the land cover distribution caused by changes of vegetation, building density and the use of the new materials on this site between 1994 and 2005. Based on the land cover distribution analysis using Definiens eCognition and ArcGIS 9.3 (ArcMap) software (presented in section 4.3.3), results presented in Table 5.1 indicated a 18.6% diminishment of vegetation and a replacement of hard surfaces in built-up areas of up to 8.2%, within a parameter of ten kilometres radius from the Persiaran Perdana area.

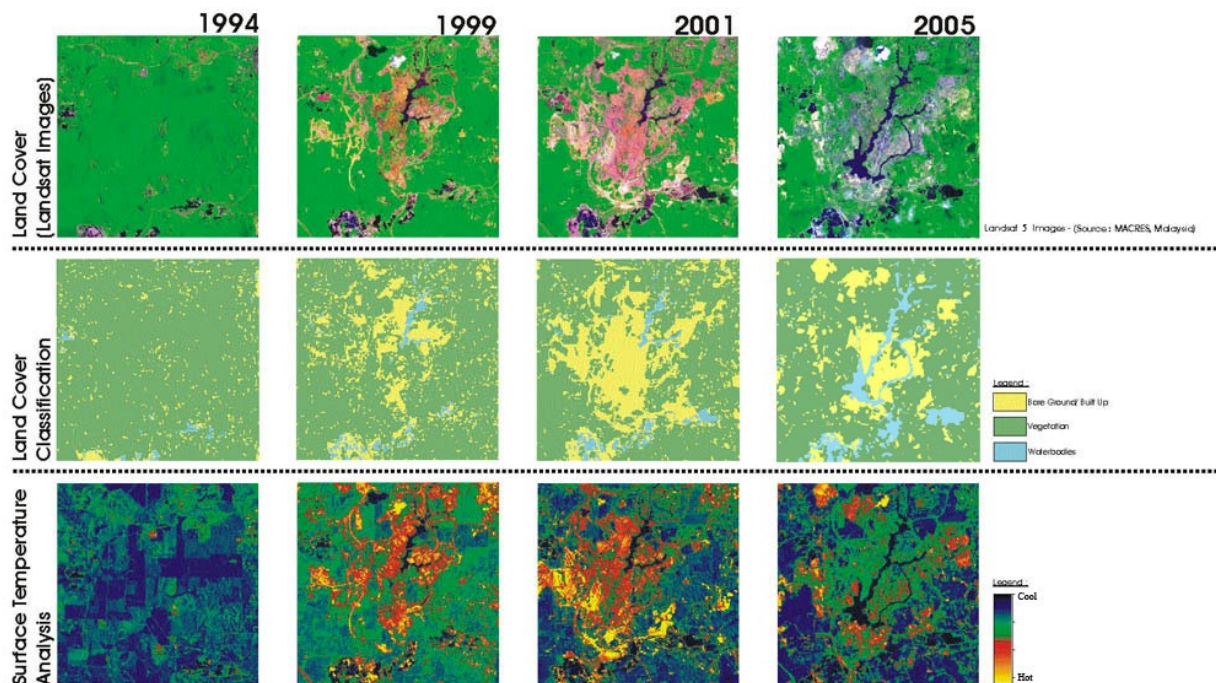

Figure 5.1 Land cover classification with thermal satellite images within 10 km radius of the Persiaran Perdana area from years 1994 to 2005

As presented in Figure 5.1, the development of new urban areas creates significant changes in land cover distribution especially in terms of vegetation and built up areas. Due to the same factors, the overall distribution of hot spot areas were found to be larger compared with 1994. Hot spot areas with a red colour mark represent the highest temperature within this area; these major conditions are believed to be one of the main contributors to the occurrence of UHI, having led to significant differences in temperature between 1999 and 2005.

Table 5.1 Land cover classification in areas and percentages from the years 1994 to 2005

Land Cover Area	1994		1999			2001			2005		
	sq m	%	sq m	%	△ %	sq m	%	△ %	sq m	%	△ %
Bare Ground	3231900	2.24%	17399700	12.08%	9.84%	35861400	24.90%	22.66%	6078600	4.22%	1.98%
Built-up	4618800	3.21%	9707400	6.74%	3.53%	11323800	7.86%	4.66%	13608000	9.45%	6.24%
Vegetation	134678700	93.53%	113974200	79.15%	-14.38%	91128600	63.28%	-30.24%	107919000	74.94%	-18.58%
Water Bodies	1470600	1.02%	2918700	2.03%	1.01%	5686200	3.95%	2.93%	16394400	11.39%	10.36%

The results from the years 1999 to 2001 (which refers to the time of the construction period) also reveal, approximately 30.2% of vegetation coverage being demolished and land exposed as bare ground accounting for at least 22.7% of the land coverage. These crucial events have created extreme changes to the environment in this area, with the largest hot spot areas arising during the period of construction.

However, after the development was completed in 2005, it was found that about 9.5% of land has been covered with a built up area representing: 4.2% of bare ground with unsettled development; 74.9% of vegetation coverage and 11.4% of water bodies. Theoretically, it would suffice to say that three quarters of the surrounding land being covered by vegetation is sufficient to balance the urban climate in the Persiaran Perdana area. However, the hot spot areas can still be found within this 4.2 km boulevard built up area.

With reference to Figure 5.2, 5.3 and Table 5.2, it can be observed that the majority of land cover in the Persiaran Perdana area is covered by a built up area of 40.4%; followed by an area of vegetation of 33.6% and a bare ground land area of 26.1%. Almost 66.4% of land is covered with buildings, roads, parking areas, pavements and bare ground.

In contrast to previous findings, the study concluded the amount of vegetation representing a quarter of land coverage was insufficient for balancing the urban microclimate

of the Persiaran Perdana. In addition, only 12.3% of vegetation areas are covered by a dense canopy and the other 21.3% is covered with green field.

Thus, it has been noted that the Persiaran Perdana is lacking in vegetation and this therefore suggests that a large amount needs to be added in order to balance the environment. Such conditions also contribute to larger hot spots, of which the majority are found within the built up areas consisting of hard surface materials and buildings. Thus, the main contributors to hot spots in this area are hard surface materials; such as pavement, tarmac and building materials situated within the built up areas not covered with vegetation. It can be concluded therefore that the changes to land cover distribution in the Persiaran Perdana and surrounding areas create new significant transformation of hot spot areas and temperature differences due to the lack of vegetation, development of new built up areas and changes to hard surface materials.



Figure 5.2 Land cover classification with thermal satellite images area in 2005

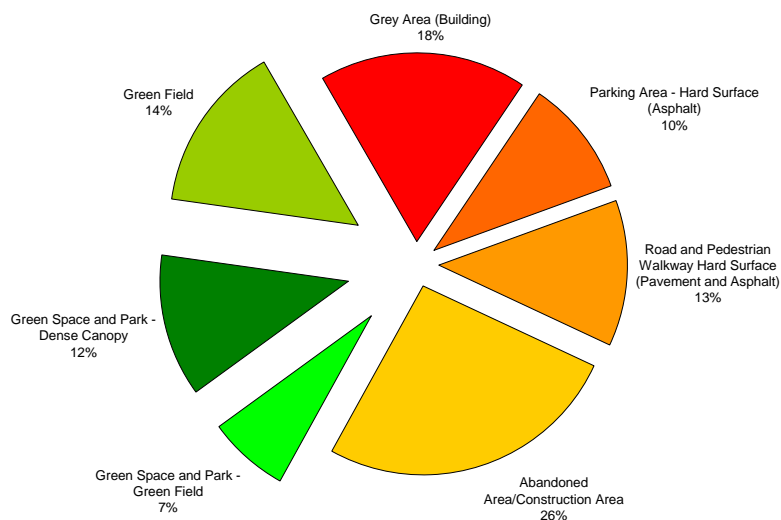

Figure 5.3 Diagram representing land cover classification in the Persiaran Perdana area

Table 5.2 Details of land cover classification in the Persiaran Perdana area

Land Area Conditions	Land Cover Classification	Area	Area (sqm)	Percentage in Detail Area (%)	Total Area (sqm)	Ratio (%)	Ration
Hard Surface Area	Built Up Area	Grey Area	402,754	17.85	1,498,999	66.44	2/3
		Parking Area - Hard Surface (Asphalt)	221,570	9.82			
		Road and Pedestrian Walkway					
	Hard Surface (Pavement and Asphalt)	286,046	12.68				
	Bare Ground	Abandoned Area/Construction Area	588,629	26.09			
Vegetated Area	Vegetation	Green Space and Park - Green Field	155,427	6.89	757,157	33.56	1/3
		Green Space and Park - Dense Canopy	276,333	12.25			
		Green Field	325,397	14.42			
Total			2,256,156	100	2,256,156	100	3/3

5.1.2 Hot and Cool Spots Distribution

Based on Figure 5.4, the satellite image is focused and zoomed to show 4.2 kilometres of the Persiaran Perdana. In order to obtain clear analysis of temperature distribution, the map and thermal satellite image have been combined and overlaid within the same boundary plot. From both images, it is apparent that most of red spot distribution is found at the same locations as buildings and follows the boulevard in the map. Red colour spots representing the highest temperatures can be found in areas such as car parks, squares and bare ground. This means that areas are amongst the main contributors to the highest temperatures, which contribute to the UHI occurrence in the Persiaran Perdana.

Most of the remarkable hot spot distributions are focused in the main focal area, where the majority of the buildings and users are frequently located. These spaces are also designed for public spaces as one of the tourist attraction areas in Putrajaya. These areas are fully occupied mostly during the daytime.

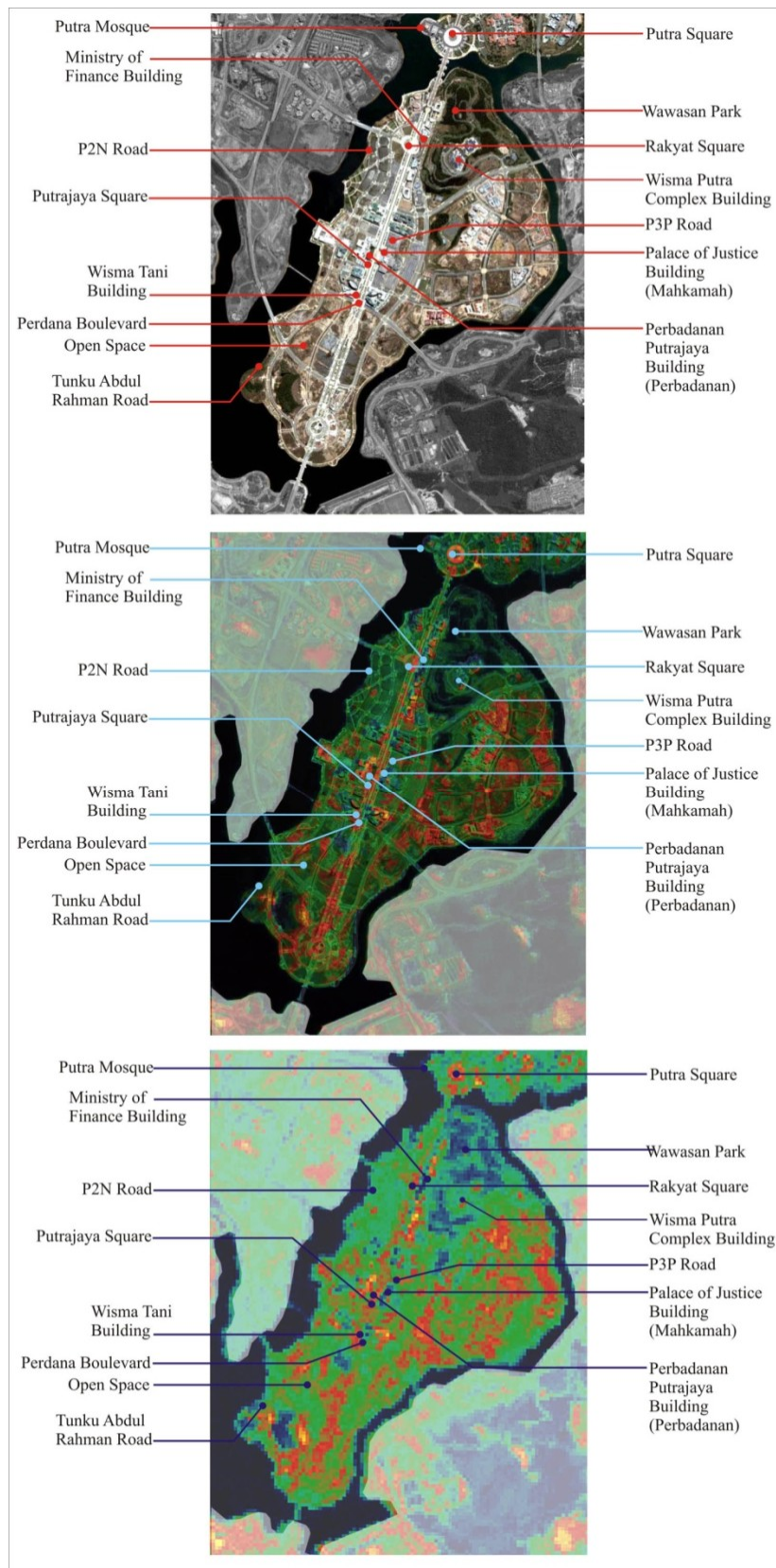

Figure 5.4. Map and overlaid Persiaran Perdana maps with hot and cool spot distribution

The focal areas, such as Putra Square, Rakyat Square alongside the Perdana Boulevard pedestrian area and Putrajaya Square were designed as an open space with major densities of hard surfaces (Figure 5.5). It is believed that non-vegetated areas with extensive use of pavements, tarmacs and majority of lower albedo materials are able to increase surface temperature and eventually decreased the surface moisture available for evapotranspiration. Although graphically most of the hot spot areas show very light colours of pavement suggesting high albedo for the area, the majority of ground material from concrete with darker red and yellow colour increased the heat from surface during the peak daytime period. High absorption of direct radiation is reradiated into heat due to high absorption of low albedo materials; especially major roads with tarmac materials. As a result, the sensible heat fluxes are higher, increasing the heat from ground surfaces and reducing the humidity of those areas.

Conversely, it is evident that blue spot distributions, representing the lowest temperatures are mainly found in large areas with a high density of vegetation. This environment creates a cool spot area where most of the elements are found as clusters of tree and vegetation. However, some areas are covered only by grass, such as the football fields, and are shown as a mixed distribution of blue and green spots; most likely due to cool surfaces of natural lawn.

The major area contribution to the lowest temperature (i.e. darker blue spot) is Wawasan Park and this is visually considered as an area of dense greenery. The recreational park, with an area of 56 hectares is covered with a mixture of grass and pavement. In addition, there are small cool spot areas which represent small pocket parks and green spaces around the Persiaran Perdana area (Figure 5.6). It can be observed that the darkest blue colour distribution is found at the central part of the dense green area and this is believed to be the result of the evapotranspiration process and results from tree shading.

Based on the surface temperature distribution, this environmental condition has impacted on the nearby areas. For instance, the Wisma Putra Complex building surrounded by the Wawasan Park has improved temperature distribution; the area is shown as slightly greenish in colour.

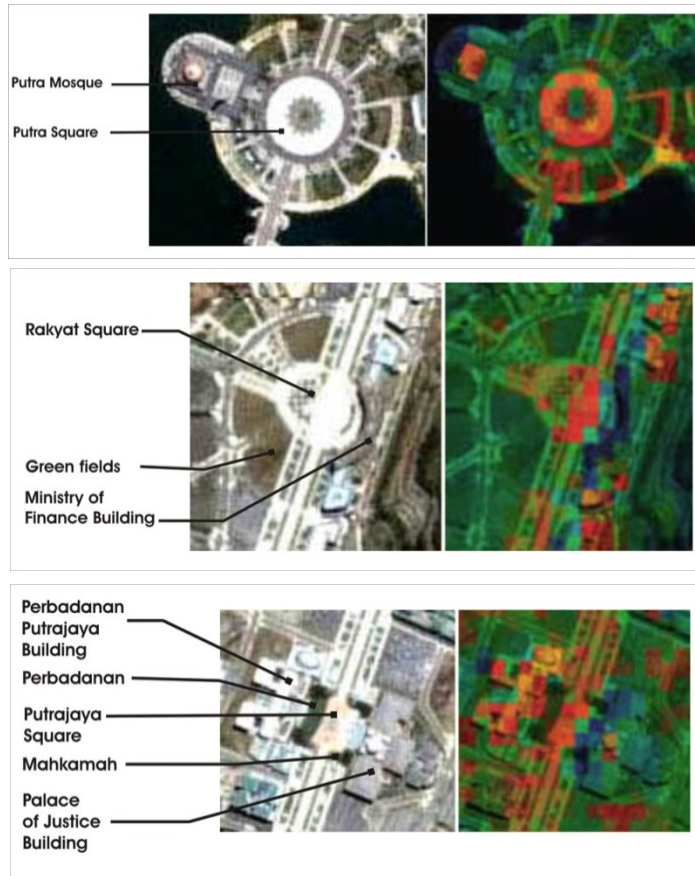
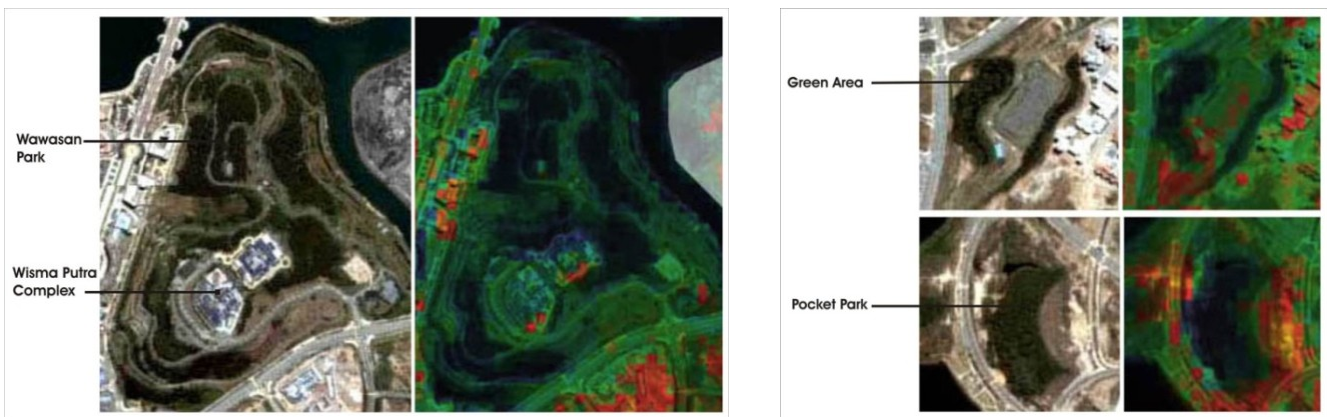

Figure 5.5 Putra Square (above); Rakyat Square (middle) and Putrajaya Square (below) hot and cool spot distribution

It is believed that evapotranspiration of high density of trees can reduce a certain amount of the surrounding ambient temperature and provide a significant cooling effect on the nearby environment.

Figure 5.6 Wawasan Park (left) green area and pocket park (right) hot and cool spot distribution



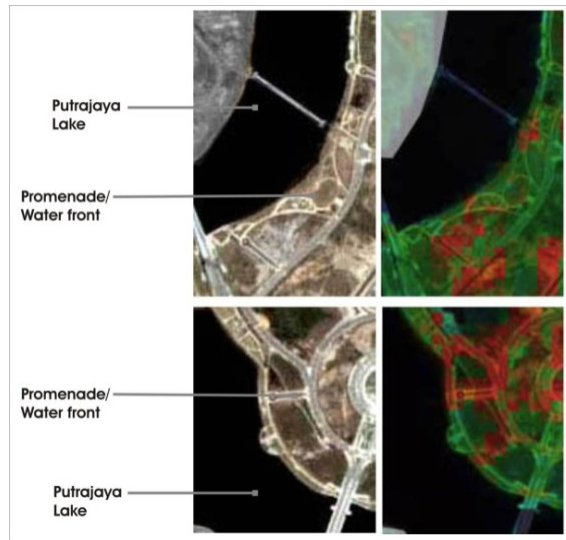

Figure 5.7 Promenades and water front hot and cool spot distribution

In addition to land surfaces, the design of this boulevard is surrounded by a man-made lake and the images with the darkest spots enclosed to the main island represent a large proportion of the water body. However, some areas near to the water body show insignificant differences in surface temperature (Figure 5.7).

It is noted that water vapour from the water bodies has not influenced the vertical plane of inland ground surfaces to any significant level. Conversely, it is believed that the water vapour will have considerable influence increasing the relative humidity; rather than reducing the surface temperature of the surrounding area.

Thus, based on the overall results it confirms that spaces with a high density of hard materials such as buildings, pavement, roads and parking areas contribute to the highest air and surface temperatures in the Persiaran Perdana. It is believed the majority of these elements increase the chances of creating a UHI phenomenon in the Persiaran Perdana are higher; even though the area has been provided with green spaces. This is due to the higher amount of sensible heat fluxes from the surface materials that heat the air and increase the surrounding air temperature effectively.

Conversely, the appearance of latent heat fluxes is lower due to the small amount of trees that reduce and block direct radiation and cool the surface underneath the trees. The

amounts in the evapotranspiration process are lower due to the small quantities of trees that are not balanced with a hard surface area. Therefore, in further analysis, these critical spot areas (i.e. spaces that create significant hot and cool spots) were considered and selected as a measuring point to evaluate their contribution towards the current microclimate in the Persiaran Perdana area.

5.2 Field Measurement Programme Results

5.2.1 Current Condition of Air Temperature in Persiaran Perdana area

Figure 5.8 shows the average temperature at three urban stations (Persiaran Perdana, Parlimen and Petaling Jaya) and one rural station (Pusat Pertanian Serdang) over the period of one month in February 2009. The error bars represent the variation, high and low daily values around the 24 hour mean and are colour coded for each station.

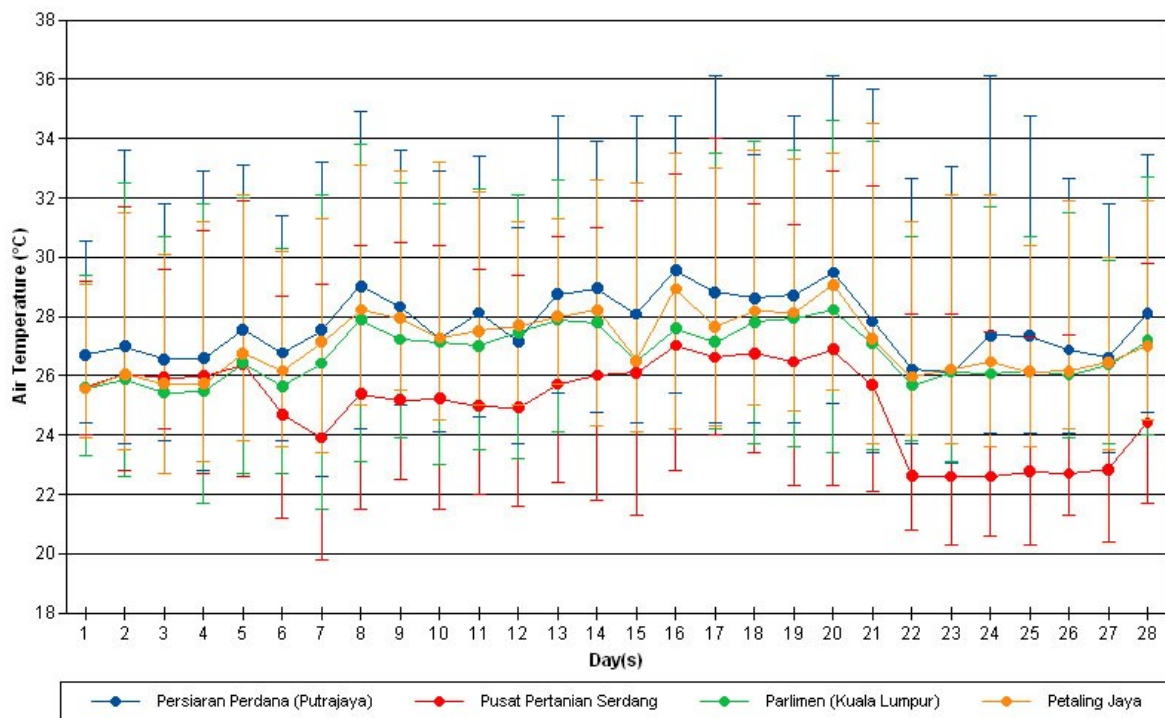

Figure 5.8 Average urban and rural temperatures during one month measurement period

The lines representing the mean daily temperature for Persiaran Perdana are consistent and clustered on top, as compared to the other urban stations, with an average air temperature of 27.7°C. The other two urban stations indicated an average of 27.1°C and 26.7°C for Parlimen and Petaling Jaya, respectively. In contrast, the rural station line is mostly at the bottom, nearer to the X-axis. This indicates that the rural station shows the lowest average air temperature compared to other stations at 25.1°C, and shows the largest variation from the urban-rural station of Persiaran Perdana with a magnitude of 2.6°C. The other two stations have differences with magnitudes of 2.0°C and 1.6°C for Petaling Jaya and Parlimen, respectively.

Obviously, this indicates the presence of a UHI in these three urban areas during the period of measurement. However, newly developed areas, such as Persiaran Perdana, have the highest UHI intensity when compared with the two older urban areas. This also revealed the current air temperature condition during the month of February in Persiaran Perdana; the month when it is exposed to the highest average solar radiation of the year (Azhari et al, 2008).

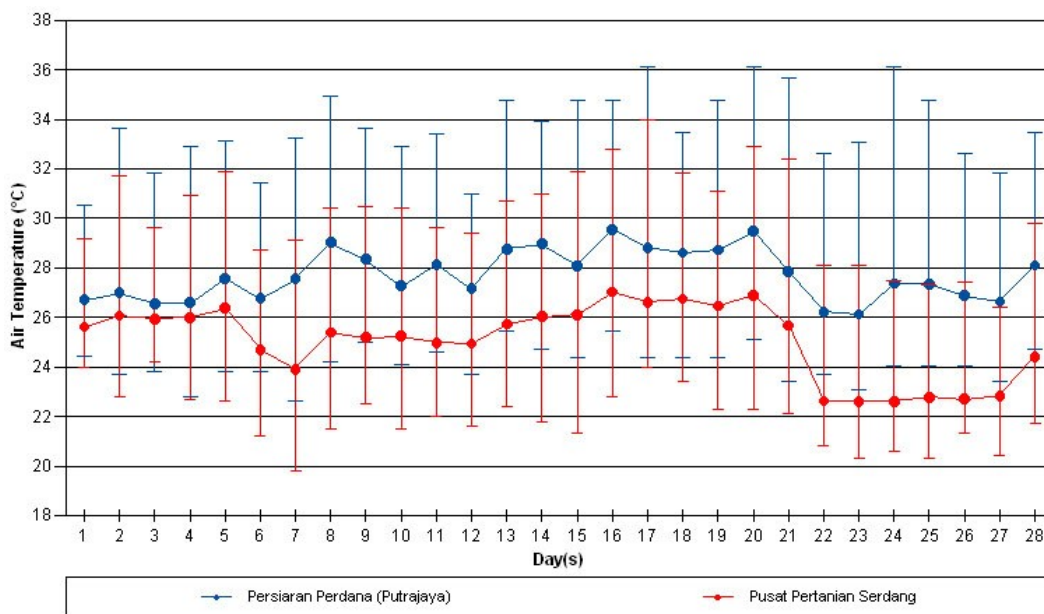

Figure 5.9 Comparison of average Persiaran Perdana (urban) and Pusat Pertanian Serdang (rural) temperatures during one month measurement period

The average one month trend (Figure 5.9) when comparing both urban and rural stations (i.e Persiaran Perdana and Pusat Pertanian Serdang) reveals a consistent pattern of higher urban average temperatures with large amplitude differences of 0.6°C to 4.7°C. In

fact, the maximum temperature here could reach 36.1°C compared to 34.0°C in the rural station. This large range of temperature difference is due to the dissimilarity of environmental conditions in both stations. The Persiaran Perdana pattern represents the highest number of hard surface materials, with less vegetation when compared to the rural station. This rural condition creates a larger cooling effect on the area and keeps the average air temperature at its lowest rate.

Unlike the Persiaran Perdana area, the heat from hard surfaces, such as buildings and pavements creates the highest averages, which reach their maximum during the peak hours of daytime. Having lesser amounts of vegetation; the sensible heat from hard surface materials that are exposed to the air increases the ambient temperature and keeps the environment hotter than in rural areas. For instance, it can be observed from the 22nd to the 28th days that the urban-rural air temperature difference is higher, within the range of 3.5°C to 4.8°C; it is believed that this is due to the heat that is trapped in the urban environment maintaining the same average temperature over subsequent days.

On the contrary, the existence of large cooling effects from vegetation and less hard surface materials keeps the average temperature, until it reaches a high again on the 28th day. Thus, the Persiaran Perdana has a higher urban air temperature when compared with the rural area due to the hard surface and lack of vegetation in this area.

5.2.2 Average, Maximum and Minimum Air Temperature at 13 Measurement Points

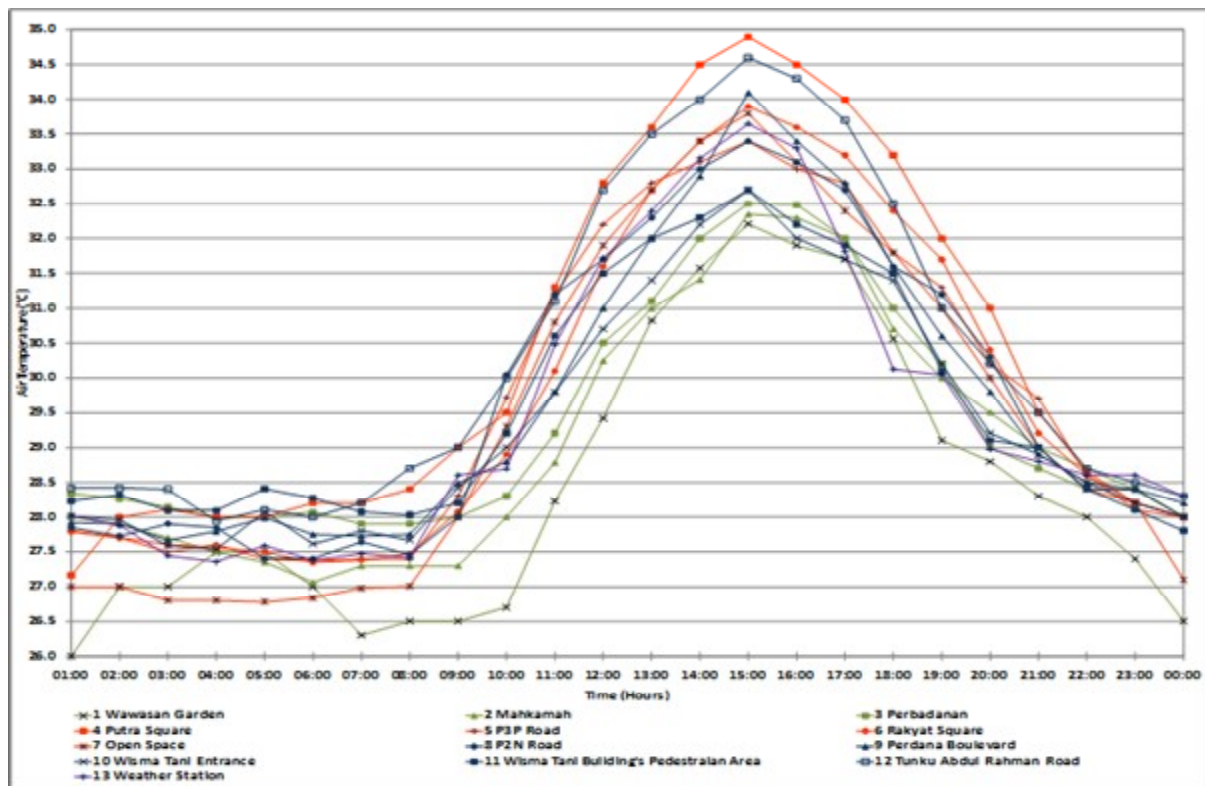

Figure 5.10 Mean hourly air temperature at 13 measurement points in a typical clear day

Based on the field measurements conducted from the 1st February to 3rd March 2009, a typical clear day in 28th February was randomly selected in order to give an overview of the temperature changes at each measurement point as a reference for later analyses. Figure 5.10 shows the mean hourly air temperature in a typical day at 13 location points in the Persiaran Perdana. Each individual colour represents landscape environment groups, i.e. green for green spaces; red for open hard surface areas and blue represents a mix of environment areas. Obviously, it can be observed that most of the measurement points that have a high density of hard surfaces are among those on top of the graph.

The significant areas such as Putra Square, Tunku Abdul Rahman Road, Rakyat Square, P3P Road, Open Space and Perdana Boulevard area have a major element of hard surface (i.e. pavement and tarmac) which contributes to the highest temperature between peak times from 14:00 to 15:00 hours. As in tropical climates, peak daytime air temperature is most critical due to high exposure to solar radiation (Shahidan et al, 2010). During peak hours, Putra Square shows the highest peak temperature of 34.9°C followed by Tunku Abdul Rahman Road, Perdana Boulevard, Rakyat Square, Open Space, P3P Road and P2N Road

with 34.6°C, 34.1°C, 33.9°C, 33.8° and 33.4°C respectively. In fact, the measurement points located near a water body (i.e. Tunku Abdul Rahman Road and P2N Road) show a remarkably high temperature during peak hours. It can also be noted that Putra Square, Tunku Abdul Rahman and Perdana Boulevard areas show a higher maximum temperature than the weather station reading. Thus, these three major areas can be considered as the highest heat contributors to the Persiaran Perdana area.

Overall, the results correlate with the red spot distribution where most of these measurement points contribute to higher temperatures during daytime peak hours. These results confirm the earlier assumption that the areas with a high density of hard surfaces contribute more sensible heat than those that heat up the surrounding air; and create a hot spot with high air and surface temperature. Indeed, the majority of these areas are believed to be among the contributors to UHI occurrence in the Persiaran Perdana, compared to other areas; and the findings correlate with earlier hot and cool spots images results. Thus; these critical areas need further consideration in terms of mitigating the impact of the UHI in order to reduce the air temperature, especially during peak hours.

Conversely, it can be observed that the majority of the measurement points with greenery environments are clustered at the bottom part of the graph. The Wawasan Park, Mahkamah and Perbadanan show the lowest maximum air temperatures during peak daytime hours compared to other measurement points with 32.2°C, 32.3°C and 32.5°C respectively.

Obviously, the lowest maximum temperature can be obtained from these areas due to the coverage of urban trees. In the tropics, the shade coverage condition is important during the middle of the day when the solar position is overhead and at its hottest (Kotzen, 2003, Shahidan et al, 2010). During these hours, the shade is concentrated directly around the canopy starting from 12:00 hours (Shahidan et al, 2010, Tukiainen, 2010). This condition provides full shade coverage; influencing the effectiveness in warming the air less due to larger shaded areas that reduce surface temperature underneath the canopy. It is believed that where more latent heat fluxes are released due to the process of evapotranspiration the lower the ambient temperature during peak hours. Thus, it can be noted that the cooling effect of trees creates a remarkable effect on lowering air temperature in surrounding areas.

Conversely, the Wisma Tani's pedestrian area and Wisma Tani entrance, located between buildings and clustered in a greenery environment, illustrate the lowest temperature at peak time. Based on further investigation and observation in these two areas, this occurs principally due to the fall of shade from tall buildings and trees which occurs during those hours. In fact, the shade continues until 19:00 hours due to the orientation of buildings being east facing. Thus, it can be noted that shade from buildings plays a role in reducing the air temperature of surrounding areas. In fact, the importance of shade is notably significant in reducing the air temperature, whether it originates from buildings or trees. However, the temperatures gradually increase at night and this is believed to be the result of the heat accumulated by buildings and hard surfaces during the day time, which are subsequently expelled slowly during night-time.

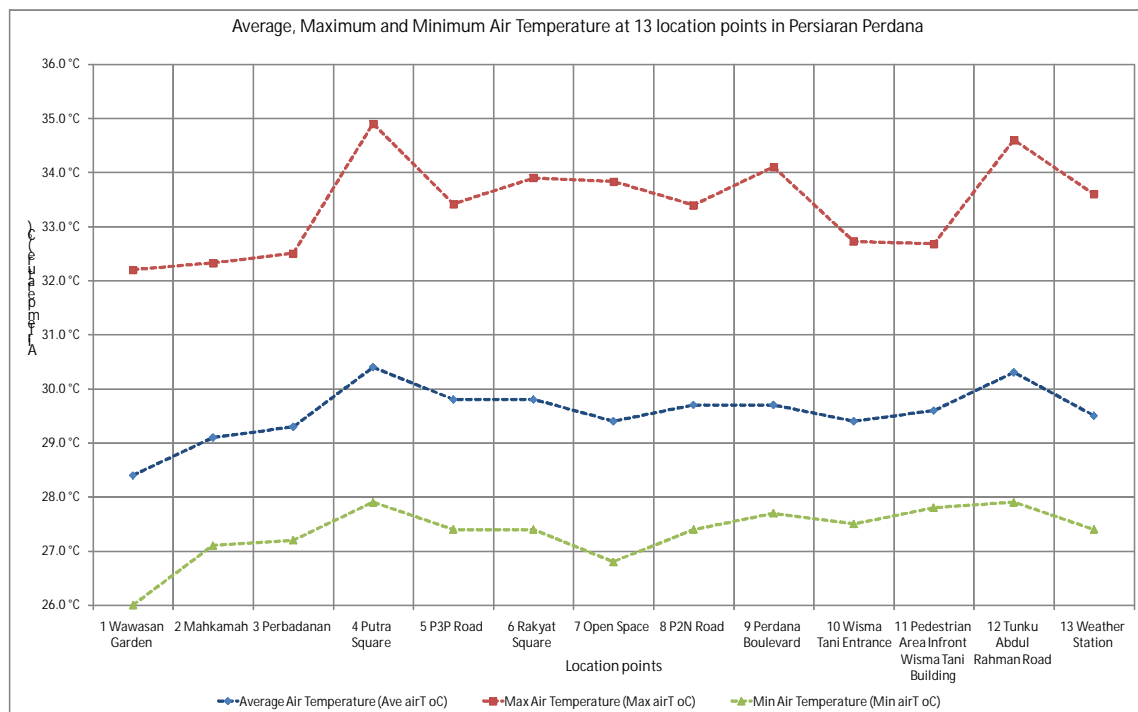

Figure 5.11 Average, maximum and minimum air temperature in 13 measurement points

In comparing each measurement point and landscape environment group, the average, maximum and minimum of air temperature during the selected day of the measurement period are plotted in Figure 5.11. As far as the average temperature is concerned, the pattern is very obvious. There are fluctuations within some groups; however, the dominant trend from low to high temperatures remains unchanged.

The average temperature ranges from 28.4°C to 30.4°C, representing a difference of about 2.0°C. Conversely, it can be perceived that the maximum temperature difference at different locations is very significant. The maximum difference is about 2.7°C between the two locations of Wawasan Park and Putra Square. Both locations varied accordingly due to the presence of dense green areas in Wawasan Park. As mentioned earlier, the maximum temperature is of significant importance in the tropics, since it determines the outdoor comfort level and energy use in buildings in urban areas (Wong et al, 2007, Shahidan et al, 2010). Thus, the large differences of maximum temperature need to be reduced in order to mitigate the effect of UHI in the Persiaran Perdana. This verifies the importance of this study in maximising the cooling effect in this area so as to mitigate the actual UHI condition in the Persiaran Perdana.

It is also worth considering that the minimum air temperature represented at night-time hours show a significant difference, with a magnitude of 1.9°C. It can be seen from the lowest minimum air temperature occurring at Wawasan Park with 26.0°C, compared to 27.9°C for Putra Square locations. This correlates with the study by Wong et al (2007) that previously verified the hypothesis that heat accumulated in the daytime is minimally dispersed during night-time because of the majority of hard surface materials and buildings. The heat from night-time will therefore retain the temperature and the reduction of air temperature will be lesser. Conversely, the effect of cooling from trees during the daytime is insufficient to balance the overall temperatures during the night-time. In this case, the quantities and the implementation of the suitable tree densities could therefore improve the current environmental condition in the Persiaran Perdana.

5.2.3 Average, Maximum and Minimum Relative Humidity

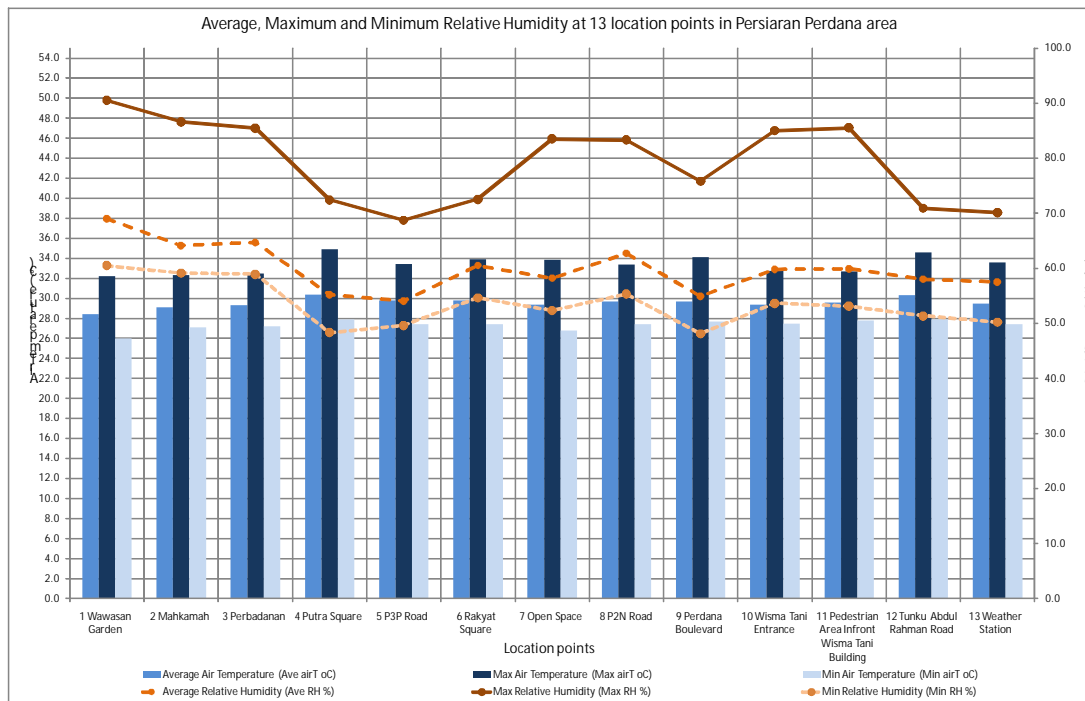

Figure 5.12 Average, maximum and minimum relative humidity in 13 measurement points

Figure 5.12 shows the average, maximum and minimum air temperature and relative humidity at each location point. In contrast to air temperature, the main concern is related to the minimum relative humidity during the hottest period of the day. The graph shows that most of the areas with major elements of hard surface have a higher maximum temperature and lower minimum relative humidity. The Putra Square area is clearly found to have the highest maximum air temperature and lowest minimum relative humidity with 34.9°C and 48.3% respectively. This is again due to the large proportion of surface materials and a less vegetative environment. Moreover, the same conditions occur in high focal areas, namely, Perdana Boulevard and Rakyat Square where maximum air temperatures are found to be at 34.1°C and 33.9°C with 48.1% and 54.6% in minimum relative humidity, respectively.

In contrast, the highest minimum relative humidity can be found in areas of greenery such as Wawasan Park, Mahkamah and Perbadanan. It is believed that greater shading and evapotranspiration occurs in these areas at midday, due to the larger amounts of dense planting. This makes it possible to maintain a lower ground surface temperature and therefore dramatically increases the moisture content due to a higher latent heat flux and influence on the air temperature. As a result, the surrounding air temperature becomes lower and the

relative humidity increases. Thus, it is asserted that the variation in relative humidity is related to changes in air temperature and can be affected by the presence of vegetation.

This can be seen in high density areas such as Wawasan Park which found to be areas of humidity with a minimum of 60.5% and a 32.2°C maximum air temperature. This continues with Mahkamah and Perbadanan with average dense and sparse greenery conditions of 59.1% and 32.3°C and 58.9% and 32.5°C respectively. Thus, it can claim that the differences in tree density and quantities offer a variation in air temperature and are one of the key factors that can be modified in offering a better environment. It is believed that the variation of the cooling effect can be achieved due to the modification of tree densities and quantities.

However, it is worth mentioning that location points near water bodies are higher in relative humidity. The minimum relative humidity for P2N Road and Tunku Abdul Rahman Road locations are found to be at 55.3% and 50.2% respectively. It is therefore noted that water bodies are able to increase relative humidity due to the high water vapour content in the atmosphere. However, the effect of trees in modifying the relative humidity is much greater than the effect from static water bodies, especially at the street level.

5.2.4 Average, Maximum and Minimum Surface Materials and Grass Surface Temperature

Figure 5.13 shows the average, maximum and minimum air temperatures compared to surface materials and grass surface temperatures at 12 location points. It clearly shows that most of the areas occupied with plenty of vegetation, have a lower air and surface temperature. The Wawasan Park, Mahkamah, Perbadanan and Wisma Tani Building pedestrian areas show a lower ground and grass surface temperature compared to the areas with a high density of hard surfaces. On average, the maximum surface temperature reduction is found with a magnitude of up to 20°C. It is believed that shade from the trees creates a remarkable reduction in the surface temperature. In addition, both ground materials (pavement and grass) are much cooler and are able to maintain higher moisture retention and slow the evaporation process in the soil, because of the effect of shade.

The occurrence of the evapotranspiration process modifies the surrounding environment with the reduction of the air temperature and also increases relative humidity in that area. Furthermore, the use of high albedo materials and grass cover will lead an increased impact on the microclimate components.

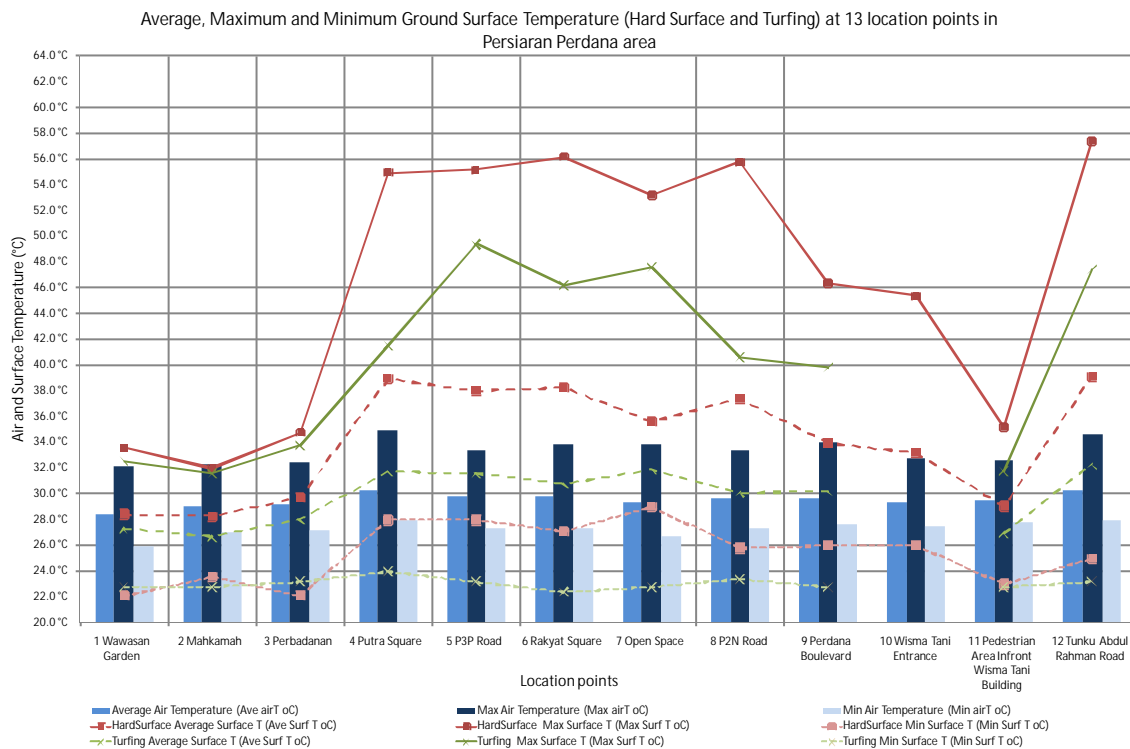

Figure 5.13 Average, maximum and minimum of ground surface temperature in 12 measurement points

Conversely, most high density hard surface areas, such as Putra Square, P3P Road, Rakyat Square, P2N Road and Perdana Boulevard are among the highest maximum ground surface temperatures. The largest maximum air temperature can be found with magnitudes of up to 57.4°C within these areas. This is due to the exposure of high solar radiation and the dryness of ground surfaces that creates more sensible heat rather than latent heat. The higher the surface temperature, the higher the air temperature likely to be found during peak hours. Therefore, it is sufficient to note that the air and surface temperatures are the two major microclimate entities that correlate with each other. It is therefore important to investigate the difference of surface materials in respect of the surface temperature in the Persiaran Perdana.

5.2.5 Average Surface Temperature on Six Major Ground Surface Materials

Figure 5.14 shows the average measured surface temperature within six major ground surface materials used in the Persiaran Perdana. The exposed materials of tarmac shows the highest average surface temperature at 43°C; red concrete imprint is 40°C; white granite is 38°C; yellow concrete pavement is 36.8°C; polished/shining white granite is 33.2°C; and finally grass is coolest at 32.4°C. Meanwhile, ground materials beneath tree shading shows a remarkable reduction as tarmac shows the average surface temperature at 31.9°C; red concrete imprint pavement is 31.8°C; white granite is 31.6°C; yellow concrete pavement is 31.2°C; polished/shining white granite is 29.6°C; and finally grass is coolest at 28.5°C. This shows that up to 20% of surface temperature reduction when ground surface materials placed beneath the trees.

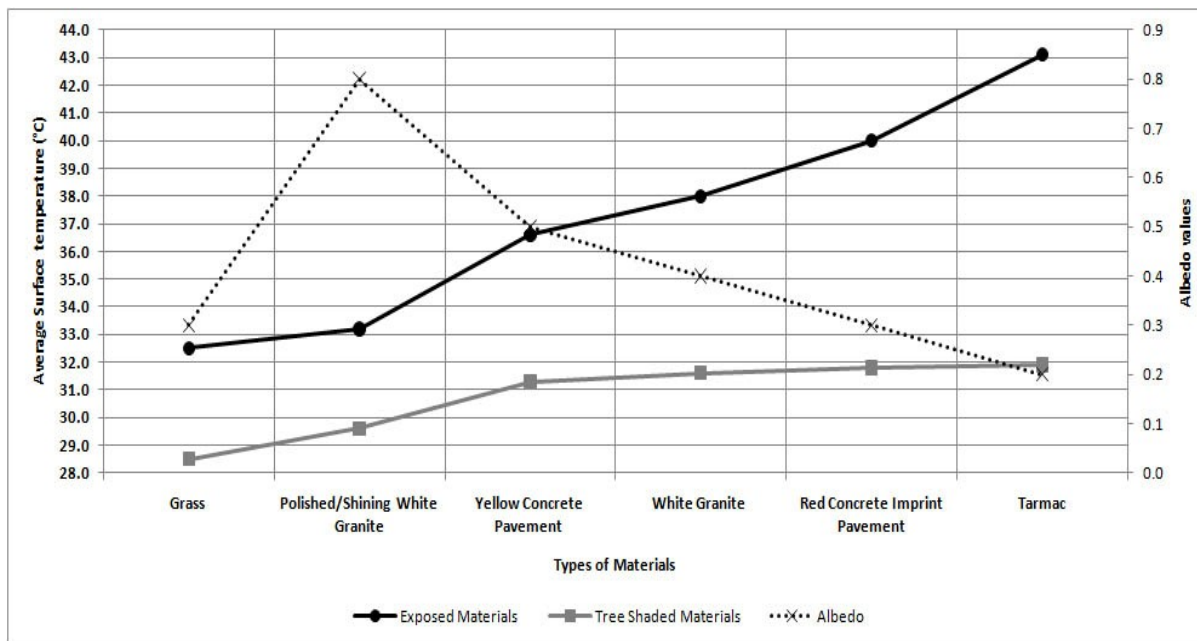

Figure 5.14 Average surface temperatures of ground surface materials in the Persiaran Perdana

This result also correlates with standard albedo values in each material where the tarmac was found to be 0.2; red concrete imprint pavement, 0.3; white granite, 0.4; yellow concrete pavement 0.5; and, for polished/shining white granite, 0.8. Although albedo for the grass is lower than other materials at 0.3 (Santamouris, 2001), the low surface temperature was due to the high moisture content in the soil. However, it is worth mentioning that with high albedo materials, such as polished white granite, the performance in lowering the surface temperature is similar to grass with a small difference of 0.6°C. Thus, it can be noted that

these materials are recommended as cool materials for use in the Persiaran Perdana area. The greater impact can be seen when these ground materials placed underneath the shade of trees. It is also evident that the variations of albedo values in surface materials provide a significant impact on air and surface temperature differences. Thus, this confirms that the modification of this physical property is significantly important for reducing both air and surface temperature in the Persiaran Perdana.

5.2.6 Discussion: Current Condition of Persiaran Perdana

Ultimately, it can be noted that most of the areas which have high and low air and surface temperatures are correlated with the same hot and cool spot distribution from satellite images. The vegetation and hard surface materials that create variation values in surface temperature are highly influential on the output values of air temperature and relative humidity. It should be noted that further consideration needs to be taken into areas with critical conditions such as Putra Square, P3P Road, Rakyat Square, Open Space, Perdana Boulevard and Tunku Abdul Rahman Road.

Based on the above findings, the areas can be improved efficiently by providing more trees and cool materials in order to reduce the impact towards air and surface temperature. The optimum cooling effect needs to be quantified by proposing new modification scenarios and identified performance on per-tree cooling effects from variation of tree density. A combination from both modifications needs to be introduced in quantifying the outcome from each of the modification scenarios. Therefore, investigation into the modification of these two elements is of prime importance in order to promote a desired optimum cooling effect to the surrounding area; and ultimately mitigate the UHI effect.

5.3 Computer Simulation Programme Results

5.3.1 Validation of ENVI-met model: Computed and Measurement Comparisons

For validating the accuracy of the model, an experiment has been conducted based on the actual one day measurement selected in the above field measurement study in the Persiaran Perdana (i.e. February 28, 2009). As the air temperature and ground surface temperature becomes the main concern in the overall condition of the tropical urban climate, the above results were compared with simulated results obtained with ENVI-met. A horizontal resolution of 20 m x 20m was chosen for the model area. For this comparison, the adjustment of a 1.1 m/s difference could be set for the wind speed to fit with the measured data for air temperature and surface temperature as was further explained in the earlier section 4.3.6.2.1. Twelve selected location points were evaluated in this experiment.

Figure 5.15 shows the air temperature T_a at three meter heights simulated by ENVI-met, plotted against measured T_a at 12 location points in the Persiaran Perdana. Considering the complexity of the three dimensional environment, ENVI-met is found to well represent the trends of T_a with its two contrasting periods at every location point. It can be observed that most of the areas which simulated values of T_a were overestimated early in the morning and at night time. This is due to the weakness of the model in the prognosis of the night time situation, i.e. overestimation of air temperature and the lack of the nocturnal heat release process as no heat is stored in the building fabric (Ali-Toudert, 2005 and Fahmy et al, 2010).

Nevertheless, the average error during these hours was found to be at 0.6°C. In daytime, the difference between measured and computed air temperature is found to be the same with a 0.6°C average error. In 24 hour simulations, the differences for twelve location points show about a 0.9°C average error. In fact, similar 24 hour air temperature curves were achieved on the calculated correlation coefficient, R^2 , between the measured and computed for measurement point ranged from 0.905 to 0.975 and tabulated in Table 5.3. Thus, the measured and computed ENVI-met for T_a is well correlated and considered reliable in presenting the current air temperature condition of the Persiaran Perdana.

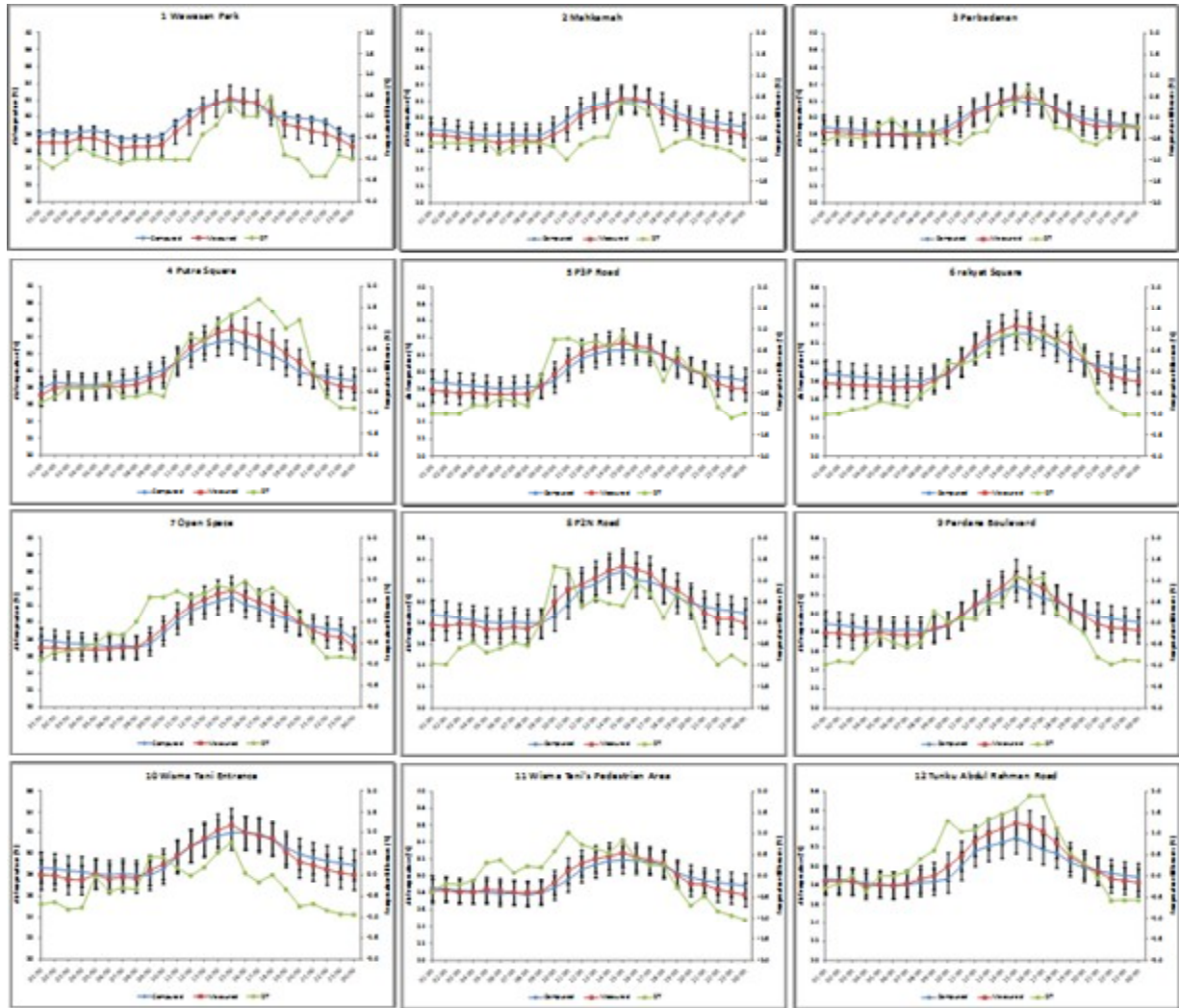

Figure 5.15 Comparison between measured and computed air temperature for 12 location points

Table 5.3 Correlation coefficients between the measured and the computed air temperatures for each location in a 24 hour period

Location points	Environment	
	Air Temperature	
	Correlation coefficient (R ²)	Average Error (°C)
1. Wawasan Park	0.956	-0.8
2. Mahkamah	0.975	-0.5
3. Perbadanan	0.972	-0.2
4. Putra Square	0.970	0.1
5. P3P Road	0.958	-0.2
6. Rakyat Square	0.970	-0.2
7. Open space	0.965	0.6
8. P2N Road	0.923	-0.1
9. Perdana Boulevard	0.959	-0.2
10. Wisma Tani Entrance	0.933	-0.3
11. Wisma Tani's Pedestrian Area	0.905	0.1
12. Tunku Abdul Rahman Road	0.957	0.5

Figure 5.16 shows the surface temperature T_s at ground level simulated by ENVI-met plotted against measured T_s at 12 location points in the Persiaran Perdana. It is evident, that most of the location points do not exceed the acceptable band except in one calculated point in Rakyat Square; Wawasan Park and Mahkamah. In the case of Rakyat Square, this may be caused by moulder conditions at the ground surface which modifies the colour and the albedo values of materials. This condition makes the ground surface temperature higher during the peak hours on site compared to the simulated results.

Conversely, in the case of Wawasan Park and Mahkamah, the measurements taken during this time were inconsistent due to changes in the shading effect of trees. It is obvious that there is a much larger convergence between those measured and computed in terms of surface temperature, than between those measured and computed in terms of air temperature. The average error for the 12 location points in the whole period of measurement from 07:00 to 00:00 hours was found to have a magnitude of 1.3°C. In the daytime, the average was found to be 1.2°C; however, the errors become larger with a magnitude of 1.6°C at night time. Nevertheless, overall similar curves were achieved on calculated correlation coefficients, R^2 , between those measured and computed on 12 measurement points ranging from 0.860 to 0.973 and tabulated in Table 5.4. Thus, it is sufficient to say that the measured and computed ENVI-met for T_s is correlated and dependable in presenting the current surface temperature of the Persiaran Perdana.

Table 5.4 Correlation coefficients between the measured and the computed surface temperatures for each location in 24 hour period

Location points	Environment	
	Surface Temperature	
	Correlation coefficient (R^2)	Average Error (°C)
1. Wawasan Park	0.919	-0.7
2. Mahkamah	0.860	-0.5
3. Perbadanan	0.972	-0.1
4. Putra Square	0.973	1.0
5. P3P Road	0.973	-0.6
6. Rakyat Square	0.969	0.0
7. Open space	0.952	0.5
8. P2N Road	0.972	-0.9
9. Perdana Boulevard	0.971	-0.9
10. Wisma Tani Entrance	0.972	-0.5
11. Wisma Tani's Pedestrian Area	0.969	0.6
12. Tunku Abdul Rahman Road	0.970	1.5

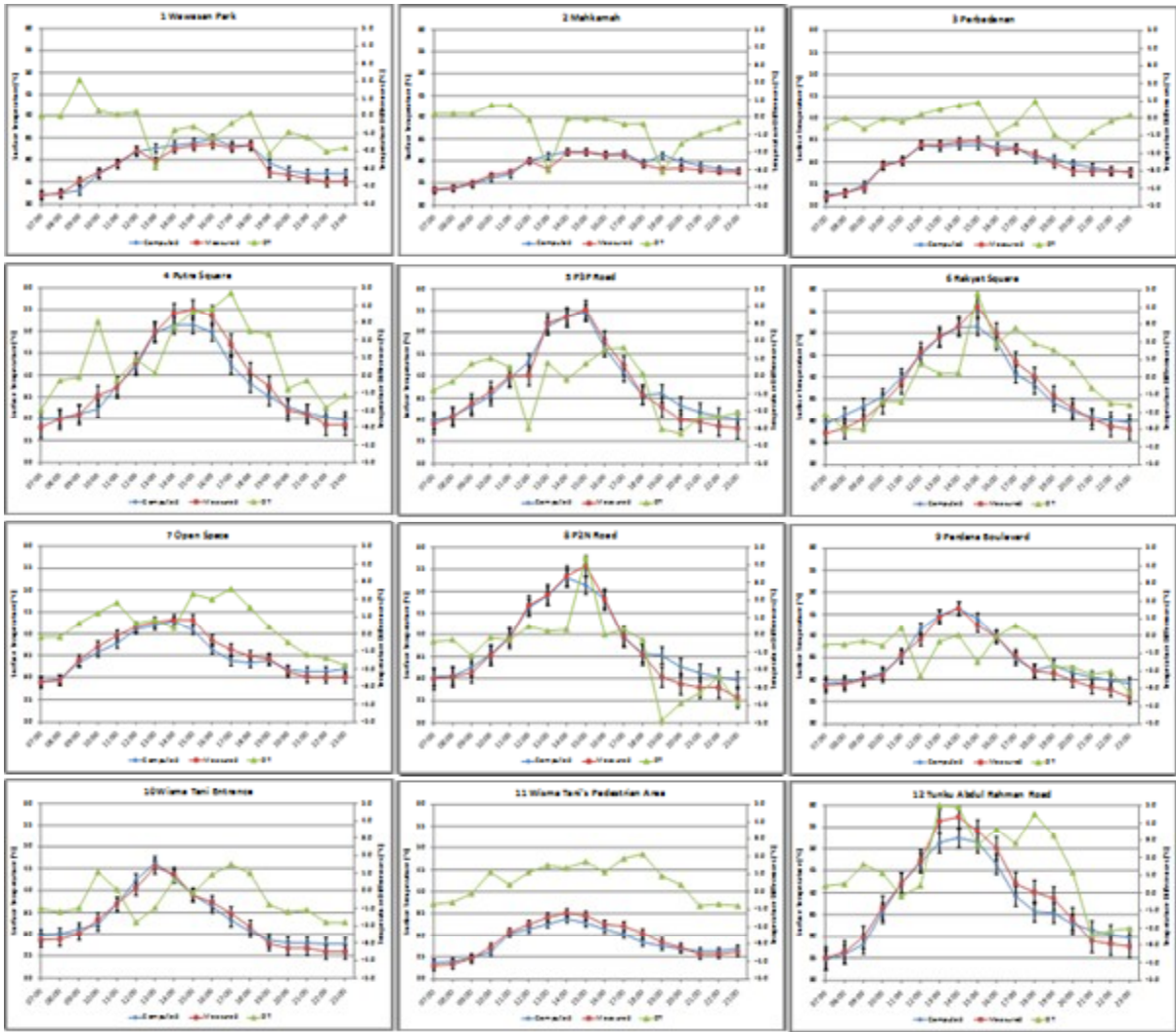

Figure 5.16 Comparison between measured and computed surface temperature for 12 location points

5.3.2 Tree Cooling Effect Performance Results

The tree cooling effect performance prediction has been simulated based on the results from leaf area index and leaf area density field measurement of four different types of tree. The results of LAD distribution, z_p ; average distribution of LAD, LAD_{ave} ; and LAI of each selected trees are presented in Table 5.5.

Table 5.5 Results of tree area density and leaf are index for four different tree species

ID	Name	Height, H	LAD distribution (z_p = height of the plant)										LAD average distribut ion	LAI
			0.1 z_p	0.2 z_p	0.3 z_p	0.4 z_p	0.5 z_p	0.6 z_p	0.7 z_p	0.8 z_p	0.9 z_p	1.0 z_p		
ml	<i>Malaleuca leucadendron</i>	8	0.000	0.060	0.070	0.110	0.130	0.150	0.140	0.130	0.100	0.040	0.12	0.9
fd	<i>Flicium decipiens</i>	8	0.000	0.075	0.075	0.075	0.250	1.150	1.060	1.050	0.920	0.075	0.59	4.7
mf	<i>Mesua ferrea</i>	8	0.000	0.000	1.140	1.140	1.140	1.425	1.425	1.140	0.570	0.000	1.00	7.9
Fb	<i>Ficus benjamina</i>	8	0.000	0.000	0.000	1.620	1.620	1.620	2.025	2.025	0.810	0.000	1.22	9.7

5.3.2.1 Air Temperature

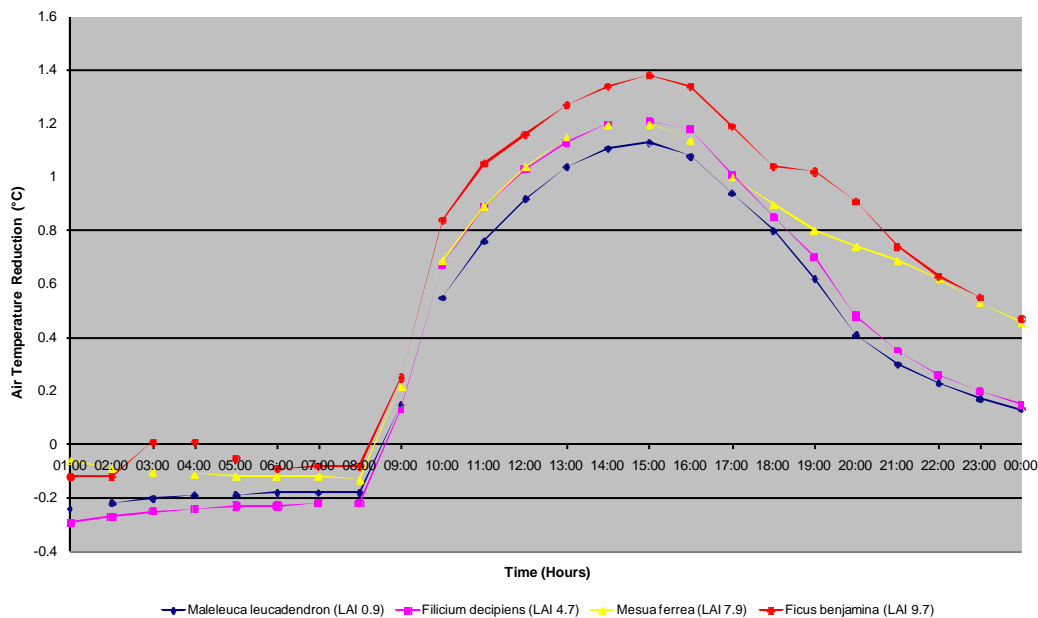

Figure 5.17 Comparison of hourly temperature reductions for four different tree species in a 24-hours period

Figure 5.17 shows the hourly air temperature reduction for four different types of tree species in a 24 hour period. Obviously, the effect of trees in reducing the air temperature occurs from 08:00 and gradually increases until it reaches the peak at 15:00 hours; subsequently the effect starts to decrease gradually in the evening. However, the individual effect of each tree can be seen based on the gap differences ranging from 10:00 to 16:00.

During the peak hour, the *Ficus benjamina* (Fb) shows the highest maximum reduction with a magnitude of 1.38°C difference from the outside air temperature. This is followed by *Filicium decipiens* (fd) and *Mesua ferrea* (mf) both with a maximum reduction of 1.2°C and the lowest maximum reduction of 1.1°C for *Malaleuca leucadendron* (ml). During these hours, it can be observed that the tree shading effect is greater during the middle of the day from 12:00 to 15:00 when the solar position is overhead and at its hottest. The shade is concentrated directly around the tree canopy and provides fullest shade. Thus, the air temperature becomes lower compared to the outside ambient temperature and is affected until it reaches its peak at 15:00 hours.

This is correlated to the Kotzen (2005) and Shahidan et al. (2010) studies which also reported the greatest effect from tree shading during these hours. In addition, it is believed that the process of evaporation and transpiration in each tree was different due to the amount of leaves and the density of shade created throughout those hours. In addition, the process of radiation filtration was varied according to the canopy density of each tree (Brown and Gillespie, 1995; Shahidan et al, 2010).

Table 5.6. Results of leaf area density (LAI) and average temperature reduction for four different tree species

Tree Species	LAI	Average Air Temp Reduction (°C)
<i>Maleleuca leucadendron</i>	0.93	0.37
<i>Filicium decipiens</i>	4.73	0.42
<i>Mesua ferrea</i>	7.90	0.51
<i>Ficus benjamina</i>	9.72	0.60

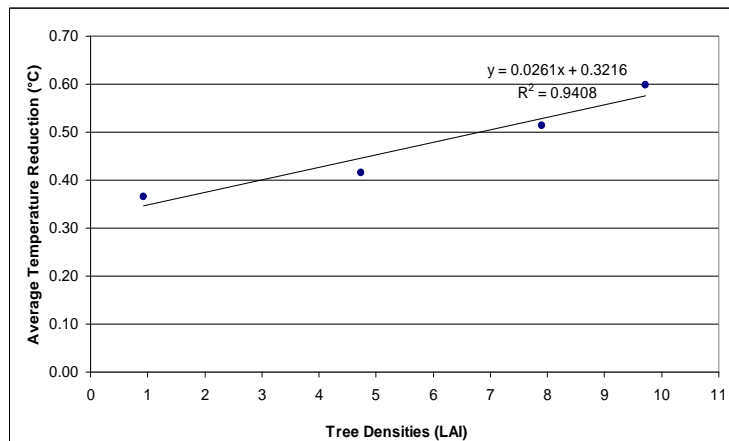

Figure 5.18. Correlation of average air temperature and tree densities (LAI) of four different tree species

On average, the air temperature reduction of Fb is the highest with a magnitude of 0.6°C, followed by mf, fd and ml with a magnitude of 0.51°C, 0.42°C and 0.37°C respectively (Table 5.6). Based on the regression model, presented in Figure 5.18, this displays a linear pattern. The LAI value shows a higher increase of average temperature reduction. Thus, it is noted that the average temperature reduction corresponds to the higher LAI values of the tree canopy with a R^2 value of 0.94. In relation to the result, it is confirmed that the variation of reductions are due to the canopy proportions and foliage differences with density variations.

In fact, the greater reduction within the tree canopy parameter is affected by the solidness of the shading effect and radiation interception due to the greater density of the canopy during the daytime. For instance, trees with the same density as Fb (more than 9 LAI values) warm the air less when compared to other trees with lower densities. Thus, greater cooling benefits can be obtained through high quality of shade and incoming solar radiation interception. The cooling effect would be much greater when more trees were added in clusters.

Figure 5.19 shows the hourly air temperature reduction for one, four and ten high densities of Fb trees in a 24 hour period. The graph shows the same reduction patterns during peak hours and the air temperature reduction becomes higher as the quantity of trees increases. The additional maximum reduction compared to single trees is 0.08°C and 0.2°C for four and ten trees added to the site, respectively. However, during the night time, starting from 18:00 hours, the reduction is gradually increased compared to the single tree that is reduced. It is believed additional trees which provide a larger shaded area during the daytime are able to maintain lower air temperature underneath the tree compared to the outside temperature during the night time. This condition also continues with a constant lower surface temperature during the daytime; and throughout the night time compared to the outside surface material that slowly starts to expel heat stored during the day time. The heat from the outside surface warms the air more and the differences between the outside and underneath become larger. Thus, it is claimed that the cooling benefits can become optimum as the number of trees rises.

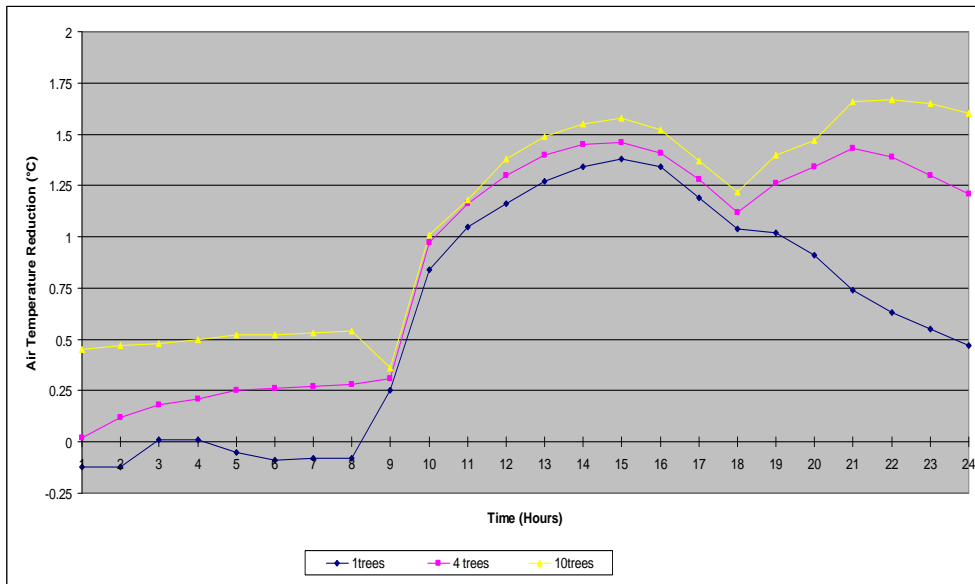

Figure 5.19. Comparison of hourly temperature reductions for one, four and ten trees in a 24-hour period

Table 5.7 explains the conditions of average air temperature in response to additional tree quantities of Fb. Based on these results it shows that the average air temperature reduction becomes larger as trees are added to the site. This will lead to a 60% more reduction when 10 trees are added to the site. Figure 5.18 displayed a linear pattern. The larger number of tree quantities shows a higher reduction of average air temperature. This result confirms that the higher average temperature reduction corresponds to the larger tree numbers, with an R^2 value of 0.94. Thus, it is accurate to say that larger tree quantities with a high density of canopy are significant in promoting higher air temperature reduction, which helps in promoting an optimum cooling effect on the urban environment.

Table 5.7. The relation of tree quantities and average temperature reduction

Tree Quantities	Average Air Temp Reduction (°C)
1	0.6
4	0.81
10	0.98

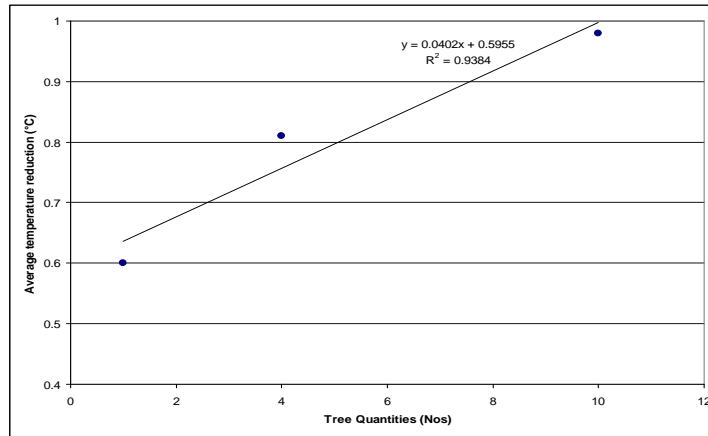

Figure 5.20 Correlation of average air temperature and tree quantities of *Ficus benjamina* tree species

5.3.2.2 Relative Humidity

Figure 5.21 shows the hourly relative humidity increase for four different types of tree species in a 24-hour period. It can be observed that the relative humidity increase pattern is correlated with the air temperature reduction presented in the earlier section. The highest temperature reduction creates a higher increase of relative humidity starting from 08:00 to the peak at 15:00 to 17:00 hours and reducing gradually during the night time. However, the ml tree species keep constant at a 2% level of reduction; and may be due to the loose canopy that mixes with the outside humidity.

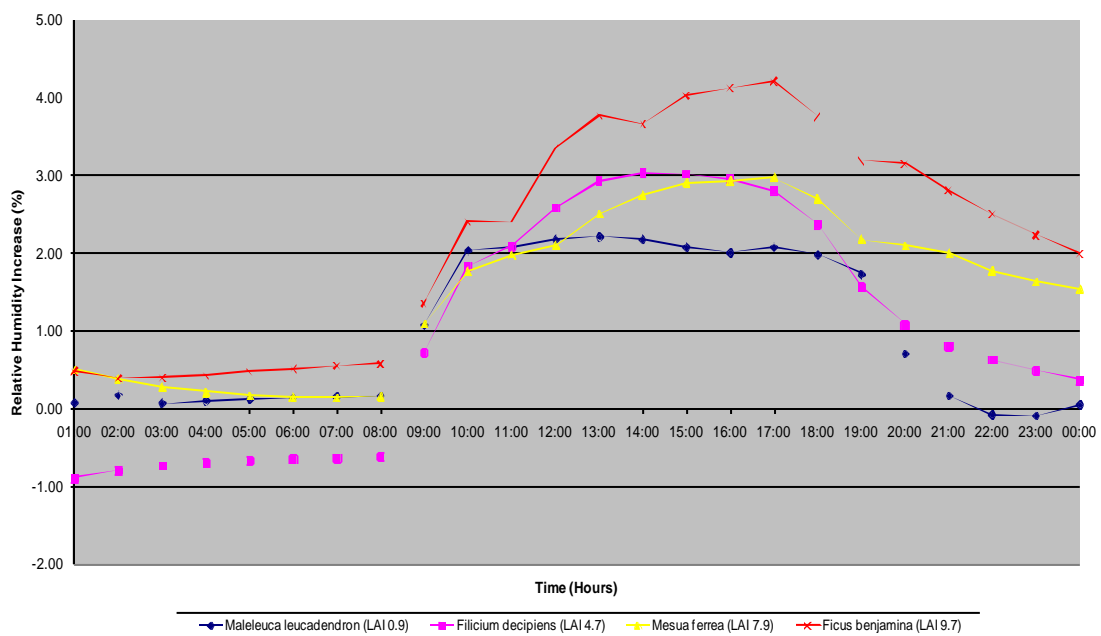

Figure 5.21 Comparison of hourly relative humidity increase for four different tree species in 24-hours period

Conversely, the higher canopy density such as fd, mf and Fb increases up to a maximum of 3% and 4%, respectively making the difference of a 1% maximum difference in each tree. The Fb tree species show the highest relative humidity due to the reduction of air temperature underneath the tree. In fact, the effect is believed to be from the higher volume of water transpired to the air due to the process of evapotranspiration from the trees. This due to the higher the density of leaves cover offers a larger transpiration process especially during the hottest period of the day (Pokorny, 2001). Thus, it can be noted that the greatest effect from the process takes place during daytime hours starting from 10:00 and gradually increases to a peak from 13:00 to 17:00 hours; whilst the effect slowly decreases during the night time. Therefore, the greater effects can be found during the critical hours when the urban air temperature is at its peak. In fact, it is believed that the latent heat production is larger than the sensible heat which produces more transpired water from the surface, apart from the transpiration process, during the hottest daytimes.

Nevertheless, it can be observed that each tree contributes to this effect. However; the physical properties of trees, such as densities of the canopy, play a significant role in increasing the surrounding humidity, despite the effect shading has on reducing the ambient temperature. Table 5.8 has presented the average relative humidity with LAI values. On average, Fb shows the highest average relative humidity increase with 2.21%, followed by mf, fd and ml with 1.54%, 0.99% and 0.98% respectively.

Table 5.8. Results of leaf area density (LAI) and average relative humidity increase for four different tree species

Tree Species	LAI	Average Rel. Humidity Increase (%)
<i>Maleleuca leucadendron</i>	0.93	0.98
<i>Filicium decipiens</i>	4.73	0.99
<i>Mesua ferrea</i>	7.90	1.54
<i>Ficus benamina</i>	9.72	2.21

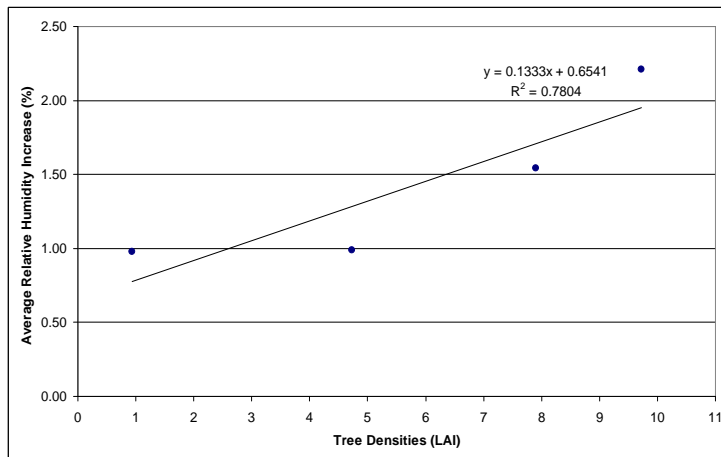

Figure 5.22. Correlation of average increase of relative humidity and tree densities (LAI) of four different tree species

Figure 5.22 displays a linear pattern. The correlation confirmed the relative humidity increase in each tree corresponding to the physical properties of each tree canopy density with R^2 of 0.78. Thus, with an increased canopy density of trees the percentage increase of humidity is larger. Therefore the effects of the transpiration process become effective when the physical properties of the trees are denser and more solid due to higher quantities of leaves in the canopy. Thus, based on the results, the optimum cooling effect can be obtained from Fb due to the higher densities and larger increase of relative humidity. The effect will be much greater when more Fb trees are added.

Figure 5.23 shows the results of one, four and ten trees. The relative humidity outline correlates with air temperature reduction patterns where the highest reduction is found in ten trees added to the site. Importantly, the greater effect was found for ten trees during the peak hours with the highest increase of 5.3 %. In addition, the same effect was found during the night time where the difference of relative humidity increases between single and additional trees; and is believed to be due to the heat released that decreases the outside humidity. Thus, it can be noted that the crowding of more trees will help in maintaining the humidity effect throughout the night time.

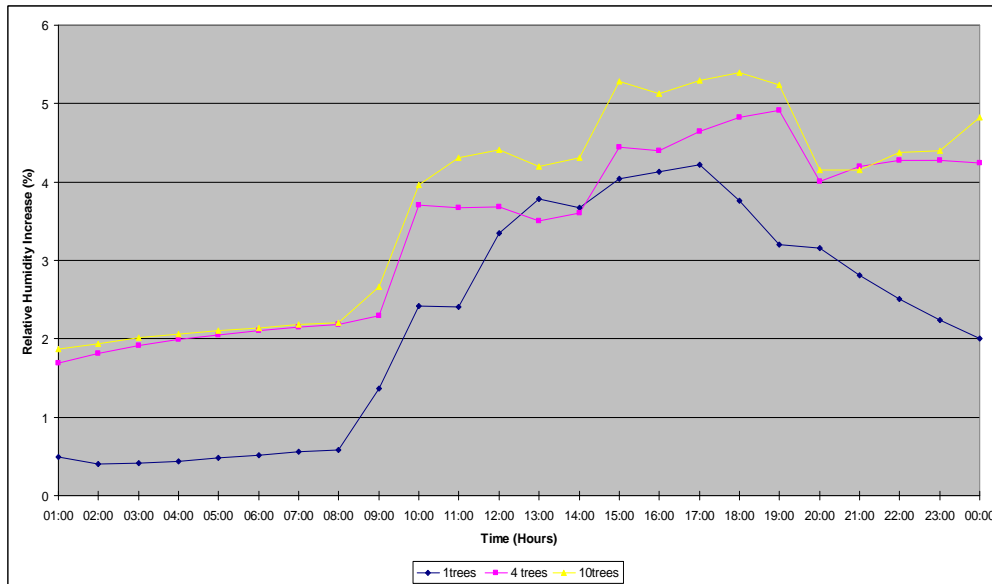

Figure 5.23 Comparison of hourly relative humidity increase for one, four and ten trees in a 24-hour period

Table 5.9 further explains the conditions of average humidity in response to additional tree quantities. The increase of 4.42% can be found with 10 additional trees in the urban environment. This makes a 50% additional increment from a single tree. In contrast to the air temperature, the result showed that the increases in average humidity became larger as more trees are added to the site. This has been confirmed with correlation of the humidity affected to the number of tree quantities with R^2 value of 0.97 as presented in Figure 5.24.

Table 5.9. The relation of tree quantities and average humidity increase

Tree Quantities	Average Rel. Humidity Increase (%)
1	2.21
4	3.26
10	4.42

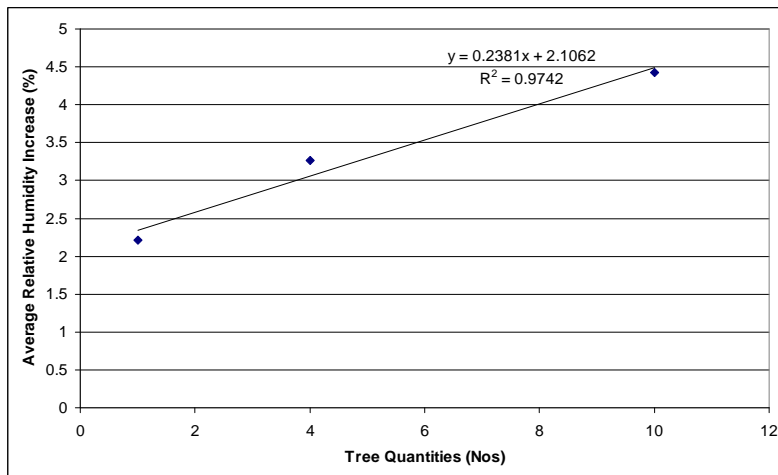

Figure 5.24. Correlation of average relative humidity and tree quantities of *Ficus benjamina* tree species

5.3.2.3 Absolute Humidity

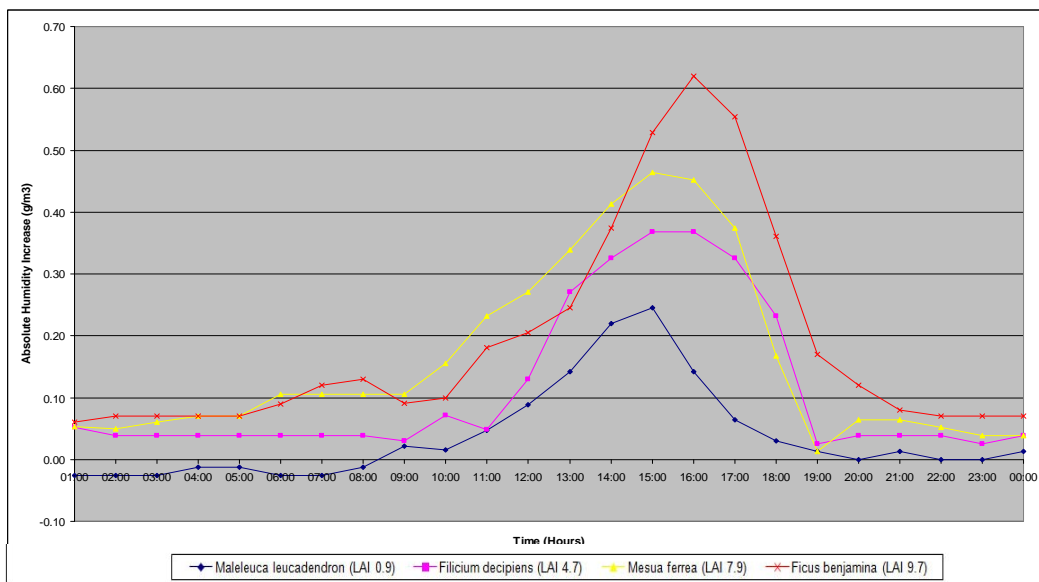

Figure 5.25 Comparison of hourly absolute humidity increase for four different tree species in 24-hour period

These results are presented in order to confirm the increase in moisture content due to the variation contribution of evapotranspiration and to further explain the air temperature reduction and relative humidity increase on each plant. In fact, the presence of vegetative cooling is effectively determined through measurement of absolute humidity (Kurn et al, 1994; Spangenberg et al, 2008). The range of absolute humidity in four different tree species is found to be at 15.59 to 22.90 g/m³ or 12.05 to 17.75 g/kg in specific humidity (refer appendix 6). This correlates with the findings of Kurn et al (1994) where the average range of

specific humidity in the summer season was in the range of 6 to 23 g/kg (refer section 3.2.3). Thus, the absolute humidity result from the simulation is confirmed based on this relationship.

Figure 5.25 shows the hourly absolute humidity increase for four different types of tree species in a 24 hour period. It can be observed during the day time that the absolute humidity gradually increases in all four tree species starting from 10:00 until it reaches its peak at 15:00 to 16:00 and slowly decreases during the night time.

The largest increment was found in Fb at 16:00 with a magnitude of 0.62 g/m³ followed by mf, fd and ml with 0.46, 0.37 and 0.25 g/m³ respectively. Thus, this explains the relative humidity variation in each tree where it is due to the increase of moisture content from the trees. This condition also explains the contribution of each individual tree species in the evapotranspiration rate. Obviously, the Fb tree species has the higher evapotranspiration rate when compared to others. This condition allows a higher ratio of latent heat flux to sensible heat flux within tree parameters. In fact, this is becoming one of the conditional factors that contribute to the causes of the largest temperature reduction and relative humidity increase for this tree. Importantly, the physical property of the tree creates this condition in order to be more effective.

Table 5.10 and Figure 5.26 explain the absolute humidity condition with of trees. The moisture content increased as the density increased. In the other words, the correlation confirmed that the evapotranspiration rate is larger with a higher density of trees with R² value of 0.96.

Table 5.10. Results of leaf area density (LAI) and average absolute humidity increase for four different tree species

Tree Species	LAI	Average Absolute Humidity Increase (g/m ³)
<i>Maleleuca leucadendron</i>	0.93	0.05
<i>Filicium decipiens</i>	4.73	0.10
<i>Mesua ferrea</i>	7.90	0.13
<i>Ficus benamina</i>	9.72	0.18

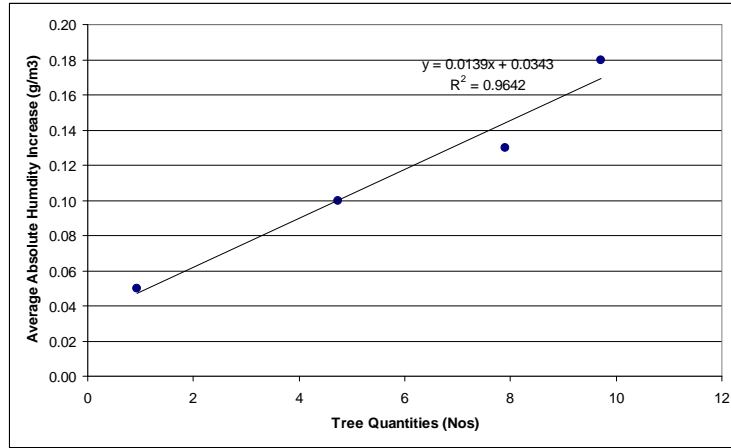

Figure 5.26 Correlation of average increase of absolute humidity and tree densities (LAI) of four different tree species

In addition to this, the use of more trees with a high canopy density, such as the Fb, leads to the presence of higher moisture content in the urban area. For instance, Figure 5.27 shows the pattern in absolute humidity with the highest increment with a magnitude of 0.69 g/m^3 in ten trees followed by four and single trees with 0.62 g/m^3 for both. However, during the night time the differences of moisture content still occur with four to ten trees within the range of 0.21 to 0.49 g/m^3 . This is due to the quantities of trees with a solid canopy expelling small amounts of moisture content during the night time compared to the open area. Thus, this condition explains further the reason of relative humidity and air temperature patterns during the night time; where the value differences become larger during these hours. In fact, the larger moisture content due to the evapotranspiration process influences the decrease of the urban air temperature and an increase of relative humidity; and this one conditional factor will lead to the optimum cooling effect of trees in the urban environment.

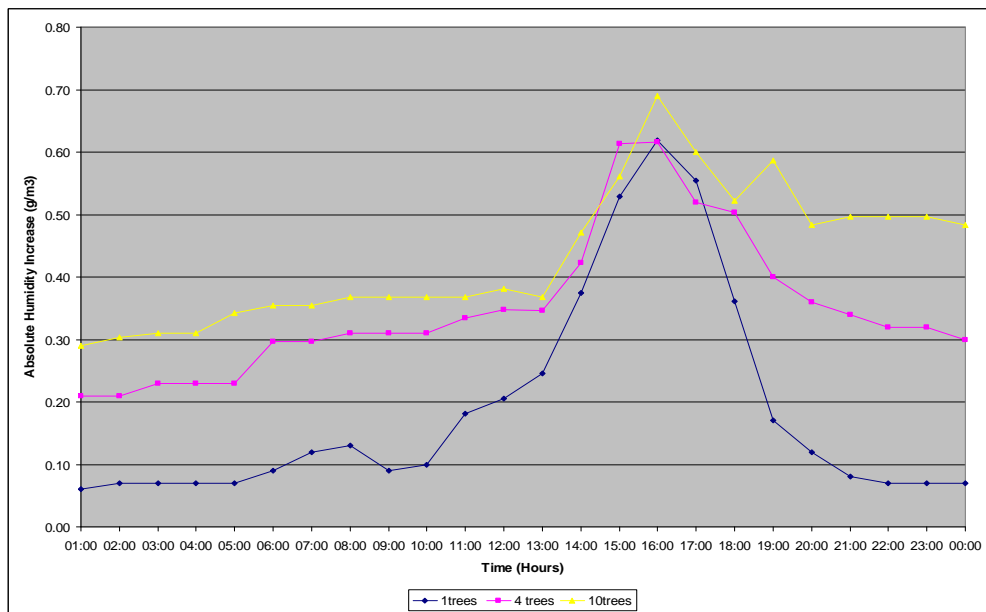

Figure 5.27. Comparison of hourly absolute humidity increase for one, four and ten *Ficus benjamina* tree in a 24-hour period

This has been confirmed with the correlation results of average absolute humidity with tree densities of R^2 value of 0.93 presented in Table 5.11 and Figure 5.28. It shows that the higher amount of moisture content is influenced by higher tree quantities.

Table 5.11. The relation of tree quantities and average increase of absolute humidity

Tree Quantities	Average Absolute Humidity Increase (g/m ³)
1	0.18
4	0.32
10	0.43

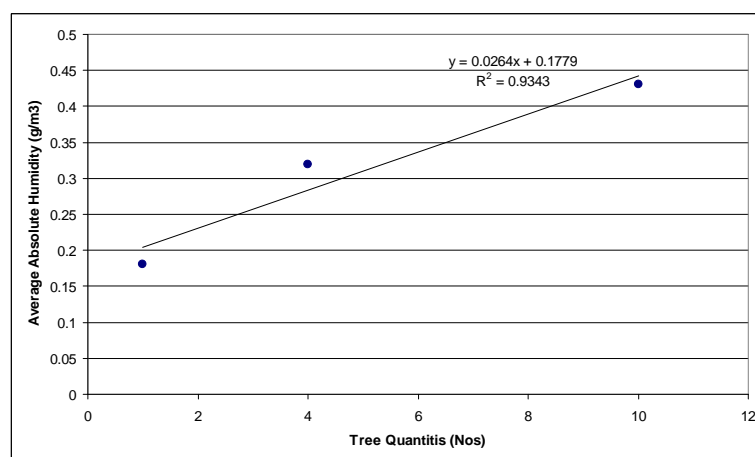

Figure 5.28. Correlation of average absolute humidity and tree quantities of *Ficus benjamina* tree species

5.3.2.4 Ground Surface Temperature

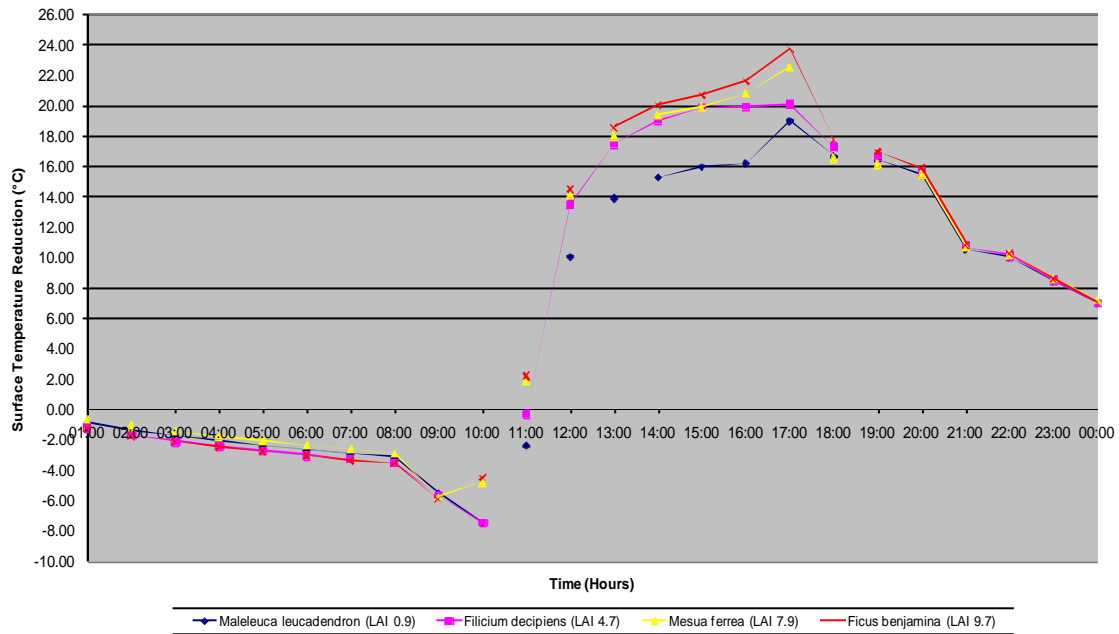

Figure 5.29. Comparison of hourly ground surface temperature reduction for four different tree species in a 24-hour period

This result is presented for further explanation of the effect of shading from each tree canopy towards ground surface temperature in referring to air temperature and relative humidity modification. These findings are confirmed by further results relating to thermal radiation filtration and radiant temperature in the following sections.

Figure 5.29 shows the comparison of the hourly ground surface temperature reduction for four different types of tree species in a 24 hour period. Apparently, the ground surface temperature differences occur during the daytime starting from 11:00 and drastically increase until they reach a peak at 15:00 to 17:00 hours, before gradually decreasing over night. This is believed to be the result of the sun angle in this region where the sun is overhead; and the shade is concentrated directly around the canopy starting from 12:00 to 15:00 hours (Shahidan et al, 2010). At this point of time, the shadow area will be almost equal to the planting area due to the solar angle height being close to 90° (Fahmy et al, 2010; Shahidan et al, 2010).

In fact, the radiation filtration throughout tree canopy will influence the amount of radiant heat underneath the canopy. This condition leads to the lowering of the ground surface

temperature underneath the canopy due to lower Bowen ratio compared to the exposed surface, as more latent heat fluxes are thus released. Thus, it promotes the evaporation process from the ground and encourages the transpiration process due to the stability of water content in the soil. This is one of the reasons why the moisture content is higher during the daytime.

Consequently, the air is less heated; the air temperature becomes lower and the relative humidity increases drastically. However, with reference to the results it can be observed that performance depends on each individual tree. It can be noted that the effects of surface cooling continue for two hours until it slowly starts to decrease afterwards. The Fb tree shows the highest reduction at 17:00 with 23.8°C; followed by mf, fd and ml with magnitude differences of 22.6°C, 20.1°C and 19.1°C, respectively. On average, the ground surface temperature reduction for Fb is about 7.45°C, followed by mf, fd, and ml with a magnitude of 7.38°C, 6.79°C and 5.97°C respectively (Table 5.12). This again has been proved, where the ground surface temperature reduction correlates with tree densities as presented in Figure 5.28 with R^2 values of 0.97.

Table 5.12 Results of LAI and average ground surface temperature reduction for four different tree species

Tree Species	LAI	Average Ground Surface Temp Reduction (°C)
<i>Maleleuca leucadendron</i>	0.93	5.97
<i>Filicium decipiens</i>	4.73	6.79
<i>Mesua ferrea</i>	7.90	7.38
<i>Ficus benamina</i>	9.72	7.45

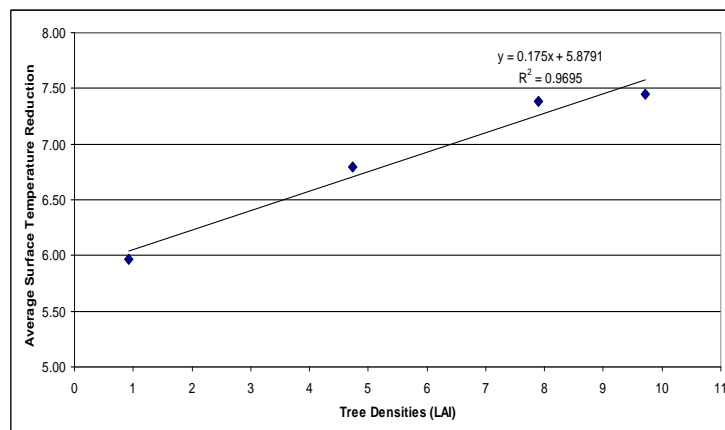

Figure 5.30 Correlation of average ground surface temperature reduction and tree densities (LAI) of four different tree species

In respect of the tree quantities of Fb tree species, Figure 5.31 shows the reduction of ground surface temperatures with single, four and ten trees during a 24 hour period. It is observed that the reduction becomes larger as more trees are added to the urban environment. In fact, the densities of trees become optimum and solid as more trees are placed in groups. This condition will maintain the lowest ground surface temperature underneath the tree during the day and night time. On average, ten trees will be reduced by about 8.9°C of surface temperature as presented in Table 5.13.

Figure 5.32 shows a relationship of the surface temperature reduction towards tree canopy densities with R^2 values of 0.83. In this respect, it is also believed that with higher canopy density trees being added to urban spaces; the amount of evapotranspiration will increase to the optimum level due to the lowest ground surface temperature and will modify the air temperature and relative humidity effectively.

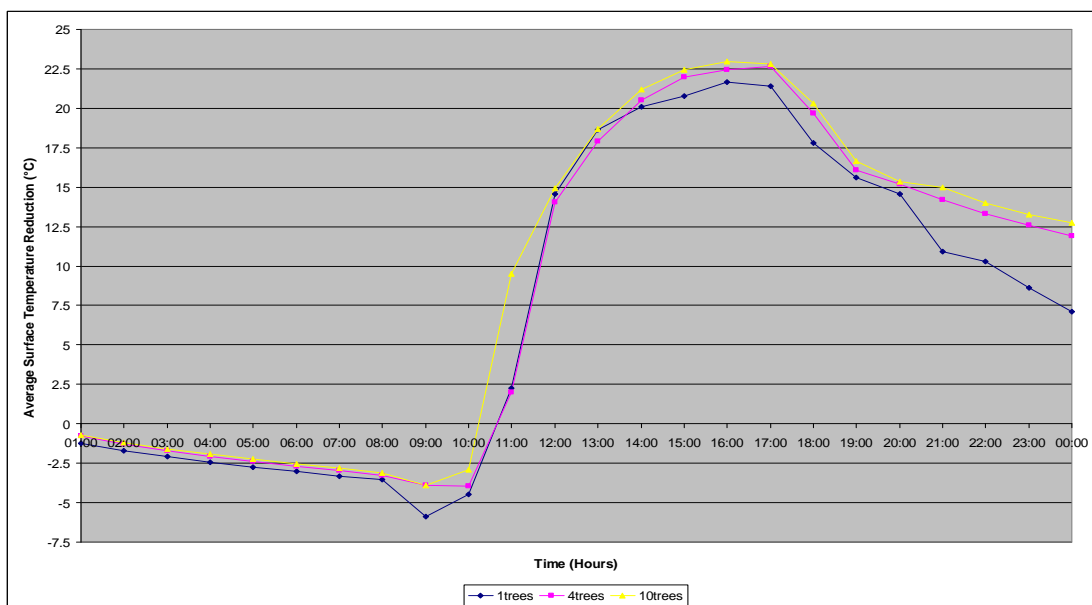

Figure 5.31 Comparison of hourly ground surface temperature reduction for one, four and ten *Ficus benjamina* tree in a 24-hour period

Table 5.13 The relation of tree quantities and average increase of surface temperature reduction

Tree Quantities	Average Ground Surface Temperature Reduction (°C)
1	7.45
4	8.48
10	8.90

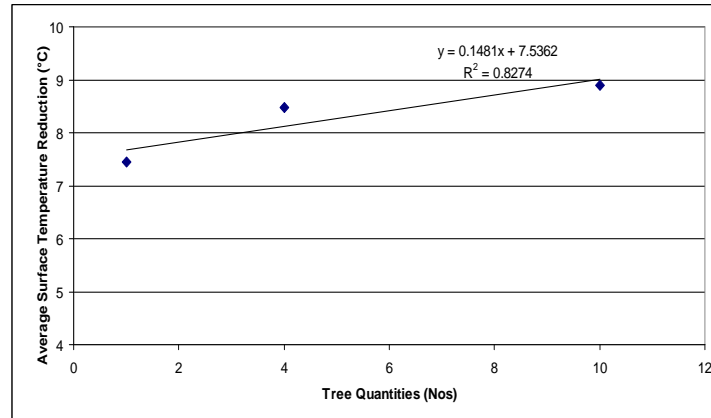

Figure 5.32 Correlation of average ground surface temperature reduction and tree quantities of *Ficus benjamina* tree species

5.3.2.5 Thermal Radiation Filtration

As mentioned earlier, one of the reasons associated with the surface temperature reduction was radiation filtration throughout the canopy. This filtration will influence the amount of direct radiation and terrestrial radiation underneath the canopy and is also related to the shading properties of each tree (Brown and Gillespie, 1995, Kotzen, 2003; Shahidan et al, 2010; Fahmy et al, 2010). The amount of these two major entities influences the values of the surface temperature. Thus, these results further explain the condition of each individual tree canopy's radiation filtration in respect to ground surface temperature reduction.

Figure 5.33 shows the comparison of hourly thermal radiation filtration for four different tree species from 07:00 to 19:00 hours daytime period. It can be observed that the canopy begins to filter direct radiation from 08:00 to 17:00 hours. Obviously, it can be seen that the highest filtration occurs at 12:00 due to the 90° sun angle that provides solid shade underneath the canopy. Compared to the other times, the filtration becomes more effective as the leaves filter more incoming radiation and small amounts are transmitted through shading underneath the canopy. Drastically, this condition will reduce the amount of direct and terrestrial underneath the canopy, thus, less heat is found when compared to the exposed area. Due to this reason, the ground surface absorbed less heat and simultaneously reduced the ground surface temperature underneath the canopy. This explains the condition where the ground surface temperature reduction which is significant starts to increase drastically during this hour. However, the effects continued until 17:00 hours where the surface temperature reduction was found to be the highest.

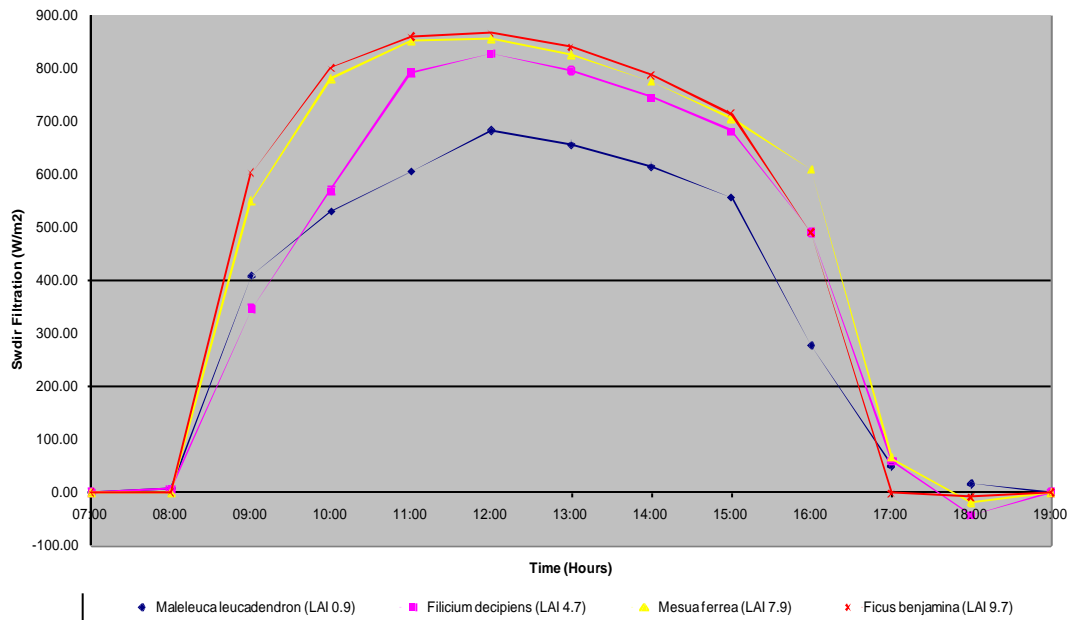

Figure 5.33 Comparison of hourly thermal radiation filtration for four different tree species in a day time period

On average, it was found that trees with the highest densities correlate with the highest thermal radiation filtration. The Fb tree species was found to be of 98.71% filtration followed by mf, fd and ml with 96.48%, 83.76% and 70.87% filtration respectively (Table 5.14).

Figure 5.34 shows the relationship with R^2 values of 0.95. This finding correlates with the Shahidan et al (2010) field measurement study where the LAI correlation factor was equal to the thermal radiation filtration in this study. Thus, the thermal radiation filtration from simulation result was confirmed based on this relationship.

Table 5.14. Results of LAI and thermal radiation filtration for four different tree species

Tree Species	LAI	Computed Thermal Radiation Filtration (%)	Predicted Thermal Radiation Filtration by Field Measurement (%)
<i>Maleleuca leucadendron</i>	0.93	70.87	73.77
<i>Filicium decipiens</i>	4.73	83.76	89.45
<i>Mesua ferrea</i>	7.90	96.48	95.67
<i>Ficus benjamina</i>	9.72	98.71	98.77

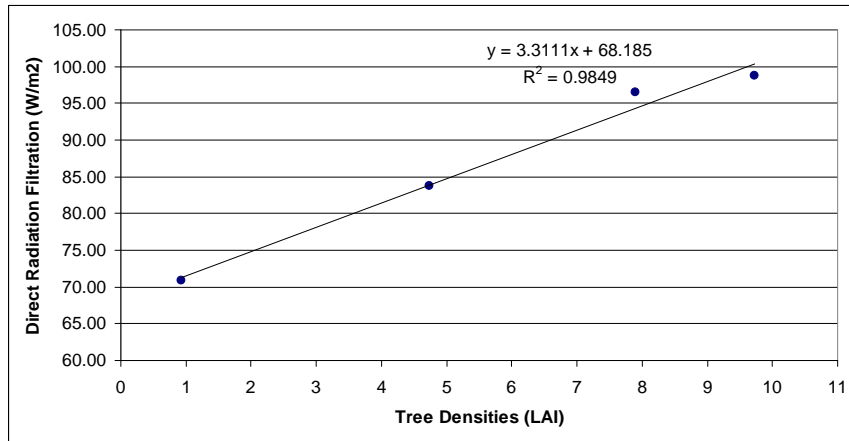

Figure 5.34 Correlation of average thermal radiation filtration and tree densities (LAI) of four different tree species

In Figure 5.35, the pattern of single, four and ten trees of *Fb* tree species are similar, however, the variation on the filtration can be observed after 12:00 as the effect of shading becomes significant during this hour. In fact, during 16:00 hours the filtration becomes larger compared to single trees. This pattern correlates to ground surface temperatures where the gap difference between tree quantities can be seen starting from 12:00 and reduces slowly at 17:00 as the filtration become lesser when the sun angle is at low altitude. During this time the shading is located far away from single trees and the ground surface is exposed to the sun, thus, the ground surface temperature become higher. However, with higher canopy density trees added to the site, larger shaded areas can be found and the filtration process occurs during this hour. As a result, lower surface temperatures were found at some parts of the shaded area underneath the canopy.

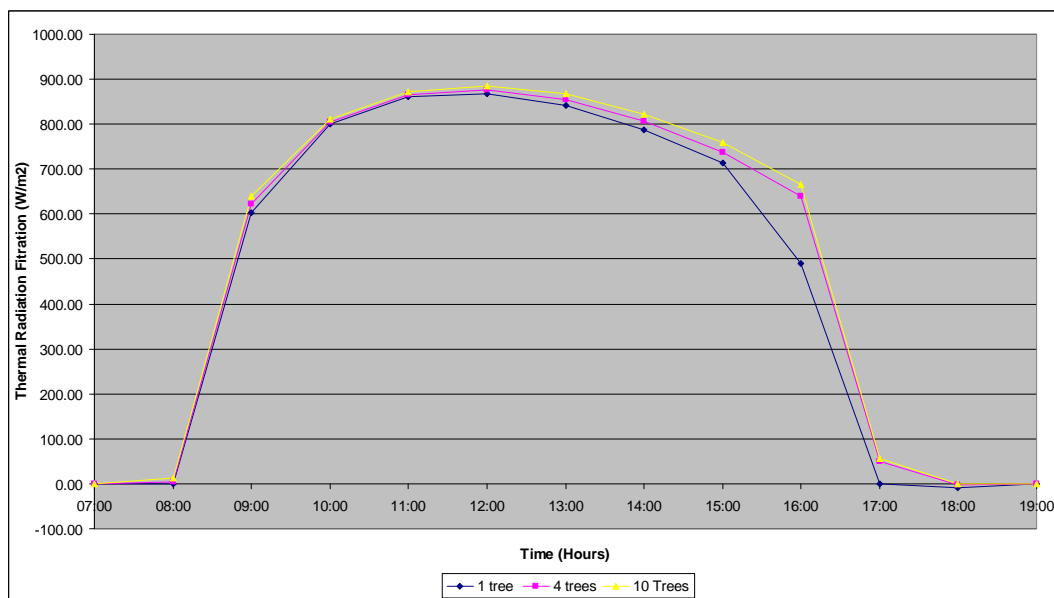

Figure 5.35. Comparison of hourly thermal radiation filtration for one, four and ten *Ficus benjamina* tree species in a 24-hour period

On average, the ten trees' thermal radiation filtration of Fb is almost 100% and the shading can be considered solid (Table 5.15). It is believed that this state of filtration value provides an optimum condition of cooling effect as it influences the reduction of ground surface temperature and increase of the evapotranspiration rate. In fact, these modifications turn out to be another reason associated with the urban air temperature and relative humidity improvement. Figure 5.36 explains the relationship of thermal radiation filtration with tree densities with R^2 values of 0.95.

Table 5.15. The relation of tree quantities and average thermal radiation filtration

Tree Quantities	Average Thermal Radiation Filtration (%)
1	98.87
4	99.45
10	99.97

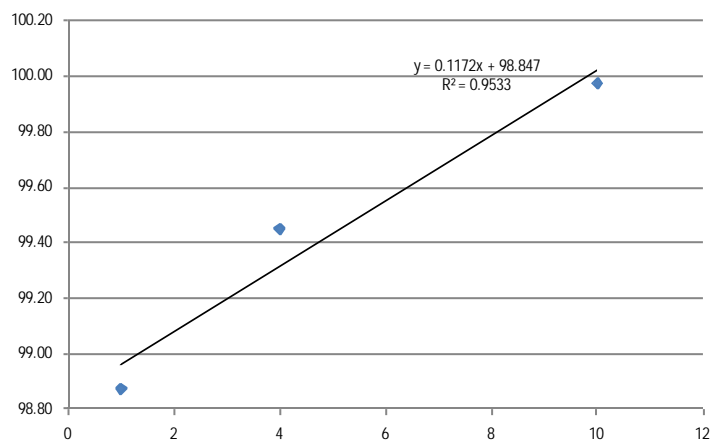

Figure 5.36. Correlation of average thermal radiation filtration and tree quantities of *Ficus benjamina* tree species

5.3.2.6 Radiant Temperature

Due to the dependency of mean radiant temperature on radiation interaction, it is of importance to present this result in order to evaluate radiant heat underneath the canopy (i.e. short - and long-wave radiation) as they conclude the mean radiant temperature values. The heat budget at any point on the ground surface is generally calculated by modifications to the radiation sources due to plants by the vegetation foliage transmission factor (Bruse, 2008). The finding is also significant in relation to absolute humidity, radiation filtration and surface temperature results.

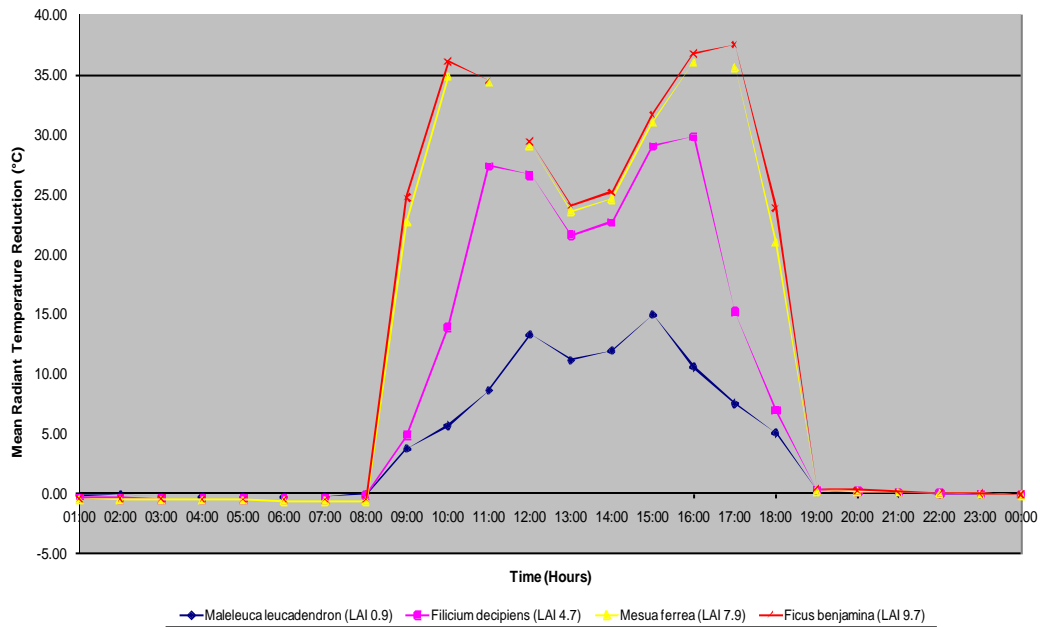

Figure 5.37 Comparison of hourly mean radiant temperature for four different tree species in daytime period

Figure 5.37 shows the hourly mean radiant temperature reduction for four different tree species. Mean radiant temperature as bio meteorological representation of all wave radiations influencing pedestrian comfort under tree canopies is attributed to solar movement (Fahmy et al, 2010).

Early in the day starting from 8:00, it can be observed that the higher values of radiant temperature were recorded until it reached its peak at 10:00 to 12:00 hours on individual trees. This is due to the early daytime when the highest solar radiation was recorded and radiation filtration during these hours is at the peak. During these hours, the condition creates larger differences in mean radiant temperature due to the lowest radiant heat underneath the canopy compared to the exposed area. However, during the peak hours at 12:00 to 13:00 when the solar angle is at 90°; the effect of shading and radiation filtration becomes significant and the amount of radiant heat underneath the canopy is constant and lower.

Consequently, it is recorded that the largest differences in mean radiant temperature outside and underneath can be found after 13:00 as the effect of the shading and filtration effects continue until 15:00 to 16:00 hours. This condition is explained further on the effective hour of surface temperature reduction and increase of moisture content where larger differences can be found starting at this point of time. Thus, the largest differences on the

surface temperature and evapotranspiration rate due to the greater shading and radiation filtration effect were affected to the lowest radiant heat underneath the canopy.

This group of conditions has an effect on the air temperature reduction and increase of relative humidity where the greatest effect is found during this period of hours. Subsequently, it starts to reach its second peak at 17:00 and drastically drops after this time. The significant difference comes with the sun at low altitude due to the obstacles from the environment. During this hour, the radiation filtration process and shading effect are insignificant, thus, the mean radiant temperature reduction becomes lower. This is also explained on the identical condition of ground surface temperature and absolute humidity where both reached its highest peak differences at 17:00 hours.

On average, the performance of each tree varies with highest reduction and is found in highest canopy density, Fb, with 7.45°C; followed by mf, fd and ml with 7.38°C, 6.79°C and 5.97°C, respectively (Table 5.15). It has been confirmed with correlation result with R² values of 0.98 (Figure 5.38). It is worth mentioning that the lowest human energy budget can be found underneath the denser tree canopy and affects the human thermal comfort effectively.

Table 5.16. Results of LAI and average mean radiant temperature reduction for four different tree species

Tree Species	LAI	Average Mean Radiant Temp Reduction (°C)
<i>Maleleuca leucadendron</i>	0.93	3.85
<i>Filicium decipiens</i>	4.73	8.19
<i>Mesua ferrea</i>	7.90	12.07
<i>Ficus benjamina</i>	9.72	12.60

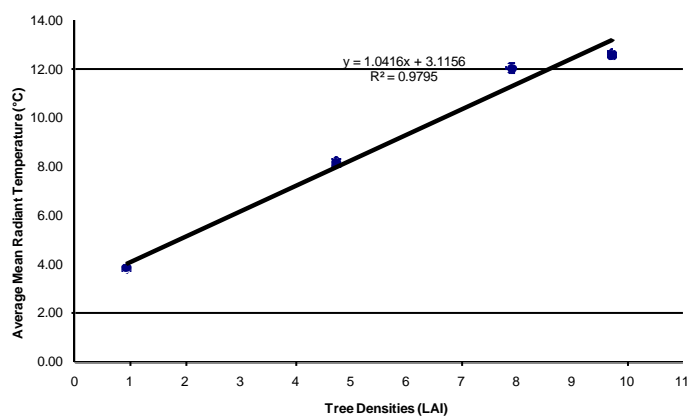

Figure 5.38. Correlation of average mean radiant temperature and tree densities (LAI) of four different trees

Conversely, the amount of tree quantities will lead to the optimum reduction. On average, almost 10% differences of reduction when the urban areas are added with ten numbers of high canopy density trees such as *Ficus benjamina* (Figure 5.39 and Table 5.17).

Figure 5.40 displays a linear pattern and confirms the relationship of mean radiant temperature reduction with tree quantities by R^2 values of 0.88. With this improvement, the enhancement on the cooling process such as radiation filtration, evapotranspiration and shading effect becomes optimum and further reduces the urban air temperature, ground surface temperature and increase in relative humidity.

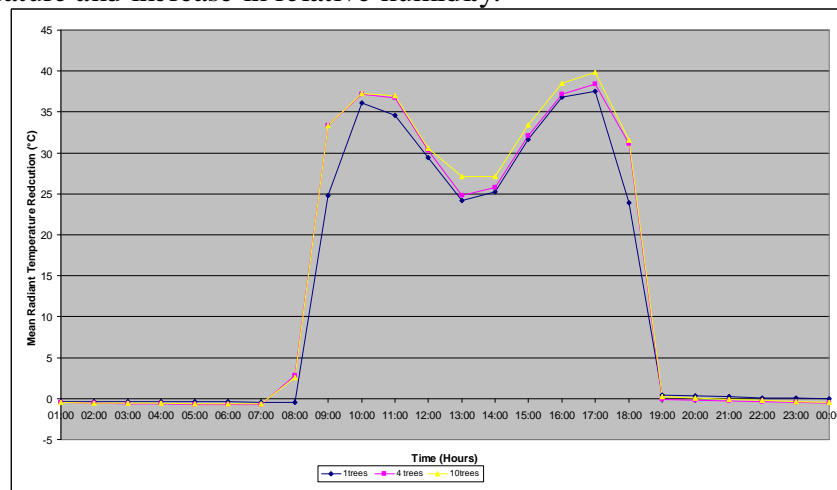

Figure 5.39 Comparison of hourly mean radiant temperature reduction for one, four and ten *Ficus benjamina* tree species in 24-hour period

Table 5.17 The relation of tree quantities and average mean radiant temperature reduction

Tree Quantities	Average Mean Radiant Temperature Reduction (°C)
1	12.60
4	13.48
10	13.97

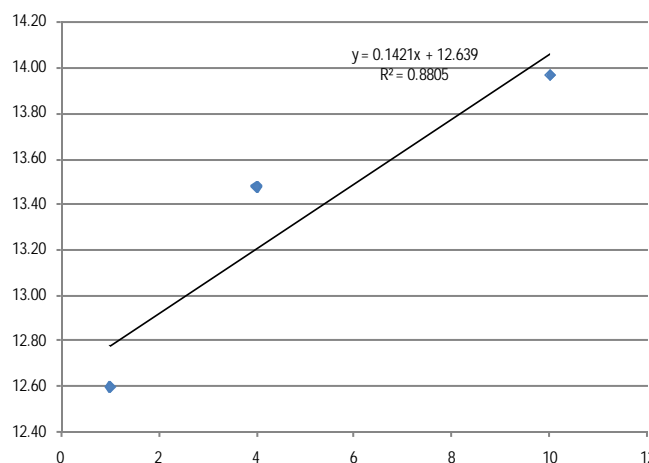

Figure 5.40. Correlation of average mean radiant temperature reduction and tree quantities of *Ficus benjamina* tree species

5.3.2.7 Wind Speed

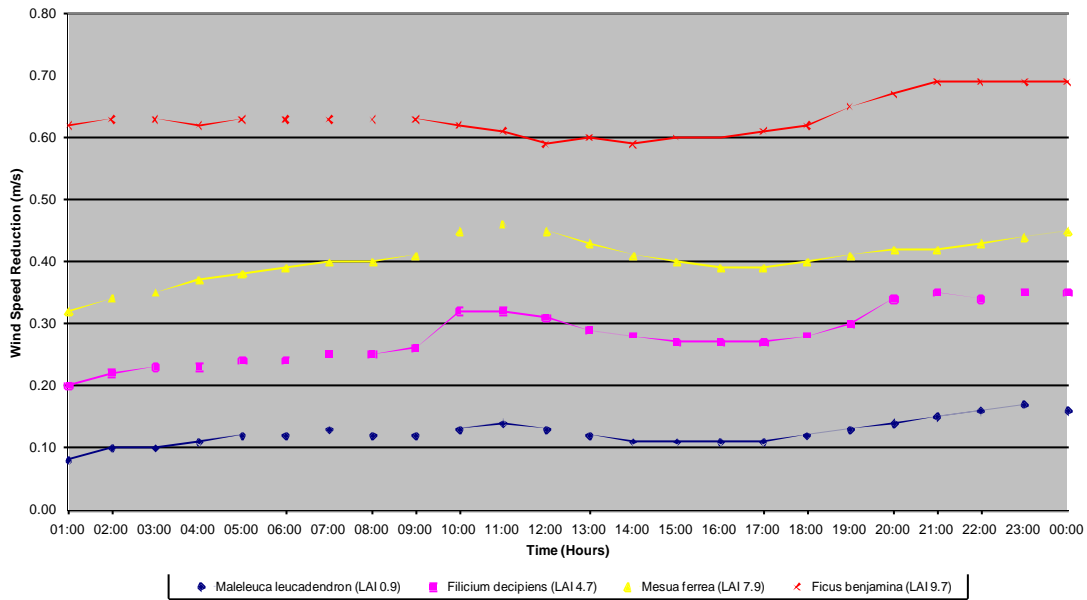

Figure 5.41. Comparison of hourly wind speed reduction for four different tree species in a 24 hour period

Figure 5.41 shows the actual condition of wind speed reduction for four different tree species in a 24 hour period. The graph shows a similar and constant pattern for each tree species. It can be observed that the highest reduction can be found in the Fb tree with 0.69 m/s followed by mf, fd and ml with magnitude differences of 0.46, 0.35 and 0.17 m/s, respectively. In contrast to the previous result, it is believed that the highest wind speed reduction in Fb creates less impact in cooling distribution due to the high density of the tree canopy. On average, the reduction of high canopy density trees such as Fb was found to be at 63% (Table 5.18) reduction and correlation of tree densities and wind speed reduction has been confirmed with R^2 values of 0.89 (Figure 5.42).

However, based on the results of this study it seems that the wind effect does not have much of an effect on the cooling process as has been proven from the previous section that reduction of air temperature is still considered as significantly higher. Nevertheless, it is believed that the existence of wind movement will help in distributing the tree cooling effect in the urban area. Conversely, trees with a high canopy density will reduce the distribution effect but the distribution can still be seen with less effect.

Table 5.18 Results of LAI and average wind speed reduction for four different tree species

Tree Species	LAI	Average Wind Speed Reduction (%)
<i>Maleleuca leucadendron</i>	0.93	12
<i>Filicium decipiens</i>	4.73	21
<i>Mesua ferrea</i>	7.90	40
<i>Ficus benamina</i>	9.72	63

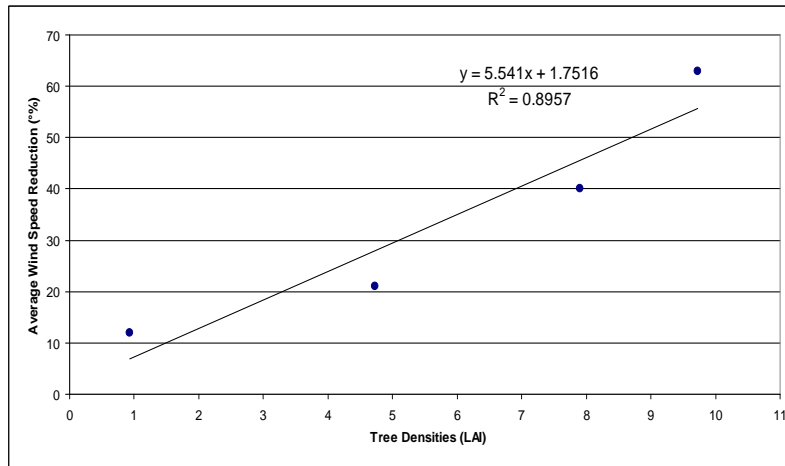

Figure 5.42. Correlation of average wind speed reduction and tree densities (LAI) of four different trees

In contrast to high canopy density trees, the loose density trees such as fd and ml with an average reduction of 12% to 21% (Table 5.18), respectively, block wind speeds less. However, the effect of cooling and reduction of the air temperature was less due to the smaller amount of leaves that provided a low quality shading effect and less effect in filtering direct radiation. In fact, by having higher of wind movement, the cooling effect of loose density will be decreased due to the immediate effects of the mixture of cool air from trees and hot air from the surrounding areas carried by high air movement.

According to Dimoudi and Nikolopoulou (2003) the effect of trees seemed to decrease as the high wind movement occurred above the ground. Thus, the wind effect does not help in providing the optimum cooling effect process of trees, regardless of the effect of the cooling distribution in the urban area. This correlates with the study by Fahmy et al (2010) who found that the wind speeds did not help in reducing the air temperature.

It should also be noted in these findings that high tree quantities with tree clusters planting can create a drag force of plant canopies as shown in Figure 5.43 where the highest reduction can be found at the end of the day. However, the reduction of wind speed does not

have much of an effect on the cooling process of trees during daytime, since the air temperature is found to be lower with higher quantities of high canopy density trees such as *Ficus benjamina* ; although 7% more reduction of wind speed was found within ten additional trees (Figure 5.43 and 5.19).

Wind movement is therefore insignificant in promoting the optimum cooling effect of trees due to small changes in other meteorological parameters that have been listed in previous findings. It is worth considering that by having static air movement the optimum cooling effect of trees can be produced effectively due to high canopy density and quantities of trees and as a result the surrounding air temperature can be reduced to an optimum level.

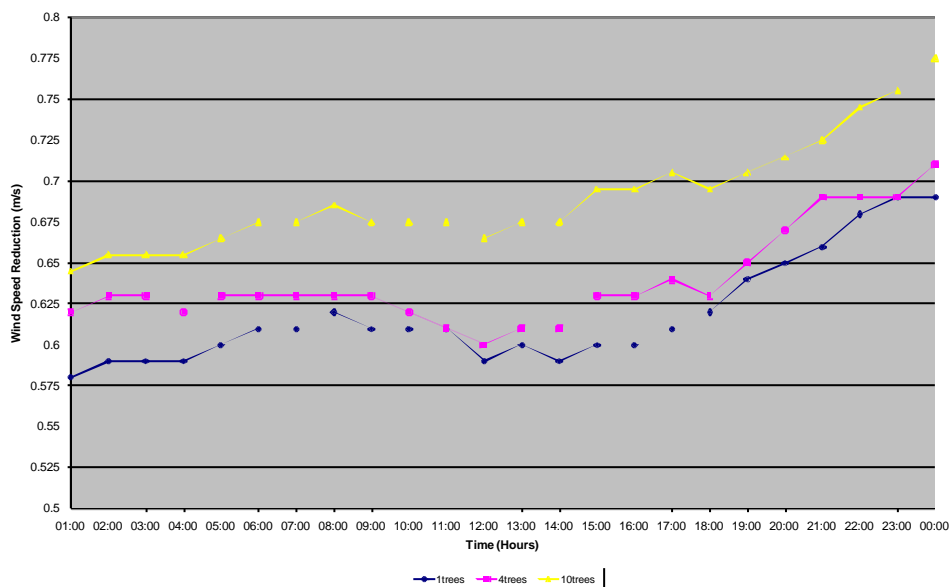

Figure 5.43. Comparison of hourly average wind speed reduction for one, four and ten *Ficus benjamina* tree species in a 24-hour period

Table 5.19 The relation of tree quantities and average wind speed reduction

Tree Quantities	Average Wind Speed Reduction (%)
1	63
4	66
10	70

5.3.2.8 Discussion: Per-Tree Cooling Effect Performance

Table 5.20. The summary table of per-tree cooling effect performance for four different tree species

Types Of Trees (LAI, Heights)	Air Temperature [Reduction] (°C)	Relative Humidity [Increase] (%)	Absolute Humidity [Increase] (g/m ³)	Ground Surface Temperature [Reduction] (°C)	Thermal radiation Filtration [Reduction] (%)	Radiant Temperature [Reduction] (°C)	Wind Speed [Reduction] (%)
1. <i>Maleleuca leucadendron</i> , ml (0.93,	0.37	0.98	0.05	5.97	70.87	3.85	12
2. <i>Filicium decipiens</i> , fd (4.7, 8m) Dense	0.42	0.99	0.10	6.79	83.76	8.19	21
3. <i>Mesua ferre</i> , mf (7.9, 8m) Very dense	0.51	1.54	0.13	7.38	96.48	12.07	40
4. <i>Ficus benjamina</i> , Fb (9.7, 8m) Very dense	0.60	2.21	0.18	7.45	98.71	12.60	63
5. <i>Ficus benjamina</i> Fb – (4 Trees)	0.81	3.26	0.32	8.48	99.45	13.48	66
6. <i>Ficus benjamina</i> Fb – (10 Trees)	0.98	4.42	0.43	8.90	99.97	13.97	70

Table 5.20 shows the summary of the per-tree cooling effect performance for four different tree species. Collectively, it can be confirmed that the tree cooling effect performance in each tree is based significantly on the physical properties of trees. Variation of tree densities offers a different performance in the tree cooling effect. Based on this condition, each tree has a different capability in modifying air temperature, relative humidity, absolute humidity, ground surface temperature, solar radiation and wind. It can be observed that with single high canopy density trees such as *Ficus benjamina* of LAI 9.7 offer a remarkable modification on microclimate variables compared to other trees.

The other trees such as *Mesua ferrea*, *Filicium decipens* and *Maleleuca leucadendron* provide a less cooling effect as the tree canopy density becomes lower, respectively. The high canopy density of *Ficus benjamina* offers a significant reduction of 0.6°C in air temperature and 2.21% increases of relative humidity and it is justified due to high filtration of 98.71% that provide a high quality of the tree shading effect underneath the canopy. In addition this condition allows ground surface temperature and radiant temperature to reduce up to 7.45°C and 12.60°C respectively, and promotes the evapotranspiration rate which increases the absolute humidity up to 0.18 g/m³. Importantly, the optimum cooling performance can be found during the hottest day time at approximately 15:00 hours. The effect of cooling can be achieved by having the lowest air movement. However, it should be noted that the downside of implementing high tree canopy density can be the creation of a reduction of 63% of wind speed that possibly influences the air movement in urban areas in contrast to loose canopy

density with 40%, 21% and 12% for *Mesua ferrea*, *Filicium decipens* and *Maleleuca leucadendron*, respectively.

In providing the optimum cooling effect, the findings confirm that tree quantities play an important role in tree cooling performance. By having larger high canopy density trees at the site of an urban area offers a better improvement in all microclimate variables, regardless of the further reduction of the wind effect. However, in the tropics, it can be observed that the improvement is much more concerned with the air and surface temperature which could influence the thermal comfort and energy performances of buildings. Thus, the improvement of microclimate variables is significantly correlated with larger tree quantities with cluster planting.

Overall, the optimum cooling effect can be achieved and influenced by high canopy density trees and large quantities of trees that offer better air and ground surface temperature reduction, high relative humidity and evaporative cooling; and finally optimum quality radiation filtration and shading effect to the urban environment.

5.3.3 Comparison of Current Condition, Three Modification Scenarios and Results

With reference to research methodology section 4.3.6.2.1, the comparisons of the current condition with three scenario modification were divided and discussed into six major meteorological parameter findings such as air temperature, relative humidity, ground surface temperature, absolute humidity, wind speed and mean radiant temperature. The findings were discussed based on these four different conditions and were coded as: (A) current condition; (B) double the amount of trees and changes of mean LAI 0.9 with current ground materials albedo condition; (C) double the amount of trees and changes of mean LAI 9.7 with current ground materials albedo condition; (D) double the amount of trees and changes of mean LAI 9.7 with changes of ground surface materials more than 0.8 albedo values.

5.3.3.1 Air Temperature

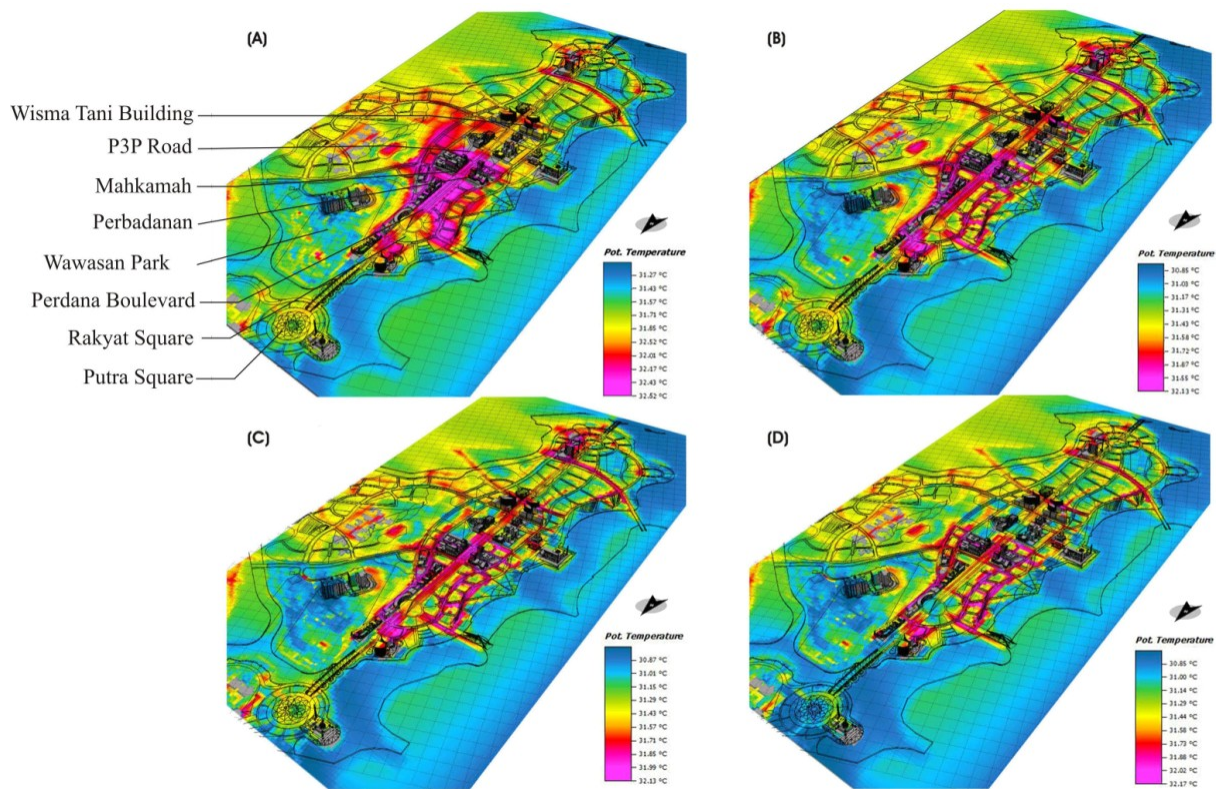

Figure 5.44 Air temperatures at four different conditions: current condition (A) and modified environments (B) to (D) compared at 15:00 in three metres height

Based on field measurement findings, the peak temperature time in the Persiaran Perdana was at 15:00. In a tropical climate, the maximum temperature is of special importance, since it determines the UHI intensity of the urban area. In addition it also influences the thermal comfort of people and determines the sizing of air-conditioning systems (Wong et al, 2007, Wong and Yu, 2010). Therefore; four different conditions were compared during this hour at three metres height, in order to understand the impact of modification towards the maximum temperature in this area, as presented in Figure 5.44.

The image shows the gradient colour marked from a blue to magenta colour, representing the lowest to highest air temperature. Based on current condition (A) profiles, during daytime the spot of magenta colour is focused at the centre point of the boulevard and clearly represents the highest air temperature within the whole area in the Persiaran Perdana. In fact, the areas most affected are the P3P Road and Perdana Boulevard area. The areas with red and yellow spot areas such as Putra Square and Rakyat Square also have a higher

temperature. The highest air temperature condition is believed to be the result of a lack of greenery; lower ground albedo materials and higher building density within this area. Conversely, there are spotted greenery areas such as Wawasan Park that produce a cooling effect and keep the area cooler during peak hours. However, the effect is not sufficient to provide optimum cooling to the entire area of the Persiaran Perdana; especially at the centre of the boulevard where most activities are occur during the daytime.

In contrast, after modification was made to conditions (B), the magenta spots become lessened and turn into a yellowish to greenish colour. This indicates that the air temperature has become lower as more vegetation has been added; especially at the hot spot area at the centre of the boulevard. The modified areas such as the P3P Road, Perdana Boulevard area and along Rakyat Square show an improvement in air temperature reduction. These improvements were believed to be the result of an increase of trees from 60% to 100%. However, the effect of cooling can still be considered as lower due to the use of loose canopy density trees in this scenario. The actual reduction is believed to be the result of an increase in tree quantities and not influenced significantly by tree densities.

In condition (C), the same situation occurred, nevertheless, the greenish colour spotted in condition (B) becomes more bluish and fewer magenta spots were found. This indicates that the area becomes cooler than in the previous scenarios (B), due to tree densities (LAI) differences.

Thus, it can be noted that high canopy density trees create a remarkable modification to air temperature reduction. This correlates with per-tree cooling findings where trees with higher densities such as *Ficus benjamina* species provide a better shading effect and radiation filtration. This condition reduces the ground surface temperature, which influences the evapotranspiration rate and consequently reduces the air temperature effectively.

In comparison to condition (B), the Wawasan Park shows the darkest blue colour and indicates the lowest air temperature within the whole area of the Persiaran Perdana. In fact, it can be observed that cooling effects created in Wawasan Park can influence nearby areas and buildings both in the day and at night time (Figure 5.45). In this case, the effect of wind plays an important role in carrying the cool air from the park and drops the temperature parallel to

the park (Dimoudi and Nikolopoulou, 2003). This condition confirms that high canopy density trees alone can create a significant cooling effect with significant ambient air temperature reduction.

Ultimately, in condition (D) where both elements are modified, it can be observed that in the main the air temperatures in problematic areas become settled and the coolest compare to alternative scenario conditions; especially in comparison to condition (A). The centre of the boulevard area becomes cooler and fewer magenta spots were found due to the changes to cool materials that further reduced the ground surface temperature and promoted an optimum evapotranspiration process, regardless of the shading effect and radiation filtration from high canopy density trees. Obviously, the effect can be seen in the middle of the boulevard and Putra Square where lower albedo has been changed to the higher albedo ground materials.

Overall, both modifications are definitely important in reducing the air temperature in urban areas especially the critical hot spots determined in the earlier findings. During the peak hour, this ultimate modification from trees and ground materials creates optimum differences in air temperature reduction as well as cooling effect compared to (B) and (C) conditions. This verifies the hypothesis that the urban air temperature conditions vary as tree densities and ground surface albedo values increase.

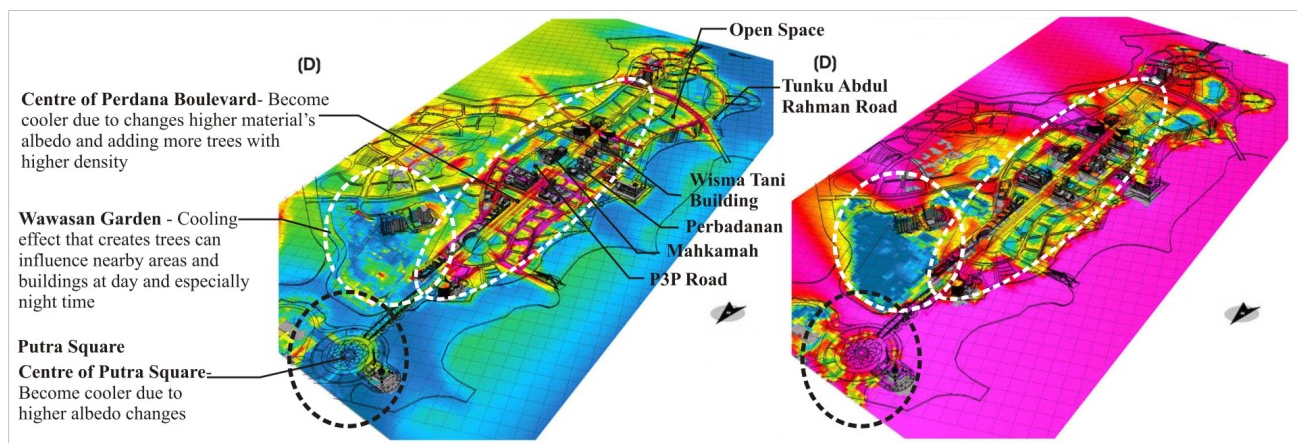

Figure 5.45 Predicted air temperatures in condition (D) where larger cooling effects can be found throughout the Persiaran Perdana area due to trees and ground material modifications (right) at 15:00; (left) at 03:00.

Conversely it is also worth noting the night time cooling effect (Figure 5.46). In the night time at 03:00 (i.e. 12 hours after peak temperature) the same condition occurs. However, in condition (A), most of the areas are hotter due to the fact that the heat stored in

the buildings and ground surfaces begins to radiate back into the environment (regardless the underestimations for the nocturnal cooling by night). Consequently, the ambience makes the surrounding areas much hotter at night time. However, with the presence of greenery in Wawasan Park, the cooling effects produced by trees during the daytime made it possible to neutralise this heat and keep the areas cooler at night; although effects were very limited to nearby areas.

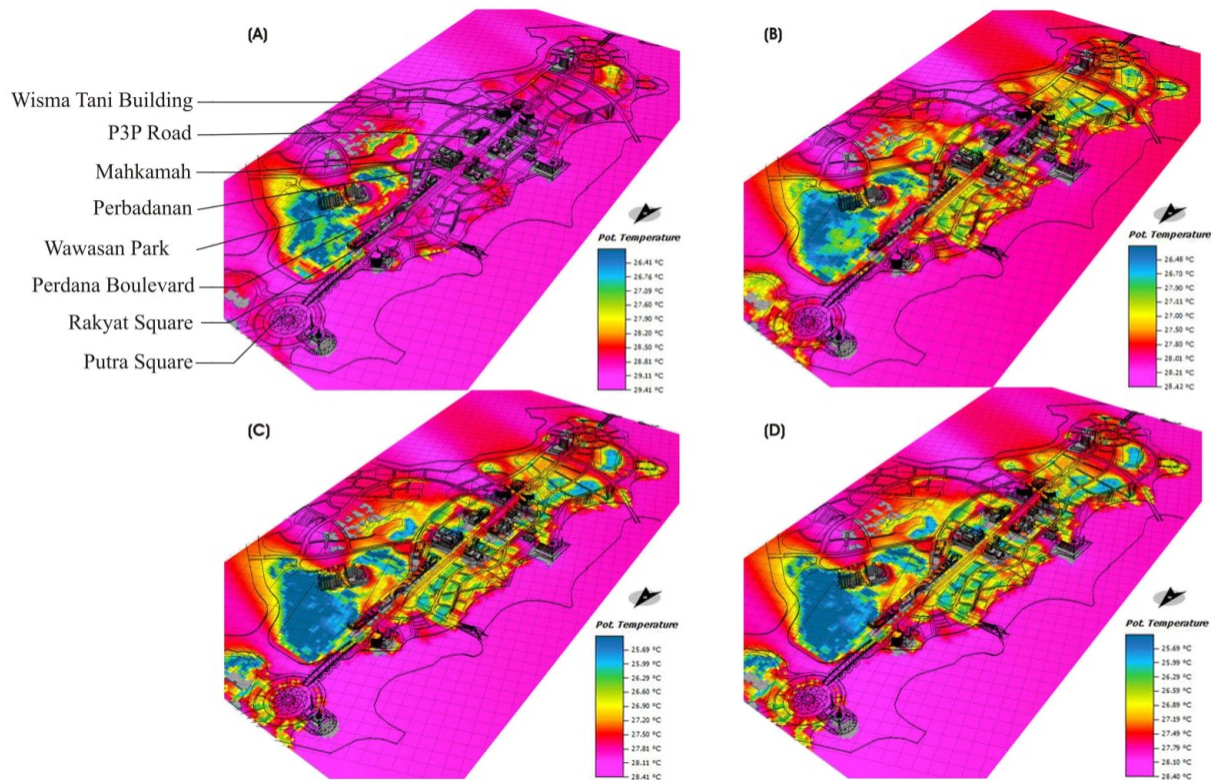

Figure 5.46. Air temperatures at four different conditions i.e. current condition (A) and modified environments (B) to (D) compared at 03:00 in three metres height

Ultimately, in modification scenarios of (C) and (D), the air temperature at most of the areas is reduced especially along the boulevard area where more yellow and blue spot areas can be found. Wawasan Park shows significant changes in air temperature after modification (i.e. conditions C and D) where blue spots are darker in comparison to conditions (A) and (B). It is believed that this is due to high canopy density trees which create solid shading during the day time and could sustain the cooling on the surface and keep the moisture content in the soil during the night time.

The daytime heat storage expelled to the air is much lower compared with the exposed area. In addition, there is practically no heat storage in the vegetated surface, thus the variance

in air temperature can be found in the highest density vegetated areas. However, it should be noted that with high canopy density trees, the heat could be trapped with a lower release rate in comparison to exposed areas due to the high volume of tree canopy density which blocks daytime heat to release quickly. Thus, the temperatures early in the day are much higher than those in exposed areas. However, this condition was not influential on the daytime cooling effect as the cooling process is much more significant than the heat trapped condition during the night time.

Based on the 24 hour simulated results from the 12 location points from each condition, presented in Figure 5.47, the lowest air temperature reduction in each location point can be found in condition (D). As far as the average air temperature is concerned, the pattern is very obvious and there is a significant difference in every condition.

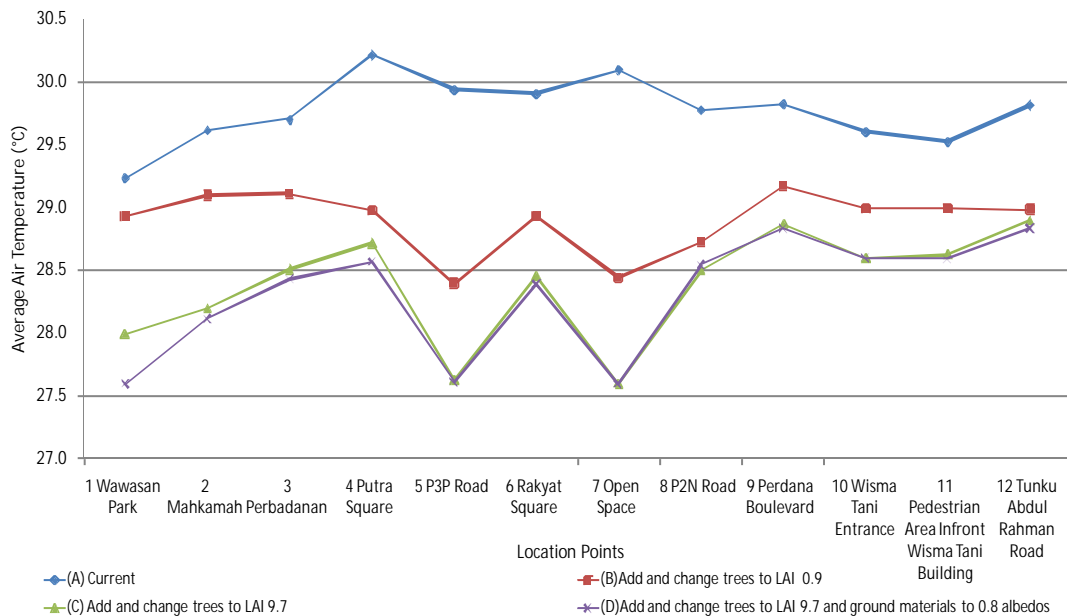

Figure 5.47. Average air temperatures for 12 location points from conditions A to D

In comparison to each modification with the current condition, most of the areas were found to be within average temperature differences with magnitudes of 0.9°C, 1.4°C and 1.5°C for condition B, C and D respectively. The results show that almost 60% of average temperature differences are when the tree densities are changed from low (condition B) to high canopy density trees (condition C).

Conversely, it is also noticeable that the differences in changing to cool materials are less than 10% (i.e. condition C to D). These results reveal that within the whole 24 hour

period, the highest reduction of air temperature is originally obtained from high canopy density and large tree quantities; as the lesser effect is found from the changes of the ground surface material properties. Thus, modification of the physical aspect of trees offers a larger cooling effect in reducing air temperature; rather than ground material modifications. For instance, it can obviously be seen in P3P Road and the Open Space location point that the increase in quantities of high canopy density trees, from none to 124 to 288 additional trees in each location, creates a remarkable reduction of 2.3°C and 2.5°C, respectively. However, there is no further reduction when the similar ground surface is used in condition D.

In another example, when only the albedo was changed and a similar quantity of trees was retained, the reduction was only found to be a difference up to 0.4°C and was obviously observed in Mahkamah, Perbadanan, Wisma Tani Entrance and the Wisma Tani's pedestrian area location points. On the contrary, it is believed that modification of ground materials can significantly enhance the optimum cooling effect of vegetation due to low absorption of solar radiation and high ground surface moisture contents during the daytime. In fact, both combinations can provide an optimum effect in comparison to current conditions with a range of average air temperature found to be from 27.6°C to 30.3°C. This makes a maximum average difference with a magnitude up to 2.7°C.

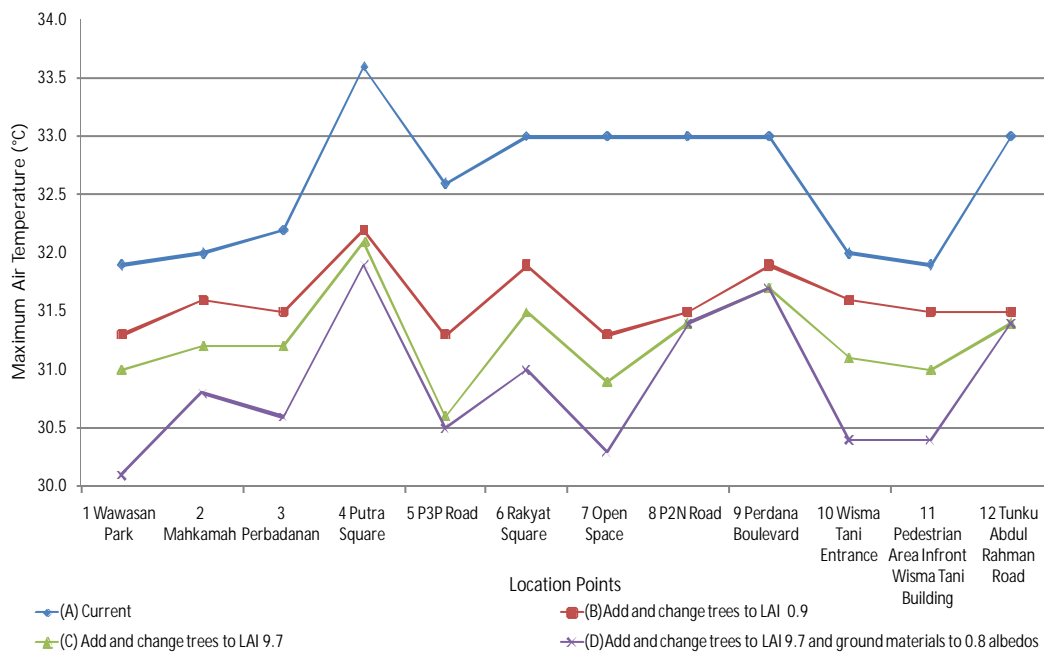

Figure 5.48 Maximum air temperatures for 12 location points from condition A to D

In Figure 5.48, as the maximum air temperature is in the main concerned with minimising the effect of UHI, the pattern is very obvious and there are significant differences in every condition. As a result of having large amounts of trees, large air temperature differences can be found in every location point. After modification each critical location is found in better and comparable condition with green spaces groups (i.e. Wawasan Park, Mahkamah, Perbadanan). Condition (D) shows the lowest maximum air temperature and the highest maximum differences were found in Open Space with magnitude of 2.7°C compared to the current condition (A). This is due to the effectiveness performance in the cooling process of trees and the ground surface during the peak hours. During these hours, it is believed that all cooling processes were taken into consideration such as radiation filtration, shading effect and the evapotranspiration process. By having enough tree quantity, high canopy density trees and albedo materials offers an optimum cooling process that could offer a remarkable reduction in air temperature. On average, each location point in each modification scenario could reduce by about 0.9°C, 1.2°C and 1.4°C for conditions B, C and D respectively.

These results show the lower differences in average maximum from 0.3° to 0.5°C when comparing each condition. This is believed to be the result of the variation of the cooling process that took place in both different types of tree densities (i.e. LAI 0.9 and 9.7). However, the effect of cool materials can be seen with an average maximum difference of 0.2°C when comparing conditions C and D. These conditions optimise the effect of cooling from trees due to cool materials being placed underneath the canopy. For instance, Wawasan Park, Mahkamah, Perbadanan and Rakyat Square show a remarkable reduction of maximum air temperature when cool materials are placed underneath the canopy in condition D within the range differences of 0.2 to 0.6°C, respectively.

Thus, it can be noted that the cool materials performed optimally during peak daytime hours; due to the shading effect, radiation filtration and low absorption of incoming radiation from the materials. Overall, the maximum air temperature ranges from 30.1°C to 33.6°C when comparing conditions A and D and thus, leads to a maximum difference of up to 3.5°C. These large differences therefore become one of the possible ways to mitigate the effect of UHI in the Persiaran Perdana through the optimum cooling effect provided from both modifications.

5.3.3.2 Relative Humidity

In order to confirm the presence of the cooling effect, relative humidity throughout the area should be analysed. Contrary to air temperature profiles, the range of lowest relative humidity to highest relative humidity is represented in the blue to magenta colour, respectively.

Figure 5.49 shows the relative humidity at four different conditions during 15:00 hours. It clearly shows that in current condition (A), the lowest relative humidity is found at high density areas of buildings and hard surfaces; and low coverage areas of vegetation. It can commonly be seen at the centre of the boulevard where this environment can be found. This correlates with the result from air temperature profiles presented in the earlier section.

Conversely, the highest relative humidity can be found in the area with the largest proportion of trees such as Wawasan Park. Thus, it shows that more vegetation is able to promote the effective evapotranspiration process, releases more moisture content to the air and simultaneously increases the relative humidity. However, the effect is limited to this area and not considered significant enough to influence the larger urban area of the Persiaran Perdana.

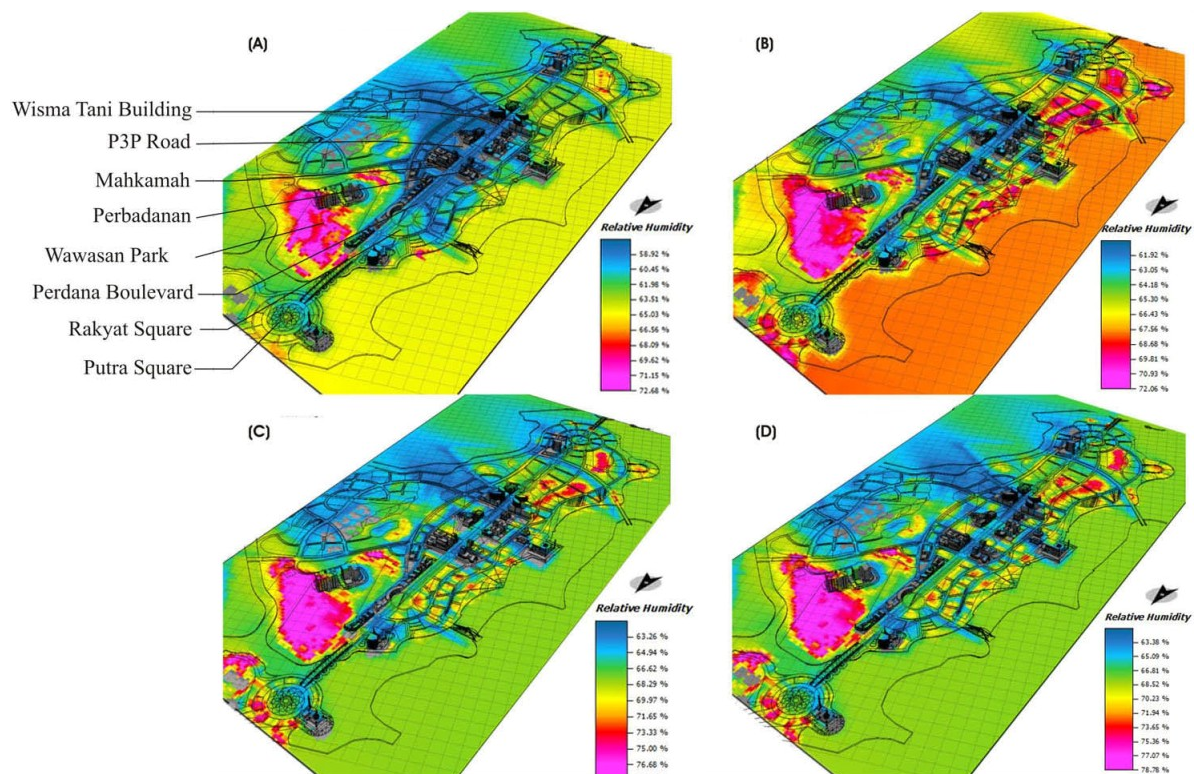

Figure 5.49 Relative humidity at four different conditions: current condition (A) and modified environments in conditions (B) to (D) compared at 15:00 in three metres height

The changes of relative humidity can be seen throughout all conditions in modification scenario environments. Based on the colour range in condition (B), it seems that the area is more humid than conditions (C) and (D). However, it should be noted that in condition (B) the range is lower from 60.8% to 72.06%, than condition (C) and (D) which is and 61.7% to 78.8% respectively. It is up to a 5.8% range difference in relative humidity. Therefore, conditions (C) and (D) are more humid than condition (B).

This condition is believed to be the result of the evapotranspiration process which releases more water vapour to the air and increases the relative humidity through larger quantities of high canopy density trees. It can clearly be seen that the presence of more yellowish to magenta colour spots in condition C is due to the changes in tree densities. Ultimately, in condition D, it shows that more magenta spots can be found and that relative humidity increased throughout the whole area. In addition, changes in tree canopy density and cool materials influence the surrounding relative humidity due to high evaporative cooling.

Cool material reflects more heat from solar radiation, lowering the heat absorption into the surface and finally keeps the surface cooler in daytime. This correlates with the per-tree cooling effect findings whereby, the greater effect of the cooling process takes place during peak hours from 13:00 to 17:00 hours. The Wawasan Park shows a remarkable increment up to 78.8% of relative humidity (i.e. darker magenta colour) due to the changes of tree canopy density. These increments of relative humidity correlate with the lower air temperature especially to the most of the critical spots situated in the middle of focal area of the Persiaran Perdana during the peak hours. This condition will also influence nearby areas such as buildings, open spaces and pedestrian areas due to higher relative humidity and lower air temperature.

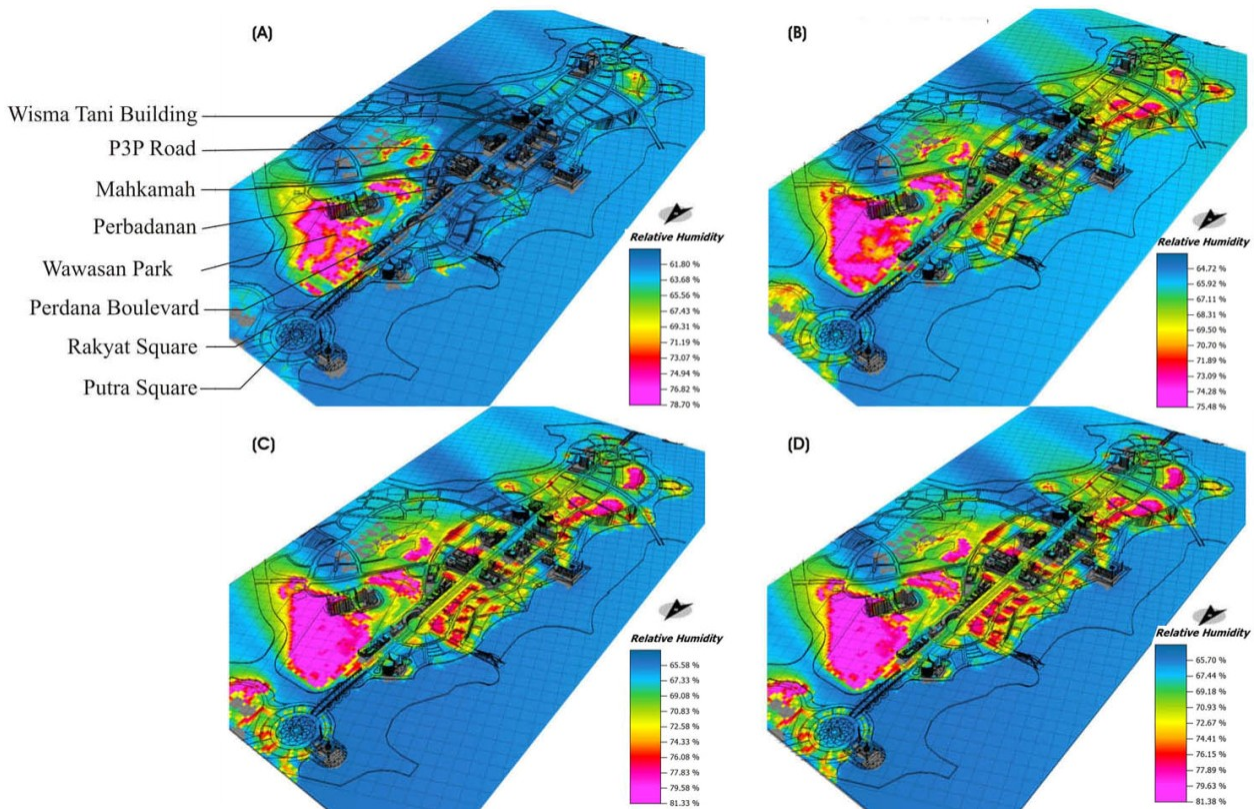

Figure 5.50 Relative humidity at four different conditions: current condition (A) and modified environments in conditions (B) to (D) compared at 03:00 in three metres height

Figure 5.50 shows the relative humidity for four different conditions at 03:00 hours. During the night time, the same phenomenon happens and remarkable changes of relative humidity can obviously be seen throughout conditions A to D. However, there are fewer changes in conditions C to D as the colour profiles make little difference. It is believed that the effects of cool surfaces are lessened during night time when compared to day time and the changes are greater on tree effects. Importantly, the cooling effects of trees are continuous during night time and can clearly be seen in Wawasan Park where the highest humidity can be found within this area.

Based on the 24 hour simulated results from 12 location points from each condition presented in Figure 5.51; the highest increment of humidity in each location point can be found in condition (D). On average, the pattern of average relative humidity was conversely with air temperature. The average temperature difference can be found with magnitude of 7.1%, 10.5% and 10.7% for conditions B, C and D when compared to current condition (A). Again, the effects of trees are larger than cool materials as the average difference in condition C and D is lower with magnitude of 0.2%. Different amounts of tree densities provide

different performance in modifying the humidity. This confirms the phenomenon happening in the air temperature where similar patterns were found. Ultimately, the average relative humidity after modification ranged from 57.1% to 73.5%. Thus there is about an 18% difference.

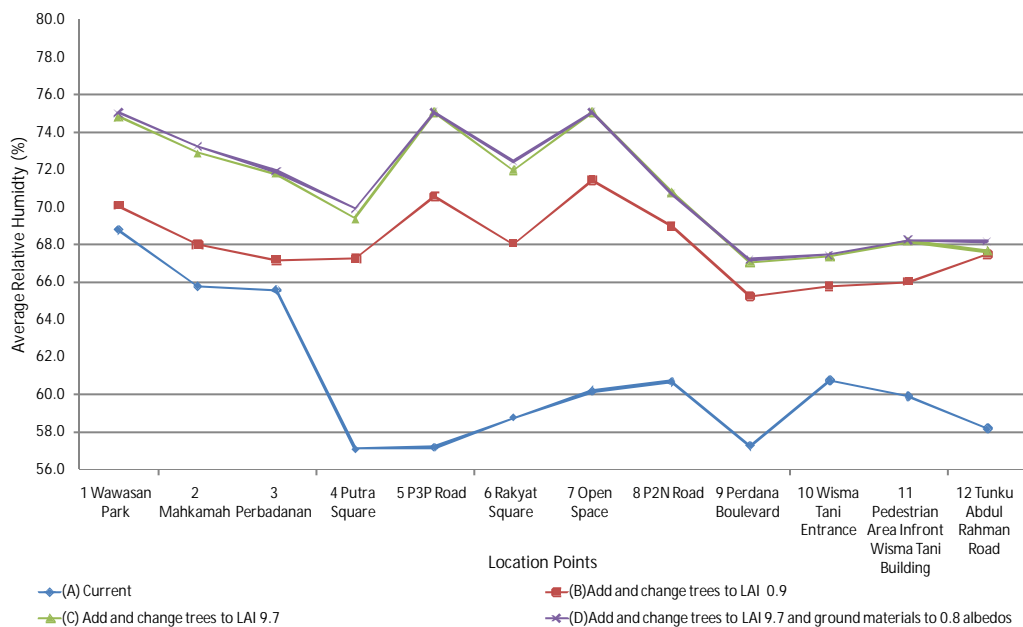

Figure 5.51 Average relative humidity for 12 location points from conditions A to D

In contrast to air temperature, minimum relative humidity becomes the main concern in evaluating the improvement of modification in the Persiaran Perdana area (Figure 5.52). The pattern in each scenario condition is very obvious as most of the critical areas such as Putra Square, P3P Road, Rakyat Square and Open Space are improved in terms of minimum relative humidity during the daytime peak hours. Thus, it shows that the cooling processes from variation tree densities were effective and provides high humidity to these areas. The main reason is due to high evapotranspiration process which releases the water vapour to the air. In fact, the optimum cooling effect can be achieved as cool materials were placed underneath high canopy density trees as clearly shown in condition D.

Furthermore, the effects of shading and radiation filtration enhance the process and higher relative humidity can be achieved in this scenario condition. In achieving an optimum cooling effect from this modification, it is important in tropical climates to achieve higher relative humidity during the hottest day in order to balance the mixture of air with excessive heat from ground and buildings materials. However, it is worth mentioning that in an outdoor thermal comfort point of view excessive humidity may become worse. However in a tropical

climate, it is believed that people are able to tolerate much higher temperatures and humidity than those in temperate regions due to adaptation and acclimatisation (Wong and Yu, 2009). On average, each location point in every modification scenario could increase about 7.5%, 10.3% and 11.1% for conditions B, C and D. These made a difference of 2.8% in comparison to loose canopy density (condition B) and high canopy density trees (condition C).

Conversely, both modifications (condition D) create a difference of 0.8% due to the effective cooling process that allows the increment in relative humidity. Thus, these effects create an optimum cooling throughout the whole scenario modification; and reveal the importance of modifying physical properties of each entity. Ultimately, the minimum relative humidity range is from 51.1% to 70.91% in comparison to conditions A and D. These make a minimum difference of up to 19.8%.

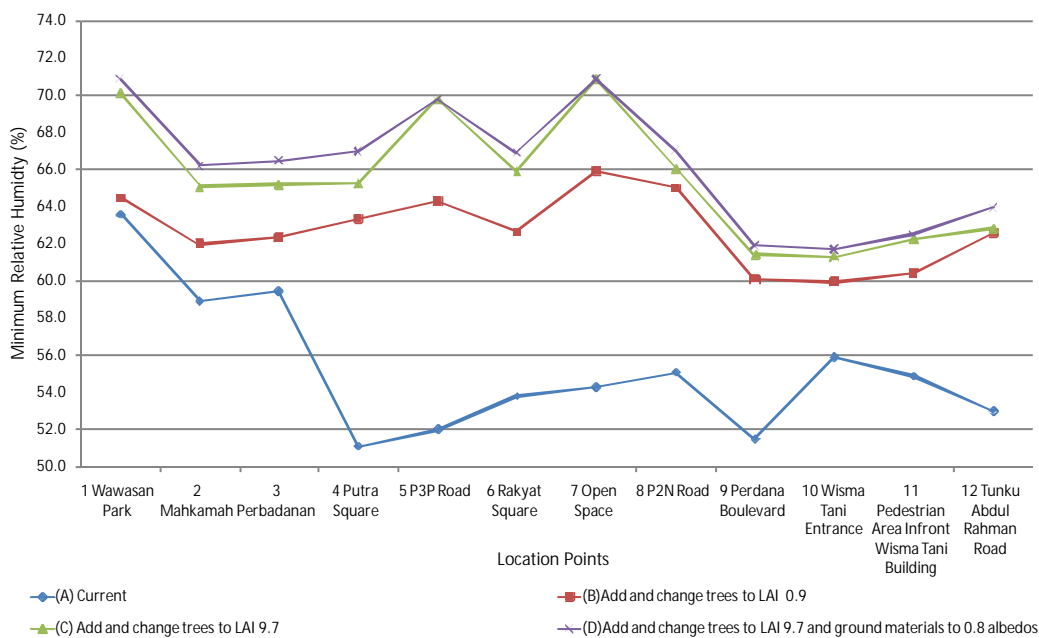

Figure 5.52 Minimum relative humidity for 12 location points from conditions A to D

5.3.3.3 Absolute Humidity

In confirming the presence of the vegetative cooling effect due to the effectiveness of the evapotranspiration process, the absolute humidity results from each modification are significantly important (Kurn et al, 1994, Spangenberg et al, 2008). The air moisture contents were presented and determine the evapotranspiration rate from each location which influences the air temperature and relative humidity conditions. Figure 5.53 shows the absolute humidity at four different conditions during 15:00 hours. The range of lowest to the highest absolute

humidity was represented in the gradient colour from white to magenta, respectively. Obviously, it can be seen that most of the areas in condition (A) are found in the lowest absolute humidity due to less planted vegetation in the Persiaran Perdana. The middle area of the boulevard is found to be the lowest and this correlates with air temperature and relative humidity profiles.

Based on these results it is confirmed that at the current stage, the Persiaran Perdana has a lower amount of vegetation which cannot provide enough vegetative cooling to the whole surrounding; regardless of the cooling effect from Wawasan Park that only provides to near surrounding areas. During this peak hour, the range of absolute humidity in condition (A) was found to be from 21.92 to 26.78 g/m³ with a difference of 4.86 g/m³.

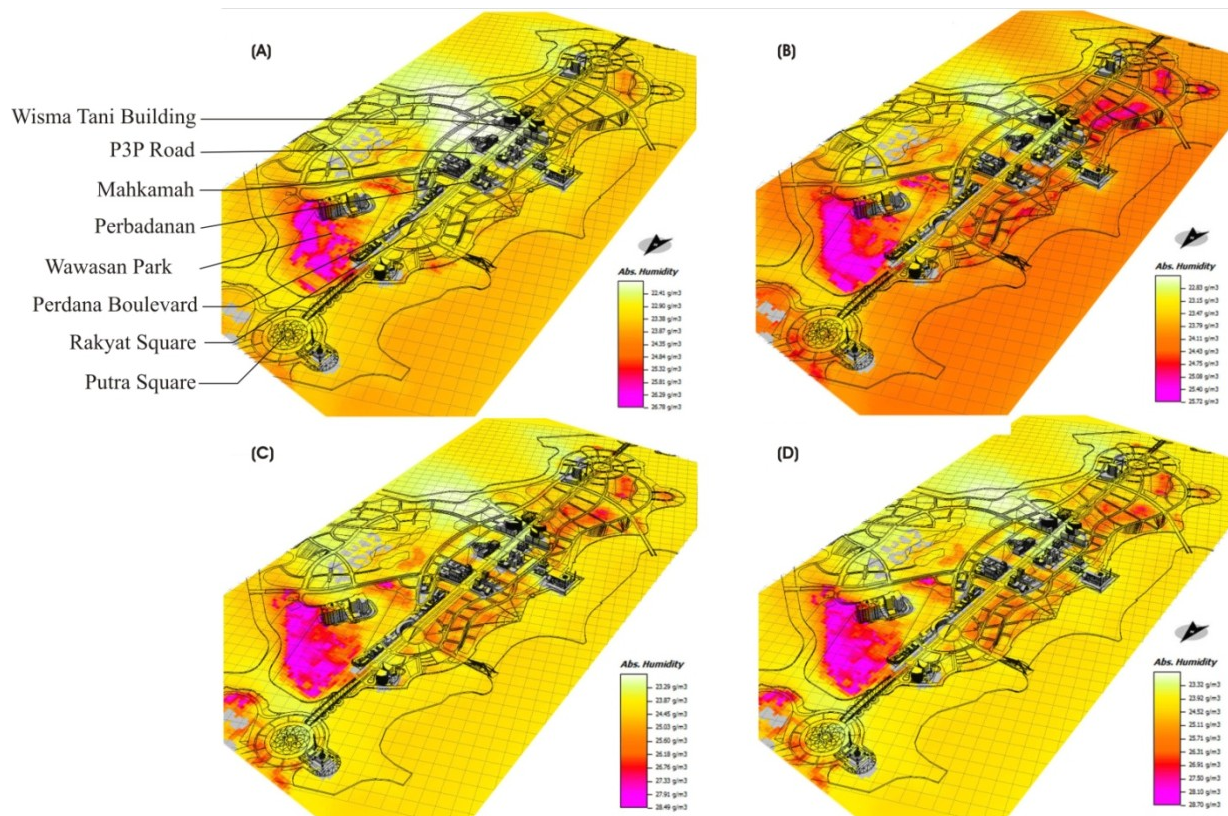

Figure 5.53 Absolute humidity at four different conditions: current condition (A) and modified environments in conditions (B) to (D) compared at 15:00 in three metres height

Meanwhile, it is worth mentioning that after modification in condition B with loose canopy density it can be observed that moisture content in the air becomes lower with magnitudes from 22.51 to 25.72 g/m³ regardless of the colour representation being darker

than other modification scenarios. This makes a difference of 3.21 g/m^3 . It has been proven in the earlier findings that absolute humidity correlates with canopy density of trees. Rationally, the average tree canopy density of the current condition is higher than LAI 0.9 and this makes the moisture content much higher than condition (B) despite about half of additional trees being added to the site.

Based on this situation, this study claims that absolute humidity influenced from the evapotranspiration rate are greatly influenced by tree canopy density rather than quantities of trees. This is due to the larger amount of leaf coverage that allows transpiration of more moisture to the air (Jacobs et al, 2003); and the effect of shading could maximize the evaporation process from leaves and ground surfaces (Dimoudi and Nikolopoulou, 2003) especially during the hottest day in tropical climate.

Conversely, the modification in condition (C) with high canopy density trees creates a remarkable increment within a range of 22.71 to 28.49 g/m^3 with difference of 5.78 g/m^3 . This increment of absolute humidity is believed to be one of the reasons in significant reduction of air temperature and large increment of relative humidity. High evapotranspiration process due to high canopy density of trees provides large amount of vegetative cooling. The effect is much greater in condition (D) where the range become a bit higher within a range of 22.72 to 28.70 g/m^3 with difference of 5.98 g/m^3 . This is due to the changes of cool materials that reduce the absorption amount of radiant heat and release more latent heat fluxes to air.

This effect is supported by solid shading with almost full radiation filtration from the canopy that increases the ground surface evaporative cooling which releases more moisture content to the air. However, the cooling effects of cool materials (i.e. condition B) are rather small with only 0.2 g/m^3 compared to vegetative cooling (i.e. condition C) with a difference of 2.57 g/m^3 . In other words, the evapotranspiration rate was greatly influenced from the tree canopy density rather than ground materials.

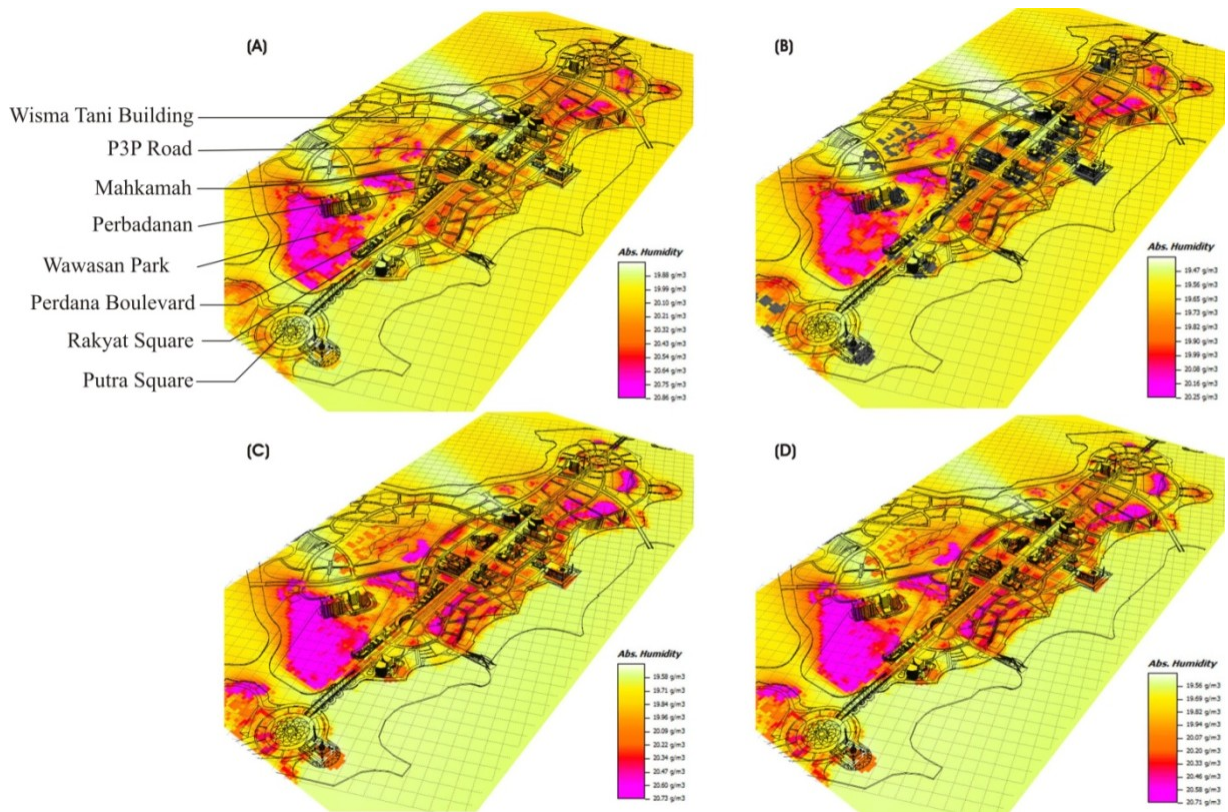

Figure 5.54 Absolute humidity at four different conditions; current condition (A) and modified environments in condition (B) to (D) were compared at 03:00 in three metres height

At night time, it can be observed that the absolute humidity becomes lower in all four conditions as presented in Figure 5.54. In all conditions, the range of absolute humidity is found to be from 19.38 to 20.71 g/m^3 . The absolute humidity becomes insignificant due to the process of photosynthesis that does not occur during the night time as the respiration process is more likely to take place. Hence, it is believed the evapotranspiration rates during these hours are the lowest.

During the night time when the outdoor temperature is lower, the daytime heat storage from the ground and building is slowly expelled to the environment by radiation and by convection (Santamouris, 2001). Therefore, the night temperature become slightly higher and the relative humidity become lower due to the heat transfer process.

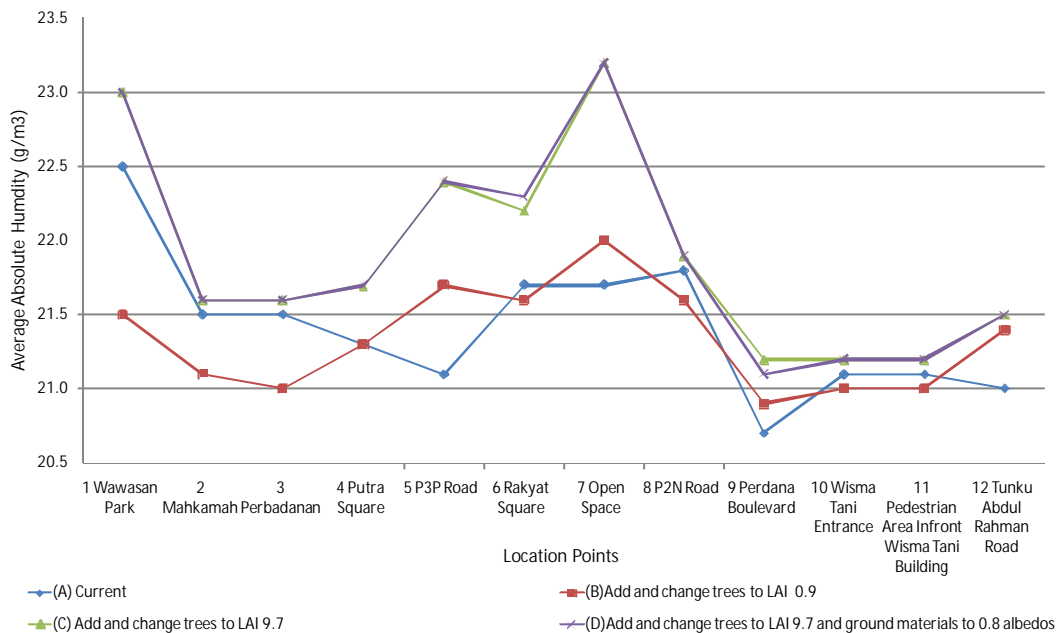

Figure 5.55 Average absolute humidity for 12 location points from condition A to D

Figure 5.55 shows the average 24 hours simulated results from 12 location points from each scenario condition. The highest increment of absolute humidity is found to be in condition (D) where most of the areas are increased in moisture content. This result has proven that by having high canopy density trees, the evapotranspiration rate is increased significantly. Besides, the significant increase of relative humidity and reduction of air temperature is believed to be due to this optimum improvement.

For instance, the Open Space and P3P road showed a remarkable improvement when 288 and 124 numbers of high canopy density trees were added to the site and made the changes up to 1.5 g/m^3 and 0.8 g/m^3 , respectively. However, on average it can be seen that the changes of ground materials do not provide much effect as the similar pattern and average values was found to be 25.1 g/m^3 in both conditions (C) and (D). Thus, this condition explained the average condition happening in average air temperature and relative humidity where the same pattern in conditions C and D were similar. This is due to the less effect of cool materials to expell heat during the night time.

Conversely, by comparing conditions (A) and (B) the evapotranspiration rate is much higher in condition (A), for example, in Wawasan Park, Mahkamah, Perbadanan, Putra

Square, P2N Road, Perdana Boulevard, Wisma Tani's entrance and pedestrian area. This is due to the canopy density of trees in the current condition which is the average LAI values are found to be at 2.4 (PPJ, 2008). Based on this condition, again, it is confirmed that the evapotranspiration rate was defined significantly according to the canopy density of trees rather than quantities of trees. However, if there is high canopy density with appropriate tree quantities; the effect of vegetative cooling becomes optimum. This has been proved where the average differences in each modification scenario compare to condition (A) and are about -0.2 g/m^3 , 0.4 g/m^3 and 0.4 g/m^3 for conditions B, C and D. Ultimately, the average of absolute humidity before (i.e. condition A) and after both modifications (i.e. condition D) ranged from 21.0 to 23.2 g/m^3 and makes the difference up to 2.2 g/m^3 .

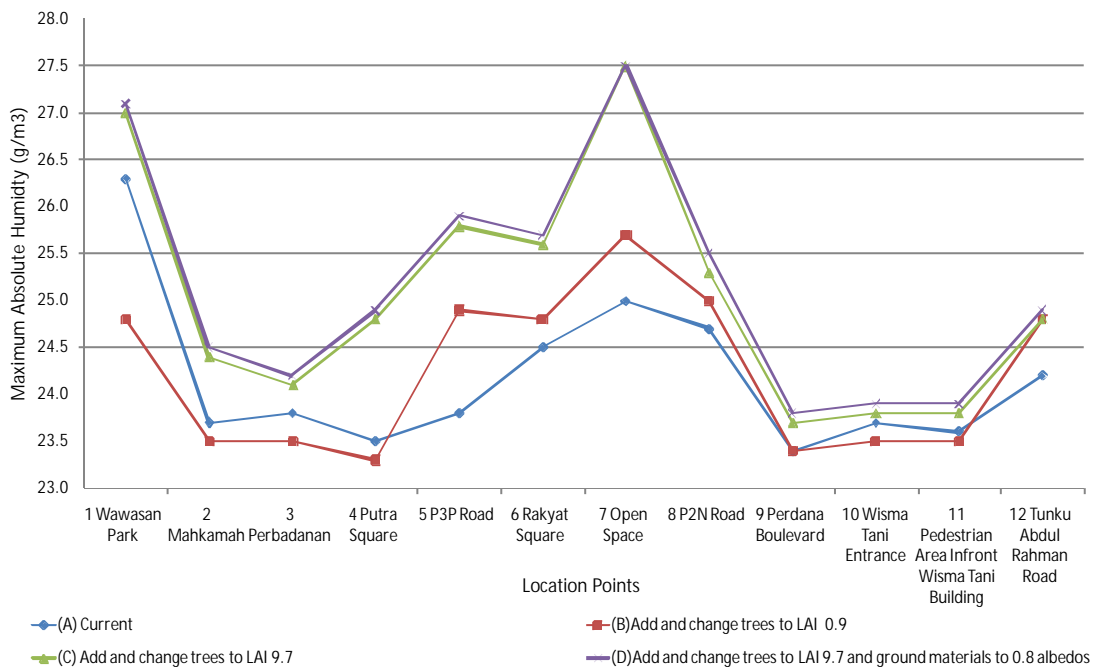

Figure 5.56 Maximum absolute humidity for 12 location points from conditions A to D

With respect to the peak time condition, the maximum absolute humidity is presented in Figure 5.56. Obviously, the highest maximum absolute humidity was found in location points in condition C and D. During this hour, the effect of cool materials in maximising the effect of the evapotranspiration rate can be clearly seen with differences of about 0.1 g/m^3 in each location point. This confirmed the effect of cool materials towards absolute humidity during the peak hours. However, the effect of the cooling of cool materials is believed to greatly influence the surface temperature that reduces heat absorption and releases latent heat to the air during the peak daytime hour. Conversely, the actual effect of vegetative cooling

can be seen clearly in Wawasan Park, Mahkamah and Perbadanan where the tree quantities remain the same as the current condition.

The variation of tree canopy density in each condition creates a different amount of evapotranspiration rate in each condition. The larger the tree densities the greater the effect of the evapotranspiration rate and maximisation of the cooling effect to the urban environment. In fact, as more trees are added to the urban area the moisture content in the air becomes higher. For instance, the open hard surface group considered as a critical area in the earlier stage; creates dramatic changes in the absolute humidity due to an increase of trees that provide a significant rate of evapotranspiration. All these conditions contribute to a lower air temperature and increase of relative humidity. In fact, the vital condition with modification of vegetation and ground materials increase the efficiency in optimising the cooling effect especially during the hottest day in the Persiaran Perdana. This modification makes a maximum difference up to 4.2 g/m^3 within a range of maximum absolute humidity of 23.4 to 27.6 g/m^3 . Thus, it is believed that factors such as vegetative cover, leaf area index and the reflectivity of ground surfaces can affect rates of evapotranspiration and optimising the amount of moisture content in urban areas (Burba, 2006).

5.3.3.4 Ground Surface Temperature

Figure 5.57 shows ground surface temperatures at four different conditions at 15:00 hours. In condition A, a similar air temperature profile is found to be in the surface temperature during 15:00 peak hours. The highest surface temperature is found at the focal area where lower albedo materials are located such as tarmac and red concrete pavement. It can be found predominantly in the boulevard area and this is believed to be one of the reasons why the air temperature becomes higher in this areas. In fact, it is evident that both surface and air temperature are in a similar condition in most critical areas.

Thus, it can be noted that higher surface temperature is significantly correlated with higher air temperature and vice versa. On the contrary, ground surface underneath tree canopies were found to be cooler (green colour) due to the shading effect of trees, e.g. in Wawasan Park. It becomes greater when leaf density becomes higher, e.g. condition (B) to (C); where in condition (C) lesser magenta spots were found and turn from a greenish to bluish colour which represents a lower surface temperature. These surface temperature

reductions are due to the high quality of shading and radiation filtration as these effective cooling processes are on its peak.

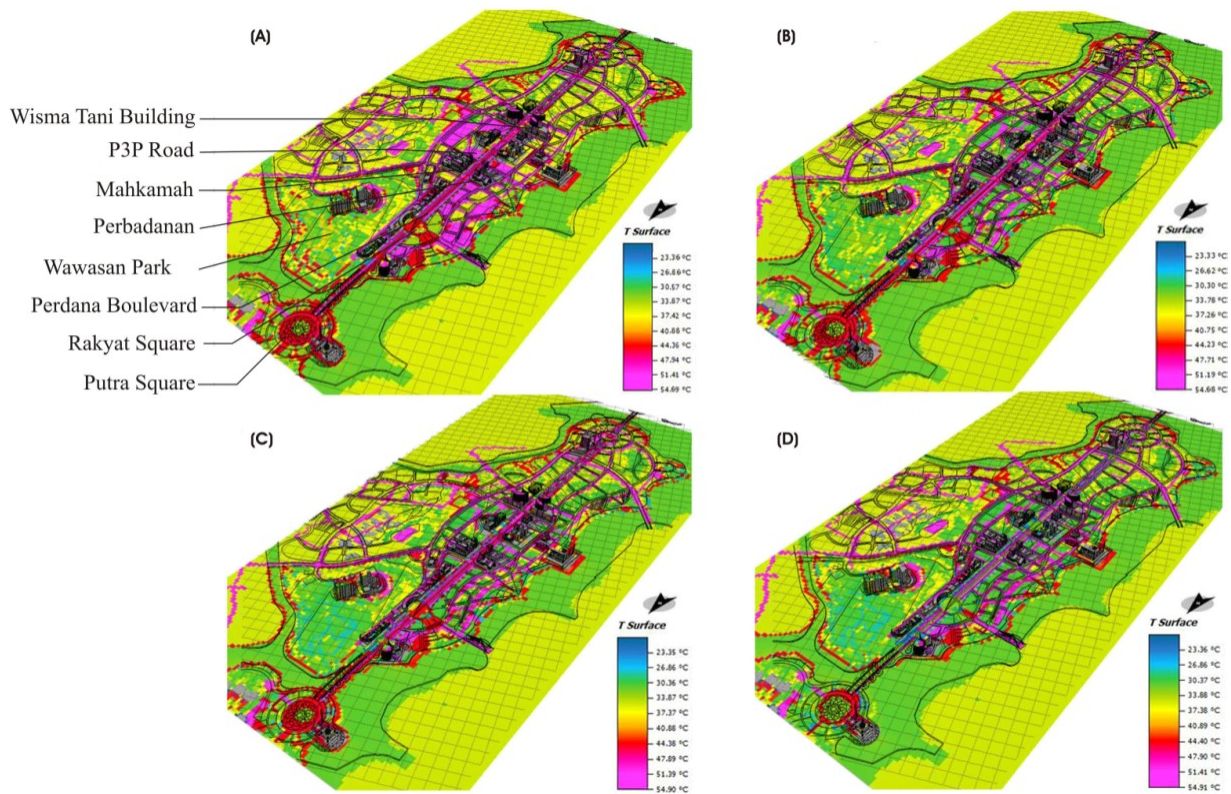

Figure 5.57 Ground surface temperature at four different conditions: current condition (A) and modified environments in conditions (B) to (D) compared at 15:00 at ground level

Consequently, this condition leads to further reduction on the ground surface temperature underneath the canopy and more latent heat fluxes are released as compared to less effect from the loose canopy. More evaporation processes from the ground and transpiration processes can be found due to the stability of water content in the soil. This explanation becomes a concrete reason for the larger variation of air temperature, relative humidity and absolute humidity which can be found between these two modification scenarios. Moreover, there is quite a difference in colours where a more bluish colour and less high surface temperature is found in condition (D) as magenta colours settle. The changes obviously can be seen in Putra Square, Rakyat Square and along the Perdana Boulevard area.

The bottom line here is that when modification of materials is made; most of hot (magenta) surface materials turn to cool (blue) surface materials. This indicates clearly that cool materials play an important role in further reducing ground surface temperature as the cooling process become optimum, regardless of the effect from high canopy density trees.

Consequently, the air is much less heated, the air temperature becomes lowest and relative humidity is highest among other modification scenarios. This verifies the hypothesis that urban air and surface temperature conditions vary as the tree densities and ground surface albedo values are increased. Alternatively, it should be noted that changes to grass cover are recommended as it can maintain the moisture content and promote better evaporative cooling to the surrounding area.

A similar condition occurs during the night time (Figure 5.58). However, after the modification stages, the surface temperature will still be hot due to heat absorption at daytime that takes some time to release. This can be seen in the ground area represented with a yellowish colour that is covered with trees. Nevertheless, the ultimate reduction can be seen tremendously in condition (D) where most of the surface temperature becomes lower due to changes of cool materials. It can also be noted that the effects of ground cooling are continuous until the night time, regardless the less effect of heat released during these hours.

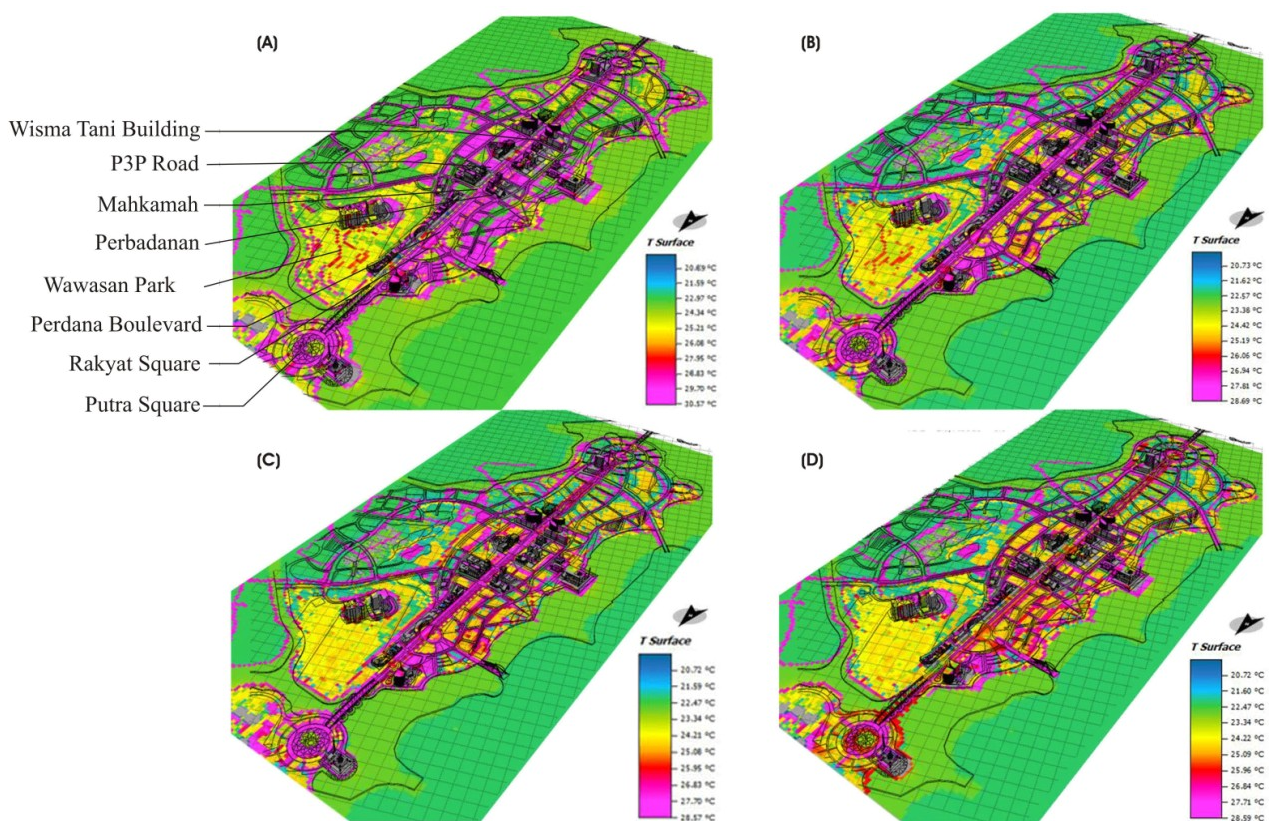

Figure 5.58 Ground surface temperature at four different conditions: current condition (A) and modified environments in conditions (B) to (D) compared at 03:00 at ground level

Based on the 12 location simulated results presented in Figure 5.59; the surface temperature for most of the areas was reduced to an average of 3.4°C, 4.2°C and 6.7°C for conditions B, C and D in comparison to condition A, respectively. Based on these results it can obviously be seen that the modification to cool material creates a significant reduction in surface temperature with almost 60% increases of average reduction in comparison to condition C and D. Meanwhile, only 25% average reduction of ground surface temperature can be found with the changes on tree densities with no changes in existing current surface materials. Thus, cool materials greatly influence the ground surface temperature as the albedo is increased and it confirms that the effect becomes optimum when placed underneath the canopies.

For instance, the differences can be seen in some of the areas in condition (D) when the cool materials are replaced. The critical location points, such as Putra Square, Rakyat Square, Tunku Abdul Rahman Road and Perdana Boulevard previously determined with high surface temperature in the field measurement, have resolved into lower surface temperature areas consequently reducing the surrounding air temperature. Ultimately, the average ground surface temperature after the modification ranges from 22.7°C to 35.8°C making a significant reduction of 13.1°C.

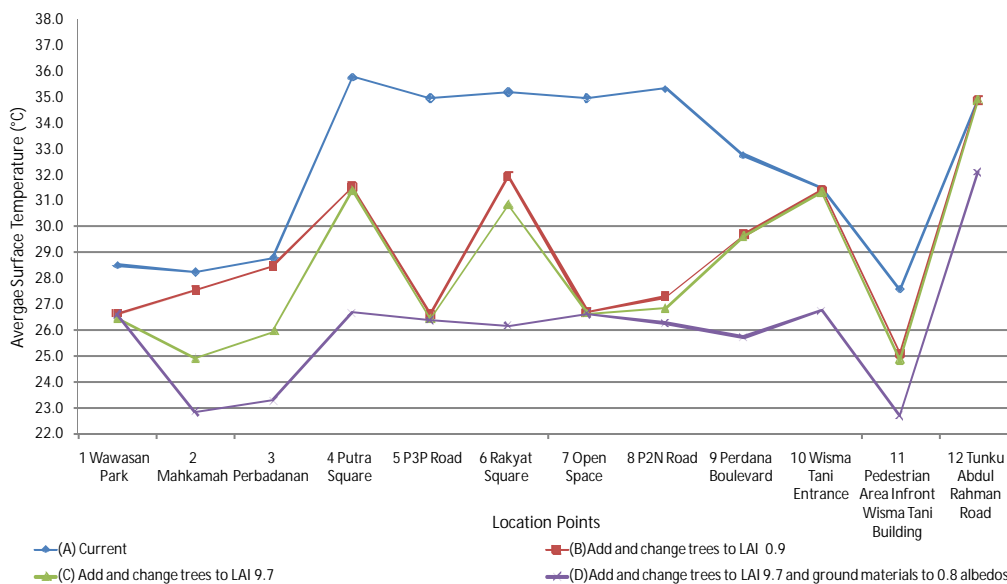

Figure 5.59 Average surface temperatures for 12 location points from conditions A to D

Similar to air temperature, the maximum surface temperature becomes important as the values determine the reduction of air temperature in UHI evaluation. In Figure 5.60, a comparable pattern with average surface temperature is obtained. However, on average, the

maximum surface temperature in 12 location points was found with magnitudes of 7.1°C, 9.7°C and 14.7°C for conditions B,C and D. Again, the optimum reduction of surface temperature can be found in condition D where vegetation and surface materials was modified. In fact, about 65% reduction when the ground surface was modified to cool materials, whilst only a 37% reduction for tree physical properties modification from loose to high canopy density with lower albedo materials. This large reduction in condition D is important for reducing large amounts of air temperature in the peak hours as in the current condition (i.e. condition A) whereby the high surface temperature has become a major issue to the Persiaran Perdana area.

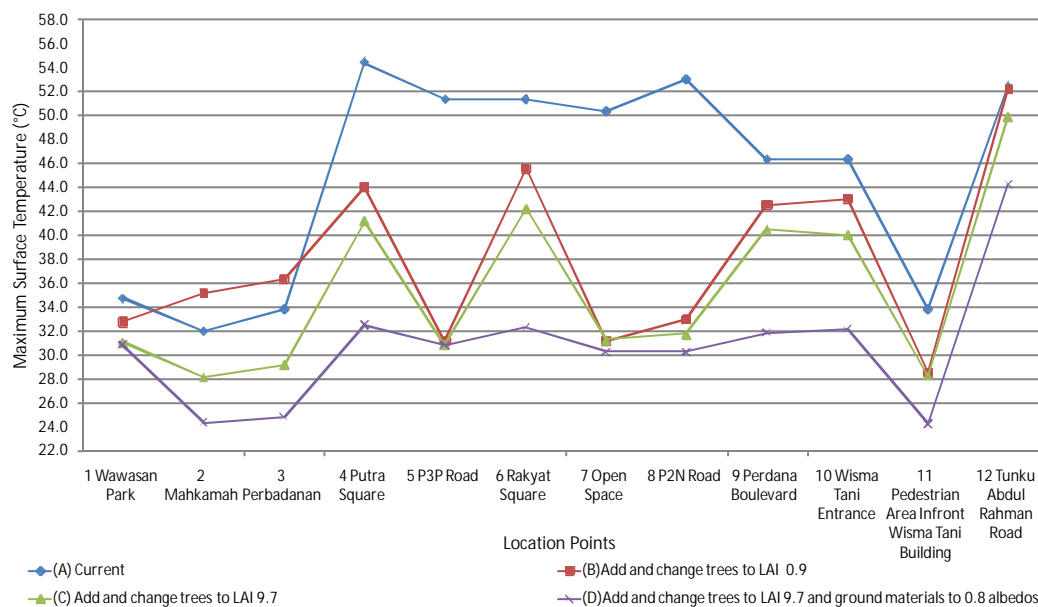

Figure 5.60 Maximum surface temperatures for 12 location points from conditions A to D

Thus, these differences reveal the importance of cool materials in providing the optimum cooling effect and the effectiveness in providing both modifications in urban areas especially during the daytime peak hour. The areas such as Putra Square, Rakyat Square, and the Perdana Boulevard show large differences in surface temperature in this optimum modification due to cool material changes, especially underneath the canopies. In contrast, the high surface temperature of the lower albedo minimise the effects of cooling in condition C as the surface releases more sensible heat than latent heat fluxes. In fact, the evapotranspiration process becomes lower due to large absorption of radiant heat into the ground surfaces. Ultimately, the maximum ground surface temperature ranges from 24.3°C to 54.5°C making a large difference to maximum surface temperature with a magnitude of 30.2°C during the peak of day time hours.

5.3.3.5 Radiant Temperature

As presented in the earlier findings in section 5.3.2.6, modification on mean radiant temperature will explain the possibility of reduction of radiant heat (i.e. short and long-wave radiation) due to radiation filtration and shading effects from the tree canopy as well as the effectiveness of ground surface reflectivity. These conditions are related to the human energy budget and have an effect on the outdoor thermal comfort as further results explain in chapter six. This finding is significant in the relationship to air temperature, relative humidity and absolute humidity conditions. As mean radiant temperature becomes another important meteorological measure in tropical climates; the modification on the maximum radiant temperature during the hottest day is the primary concern.

Figure 5.61 shows the mean radiant temperature at four different conditions during 15:00 hours at one meter height. The image shows the gradient colour marked from blue to magenta which represents lowest to highest mean radiant temperature within a range of 29.5° to 82.7°C respectively.

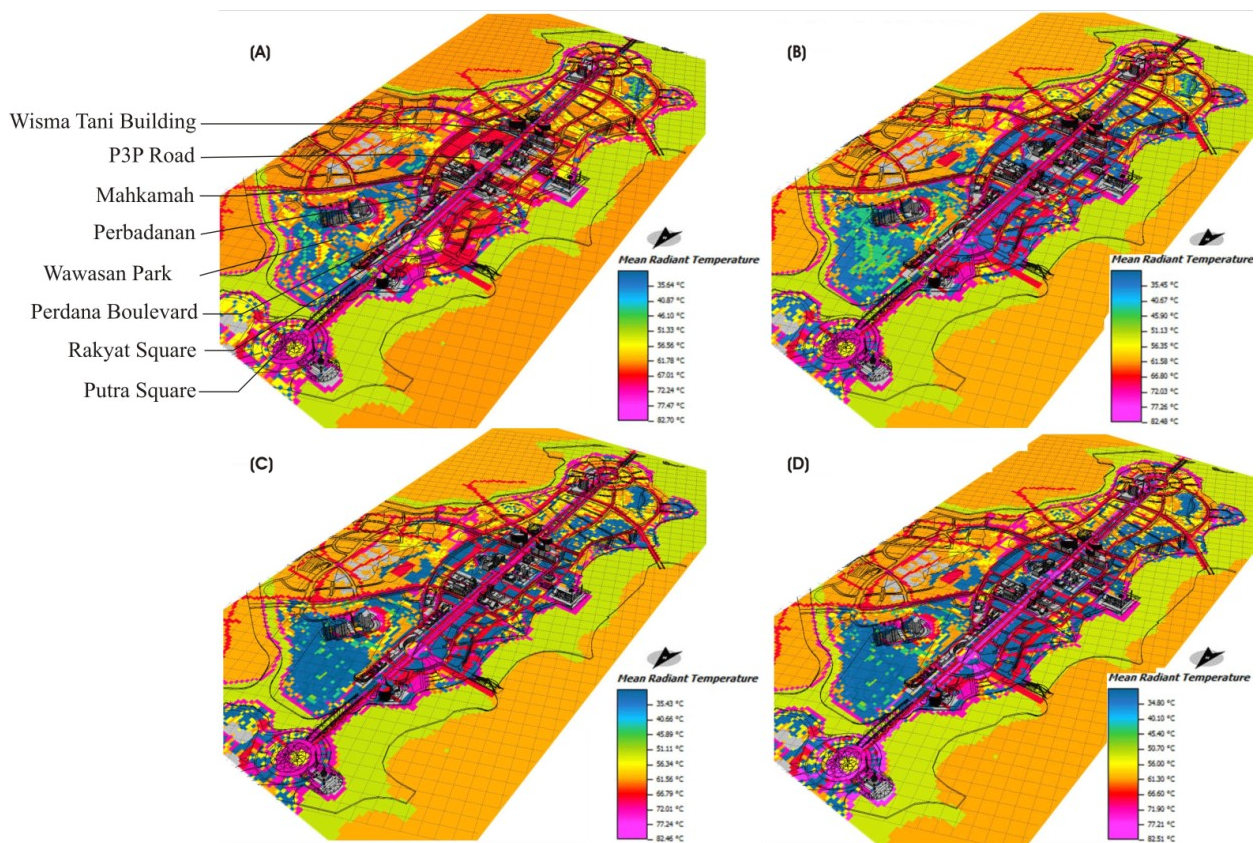

Figure 5.61 Mean radiant temperature at four different conditions: current condition (A) and modified environments in conditions (B) to (D) compared at 15:00 at 1 meter height

It can be observed that the mean radiant temperature profiles in current condition (A) are mostly covered with the highest mean radiant temperature (i.e. red to magenta colour) especially at the centre area of the Persiaran Perdana. This condition correlates with air temperature, relative humidity and the ground surface temperature profile where most of the reason is due to lack of greenery, lower ground albedo materials and higher building density. With respect to radiant heat distribution, this condition releases the highest rate of sensible heat fluxes from buildings and ground materials as the conversion of more short and long-wave radiation from hard surface creates unbalanced radiant energy in this area. Consequently, the air and surface temperature becomes higher and relative humidity lower. In referring to these conditions, the current condition energy budget is significantly higher.

In conditions (B), (C) and (D), the modification on tree quantities creates significant changes in mean radiant temperature. In fact most of critical areas especially in the Open Hard Surface group are settled and reduced to their minimum. However, there are differences in minimum values where about 30.23°C, 30.20°C and 29.5°C can be found in conditions B, C and D during peak hours, respectively. The modification of vegetation and ground materials make the crucial difference. The changes from the exposed area to vegetated cover and cool materials provide a significant improvement in altering the radiation entities.

The reduction of incoming solar radiation caused by high density tree canopy filtration create a solid shading that offers less amount of short and long-wave underneath the canopy with high reflectivity of cool materials creating this remarkable reduction. This becomes another reason associated with the air and ground surface temperature becoming lower. Thus, the optimum reduction of mean radiant temperature can be found in condition D where both modifications were required. Technically, the human energy budget in the Persiaran Perdana was therefore improved efficiently.

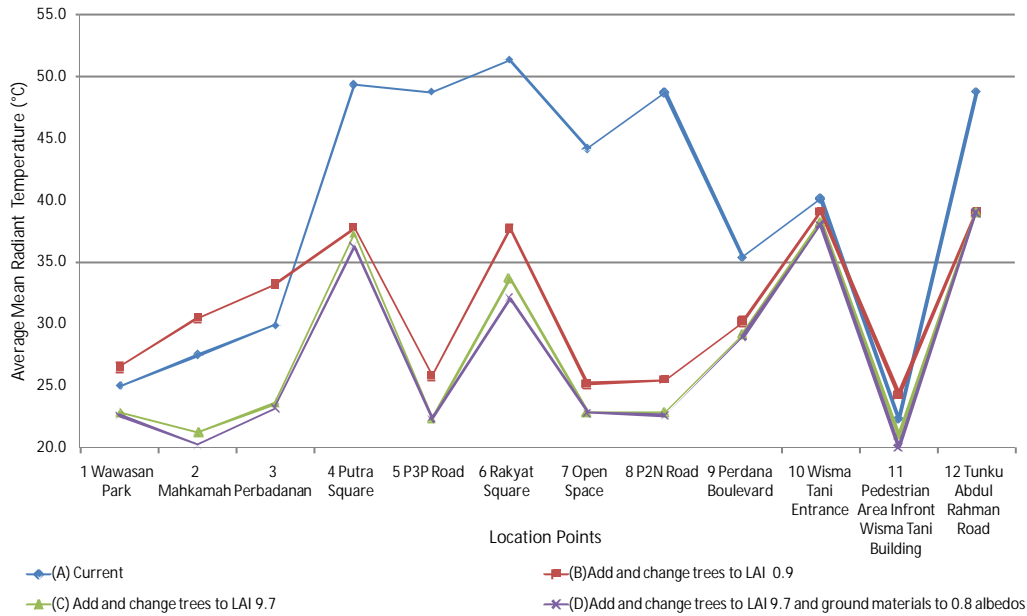

Figure 5.62 Average mean radiant temperature for 12 location points from conditions A to D

Figure 5.62 shows the average mean radiant temperature for 12 location points from conditions A to D. It can be observed that most of the location points are improved due to the modification on tree quantities, physical properties and cool materials. For instance, Putra Square, P3P Road, Rakyat Square, Open Space, P2N and Perdana Boulevard show a significant reduction as more trees are added to the site. Conversely, green spaces groups mean radiant temperature modification results correlate with tree density values.

It worthy of mention that the mean radiant temperature in the Wisma Tani entrance remains in a similar condition as there have been no changes to tree quantities in this area. On average, the mean radiant temperature in conditions (A), (B), (C) and (D) are to be within the magnitude of 39.3°C, 31.2°C, 27.8°C and 27.4°C respectively. This makes a difference of 8.1°C, 11.5°C and 11.9°C for conditions (B), (C) and (D) in comparison to condition (A). The results correspond to each level of modification and the optimum reduction can be found in condition D. The effect of high canopy density trees is higher with 45% differences and combination of cool materials making a further reduction of 6%. Thus, the lowest radiant can be found within the area full of shaded trees that provide high quality radiation filtration and shading and optimum reduction after combination of modification of ground surface to cool materials.

The effect of cool materials becomes effective as the ground temperature lowers due to the effect of tree canopies. Ultimately, the mean radiant temperature ranged from 22.3°C to 39.0°C making an average difference up to 16.7°C.

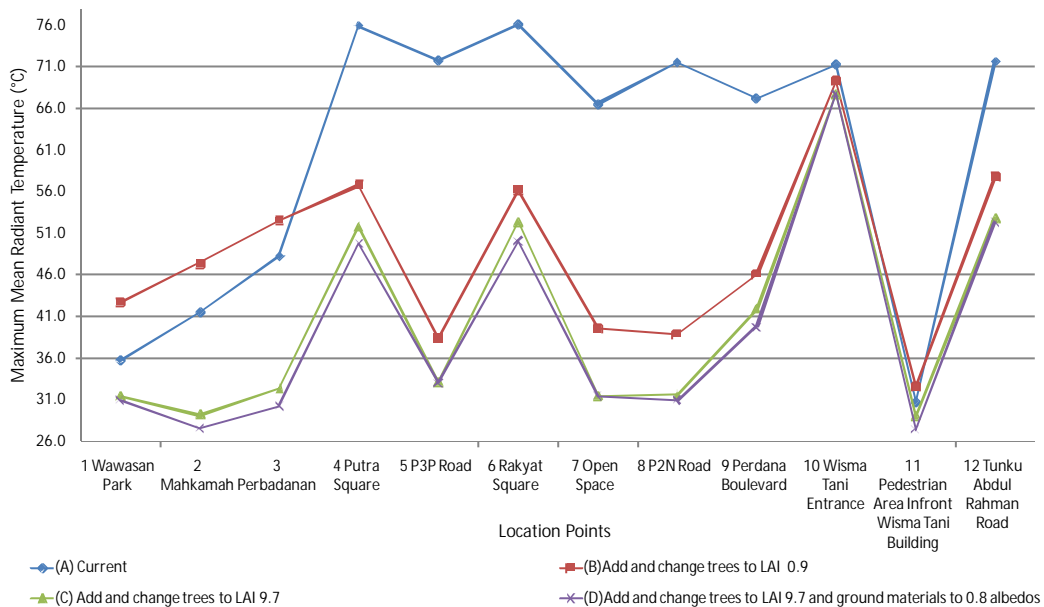

Figure 5.63 Maximum mean radiant temperature for 12 location points from conditions A to D

Conversely, maximum mean radiant temperature show a similar pattern (Figure 5.63). During the peak hours, the effect of the physical properties of trees as differences in each scenario modification can be observed clearly. At this point of time, the effectiveness of tree shading and radiation filtration becomes larger due to the 90° sun angle. Thus, the effect on thermal modification becomes significant.

On average, the maximum mean radiant temperature is found with a magnitude of 60.7°C, 48.2°C, 40.4°C and 39.3°C for conditions (A), (B), (C) and (D) respectively. Thus making differences of 12.5°C, 20.3°C and 21.4°C for conditions (B), (C) and (D) in comparison to condition (A). The effect of high canopy density trees is higher with 60% differences and combination of cool materials making a further reduction of 6%. This is due to the cooling effect and radiant reduction found to be in the optimum level; and lowest radiant heat can be found underneath the tree canopies. Ultimately, the range of maximum mean radiant temperature ranged from 30.8 to 67.8°C making a maximum difference up to 37°C.

5.3.3.6 Wind Speed

As presented in the earlier Chapter 5.3.2.7, the wind speed becomes a disadvantaged variable factor when dealing with high canopy density trees. However, the shortcoming effect of wind can be significant when the lowest reduction can be found within a compact urban environment. In the case of the Persiaran Perdana the less wind reduction effect can be found due to the openness and less compactness of urban planning.

In fact, in some areas such as Wawasan Park the advantages of wind towards high canopy density trees can be seen when the air movement distributes the cooling effect; but is limited to the leeward side or parallel to the park. By having wind reduction the constant cooling effect can be achieved inside the park or green spaces (Dimoudi and Nikolopoulou, 2003). However, the effect of cooling is not greatly influenced as the wind does not have much of an effect on shading, radiation filtration and the evapotranspiration process.

Figure 5.64 shows the wind speed at four different conditions during 15:00 hours. The range of lowest to highest wind speed is indicated with blue to magenta contour profiles, respectively. It can be observed that in condition (A) and (B), moderate wind speed can be found as more yellowish colour can be found at the centres of the Persiaran Perdana. In condition (A) the lessening effect of wind reduction is due to the lack of trees with less obstruction and can be found from the trees rather than from buildings. Condition (B) has a similar condition but less effect of wind reduction due to loose tree canopy density with high porosity of canopies. In contrast, conditions (C) and (D) are found to have a higher reduction in wind speed (e.g. more bluish colour was found in overall area) due to drag force of high density of the tree canopy. However, it is believed that the wind effect does not significantly affect the air temperature as the optimum reduction was found to be in condition (D). However, it should be noted that the reduction of wind speed could influence the human energy budget in the Persiaran Perdana area (Robinette, 1972; Brown and Gillespie, 1995).

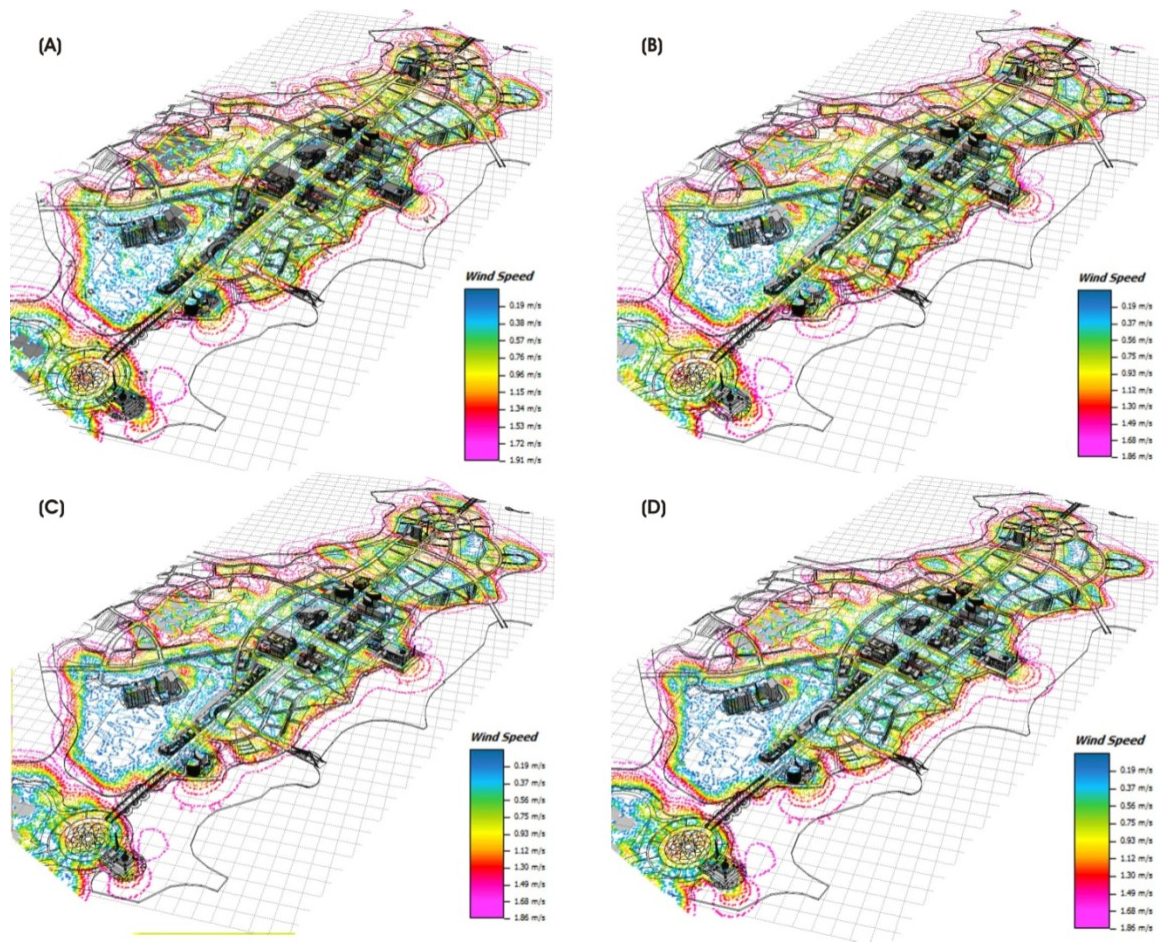

Figure 5.64. Wind speed at four different conditions: current condition (A) and modified environments in conditions (B) to (D) compared at 15:00 at 3 meter height

Figure 5.65 shows the simulated results from 12 location points from each condition. On average, a wind speed reduction with magnitude of 50% can be found for condition (B) and almost 65% for both condition (D) compared with condition (A). The greatest reduction can be found in the Open Hard Surface group (e.g. Putra Square, P3P Road, Rakyat Square, Open Space, P2N Road) where more trees were added into these areas. However, wind speed in some of the areas is constantly lower from condition (A) to (D) due to the obstruction from surrounding buildings such as the Perdana Boulevard and Wisma Tani's pedestrian area. Thus, it can be concluded that high canopy density trees modified in scenarios (C) and (D) offer a lower wind speed; however, the optimum effect of cooling does not have a result as the other important microclimate variables were significantly improved.

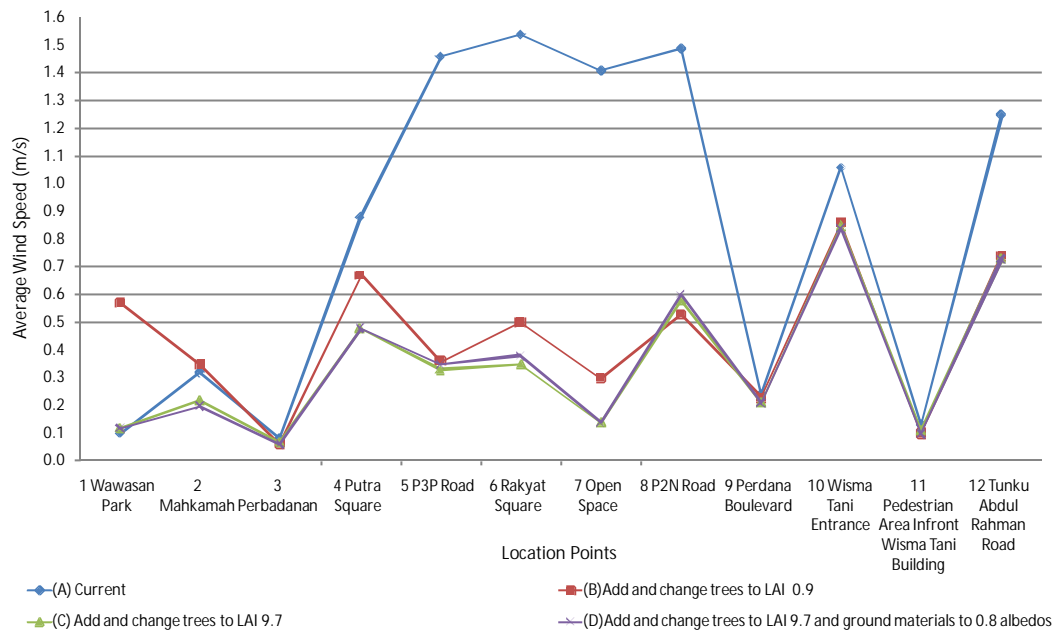

Figure 5.65 Average wind speeds for 12 location points from conditions A to D

5.4. Discussion: The Optimum Cooling Effect from Modification Scenarios

Table 5.21 Summary table on the optimum cooling effect made by modification of vegetation and cool materials

Modified Environmental Variables	Air Temperature (°C)	Relative Humidity (%)	Absolute Humidity (g/m ³)	Ground Surface Temperature (°C)	Radiant Temperature (°C)	Wind Speed (%)
Average	- 2.7	+ 18	+ 2.2	- 13.1	- 16.7	- 65
Max	- 3.5	+ 19.8	+ 4.2	- 30.2	- 37.0	

Note: +/- symbols shows increase or decrease values

As the main concern of the study is to evaluate the optimum cooling effects made by physical properties of trees and ground materials modification, a summary presented in table 5.20 concluded the optimum modification in each microclimate variables. This condition leads to significant improvement of the cooling effect on the street level of the Persiaran Perdana urban area. It is evident from the findings that the significant modification was due to the changes in physical properties from both entities. In fact, most critical areas identified in early stages of the findings show a remarkable reduction and settle due to this modification. The maximum effect of cooling was found during the hottest day at 15:00 hours.

The findings show that tree quantities and densities are one of the paramount factors in providing significant temperature reduction in urban scale. The higher the amount and

densities of trees, the greater the temperature decreases. However, combinations of both modifications are required to achieve the largest cooling effect provided from better radiation interception, high quality of shading effect (i.e. solidness), promotion of the high evapotranspiration process and reducing large amounts of radiant heat (i.e. short and long-wave radiation) underneath the canopy. This implementation leads to the largest reduction of air temperature with average and maximum of 2.7°C and 3.5°C, respectively.

The reduction of air temperature was due to the alteration in relative humidity with average and maximum of 18% and 19.8% influence from the high evapotranspiration process that transpired more water vapour to the air with average maximum increases of absolute humidity with 2.2 and 4.2 g/m³, respectively. In fact, this condition was developed from the highest radiation filtration and shading effect combined with cool materials that reduced the largest ground surface temperature with an average and maximum of 13.1°C and 30.2°C, respectively.

Conversely, choosing or replacing with cool materials is recommended in areas with no tree planting in order to reduce ground surface temperature. Continuously, this process reduces the largest amount of radiant heat (i.e. short and long-wave radiation) with the determination of average and maximum mean radiant temperature reduction of 16.7°C and 37°C respectively.

The study also found out that cluster planting could increase the performance of cooling due to the broad leaf coverage providing a wider shading area. Thus, it has been clear that the more surfaces are covered with vegetation, the greater the effect of cooling. However, it should be noted that this implementation of modification could lead up to a 65% wind speed reduction; but the study proved that the drag force of the canopy does not have much of an effect on the cooling process from trees and cool materials.

This verifies the hypothesis that the optimum improvement of the urban microclimate environment can be achieved with modification of high tree canopy density (LAI 9.7) and cool material (0.8 albedo values) in urban areas. It also confirmed that this dynamic cooling cycle process offers one solution in optimising the cooling effect at the street level in the Persiaran Perdana and mitigates the UHI effect efficiently.

Therefore, this study recommends that trees with similar high canopy density with *Ficus benjamina* species are required in providing high quality shaded coverage; and radiation interception with additional high albedo surface (e.g. polished white granite) with low energy absorption in offering optimum cooling to the urban environment. In other words, one effective solution that could mitigate the UHI effect is by implementing the ideal tree quantities, right selection of tree species and cool materials in urban areas.

5.5 Summary

The Persiaran Perdana area has been identified as having high thermal hot spot areas due to high density of hard surfaces and lack of vegetation. The UHI phenomenon in Persiaran Perdana is found to be moderately collection of hot spot separated with coolers area and these findings correlated with previous study in Nichol (1996a, 1996b) and Wong et al. (2007) where the same pattern of UHI was found. These conditions have been proved quantitatively contributes in high intensity of air temperature when compared to rural areas with an average of 2.6°C. However, the study also proved that in the current condition most areas planting trees have lower air temperatures and provide a cooling effect. However, the amount of vegetation was insufficient to balance the urban environment in the Persiaran Perdana.

Through this ENVI-met model prediction, it has been proved that variation of tree densities provide different performance in tree cooling. The study has proved that the higher the canopy density of trees the greater the effect of cooling. Larger amount of tree quantities play an important role in offering a larger cooling effect, regardless of the lesser effect from the wind speed reduction due to the drag force of the tree canopy.

The cluster planting arrangement was thus recommended in obtaining a better effect. Importantly, the maximum cooling was obtained during the daytime peak hours as all processes of cooling are in maximum intensity. During this time, the radiation interception, shading effect, evapotranspiration rate, ground surface cooling and reduction of radiant heat were obtained due to the sun angle that provided variation in meteorological parameters underneath and outside the canopy areas. Thus, in the tropics, the optimum cooling effect can be achieved during the hottest day; and the reduction of air temperature and increases of humidity can be found effectively during these hours.

Inspired from these findings, it has been proven practically that when a combined modification of the physical properties of trees and ground surface materials is made; it is possible to cool Persiaran Perdana's urban microclimate quite significantly in the peak hours. In addition, this modification offers a remarkable reduction in the air temperature within the most critical areas found in the current condition of the Persiaran Perdana. It is confirmed that the higher combination of cooling process made by this modification offers greater reductions in average air temperature up to 2.7°C. This improvement has filled the gap of urban-rural air temperature intensity found in the earlier condition in the Persiaran Perdana. It has also been proven that with modification to higher tree densities with larger tree quantities (i.e. LAI 9.7) and cool materials (i.e. 0.8 albedo values) this can offer an optimum cooling effect at street level due to high increment of cooling processes. This high increment of cooling process has been proven due the significant improvement of relative humidity, absolute humidity (i.e. evapotranspiration rate), reduction of ground surface temperature and radiant temperature. In other words, the optimum cooling effect can be achieved by having ideal quantities of high canopy density tree planting with additional cool materials that can reduce the urban air temperature effectively.

It is also recommended that in the absence of tree planting, the cool materials should be located at high risk thermal areas in order to reduce the ground surface temperature in open spaces. A combination of pavement and grass surface can offer greater cooling effect due the encouragement of evaporative cooling.

Conversely, the right selection of plant that have a similar canopy density of *Ficus benjamina* need to be classified based on tree physical properties such as density, height, size of leaves and arrangement as these factors will affect the quality of radiation interception, solidity of shading effect and evapotranspiration rate of trees.

Finally, it is suffice to say that the modification of tree and ground surface physical properties offer a remarkable improvement at the street level of the urban environment in the Persiaran Perdana. It can become an additional mitigation strategy that can offer one solution and guidelines in reducing the UHI effect especially in the context of the urban tropical climate. However, the benefits from this modification need to be quantified in thermal comfort and energy savings perspectives and these further findings are presented in Chapter 6 and

CHAPTER 6

OUTDOOR THERMAL COMFORT: FINDINGS AND DISCUSSION

6.1 Results of Subjects' Personal Details and Observations

An observational survey of 229 subjects (62% male and 38% female) was taken during the hottest period of the day (i.e. peak hours) in outdoor spaces in Persiaran Perdana. The results show that subjects were between the ages of 20 and 35 years old, with 55% of them being foreigners and the rest being working people. The results also revealed that many of the subjects (39.7%) used outdoor spaces during the afternoon hours from 12:00 to 17:00 (see Appendix 7). During the survey, observations were made of the subjects' activity (met. rate) and clothing types (clo. values). Seven clothing types and five metabolic rates were estimated in accordance with ISO 7730 (ISO7730, 2005) as demonstrated in the table 4.10 presented in Chapter 4.4.6.2. The findings about subjects' clothing type and metabolic rate are summarised in Table 6.1. The mean clo. value for users of 0.5 indicates that men with office attire are comfortable wearing short sleeve shirts, long trousers and shoes/socks, while women prefer blouses or *baju kurung*, short or long skirts and shoes or sandals. Meanwhile both male and female foreigners prefer wearing casual attire (i.e. t-shirts and jeans, with shoes, sandals or thongs). The mean met. rate for users was 80 W (i.e. refers to standing to walking activity pre-survey). In fact, many of the subjects (38.4 %) were not consuming any food or drinks before the survey commenced. These results were used as a basis later for calculating every subject's Physiological Equivalent Temperature (PET).

Table 6.1 Summary results of mean subject's clo. value and met. rate in Persiaran Perdana

Observation	N	Mean	S.D
Clothing types (clo. values)	229	0.5	±0.1
Activity (met. rate)	229	80.0	±25.0

6.2 Comparison of Green Spaces, Open Spaces and Outdoor Building Spaces in Outdoor Comfort Perceptions and Preferences

Before looking at the effects of modification on Persiaran Perdana’s outdoor thermal comfort, the users’ outdoor thermal perceptions and preferences were analysed in order to understand their behaviour in response to the hottest period of the day, specifically in three major environments in the Persiaran Perdana area. Every subject was asked twelve perception and preference questions, relating to five major microclimate parameters, based on their spontaneous experiences during the survey session, as discussed earlier in section 4.4.5. Findings were divided into three major environments – green spaces, open spaces and outdoor building spaces.

6.2.1 Air Temperature and Mean Radiant Temperature

Table 6.2 Results for thermal sensation perception and preference for peak hours in Persiaran Perdana

Case	Mean thermal sensation perception and preference votes for different spaces			
	Perception	S.D.	Preference	S.D.
Green Spaces (n = 78)	1.2	±1.0	-1.2	±0.8
Open Spaces (n = 77)	2.7	±0.9	-2.1	±0.8
Outdoor Building Spaces (n = 74)	1.2	±1.1	-1.2	±1.0

Following the thermal sensation perception categories in the applied questionnaires, -0.5 to 0.5 means neutral; 0.5 to 1.5 slightly warm; 1.5 to 2.5 warm; above 2.5 hot; -0.5 to -1.5 means slightly cool; -1.5 to -2.5 cool; and below -2.5 cold. Regarding thermal sensation preferences, however, -0.5 to 0.5 means no change; 0.5 to 1.5 warm, 1.5 to 2.5 warmer; above 2.5 much warmer; -0.5 to -1.5 means cool; -1.5 to -2.5 cooler; and below -2.5 much cooler.

Table 6.2 summarises the results in terms of thermal sensation and preference for the three different kinds of spaces during peak hours in Persiaran Perdana (see Appendix 8). The results show that the three different spaces (i.e. green spaces, open spaces and outdoor building spaces) offered significant differences in thermal sensations, one to the other; although the green spaces and outdoor building spaces offered similar thermal sensations, both with mean votes of 1.2 (slightly warm) compared with open spaces that offered “hot” thermal sensations, with a mean vote of 2.7. This is due to subjects in open spaces being 100% exposed to the sun during the peak hours, whereas shade is provided by trees and buildings in green and outdoor building spaces. However, it is worth mentioning here that the

effect of shade from trees is a similar thermal sensation experience to that experienced by subjects in the shade of buildings. Obviously, based on the open spaces condition most subjects prefer to be in cooler areas (-2.1) than in the present condition; however, lower preferences are found in green and outdoor building spaces, with -1.2 preferences (i.e. cool).

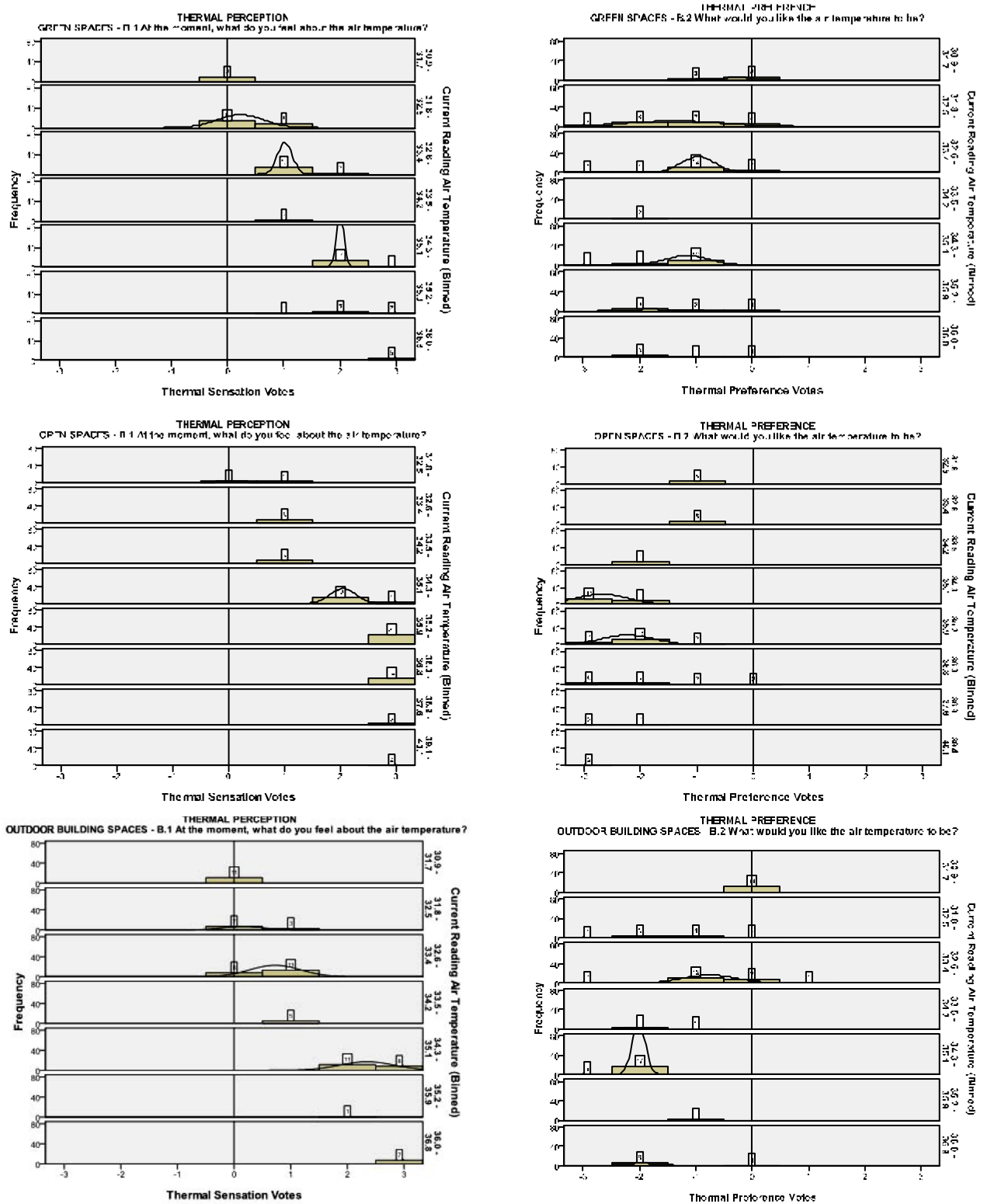

Figure 6.1 Frequency distribution between thermal perception and preference with air temperature readings for three different space conditions

Figures 6.1 and 6.2 show the actual frequency distribution between the mean air and radiant temperature measurements and the thermal sensation and preference votes. The differences in the range of subjects' neutrality in each space are significant. The range of green spaces and outdoor building spaces were found to be 30.9°C to 32.5°C and 30.9°C to 33.4°C respectively with almost 40% of subject in both spaces are in "neutral" condition.

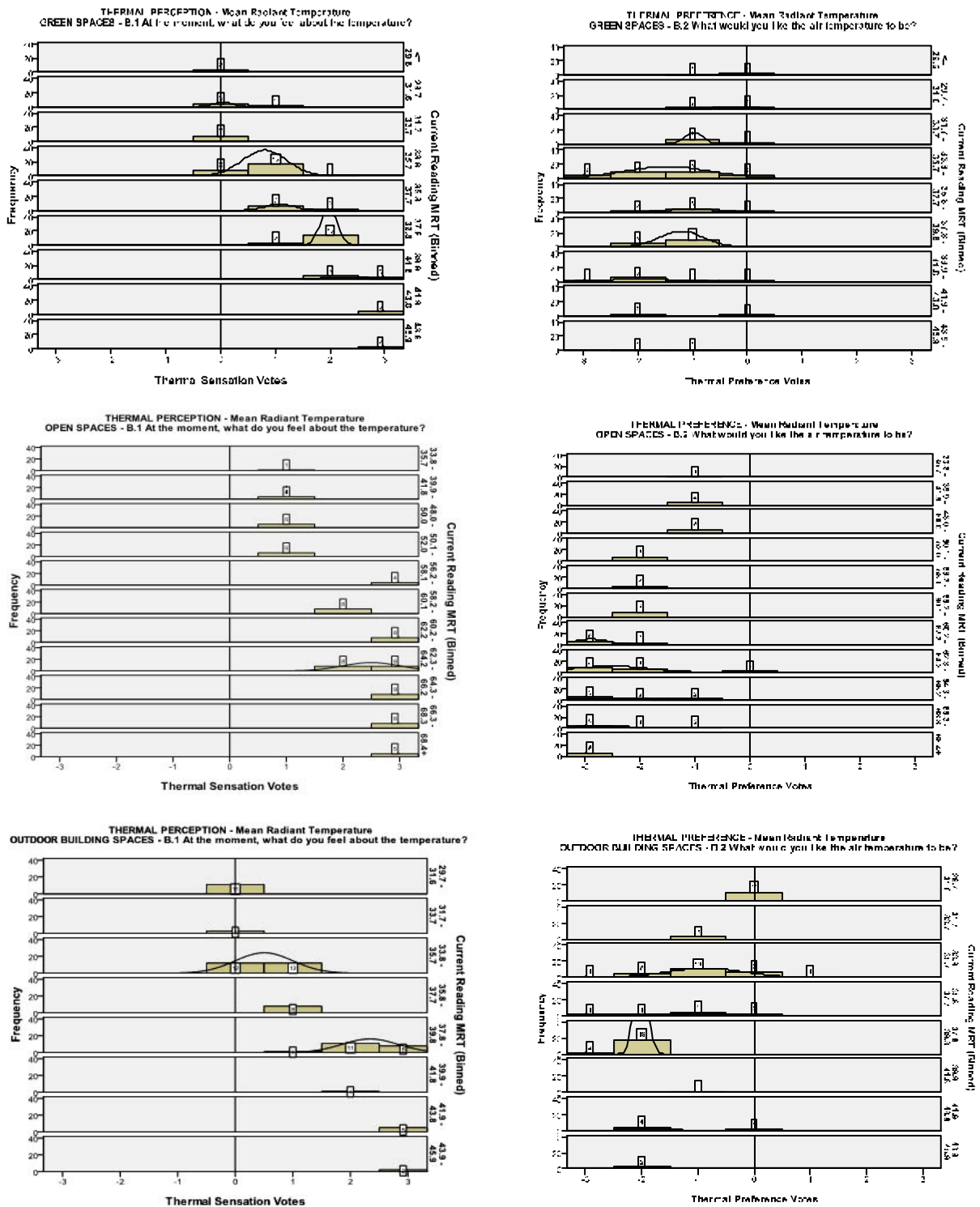

Figure 6.2 Frequency distribution between thermal perceptions and preference readings for three different space conditions

Meanwhile, in the open spaces only 5% (i.e. 31.8°C to 32.5°C) of the subjects were found to be in this condition. Thus, it suffices to say that the users in Persiaran Perdana felt “neutral” when they were under tree canopy and building shade within an air temperature range of 30.9°C to 33.4°C. Nevertheless, the users prefer “cool” conditions although they felt “neutral” in both locations. They prefer “cooler” to “much cooler” conditions starting from 33.5°C onwards. In contrast, most of the users prefer “cool” to “much cooler” condition in open spaces starting from 31.8°C of air temperature due to full exposure to sunlight. Thus, open spaces can be considered as spaces that are not preferable to the users in comparison to green and outdoor building spaces during the daytime peak hours.

Based on the mean radiant temperature evaluation of thermal sensation perception, the range in all spaces was found to be 29.6°C to 68.4°C. However, the open spaces showed the largest range, from 33.8°C to 68.4°C, while both green and outdoor building spaces showed a smaller range of 29.6°C to 43.9°C, making a difference of 34.6°C and 14.3°C respectively. In considering the neutrality of thermal sensation, it can be seen that the users in Persiaran Perdana feel they are in a “neutral” situation under tree canopy and building shade when the mean radiant temperature is less than 35.7°C; however, in open spaces the users feel “warm” in this situation. In fact, open spaces offer a “warm” to “hot” sensation during the hottest period of the day due to full radiation exposure, and none of the users were found to be in a neutral condition.

In respect to users’ preference, more than half of the users prefer “cool” to “cooler” condition when they are in green spaces and outdoor building spaces. In fact, a quarter of the respondents preferred no changes when they are in “neutral” condition. Unlike open spaces, where almost of the users preferred changes in their present condition from “cool” to “much cooler” condition. Thus, it can be seen that the most evident effect of shading is protection from solar radiation, and the results during the hottest part of the day show a remarkable effect, especially from tree canopies, on the comfort of users in Persiaran Perdana.

6.2.2 Relative Humidity

Following the humidity perception categories in the applied questionnaires, results from -0.5 to 0.5 mean neutral; 0.5 to 1.5 slightly damp; 1.5 to 2.5 damp; above 2.5 very damp; -0.5 to -1.5 means slightly dry; -1.5 to -2.5 dry; and below -2.5 too dry. For humidity preference, -0.5 to 0.5 means no changes; 0.5 to 1.5 slightly damp, 1.5 to 2.5 damp; above 2.5 very damp; -0.5 to -1.5 means dry; -1.5 to -2.5 dryer; and below -2.5 much dryer.

Table 6.3 Results for humidity perception and preference for peak hours in Persiaran Perdana

Case	Mean humidity perception and preference votes for different spaces			
	Perception	S.D.	Preference	S.D.
Green Spaces (n = 78)	-0.1	±1.8	1.2	±0.9
Open Spaces (n = 77)	-1.5	±1.2	1.8	±0.8
Outdoor Building Spaces (n = 74)	-0.2	±1.3	1.1	±0.8

Table 6.3 summarises the results for humidity perception and preference in the three different space conditions during peak hours in Persiaran Perdana (see Appendix 9). The results show that the three space conditions (i.e. green spaces, open spaces and outdoor building spaces) offer significant differences to the subjects' humidity perception. However, the green spaces and outdoor building spaces are again very similarly perceived overall, with "neutral" mean votes of -0.1 and -0.2, respectively, compared with open spaces which offer a dry ambient perception with a mean vote of -1.5.

This is believed to be due to the open spaces offering more sensible heat fluxes from the ground and building surfaces, which heat the air more and dry it even faster. Thus, the humidity of the air decreases more quickly than the areas with more latent heat fluxes, such as green spaces. However, in outdoor building spaces with no trees present, the shade from buildings offers neutrality to subjects as the solid shade is a prominent contributing factor to the maintenance of humidity around the buildings. Obviously, based on the open space condition most subjects prefer that the areas are damp (1.8) than the present condition. Although most subjects felt "neutral" in the current condition, lower preferences can be found in green and outdoor building spaces with preferences of 1.2 and 1.1 (i.e. slightly damp), respectively.

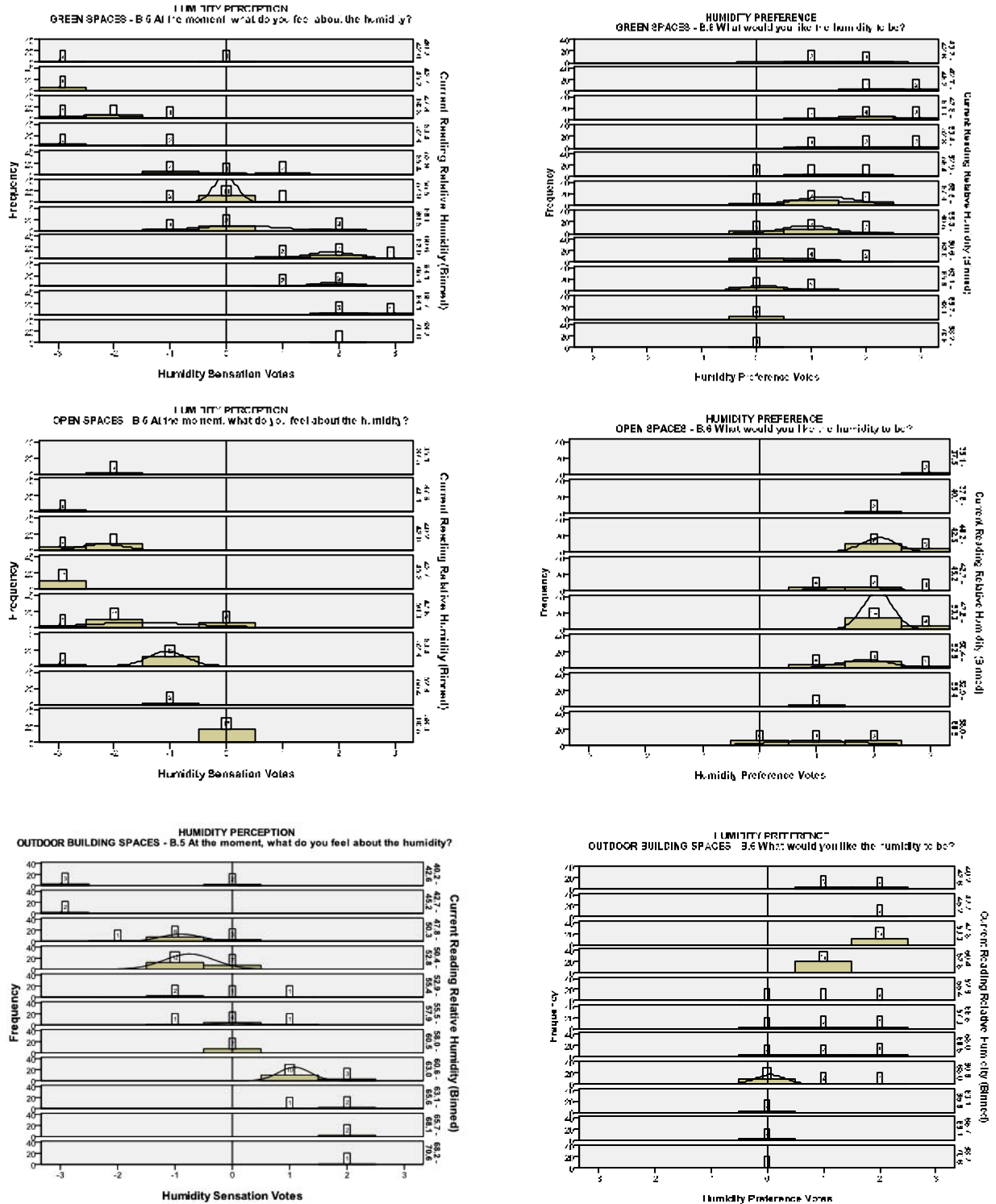

Figure 6.3 Frequency distribution between humidity perception and preference with relative humidity readings for three different space conditions

Figure 6.3 shows the results of the frequency distribution between the relative humidity measurement and the humidity perception and preference vote. The differences in the range of subjects' neutrality are significant. The range of green spaces and outdoor

building spaces were found to be 52.9% to 60.5% and 47.8% to 60.5% respectively, while in the open spaces most of the subjects were found to be in a “neutral” condition within the range of 58.0% to 60.5%. It can be noted that although the air becomes drier in outdoor building spaces, most of the subjects felt comfortable here; this is believed to be due to the solid shade from buildings, which provides more “neutral” thermal sensation, negating the effects of dry air on subjects in this area. In fact, the dry air is believed to be caused by the heat absorption and dispersion from building walls, which dry the air faster. In green spaces, the “neutral” range was smaller than that of outdoor building spaces, at 7.6%, and it is believed that this is due to the radiant heat that still occurs underneath the canopies, as the filtration and shading effects of tree canopies were not 100% solid, in contrast to buildings’ shade. However, it should be noted that green spaces provide the further effect of latent heat fluxes, in contrast to outdoor building spaces. Unlike in the open spaces, the subjects’ “neutral” situation during the peak hours could be achieved when the humidity was at its maximum.

In respect to users’ preference, the users in both green and outdoor building spaces did not prefer of any changes as they are comfortable with higher humidity within the range of 52.8% to 70.6%. Unlike open spaces, most of the users prefer damp conditions due to the lower range of relative humidity from 35.1% to 55.4%. Thus, it suffices to say that higher humidity is preferable to the users, as this condition influences the comfort level of people in tropical climate. In fact, during the peak daytime with higher air temperature, higher humidity is the users’ preference for their outdoor thermal comfort. Therefore, the location that can offer the higher relative humidity such as green and outdoor building spaces are much preferred.

6.2.3 Wind Movement

Wind movement is another factor in the evaluation of outdoor thermal comfort. Following the categories for wind movement perception in the applied questionnaires, -0.5 to 0.5 means moderate; 0.5 to 1.5 slightly strong; 1.5 to 2.5 strong; above 2.5 too strong; -0.5 to -1.5 means little wind; -1.5 to -2.5 stale; and below -2.5 means none. For wind movement preference, -0.5 to 0.5 means same amount; 0.5 to 1.5 slightly more, 1.5 to 2.5 more; above 2.5 much more; -0.5 to -1.5 means slightly less; -1.5 to -2.5 less; and below -2.5 much less.

Table 6.4 Results for wind perception and preference for peak hours in Persiaran Perdana

Case	Mean wind perception and preference votes for different spaces			
	Perception	S.D.	Preference	S.D.
Green Spaces (n = 78)	-0.8	±2.1	1.6	±1.4
Open Spaces (n = 77)	0.3	±2.1	0.7	±1.8
Outdoor Building Spaces (n = 74)	-0.2	±1.8	0.9	±1.5

Table 6.4 summarises the results in terms of wind perception and preference for three different space conditions during the peak hours in Persiaran Perdana (see Appendix 10). The results show that the three different space conditions (green spaces, open spaces and outdoor building spaces) offer significant differences in wind perception. In both open spaces and outdoor building spaces most subjects felt moderate wind movement, while in green spaces little wind was experienced. This is believed to be due to the drag force of the canopies that reduced the wind speed and resulted in the subject experiencing less wind movement than in open spaces and outdoor building spaces (Brown and Gillespie, 1995; Dimoudi and Nikolopoulou, 2003; Yoshida et al, 2006; Fahmy et al, 2010). In fact the height of the tree canopies plays an important role in providing a sufficient amount of wind movement (Shahidan and Jones, 2008). According to the survey, most subjects in open spaces and outdoor building spaces prefer slightly more wind (0.7 and 0.9 respectively), while in green space conditions subjects need more wind movement (1.6) as they experience less underneath the tree canopies.

Figure 6.4 shows the frequency distribution between wind movement measurement and wind perception and preference votes. Regarding the subjects' sensation in each space, the differences in the range are significant. In green spaces, the users was experienced moderate wind movement within the range of 0.9 to 3.1 m/s, in outdoor building spaces it was about 1.7 to 3.1 m/s and in open spaces it was 1.7 to 2.3 m/s. This shows that although subjects in green spaces experienced less wind movement, they still experienced sufficient wind movement when the air speed was as low as 0.9 m/s. However, the majority of the users prefer more wind in green spaces, whilst in outdoor building spaces, they prefer the conditions when the wind speed is less than 2.3 m/s. In contrast, the users in open spaces prefer less wind when the wind movement reached up to 4.0 m/s and above.

On the other hand, it can be clearly seen that in these three main spaces, the moderate wind movement was found to be in the range of 1.7 to 2.3 m/s. Although subjects in open spaces experience sufficient amounts of wind movement in comparison to green spaces, it

does not have much effect on the thermal sensation vote as the air temperature and mean radiant temperature are significantly higher. Thus, it suffices to say that wind movement does not have much effect on the overall outdoor thermal comfort.

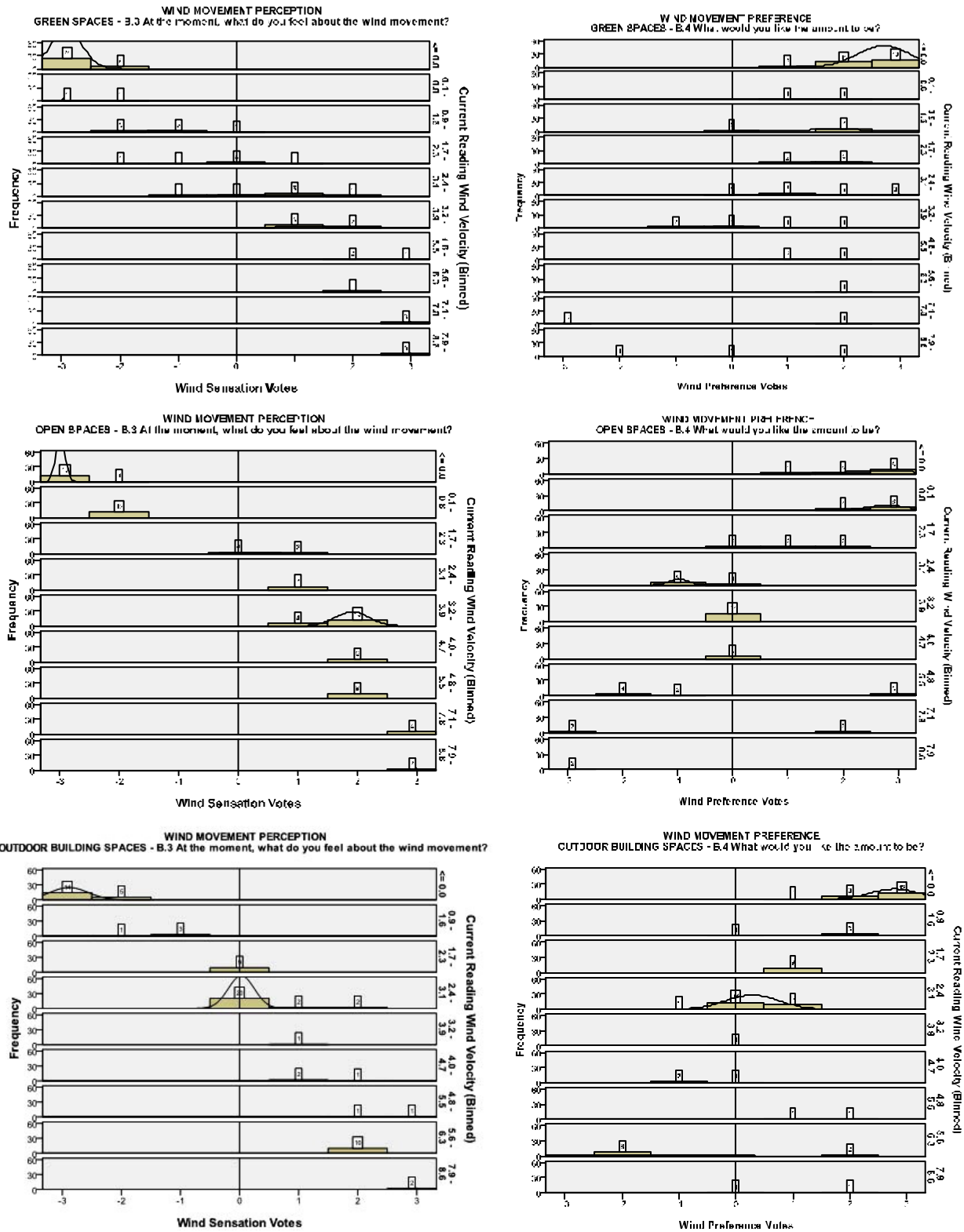

Figure 6.4 Frequency distribution between wind perception and preference with wind velocity readings for three different space conditions

6.2.4 Light Intensity

Although the light intensity is not one of the most important aspects to consider when calculating outdoor thermal comfort, it is worth evaluating the effect of glare as this will impact on the ground surface reflection (i.e. albedo and emissivity) towards Persiaran Perdana users. Following the categories of the applied questionnaires as before, results in the -0.5 to 0.5 range mean neither bright nor dark; 0.5 to 1.5 slightly bright; 1.5 to 2.5 bright; above 2.5 too bright; -0.5 to -1.5 mean slightly dark; -1.5 to -2.5 dark; and below -2.5 too dark. For light intensity preference, -0.5 to 0.5 means no change; 0.5 to 1.5 slightly lighter, 1.5 to 2.5 lighter; above 2.5 much lighter; -0.5 to -1.5 means slightly darker; -1.5 to -2.5 darker; and below -2.5 much darker.

Table 6.5 Results for light intensity perception and preference for peak hours in Persiaran Perdana

Case	Mean light intensity perception and preference votes for different spaces			
	Perception	S.D.	Preference	S.D.
Green Spaces (n = 78)	1.3	±1.3	-1.4	±0.9
Open Spaces (n = 77)	2.2	±0.9	-2.2	±0.8
Outdoor Building Spaces (n = 74)	1.6	±1.3	-1.5	±0.8

Table 6.5 summarises the results in terms of light intensity perception and preference for the three different space conditions during peak hours in Persiaran Perdana (see Appendix 11). The results show that the three different space conditions (green spaces, open space and outdoor building spaces) offer significant differences in glare experience. On average, subjects in green spaces showed lower glare experience (1.3) in comparison to those in open and outdoor building spaces, who experience more glare (2.2 and 1.6 respectively). It is believed that the transmissivity of tree canopies can reduce glare to humans, as leaf cover can absorb excessive visible light from the sun and reflected surfaces (Shahidan et al, 2010).

Although the outdoor building spaces provide full shade, the excessive visible light from exposed spaces and building walls is reflected towards humans as there is no leaf cover or equivalent elements to significantly absorb light. Thus, these exposed conditions offer a greater glare experience to users. As the open spaces do not have any obstruction, similarly bright conditions are experienced but the effect is much higher (2.2). Therefore, it can be noted that by implementing high albedo materials, the users in Persiaran Perdana will experience more glare due to the high reflectivity of the materials. However, this can be balanced by the presence of trees, as these elements reduce the light intensity during the

hottest part of the day in Persiaran Perdana. Obviously, most subjects in the three different spaces prefer darker conditions to their present experience. It can be noted that higher densities of trees can provide the desired conditions.

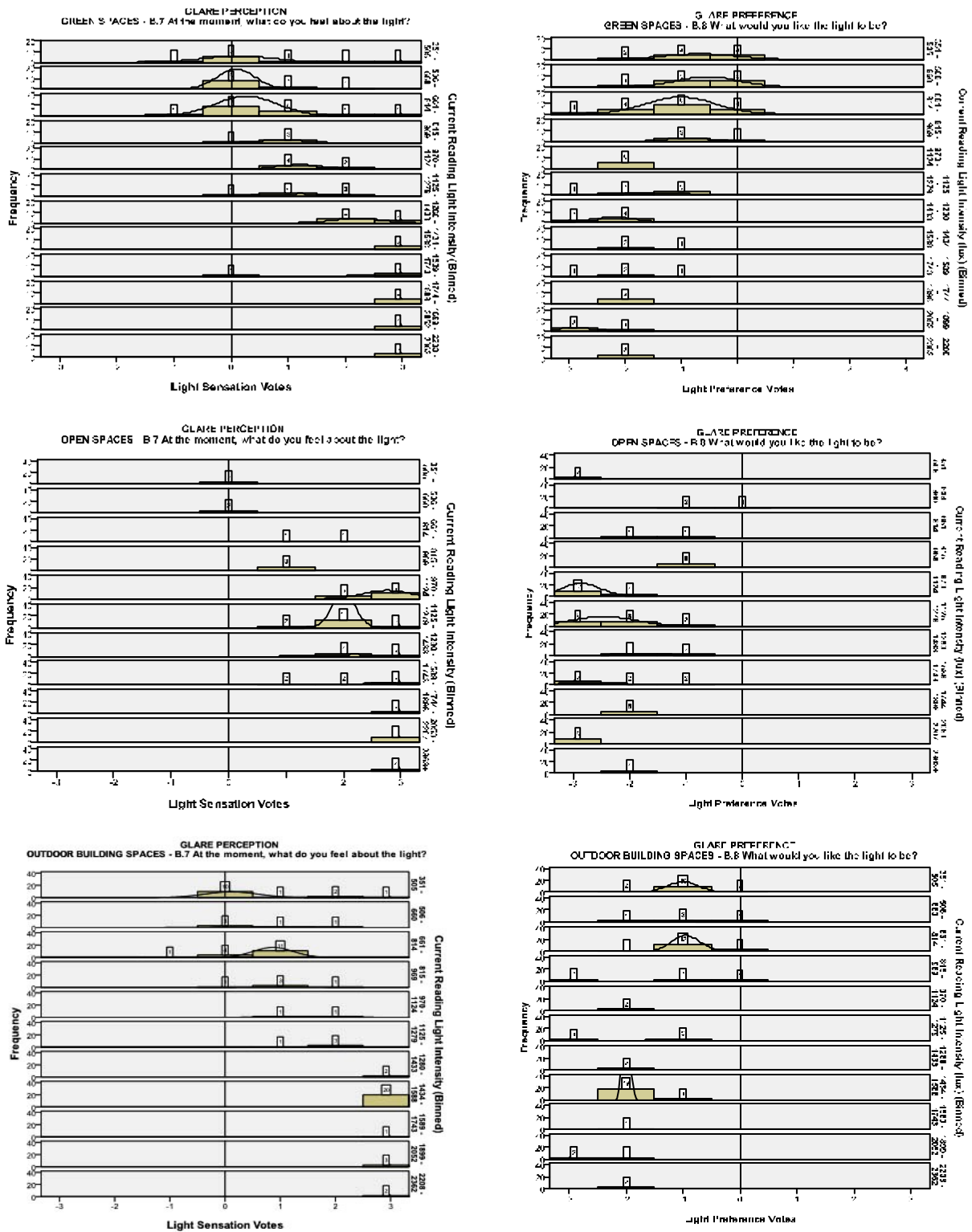

Figure 6.5 Frequency distribution between light intensity perception and preference with light intensity (lux) readings for three different space conditions

Figure 6.5 shows the frequency distribution between the light intensity measurement and the light intensity perception and preference vote. In green and outdoor building spaces, subjects can tolerate a wide range of light intensity, from 351 to 969 lux in both conditions. However, subjects in open spaces can only tolerate a small amount of light, within the range 351 to 660 lux, and most of the subjects experienced higher light intensity due to being in spaces that fully exposed them to the sun. Significantly, the majority of the users in green and outdoor spaces prefer darker conditions, whilst users in open spaces mostly prefer much darker condition. This means that users in all spaces prefer more shading with high quality of shade effect having the potential to offer better ambient conditions and efficient reductions to the glare effect. Overall, the users in Persiaran Perdana can tolerate light intensity less than 969 lux when there is shade present and 660 lux when they are in open spaces.

6.2.5 Green and Shaded Area Perception

When evaluating the amount of green and shaded areas in Persiaran Perdana, it is worth assessing the local perception of the green spaces in this area. Following the categories for the perceived amount of green and shaded space in the applied questionnaires, results in the range -0.5 to 0.5 mean acceptable; 0.5 to 1.5 some; from 1.5 to 2.5 a lot; above 2.5 too much; from -0.5 to -1.5 mean not quite acceptable; from -1.5 to -2.5 only a little; and below -2.5 too little. For green and shaded preference, -0.5 to 0.5 means no change; 0.5 to 1.5 a little more, 1.5 to 2.5 more; above 2.5 much more; -0.5 to -1.5 means slightly less; -1.5 to -2.5 less; and below -2.5 much less.

Table 6.6 Results for light intensity perception and preference for peak hours in Persiaran Perdana

Case	Mean amount of vegetation and shaded area perception and preference votes			
	Perception	S.D.	Preference	S.D.
Vegetation Amount (n = 229)	-1.3	±1.7	2.1	±1.1
Shaded Area (n = 229)	-1.5	±1.3	1.9	±1.1

Table 6.6 summarises the results for perception and preference of the amount of vegetation and shaded areas in Persiaran Perdana (see Appendix 12). Overall, it can be confirmed that the users in Persiaran Perdana experienced less green and shaded areas, with a mean vote of -1.3 and -1.5 respectively. However, they preferred more trees and shaded areas (with a mean vote of 2.1 and 1.9 respectively) to be planted in Persiaran Perdana. In other words, it can be said that more trees need to be added in Persiaran Perdana in order to provide

sufficient amounts of trees and shaded areas, based on the users' perceptions. These results confirmed that the implementation of more trees in Persiaran Perdana is essential, based on local users' comfort experience.

6.2.6 Thermal Comfort Satisfaction

Table 6.7 Results for thermal comfort satisfaction for peak hours in Persiaran Perdana

Case	Thermal comfort satisfaction		
	Mean	S.D.	Condition
Green Spaces (n = 78)	0.08	±1.3	Neutral
Open Spaces (n = 77)	-1.65	±1.2	Uncomfortable
Outdoor Building Spaces (n = 74)	0.64	±1.2	Slightly Comfortable

Table 6.7 summarises the results for thermal comfort satisfaction for the three different space conditions during the peak hours in Persiaran Perdana (see Appendix 13). Following the categories in the applied questionnaires, results of -0.5 to 0.5 mean neutral; 0.5 to 1.5 slightly comfortable; 1.5 to 2.5 comfortable; above 2.5 very comfortable; -0.5 to -1.5 mean a little uncomfortable; -1.5 to -2.5 uncomfortable; and below -2.5 very uncomfortable. Overall, it can be clearly seen that subjects were neutral when they were in green spaces (mean of 0.08) and slightly comfortable when they were located in outdoor building spaces (mean of 0.64). On the other hand, subjects were uncomfortable (mean of 1.65) when they were in open spaces. Thus, it is confirmed that the users in Persiaran Perdana experience their ideal outdoor comfort zone in green and outdoor building spaces rather than in open spaces during the hottest period of the day in Persiaran Perdana.

6.3 Overall Thermal Comfort Satisfaction

Based on the three major areas that represent the outdoor spaces in Persiaran Perdana, the overall outdoor thermal comfort satisfaction can be summarised according to each of the microclimate parameters (i.e. air temperature, relative humidity, wind speed, light intensity and mean radiant temperature) presented in the findings described above. By combining these results and averaging the findings of clo. and met. values, the PET in Persiaran Perdana's human outdoor thermal comfort was determined and summarised; this will be used for further reference in the evaluation of the effects of modification scenarios on users' comfort.

6.3.1 Air Temperature

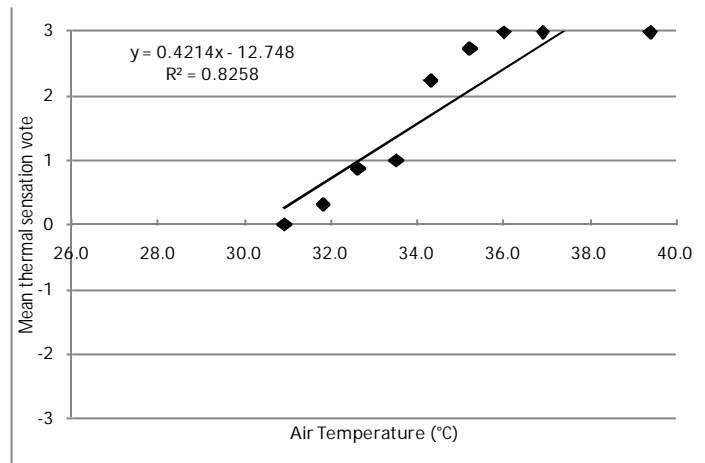

Figure 6.6 Correlation between mean thermal sensation votes (MTSVs) and air temperature at the peak hours in Persiaran Perdana

Figure 6.6 shows the calculated and plotted thermal sensation votes of subjects at each 1°C air temperature (T_a) interval group within the peak hours in Persiaran Perdana. The fitted regression lines for subject sensation versus T_a in the peak hours are as follows:

$$\text{MTSV} = 0.4214 \times T_a - 12.748 \quad (R^2 = 0.83) \quad \text{Eq. 18}$$

The slope of the fitted line indicates the thermal sensitivity of respondents to air temperature variations. The slope value is 0.4124, corresponding to a 2.3°C air temperature per sensation unit. In order to verify the effect of experience on respondents' thermal perception it is useful to consider neutral temperatures during the peak hours. The neutral temperature is the temperature at which people feel thermally "neutral" (neither cool nor warm), and can be assessed using fitted Eqs. 18 with $\text{MTSV} = 0$. The neutral air temperature was found to be 30.3°C. Therefore, it can be said that during the peak hours Persiaran Perdana's users can tolerate this air temperature in outdoor spaces.

6.3.2 Mean Radiant Temperature

Figure 6.7 shows the calculated and plotted thermal sensation votes of subjects in each 4°C mean radiant temperature (T_{mrt}) interval group, within the peak hours in Persiaran Perdana.

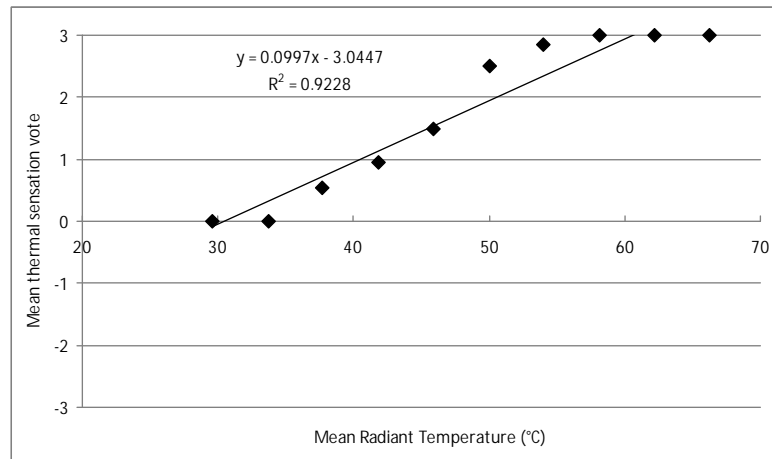

Figure 6.7 Correlation between mean thermal sensation votes (MTSVs) and mean radiant temperature at the peak hours in Persiaran Perdana

The fitted regression lines for subject sensation versus T_{mrt} in the peak hours are as follows:

$$\text{MTSV} = 0.0997 \times T_{mrt} - 3.0447 \quad (R^2 = 0.92) \quad \text{Eq. 19}$$

The slope of the fitted line indicates the thermal sensitivity of respondents to mean radiant temperature variations. The slope value is 0.0997, corresponding to a 10°C mean radiant temperature per sensation unit. In order to verify the effect of experience on respondents' thermal perception, neutral temperatures were considered during the peak hours. As mentioned above, the neutral temperature is the temperature at which people feel thermally neutral (neither cool nor warm), and can be assessed using fitted Eqs. 19 with $\text{MTSV} = 0$. The neutral mean radiant temperature was found to be 30.5°C. Thus, again it can be seen that during the peak hours Persiaran Perdana's users can tolerate this mean radiant temperature in outdoor spaces.

6.3.3 Relative Humidity

Figure 6.8 shows the calculated and plotted humidity sensation votes of subjects in each 2.5% relative humidity (RH) interval group within the peak hours in Persiaran Perdana. The fitted regression lines for subject sensation versus relative RH in the peak hours are as follows:

$$\text{MHSV} = 0.01623 \times \text{RH} - 8.8947 \quad (R^2 = 0.91)$$

Eq. 20

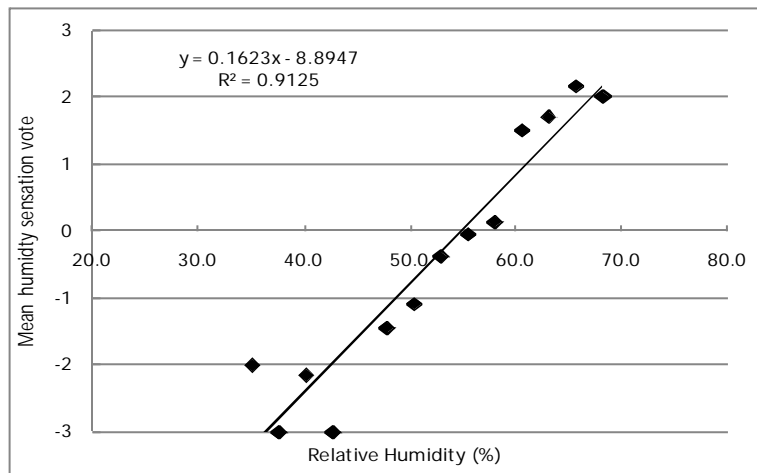

Figure 6.8 Correlation between mean humidity sensation votes (MHSV) and relative humidity at the peak hours in Persiaran Perdana

The slope of the fitted line indicates the air humidity sensitivity of respondents to relative humidity variations. The slope value is 0.1623, corresponding to 6% of relative humidity per sensation unit. In order to verify the effect of experience on respondents' humidity perception, neutral air humidity was considered during the peak hours. The neutral humidity is the moisture of air at which people feel neutral (neither dry nor damp), and can be assessed using fitted Eqs. 20 with MHSV = 0. The neutral relative humidity was found to be 55%. Thus, it can be assumed that during the peak hours Persiaran Perdana's users were satisfied with this level of relative humidity in all outdoor space conditions.

6.3.4 Wind Speed

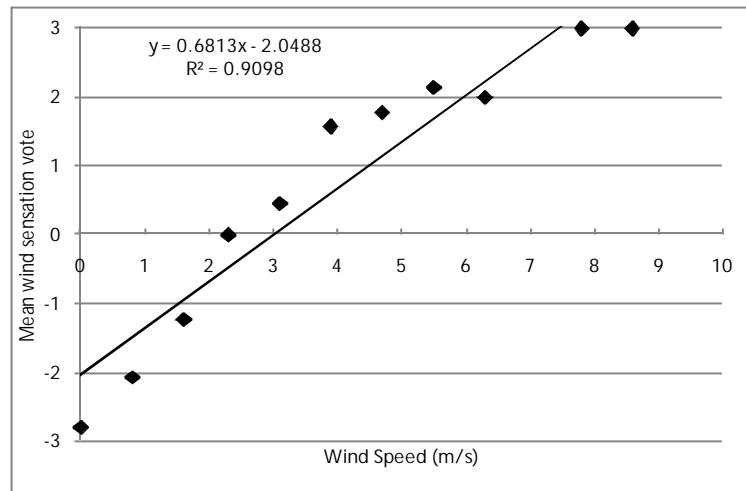

Figure 6.9 Correlation between mean wind sensation votes (MWSVs) and wind speed at the peak hours in Persiaran Perdana

Figure 6.9 shows the calculated and plotted wind sensation votes of subjects in each 0.8 m/s wind speed (v) interval group within the peak hours in Persiaran Perdana. The fitted regression lines for subject sensation versus v in the peak hours are as follows:

$$\text{MWSV} = 0.6813 \times v - 2.0488 \quad (R^2 = 0.91) \quad \text{Eq. 21}$$

The slope of the fitted line indicates the wind movement sensitivity of respondents to wind speed variations. The slope value is 0.6813, corresponding to 1.5 m/s of wind speed per sensation unit. In order to verify the effect of experience on respondents' wind movement perception, moderate wind speed was considered during the peak hours. The moderate wind speed is the wind movement which people feel is acceptable (neither none nor strong), and can be assessed using fitted Eqs. 21 with MWSV = 0. The neutral wind speed was found to be 3.0 m/s. Thus, it can be stated that during the peak hours Persiaran Perdana's users can tolerate this value of wind speed in outdoor spaces.

6.3.5 Physiological Equivalent Temperature (PET)

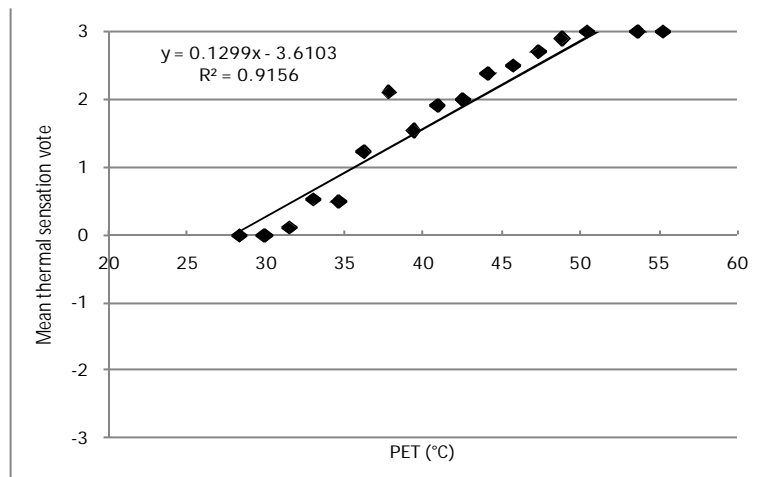

Figure 6.10 Correlation between mean thermal sensation votes (MTSVs) and PET at the peak hours in Persiaran Perdana

Based on the calculation of PET that considers air temperature, mean radiant temperature, relative humidity, wind speed, human clothing and activity of every subject using Rayman’s model (2000), Figure 6.10 shows the calculated and plotted thermal sensation votes of subjects in each 1.6°C PET interval group within the peak hours in Persiaran Perdana. The fitted regression lines for subject sensation versus PET in the peak hours are as follows:

$$\text{MTSV} = 0.1299 \times \text{PET} - 3.6103 \quad (R^2 = 0.92) \quad \text{Eq. 22}$$

The slope of the fitted line indicates the thermal sensitivity of respondents to PET variations. The slope value is 0.1299, corresponding to 7.7°C PET per sensation unit. In order to verify the effect of experience on respondents’ thermal sensation in Persiaran Perdana, neutral temperature was considered during the peak hours. The neutral temperature is the temperature at which people feel neutral (neither cool nor warm), and can be assessed using fitted Eqs. 22 with MTSV = 0. The neutral temperature was found to be 27.8°C. This regression model becomes a reference for the comparison between the current and modification scenarios for outdoor thermal comfort improvement. Following the categories of mean thermal sensation votes, the PET results of -0.5 to 0.5 mean neutral (i.e. a range of 23.9°C to 31.6°C); 0.5 to 1.5 warm (i.e. a range of 31.6°C to 39.3°C); 1.5 to 2.5 hot (i.e. a range of 39.3°C to 47.0°C) and above 2.5 very hot (i.e. above 47.0°C).

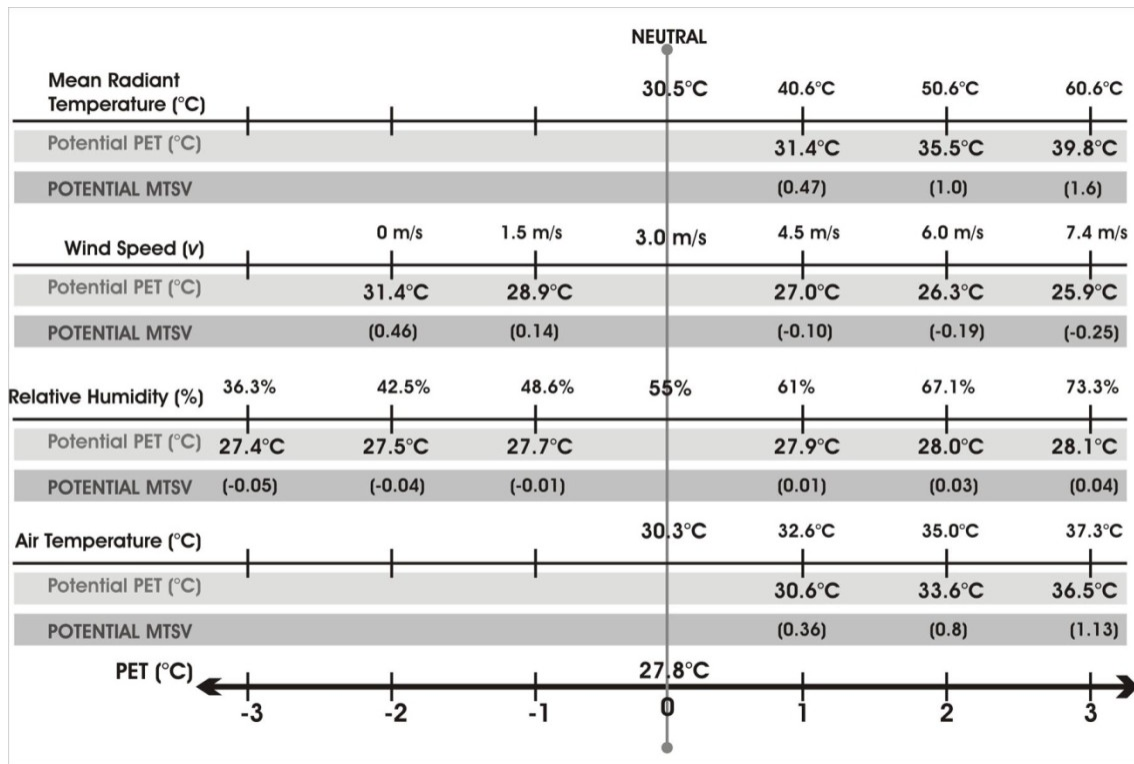

Figure 6.11 Summary of the effect of each microclimate factor on PET in Persiaran Perdana

Therefore, it is shown that with the neutral temperature of PET, 30.3°C air temperature, 55% relative humidity, 3.0 m/s wind speed, 30.5°C radiant temperature with an average of 0.5 clothing values and 80.0 W metabolic rates were considered as the ideal outdoor thermal comfort for Persiaran Perdana's users during the peak hours. Based on these results and referring to each microclimate factor regression model, Figure 6.11 summarises the effect of each microclimate factor on PET in Persiaran Perdana (see Appendix 14). It can clearly be seen that the microclimate parameters most affecting thermal sensation votes were air and mean radiant temperature. Both parameters promote significant changes in thermal sensation votes when the values increase, unlike the wind speed and relative humidity, where changes have less effect on the thermal sensation votes. This correlates with the Nikolopoulou (1998) study where these two paramount parameters (air temperature and mean radiant temperature) have the biggest impact on the outdoor thermal comfort level. As the importance of vegetation and cool materials are likely to modify these two major outdoor comfort microclimate parameters, one can say that the improvement in outdoor comfort caused by modifying both physical properties in Persiaran Perdana was significantly efficient. In other words, when modifying the urban environment to bring benefits to human comfort, these two major parameters must be considered in order to offer optimum outdoor comfort, especially in tropical climates.

6.4 Comparisons of PET Based on Modification Scenarios in Persiaran Perdana

Table 6.8 Comparisons of subjects' PET based on current and modification scenarios in Persiaran Perdana

Location Points	PET(°C) and Comfort Level							
	CONDITION A (Current)		CONDITION B (LAI 0.9)		CONDITION C (LAI 9.7)		CONDITION D (LAI 9.7 & α 0.8)	
	PET (°C)	Comfort Level	PET (°C)	Comfort Level	PET (°C)	Comfort Level	PET (°C)	Comfort Level
1. Wawasan Park	34.4	Warm (0.85)	36.4	Warm (1.12)	31.5	Neutral (0.49)	31.0	Neutral (0.41)
2. Mahkamah	37.0	Warm (1.20)	39.8	Hot (1.60)	30.5	Neutral (0.35)	29.5	Neutral (0.22)
3. Perbadanan	41.8	Hot (1.82)	44.0	Hot (2.11)	32.4	Warm (0.59)	31.1	Neutral (0.43)
4. Putra Square	55.4	Very Hot (3.60)	43.6	Hot (2.05)	42.0	Hot (1.85)	40.7	Hot (1.67)
5. P3P Road	50.8	Very Hot (2.98)	34.7	Warm (0.89)	31.6	Neutral (0.49)	31.5	Neutral (0.48)
6. Rakyat Square	53.3	Very Hot (3.31)	44.2	Hot (2.13)	42.4	Hot (1.87)	40.3	Hot (1.62)
7. Open Space	48.4	Very Hot (2.68)	35.6	Warm (1.01)	33.2	Warm (0.70)	31.4	Neutral (0.46)
8. P2N Road	51.1	Very Hot (3.03)	34.7	Warm (0.89)	31.3	Neutral (0.46)	31.1	Neutral (0.42)
9. Perdana Boulevard	52.6	Very Hot (3.22)	39.5	Hot (1.52)	37.2	Warm (1.22)	36.1	Warm (1.07)
10. Wisma Tani Entrance	50.0	Very Hot (2.88)	49.0	Very Hot (2.75)	47.8	Very Hot (2.59)	47.2	Very Hot (2.52)
11. Wisma Tani's Pedestrian Area	31.7	Neutral (0.5)	32.7	Warm (0.64)	30.4	Neutral (0.33)	28.2	Neutral (0.05)
12 TAR Road	51.6	Very Hot (3.09)	43.9	Hot (2.10)	41.2	Hot (1.74)	40.9	Hot (1.70)

In order to understand the effect of vegetation and ground material modification on human outdoor thermal comfort in Persiaran Perdana, PET values in 12 location points, in current and modification scenarios, were calculated and tabulated in Table 6.8 (refer appendix 15). Obviously, condition A provides a “very hot” experience as most of the location points had more than 2.5 MTSV. In the current situation, Persiaran Perdana’s users were not comfortable in areas without any vegetation, which were exposed to radiation. For instance, the areas that were categorised under the ‘open hard surface areas’ and ‘mixed environment’ groups, namely Putra Square, P3P Road, Rakyat Square, Open Space, P2N Road, Perdana Boulevard and Wisma Tani Entrance, provided a “very hot” and “uncomfortable” experience to the users. On the other hand, although the green spaces offered a variety of tree cover densities, the users still experienced a “warm” to “hot” sensation (0.85 to 1.82). However, the users at Wisma Tani’s Pedestrian Area felt “neutral” due to the combination of vegetation and building shade. This condition creates a “neutral” experience, with 0.5 MTSV values.

Although modifications had been made in condition B (i.e. the changes in tree canopy density to LAI 0.9), most of the areas still had higher MTSVs; this is believed to be due to having a lower density of tree canopy, which do not provide full shade and radiation

interception. Thus, the users still experienced excessive radiation underneath the canopy. For instance, the areas that have been modified with additional trees such as P3P Road, Rakyat Square, Open Space and P2N Road were improved from “very hot” to “hot” and “warm” experiences; however, the improvement was very small due to the tree canopy density issue. In fact, green spaces provide slightly improved on thermal experiences than condition A, which is believed to be due to the differences in tree canopy density values (MTSV 1.12 to 2.11). This issue has also been confirmed by the effect in Wisma Tani’s Pedestrian Area where the users’ thermal experiences deteriorated to a “warm” sensation (from MTSV 0.5 to 0.64) as the tree canopy density in that area was modified to become sparser.

In condition C, with the introduction of high canopy density trees, the users’ thermal sensations were improved to “neutral” conditions in four areas, namely Wawasan Park, Mahkamah, P2N Road, P3P Road and Wisma Tani’s Pedestrian Area. Besides, certain areas initially offering “very hot” and “hot” conditions in conditions A and B respectively (i.e. Perbadanan, Open Space and Perdana Boulevard) were improved to a “warm” condition. Most of the improved areas had additional high canopy density trees added, which offer a more efficient cooling performance due to the high quality of the shade and radiation interception. This condition allows lower radiant heat and reduces the air temperature underneath the canopy, which affects human energy budget. Thus, the outdoor thermal comfort of users in Persiaran Perdana was significantly improved. Unlike the Putra Square area which was designed as an open space; here the improvement of outdoor thermal comfort was small due to the small quantity of trees in that particular area. On the other hand, Wisma Tani Entrance was not significantly improved because of the non-existence of trees near the entrance area. Thus, the improvement of thermal sensation was very small.

Ultimately, it can be seen that users’ thermal comfort was optimally improved by a combination of high canopy density trees (i.e. LAI 9.7) and the implementation of cool materials in condition D. Almost 50% of the area was significantly improved from “very hot” to a “neutral” situation. The areas such as Wawasan Park, Mahkamah, Perbadanan, Open Space, P2N Road, P3P Road and Wisma Tani’s Pedestrian area were among those that offered a more comfortable environment. This was due to optimum shade quality, higher radiation interception and evapotranspiration, and lower ground surface temperature and radiant heat, provided by high canopy density trees and cool materials. This proved to be the optimum method for enhancing the human energy budget in Persiaran Perdana. Moreover,

the overall improvements were confirmed when MTSV values in all areas were improved and brought closer to a “neutral” condition.

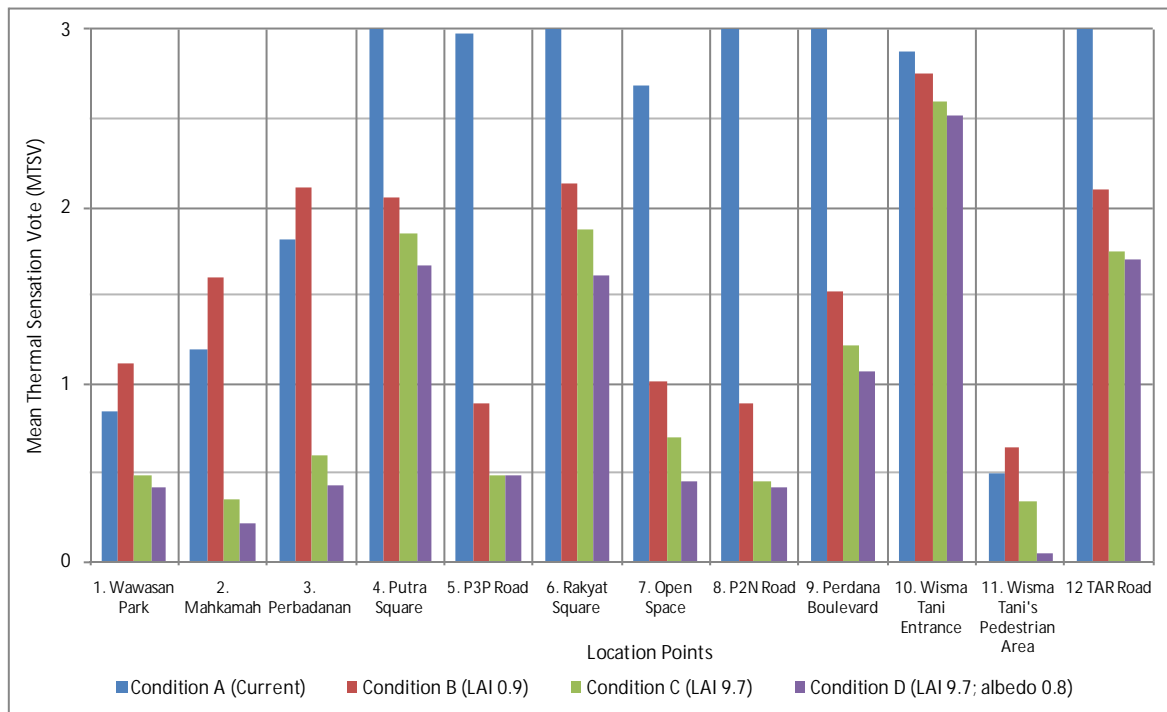

Figure 6.12 Comparison of PET based on the effects of modification on outdoor thermal comfort in Persiaran Perdana

The graph in Figure 6.12 shows the improvement of PET for the 12 location points affected by vegetation and ground surface modification. It can plainly be seen that almost 100% of users’ thermal sensations were improved, comparing conditions A to D. Almost 75% were improved and closer to the “neutral” condition, and the rest were up to a “warm” or “hot” condition. In other words, outdoor thermal comfort in Persiaran Perdana was significantly improved due to the vegetation and ground materials modifications. This therefore verifies the hypothesis and answers the question about the influence of this kind of modification on human outdoor thermal comfort in Persiaran Perdana.

6.5 Discussion

In general, the earlier findings discussed how the users in Persiaran Perdana were exposed to three major outdoor environments. They experienced “neutral” situations in green and outdoor building spaces, in contrast to open spaces, during the hottest part of the day in Persiaran Perdana. In fact, most of the microclimate parameters measured, such as air temperature, radiant temperature and relative humidity were closer to a “neutral” thermal

sensation. In the open spaces, however, the users felt uncomfortable due to solar radiation exposure and heat from the surfaces, which affect their energy budgets. Therefore, it is important to modify the solar radiation by having shade from trees and buildings. These elements provide full shade to the users and intercept radiation in their own way. However, trees provide cooling effects as they reduce the radiation and provide additional cooling processes, whilst buildings only provide full amounts of shade, and the heat reflected by wall surfaces needs to be considered. Nevertheless, it can be noted that tree densities play an important role in defining the amount of the effect on outdoor comfort of the users. In contrast, the findings also showed that the effect of wind movement was reduced by the drag force of tree canopy; however, the effect does not have much impact on the overall thermal sensation votes. Indeed, the shade in green and outdoor building spaces was similar, as this becomes a paramount factor in contributing to a better outdoor comfort environment in urban areas. In the context of the current situation of Persiaran Perdana, only small amounts of vegetation and shaded areas were experienced by the users, who preferred almost twice the amount than that provided by the current situation. Additionally, in green spaces the excessive light was reduced due to absorption by leaf cover, and glare problems were decreased.

In summary of the above findings, the PET results were obtained from each microclimate parameter regression model. The findings show that the “neutral” temperature during the hottest period of the day in Persiaran Perdana was 27.8°C. This finding also demonstrated that the air temperature and mean radiant temperature become an important measure in affecting outdoor thermal comfort levels, and these results correlate with Nikolopoulou’s (1998) findings. Significant changes in air and mean radiant temperature were found as the thermal sensation votes became larger. Conversely, the wind speed and relative humidity do not have much effect on the outdoor thermal comfort as only small differences were found in PET from each thermal sensation voting scale. At this point, improvements in radiation and air temperature were important as these conditions were key to the impact of modifications to the physical properties of trees and ground surface materials.

Finally, based on the PET regression model, the findings on the comparison of the current condition and modification scenarios show significant changes in outdoor thermal comfort in Persiaran Perdana. Most of the areas in actual conditions provide a “very hot”

experience to the users due to the lack of vegetation and shaded areas. The thermal sensation was improved as more trees with sparser canopies were added to the site. However, it can be noted that due to these modifications some of the areas' thermal sensations were worsened. By adding high canopy density trees, almost 50% of the location points were improved from “hot” to “neutral” conditions. Ultimately, the optimal outdoor thermal comfort was achieved when both larger quantities of high canopy density trees and cool materials were added to the site, and almost 75% of areas were improved and brought closer to a “neutral” condition. In other words, the larger the quantity and the denser the trees, with a higher albedo of surface materials, the larger the improvement on outdoor thermal comfort. This answers the question of the influence of modifications on human outdoor thermal comfort, especially during the hottest part of the day in tropical climates.

6.6 Summary

The outdoor thermal comfort results provide two main conclusions. The first, expected and more easily identifiable, is that under shaded conditions (i.e. tree canopies and buildings) the thermal sensations tend more to “neutral” situations than they do under open sky conditions (i.e. open spaces), considering the typical hottest part of the day in tropical climates. It can be noted that the most evident effect of shading was regarding solar radiation modifications, and this will affect the human thermal energy budget. It is confirmed in these findings that green spaces with trees provide a “neutral” situation with similar shade effects to buildings, regardless of the difference in cooling effects from trees and heat reflection from building walls.

The second conclusion from the comparative results confirmed the significant effects that modification to trees and to the physical properties of ground surfaces have on outdoor thermal comfort during the peak hours of the day. Higher tree-densities and cool materials provide the optimum level of thermal sensation as these properties significantly modified the two most paramount microclimate parameters in thermal sensation votes – air temperature and mean radiant temperature. Higher quantities and densities of trees with cool materials provide a higher quality of shade, more radiation interception and evapotranspiration processes, lowering air, surface and radiant temperature effectively. This condition provided a balanced human energy budget, and a comfortable outdoor environment was achieved. Finally, it is useful to note that the modification of vegetation and ground surface material

optimally benefits users' outdoor thermal comfort during the hottest part of the day in Persiaran Perdana, especially in urban tropical climates.

CHAPTER 7

BUILDING ENERGY SAVINGS: FINDINGS AND DISCUSSIONS

7.1 Field Measurement Programme Results

7.1.1 A Comparison of the Influence of Six Different of Outdoor Environmental Conditions on Buildings' Indoor Environments

Based on the field measurement procedures presented in chapter 4.5.2.4, six selected outdoor environmental conditions (refer 4.5.2.2 Table 4.11 and 4.12) were measured to assess the effect of trees on building's indoor environments. In order to determine the actual direct effect of trees on indoor air temperature conditions, these results primarily focus on the comparison of outdoor and indoor air temperature and wall and ground surface temperature without the influence of air-conditioning. The variations were evaluated based on the various measurements of exposed conditions towards absolute measurement (control).

7.1.1.1 Comparison of Outdoor and Indoor Air Temperature

Table 7.1 The differences in the average and peak outdoor and indoor air temperature for six selected environmental conditions

BUILDINGS	Air Temperature (°C)			
	OUTDOOR		INDOOR	
	Average, DTa	Max, DTa	Average, DTa	Max, DTa
1 Industrial Design Building, Studio 3	1.0	3.2	0.9	2.6
2 MPIL Building	0.7	2.8	0.3	1.0
3 Swimming Complex	0.7	2.8	0.4	0.8
4 Student Centre I (2m Single/9m Cluster)	-1.1/-0.9	-1.2/-0.8	-0.9/-0.6	-1.1/-0.5
5 Student Centre II (2m Single)	-0.7	-0.9	-0.4	-0.5
6 Academic Building	0.3	2.1	0.1	0.6

Note: +/- symbols show increase or decrease values

Table 7.1 and Figure 7.1 show that the results for the actual average and peak air temperature differences for outdoors and indoors, in the case of the six selected environmental conditions; revealing those locations with trees experiencing a reduced air temperature. Student Centre 1 and Student Centre II show a remarkable outdoor air temperature reduction due to the presence of trees, of an average of up to 1.1 and 0.7, respectively. During peak hours, the maximum outdoor air temperature reduction becomes higher and the differences were found to be 1.2°C to 0.9°C, respectively. Significant

differences are believed to be due to the shading from the tree canopies reducing the outside air temperature and intercepting solar radiation before it can penetrate the walls and ground surfaces. In fact, it can be noted that the reduction of air temperature was influenced by the tree canopy density and its distance from the building's walls. For instance; the highest average and maximum outdoor air temperature reduction occurs in the Student Centre I Building where there is 100% grass, and 2m single trees with LAI values of 5.49, compared to Student Centre II which has lower LAI values of 3.89. These results lead to an average of 0.9°C and 0.4°C and a maximum of 1.1°C and 0.5°C, in terms of indoor air temperature reduction in Student Centre I and II Buildings, respectively.

Conversely, the indirect effect of a 9m cluster of trees in Student Centre I Building can be seen clearly with an average and maximum outdoor air temperature reduction of 0.9°C and 0.8°C, respectively. This is believed to result from the indirect tree cooling effect that reduces outdoor air temperature significantly. These results lead to an average and maximum indoor air temperature reduction of 0.6°C and 0.5°C, respectively. Thus, the average and maximum of the outdoor and indoor air temperature resulting from the indirect effect of trees at the Student Centre I Building provides almost two quarters of the reduction in terms of comparing with the direct effect of trees. This reveals the significance of indirect effects from tree cooling on the indoor building environment. Furthermore, both the direct and indirect effect of trees significantly influences the indoor environment. The findings also revealed that the reduction of outdoor air temperature because of the presence of trees significantly influences the improvement in indoor air temperature.

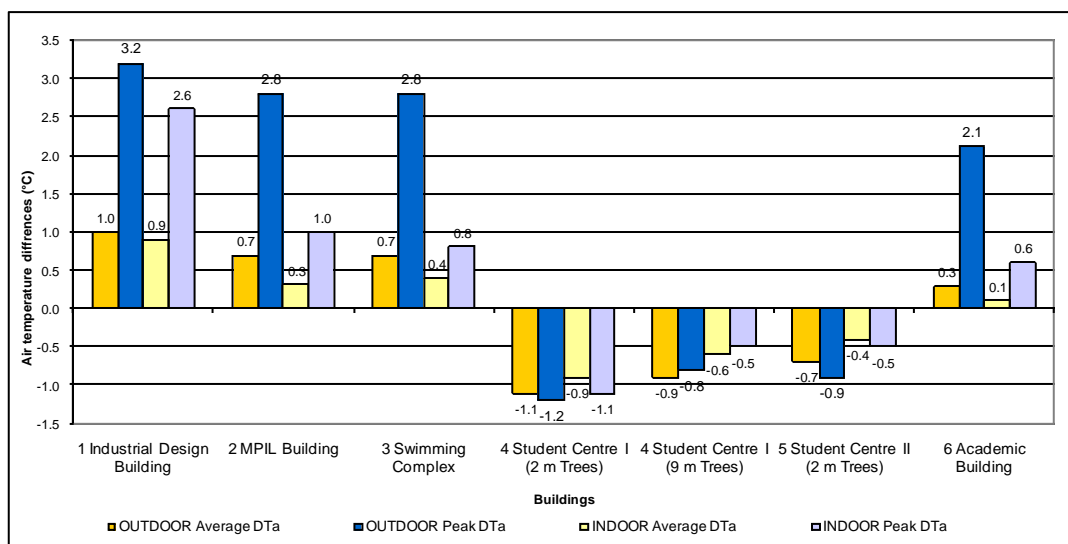

Figure 7.1 Summary of the differences in average and peak outdoor and indoor air temperatures for six selected environmental conditions

In contrast, the environmental condition with a 100% hard landscape show the highest increase in outdoor average and maximum air temperature. The Studio 3, Industrial Design Building shows the highest average and a maximum outdoor air temperature increase of 1.0°C and 3.2°C, respectively. This is due to full exposure to solar radiation, which directly influences the air temperature. The higher radiation increases the temperature of ground surfaces, made of asphalt and concrete, and this releases sensible heat fluxes that heat the air significantly. In addition, it is believed that the heat absorbed by the pavement and asphalt was stored and released at the end of the day. This makes the average air temperature in these conditions the highest when compared with other conditions. The influence of this condition on the indoor environment can be seen clearly from the highest average and maximum indoor air temperature differences of 0.9°C and 2.6°C, respectively.

In other areas, such as MPIL, Swimming Complex and Academic buildings, outdoor air temperatures were found to occur in moderate increments with an average of 0.7°C, 0.7°C and 0.3°C; and maximum of 2.8°C, 2.8°C and 2.1°C, respectively. This is due to the fact that these areas have a combination of elements of hard and soft landscapes that reduce the effect of hard surface elements such as asphalt. However, the effects are very small compared to the conditions where there are trees present. Regardless of the effects of grass and small trees, the MPIL buildings and Swimming Complex show a similar increment due to the dominant elements of asphalt in both. These environmental conditions have fewer cooling elements, especially shade and radiation interception, from trees which would improve the air temperature significantly. In fact, the dominant elements, such as asphalt, worsen the impact on the indoor environment. It can be seen that the indoor air temperature is higher in both conditions (i.e. MPIL buildings and Swimming Complex), within a range of 0.8°C to 1.0°C. However, in the Academic building the effect of hard surfaces is less, due to the ground surfaces being fully covered with grass. Although the outdoor condition was exposure to direct solar radiation, the effect of grass created a lower average and maximum outdoor air temperature of 0.3°C and 2.1°C respectively, compared to the MPIL building and Swimming Complex. This condition offers a slightly lower increment on the average and maximum indoor air temperature, with 0.1°C and 0.6°C, respectively. This condition illustrates the impact of different ground materials on outdoor and indoor air temperature.

Taking into consideration the overall conditions, it can be asserted that the outdoor landscape conditions significantly influence the indoor air temperature conditions; the higher

the reduction in outdoor air temperature, the more significant the improvement in the indoor air temperature. Obviously, the crucial factor in improving indoor air temperature is the shade and the cooling effect of trees. This effect is enhanced when the ground surface is covered with grass, because this causes evaporative cooling, particularly when the trees are closer to an east or west wall, because the shade from the wall also reduces indoor air temperature effectively.

7.1.2.1 Comparison of Outdoor and Indoor Wall Surface Temperatures

Table 7.2 The differences in the average and maximum outdoor wall and ground surface temperature and indoor wall surface temperature for six selected environmental conditions

BUILDINGS	Wall (W) / Ground (G) Surface Temperature (°C)		Wall (W) Surface Temperature (°C)	
	OUTDOOR		INDOOR	
	Average, DW/GTs	Max, DW/GTs	Average, DWTs ^a	Max, DWTs
1 Industrial Design Building	2.6/ 10.8	4.4/ 20.8	1.6	2.8
2 MPIL Building	2.4/ 8.5	1.4/ 13.0	0.8	1.0
3 Swimming Complex	1.9/ 9.0	3.4/ 18.4	0.6	0.6
4 Student Centre I (2m Single)	-1.0/ -3.9	-2.0/ -8.0	-0.3	-1.6
5 Student Centre II (2m Single)	-0.7/ -2.7	-1.8/ -5.2	-0.1	-0.4
6 Academic Building	2.1/ 0.9	3.2/ 1.4	0.8	0.6

Note: +/- symbols show increase or decrease values

In Table 7.2 and Figure 7.2, the differences in the average and maximum outdoor and indoor wall and ground surface temperatures are demonstrated. Based on these findings the effect of tree shading on the wall and ground surfaces were analysed in order to understand the impact on the indoor environment. It is apparent that the effects of shading occurred in two landscape conditions with trees near the wall surfaces. In fact, the effect of shading reduced the ground surface temperature significantly. Both Student Centre I and II received the highest tree shading effect with reduced average outdoor wall surface temperatures of 1.0°C and 0.7°C, respectively. The effect of shading also reduced the average outdoor ground surface temperature below the tree canopy by 3.9°C and 2.7°C, respectively. Moreover, the effect of shading increased during peak hours, where the average and maximum reduction were recorded in both outdoor conditions with the wall surface temperature up to 2.0°C with 1.8°C, and ground surface temperature with 8.0°C and 5.2°C, respectively. However, it should be noted that the variation in wall and ground surface temperature reduction could be explained by the different tree densities in each of the outdoor environment conditions. Significantly, the reduction in outdoor wall and ground surface temperatures reduced the

indoor surface temperature average and maximum of 0.3°C and 1.6°C; and 0.1°C and 0.4°C in both Student Centre I and II, respectively. In other words, the reduction of indoor wall surface temperature is believed to be one of the main factors contributing to the lowest reduction of air temperature for both outdoor landscape conditions.

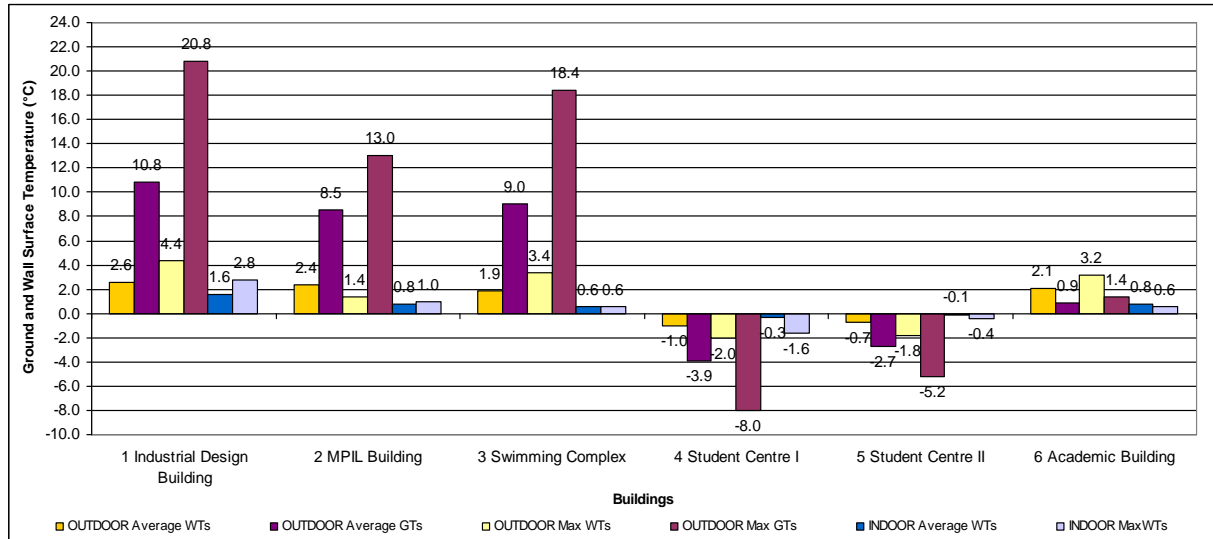

Figure 7.2 Summary of the differences of average and maximum outdoor wall and ground surface temperature and indoor wall surface temperature for six selected environmental conditions

In comparison to the other buildings, the increases in the outdoor wall and ground surface temperatures of Studio 3, Industrial Design Building, were highest due to high exposure of solar radiation during the day time. This condition increased the outdoor average and maximum surface temperature significantly, with 2.6°C and 4.4°C for the wall, and 10.8°C and 20.8°C for the ground surfaces, respectively. Correspondingly, this condition caused increases in the average and maximum temperature, 1.6°C and 2.8°C indoor wall surface temperature. The energy absorbed by the outer wall surface advances to the inner wall layers and reaches the inner wall surface, which in turn results in an increase in temperature (Papadakis, 2001).

This modification of temperature is also related to the higher air temperature changes in the indoor environment. The Swimming Complex, with 90% asphalt and 10% grass, shows slightly lower temperatures than the Industrial Design building, due to the effects of the 9m cluster of trees. However, the effect of indirect cooling is not sufficient to reduce the effect of thermal heat on wall and ground surfaces. On the other hand, the MPIL building shows lower increases than the Swimming Complex and it is believed that this is due to the presence of small trees with very loose canopy density (LAI 0.8) which provide shading to the wall and

ground surfaces. Nevertheless, the effect is not sufficient to improve the indoor wall surface temperature. In the Academic building, with grass-covered landscape conditions, the effect of a reduction in ground surface temperature can be seen, with average and maximum ground surface temperatures of 0.9°C and 1.4°C, respectively. However, the outer wall's exposure to solar radiation increased the indoor wall surface temperature by an average of 0.8°C.

Thus, it can be noted that shading from trees is a crucial factor in reducing the east- or west-facing wall surface and ground temperature. The effect of shading reduces the effect on outdoor ground and outer wall surface temperature, which in turn will result in the reduction of indoor air temperature.

7.1.2 Discussion: Outdoor versus Indoor Environment

As presented in earlier findings, we have clearly observed the effects of tree shading and the cooling effect of trees on indoor air temperature. Significantly, the effect of trees will influence the building's cooling load during the hottest day, as it is significantly higher during this period of time. The direct effect of trees can be seen when a higher canopy density of tree is located within 2m of the east- or west-facing wall. Under these conditions, the outdoor temperature, wall and ground surface temperature become lower and improve the air temperature in the indoor environment. This improvement is due to the effect of shading and radiation interception from trees that provide shelter to the outer wall surface, reduce the amount of energy absorption into the inner wall layers, and lessen the temperature effect on the inner layer. It is believed that this condition could lead to energy savings, thanks to the effect of the trees. Moreover, it should be noted that grass ground cover also enhances the cooling effect of trees, due to its evaporative cooling.

As well as providing shading for the wall surfaces, the cooling from a cluster of trees reduces the immediate outdoor air temperature and influences the indoor air temperature. This correlates with the study by Akbari (1992) where he found that the indirect effect of tree evapotranspiration is the key factor that resulted in lower outdoor air temperature, coupled with the direct effect of shading. However, the effect is lesser than the effect of trees that are much closer to the building wall. In this case, the direct effect of shading and indirect cooling effect of high canopy density trees 2m closer to the building walls (i.e. Student Centre I) improved the maximum indoor air temperature by up to 4.4°C, compared with the open hard

surface area (i.e. Industrial Design building). In addition, the indirect effect of evapotranspiration from a cluster of trees within 9 m of the building wall reduced maximum indoor air temperature by up to 2.1°C. Thus, it can be concluded that the outdoor landscape environment plays an important role in improving the indoor air temperature, and it is possible that the modification of the outdoor environment can improve the building's energy saving, especially in a tropical climate.

7.2 Computer Simulation Programme Results

7.2.1 Validation of HTB2 Simulation Results in Two Selected Outdoor Environments

In order to evaluate the influence of the outdoor environment on building cooling load, HTB2 software was used in this study (refer Chapter 4.5.3.1). In validating the accuracy of the model, an experiment was conducted based on the results of the field measurements. The outdoor environments were chosen as (i) Industrial Design Building and (ii) Student Centre I to represent open hard landscape, as well as single trees and clusters of trees. Both outdoor meteorological parameters were used as input into the HTB2 model. In order to achieve better accuracy, tree shading mask evaluations, building ventilation rates, and comparisons between measured and computed indoor air temperature without air-conditioned influences (i.e. natural ventilation), were obtained and are presented below.

7.2.2 Tree Shading Mask Result

As presented in chapter 4.5.3.2, the HTB2 model accepts descriptions of shading devices as a numerical map or 'shading mask' illustrating the amount of energy able to reach the surface. So as to determine the effect of shading from a tree canopy, as compared to a default shading mask on external walls, the transmissivity (Alexander, 1996) of tree canopies was determined from field measurements to show an average of 6.5%. This means that the ratio of estimated shaded radiation to unshaded radiation was almost 9:1, compared with the external wall shading mask. Therefore, the tree shading mask value was developed according to this value and the mask data was compared with results from ECOTECH tree and wall shading simulation comparison. The results for both shading mask values were tabulated and presented in Appendix 16. In addition, the shading mask values based on tree distances of 2m to 10m were developed in order to evaluate the effect of tree distance from the building wall.

Based on the development of this shading mask, the experiment on the effect of shading from external wall and tree canopy was analysed, and the effects on indoor air temperature were presented in Figure 7.3. Based on the findings, the effects of wall and tree shading were shown to be significantly different. The variation in indoor air temperature is believed to be due to the effect of the transmissivity of the tree canopy, which is more transparent when compared with a solid wall.

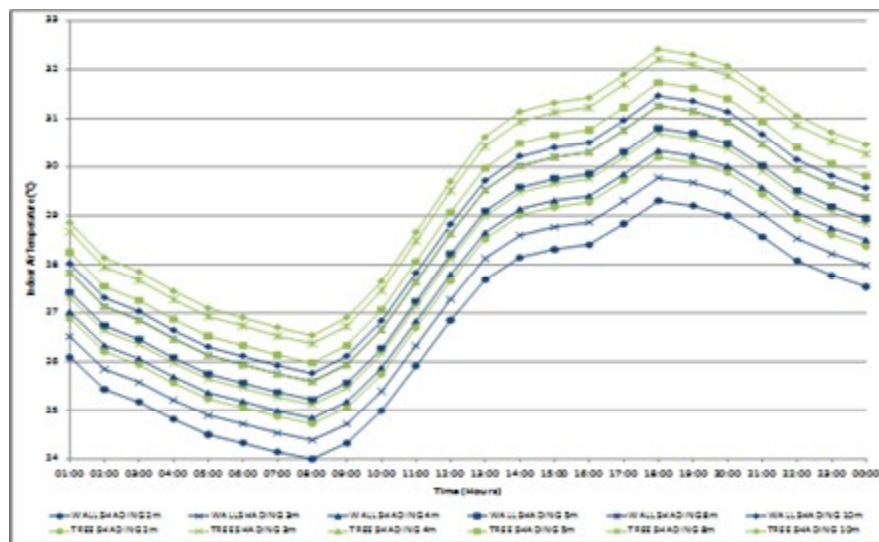

Figure 7.3 Results on the indoor air temperature affected by external wall and tree canopy shading

Based on the average and maximum indoor air temperature, it can be observed that the variation in transmissivity of trees (i.e. 6.5%), in comparison to solid walls (i.e. 0%), contributes to an increase of approximately 3% of indoor air temperature. This effect is believed to be due to the ratio of shaded and unshaded radiation that allows 6.5% of radiation penetration onto the outer building wall surfaces. This condition allows the excessive energy absorbed by the outer wall surfaces to advance to the inner wall layers and reach the inner wall surface, which in turn results in an increase in indoor air temperature by 3%.

Table 7.3 and Figure 7.4 illustrate the results of average and maximum indoor air temperature, as affected by the external wall and tree canopy. The findings from both table and figures show the effects of external wall and tree canopy distances on indoor air temperature reduction. This demonstrates that the further the distance of external wall and tree canopy, the higher the increases of average and maximum indoor air temperature; thus, clearly illustrating the effect of the direct and indirect effects of a tree canopy on the building's wall. Compared with a 2m distance from tree to wall, distances of 3m, 4m, 5m, 8m and 10m offer significant increases in indoor air temperature, as the tree is further away from

the building's wall, with 1.6%, 3.5%, 5.0%, 6.6% and 7.3% increased in indoor air temperature, respectively.

Thus, these findings confirmed the development of the shading mask and clearly demonstrated the shading effect of a tree canopy on the building's wall. Therefore, tree shading mask values from this development can be considered useful in representing the actual tree shading effect, and could therefore be used for further investigation.

Table 7.3 Comparison of external wall and tree canopy effect on indoor air temperature at distance variation

Indoor Air Temperature	Shading Mask	2m	3m	4m	5m	8m	10m
Average	External Wall	26.73	27.16	27.66	28.08	28.51	28.69
	Tree Canopy	27.53	27.97	28.49	28.92	29.36	29.55
Maximum	External Wall	28.41	28.86	29.41	29.85	30.30	30.49
	Tree Canopy	29.26	29.73	30.13	30.75	31.21	31.41

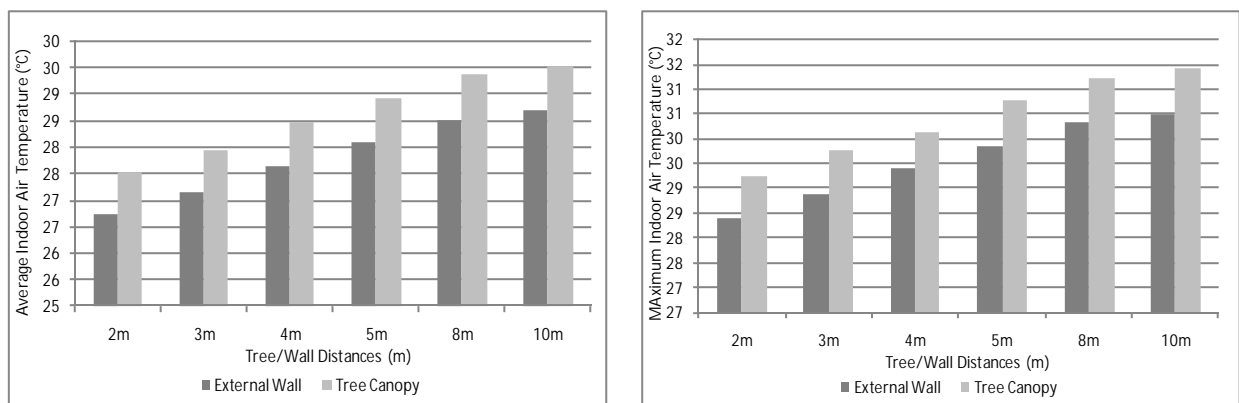

Figure 7.4 Comparison of external wall and tree canopy on average (left) and maximum (right) indoor air temperature at distance variation

7.2.3 Building Ventilation Rate Result

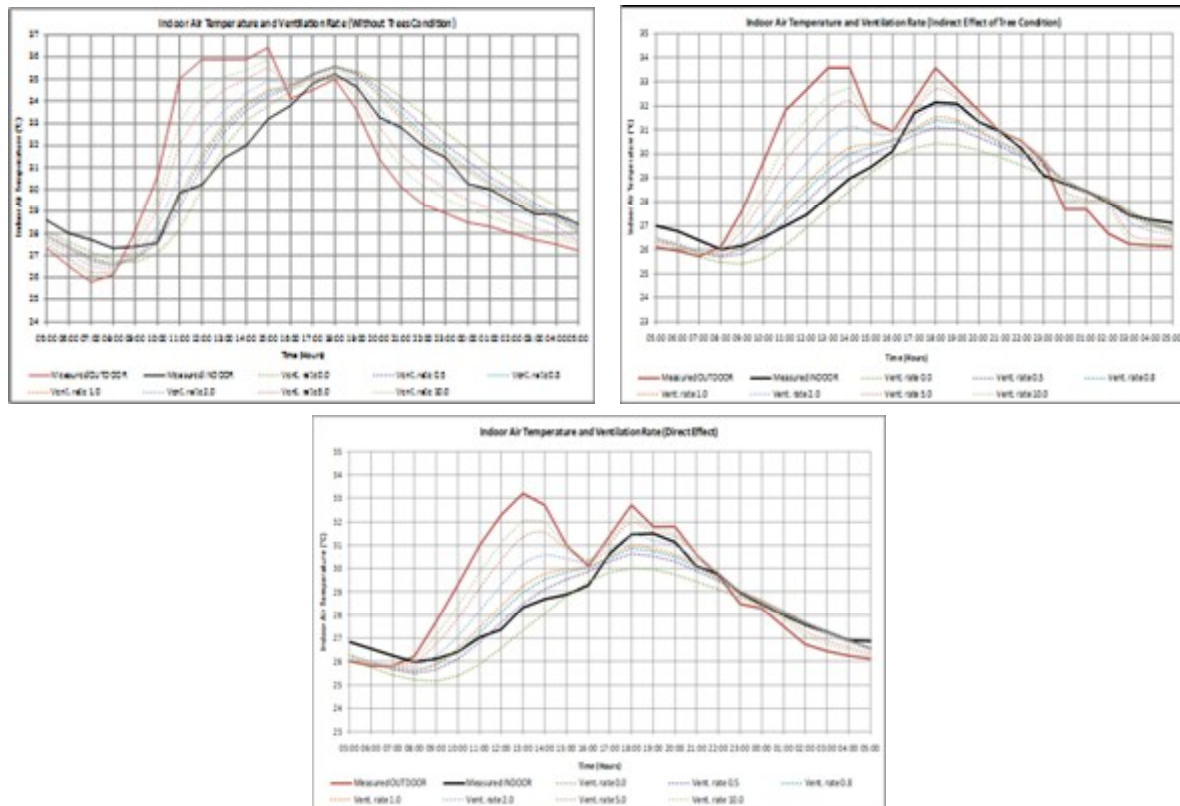

Figure 7.5 Ventilation rate results based on the comparison of measured and computed indoor air temperature in three outdoor environmental conditions (i.e. hard surface – without trees, indirect effect of tree – without tree shading, direct effect of tree – with tree shading)

In order to determine the actual ventilation rate that can be implied for one building in further validation of the HTB2 simulation, three experiments based on three different outdoor environments were conducted. The results were presented in Figure 7.5. In determining the actual ventilation rate, the results from measured and computed indoor air temperature were compared and correlated. A wide range of ventilation rates from 0.0 to 10 ach were simulated, and the correlation coefficient results from each outdoor condition are tabulated in Table 7.4 (refer Appendix 17).

Table 7.4 Correlation coefficient of ventilation rate with outdoor conditions

Outdoor Environmental Conditions	Ventilation Rate (ach)						
	0.0	0.5	0.8	1.0	2.0	5.0	10.0
Hard Surface – Without Trees	0.973**	0.987**	0.986**	0.983**	0.958**	0.887**	0.825**
Indirect Effect of Tree – Without Tree Shading	0.955**	0.965**	0.953**	0.944**	0.902**	0.828**	0.772**
Direct Effect of Tree – With Tree Shading	0.958**	0.967**	0.960**	0.952**	0.915**	0.845**	0.791**

**Correlation is significant at the 0.01 level (2-tailed)

Based on the above results, it can be observed that in each condition the most correlated results were found at air change rate of 0.5 ach, with R^2 of 0.987, 0.965 and 0.967 in all with tree outdoor conditions. It can be assumed that the indoor conditions for the Industrial Design Building and Student Centre I would have similar indoor conditions due to the comparable ventilation rates. Thus, in this study the Industrial Design Building was selected to represent one sample building for every outdoor condition simulated in this study. Additionally, the 0.5 ach was used as a reference in presenting the actual building ventilation rate in further investigations.

7.2.4 Comparison of Measured and Computed Indoor Air Temperature Results

Based on previous shading mask and ventilation rate results, Figure 7.6 shows the indoor air temperature, T_a , simulated by HTB2 plotted against measured T_a , in three different outdoor landscape conditions. Considering the flexibility of the HTB2 model in providing different meteorological inputs, HTB2 is found to accurately represent the trends of indoor T_a with two contrasting periods in all outdoor environments. It can be observed that all three conditions simulating values of indoor T_a were underestimated during the morning periods, and the average error at these times was found to be between 0.4°C and 0.6°C for each condition. This may be because the model underestimated the heat release from the building fabric during the night, as compared to the actual conditions.

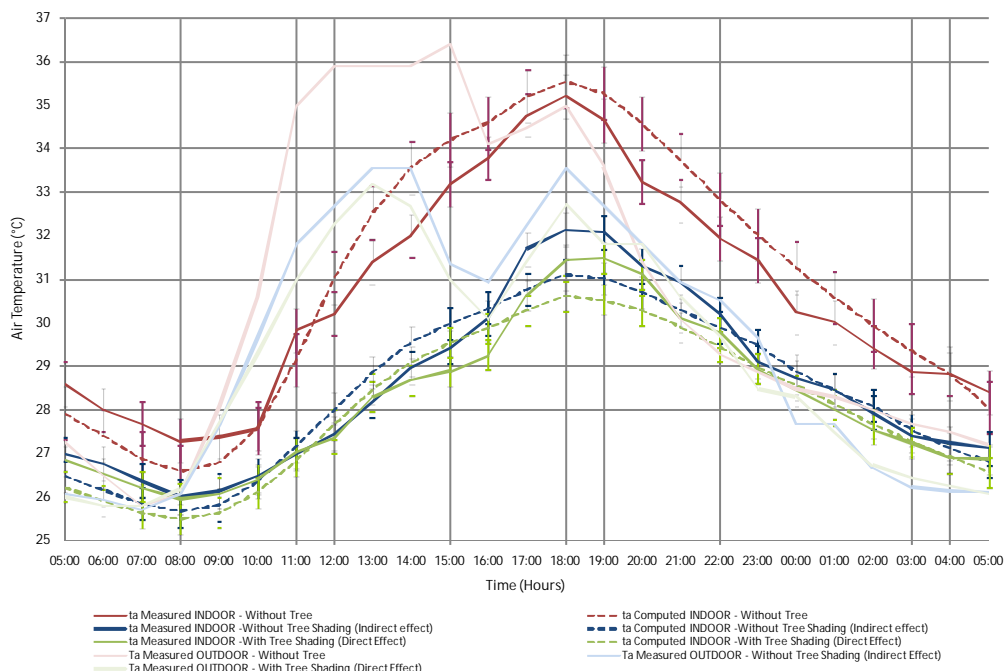

Figure 7.6 Comparison between measured and computed results for indoor air temperature in three different outdoor environments

In addition, the underestimated daytime indoor air temperatures with and without trees shading effects, and overestimated without tree conditions, occurred mostly during the peak hours, 1700 to 1900 hours. The overestimation and underestimation of daytime indoor air temperature may due to the model's presumption of constant ventilation in the building, which does not allow for flexibility in the air exchange rate. In fact, implementation of the tree shading mask may affect the accuracy levels of both predicted and measured data, especially with and without tree shading effect conditions. Nevertheless, the daytime average error was found to be lower, within the range of 0.5°C to 0.7°C, and the highest average error was during the peak hours in all conditions, between 0.6°C and 0.8°C, respectively.

Table 7.5 Correlation coefficients between the measured and the computed air temperatures for each outdoor condition in a 24 hour period

Outdoor Conditions	Measured and Computed Indoor Air Temperature	
	Correlation coefficient (R ²)	Average Error (°C)
Without Tree	0.985**	0.7
Without Tree Shading (Indirect Effect)	0.965**	0.4
With Tree Shading (Direct Effect)	0.967**	0.4

**Correlation is significant at the 0.01 level (2-tailed)

Regardless of the contrasting results, it can be estimated that over 24 hours simulation using HTB2 would be reasonable. By comparing the computed and measured results without trees, without tree shading (indirect effect) and with tree shading (direct effect) conditions, the average errors were found to be 0.7°C, 0.4°C and 0.4°C, respectively. In fact, similar 24 hour air temperature curves were achieved in the three different conditions using the calculated correlation coefficient, R², between the measured and computed ranges from 0.965 to 0.985 tabulated in Table 7.3. Thus, it can be claimed that the measured and computed temperatures, using HTB2 for indoor T_a, correlated and accurately predicted, and therefore can be considered a reliable tool which can be used for further investigation.

7.3 Comparisons of Cooling Load Influence according to Tree Cooling Effect

In order to understand the influence of outdoor environmental conditions on the indoor environment, especially in terms of cooling load, Figure 7.7 shows an investigation result for three different outdoor environments. Based on office hours of 9:00 to 17:00 hours, the air-conditioning was switched on at 25°C room temperature. Then, from 17:00 hours onwards, the air-conditioning was switched off.

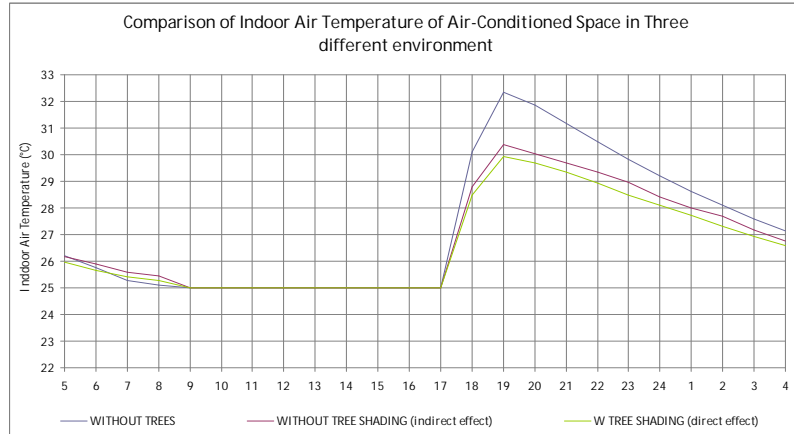

Figure 7.7 Comparison of indoor air temperature with air-conditioned space in three different outdoor environments

Based on this activity, Figure 7.8 shows the results of the cooling load for each outdoor condition. It can be readily observed that the outdoor condition without trees (i.e. hard landscape) shows the highest cooling load compared with the other conditions. The maximum cooling load reached up to 26 KWh for without tree condition, whilst for both indirect effect and direct effect of tree condition it was lower, at 21 KWh and 20 KWh, respectively. As tabulated in Table 7.6 and Figure 7.9, the total cooling load for one single day was found to be higher, at 155.6 KWh, whilst the indirect effect and direct effect of with tree conditions were found to be 132.3 KWh and 121.6 KWh, respectively. This makes a significant reduction of 14.9% and 21.9% for both tree conditions respectively.

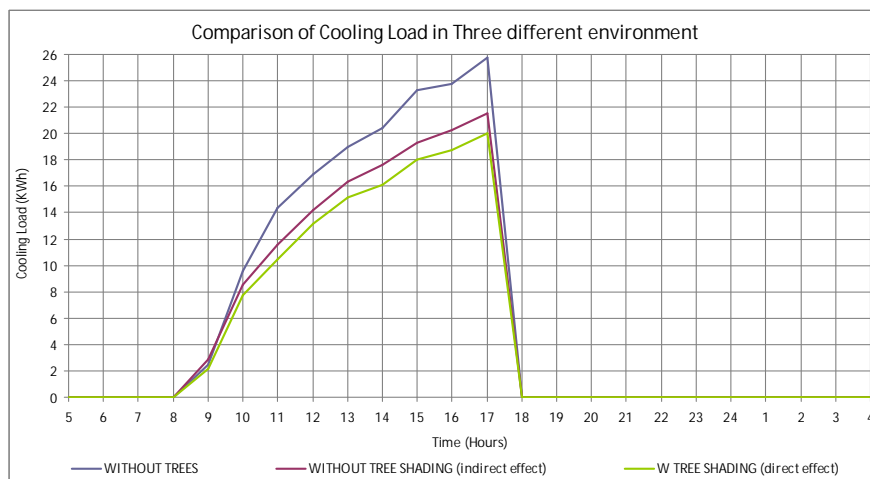

Figure 7.8 Comparison of indoor air temperature with air-conditioned space in three different outdoor environments

Table 7.6 Comparison of total cooling load and reduction of energy usage in three different outdoor conditions

	Without Trees	Without Tree Shading (Indirect effect)	With Tree Shading (Direct effect)
Total Cooling Load (KWh)	155.6	132.4	121.6
Reduction of Energy Usage (Comparing to Without Trees Condition)	0.00%	14.9%	21.9%

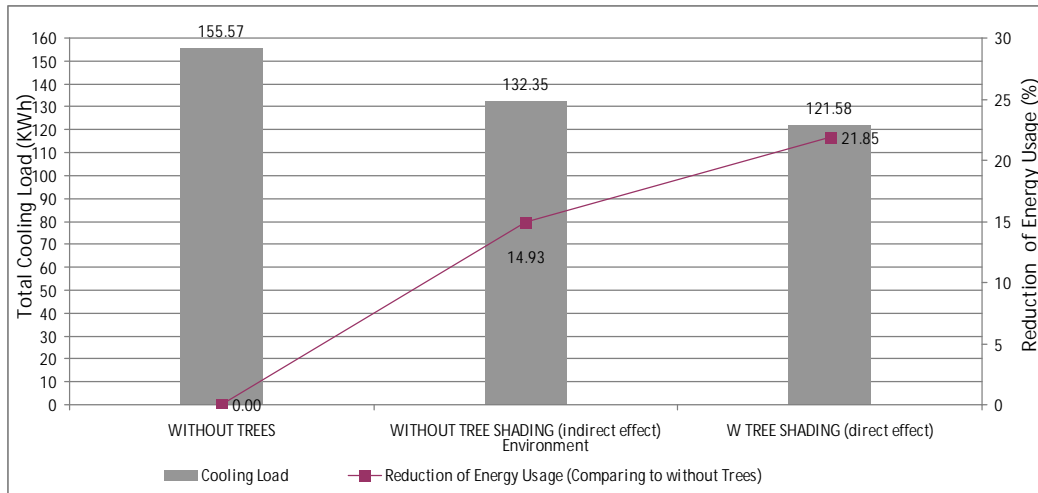

Figure 7.9 Comparison of total cooling load and reduction of energy usage in three different outdoor conditions

The larger differences in both tree conditions explain the benefits of direct effect of tree shading and cooling effect of trees within a 2m distance of the building wall. However, the influence of indirect effect from tree evapotranspiration (i.e. cluster of trees within 9m of the building wall) should also be noted as this condition contributes to more than half of reduction in energy usage, compared with direct effect conditions. This result correlates with Akbari et al.'s (1992) findings, where the indirect effect of evapotranspiration had more effect compared with direct shading, in terms of building energy savings. In fact, it can be observed that both effects become greater when trees are closer to an east or west building wall. Therefore, it is also important to investigate the effect of trees based on distance from tree to building wall in order to reach a clearer understanding of the indirect impact on building energy savings.

7.4 Comparisons of Cooling Load Influence by Tree Distance from Building Wall

Table 7.7 Comparison of total cooling load and reduction of energy usage influence by tree distance from building wall

	Tree Distances					
	2m	3m	4m	5m	8m	10m
Total Cooling Load (KWh)	121.6	123.5	125.9	127.8	129.7	131.1
Increases of Energy Usage (Comparing to 2m Distance)	0.00%	1.6%	3.5%	5.1%	6.7%	7.4%

Table 7.7 and Figure 7.10 show the comparison results of total cooling load and reduction of energy usage influence by tree distance from building wall. It can be observed that tree distance plays an important role in determining the building energy usage. On average, the percentage energy usage increased by about 1.5% for every meter away from the building wall. This is because the direct effect of shading decreases with trees further away from the building wall, and only the indirect effect of trees is received as the air temperature decreases with the cooling effect (i.e. evapotranspiration process) of the trees. Although the effect is not as great as with the direct effect of trees, the indirect effect of trees plays an important role in reducing building energy usage in urban areas with clusters of trees (i.e. a number of tree) and a high canopy density of trees that offers significant cooling and improved outdoor air temperature, especially in tropical urban environments. This condition leads to improved indoor air temperature and, at the same time, improved building energy savings in urban areas. Thus, it is important for this study to evaluate the indirect impact of the outdoor environment, especially air temperature modification that influences the indoor air temperature and building energy savings.

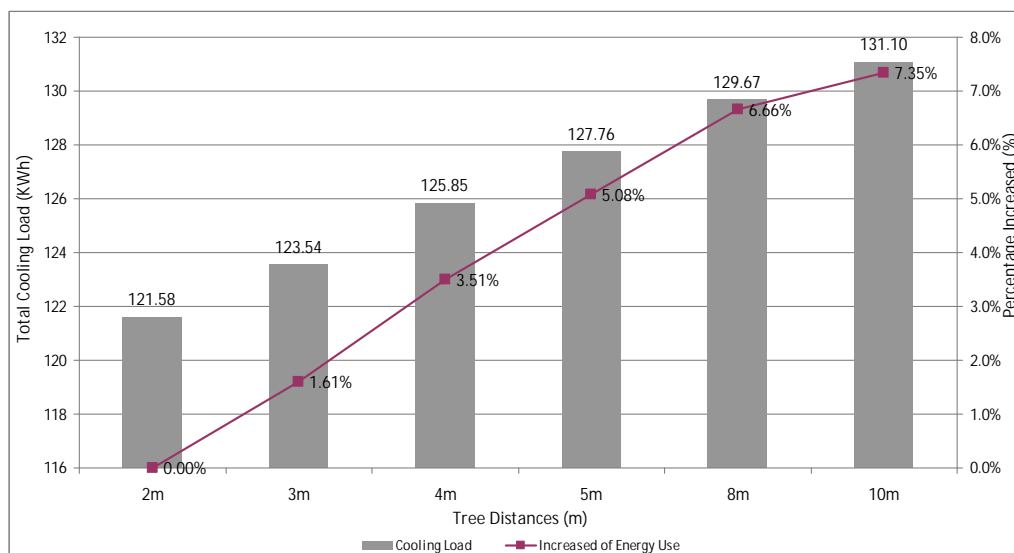

Figure 7.10 Comparison of total cooling load and reduction of energy usage based on tree distances

7.5 The Indirect Effect of Outdoor Air Temperature Modification on Indoor Air Temperature in Selected Location Points in Persiaran Perdana

Table 7.8 Comparison of outdoor air temperature modification in six selected location points in Persiaran Perdana

Location	CONDITION	Outdoor Air Temperature (°C) Reduction						No of Trees		Total	Increase Percentage
		A	B	C	D	Differences	Reduction (%)	Current Tree	Add Tree		
Wawasan Park	Average	29.20	28.90	28.00	27.60	1.60	5.48	90	0	90	0
	Peak (Max)	31.90	31.30	31.10	30.10	1.80	5.64				
Perbadanan	Average	29.70	29.10	28.50	28.40	1.30	4.38	36	0	36	0
	Peak (Max)	32.20	31.50	31.30	30.60	1.60	4.97				
Rakyat Square	Average	29.90	28.90	28.50	28.40	1.50	5.02	64	22	86	35%
	Peak (Max)	33.00	31.90	31.90	31.00	2.00	6.02				
P3P Road	Average	29.90	28.40	27.60	27.60	2.00	7.69	0	124	124	100%
	Peak (Max)	32.60	31.30	31.00	30.50	2.10	7.44				
Wisma Tani's Pedestrian	Average	29.50	29.00	28.60	28.60	0.90	3.05	10	0	10	0
	Peak (Max)	31.90	31.50	31.40	30.40	1.50	4.70				
Perdana Boulevard	Average	29.80	29.20	28.90	29.00	0.80	2.68	0	4	4	100%
	Peak (Max)	33.00	31.70	31.70	31.70	1.30	3.94				

Table 7.9 Comparison of indoor air temperature modification in six selected location points in Persiaran Perdana

Location		Indoor Air Temperature (°C) Reduction						No of Trees		Total	Increase Percentage
		A	B	C	D	Differences	Reduction (%)	Current Tree	Add Tree		
Wawasan Park	Average	28.93	28.48	27.78	27.74	1.19	4.12	90	0	90	0
	Peak (Max)	30.55	30.08	29.60	28.80	1.75	5.74				
Perbadanan	Average	29.04	28.61	28.16	28.09	0.95	3.27	36	0	36	0
	Peak (Max)	30.70	30.24	29.91	29.59	1.11	3.61				
Rakyat Square	Average	29.21	28.49	28.14	28.07	1.14	3.90	64	22	86	35%
	Peak (Max)	31.41	30.66	30.43	29.76	1.65	5.26				
P3P Road	Average	29.24	28.08	27.51	27.50	1.74	5.95	0	124	124	100%
	Peak (Max)	30.96	29.84	29.42	29.11	1.85	5.97				
Wisma Tani's Pedestrian	Average	28.92	28.51	28.24	28.21	0.70	2.44	10	0	10	0
	Peak (Max)	30.56	30.15	29.96	29.31	1.25	4.09				
Perdana Boulevard	Average	29.09	28.66	28.44	28.40	0.69	2.36	0	4	4	100%
	Peak (Max)	30.71	30.30	30.15	29.56	1.15	3.74				

In order to evaluate the indirect effect of outdoor microclimate modification from high canopy density trees and the cool materials influence on building energy savings, the outdoor and indoor air temperatures from each modification scenario were evaluated. These results were used to justify the impact of modification on both outdoor and indoor air temperature, and how great a reduction of outdoor and indoor air temperature can be achieved from the modification of high canopy density trees and cool materials. By using the same building as the previous experiment, a comparison of average and maximum outdoor and indoor temperatures in six selected locations in Persiaran Perdana were tabulated in Tables 7.7 and 7.8, and Figures 7.11 and 7.12. In outdoor air temperature modification, it can be seen that the highest reduction is in condition (D) of P3P Road, where the modification of 124 high canopy density trees were placed at this location point. The average and maximum reductions were found to be 2.0°C and 2.1°C, with reductions of 7.7% and 6.4% respectively, compared with condition (A). This modification of the outdoor environment offered a further reduction in indoor air temperature, with average and maximum temperatures of 1.7°C and 1.9°C (i.e. 6.0% and 6.0%), respectively. On the other hand, the lowest tree quantity location point, Perdana Boulevard, with four trees, shows the lowest average and maximum

reductions of 0.7°C and 1.2°C, with percentage reductions of 2.4% and 3.7%, respectively. Significantly, this result confirmed the effect of outdoor modification from trees and cool materials on indoor air temperature improvement in Persiaran Perdana. Thus, the building cooling load is reduced due to the impact of these external modifications. Furthermore, it can be noted that the reduction of outdoor and indoor air temperature shows a significant correlation with high canopy density tree quantities.

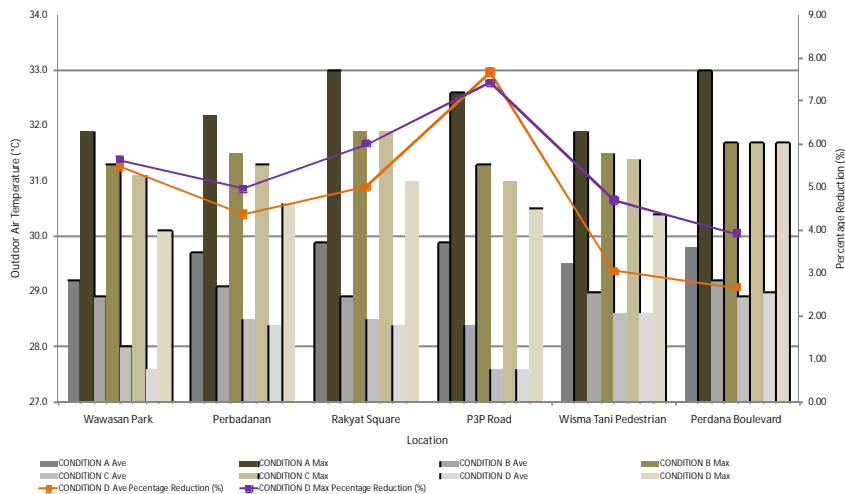

Figure 7.11 Summary of the comparison of outdoor air temperature modification in six selected location points in Persiaran Perdana

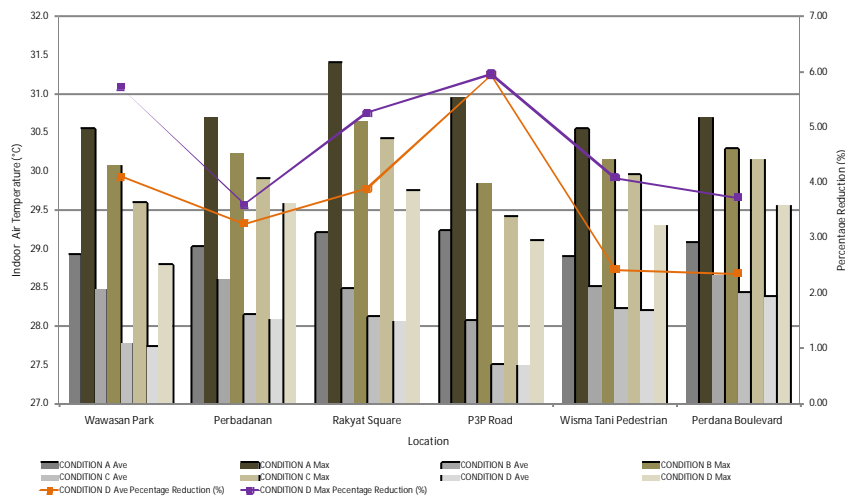

Figure 7.12 Summary of the comparison of indoor air temperature modification in six selected location points in Persiaran Perdana

Figures 7.13 and 7.14 show the calculated and plotted average and maximum outdoor and indoor air temperature reductions against high canopy density tree quantities. The fitted regression lines for average outdoor and indoor air temperature reduction, $dT_{a \text{ mean (out)/(in)}}$, versus high canopy density tree quantities, Q , are as follows:

$$dT_{a \text{ mean (out)}} = 0.0091 \times Q + 0.8216 \quad (R^2 = 0.96) \quad \text{Eq. 23}$$

$$dT_{a \text{ mean (in)}} = 0.0077 \times Q + 0.6217 \quad (R^2 = 0.91) \quad \text{Eq. 24}$$

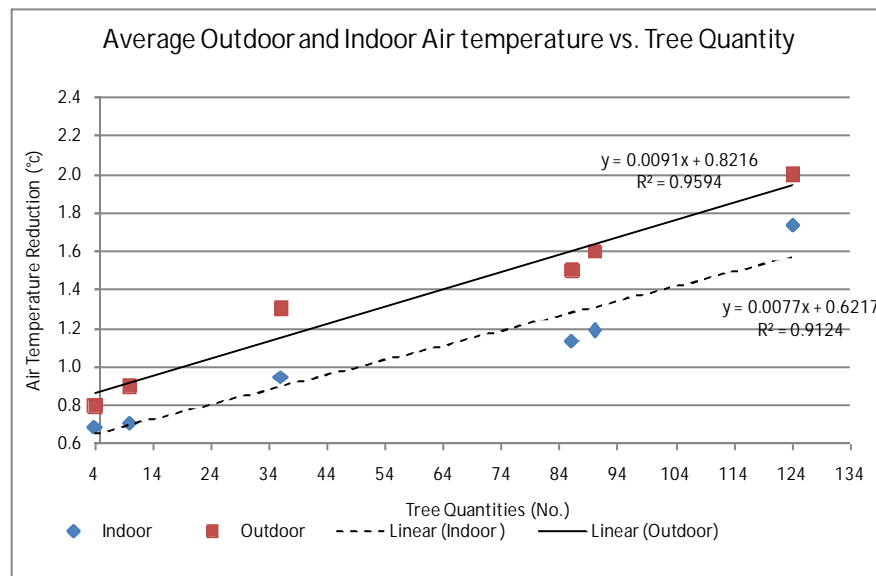

Figure 7.13 Correlation between average outdoor and indoor air temperature and tree quantities in six selected location points

The slope of the lines indicates the average outdoor and indoor air temperature to tree quantity increases. The slope value is 0.0091 corresponding to a 0.009°C average outdoor air temperature reduction per single high canopy density trees added to the site, starting from 0.8°C reduction in 4 trees. This correlates with the per tree cooling effect of *Ficus benjamina* species findings, where similar quantities reduced the average air temperature by 0.8°C. This correlation confirmed the effect of cooling from high canopy density trees on outdoor air temperature modification. On the other hand, the effect of outdoor modification provides a significant reduction in indoor air temperature. It can be observed that the slope value of 0.0077 corresponds to a 0.08°C average indoor air temperature reduction per single trees added to the site, starting from 0.7°C reduction in 4 trees.

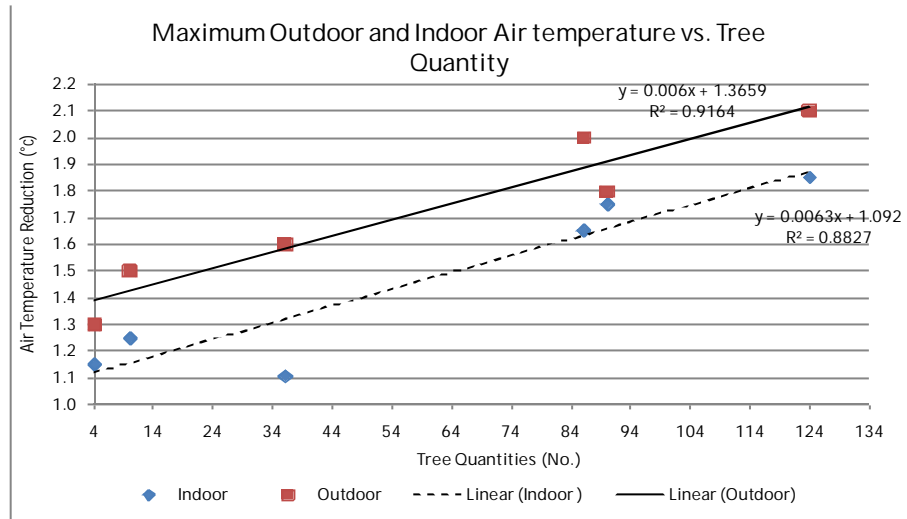

Figure 7.14 Correlation between maximum outdoor and indoor air temperature and tree quantities in six selected location points

Similar fitted regression lines determined for maximum outdoor and indoor air temperature reduction, $dT_{a \max (out)/(in)}$, versus high canopy density tree quantities, Q , are as follows:

$$dT_{a \max (out)} = 0.0006 \times Q + 1.3659 \quad (R^2 = 0.92) \quad \text{Eq. 25}$$

$$dT_{a \max (in)} = 0.0063 \times Q + 1.092 \quad (R^2 = 0.88) \quad \text{Eq. 26}$$

The slope of the line indicates the maximum outdoor and indoor air temperature to tree quantity increases. The slope value is 0.0006 corresponding to a 0.0007°C maximum outdoor air temperature reduction per single high canopy density trees added to the site, starting from 1.4°C reduction in 4 trees. This also correlates with the per tree cooling effect of *Ficus benjamina* species findings, where similar quantities reduced the maximum air temperature by approximately 1.4°C. This correlation confirmed the effect of optimum cooling from high canopy density trees on outdoor air temperature modification during the hottest day at 15:00 in the Malaysian tropical climate. This effect of outdoor modification provides a significant reduction in indoor air temperature. It can be observed that the slope value of 0.0063 corresponds to a 0.006°C maximum indoor air temperature reduction per single trees added to the site starting from 1.1°C reduction in 4 trees. Based on these findings, it can be concluded that by having high canopy density and tree quantities, combined with cool materials, can improve the outdoor air temperature in an urban area. This relationship

between reductions in outdoor and indoor air temperature can results in benefits to the building energy savings in a tropical climate. In fact, it can be noted that the higher quantities of high canopy density trees planted in the building environ, the higher the outdoor and indoor air temperature reductions.

7.6 Indirect Effect of Outdoor Modification on Building Energy Savings at Six Selected Location Points

Table 7.10 Comparison of total cooling based on each modification at six selected location points in Persiaran Perdana

Location	CONDITION	Cooling Load (kWh) Reduction						No of Trees		Total	Increase Percentage
		A	B	C	D	Differences	Reduction (%)	Current Tree	Add Tree		
Wawasan Park	TOTAL	153.85	141.72	125.88	125.11	28.74	18.68	90	0	90	0
Perbadanan	TOTAL	158.20	146.52	134.50	131.33	26.86	16.98	36	0	36	0
Rakyat Square	TOTAL	168.03	145.86	136.68	136.22	31.80	18.93	64	22	86	35%
P3P Road	TOTAL	169.62	132.64	119.89	119.75	49.87	29.40	0	124	124	100%
Wisma Tani's Pedestrian	TOTAL	153.60	141.52	134.91	133.35	20.26	13.19	10	0	10	0
Perdana Boulevard	TOTAL	155.57	148.35	143.04	139.57	16.00	10.28	0	4	4	100%

In assessing the impact of vegetation and cool materials modification on building energy performances in Persiaran Perdana, Table 7.10 and Figure 7.15 show the comparison of total cooling load based on each modification at six selected location points in Persiaran Perdana. It can be observed that condition (A) shows the highest total cooling load in all six locations, from 153.6 to 169.6 KWh for one single day. At this stage, it can be assumed that most buildings in Persiaran Perdana have the highest cooling load due to higher outdoor temperatures caused by insufficient vegetation and a high albedo of hard surfaces. This condition is believed to cause the rises in the building cooling load and results in a drastic increase in urban electricity consumption (Wong and Yu, 2009).

However, about 4.6% to 21.8% of cooling load reduction is observed in condition (B), where vegetation was added to the site with low canopy density trees. In this case, by adding more trees the outdoor air temperature become lower and reduced the building cooling load in Persiaran Perdana. However, the impact was not greater than with high canopy density trees added to the site, and it reduced the building cooling load from 125.9 to 148.0 KWh over one day. This constitutes a significant reduction, from 8.1% to 29.3% in condition (A). It shows that the densities and types of trees play an important role in offering an indirect effect on building energy savings in a tropical climate. Significantly, the ultimate impact on building energy savings at street level can be observed when both combinations, modification

of high canopy density trees and cool material, offer a further reduction in total cooling load. The total cooling load was found to be in the range of 119.8 to 139.6 KWh, with a percentage reduction of 10.3% to 29.4%. This represents a significant improvement in urban building energy saving in Persiaran Perdana. These findings confirmed the combined effect of both modifications on building energy savings in Persiaran Perdana, and this modification strategy could benefit annual energy consumption in tropical urban areas. This also verifies the hypothesis and answers the research questions regarding the influence of modification on building energy savings.

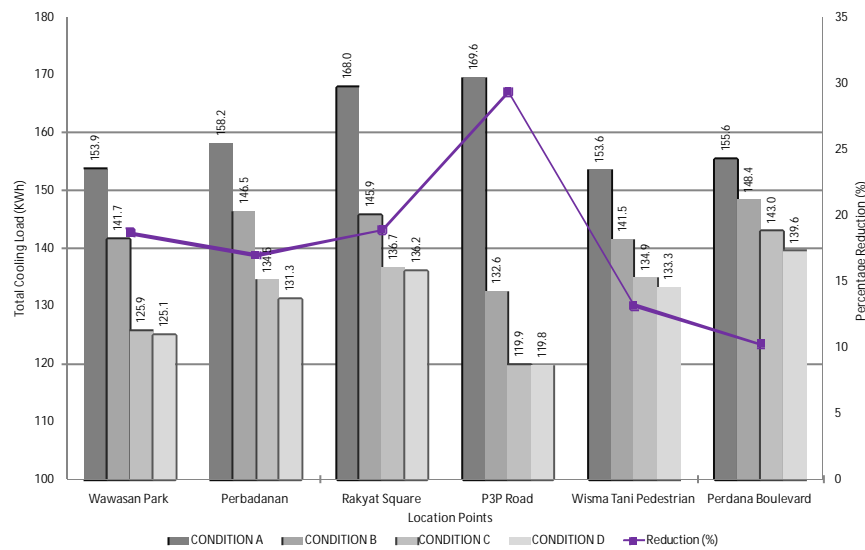

Figure 7.15 Summary of the comparison of total cooling, based on each modification in six selected location points in Persiaran Perdana

Additionally, the findings from this study also found that the reduction in building total cooling load is well correlated with high canopy density tree quantities. Figure 7.16 shows the calculated and plotted total cooling load percentage reduction against high canopy density tree quantities. The fitted regression lines for total cooling load percentage reduction, $T_{cl\downarrow}$, versus high canopy density tree quantities, Q , are as follows:

$$T_{cl\downarrow} = 0.1239 \times Q + 10.682 \quad (R^2 = 0.85) \quad \text{Eq. 27}$$

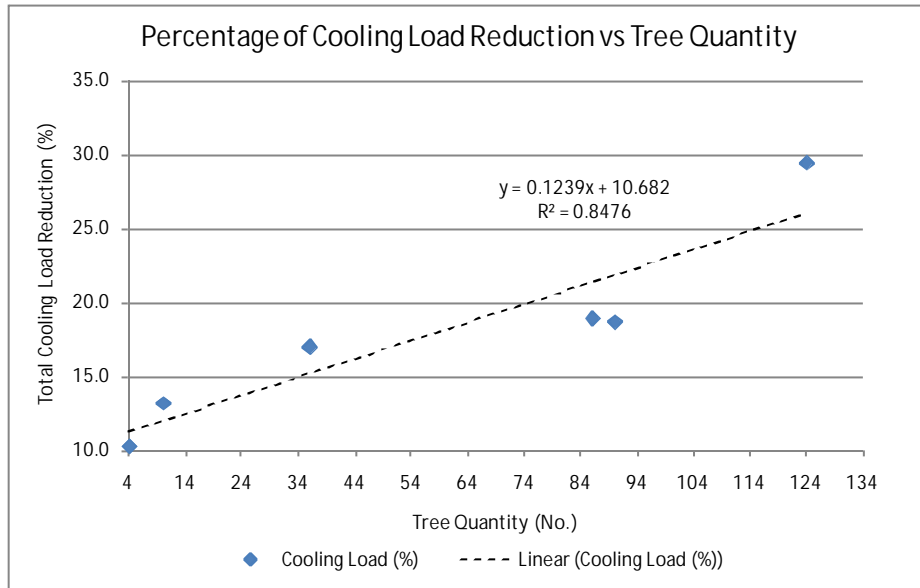

Figure 7.16 Correlation between total cooling load percentage reduction and tree quantities at six selected location points

The slope of the fitted line indicates the total cooling load percentage reduction to tree quantity increases. The slope value is 0.1239 corresponding to a 0.12% total cooling load reduction per single high canopy density trees added to the site, leading to a minimum reduction of 11.2% due to the planting of 4 trees. It appears that the building cooling load reduces with the increase of tree quantities. Finally, it can be concluded that modification of tree canopy density, quantity and cool materials significantly benefit building energy savings in Persiaran Perdana. Therefore, these three major aspects should be considered in designing urban outdoor landscapes. The modifications optimally modify outdoor and indoor air temperature and ultimately offer improvements in building energy performance in hot urban tropical climate conditions.

7.7 Discussion

Based on the validation result presented in section 7.2.3, it is clearly shown that HTB2 is capable of simulating an indoor environment influenced by outdoor modification. Regardless of the underestimated and overestimated values of peak hour indoor air temperature, the average error ratio in every condition was found to be within the range of $\pm 1^\circ\text{C}$. This was deemed to correlate with, and accurately predict, the influence of direct and indirect effect of trees, according to the correlation coefficient results of R^2 value ranged from 0.965 to 0.985. In addition, the findings from this also confirmed the reliability of the

tree shading mask development, as the predictions for the direct effect of trees were significantly correlated. However, this issue of over- and underestimated values needs to be taken into consideration in future studies, with further investigation of this effect needed in order to provide better simulation results.

Further investigation into the effect of different outdoor conditions on building cooling load reveals results of great significance. As presented in section 7.3, the building cooling load was reduced due to the direct and indirect effect of trees. The cooling load was reduced by up to 14.9% due to the indirect effect of a tree cluster within 9m of the building wall, whilst a further reduction was observed, of 21.9%, influenced by the direct shading effect of trees. However, the findings also revealed that the indirect effect of trees contribute almost 2/3 reduction in building energy, compared with the direct shading of trees on the building wall. This finding also correlates with Akbari et al.'s (1992) study where the same amount was recorded, due to the effect of evapotranspiration that further reduced the outdoor air temperature.

Thus, the importance of the cooling effect of trees is more important in reducing the outdoor and indoor air temperature; however, a greater cooling load reduction can be achieved when both effects are combined through the direct effect of trees. On the other hand, the investigation into the influence of tree distance on building cooling load confirmed that the direct and indirect effects of trees was an approximate increase of 1.5% total cooling load for every meter away from the building wall. Ideally, the best effect of trees on building energy performance was found to be within a 2 to 3 m distance, as the effect of shading and evapotranspiration (i.e. cooling effect) was significantly effective here. Nevertheless, the effects of both conditions will affect building energy demand in a tropical environment. Thus, these findings further explained the importance of direct effect and the consequences of indirect effect of trees on building energy performances.

Based on the above investigations, the same building was used to evaluate the indirect effect of outdoor modification on the building environment in Persiaran Perdana. Six significant location points were selected with different environments and modification. In the context of outdoor and indoor air temperature modification, it can be observed that almost of the outdoor building areas were improved within the average range of 0.8°C to 2.0°C

outdoor, and 0.7°C to 1.9°C indoor, and with modification to high canopy density trees and cool materials. In fact, both outdoor and indoor air temperature reductions were found to correlate significantly with tree quantities.

It can be concluded that the higher the quantity and canopy density of trees provided with cool materials, the higher the reduction in outdoor and indoor air temperature; and this correlation significantly affects the building energy savings. It has been confirmed that the effect of optimum outdoor microclimate modification from trees and cool materials reduced by up to 29.4% when 124 trees were added near to the building area. The optimum indirect effect of trees on building energy savings can also be evaluated from the correlation results, where the effect of higher tree quantity and canopy density with cool materials will offer higher building energy savings. This concluding statement further verifies the earlier hypothesis on the beneficial value of outdoor microclimate modification from trees and cool materials on building energy performance.

7.8 Summary

The building energy savings chapter offers two main conclusions. Firstly, it has been proven in this chapter that variation of outdoor environment significantly influences the indoor environment, especially for air temperature modification. It is clear that the effect of trees plays an important role in modifying outdoor air temperature, and at the same time reduces indoor air temperature effectively. It can also be claimed that the variation of tree canopy density provides different levels of indoor air temperature improvement. In fact, the effects of trees on indoor environment were divided into two parts – i.e. direct and indirect effect. On the one hand, the direct effect of tree shade and evapotranspiration (i.e. cooling effect) can be optimally achieved from a tree that is 2m to 3m close to an east or west building wall, and this condition provides a significant outdoor and indoor improvement.

On the other hand, indirect effect of trees can be obtained when a cluster of trees provides a cooling effect from evapotranspiration due to the distance from the building wall. However, this study also agreed with Akbari et al.'s (1992) findings that the indirect effect of trees can provide almost 2/3 of the reduction in indoor environment temperature and total cooling load, as compared to the direct effect of shading alone. In addition, the ground

surface materials play an important role in modifying the outdoor environment, as grass surface can provide evaporative cooling which enhances the air temperature reduction compared with asphalt or pavement ground surfaces.

Secondly, as one of the objectives of this study was to evaluate the benefits of outdoor modification towards building energy savings in Persiaran Perdana, it can be concluded that modification of high canopy density trees and cooling materials offers an optimum building energy savings compared to other proposals. It is clear that the indirect effect of trees reduces outdoor air temperature and significantly influences indoor air temperature. This condition leads to an optimum cooling load reduction of up to 29.4% with 124 high canopy trees in a cluster arrangement, and it also demonstrates that tree quantity is another important factor in optimising building energy savings. The cooling load reduction becomes greater as the tree quantity increases. Importantly, the implementation of this ultimate modification may lead to more than a quarter of reduction in building energy cost in Persiaran Perdana. Therefore, it can be concluded that the combination of these four major aspects – i.e. (i) high tree canopy density; (ii) large tree quantity, (iii) cool materials; and (iv) tree distances from building's wall- offers an optimum building energy saving for Persiaran Perdana and for tropical urban environments in general.

CHAPTER 8

CONCLUSIONS AND RECOMMENDATIONS

8.1 Introduction

This chapter concludes the overall discussions and findings of the thesis. It includes the following sections: conclusions, based on the thesis aim and objectives; guidelines for improving UHI mitigation strategies for tropical and hot climates; outline for possible future research and contributions of the study.

8.2 Conclusions based on Thesis Aim and Objectives

8.2.1 Review of UHI and Cooling Modification Potential of Vegetation and Albedo

As discussed in Chapter 2, the implication for UHI effect that is caused by an effect of urbanisation through poor design planning, decreased green areas, and unbalanced urban energy processes, can lead to uncomfortably raised urban temperatures in both cold and hot climates. This prompted the author to gather literature on the UHI phenomenon during the summer months for countries that have a similar tropical climate, in order to understand the similarity and differences. This literature is presented in section 2.4. The study found that the similarity of both regions can be determined by resemblance of urban features that characterise the urban climate. However; both regions have several differences, due to climatic parameters especially during the UHI max in the hot and dry season in tropical regions and the summer season in non-tropical region. In this case, the strategies for mitigating the UHI need to be based on specific climatic parameters and the location of the city.

It can be observed that during the hot season, UHI intensity can reach 8.0°C. This condition can become more extreme, especially in tropical climates, due to high exposure to solar radiation. In the tropics, air temperature, surface temperature, relative humidity, and the radiation regime are the variables most affected regarding changing the whole microclimate in an urban area. The changes in an urban tropical microclimate can directly impact on bioclimatic influences that are more focused on human thermal comfort and building energy performance, especially for cooling (Emmanuel, 2005). This is important when considered in

the context of reported annual electricity consumption increases of up to 5.3% (Akbari et al., 2001 and Wong and Yu, 2009). In addition, this study discovered that lack of vegetation and extensive use of lower albedo hard surfaces are among the main causes of the UHI effect occurring in both temperate and tropical regions. In the context of Malaysia, the few examples of works providing evidence of UHI occurrence reported in section 2.5.2, concluded that within a 15 year time period the UHI intensity in Kuala Lumpur, the capital city of Malaysia, increased by 1.5°C from 5°C in 1992 to 7.5°C in 2006 (Sham, 1984; Shaharudin, 1992; Elsayed, 2006). With urban temperatures threatening to increase within a short period of time, it has been considered necessary in this study to assess the UHI intensity in development of new urban areas such as Persiaran Perdana, Putrajaya. Based on the literature findings presented in section 2.7, most studies of the UHI mitigation strategies study claimed that by increasing the amount of vegetation and raising albedo values urban air temperature would significantly reduce. However, this study has taken a further step in improving the strategies, by providing theoretical evidence and assessing the potential of modifying both physical properties of vegetation and ground surfaces to give the optimum cooling effect at street level.

It was explained in detail in chapter 3, that vegetation and ground surfaces can be modified through the understanding of physical and technical reactions to all microclimate variables. It was also indicated that there are two mechanisms by which trees offer cooling benefits; i.e. shading and evapotranspiration. Particularly in hot climates, tree canopies have the ability to alter the microclimate via radiation interception based on their physical characteristics. Thus, this study indicated that dense foliage cover, branching habit, and species types are major factors influencing the value of radiation interception. Foliage cover that is related closely to high canopy density contributes by intercepting more incoming solar radiation and also improves air temperature, surface temperature and relative humidity due to high quality shade creation, as detailed in section 3.2. Thus, it was pointed out that density, types, sizes, and arrangements of leaves play important roles in improving efficiency of radiation absorption and reflection. Technically, the above characteristics provide better efficiency as a result of the evapotranspiration process via lower leaf temperature, lower surrounding air temperature, and increased humidity. Also, a higher number of trees will promote greater cooling effects and efficiency.

All these conditions are prominent in offering optimum cooling benefits especially in a tropical urban climate. Therefore, the study suggests that these factors need to be taken into account when creating the most effective shade and cooling effect. Shade and evapotranspiration effectiveness is closely related to leaf area index (LAI) and leaf area density (LAD) and as a result these are key measures used to understand and compare plant species. With this value, the cooling effect performance of plant canopies across tree species and across trees within a species can be compared and evaluated. Thus, knowledge of the tree canopy's physical characteristics is of prime importance in explaining the potential of vegetation modification in offering an optimum cooling effect in the urban environment.

As presented in section 3.4, high albedo urban surfaces are suggested as offering cooler surfaces and reduced urban surface temperature. As detailed in section 3.4.1, physical properties of ground materials such as colour, texture and construction material determined the 'cool' values of the materials. It is recommended that by modification of higher albedo and emissivity value materials (i.e. near to 1) less absorption of direct radiation can be achieved for urban structures, which keeps surfaces cooler. Technically, white and polished surfaces are recommended as providing a 'cool' materials effect. However, it is worth pointing out that due to high porosity and absorption of more water and latent heat into the atmosphere, a grass surface has a much greater effect in reducing surrounding air and surface temperature. Importantly, the study concluded that by implementing larger quantity of higher canopy density, coupled with high albedo material will offer greater shading effect, more latent heat effect, lower radiation interception and absorption in ground surface materials that can give a better result in cooling down the urban environment and mitigate the UHI effect. In fact, the bio-climatic influences from both modifications are explained in detail in section 3.4.3. Finally, this thesis has shown the extent to which combination of vegetation with ground material modification can theoretically act as climatic modifiers, lowering raised urban temperature, by applying their physical characteristics in promoting optimum cooling effects at street level.

8.2.2 UHI Mitigation Strategies

8.2.2.1 Hot and Cool Spots through Thermal Satellite Images Assessment and Field Measurement

The first thermal satellite images assessment was conducted to understand the development process influencing land cover distribution due to the changes of vegetation, building density and transformation of new ground materials, from 1994 to 2005. Secondly, the superimposed images were used to identify the 'hot' and 'cool' spots in Persiaran Perdana, Putrajaya. The assessment was successfully conducted within the limitations stated by the author. The details of the assessment procedure and descriptions are detailed in section 4.3.3. In the thermal satellite image assessment findings, presented in section 5.1, it has been confirmed that the increase of hot spots in Persiaran Perdana and surrounding area is due to vegetation loss, replacement and development of new built-up areas, and ground surface materials. Based on data collected between 1994 and 2005, this study revealed an almost 18.58% loss of vegetation area is within a 10 km radius of Persiaran Perdana, Putrajaya, due to new city development. A higher number of hot spot areas can be found and it is believed that this condition invited the unpredicted heat island effect and caused abrupt changes in the surrounding air temperature. In fact, the study also found that it is important during any construction stage that expansions of development area need to be controlled to prevent an unpredicted heat island effect due to the changes in land cover and major losses of vegetation, especially in a tropical urban climate highly exposed to solar radiation.

In focusing on Persiaran Perdana area findings (section 5.1.2), it was pointed out that the UHI effect in Persiaran Perdana was a distributed collection of hot spots separated by green areas (cool spots). It can be seen clearly that the most remarkable distribution of hot spots was focused at the centre of boulevard, and are on and around the buildings and hard surfaces areas (i.e. car parks, squares and bare grounds). It can be concluded that buildings and hard surface areas are among the contributors to the creation of UHI in Persiaran Perdana. Thus, these areas are notified as critical areas that need to be considered for further improvement. On the other hand, there are cool spots that represent a variation of density of greenery and have the ability to influence the thermal distribution of nearby buildings and surrounding environments. It was observed that the buildings surrounded by the perimeter of the green area have better thermal distribution than other buildings away from the dense green area. In addition, the denser green areas such as Wawasan Garden more successfully

offer a better cooling effect due to the higher quantity and density of trees. In addition small pocket parks and green fields offer a reduced cooling effects due to the small numbers of trees with lower density. It can be concluded that the variation of tree densities and quantities create a difference in cooling effects on the surrounding environment.

Field measurements consisting of weather station air temperature and relative humidity were conducted to understand and compare the current conditions in 12 selected location points based on satellite images results. The whole area of Persiaran Perdana was divided into three major environmental conditions, namely, green area, open hard surface area, and mixed environment area (hard, green and water area). The entire field measurement period was successfully conducted from February 1 to March 3, 2009 within the time, manpower, information and instruments limitations defined by the author. A typical day was randomly selected on 28th February and detailed descriptions of measurements and procedures taken then are described in section 4.3. 4.

Overall, the study revealed that Persiaran Perdana had a higher UHI intensity than other urban areas with a magnitude of 2.6°C over the period of one month. This finding confirmed the actual UHI phenomenon in Persiaran Perdana. The details, described in Chapter 5.2.2, reveal that the location and urban pattern influences different values in air temperature, relative humidity, and surface temperature. Places with fewer plants have higher air temperature and vice-versa. Air temperature, relative humidity and surface temperature with different land uses are quite relevant to the density of greenery and surface materials used and this is well correlated with the distribution of hot and cool spots from thermal satellite image findings. Low albedo materials (i.e. tarmac and red concrete imprint) with standard albedo values of 0.2 and 0.3 were considered among the highest heat contributors to the environment with a day-time average surface temperature magnitude of 39.9 to 40.0°C, respectively. On the other hand, polished white granite with a standard albedo value of 0.8 shows a lower day-time average surface temperature of 32.0°C. Although albedo for grass is lower than other materials at 0.3, the lowest surface temperature was found, due to the high moisture content, in the soil with a magnitude of 31.4°C.

Therefore, most of the areas that provide high canopy density of trees and albedo values (i.e. Wawasan Garden) create a lower air and surface temperature with higher relative humidity, with maximum differences in air temperature reaching up to 2.7°C and 2.0°C on

average; relative humidity with 12.2% minimum and an average of 8.8%; and surface temperature maximum differences reaching up to 25.5°C and average with 20.0°C, compared with hard paved area with lower albedo values (i.e. Putra Square). This is due to the shade from trees that reduces downwards energy flow to the ground and makes the surface cooler. Also, a combination of higher albedo and grass cover underneath a canopy maintains higher moisture retention and slows the evaporation process in the soil due to the shading effects. These findings confirmed that both surface and air temperature UHI contributes to the actual condition of the UHI phenomenon in Persiaran Perdana. These findings revealed the critical areas demanding focus in Persiaran Perdana which need to be considered for further mitigation. Thus, combination modification of tree and albedo physical properties can be implemented further in offering a better solution in mitigating the UHI phenomenon in this city area.

8.2.2.2 ENVI-met Model Validation

The ENVI-met simulation model has been used to describe the effect of tree and albedo modification on temperature decrease and cooling effect. As most existing models, describing fluid dynamics and heat transfer in the microclimate to local climate scale, they do not take into consideration surface-plant-air thermal and plant physiological interactions; this model was equipped to take this phenomenon into account. The general structure of the model, especially regarding vegetation and ground surfaces was described in section 4.3.5.3. Thus, the thermal effect of vegetation and surface with different canopy density and albedo values can be evaluated in detail. Due to the limited local plant database, as presented in Chapter 4, a new database evaluating four types of local plant species, leaf area density and leaf area index values was developed. This model has its limitations due to the weakness of the model on the prognosis of the night time situation, i.e. overestimation of air temperature and the lack of the nocturnal heat release process as no heat is stored in the building's fabric (Ali-Toudert, 2005 and Fahmy et al, 2010).

Besides, the study also revealed that the air temperature is generally underestimated due to overestimation of the wind cooling effect. Thus, further adjustment to wind speed is needed and this has become an additional reference point for further simulation based research using this model. However; based on the experiments presented in section 5.3, conducted at twelve selected location points comparing computed and measured air

temperature and ground surface temperature, the results shown are well correlated and reliable. The study found that the 24-hour average error was about 0.9°C with a correlation coefficient R^2 , ranged from 0.91 to 0.98. Meanwhile, surface temperature showed an average error of 1.3°C with correlation coefficient R^2 , ranged from 0.86 to 0.97. As these two factors are important in estimating the effects of both vegetation and ground surface materials towards the urban microclimate environment, the T_a and T_s measured and computed by ENVI-met were deemed to correlate and accurately predict, and can be considered as a reliable tool and therefore are able to be used for this study. The study also concluded and recommended that ENVI-met simulation model is a suitable model for any future research that needs to consider the effects of plants, surface and urban microclimate.

8.2.2.3 Tree Cooling Effect and Optimum Cooling Potential with Different Scenarios through ENVI-met Model Prediction

In confirming the effect of trees on urban environments, the study conducted a per-tree cooling effect evaluation using ENVI-met on individual trees based on different types of species and density. Based on the findings using ENVI-met simulation in determining per-tree cooling effect with different densities, it was indicated that a key parameter in defining the performance of tree cooling effects is the leaf area index (LAI) of the canopies. In order to further evaluate the LAI based on per-tree's cooling performances, the local canopies' leaf area density (LAD) profiles were generated, to be used and added to the ENVI-met plants database. The results were presented in Chapter 5.3.2 with an individual experiment using local tree species with LAI, namely, *Maleleuca leucadendron* of (LAI 0.9) *Filicium decipiens* (LAI 4.7), *Mesua ferrea* (LAI 7.9) and *Ficus benjamina* (LAI 9.7), respectively.

The study revealed that the average air temperature reduction is well correlated for individual trees densities with magnitude of 0.37°C to 0.60°C as a result of the variation of tree densities from each individual tree species. It can be concluded that the higher canopy tree densities provide a better reduction in air temperature underneath the canopy. This is based on the highest direct radiation interception of tree canopy up to 98.7% for the higher canopy density with 9.7 LAI values for *Ficus benjamina* species. A low radiant temperature of 12.6°C offers a low amount of terrestrial radiation underneath the canopy, thus reducing the ground surface temperature by a magnitude of 7.5°C. This condition promotes the evapotranspiration process and produces more latent heat that helps increase water vapour in

the air with absolute humidity of 0.18 g/m^3 and relative humidity of magnitude up to 2.2% for a single tree. However, up to 63% of wind speed reduction occurs as tree canopy density becomes greater. Nonetheless, the net result of radiation is still a decrease in total radiant energy input and lower temperatures can be achieved through the creation of shade and radiation interception.

It has also been highlighted that when the number of trees has increased from four to ten, in cluster planting of *Ficus benjamina* species, there is a gradual decrease of temperature up to 0.98°C , owing to the highest radiation interception up to 99.9% and reduction in ground surface temperature. Importantly, this study also revealed that the performance of trees on shading and the evapotranspiration process can be found during the hottest time of day in a tropical climate, at approximately at 15:00 hours. Thus, it can be concluded that variations of tree canopy density values create a different cooling effect to the surroundings by reducing the underneath and surrounding air and surface temperatures, and providing an increase of relative humidity due to the high quality of shade creation and radiation interception. The effects should be greater when cluster planting is applied with the increased number of trees. The findings highlight the capability of trees in modifying microclimate and therefore, by manipulating the physical properties and quantities, optimum cooling can be achieved. This also verifies the hypothesis and answers the question of cooling effect performance based on tree densities.

This study has predicted the significant potential in offering an optimum cooling effect to urban spaces by modifying vegetation and physical properties. In further prediction of the optimum cooling potential from both modifications, the current environment of Persiaran Perdana has been compared with three different scenarios consisting of different tree LAI values and albedo values. Based on the findings presented in section 5.4.2, the model predicts that for Persiaran Perdana with a scale up to average of 2.7°C , lowered temperatures can be expected when the majority of trees have a higher LAI values, 9.7 (i.e. *Ficus benjamina* species), with additionally half the number of existing trees provided with cool materials (i.e. 0.8).

It should be noted that this improvement has filled the gap of UHI intensity, found earlier in the current condition of Persiaran Perdana. However, it can be seen from the findings that this mitigation strongly depends on the LAI values and quantity of trees. This is

due to the fact that modification with higher number of albedo values (i.e. 0.8) contributes only a small maximum reduction of air temperature with a magnitude of 0.1°C compared to high tree canopy density conditions. However, it should be noted that the greater impact of cool materials can be seen when they were placed underneath high canopy density trees, with up to 0.2°C to 0.6°C. In addition, the study revealed that tree quantity has significantly correlated with air temperature reduction, and has been described in detail in section 7.5. Thus, the study proved that modifying tree LAI value to higher tree canopy density with an adequate tree quantity is sufficient in lowering urban temperature in Persiaran Perdana.

This study shows that tree quantities and densities play a significant role in providing significant temperature reduction on an urban scale. However, combined modifications of both vegetation and cool materials are required to achieve the largest temperature reduction, due to the average improvement of differences of relative humidity, absolute humidity, ground surface temperature and radiant temperature of 18%, 2.2 g/m³, 13.1°C and 16.7°C respectively in compared to current condition. Therefore, this study recommends that trees with high canopy density (e.g. *Ficus benjamina* species) are needed to provide high quality shade coverage and radiation interception, with additional high albedo surfaces (e.g. polished white granite) providing low energy absorption, for the optimum cooling effect in a tropical urban environment. Nonetheless, it should be noted that by replacing surfaces with grass or a combination of grass and high albedo hard surfaces, vegetation will be more efficient in producing the optimum cooling effect due to the effective evapotranspiration process, moisture availability, and high surface cooling rate in grass and soil layers. In other words, the UHI effect can be mitigated optimally at street level in an urban microclimate, especially in a tropical region, by implementing the right tree quantities with a suitable selection of tree species and surface materials. Therefore, the above findings contribute to additional guidelines for mitigating the UHI by highlighting the importance of trees and albedo selection.

8.2.3 Outdoor Thermal Comfort Perception and Impact of Outdoor Modification towards their Comfort Level

In order to assess the influence of optimum modification on Persiaran Perdana's users, initially the study measured the users' outdoor thermal comfort perception in Persiaran Perdana in three major identifiable environments that are green spaces, open spaces and

outdoor building spaces. The results were tabulated and detailed in of section 6.1. The primary important findings reveal that users' actual thermal sensations tend to be neutral when in shaded conditions, on a typical hottest day in a tropical climate. Although similar effects of shading from tree canopies and buildings have benefited humans, the overall thermal comfort satisfaction under tree canopies was remarkable during the hottest day in Persiaran Perdana. In addition, the findings concluded that the neutral temperature of PET in Persiaran Perdana was found to be at 27.8°C and was a further reference point for evaluating the impact of modification towards outdoor human thermal comfort. The study also agreed with Nikolopoulou's findings on the importance of air temperature and mean radiant temperature for assessing the actual thermal sensation satisfaction. Generally, these values become paramount factors for analysing the benefits of modification on outdoor thermal comfort in locations in Persiaran Perdana. In addition, the study revealed that variation in relative humidity and wind movement provide a smaller effect on human thermal sensation satisfaction.

Based on the regression model for the neutral temperature of PET, the study has confirmed the effect of vegetation and ground surface material modification on outdoor thermal comfort in Persiaran Perdana. The results were presented in detail in section 6.3. With high tree canopy density trees alone, only 50% of location points were improved from a 'hot' to a 'comfortable' condition. However, the study also revealed that almost 75% of areas were improved due to the impact of modification and became closer to a 'comfortable' condition. Thus, it can be concluded that the greater the quantity and canopy density of trees with cool materials, the greater the improvement of outdoor human thermal comfort in Persiaran Perdana. These modifications provide higher quality of shade, greater radiation interception and evapotranspiration process in lowering the air and mean radiant temperature optimally. These findings highlight the potential of tree and ground material in reducing outdoor thermal comfort in Persiaran Perdana. Thus, this verifies the hypothesis and answers the research questions on the impact of modification towards human outdoor thermal comfort.

8.2.4 Influence of Outdoor Environment Modification towards Building Energy Saving

As presented in detail in chapter 7 section 7.1.1, the study has proven quantitatively that the outdoor environment significantly influences the indoor environment, and the

outdoor landscape plays an important role in determining any difference. Notably, the effect of trees on buildings' indoor environment was divided into two categories; the direct and the indirect effect. The direct effect of trees combined with direct shading to the walls and the immediate cooling effect from evapotranspiration process offered greater improvement in the indoor environment. The closer the tree towards the building walls, the better the effect on the indoor environment. This is due to a reduction in outdoor air temperature of 4.2°C, caused by the shading and cooling effect of trees, influencing indoor air temperature; as compared to the direct effect obtained, of up to 2.2°C. However, the impact of indirect effect is remarkable as more than half of the reduction can be found from cooling effect alone. On the other hand, the findings show a vice-versa condition wherein most of the indoor air temperature was increased due to the absence of trees (i.e. hard pavement condition). However, the ground surface materials play an important role in modifying the outdoor environment, as grass surface can provide evaporative cooling that can enhance air temperature reduction in the outdoor environment, when compared to an asphalt or pavement ground surface. Thus, these findings confirm quantitative evidence of the influence of the outdoor landscape environment on the indoor environment.

To simulate the effect of trees on building energy performance in this study, the same three outdoor environments (i.e. without tree, with tree indirect effect and direct effect) and building were simulated in HTB2 model with the influence of a tree shading mask. The comparisons between measured and simulated indoor air temperature were significant with correlation coefficient result, R^2 , of 0.99, 0.97 and 0.97, respectively with up to $\pm 0.5^\circ\text{C}$ average error, as presented in detail in section 7.2.3. However; there are uncertainties in the model that need to be highlighted which underestimated early morning indoor air temperature, possibly due to underestimated heat release from building fabric during the night time. The overestimation and underestimation of daytime indoor air temperature may result from the model of constant ventilation in the building that does not allow flexibility in the air exchange rate. In fact, implementation of a tree shading mask may affect the accuracy levels of both predicted and measured data. Nevertheless, the model was deemed to be correlated and to accurately predict and therefore is considered a reliable tool in investigating building energy savings. Thus, in conditions when more detailed simulation result is required, those parameters should be measured in detail, moreover, the first attempt of shading mask development has open a room for improvement as the error can be improved in further research regarding this subject area.

Importantly, the model predicts that the reduction in total cooling load of indirect effect and direct effect of trees compared to an absent tree condition, were remarkable with 14.9% and 21.9% reduction. Notably, the indirect effect of trees offers half the total cooling load reduction compared to the direct effect of trees. Thus, the effect of cooling (i.e. evapotranspiration) is greater than the effect from tree shading. In fact, the effect of tree location further explains the importance of trees' direct and indirect effect on building energy performances. The study found an average 1.5% increase of total cooling load for every metre that trees are away from the building wall. Ideally, the best effect was found when trees are 2 to 3m distant from an east or west-facing building wall. This was presented in detail in section 7.4.

Finally, the benefits of outdoor modification towards building energy savings in Persiaran Perdana were predicted using the model and presented in detail in section 7.5. It can be concluded from this findings that modification of high canopy density trees and cool materials offers optimum building energy savings compared to other proposals. The study revealed that in almost all building areas, outdoor and indoor air temperatures were improved by up to 2.0°C and 1.2°C, respectively; due to the modification to high canopy density trees and cool materials. In fact the study also revealed that tree quantities are well correlated with outdoor and indoor air temperature reduction. It can be concluded that the higher the quantity and canopy density of trees provided with cool materials, the higher the reduction of outdoor and indoor air temperature. This condition has an effect on the energy performances of buildings and was confirmed when up to 29.4% reduction in total cooling load was found when 124 high canopy density tree clusters were added to the site (refer to section 7.6). This revealed that over a quarter of building energy costs in Persiaran Perdana can be reduced as results from this modification implementation. Thus, this answers the research questions regarding how much influence outdoor modification has on building energy performance in Persiaran Perdana. Essentially, the study recommends that four major factors need to be considered in optimizing the building energy savings; i.e. high tree canopy density, greater tree quantity, cool materials and tree distances from building wall.

8.3 Guidelines for Improving UHI Mitigation Strategies for Tropical and Hot Climates

Based on the research findings and conclusions, the potential guidelines for improving UHI mitigation strategies are as follows:

1. Overall, the study shows that modification of vegetation and ground surface materials has a significant influence on external and internal environments. Therefore; it is suggested that planting tree species with higher canopy density trees in appropriate quantities should be considered as additional guideline in mitigation strategies, at the design or planning stage for new urban areas. In the case of new built-up urban areas, such as Persiaran Perdana, Putrajaya, the replacement or adding of extra trees, with the right physical criteria is recommended to result in the desired cooling effect. The implementation in order to minimize the impact of UHI would also be applicable to other new city developments in Malaysia;
2. Choice of the right plants should ideally be based on the trees' physical characteristics, such as density, height and crown width, types of tree species, size of leaves and branching arrangement. The species selection also needs to take into consideration the availability of native plants that are appropriate for geographic and climate context. Making the right choice of plants would result in more effective and better radiation interception and lowered urban temperatures. Mature trees with similar characters to the *Ficus benjamina* species (i.e. LAI 9.7) are recommended as priority plants to ensure the implementation of UHI mitigation strategies is successful. In addition, in order to provide optimum effect, trees with cluster planting design are recommended to offer a better quality of shade and cooling (i.e. evapotranspiration) to influence human energy budgets and improve human thermal comfort;
3. Modification by choosing or replacing surfaces with high albedo ground material (i.e. 0.8) is recommended, e.g. polished white granite, in order to reduce ground surface temperature in areas with no tree planting. Besides, the smooth and light coloured surface and construction materials made of marble, mosaic and stone material is recommended in indicating the material of 0.8 albedo values. However, it is suggested that to provide an optimum cooling effect by reducing air, surface temperature and thermal reflectivity into buildings; cool pavements are best placed underneath a high-

density tree canopy. Also, a combination of a pavement and grass surface can offer a greater cooling effect, due to the way in which grass coverage promotes the evapotranspiration process;

4. As the outdoor landscape has a great influence on the indoor environment, providing high-density tree canopies with grass surfaces outside buildings would lead to the cooling of internal spaces and therefore increase energy savings. However, it is recommended that the effect will be much greater if the trees are planted 2 to 3 metres away from the east or west wall of the building, as trees act as natural shading and cooling devices. It was determined that four key factors need to be considered when providing optimum building energy savings; tree canopy density, tree quantity, cool materials and tree distances to building wall.

8.4 Outline for Possible Future Research

The findings and recommendations stated are limited to the scope of this study. Many related issues and detailed findings need further investigation, in order to improve on the evaluation of trees and ground surface physical properties potential for minimising the UHI effect. Several suggestions for future research are recommended to refine the detailed procedures carried out for this thesis.

1. One of the limitations of the present study is the lack of local tree species provided by ENVI-met model databases. Although this study developed four different profiles of local tree species that contribute to the model's plants database, this was limited the author's ability to simulate the local environment with a diversity of different types and densities of local species. These limitations have opened up new research possibilities in terms of gathering local tree species information and data through field measurement studies to enhance the scope of ENVI-met model plants databases; thus producing more accurate and precise simulations, especially in tree cooling effect potential towards local urban environments. Although there is much room for improvement, the author believes that tree development methodology can be useful for further LAI and LAD evaluation for other types of local tree species.

2. As this study has provided substantial possibilities based on the weakness and strength of ENVI-met model in Malaysia's urban climate perspectives, the author would suggest further research may be used applying this model as a tool for designing and assessing the old and new city throughout Malaysia. This tool will be further upgraded from time to time as new assessments will be obtained from the advanced versions of this model.
3. Future comparisons of different types of local tree species with the same canopy density preferences should be explored. This will allow more understanding of the actual ability of various tree species in providing different cooling effects. It will include a further research refinement on trees' physical aspects such as size of leaves, branching arrangement, height and forms of plants. It is also suggested the variations of ground surface albedo and grass should be examined with different types of tree canopy density in assessing the behaviour of individual interaction between both entities. As this study is based on the individual tree's ability in modifying urban microclimate using model and literature validation, thus it is also suggested for future research framework to include a comparison on measured and computed validation to ascertain a better result.
4. As this study provides knowledge of tree LAI in maximizing the cooling effect of trees, further investigation into multiple tree canopy layers at different densities can be developed. By using future upgraded and advanced three dimensional ENVI-met simulations (i.e. ENVI-met V4.0), this upcoming model provides a massive competency to develop a 3-D tree plant model, full building geometry and simulation of terrain. Through this model's ability, the effect of tree canopy layers on microclimate variables, especially wind effect can be better predicted. The significant form and effect of trees can be also visualised better.
5. As the study found that UHI in tropical and temperate climate has similar urban features to the urban climate, the author would suggest the guidelines be implemented in new UHI locations. This is for further understanding of the impact of these guidelines on different locations and weather conditions. It will provide comparative knowledge in improvement UHI mitigation strategies guidelines according to weather and locality of urban area.

6. This study has exposed the actual outdoor thermal comfort conditions in Persiaran Perdana by identifying comfort zones that are suitable for local users in this city area specifically during peak periods. However, due to the time and instrumentation limitations of fieldwork, the site measurement for outdoor thermal comfort was carried out with limited instrumentations, time and numbers of environmental locations. This has open up new research possibilities for which Perbadanan Putrajaya would probably seek to conduct further research on daytime site assessments using better instruments and focusing on a larger area throughout the whole city of Putrajaya; if both the time and cost permits. Although the field study is the main activity for this research work, this study has shown how limited resources can still measure the outdoor thermal comfort level in city areas.

7. Further investigation into the different effects of tree densities, on building energy savings in conjunction with shade intensity and coverage using an HTB2 model need to be explored. The first attempt at this study regarded developing tree canopy shading masks to ascertain the actual direct effect of tree through shading and cooling, the author believed that there is more room for improvement in this area. The development in variation of tree form, density and transmissivity could enhance the flexibility of HTB2 model in assessing the impact of outdoor or indoor environments. Although this study has validated the results on the effect of tree shading masks, the procedure can be improved further. This could be assessed in another research study by measuring the actual tree canopy transmissivity from different angles and location points, to provide accuracy in defining radiation transmission value. Thus, the enhancement of the HTB2 model in predicting tree shading effect is potentially useful for architects, landscape architects, designers, etc.

8.5 Limitation and Suggestion of the Study

It is important for this study to highlight the limitations of the study for further research suggestions and to ensure validation in future work. There are some issues and approaches in this study that need to be highlighted and improved for further study.

In outdoor thermal comfort surveys, the instruments that used in measuring globe temperature need to be reconsidered. The used of black globe thermometer need to be replaced with gray globe thermometer that is more suitable for comfort outdoor studies outdoor. By using black globe thermometer without correction for people's solar thermal reflectivity assumes that all people in the sun are black wearing black clothing, thus overestimating MRT in these conditions (Nikolopoulou, 2006). Importantly, the study suggested that further research need to consider gray globe thermometer that able to evaluate globe temperature with consideration of people's solar thermal reflectivity.

The used of hot wire-directional is limited to one directional air flow measurement. Thus, there is limitation on wind speed measurement from various directions. It is suggested for further research to consider omni-directional instrument that able to measure any wind directions as this will influence the certainty and reliability of wind speed measurement.

In evaluating all microclimate parameters that constitute to outdoor thermal comfort evaluation, it is important to highlight the limitation in this study. All parameters were examined in relation to the single variable as opposed to the overall thermals sensation. Thus for further work, the individual evaluation should consider for overall thermal sensation as this will influence the outcome of the findings.

8.6 Contributions of the Study

The outcome of this study not only offers a solution to some of the issues and problems that are faced in mitigating the impact of UHI in tropical climate, but at the same time enriches the knowledge in this field. The study has identified efforts in improving UHI mitigation strategies in tropical climates by assessing the potential optimum cooling effect of trees and the physical properties of ground surface materials. The proposed guidelines would

be useful in improving the new city development and act as new for to architects, landscape architects, planners, environmentalist and urban designer.

The study has discovered five main contributions, which add substantially to the current literature, especially that concerning guidelines in UHI mitigation strategies in urban tropical climate:

1. This study has expanded the guidelines in UHI mitigation strategies in tropical countries by suggesting baseline models for types and numbers of plants species and ground surface material and how these combination strategies can be implemented to offer optimum urban cooling. Furthermore, the proposed extended guidelines can be argued to be adaptable and appropriate for use not only in Malaysia and other tropical cities, with some modifications, but are also applicable and appropriate for use in other climate regions. Importantly, these guidelines can be implemented throughout the city of Putrajaya, especially in Persiaran Perdana, in order to solve UHI issues in this particular area. In addition, the implementation would reduce the cost of cooling energy and improve the comfort of urban dwellers throughout the city.
2. This study has provided a new insight into the perceptions of Malaysian urban designers; especially architects, planners, landscape architects and government, regarding the importance of tree and ground surface material selection when designing urban area. This knowledge is important for opening up a new perspective and capability regarding the technical aspects of trees and ground surface materials in minimising the impact of UHI. By knowing the fact and figures, the designer can better allocate effort in designing urban space to maximise the cooling potential from both factors.
3. The study has provided a platform in adding the knowledge of local tree canopy databases, especially in tree canopy modelling, that can be used sufficiently in ENVI-met tools. This will further enhance future research to provide varieties of local species in the database and improve the competency of ENVI-met models in future developments.

4. The study has provided the basic database on the comfort level of outdoor thermal comfort for Persiaran Perdana users during daytime peak hours, which can be further used as a reference for Perbadanan Putrajaya, in order to evaluate the impact of outdoor landscape throughout the city area.
5. Finally, the combined method framework in this study, assessing the UHI phenomenon using satellite images, ENVI-met prognosis model and field measurement has enhanced the current UHI assessment in this city in Malaysia. For the first time, to the author's knowledge, this process and research framework has been implemented to offer a better understanding and advanced solutions for enhancing UHI mitigation strategies in Malaysia.

As a final point, the author strongly believed that the work carried out in this study has contributed in improving the guidelines in UHI mitigation strategies to lead to a better solution in mitigating the impact, as a result, improving the quality of urban life in present and future development. It is hoped that these contributions will broaden the scope of researchers in this and related fields.

References

1. Adebayo, Y.R. (1987). Land-use approach to the spatial analysis of the urban 'heat island' in Ibadan, Nigeria. *Weather*, 42(9), 273-280.
2. Adebayo, Y.R. (1990). Aspects of the variation in some characteristics of radiation budget within the urban canopy of Ibadan. *Atmospheric Environment B*, 24(1), 9-17.
3. Adebayo, Y.R. (1990/91). Consideration for climate sensitive design in tropical Africa. *Energy and Buildings*, 15/16, 15-21.
4. Adebayo, Y.R. (1991). 'Heat Island' in a humid tropical city and its relationship with potential evaporation. *Theoretical and Applied Climatology*, 43(3), 137-147.
5. Ahmad, S. (2003). *Trends of urban climate in several urban areas in Malaysia: An analysis of urbanization impacts* (in Malay). In the National Conference proceedings of Development Challenge, Environmental Dilemma, 12-13 September 2003, UKM Bangi, 703-724.
6. Akbari H. and Konopacki. S, (2005). Calculating energy-saving potentials of heat island reduction strategies. *Energy Policy*, 33, 721-756.
7. Akbari, H. (2002). Shade trees reduce building energy use and CO2 emissions from power plants. *Environmental Pollution*, 116(Supplement 1), 119-126.
8. Akbari, H. and Rose, L.S. (1999) *Characterizing the fabric of the urban environment: A case study of Sacramento, California*. Lawrence Berkeley National Laboratory, 48. Berkeley, CA, USA.
9. Akbari, H. and Rose, L.S. (2001) *Characterizing the fabric of the urban environment: A case study of Salt Lake City, Utah*., Lawrence Berkeley National Laboratory, 51. Berkeley, CA, USA.
10. Akbari, H. and Taha, H. (1992). The impact of trees and white surfaces on residential heating and cooling energy use in four Canadian Cities. *Energy*, 17, 141-149.
11. Akbari, H., Berdahl, P., Levinson, R., Wiel, S., Miller B. and Desjarlais, A. (2006). *Cool colour roofing material*. Lawrence Berkeley National Laboratory and Oak Ridge National Laboratory Report, Berkeley and Oak Ridge, USA.
12. Akbari, H., Bretz, S., Kurn, D.M. and Handford, J. (1997). Peak power and cooling energy savings of high-albedo roofs. *Energy and Buildings*, 25, 117-126.
13. Akbari, H., David, S., Dorsano, S., Huang, J. and Winnett, S. (1992). *Cooling our Communities*. EPA, USA, 99-103.

14. Akbari, H., Pomerantz, M. and Taha, H. (2001). Cool surfaces and shade trees to reduce energy use and improve air quality in urban areas. *Solar Energy*, 70(3), 295-310.
15. Akbari, H., Rosenfeld, A. and Taha, H. (1989). *Recent developments in Heat Island Studies: technical and Policy*. In proceedings of Workshop on Saving energy and Reducing Atmospheric Pollution by Controlling Summer Heat Islands, 23-24 February, 14-20. Berkeley, CA, USA
16. Alexander D.K. (1996). *HTB2 Users Manual*. Welsh School of Architecture, United Kingdom.
17. Alexander, D. and Jones P. (1996). *Heat Transfer in Buildings 2.0*. Welsh School of Architecture: Thermal predictive model, United Kingdom
18. Alexandri, E. (2005). *Investigations into Mitigating the Heat Island Effect through Green Roofs and Green Walls*. Unpublished PhD thesis, Cardiff University, Cardiff, United Kingdom.
19. Alexandri, E. and Jones, P. (2008). Temperature decreases in an urban canyon due to green walls and green roofs in diverse climates. *Building and Environment Part Special: Building Performance Simulation*, 43(4), 480-493.
20. Ali-Toudert, F. (2005). *Dependence of outdoor thermal comfort on the street design in hot and dry climate*. PhD thesis, Institute of Meteorology, Freiburg, Germany.
21. Ali-Toudert, F. and Mayer, H. (2006). Numerical study on the effects of aspect ratio and orientation of an urban street canyon on outdoor thermal comfort in hot and dry climate. *Building and Environment*, 41, 94-108.
22. Ali-Toudert, F. and Mayer, H. (2007a). Thermal comfort in an east-west oriented street canyon in Freiburg (Germany) under hot summer conditions. *Theoretical and Applied Climatology*, 87, 223-237.
23. Ali-Toudert, F. and Mayer, H. (2007b). Effects of asymmetry, galleries, overhanging facades and vegetation on thermal comfort in urban street canyons. *Solar Energy*, 81, 742-754.
24. Allaby E.M. (2006). *A Dictionary of Ecology*. *Oxford Reference Online*. Oxford University Press, Cardiff University [Online]. Available: <http://www.oxfordreference.com/views/ENTRY.html?subview=Main&entry=t14.e3509> (Accessed on 27 February 2008)
25. American Forestry Association (1996). CITYGreen software module for ArcView GIS v.3.x [online]. Available: <http://www.americanforest.org/productsandpubs/citygreen/citygreen5.php/> (Accessed on 25 March 2010).

26. Arnfield, A.J. (1982). An approach to the estimation of the surface radiative properties and radiation budgets of cities. *Physical Geography*, 11(3), 220-239.
27. Asaeda, T. and Ca, V.T. (1993). The subsurface transport of heat and moisture and its effects on the environment: a numerical model. *Boundary- Layer Meteorology*. 65, 159-179.
28. Asaeda, T., Vu, T.C. and Akio, W. (1996). Heat storage of pavement and its effect on the lower atmosphere. *Atmospheric Environment*, 30(3), 413-427.
29. ASHRAE, 2001. *ASHRAE Fundamentals Handbook 2001* (SI Edition). American Society of Heating, Refrigerating, and Air-Conditioning Engineers, USA.
30. Azhari, A.W., Sopian, K., Zaharim, A. and Al-Ghoul, M. (2008). A new approach for predicting solar radiation in tropical environment using satellite images – case study of Malaysia. *WSEAS Transactions on Environment and Development*, 4.
31. Barden, H. (1982). Simulationsmodell für den Wasser-, Energie- und Stoffhaushalt in Pflanzenbeständen. Rep. Inst. Met. Univ. Hanover, 23.
32. Barradas, V.L., Tejeda-Martinez, A. and Jauregui, E. (1999). Energy balance measurements in a suburban vegetated area in Mexico City. *Atmospheric Environment*, 33 (24-25), 4109-4113.
33. Bojic, M. and Yik, F. (2005). Cooling energy evaluation for high-rise residential buildings in Hong Kong. *Energy and Building*, 26, 253–273.
34. Bonacquisti, V., Casale, G.R., Palmieri, S. and Siani, A.M. (2006). A canopy layer model and its application to Rome. *Science of the Total Environment*, 364(1-3), 1-13.
35. Bourbia, P.F. and Mansouri, O. (2008). *The effect of albedo on urban street microclimate for semi arid climate Constantine*. In World Renewable Energy Congress (WRECX), Glasgow, Scotland.
36. Bretz, S.E. and Akbari, H. (1997). Long-term performance of high-albedo roof coatings. *Energy and Buildings*, 25, 159-167.
37. Brown, R.D. and Gillespie, T.J. (1995). *Microclimate landscape design: creating thermal comfort and energy efficiency*. John Wiley & Sons, New York, USA.
38. Bruse, M. (1999). *Die Auswirkungen kleinskaliger Umweltgestaltung auf das Mikroklima. Entwicklung des prognostischen numerischen Modells ENVI-met zur Simulation der Wind-, Temperatur-, und Feuchtverteilung in städtischen Strukturen*. PhD thesis, Univ. Bochum, Germany.
39. Bruse, M. (2008). ENVI-met V3.1, a microclimate urban scale model [Online]. Available: www.envi-met.com (Accessed on 28 February 2008).

40. Bruse, M. (2009). ENVI-met 3.1 [Online Manual]. Available: www.envi-met.com (Accessed on 10 December 2010).
41. Bruse, M. and Fleer, H. (1998). Simulating surface-plant-air interactions inside urban environments with a three dimensional numerical model. *Environmental Modelling Software*. 13, 373-384.
42. Buechley, R.W., Van Bruggen, J. and Trippi, L.E. (1972). Heat island = death island? *Environmental Research*. 5(1), 85–92.
43. Ca, V.T., Asaeda, T. and Abu, E.M. (1998). Reductions in air conditioning energy caused by a nearby park. *Energy and Buildings*, 29(1), 83-92.
44. Chandler, T.J. (1960). Wind as a factor of urban temperatures – A survey in north-east London. *Weather*, 15, 204-213.
45. Changnon, S.A., Kunkel, K.E. and Reinke, B.C. (1996). Impacts and responses to the 1995 heat wave: A call to action. *Bulletin of the American Meteorological Society*, 77, 1497–1506.
46. Chapman, L., Thornes, J.E., Muller, J. and McMuldloch, S. (2007). Potential applications of thermal fisheye imagery in urban environments. *IEEE Geosciences & Remote Sensing Letter*, 4(1), 56-59.
47. Cheng, V. and Ng, E. (2006). Thermal comfort in urban open spaces for Hong Kong. *Architectural Science Review*, 49, 236-242.
48. Christensen, J. (2005). *Dictionary of Landscape Architecture and Construction*. McGraw-Hill Professional, USA.
49. Clapp, R.B. and Hornberger, G. (1978). Empirical equations for some soil hydraulic properties. *Water Resources Res.*, 14, 601-604.
50. Corner, E.J.H. (1997). *Wayside Trees of Malaya* (3rd ed. Vol. 1). United Selangor Press, Kuala Lumpur.
51. Crawley, B.D., Hand, J.W., Kummert, M. and Griffith, B.T. (2005). *Contrasting the capabilities of building energy performance simulation programs*. In proceedings of the Ninth International Conference of the International Building Performance Simulation (IBPSA), Montreal, Canada, 231-238.
52. de Dear, R. and Fountain, M.E. (1994). Field experiments on occupant comfort and office thermal environments in a hot-humid climate. *ASHRAE Transactions*, 100(2), 457-475.

53. de la Flor, F.S. and Dominguez, S.A. (2004). Modelling microclimate in urban environments and assessing its influence on the performance of surrounding buildings. *Energy and Buildings*, 36, 403-413.
54. Deardorff, J.W. (1978). Efficient prediction of ground surface temperature and moisture with inclusion of a layer of vegetation. *Journal Geophys. Res.*, 83, 1889-1903.
55. Definiens, 2007. [online]. Available: <http://www.definiens.com/> (Accessed on 31 December 2010).
56. Dhainaut, J.F., Claessens, Y.E., Ginsburg C. and Riou, B. (2004). Unprecedented heat-related deaths during the 2003 heat wave in Paris: consequences on emergency departments. *Critical Care*, 2(1-2), <http://ccforum.com/content/8/1/1> (Accessed on 16 June 2010).
57. Dimoudi, A. and Nikolopoulou, M. (2003). Vegetation in the urban environment: microclimatic analysis and benefits. *Energy and Buildings*, 35(1), 69-76.
58. Douglas, S.G., Hudischewskyj, A.B. and Gorsevski, V. (2000). *Use of the UAM-V modelling system as an air quality planning tool for examining heat island reduction strategies*. ACEEE Summer Study on Energy Efficiency in Buildings, Pacific Grove, CA, American Council for and Energy Efficient Economy.
59. Doulous, L., Santamouris, M. and Livada, I. (2004). Passive cooling of outdoor urban spaces. The role of materials. *Solar Energy*, 77, 231-249.
60. Dousset, B. and Gourmelon, F. (2003). Satellite multi-sensor data analysis of urban surface temperatures and landcover. *ISPRS Journal of Photogrammetry and Remote Sensing Algorithms and Techniques for Multi-Source Data Fusion in Urban Areas*, 58(1-2), 43-54.
61. Eliasson, I. (1996). Urban nocturnal temperatures, street geometry, street and land use. *Atmospheric Environment*, Vol. 30(3), 379-392.
62. Ellis, F.P. (1952). Thermal comfort in warm, humid atmospheres, observations in a warship in the Tropics. *Journal of Hygiene*, 50, 415.
63. Ellis, F.P. (1953). Thermal comfort in warm, humid atmospheres, observations on groups and individuals in Singapore. *Journal of Hygiene*, 51, 386.
64. Elsayed, I.S.M. (2006). *The effects of urbanization on the intensity of the urban heat island: A case Study on the city of Kuala Lumpur*. Unpublished PhD Thesis, International Islamic University, Malaysia.

65. Embi, A.F. and Dom, N.M. (2004). *Urban heat islands effects on the microclimate of Malaysian cities*. Proceedings of the 2nd APHW Conference (APHW2004) jointly with the 1st Asia Oceania Geosciences Society (AOGS) Conference, 5-8 July 2004, Suntec International Convention and Exhibition Centre, Singapore.
66. Emmanuel M. R (2005). *An Urban Approach to Climate-Sensitive Design Strategies for the Tropics*. Taylor and Francis Group, London and New York.
67. Emmanuel, R. (2003). Assessment of impact of land cover changes on urban bioclimate: the case of Colombo, Sri Lanka. *Architectural Science Review*, 46(2), 151-158.
68. Emmanuel, R. (2005). Thermal comfort implications of urbanization in a warm-humid city: the Colombo Metropolitan Region (CMR), Sri Lanka. *Building and Environment*, 40, 1591-1601.
69. Emmanuel, R., Rosenlund, H. and Johansson, E. (2007). Urban shading – a design option for the tropics? A study in Colombo, Sri Lanka. *International Journal of Climatology*, 27, 1995-2004.
70. Energy Plus v1.4, U.S department of Energy (DOE) [online]. Available: http://gundog.lbl.gov/EP/ep_main.html (Accessed on 25 March 2010).
71. Environmental Protection Agency United States (2010). Heat Island Impacts [online]. Available: <http://www.epa.gov/heatisland/impacts/index.htm> (Accessed on 23 March 2010).
72. Fahmy, H. and Sharples, S. (2009). On the development of an urban passive thermal comfort system in Cairo, Egypt. *Building and Environment*, 44, 1907-1916.
73. Fahmy, H., Sharples, S. and Eltrapolsi, A. (2009). *Dual stage simulations to study the microclimate effects of trees on thermal comfort in a residential building, Cairo, Egypt*. In Eleventh International IBSPA Conference, Glasgow, Scotland.
74. Fahmy, M., Sharples, S. and Yahiya, M. (2010). LAI based trees selection for mid latitude urban developments: A microclimate study in Cairo, Egypt. *Building and Environment*, 1-13.
75. Fanger, P.O. (1970). *Thermal comfort*. McGraw Hill, New York, USA.
76. FAO. (1984). *Irrigation practice and water management*. United Nations, Rome.
77. Gagge, A.P., Fobelets, A.P. and Berglund, L.G. (1986). A standard predictive index of human response to the thermal environment. *ASHRAE Transactions*, 92, 709-731.
78. Garrat, J.R. (1992). *The atmospheric boundary layer*. Cambridge University Press, Cambridge, United Kingdom.

79. Gartland, L. (2008). *Heat islands understanding and mitigating heat in urban areas*. Cromwell Press, Trowbridge, United Kingdom.
80. Gartland, L., Konopacki, S. and Akbari, H. (1996). *Modelling the effects of reflective roofing*. Lawrence Berkeley National Laboratory, 8. Berkeley, CA, USA.
81. Gedzelman, S.D., Austin, S., Cermak, R., Stefano, N., Partridge, S., Quesenberry, S. and Robinson, D.A. (2003). Mesoscale aspects of urban heat island around New York City. *Theoretical and Applied Climatology*, 75, 29-42.
82. Georgakis, C. (2002). *Temperature and wind velocity in the urban environment*. Athens Group of Building Environmental Physics, University of Athens, 21.
83. Giridharan, R., Lau, S.S.Y., Ganesan, S. and Givoni, B. (2007). Urban design factors influencing heat island intensity in high-rise high-density environments of Hong Kong. *Building and Environment*, 42, 3669-3684.
84. Givoni, B. (1989). Urban Design in Different Climates. *WMO Technical Report*, 346.
85. Givoni, B. (1991). Impact of planted areas on urban environmental quality: A review. *Atmospheric Environment. Part B. Urban Atmosphere*, 25(3), 289-299.
86. Gomez, F., Gaja, E. and Reig, A. (1998). Vegetation and climatic changes in a city. *Ecological Engineering*, 10(4), 355-360.
87. Google Earth (2009). [online]. Available: earth.google.co.uk (Accessed on 2 January 2009).
88. Grell, G.A., Dudhia, J. and Stauffer, D. (1994) *A Description of the Fifth-Generation Penn State/NCAR Mesoscale Model (MM5)*. NCAR Technical Note TN-398+STR, National Centre for Atmospheric Research, Boulder, CO.
89. Grimme, F.W., and Laar, M. (2005). *Solar Radiation and Orientation as a key Information for Bio Climatic Design*. Available: <http://www.tt.fh-koeln.de/publications/ittpub300102.pdf#page=31> (Accessed 8 September 2005).
90. Grimmond, C.S.B, Potter, S.K., Zutter, H.N. and Souch, C. (2001). Rapids method to estimate sky-view factors applied to urban areas. *International Journal of Climatology*, 21(7), 903-913.
91. Gross, G. (1991). *Anwendungsmöglichkeiten mesoskaliger Simulationsmodelle dargestellt am Beispiel Darmstadt. Teil 1 Wind und Temperaturfelder*. *Meteorol. Rundschau*, 43: 267-274.
92. Gulyas, A., Unger, J., Matzarakis, A. (2006). Assessment of the microclimatic and human comfort conditions in a complex urban environment: modeling and measurements. *Building and Environment*, 41, 1713-1722.

93. Hamdi, R. and Schayes, G. (2007). Sensitivity study of the urban heat island intensity to urban characteristics. *International Journal of Climatology*, 28, 973-982.
94. Heisler, G.M. (1985). Effects of individual trees on the solar radiation climate of small buildings. *Elsevier Science Publishers*, 9, 337-359.
95. Höppe, P. (1999). The physiological equivalent temperature – a universal index for the biometeorological assessment of the thermal environment. *International Journal of Biometeorology*, 43, 71-75.
96. Howard, L. (1833). *The climate of London: Deduced from meteorological observations made in the metropolis and at various places around it*. Harvey and Darton, London.
97. Huang, L., Li, J., Zhao, D. and Zhu, J. (2008). A fieldwork study on the diurnal changes of urban microclimate in four types of ground cover and urban heat island of Nanjing, China. *Building and Environment*, 43(1), 7-17.
98. Huang, Y.J., Akbari, H. and Taha, H.G. (1990). The wind shielding and shading effects of trees on residential heating and cooling requirements. *ASHRAE Transactions*, American Society of Heating, Refrigeration and Air-Conditioning Engineers, Atlanta, GA, USA.
99. Hutcheon, R.J., Johnson, R.H., Lowry, W.P., Black, C.H. and Hadlet, D. (1967). Observations of the urban heat island in a small city. *Bulletin of the American Meteorological Society*, 48(1), 7-9.
100. Hwang, R.L., Lin, T.P. (2007). Thermal comfort requirements for occupants of semi-outdoor and outdoor environments in hot-humid regions. *Architectural Science Review*, 50(4), 357-364.
101. Ichinose, T., Shomodozono, K. and Hanaki, K. (1999). Impact of anthropogenic heat on urban climate in Tokyo. *Atmospheric Environment*, 33, 3897-3909.
102. Imran, M. And Barnes, P. (1990). *Energy demand in the developing countries: Prospects for the future*, World Bank Staff Commodity Working Paper No. 23, The World Bank, Washington, D.C., USA.
103. ISO 7730. (2005). *Ergonomics of the thermal environment: Analytical determination and interpretation of thermal comfort using calculation of the PMV and PPD indices and local thermal comfort criteria*. International Standard Organization for Standardisation, Geneva, Switzerland.
104. Jacobs, A.F.G., Ronda, R.J. and Holtslag, A.A.M. (2003) Water vapour and carbon dioxide fluxes over bog vegetation. *Agric For Meteorology*, 116 (1-2), 103-12.

105. Jahi, J.M. (1974). *Analisa suhu dan kelembapan bandingan di Kuala Lumpur dengan tumpuan khas kepada pengaruh pulau haba* (Temperature analysis and relative humidity with special reference to heat island influences). Unpublished Undergraduate dissertation, Geography Department, Universiti Kebangsaan Malaysia, Malaysia.
106. Jauregui, E. (1990/91). Influence of a large urban park on temperature and convective precipitation in a tropical city. *Energy and Buildings*, 15(3-4), 457-463.
107. Jauregui, E. (1997). Heat island development in Mexico City. *Atmospheric Environment*, 31(22), 3821-3831.
108. Jauregui, E. and Romales, E. (1996). Urban effects on convective precipitation in Mexico City. *Atmospheric Environment*, 30(20), 3383-3389.
109. Jauregui, E., Godinez, L. and Cruz, F. (1992). Aspects of heat-island development in Guadalajara, Mexico. *Atmospheric Environment. Part B. Urban Atmosphere*, 26(3), 391-396.
110. Johansson, E. (2006). Influence of urban geometry on outdoor thermal comfort in a hot dry climate: a study in Fez, Morocco. *Building and Environment*, 41, 1326-1338.
111. Johnson, H., Kovats, R.S., McGregor, G., Stedman, J., Gibbs, M., Walton, H., Cook, L. and Black, E. (2005). The impacts of the 2003 heat wave on mortality and hospital admissions in England. *Health Statistics Quarterly*, (25).
112. Jonckheere, I., Fleck, S., Nackaerts, K., Muys, B., Coppin, P., Weiss, M. and Baret, F. (2004). Review of methods for in situ leaf area index determination: part I. Theories, sensors and hemispherical photography. *Agric For Meteorology*, 121(1-2), 19-35.
113. Jones, H.G. (1991). *Plants and Microclimate* (2nd ed.). Cambridge University Press, Cambridge, United Kingdom.
114. Jones, P.J. and Alexander, D.K. (1999). *Modelling building performance*. Proceedings in the 3rd International Symposium on Heating, Ventilation and Air Conditioning, Shenzhen, China.
115. Kamaruzzaman, S. and Mohd Yusof, O. (1992). Estimates of monthly average daily global solar radiation in Malaysia. *Renewable Energy*, 2(3), 319-325.
116. Karaca, M., Tayanc, M. and Toros, H. (1995). Effects of urbanization on climate of Istanbul and Ankara. *Atmospheric Environment*, 29(23), 3411-3421.
117. Katzshner, L., Bosch, U. and Roettgen, M. (2004). *Thermal Comfort Mapping and Zone*, RUROS, Fifth Framework Programme 1998-2000, Key Action 4 "City of Tomorrow and Cultural Heritage" from the programme 'Energy, Environment and Sustainable Development'.

118. Kawashima S. (1994). Relation between vegetation, surface temperature, and surface composition in the Tokyo region during winter. *Remote Sensing Environment*, 50, 52-60.
119. Kawashima, S. (1990/91). Effect of vegetation on surface temperature in urban and suburban areas in winter. *Energy and Buildings*, 15-16, 465-469.
120. Kim, Y. and Baik, J. (2005). Spatial and temporal structure of the urban heat island in Seoul. *Journal of Applied Meteorology*, 44, 591-605.
121. Kjelgren, R. and Montague, T. (1998). Urban tree transpiration over turf and asphalt surfaces. *Atmospheric Environment Conference on the Benefits of the Urban Forest*, 32(1), 35-41.
122. Klysiak, K. and Fortuniak, K., (1999). Temporal and spatial characteristics of the urban heat island of Lodz, Poland. *Atmospheric Environment*, 33(3), 3885-3895.
123. Koenigsberger. O.H., Ingersoll, T.G., Mahyew, A. and Szololay, S.V. (1973). *Manual of tropical housing and building. Part 1: climatic design*. Longman, London.
124. Konya, A. (1980). *Design primer for hot climates*. The Architectural Press Ltd., London.
125. Kotzen, B. (2003). An investigation of shade under six different tree species of the Negev Desert towards their potential use for enhancing micro-climatic conditions in landscape architectural development. *Journal of Arid Environments*, 55, 231-274.
126. Krisnan, G. (2007). Putrajaya is 5°C hotter than other local cities. In: The Star Online, Malaysia [Online]. Available: <http://thestar.com.my/metro/story.asp?file=/2007/6/19/central/17992083&sec=central> (Accessed 30 January 2008).
127. Krüger, E., Pearlmutter, D. and Rasia, F. (2009). Evaluating the impact of canyon geometry and orientation on cooling loads in a high-mass building in a hot dry environment. *Applied Energy*. doi:10.1016/j.apenergy.2009.11.034.
128. Kurn, D.K., Bretz, S.E. and Akbari, H. (1994). *The potential for reducing urban air temperatures and energy consumption through vegetative cooling*. In proceedings of the 1994 Summer Study on energy Effects in Buildings, Pacific Grove, California, USA.
129. Lalic, B. and Mihailovic, D.T. (2004). An empirical relation describing leaf area density inside the forest for environmental modelling. *Journal of Applied Biometeorology*, 43, 641-645.
130. Landsberg, H.E. (1981). *The Urban Climate*. Academic Press, New York, USA.

131. Launder, B. and Spalding, D.B. (1974). The numerical computation of turbulent flow. *Computer Methods in Applied Mechanics and Engineering*, 3, 269-289.
132. Law, B.E., Cescatti, A. and Baaldocchi, D.D. (2001). Leaf area distribution and radiative transfer in open-canopy forests: implication for mass and energy exchange. *Tree Physiology*, 21(12-13), 777-787.
133. Lewis, J.E. (1971). Some effects of urban morphology on street level temperatures at Washington, D.C. *Journal of the Washington Academy of Science*, 61, 258-265.
134. Li, Q., Jones, P. and Lannon, S. (2007). *Planning sustainable in Chinese cities: Dwelling types as a means to accessing potential improvements in energy efficiency*. In proceedings of the Tenth International Conference of the International Building Performance Simulation (IBPSA), Beijing, China.
135. Li-Cor, I. (1992). *LAI-2000 Plant Canopy Analyzer Operating Manual*. Nebraska, USA.
136. Lim, G.E. (1980). *Pulau haba bandar dan aplikasinya terhadap kajian pencemaran udara di Georgetown, Pulau Pinang* (Urban heat island and its implication to pollution studies in Georgetown, Penang). Unpublished undergraduate dissertation, Department of Geography, Universiti Kebangsaan Malaysia, Malaysia.
137. Lin, T.P. and Matzarakis, A. (2008). Tourism climate and thermal comfort in Sun Moon Lake, Taiwan. *International Journal of Biometeorology*, 52, 281-290.
138. Lin, T.P., Matzarakis, A. and Huang, J.J. (2006). *Thermal comfort and passive design of bus shelters*. In proceedings of The PLEA2006 - The 23rd Conference on Passive and Low Energy Architecture, Geneva.
139. Lin, T.P., Matzarakis, A. and Hwang, R.L. (2010). Shading effect on long-term outdoor thermal comfort. *Building and Environment*, 45, 213-221.
140. Liu, J., Chen, J.M., Black, T.A. and Novak, M.D. (1996) E- ϵ modeling of turbulent air floe downwind of a model forest edge. *Boundary-Layer Meteorology*, 77, 21-44.
141. Lomas, K.J., Eppel, H., Martin, C.J. and Bloomfield, D.P. (1997) Empirical validation of building energy simulation programmes. *Energy and Building*, 26, 253-273.
142. Lyall, I.T. (1977). The London heat-island in June-July 1976. *Weather*, 32(8), 296-302.
143. Maerschack, B.E., Janssen, S., Vankerkom, J., Mensink, C., den Burg, A.V and Fortuin P. (2008). *CFD simulations of the impact of a line vegetation element along a motorway on local air quality*. In proceedings of The 12th International Conference on

- Harmonisation within Atmospheric Dispersion Modelling for Regulatory Purposes, 7 October 2008, Croatia.
144. Magee, N., Curtis, J. and Wendler, G. (1999). The urban heat island effect at Fairbank, Alaska. *Theoretical and Applied Climatology*, 64, 39-47.
 145. Malaysian Meteorological Department. (2010). Climate of Malaysia [online]. <http://www.met.gov.my/>. (Accessed 12 January 2010).
 146. Markus, T.A. and Morris, E.N. (1980). *Building, Climate and Energy*. Pitman, London.
 147. Masmoudi, S. and Mazouz, S. (2004). Relation of geometry, vegetation and thermal comfort around buildings in urban settings, the case of hot arid regions. *Energy and Buildings*, 36, 710-719.
 148. Matzarakis, A. (2001). *Estimation and calculation of the Mean Radiant Temperature within Urban Structures*. [online]. Available: <http://www.mif.uni-freiburg.de/rayman.description.htm> (Accessed 8 January 2009).
 149. Matzarakis, A. (2007). *Climate, thermal comfort and tourism*. In proceedings of Climate Change and Tourism – Assessment and Coping Strategies Conference.
 150. Matzarakis, A. and Mayer, H. (1996). Another kind of environmental stress: thermal stress. WHO Collaborating Centre for Air Quality Management and Air Pollution Control. *NEWSLETTERS*, 18, 7-10.
 151. Matzarakis, A., Mayer, H. and Izioman, M.G. (1997). Application of a universal thermal index: physiological equivalent temperature. *International Journal of Biometeorology*, 43, 76-84.
 152. Matzarakis, A., Mayer, H. and Rutz, F. (2002). *Radiation and thermal comfort*. 6th Hellenic Conference in Meteorology, Climatology and Atmospheric Physics, Ioannina, 2, 739-744.
 153. Matzarakis, A., Rutz, F. and Mayer, H. (1999). *Estimation and calculation of the mean radiant temperature within urban structures*. In de Dear, R.J., Kalma, J.D., Oke, T.R. and Auliciems, A., eds. *Biometeorology and Durban climatology at the turn of the millennium. Selected papers from the ICB-ICUC '99 conference*, Sydney, WCASP-50, WMO/TD 1026. World Meteorological Organization, Geneva.
 154. Matzarakis, A., Rutz, F. and Mayer, H. (2007). Modelling radiation fluxes in simple and complex environments – application of the RayMan model. *International Journal of Biometeorology*, 51, 323-334.
 155. McPherson, E.G. and Sacamano, P.L. (1992). *Energy savings with trees in Southern California*. Technical Report US Department of Agriculture. Forest Service, Pacific

Southwest research Station, Western Center for Urban Forest Research, Davis, California, USA.

156. Meir, P., Grace, J., and Miranda, A.C. (2000). Photographic method to measure the vertical distribution of leaf area density in forests. *Agric for Meteorol*, 102(2-3), 105-111.
157. Mellor, G.L. and Yamada, T. (1975). A simulation of the Wangara atmospheric boundary layer data. *J. Atmos. Sci.*, 32, 2309-2329.
158. Memon, R.A., Leung D.Y.C., Liu C.H. (2010). Effects of building aspect ratio and wind speed on air temperatures in urban-like street canyons. *Building and Environment*, 45, 176-188.
159. Michaels, J. (2009). Study links tornadoes to urban heat island effect. Reported in meteorology news 2009 [online]. Available: <http://www.meteorologynews.com/2009/03/19/> (Accessed 23 March 2010).
160. Mifflin, H., (2009). *The American heritage® dictionary of the English language, 4th Edition copyright ©2000*. Houghton Mifflin Company, USA.
161. Miller, R.W. (1988). *Urban forestry: Planning and managing urban green spaces*. Prentice-Hall, Englewood Cliffs, N.J, USA.
162. MMD (2010). Malaysia Meteorological Department, Meteorological databases, Malaysia.
163. Mochida, A., Murakami, S., Ojima, T., Kim, S., Ooka, R. and Sugiyama, H. (1997). CFD analysis of mesoscale climate in the Greater Tokyo area. *Journal of Wind Engineering and Industrial Aerodynamics Computational Wind Engineering*, 67-68, 459-477.
164. Moffat, A. and Schiler, M. (1981). *Landscape design that saves energy*. William Morrow and Company, New York, USA.
165. Monteiro, C.A.F. (1986). *Some aspects of the urban climates of tropical South America: The Brazilian contribution*. In proceedings of Technical Conference in Mexico City: Urban Climatology and its Applications with Special Regard to Tropical Areas, WMO, 652, 166-198.
166. Montes, F., Pita, P., Rubio, A. and Canellas, I. (2007). Leaf area index estimation in mountain even-aged *Pinus silvestris* L. stands from hemispherical photographs. *Agric For Meteorol*, 145(3-4), 215-28.

167. New York State Energy Research and Development Authority (2006). *Mitigating New York City's heat island with urban forestry, living roofs, and light surfaces*. New York City Regional Heat Island Initiative, Final Report 06-06, October 2006.
168. Nichol, J.E. (1996a). High-resolution surface temperature patterns related to urban morphology in a tropical city: a satellite-based study. *Journal of Applied Meteorology*, 35(1), 135-146.
169. Nichol, J.E. (1996b). Analysis of the urban thermal environment with LANDSAT data. *Environmental and Planning B*, 23, 733-747.
170. Nicol, J.F. (1974). An analysis of some observations of thermal comfort on Roorkee, India, and Baghdad, Iraq. *Annals of human Biology*, 4, 411-426.
171. Nieuwolt, S. (1966). The urban microclimate of Singapore. *Journal of Tropical Geography*. 22, 30-37.
172. Nikolopoulou, M. (1998). *Thermal comfort in outdoor urban spaces*. PhD. Dissertation, Department of Architecture, University of Cambridge, Cambridge, United Kingdom.
173. Nikolopoulou, M. (ed.) (2004). *Designing open space in the urban environment: A bioclimatic approach*. RUROS project, Centre of Renewable Energy Sources, Athens, Greece.
174. Nikolopoulou, M. and Lykoudis, S. (2006). Thermal comfort in outdoor urban spaces: analysis across different European countries. *Building and Environment*, 41, 1455-1470.
175. Nikolopoulou, M. and Steemers, K. (2003). Thermal comfort and physiological adaptation as a guide for designing urban spaces. *Energy and Buildings*, 35, 95-101.
176. Nikolopoulou, M., Baker, N., Steemers, K. (2001). Thermal comfort in outdoor urban spaces: understanding the human parameter. *Solar Energy*, 70, 227-235.
177. Oke, T.R (1982). The energetic basis of urban heat island. *Quarterly Journal of the Royal Meteorological Society*, 108(455), 1-24.
178. Oke, T.R. (1973). City size and urban heat island. *Atmospheric Environment*, 7, 769-779.
179. Oke, T.R. (1978). *Boundary Layer Climates*. Methuen & Co Ltd., London.
180. Oke, T.R. (1981). Canyon geometry and the nocturnal urban heat island: Comparison of a scale model and field observations. *Journal of Climatology*, 1, 237-254.
181. Oke, T.R. (1988). Street design and urban canopy layer climate. *Energy and Buildings*, 7, 769-779.

182. Oke, T.R. (1989). The micrometeorology of the urban forest. *Philosophical Transactions of Royal Society of London B*, 324, 335-350.
183. Oke, T.R. (1995). The heat island of the urban boundary layer: Characteristics, causes and effects. In *Wind climate in cities*. In Cermak, J.E. et. al. (Eds.), 81-107. Kluwer Academic Publishers.
184. Oke, T.R. (1999). *City size and the urban heat island*. Paper presented at the 15th International Congress of Biometeorology & International Conference on Urban Climatology, 8-12 November 1999, Sydney, Australia.
185. Oke, T.R., Johnson, G.T., Steyn, D.G. and Watson, I.D. (1991). Simulation of surface urban heat islands under 'ideal' conditions at night – part 2: Diagnosis and causation. *Boundary Layer Meteorology*, 56, 339-358.
186. Outcalt, S.I. (1972). A reconnaissance experiment in mapping and modeling the effect of land use on urban thermal regimes. *Journal of Applied Meteorology*, 11, 1369-1373.
187. Padmanabhamurthy, B. (1990/91). *Microclimates in tropical urban complexes*. Paper presented at the Technical Conference in Mexico City: Urban Climatology and its Applications with Special Regard to Tropical Areas.
188. Paltridge, G.W. and Platt, C.M.R. (1976). *Radiative processes in meteorology and climatology*. Elsevier, New York.
189. Papadakis, G., Tsamis, P. and Kyritsis, S. (2001). An experimental investigation of the effect of shading with plants for solar control of buildings. *Energy and Buildings*, 33(8), 831-836.
190. Park, C. (2005). A dictionary of environment and conservation. Oxford University Press, 2007. Oxford Reference Online. Cardiff University. Available: <http://www.Oxfordreference.com/views/ENTRY.html?subview=Main&entry=t244.e3655> (Accessed 27 March 2008).
191. Parker, J.H. (1983). Landscaping to reduce the energy used in cooling buildings. *Journal of Forestry*, 81(2), 82-83.
192. Parker, J.H. (1987). The use of shrubs in energy conservation plantings. *Landscape Journal of Forestry*, 6, 132-139.
193. Pease, R.W., Lewis, J.E. and Outcalt, S.I. (1976). Urban terrain climatology and remote sensing. *Annals of the Association of American Geographers*, 66(4), 89-90.
194. Picot, X. (2004). Thermal comfort in urban spaces: Impact of vegetation growth case study: Piazza Della Scienza, Milan, Italy. *Journal of Energy*, 36, 329-334.

195. Pierce, L. and Running, W. (1988). Rapid estimation of coniferous forest leaf area index using a portable integrating radiometer. *Ecology*, 69(6), 1762-1767.
196. Plumley, H.J. (1977). *Design of outdoor spaces for thermal comfort*. Proceedings of a Conference on the Metropolitan Physical Environment, Syracuse, N.Y., 25-29 August 1975, USDA Forest Service Technical Report NE-25, Upper Darby, Pa.: North-eastern Forest Experiment Station, 152-162.
197. Pokorny, J. (2001). Dissipation of solar energy in landscape – controlled by management of water and vegetation. *Renewable Energy*, 24, 641-645.
198. PPJ (1999). Irrigation Master Plan for Putrajaya Final Report Volume II. Putrajaya, Malaysia.
199. PPJ (2008). Putrajaya Annual Report 2008. Perbadanan Putrajaya, Putrajaya, Malaysia.
200. Rao, M.N. (1952). Comfort range in tropical Calcutta. A preliminary experiment. *Indian Journal of Medical Research*, 40, 45.
201. Robinette, G.O. (1968). *Plants, people and environmental quality*. U.S. Department of the Interior, Washington D.C, USA.
202. Rose, L.S., Akbari, H. and Taha, H. (2003) *Characterizing the fabric of the urban environment: A case study of Greater Houston, Texas..* Lawrence Berkeley National Laboratory, 61, Berkeley, CA, USA.
203. Rosenfeld, A., Romm, J., Akbari, H. And Lyold (1998). Painting the town white and green. Available through the website of Lawrence Berkeley Laboratory: <http://www.lbl.gov> (Accessed 16 June 2010)
204. Rosenfeld, A.H., Akbari, H., Bretz, S., Fishman, B.L, Kurn, D.M, Sailor, D. and Taha, H. (1995). Mitigation of urban heat islands: materials, utility programs, updates. *Energy and Buildings*, 22(3), 255-265.
205. Roth, M. (2002). *Effects of cities on local climates*. Paper presented at the Workshop of IGES/APN Mega-City Project, 23-25 January 2002, Kitakyushu, Japan.
206. Russell, T., Cultler, C. and Walters, M. (2006). *Trees of the World: Illustrated Encyclopaedia and Identifier*. Hermes House, London.
207. Sailor, D. (2003). *Streamlined mesoscale modelling of air temperature impacts of heat island mitigation strategies*. Mechanical Engineering, Tulane University, New Orleans, LA, USA.
208. Sailor, D.J. and Dietsch, N. (2007). The urban heat island Mitigation Impact Screening Tool (MIST). *Environmental Modeling & Software*, 22, 1529-1541.

209. Saito, I. (1990/91). Study of the effect of green areas on the thermal environment in an urban area. *Energy and Buildings*, 15-16, 493-498.
210. Sakakibara, Y. (1996). A numerical study of the effect of urban geometry upon the surface energy budget. *Atmospheric Environment*, 30(3), 487-496.
211. Santamouris, M. (ed.) (2001). *Energy and Climate in the Urban Built Environment*. James & James (Science Publishers) Ltd., United Kingdom.
212. Santamouris, M., Argiriou, A. and Papanikolaou, N. (1996). *Meteorological stations for microclimatic measurements*. Report to the POLIS project, Commission of the European Communities, Directorate General for Science Research and Technology.
213. Santamouris, M., Papanikolaou, N., Livada, I., Koronakis, I., Georgakis, C., Argiriou, A. and Assimakopoulos, D.N. (2001). On the impact of urban climate on the energy consumption of buildings. *Solar Energy*, 70(3), 201-216.
214. Schmidt, N. (1979). *Desert animals - physiological problems of heat and water*. Dover Publication, New York, USA.
215. Scott, K.I., Simpson, J.R. and McPherson, E.G. (1999). Effects of tree cover on parking lot microclimate and vehicle emissions. *Journal of Arboriculture*, 3, 129-142.
216. Scudo, G. (2002). *Thermal comfort in green spaces*. In proceedings of The Green Structures and Urban Planning Conference, Milan, Italy, October 2002.
217. Shaharuddin, A. (1992). Some effects of urban parks on air temperature variations in Kuala Lumpur, Malaysia. In Katayama and Tsutsumi (eds.) proceedings of the Second Tohwa University International Symposium on Urban Thermal Environment (CUTEST '92), 7-10 September, Tohwa University, Fukuoka, Japan. 107-108.
218. Shaharudin A. (1994). *The diurnal variation of rainfall and urban development in Kuala Lumpur* (in Malay). Paper presented at the National Seminar of the Malaysia Association of Geography, 17-19 August, Science University of Penang.
219. Shahidan, M.F. (2008). *Effectiveness of Mesua Ferrea L. And Hura Crepitans L. as thermal radiation filters in outdoor environment*. Unpublished MSc. thesis, Universiti Putra Malaysia, Selangor, Malaysia.
220. Shahidan, M.F. and Jones, P. (2008) *Plant canopy design in modifying urban thermal environment: theory and guidelines*. In the 25th conference on passive and low energy architecture, Dublin.
221. Shahidan, M.F., Salleh, E. and Shariff, M.K.M. (2007). *Effects of tree canopies on solar radiation filtration in a tropical microclimatic environment*. In proceedings of the

- PLEA2007 - The 24th Conference on Passive and Low Energy Architecture, 22-24 November 2007, Singapore.
222. Shahidan, M.F., Shariff, M.K.S, Jones, P., Salleh, E. and Abdullah, A.M. (2010). A comparison of *Mesua ferrea* L. and *Hura crepitans* L. for shade creation and radiation modification in improving thermal comfort. *Landscape and Urban Planning*, 97, 168-181.
 223. Sham, S. (1972). Monthly and seasonal rainfall at Tangling Hospital, Kuala Lumpur (1879-1964): An analysis using normal. *Nusantara*, 1, 93-99.
 224. Sham, S. (1973). The urban heat island: Its concepts and application to Kuala Lumpur. *Sains Malaysiana*, 2(1), 53-64.
 225. Sham, S. (1984). Urban development and changing patterns of night-time temperatures in Kuala Lumpur-Petaling Jaya area, Malaysia. *Jurnal Teknologi*, 5, 21-36.
 226. Sham, S. (1986). *Temperatures in Kuala Lumpur and the Merging Klang Valley Conurbation, Malaysia*. Report prepared for UNESCO under the Ecoville Project, Institute of Advanced Studies, University of Malaya, Malaysia.
 227. Sham, S. (1987). *Urbanization and the atmospheric environment in the low tropics: experiences for the Klang Valley Region, Malaysia*. Bangi, UKM Press, Malaysia.
 228. Sham, S. (1990/91). Urban Climatology in Malaysia: An Overview. *Energy and Buildings*, 15-16, 105-117.
 229. Shashua-Bar, L, Swaid, H. and Hoffman, M.E. (2004). On the correct specification of the analytical CTTC model for predicting the urban canopy layer temperature. *Energy and Buildings*, 36, 975-978.
 230. Shashua-Bar, L. and Hoffman, M.E. (2000). Vegetation as a climatic component in the design of an urban street: An empirical model for predicting the cooling effect of urban green areas with trees. *Energy and Buildings*, 31(3), 221-235.
 231. Shashua-Bar, L., Pearlmutter, D. and Erell, E. (2009). The cooling efficiency of urban landscape strategies in a hot dry climate. *Landscape and Urban Planning*, 92, 179-186.
 232. Shlyakhter, I., Rozenoer, M., Dorsey, J. and Teller, S. (2001). Reconstructing 3D tree models from instrumented photographs. *IEEE Computer Graphics and Applications*, 1-9.
 233. Simpson, J.R. (2002). Improved estimates of tree-shade effects on residential energy use. *Energy and Buildings*, 34(10), 1067-1076.

234. Simpson, J.R., McPherson, E.G. and Rowntree, R. (1994). *Potential of tree shade for reducing building energy use in the PG and E Service Area*. Final Report to Pacific Gas and Electric Company, San Francisco, California, USA.
235. Sin H.T. and Chan A.W. (2004). *The urban heat island phenomenon in Penang Island: Some observations during the wet and dry season*. In Jahi, J.M., Kadi, A., Salmiah, S. and Shaharuddin, I. (eds) proceedings in 2nd. Bangi World Conference on Environmental Management: Facing Changing Conditions. 13-14 September 2004. Bangi, Malaysia. 504-516.
236. Solecki, W.D., Rosenzweig, C., Parshall, L., Pope, G., Clark, M., Cox, J., et al. (2005). Mitigation of the heat island effect in urban New Jersey. *Global Environmental Change Part B: Environmental Hazards*, 6(1), 39-49.
237. Spagnolo, J. and de Dear, R.J. (2003). A field study of thermal comfort in outdoor and semi-outdoor environments in subtropical Sydney, Australia. *Building and Environment*, 38, 721-738.
238. Spangenberg, J., Shinzato, P., Johansson, E. and Duarte, D. (2008). *Simulation of the influence of vegetation on microclimate and thermal comfort in the city of Sao Paulo*. In Rev. SBAU, Piracicaba, 3(2), 1-19.
239. Spronken-Smith, R.A. and Oke, T.R. (1998). The thermal regime of urban parks in two cities with different summer climates. *International Journal of Remote Sensing*, 19(11), 2085-2104.
240. Stadt, K.J., and Lieffers, V.J. (2000). MIXLIGHT: a flexible light transmission model for mixed-species forest stands. *Agricultural For Meteorology*, 43(4), 641-645.
241. Staoutjesdijk, P.H. and Barkman, J.J. (1992). *Microclimate, vegetation and Fauna*. Knivsta: OPULUS Press AB.
242. Stark, T.F. and Miller D.R. (1977). *Effect of synthetic surface and vegetation in urban areas on human energy balance and comfort*. In proceedings of a Conference on the Metropolitan Physical Environment, Syracuse, N.Y., USDA Forest Service Technical Report NE-25, Upper Darby, Pa.: North-eastern Forest Experiment Station, 139-151, 25-29 August 1975.
243. Steven, M.D., Biscoe, P.V., Jaggard, K.W. and Paruntu, J. (1986). Foliage cover and radiation interception. *Elsevier Science Publishers*, 75-87.
244. Stewart, I.D. (2000). Influence of meteorological conditions on the intensity and form of the urban heat island in Regina. *The Canadian Geographer* 44(3), 271-285.

245. Streutker, D.R. (2003). Satellite-measured growth of the urban heat island of Houston, Texas. *Remote Sensing of Environment*, 85(3), 282-289.
246. Svensson, M.K. (2004). Sky view factor analysis - Implications for urban air temperature differences. *Meteorology Applications*, 11(3), 201-211.
247. Swaid H., Bar-El, M and Hoffman, M.E. (1993). A bioclimatic design methodology for urban outdoor spaces. *Theoretical and Applied Climatology*, 48, 49-61.
248. Swaid, H. and Hoffman, M.E. (1990). Prediction of urban air temperature variations using the Analytical CTTC Model. *Energy and Buildings*, 14(4), 313-324.
249. Szokolay, S.V. (2004). *Introduction to architectural science: The basis of sustainable design*. Great Britain: Architectural Press and Elsevier Science.
250. Taesler, R. and Anderson, C. (1984). A method for solar radiation computing using routine meteorological observations. *Energy and Buildings*, 7, 341-352.
251. Taha, H. (1988). Site specific heat island simulations: Model development and application to microclimate conditions'. Lawrence Berkeley Laboratory Report No 26105; M. Geogr. Thesis, university of California, Berkeley, CA, USA.
252. Taha, H. (1994). Meteorological and photochemical simulations of the south coast air basin. In Taha, H. (ed.), Analysis of energy efficiency of air quality in the south coast air basin – Phase II, Rep. No LBL-35728, 6, 161-218. Lawrence Berkeley Laboratory, Berkeley CA., USA.
253. Taha, H. (1997). Urban climates and heat islands: albedo, evapotranspiration, and anthropogenic heat. *Energy and Buildings*, 25(2), 99-103.
254. Taha, H. (2005). *Urban surface modification as a potential ozone air-quality improvement strategy in California. Phase one: Initial mesoscale modelling*. California Energy Commissions, Sacramento, CA., USA.
255. Taha, H., Sailor, D. and Akbari, H. (1992). *High albedo materials for reducing cooling energy use*. Lawrence Berkeley Laboratory Report 31721, UC-350, Berkeley, CA.
256. Takahashi, K., Yoshida, H., Tanaka, Y., Aotake, N. and Wang, F. (2004). Measurement of thermal environment in Kyoto city and its prediction by CFD simulation. *Energy and Buildings*, 36(8), 771-779.
257. Terjung, W.H. and Louie, S.S.F. (1973). Solar radiation and urban heat islands. *Annals of the Association of American Geographers*, 63, 181-207.
258. Tjernstorm, M. (1989). Some tests with a surface energy balance scheme including a bulk parameterization for vegetation in a mesoscale model. *Boundary Layer Meteorology*, 48, 33-68.

259. Toudert, A. and Mayer, H. (2006). Numerical study on the effects of aspect ratio and orientation of an urban street canyon on outdoor thermal comfort in hot and dry climate, *Building and Environment*, 41, 94-108.
260. Toudert, A. and Mayer, H. (2007). Effects of asymmetry, galleries, overhanging facades and vegetation on thermal comfort in urban street canyons. *Solar Energy*, 81, 742-754.
261. Tran, H., Uchihama, D., Ochi, S. and Yasuoka, Y. (2006). Assessment with satellite data of the urban heat island effects in Asian mega cities. *International Journal of Applied Earth Observation and Geoinformation*, 8(1), 34-48.
262. Tso, C.P. (1996). A survey of urban heat island studies in two tropical cities. *Atmospheric Environment*, 30(3), 507-519.
263. Tukainen, M. (2010). Sunrise, sunset, dawn and dusk times around the World, Gaisma [online]. Available: <http://www.gaisma.com/en/location/kuala-lumpur.html> (Accessed 19 August 2010).
264. U.S. Department of Energy (2010). Building Technologies Program [online]. Available: http://apps1.eere.energy.gov/buildings/tools_directory/alpha_list.cfm (Accessed on 29 March 2010)
265. Unger, J., Sumenghy, Z. and Zoboki, J. (2001). Temperature cross-section features in an urban area. *Atmospheric Research*, 58, 117-127.
266. VDI (1998). *Methods for the human biometeorological evaluation of climate and air quality for the urban and regional planning*. Part I: climate. VDI guideline 3787, Part 2. Berlin: Beuth.
267. Velazquez-Lozada, A., Gonzalez, J.E. and Winter, A. (2006). Urban heat island effect analysis for San Juan, Puerto Rico. *Atmospheric Environment*, 40(9), 1731-1741.
268. Víctor L.B., Adalberto, T. and Ernesto, J. (1999). Energy balance measurements in a suburban vegetated area in Mexico City. *Atmospheric Environment*, 33, 24-25.
269. Voogt, J.A. and Oke, T.R. (1997). Complete urban surface temperatures. *Journal of Applied Meteorology*, 36, 1117-1132.
270. Voogt, J.A. and Oke, T.R. (2003). Thermal remote sensing of urban climates. *Remote Sensing of Environment Urban Remote Sensing*, 86(3), 370-384.
271. Watkins, R., Littlefair, P., Kolokotroni, M. and Palmer, J. (2002). *The London heat island – surface and air temperature measurements in a park and street gorges*. ASHRAE winter meeting, Atlantic City, GA, USA.

272. Watkins, R., Palmer, J. and Kolokotroni, M. (2007). Increased temperature and intensification of the urban heat island – implications for human comfort and urban design, *Built Environment*, 33,(1), 85-96.
273. Webb, C.G. (1959). An analysis of some observations of thermal comfort in an Equatorial climate. *British Journal of Industrial Medicine*, 16, 297.
274. Williamson, T.J. and Erell, E. (2001). *Thermal performance simulation and the urban microclimate: Measurement and prediction*. In proceedings of the Seventh International Conference of the International Building Performance Simulation (IBPSA), Rio de Janeiro, Brazil, August 13-15 2001.
275. Wilmers, F. (1990/91). Effects of vegetation on urban climate and buildings. *Energy and Buildings*, 15-16, 507-514.
276. Wilson, J.D. (1988). A second-order closure model for flow through vegetation. *Boundary-Layer Meteorology*, 42, 371-392.
277. WMO (1986). Report of the Technical Conference on Tropical Urban Climates. WMO, Dhaka, Senegal.
278. Wong, N.H. (2002). Study on the urban heat island in Singapore. National University of Singapore, Singapore
279. Wong, N.H. and Yu, C. (2005). Study of green areas and urban heat island in a tropical city. *Habitat International*, 29(3), 547-558.
280. Wong, N.H. and Yu, C. (2009). *Tropical urban heat islands: Climate, buildings and greenery*. Taylor and Francis, New York, USA.
281. Wong, N.H., Kardinal Jusuf, S., Aung La Win, A., Kyaw Thu, H., Syatia Negara, T. and Xuchao, W. (2007). Environmental study of the impact of greenery in an institutional campus in the tropics. *Building and Environment*, 42(8), 2949-2970.
282. Xian, G. (2007). Satellite remotely-sensed land surface parameters and their climatic effects for three metropolitan regions. *Advances in Space Research*, In press, corrected proof.
283. Yague, C., Zurita, E. and Martinez, A. (1991). Statistical analysis of the Madrid urban heat island. *Atmospheric Environment. Part B. Urban Atmosphere*, 25(3), 327-332.
284. Yamada, T. (1982). A numerical study of turbulent air flow in and above a forest canopy. *J. Meteorolol. Soc. Japan*, 60, 439-454.
285. Yassen, M.E. (2001). *Rainfall variations and trends in tropical urban city. A case of Kuala Lumpur and Petaling Jaya*. Proceedings SEAGA 6, 2001. In proceedings of the

International Conference on Southeast Asia's Quality of Life in the New Millennium, 12-15 November 2001, Universiti Kebangsaan Malaysia, Bangi, Malaysia.

286. Yezioro, A., Dong, B. and Fernanda, L. (2008). An applied artificial intelligence approach towards assessing building performance simulation tools. *Energy and Building*, 40, 612-620.
287. Yoshida, S., Ooka, R., Mochida, A., Murakami, S. and Tominaga, Y. (2006). *Development of three dimensional plant canopy models for numerical simulation of outdoor thermal environment*. In proceedings of ICUC6 - The 6th Conference on International Climate and Urban Climatology, Sweden.
288. Yoshida, S., Ryozo, O., Akashi, M., Shuzo, M. and Yoshihide, T. (2000). Study on effect of greening on outdoor thermal environment using three dimensional plant canopy models. *Journal of Architecture, Planning, Environmental Engineering, AIJ*, 536, 87-94.
289. Yu, C. and Hien, W.N. (2006). Thermal benefits of city parks. *Energy and Buildings*, 38(2), 105-120.
290. Zainab, S. (1980). *Pulau haba dan aplikasinya terhadap keupayaan pencemaran udara di Johor Bahru, Johor* (Urban heat island and its implication to air pollution potential in Johor Bahru, Johore). Unpublished undergraduate dissertation, Geography Department, Universiti Kebangsaan Malaysia, Malaysia.

Cloud Cover Condition at 9:00 am to 18:00pm on 28th February 2009



Time: 09:00



Time: 10:00



Time: 11:00



Time: 12:00



Time: 13:00



Time: 14:00



Time: 15:00



Time: 16:00



Time: 17:00



Time: 18:00

APPENDIX 2

Database of soil types in ENVI-met. These individual soils are combined to form a 'soil profile' as shown in Appendix 3.

ID	ns	nfc	nwilt	matpot	hyr	CP	b	Hcn	Name
Natural Soils									
0	0.451	0.24	0.155	-0.478	7	1.212	5.39	0	Default Soil (loam)
sd	0.395	0.135	0.0068	-0.121	176	1.463	4.05	0	Sand
ls	0.41	0.15	0.075	-0.09	156.3	1.404	4.38	0	Loamy sand
sl	0.435	0.195	0.114	-0.218	34.1	1.32	4.9	0	Sandy loam
sl	0.485	0.255	0.179	-0.786	7.2	1.271	5.3	0	Silt loam
le	0.451	0.24	0.155	-0.478	7	1.212	5.39	0	Loam
ts	0.42	0.255	0.175	-0.299	6.3	1.175	7.12	0	Sandy clay loam
tl	0.477	0.322	0.218	-0.356	1.7	1.317	7.75	0	Silty clay loam
lt	0.476	0.325	0.25	-0.63	2.5	1.225	8.52	0	Clay loam
st	0.426	0.31	0.219	-0.153	2.2	1.175	10.4	0	Sandy clay
ts	0.492	0.37	0.283	-0.49	1	1.15	10.4	0	Silty clay
to	0.482	0.367	0.286	-0.405	1.3	1.089	11.4	0	Clay
tf	0.863	0.5	0.395	-0.356	8	0.836	7.75	0	Peat
Artificial Soils									
zb	0	0	0	0	0	2.083	0	1.63	Cement concrete
mb	0	0	0	0	0	1.75	0	2.33	Mineral concrete
ak	0	0	0	0	0	2.214	0	1.16	Asphalt (with gravel)
ab	0	0	0	0	0	2.251	0	0.9	Asphalt (with basalt)
gr	0	0	0	0	0	2.345	0	4.61	Granite
ba	0	0	0	0	0	2.386	0	1.73	Basalt
ww	0	0	0	0	0	0	0	0	Water

Key of symbols of Appendix 2:

ns	saturation water content	m^3m^{-3}
nfc	field capacity	m^3m^{-3}
nwilt	permanent wilting point	m^3m^{-3}
matpot	Matrix potential at saturated water content	m
hyr	hydraulic conductivity at saturated water content	$10^{-6}.ms^{-1}$
CP	Volumetric Heat Capacity in [Jm ⁻³ K ⁻¹]* 106	$10^6.JM^{-3}K^{-1}$
B	constant (Clapp and Hornberger 1978)	
Hcn	soil conductivity	$Wm^{-1}K^{-1}$

APPENDIX 3

Database of multilayered soils and ground material profiles in ENVI-met. Albedo and emissivity values stated are based on ENVI-met default and standard values.

Name, ID	Upper Layer							Middle Layer			Deep Layer			z ₀	a	ε _s	Name	
	5	15	25	35	50	70	90	150	250	350	450	750	1250					1750
0	le	le	le	le	le	le	le	le	le	le	le	le	le	le	0.015	0	0.98	Default Unsealed Soil
s	ab	ab	ab	ab	ab	ab	ab	ab	ab	le	le	le	le	le	0.01	0.2	0.9	Asphalt Road
p	zb	zb	zb	zb	sd	le	le	le	le	le	le	le	le	le	0.01	0.4	0.9	Pavement (Concrete)
l	le	le	le	le	le	le	le	le	le	le	le	le	le	le	0.015	0	0.98	Loamy Soil
sd	sd	sd	sd	sd	sd	le	le	le	le	le	le	le	le	le	0.05	0	0.9	Sandy Soil
w	ww	ww	ww	ww	ww	ww	ww	ww	ww	ww	ww	ww	ww	ww	0.01	0	0.96	Deep Water
kk	zz	zz	zz	sd	le	le	le	le	le	le	le	le	le	le	0.01	0.3	0.9	Brick road (red stones)
kg	zz	zz	zz	sd	le	le	le	le	le	le	le	le	le	le	0.01	0.5	0.9	Brick road (yellow stones)
gg	gr	gr	sd	le	le	le	le	le	le	le	le	le	le	le	0.01	0.3	0.9	Dark Granite Pavement
gs	gr	sd	le	le	le	le	le	le	le	le	le	le	le	le	0.01	0.4	0.9	Granite Pavement (single stones)
g2	gr	gr	sd	le	le	le	le	le	le	le	le	le	le	le	0.01	0.8	0.9	Granite shining

APPENDIX 4

Database of various vegetation types in ENVI-met

ID	Height, H	Depth, D	LAD distribution (z_p = height of the plant)										RAD (at each z_p)	Name	
			0.1 z_p	0.2 z_p	0.3 z_p	0.4 z_p	0.5 z_p	0.6 z_p	0.7 z_p	0.8 z_p	0.9 z_p	1.0 z_p			
xx	0.63	0.5	0.3	0.3	0.3	0.3	0.3	0.3	0.3	0.3	0.3	0.3	0.3	0.1	Grass 50 cm aver. dense
lg	0.18	3	0.3	0.6	0.9	1.2	1.5	1.8	2	1.5	1	0.7	0.1	luzerne 18cm	
MO	20	2	0.04	0.06	0.07	0.11	0.13	0.15	0.14	0.13	0.1	0	0.1	Tree 20m aver. dense., no distinct crown layer	
DO	20	2	0.11	0.14	0.18	0.27	0.33	0.37	0.36	0.33	0.25	0	0.1	Tree 20m dense., no distinct crown layer	
DM	20	2	0.075	0.075	0.075	0.075	0.25	1.15	1.06	1.05	0.92	0	0.1	Tree 20m dense., distinct crown layer	
dm	20	2	0.075	0.075	0.075	0.075	0.25	1.15	1.06	1.05	0.92	0	0.1	Tree 20m dense., distinct crown layer	
ds	10	2	0.075	0.075	0.075	0.075	0.25	1.15	1.06	1.05	0.92	0	0.1	Tree 10m dense., distinct crown layer	
sm	20	2	0.15	0.15	0.15	0.15	0.65	2.15	2.18	2.05	1.72	0	0.1	Tree 20m very dense, distinct crown layer	
sk	15	2	0.15	0.15	0.15	0.15	0.65	2.15	2.18	2.05	1.72	0	0.1	Tree 15m very dense, distinct crown layer	
H2	6	1	2.5	2.5	2.5	2.5	2.5	2.5	2.5	2.3	2.2	1.5	0.1	Hedge dense, 2m	
T1	10	2	0	0	2.18	2.18	2.18	2.18	2.18	2.18	1.72	0	0.1	Tree 10m very dense, leafless base	
g	0.5	0.5	0.3	0.3	0.3	0.3	0.3	0.3	0.3	0.3	0.3	0.3	0.1	Grass 50 cm aver. dense	
bs	20	2	0	0	0.005	0.075	0.25	1.15	1.06	1.05	0.92	0	0.1	Tree 20m dense., distinct crown layer	
sc	20	2	0	0	0.15	0.15	0.65	2.15	2.18	2.05	1.72	0	0.1	Tree 20m very dense, free stem crown layer	
w	20	2	0.11	0.14	0.18	0.27	0.33	0.37	0.36	0.33	0.25	0	0.1	Forst 20 m dense., no distinct crown layer	
l1	15	2	0.04	0.06	0.07	0.11	0.13	0.15	0.14	0.13	0.1	0	0.1	Tree, light 15 m	
l2	20	2	0.04	0.06	0.07	0.11	0.13	0.15	0.14	0.13	0.1	0	0.1	Tree, light 20 m	
h	2	1	2	2	2	2	2	2	2	2	2	2	0.1	Hedge dense, 2m	
m	1.5	0.5	0.3	0.3	0.3	0.3	0.3	0.3	0.3	0.3	0.3	0.3	0.1	Maize, 1.5 m	
c	1.5	0.5	0.1	0.1	0.1	0.1	0.1	0.1	0.1	0.1	0.1	0.1	0.1	Corn, 1.5 m	
gb	0.5	0.5	0.3	0.3	0.3	0.3	0.3	0.3	0.3	0.3	0.3	0.3	0.1	Grass 50 cm aver. dense	
gz	0.5	0.5	0.3	0.3	0.3	0.3	0.3	0.3	0.3	0.3	0.3	0.3	0.1	Grass 50 cm aver. dense	
T2	16	2	0	0	2.18	2.18	2.18	2.18	2.18	2.18	1.72	0	0.1	Tree 15m very dense, leafless base	
Tb	16	2	2	2	2.18	2.18	2.18	2.18	2.18	2.18	1.72	0	0.1	Tree 15m very dense	
ee	20	2	0.5	0.5	1	1.11	1.13	1.5	1.8	2	1.5	0.8	0.1	Tree 20m aver. dense., no distinct crown layer	
TH	15	2	0	0	0	0	0.4	0.45	0.45	0.49	0.49	0.4	0.1	Tree 15m dense, distinct crown layer, Christer	
ml	8	2	0.000	0.060	0.070	0.110	0.130	0.150	0.140	0.130	0.100	0.040	0.1	<i>Malaeuca leucadendron</i> , light 8 m	
fd	8	2	0.000	0.075	0.075	0.075	0.250	1.150	1.060	1.050	0.920	0.075	0.1	<i>Filicium decipiens</i> , dense, 8m	
mf	8	2	0.000	0.000	1.140	1.140	1.140	1.425	1.425	1.140	0.570	0.000	0.1	<i>Mesua ferrea</i> , very dense, 8 m	
Fb	8	2	0.000	0.000	0.000	1.620	1.620	1.620	2.025	2.025	0.810	0.000	0.1	<i>Ficus benamina</i> , very dense, 8 m	



Welsh School of Architecture



Ref. No:

Dear respondents, thank you for participating. The objective of this survey is to understand and evaluate the outdoor thermal comfort conditions people experience and their perception of the current environment in Perdana Boulevard Putrajaya, Malaysia. You will be observed on your characteristics (such as activities, clothing and food/drink consumption). Then, you would have to rate the thermal, wind, humidity and brightness condition at this point of time. Finally, you would rate your general preferences regarding air movement, humidity, brightness and surrounding elements such as greenery elements in this area.

Ke hadapan peserta yang budiman, terima kasih kerana sudi mengisi borang soal selidik ini. Objektif kaji selidik ini adalah untuk memahami dan mengkaji keadaan manusia terhadap keselesaan terma di kawasan terbuka dan juga pengamatan mereka terhadap faktor sekeliling di kawasan Persiaran Perdana, Putrajaya, Malaysia. Anda akan dinilai dari segi faktor karektor anda (seperti aktiviti, pakaian dan pemakanan yang diambil). Seterusnya, anda dikehendaki menilai keadaan terma, angin, kelembapan udara dan faktor cahaya di waktu anda menjawab soalan ini. Akhir sekali, anda dikehendaki menilai keinginan anda secara amnya terhadap faktor angin, kelembapan udara, cahaya dan juga elemen disekeliling seperti faktor kehijauan di kawasan ini..

Yours truly,

Mohd Fairuz Shahidan | PhD Student | Welsh School of Architecture | Cardiff University | Bute Building | King Edward VII Avenue | Cardiff, CF10 3NB | email add: shahidanmf@cardiff.ac.uk

Glossary/ Glosari:

Outdoor Thermal Comfort – comfort state that is influenced by outdoor microclimate components such as air movement, air temperature, radiant temperature and humidity. It is measured in outdoor area.

Keselesaan Terma – keadaan selesa yang dipengaruhi oleh faktor iklim mikro luaran seperti pergerakan angin, suhu udara, suhu radian dan kelembapan udara. Ianya di ukur dikawasan terbuka.

Air temperature – is a measure of the heat content of the air. Typical definitions of temperature include "how hot or cold it is" relating to how people feel.

Suhu Udara – adalah pengukuran kandaungan haba di dalam udara. Secara tipikal, definisi suhu ini merangkumi 'bagaimana panas atau sejuk' berdasarkan terhadap apa yang dirasakan oleh manusia.

Wind – is the movement of the air. It simply classified by their spatial scale, the speed and the types of forces that cause them. In this study, it been classified only by its speed and scale.

Angin – adalah pergerakan udara. Ia selalunya diklasifikasi menerusi berbagai skala, kelajuan dan jenis daya yang menggerakannya. Di dalam kajian ini ianya hanya diklasifikasikan menerusi kelajuan dan skala sahaja.

Humidity – the amount of water vapour in the air.

Kelembapan Udara – adalah kandungan wap air didalam udara.

Light/Brightness – an attribute of visual perception in which source appears to emit or reflect a given amount of light. In this study, it will be evaluated according to brightest to darkest scale.

Cahaya/Pencahayaan – adalah salah satu persepsi visual dimana sesuatu objek menerima dan memancarkan amaun cahaya. Didalam kajian ini, ianaya akan dinilai berdasarkan skala kecerahan kepada kegelapan.

Vegetation – refers to plants, trees, shrubs, grass, ground covers or soft landscape

Tumbuh-tumbuhan – adalah merujuk kepada tumbuhan, pokok-pokok, pokok renek, rumput atau landskap lembut.

For office use. Do not write on this box. (Untuk kegunaan pejabat. Jangan menulis di dalam kotak ini):

Time of interview: _____ am/pm

Date of interview: ___/___/___ 2009

SECTION A: OBSERVATION. Questions A.1 to A.8. Tick (✓) one answer only for questions A.1 to A.6. For questions A.7 and A.8, you can tick more than one answer.

Seksyen A: Pemerhatian. Soalan A.1 to A.10. Tandakan (✓) pada satu jawapan sahaja bagi soalan A.1 hingga A.6. Bagi soalan A.7 dan A.8, anda boleh tandakan lebih dari satu jawapan.

A.1 Gender/ Jantina:

- 01 – Male/ Lelaki
- 02 - Female/ Perempuan

A.2 Age Group/ Kelompok Umur:

- 01 – 20-30
- 02 – 31-40
- 03 – 41-60>

A.3 Users Locality/ Pengguna tempatan:

Are you local inhabitant of Putrajaya area?

Adakah anda pengguna tempatan di kawasan Putrajaya?

- 01 – Yes/ Ya
- 02 – No/ Tidak

If YES, are you?

Jika YA, anda adalah?

- 01 – Working person/ Bekerja
- 02 – Visitor/ Pelawat
- 03 – Student/ Pelajar
- 04 – Other/ Lain-Lain _____

A.4 At the moment, are you out or in of sun?

Pada waktu ini, adakah anda terdedah atau tidak terdedah pada matahari?:

- 01 – In sun/ Terdedah
- 02 – Out of sun/ Tidak Terdedah

A.5 What time you mostly use the outdoor spaces?

Pada waktu bila anda kerap menggunakan kawasan terbuka?

- 01 – Morning/ Pagi (8.00 am-11.59 am)
- 02 – Afternoon/ Tengahari (12.00 pm-4.59 pm)
- 03 – Evening/ Petang (5.00 pm-7.00 pm)

For office use. Do not write on this box.

(Untuk kegunaan pejabat. Jangan menulis di dalam kotak ini):

Location of interview: _____

Direction: N / S / E / W

A.6 Activity/ Aktiviti:

In the last half hour, what was your main activity?

Bagi setengah jam sebelum ini, apa aktiviti utama anda?

- 01 – Sleeping/ Tidur
- 02 – Sitting/ Duduk
- 03 – Standing/ Berdiri
- 04 – Walking/ Berjalan
- 05 – Running/ Berlari
- 06 – Other/ Lain-lain _____

A.7 Clothing/ Pakaian:

What clothes are YOU wearing today?

Apa pakaian yang ANDA pakai hari ini?

- 01 – Short Sleeved Shirt/ Kemeja Lengan Pendek
- 02 – Long Sleeved Shirt/ Kemeja Lengan Panjang
- 03 – Blouse/ Blaus
- 04 – Baju Kurung/ Baju Kurung
- 05 – Vest/Jacket/Suit/ Vest/Jaket/Suit
- 06 – T-Shirt/ T-Shirt
- 07 – Long Pants/ Seluar Panjang
- 08 – Jeans/ Seluar Jeans
- 09 – Long Skirt/ Skirt Panjang
- 10 – Short Skirt/ Skirt Pendek
- 11 – Shoes and Socks/ Kasut dan Stoking
- 12 – Sandal OR Thongs/ Sandal/ Selipar
- 13 – Other/ Lain-lain _____

A.8 In the last half hour, did you take any food/or drink?

Bagi setengah jam sebelum ini, adakah anda mengambil sebarang makanan/minuman?

- 01 – None/ Tiada
- 02 – Hot food/ Makanan panas
- 03 – Cold food/ Makanan sejuk
- 04 – Hot drink/ Minuman panas
- 05 – Cold drink/ Minuman sejuk
- 06 – Smoking/ Menghisap rokok

End of Section A

SECTION B: PERCEPTION AND PREFERENCE ON THERMAL COMFORT RATING

Seksyen B: Penilaian Terhadap Keamatan dan Keinginan Keselesaan Terma

Instruction for questions B.1 – B.13: Circle in the appropriate box.

Arahan untuk soalan B.1-B.13: Tandakan (✓) pada kotak yang sesuai.

<p>Scale values:</p> <ul style="list-style-type: none"> +3 – Hot/ Panas +2 – Warm/ Hangat +1 – Slightly Warm/ Sedikit Hangat 0 – Neutrality/ Neutral -1 – Slightly Cool/ Sedikit Dingin -2 – Cool/ Dingin -3 – Cold/ Sejuk 	<p>Example of answer: At the moment, what do you feel? <i>Pada masa ini, apakah yang anda rasai?</i></p> <table border="1" style="margin-left: auto; margin-right: auto; text-align: center;"> <tr> <td style="padding: 2px;">Cold/ Sejuk</td> <td style="padding: 2px;">-3</td> <td style="padding: 2px;">-2</td> <td style="padding: 2px;">-1</td> <td style="padding: 2px;">0</td> <td style="padding: 2px; border: 2px solid black;">+1</td> <td style="padding: 2px;">+2</td> <td style="padding: 2px;">+3</td> <td style="padding: 2px;">Hot/ Panas</td> </tr> </table>	Cold/ Sejuk	-3	-2	-1	0	+1	+2	+3	Hot/ Panas
Cold/ Sejuk	-3	-2	-1	0	+1	+2	+3	Hot/ Panas		

B.1 Air Temperature Perception/ Pengamatan terhadap Suhu Udara:

At the moment, what do you feel about the air temperature?

Pada masa ini, apakah yang anda rasai terhadap suhu udara?

Cold/ Sejuk	-3	-2	-1	0	+1	+2	+3	Hot/ Panas
----------------	----	----	----	---	----	----	----	---------------

B.2 Thermal Preference/ Keinginan terhadap Faktor Keselesaan Terma:

What would you like the air temperature to be?

Bagaimanakah suhu udara yang anda inginkan?

Much Cooler/ Lebih Sejuk	-3	-2	-1	0	+1	+2	+3	Much Warmer/ Lebih Panas
-----------------------------	----	----	----	---	----	----	----	-----------------------------

B.3 Wind Movement Perception/ Pengamatan terhadap Pergerakan Angin:

At the moment, what do you feel about the wind movement?

Pada masa ini, apakah yang anda rasai terhadap pergerakan angin?

None/ Tiada	-3	-2	-1	0	+1	+2	+3	Too Strong/ Terlalu Kuat
----------------	----	----	----	---	----	----	----	-----------------------------

B.4 Wind Preference/ Keinginan terhadap Faktor Angin:

What would you like the amount to be?

Berapa banyakkah amuan angin yang anda inginkan?

Much Less/ Kurang Angin	-3	-2	-1	0	+1	+2	+3	Much More/ Lebih Angin
----------------------------	----	----	----	---	----	----	----	---------------------------

For office use. Do not write on this box. (Untuk kegunaan pejabat. Jangan menulis di dalam kotak ini):

Current Air Temperature: _____ °C Current Globe Temperature: _____ °C

Current Wind Velocity: _____ m/s

Continue to next page/ Bersambung di muka surat seterusnya

B.5 Humidity Perception/ Pengamatan terhadap Faktor Kelembapan Udara:

At the moment, what do you feel about the humidity?

Pada masa ini, apakah yang anda rasai tentang kelembapan udara?

Very Dry/ Terlalu Kering	-3	-2	-1	0	+1	+2	+3	Too Damp/ Terlalu Lembap
-------------------------------------	-----------	-----------	-----------	----------	-----------	-----------	-----------	-------------------------------------

B.6. Humidity Preference/ Keinginan terhadap Faktor Kelembapan Udara:

What would you like the humidity to be?

Bagaimana kelembapan udara yang anda inginkan?

Much Dryer/ Lebih Kering	-3	-2	-1	0	+1	+2	+3	Much Damp/ Lebih Lembap
-------------------------------------	-----------	-----------	-----------	----------	-----------	-----------	-----------	------------------------------------

B.7 Light Perception/ Pengamatan terhadap Faktor Cahaya:

At the moment, what do you feel about the light?

Pada masa ini, apakah yang anda rasai tentang cahaya?

Too Dark/ Terlalu Gelap	-3	-2	-1	0	+1	+2	+3	Too Bright/ Terlalu Cerah
------------------------------------	-----------	-----------	-----------	----------	-----------	-----------	-----------	--------------------------------------

B.8 Light Preference/ Keinginan terhadap Faktor Cahaya:

What would you like the light to be?

Bagaimana cahaya yang anda inginkan?

Much Darker/ Lebih Gelap	-3	-2	-1	0	+1	+2	+3	Much Lighter/ Lebih Cerah
-------------------------------------	-----------	-----------	-----------	----------	-----------	-----------	-----------	--------------------------------------

B.9 Amount of Vegetation Perception/ Pengamatan terhadap Amaun Tumbuh-tumbuhan:

At the moment, what do you feel about the amount of vegetation in this area?

Pada masa ini, apakah yang anda rasai tentang Amaun Tumbuh-tumbuhan di kawasan ini?

Too little/ Terlalu Sedikit	-3	-2	-1	0	+1	+2	+3	Too Much/ Terlalu Banyak
--	-----------	-----------	-----------	----------	-----------	-----------	-----------	-------------------------------------

B.10 Amount of Vegetation Preference/ Keinginan terhadap Amaun Tumbuh-tumbuhan:

How much amount of vegetation you want it to be?

Berapa banyakkah amaun yang anda inginkan?

Much Less/ Kurangkan Amaunnya	-3	-2	-1	0	+1	+2	+3	Much More/ Lebihkan Amaunnya
--	-----------	-----------	-----------	----------	-----------	-----------	-----------	---

For office use. Do not write on this box. (Untuk kegunaan pejabat. Jangan menulis di dalam kotak ini):

Current Relative Humidity: _____ °C

Current Light Intensity: _____ lux

Continue to next page/ Bersambung di muka surat seterusnya

B.11 Amount of Shaded Area Perception/ *Pengamatan terhadap Kawasan Teduhan:*

At the moment, what do you feel about the amount of shaded area in this area?

Pada masa ini, apakah yang anda rasai tentang Kawasan Teduhan di kawasan ini?

Too little/ Terlalu Sedikit	-3	-2	-1	0	+1	+2	+3	Too Much/ Terlalu Banyak
--	-----------	-----------	-----------	----------	-----------	-----------	-----------	-------------------------------------

B.12 Amount of Shaded Area Preference/ *Keinginan terhadap Amaun Kawasan Teduhan:*

How much amount of shaded area you want it to be?

Berapa banyakkah amaun yang anda inginkan?

Much Less/ Kurangkan Amaunnya	-3	-2	-1	0	+1	+2	+3	Much More/ Lebihkan Amaunnya
--	-----------	-----------	-----------	----------	-----------	-----------	-----------	---

B.13 Overall Comfort Satisfaction/ *Keseluruhan Kepuasan Keselesaan:*

In overall, how satisfied are you with your thermal comfort?

Secara keseluruhan, bagaimana tahap kepuasan keselesaan terma anda?

Very Uncomfortable/ Amat Tidak Selesa	-3	-2	-1	0	+1	+2	+3	Very Comfortable/ Amat Selesa
--	-----------	-----------	-----------	----------	-----------	-----------	-----------	--

B.14 Please specify if any additional comments/ *Sila catatkan jika anda mempunyai komen tambahan:*

End of Section B

**THANK YOU FOR YOUR KIND CO-OPERATION
TERIMA KASIH DIATAS KERJASAMA ANDA**

APPENDIX 6

SPECIFIC HUMIDITY (g/kg)								
TIME	ml		fd		mf		Fb	
	Outside	Underneath	Outside	Underneath	Outside	Underneath	Outside	Underneath
01:00	13.36	13.34	13.37	13.41	12.35	12.34	13.35	13.53
02:00	13.37	13.35	13.39	13.42	12.30	12.30	13.37	13.54
03:00	13.37	13.35	13.37	13.40	12.26	12.26	13.36	13.52
04:00	13.34	13.33	13.35	13.38	12.23	12.22	13.34	13.50
05:00	13.31	13.30	13.32	13.35	12.19	12.18	13.30	13.46
06:00	13.28	13.26	13.28	13.31	12.15	12.13	13.26	13.42
07:00	13.24	13.22	13.24	13.27	12.11	12.09	13.22	13.38
08:00	13.20	13.19	13.20	13.23	12.07	12.05	13.18	13.34
09:00	14.15	14.11	14.10	14.08	12.97	13.05	14.09	14.14
10:00	15.45	15.36	15.39	15.18	14.10	14.22	15.48	15.29
11:00	16.02	15.96	15.96	15.69	14.84	15.02	15.97	15.66
12:00	16.61	16.64	16.46	16.46	15.49	15.70	16.61	16.50
13:00	17.12	17.23	16.92	17.13	15.95	16.29	17.19	17.16
14:00	17.44	17.61	17.25	17.58	16.37	16.69	17.58	17.64
15:00	17.49	17.68	17.27	17.71	16.44	16.80	17.67	17.75
16:00	17.31	17.42	17.09	17.53	16.28	16.63	17.41	17.62
17:00	16.93	16.88	16.77	17.10	15.94	16.23	16.80	17.19
18:00	16.37	16.30	16.29	16.47	15.47	15.60	16.23	16.58
19:00	15.72	15.71	15.73	15.75	14.81	14.82	15.78	15.88
20:00	15.47	15.47	15.46	15.49	14.43	14.48	15.52	15.64
21:00	15.19	15.20	15.16	15.19	14.13	14.18	15.21	15.34
22:00	14.97	14.97	14.93	14.96	13.90	13.94	14.98	15.10
23:00	14.77	14.77	14.73	14.75	13.72	13.75	14.78	14.90
00:00	14.58	14.59	14.55	14.58	13.55	13.58	14.61	14.72
Mean	15.09	15.09	15.02	15.10	14.00	14.11	15.10	15.20
Max	17.49	17.68	17.27	17.71	16.44	16.80	17.67	17.75
Min	13.20	13.19	13.20	13.23	12.07	12.05	13.18	13.34

ABSOLUTE HUMIDITY (g/m ³)								
TIME	ml		fd		mf		Fb	
	Outside	Underneath	Outside	Underneath	Outside	Underneath	Outside	Underneath
01:00	17.23	17.21	17.25	17.30	15.93	15.92	17.22	17.45
02:00	17.25	17.22	17.27	17.31	15.87	15.87	17.25	17.47
03:00	17.25	17.22	17.25	17.29	15.82	15.82	17.23	17.44
04:00	17.21	17.20	17.22	17.26	15.78	15.76	17.21	17.42
05:00	17.17	17.16	17.18	17.22	15.73	15.71	17.16	17.36
06:00	17.13	17.11	17.13	17.17	15.67	15.65	17.11	17.31
07:00	17.08	17.05	17.08	17.12	15.62	15.60	17.05	17.26
08:00	17.03	17.02	17.03	17.07	15.57	15.54	17.00	17.21
09:00	18.25	18.20	18.19	18.16	16.73	16.83	18.18	18.24
10:00	19.93	19.81	19.85	19.58	18.19	18.34	19.97	19.72
11:00	20.67	20.59	20.59	20.24	19.14	19.38	20.60	20.20
12:00	21.43	21.47	21.23	21.23	19.98	20.25	21.43	21.29
13:00	22.08	22.23	21.83	22.10	20.58	21.01	22.18	22.14
14:00	22.50	22.72	22.25	22.68	21.12	21.53	22.68	22.76
15:00	22.56	22.81	22.28	22.85	21.21	21.67	22.79	22.90
16:00	22.33	22.47	22.05	22.61	21.00	21.45	22.46	22.73
17:00	21.84	21.78	21.63	22.06	20.56	20.94	21.67	22.18
18:00	21.12	21.03	21.01	21.25	19.96	20.12	20.94	21.39
19:00	20.28	20.27	20.29	20.32	19.10	19.12	20.36	20.49
20:00	19.96	19.96	19.94	19.98	18.61	18.68	20.02	20.18
21:00	19.60	19.61	19.56	19.60	18.23	18.29	19.62	19.79
22:00	19.31	19.31	19.26	19.30	17.93	17.98	19.32	19.48
23:00	19.05	19.05	19.00	19.03	17.70	17.74	19.07	19.22
00:00	18.81	18.82	18.77	18.81	17.48	17.52	18.85	18.99
Mean	19.46	19.47	19.38	19.48	18.06	18.20	19.47	19.61
Max	22.56	22.81	22.28	22.85	21.21	21.67	22.79	22.90
Min	17.03	17.02	17.03	17.07	15.57	15.54	17.00	17.21

Frequencies

Statistics

		Gender	Age Group	Locality	Local, as	Out/In Sun	Time In Outdoor Mostly	Activity-half an hour	Clothing	Food/Drinks Consumption
N	Valid	229	229	229	229	229	229	229	229	229
	Missing	0	0	0	0	0	0	0	0	0
	Mean	1.38	1.51	1.55	2.64	1.21	3.54	3.03	3.36	4.53
	Median	1.00	1.00	2.00	4.00	1.00	2.00	3.00	2.00	3.00
	Mode	1	1	2	4	1	2	4	2	1
	Std. Deviation	.486	.770	.498	1.497	.405	2.203	.868	1.947	3.718
	Sum	316	345	356	604	276	811	693	769	1038

Frequency Table

Gender

		Frequency	Percent	Valid Percent	Cumulative Percent
Valid	Male	142	62.0	62.0	62.0

Female	87	38.0	38.0	100.0
Total	229	100.0	100.0	

Age Group

	Frequency	Percent	Valid Percent	Cumulative Percent
Valid 20-30	152	66.4	66.4	66.4
31-40	38	16.6	16.6	83.0
41-60 over	39	17.0	17.0	100.0
Total	229	100.0	100.0	

Locality

	Frequency	Percent	Valid Percent	Cumulative Percent
Valid Yes	102	44.5	44.5	44.5
NO	127	55.5	55.5	100.0
Total	229	100.0	100.0	

Local, as

	Frequency	Percent	Valid Percent	Cumulative Percent
Valid Working Person	104	45.4	45.4	45.4
Ousider Visitor	125	54.6	54.6	100.0
Total	229	100.0	100.0	

Out/In Sun

		Frequency	Percent	Valid Percent	Cumulative Percent
Valid	In Sun	182	79.5	79.5	79.5
	Out of Sun	47	20.5	20.5	100.0
	Total	229	100.0	100.0	

Time In Outdoor Mostly

		Frequency	Percent	Valid Percent	Cumulative Percent
Valid	Morning	30	13.1	13.1	13.1
	Afternoon	91	39.7	39.7	52.8
	Evening	16	7.0	7.0	59.8
	Morning and Afternoon	23	10.0	10.0	69.9
	Morning and Evening	2	.9	.9	70.7
	Afternoon and Evening	20	8.7	8.7	79.5
	All Day Time	47	20.5	20.5	100.0
	Total	229	100.0	100.0	

Activity-half an hour

		Frequency	Percent	Valid Percent	Cumulative Percent
--	--	-----------	---------	---------------	--------------------

Valid	Sitting	83	36.2	36.2	36.2
	Standing	57	24.9	24.9	61.1
	Walking	89	38.9	38.9	100.0
	Total	229	100.0	100.0	

Clothing

		Frequency	Percent	Valid Percent	Cumulative Percent
Valid	Men - Office Attire 1 (Short Sleeved Shirt, Long Pants , Shoes/Socks)	35	15.3	15.3	15.3
	Men - Office Attire 2 (Long Sleeved Shirt, Long Pants , Shoes/Socks)	91	39.7	39.7	55.0
	Men - Formal Dress (Suits/Jacket/Vest,Long Pants , Shoes/Socks)	1	.4	.4	55.5
	Women - Office Attire 1 (Blouse, Long Skirt/Short Skirt, Shoes/Sandal)	20	8.7	8.7	64.2
	Women - Office Attire 2 (Baju Kurung, Shoes/ Sandal)	33	14.4	14.4	78.6
	Men & Women - Casual Attire 1 (T-shirt, Jeans, Shoes/Sandal/Thongs)	39	17.0	17.0	95.6
	Men & Women - Casual Attire 2 (T-shirt, Long Pants/Long Skirt, Shoes/Sandal/Thongs)	10	4.4	4.4	100.0
	Total	229	100.0	100.0	

Food/Drinks Consumption

		Frequency	Percent	Valid Percent	Cumulative Percent
Valid	None	88	38.4	38.4	38.4
	Cold Food	35	15.3	15.3	53.7
	Hot Drink	5	2.2	2.2	55.9
	Cold Drink	28	12.2	12.2	68.1
	Smoking	13	5.7	5.7	73.8
	Cold Food and Drink	2	.9	.9	74.7
	Hot Food and Cold Drink	23	10.0	10.0	84.7
	Cold Food and Hot Drink	1	.4	.4	85.2
	Food, Drink and Smoking	34	14.8	14.8	100.0
	Total	229	100.0	100.0	

Descriptive Statistics

	N	Minimum	Maximum	Mean	Std. Deviation
Clothing_EDIT	229	0	1	.54	.080
Activity-half an hour	229	60	115	83.86	25.175
Valid N (listwise)	229				

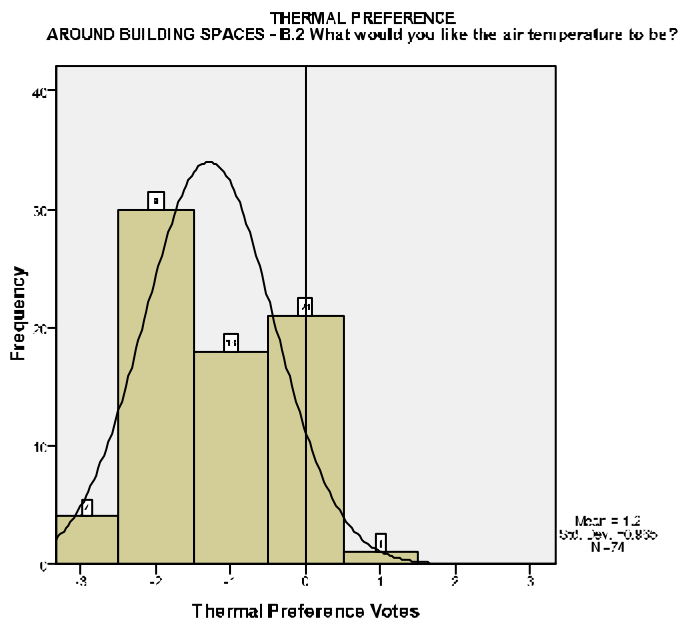
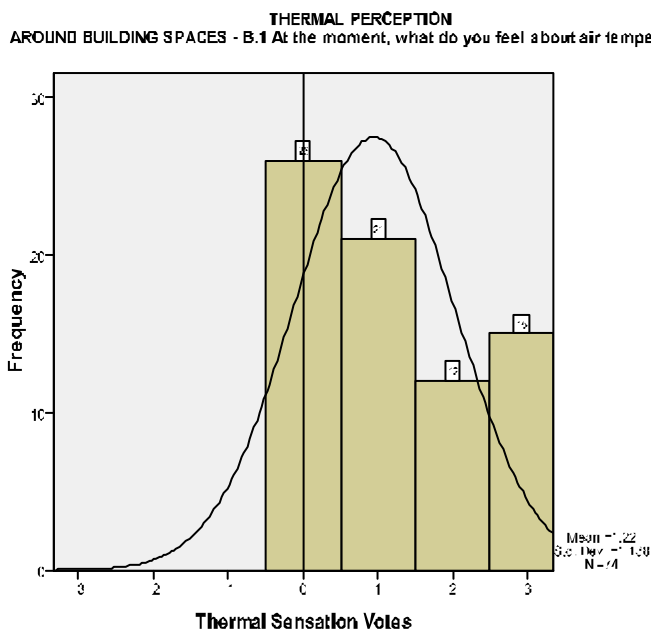
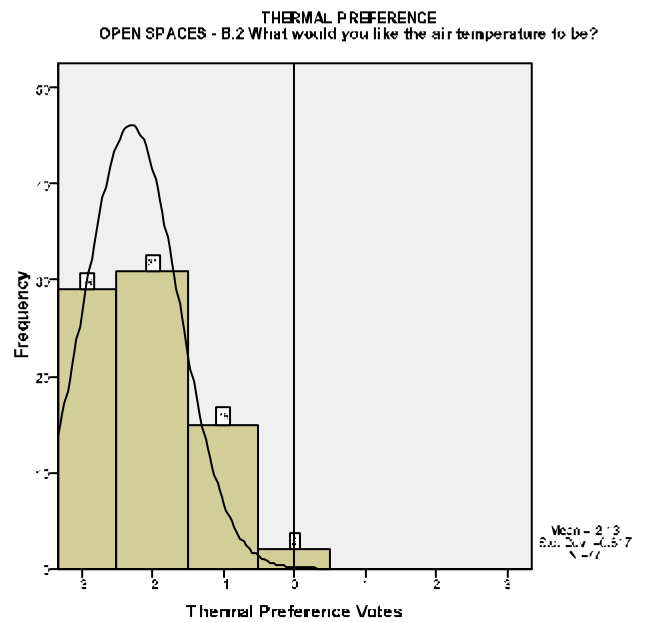
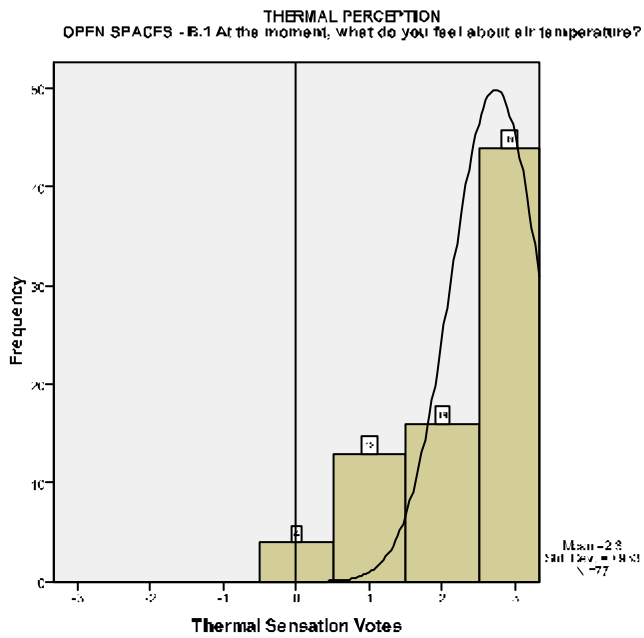
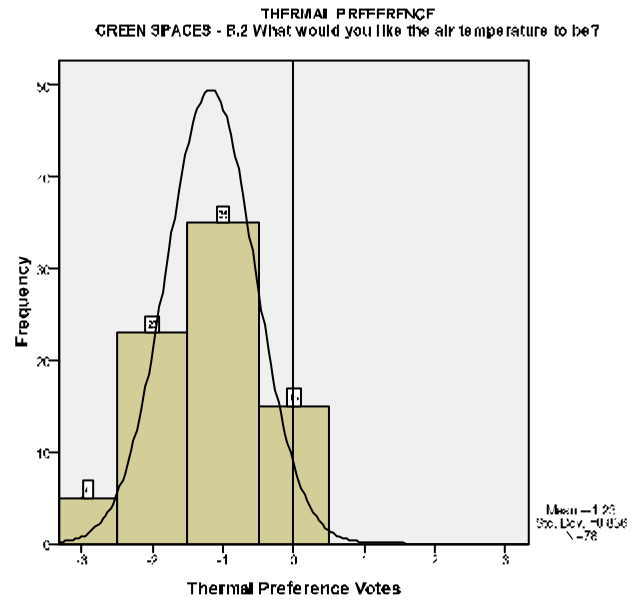
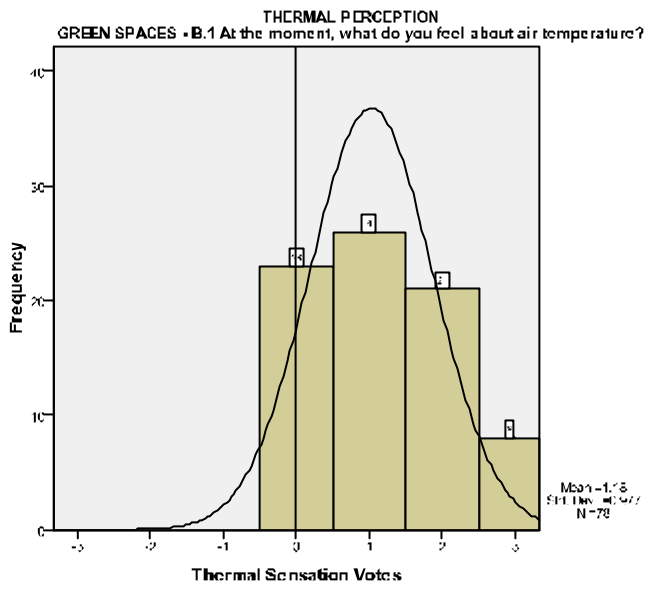

HUMIDITY PERCEPTION
GREEN SPACES - B.5 At the moment, what do you feel about the humidity?

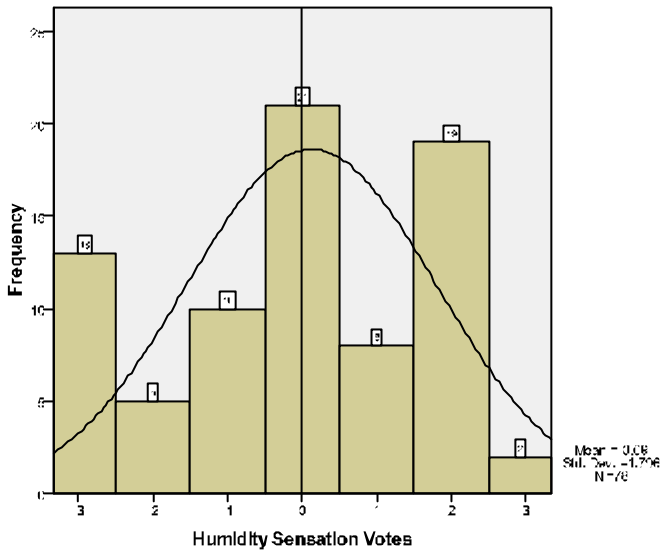

HUMIDITY PREFERENCE
GREEN SPACES - B.6 What would you like the humidity to be?

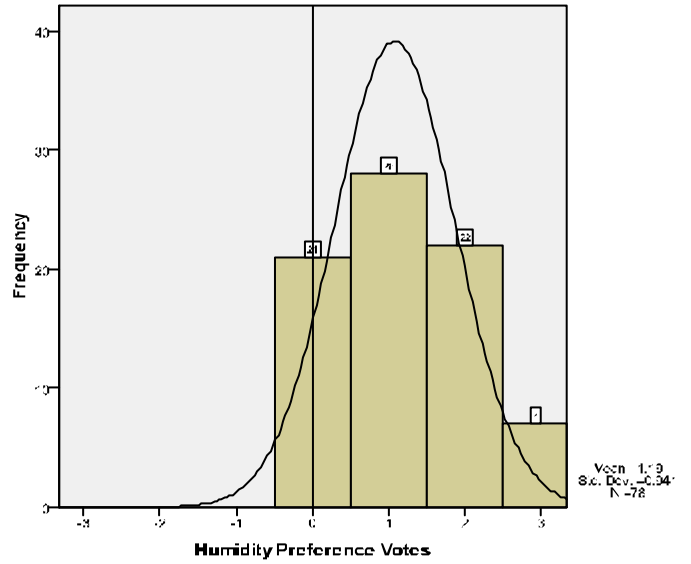

HUMIDITY PERCEPTION
OPEN SPACES - B.5 At the moment, what do you feel about the humidity?

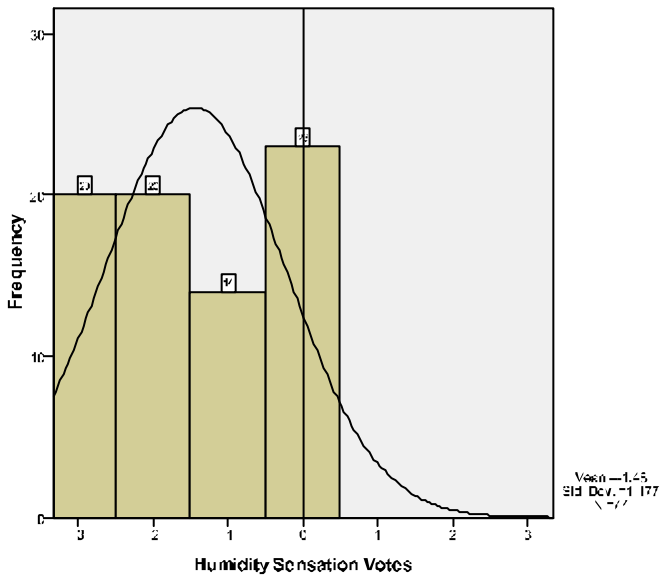

HUMIDITY PREFERENCE
OPEN SPACES - B.4 What would you like the humidity to be?

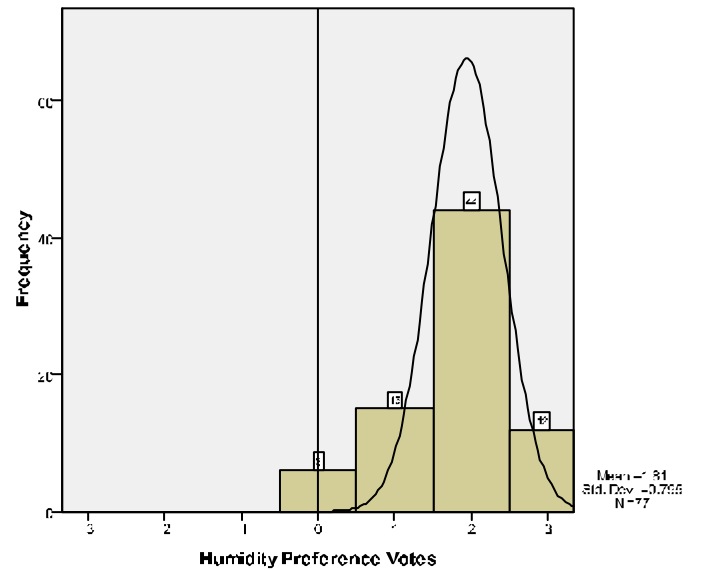

HUMIDITY PERCEPTION
AROUND BUILDING SPACES - B.5 At the moment, what do you feel about the humidity?

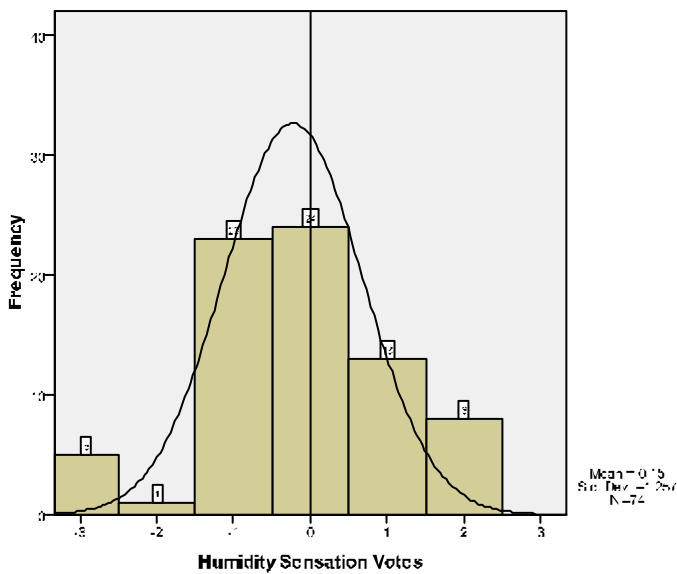

HUMIDITY PREFERENCE
AROUND BUILDING SPACES - B.4 What would you like the humidity to be?

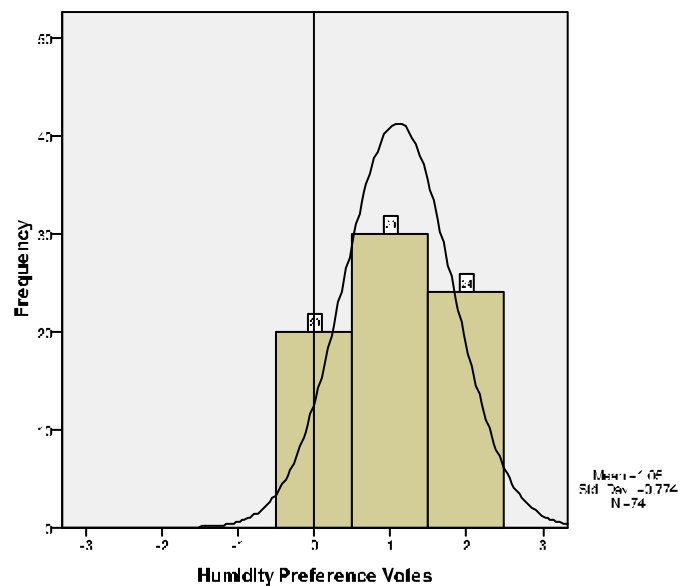

WIND MOVEMENT PERCEPTION
GREEN SPACES - B.3 At the moment, what do you feel about wind movement?

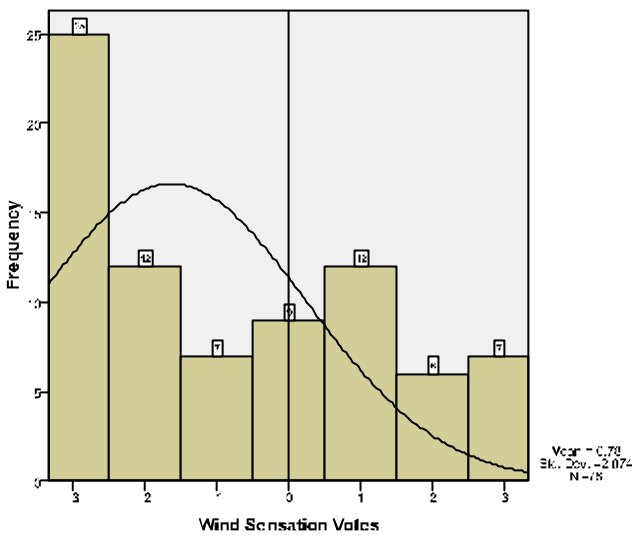

WIND PREFERENCE
GREEN SPACES - B.4 What would you like the amount to be?

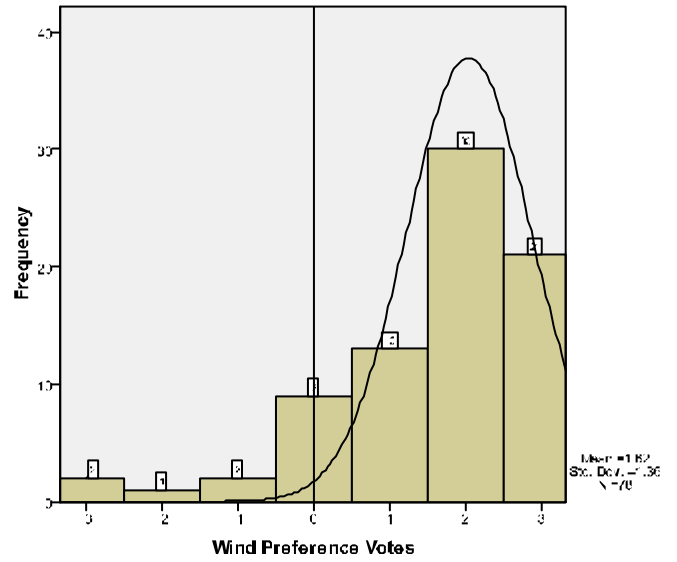

WIND MOVEMENT PERCEPTION
OPEN SPACES - B.3 At the moment, what do you feel about wind movement?

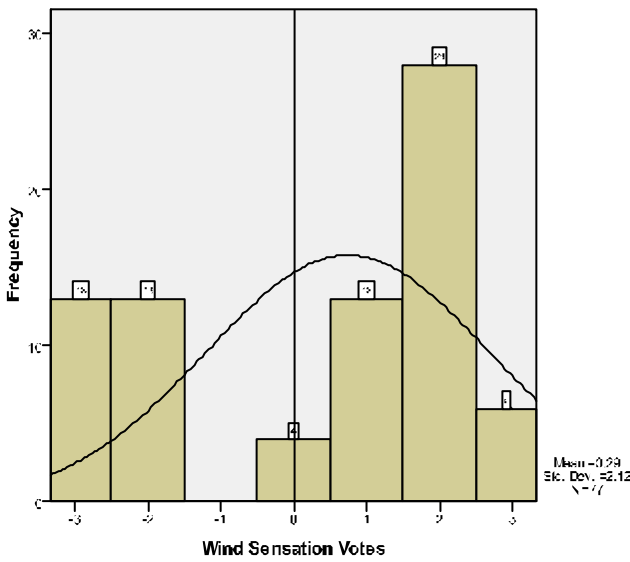

WIND PREFERENCE
OPEN SPACES - B.4 What would you like the amount to be?

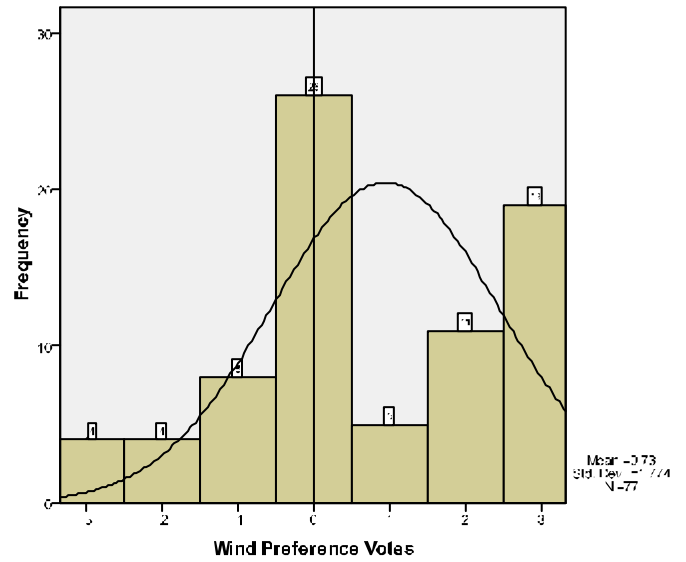

WIND MOVEMENT PERCEPTION
AROUND BUILDING SPACES - B.3 At the moment, what do you feel about wind movement?

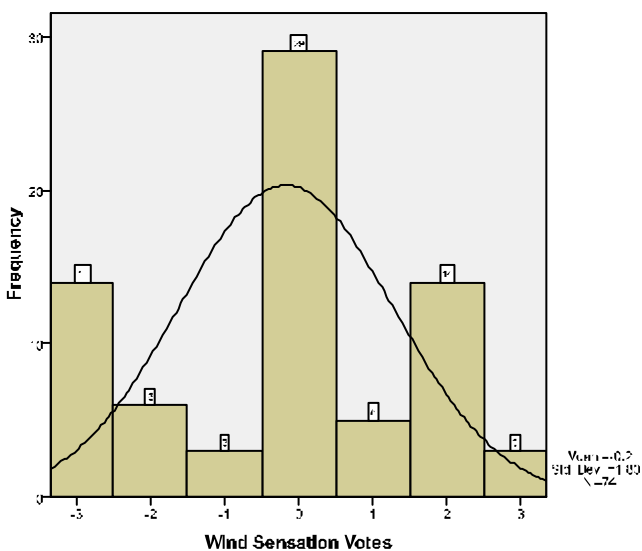

WIND PREFERENCE
AROUND BUILDING SPACES - B.4 What would you like the amount to be?

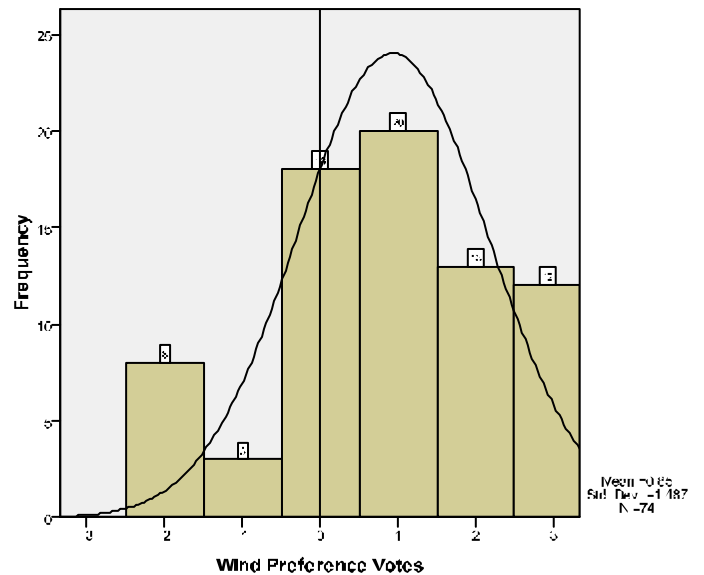

GLARE PERCEPTION
GREEN SPACES - B.7 At the moment, what do you feel about the light?

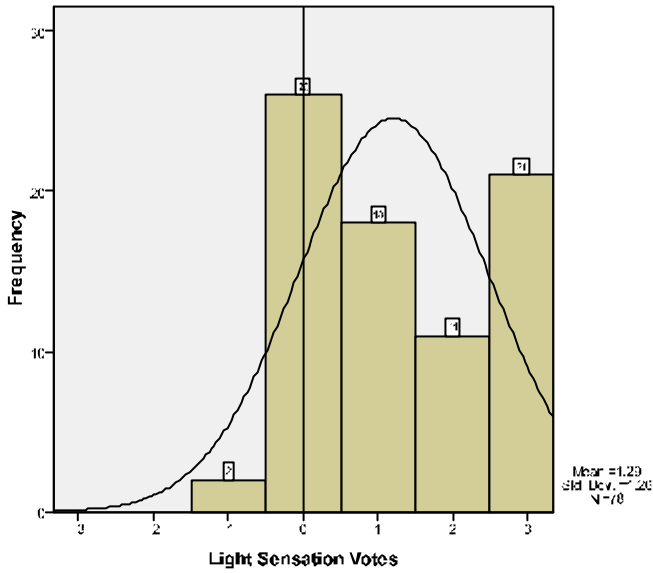

GLARE PREFERENCE
GREEN SPACES - B.8 What would you like the light to be?

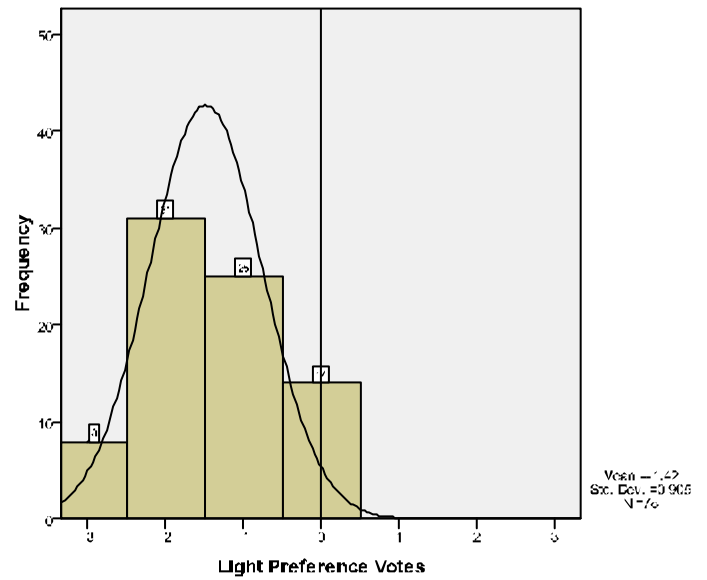

GLARE PERCEPTION
OPEN SPACES - B.7 At the moment, what do you feel about the light?

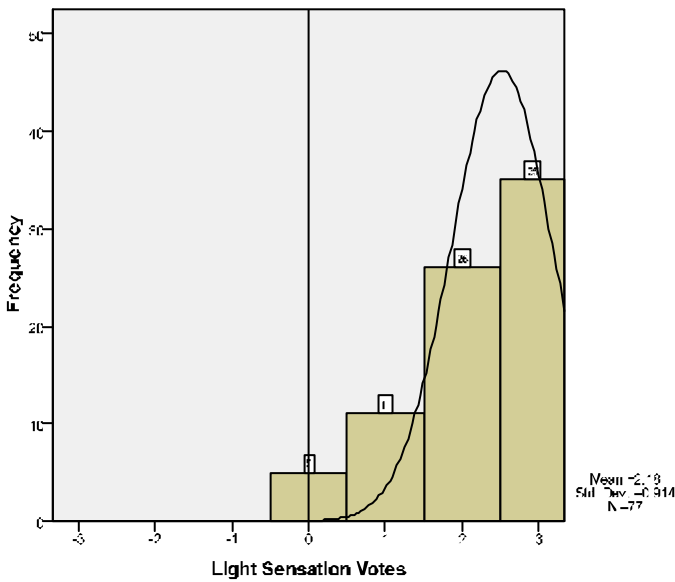

GLARE PREFERENCE
OPEN SPACES - B.8 What would you like the light to be?

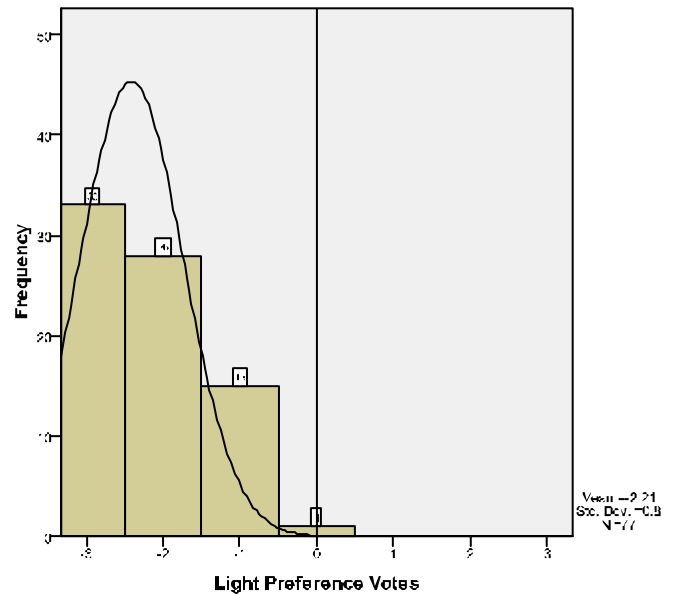

GLARE PERCEPTION
AROUND BUILDING SPACES - B.7 At the moment, what do you feel about the light?

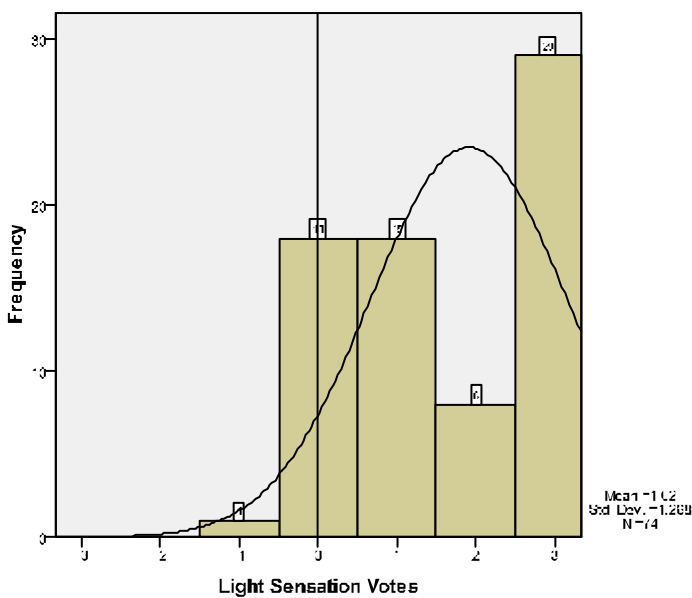

GLARE PREFERENCE
AROUND BUILDING SPACES - B.8 What would you like the light to be?

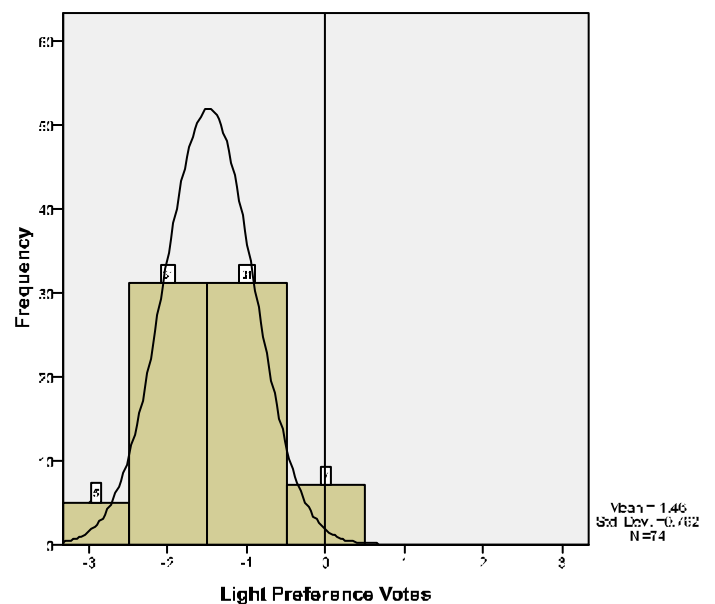

AMOUNT OF VEGETATION PERCEPTION
B.19 At the moment, what do you feel about the amount of vegetation in this area?

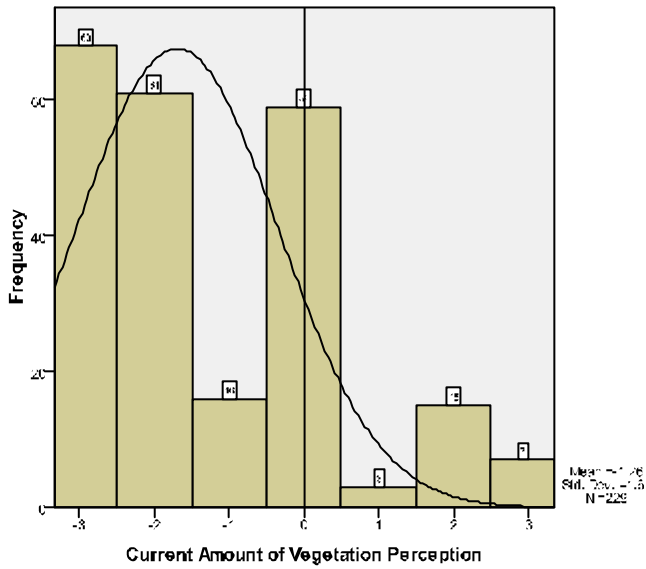

AMOUNT OF VEGETATION PREFERENCE
B.10 How much amount of vegetation you want it to be?

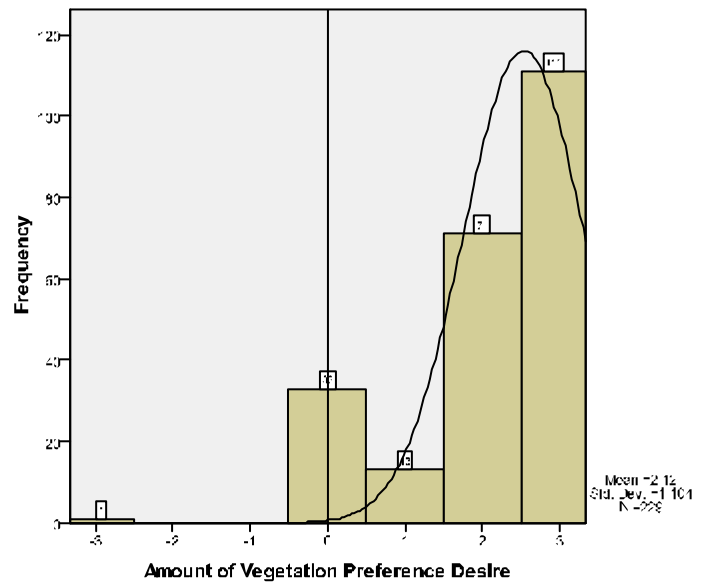

AMOUNT OF SHADED AREA PERCEPTION
B.11 At the moment, what do you feel about the amount of shaded area?

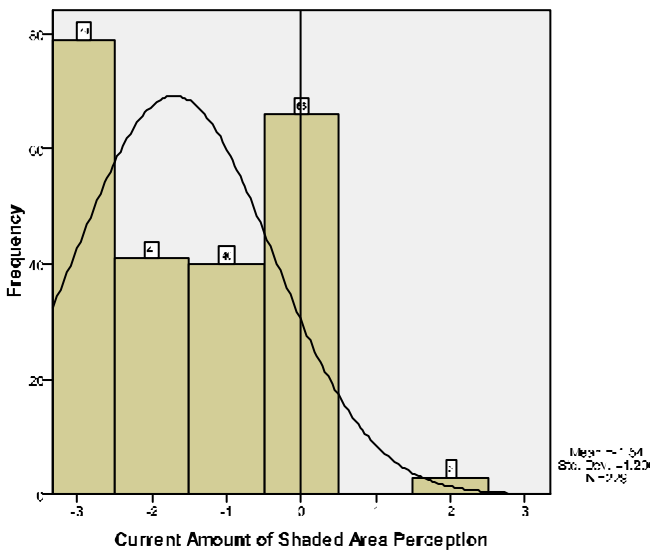

AMOUNT OF SHADED AREA PREFERENCE
B.12 How much of shaded area you want it to be?

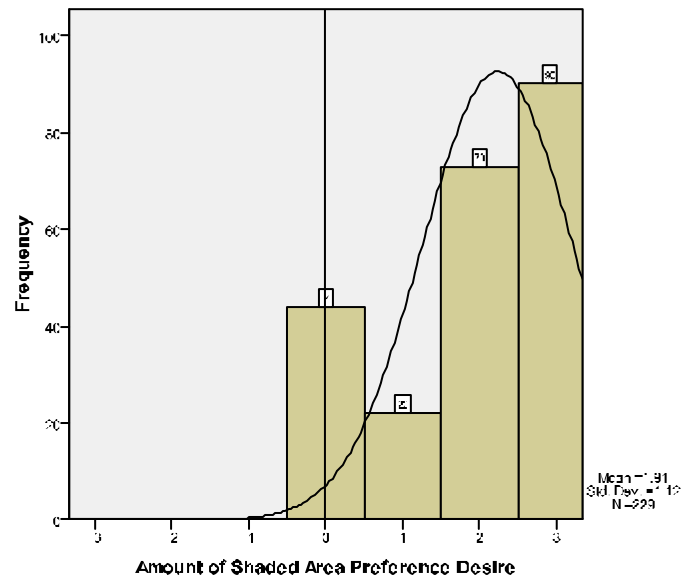

OVERALL COMFORT SATISFACTION
GREEN SPACES - B.13 In overall, how satisfied are you with your thermal comfort?

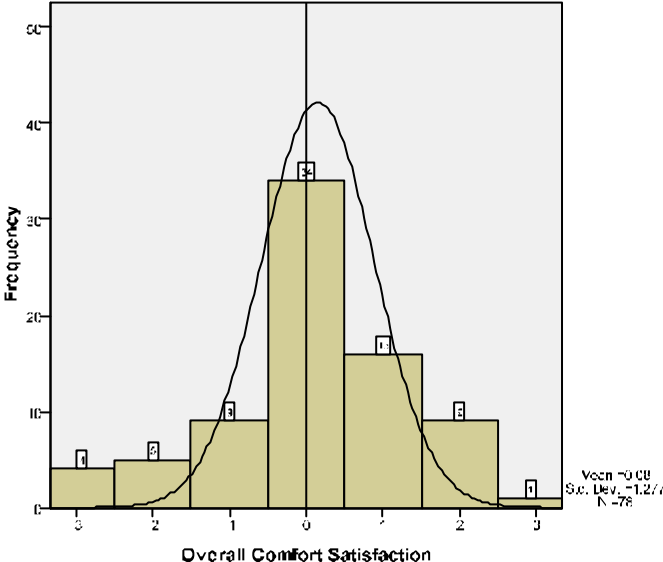

OVERALL COMFORT SATISFACTION
OPEN SPACES - B.13 In overall, how satisfied are you with your thermal comfort?

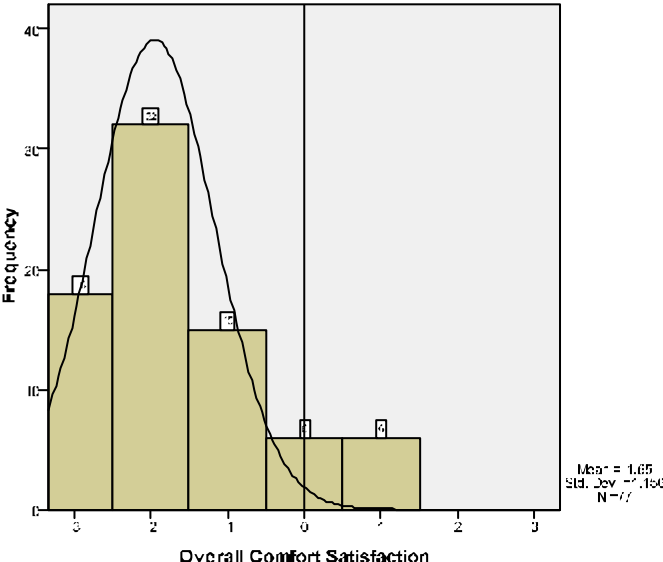

OVERALL COMFORT SATISFACTION
AROUND BUILDING SPACES - B.13 In overall, how satisfied are you with your thermal comfort?

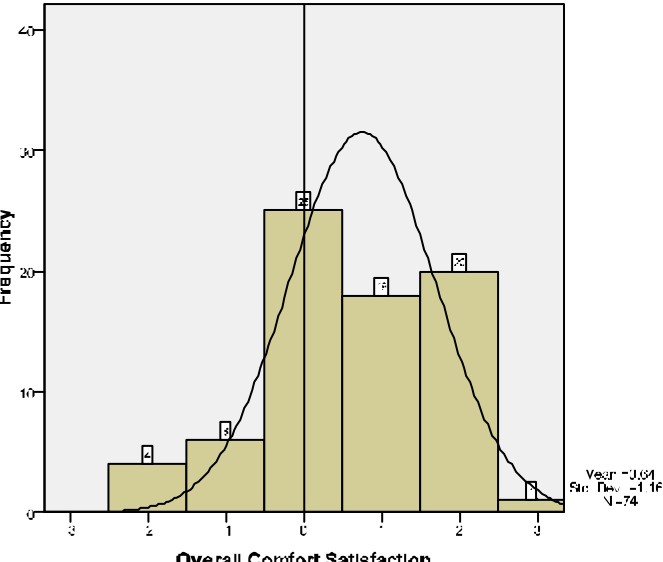

RayMan 1.2 © 2000

Meteorological Institute, University of Freiburg, Germany

Place: Malaysia (Putrajaya)

Horizon limitation: 0.0%

Geogr. longitude: 101°42'

personal data: clothing: 0.5 clo activity: 80.0 W

	day of	time	Ta	RH	v	Tmrt	PET	Sensation
date	year	h:mm	°C	%	m/s	°C	°C	Vote (MTSV)
28.2.2010	59	15:00	30.3	55	3.0	30.9	27.8	NEUTRAL (0)
28.2.2010	59	15:00	32.6	55	3.0	29.8	30.6	NEUTRAL (0.4)
28.2.2010	59	15:00	35.0	55	3.0	29.8	33.4	WARM (0.8)
28.2.2010	59	15:00	37.3	55	3.0	29.8	36.3	WARM (1.1)
28.2.2010	59	15:00	30.3	36.3	3.0	29.8	27.4	NEUTRAL (-0.1)
28.2.2010	59	15:00	30.3	42.5	3.0	29.8	27.5	NEUTRAL (-0.01)
28.2.2010	59	15:00	30.3	48.6	3.0	29.8	27.7	NEUTRAL (-0.01)
28.2.2010	59	15:00	30.3	61	3.0	29.8	27.9	NEUTRAL (0.01)
28.2.2010	59	15:00	30.3	67.1	3.0	29.8	28.0	NEUTRAL (0.03)
28.2.2010	59	15:00	30.3	73.3	3.0	29.8	28.1	NEUTRAL (0.04)
28.2.2010	59	15:00	30.3	55	0	29.8	31.4	NEUTRAL (0.4)
28.2.2010	59	15:00	30.3	55	1.5	29.8	28.9	NEUTRAL (0.1)
28.2.2010	59	15:00	30.3	55	4.5	29.8	27.0	NEUTRAL (-0.1)
28.2.2010	59	15:00	30.3	55	6.0	29.8	26.3	NEUTRAL (-0.2)
28.2.2010	59	15:00	30.3	55	7.4	29.8	25.9	NEUTRAL (-0.3)
28.2.2010	59	15:00	30.3	55	2.9	40.6	31.4	NEUTRAL (0.4)
28.2.2010	59	15:00	30.3	55	2.9	50.6	35.5	WARM (1.0)
28.2.2010	59	15:00	30.3	55	2.9	60.6	39.8	HOT (1.6)

APPENDIX 15

RayMan 1.2 © 2000

Meteorological Institute, University of Freiburg, Germany

place: Malaysia (Putrajaya)

Horizon limitation: 0.0% sky view factor: 1.000

geogr. longitude: 101°42' latitude: 3°8' Time zone: UTC +7.5 h

personal data: clothing: 0.5 clo activity: 80.0 W

CONDITION A - CURRENT

	day of	time	Ts	Ta	RH	v	Tmrt	PET
date	year	h:mm	°C	°C	%	m/s	°C	°C
28.2.2010	59	15:00	52.5	31.9	63.6	0.2	35.8	34.4
28.2.2010	59	15:00	51.1	32	58.9	0.4	41.6	37
28.2.2010	59	15:00	53.7	32.2	59.5	0.1	48.3	41.8
28.2.2010	59	15:00	49	33.6	51.1	1	76	55.4
28.2.2010	59	15:00	46	32.6	52	1.5	71.8	50.8
28.2.2010	59	15:00	46	33	53.8	1.6	76.1	53.3
28.2.2010	59	15:00	46.4	33	54.3	1.5	66.6	48.4
28.2.2010	59	15:00	46.4	33	55.1	1.5	71.6	51.1
28.2.2010	59	15:00	52.7	33	51.5	0.3	67.2	52.6
28.2.2010	59	15:00	45.4	32	55.9	1.5	71.3	50
28.2.2010	59	15:00	52.5	31.9	54.9	0.2	30.8	31.7
28.2.2010	59	15:00	47.1	33	53	1.3	71.7	51.6

APPENDIX 15

RayMan 1.2 © 2000

Meteorological Institute, University of Freiburg, Germany

place: Malaysia (Putrajaya)

Horizon limitation: 0.0% sky view factor: 1.000

geogr. longitude: 101°42' latitude: 3°8' timezone: UTC +7.5 h

personal data: clothing: 0.5 clo activity: 80.0 W

CONDITION B – LAI 0.9

	day of	time	Ts	Ta	RH	v	Tmrt	PET
date	year	h:mm	°C	°C	%	m/s	°C	°C
28.2.2010	59	15:00	48.5	31.3	64.5	0.7	42.7	36.4
28.2.2010	59	15:00	50.7	31.6	62	0.4	47.4	39.8
28.2.2010	59	15:00	53.1	31.5	62.4	0.1	52.6	44
28.2.2010	59	15:00	48.1	31.5	63.4	0.8	56.8	43.6
28.2.2010	59	15:00	49.7	31.3	64.3	0.5	38.4	34.7
28.2.2010	59	15:00	49.6	31.9	62.7	0.6	56.2	44.2
28.2.2010	59	15:00	50.4	31.3	66	0.4	39.6	35.6
28.2.2010	59	15:00	49	31.2	65	0.6	38.9	34.7
28.2.2010	59	15:00	51.6	31.7	60.1	0.3	46.1	39.5
28.2.2010	59	15:00	45.8	31.6	60	1.3	69.3	49
28.2.2010	59	15:00	53.1	31.5	60.4	0.1	32.6	32.7
28.2.2010	59	15:00	47.6	31.5	62.6	0.9	57.8	43.9

RayMan 1.2 © 2000

Meteorological Institute, University of Freiburg, Germany

place: Malaysia (Putrajaya)

Horizon limitation: 0.0% sky view factor: 1.000

geogr. longitude: 101°42' latitude: 3°8' timezone: UTC +7.5 h

personal data: clothing: 0.5 clo activity: 80.0 W

CONDITION C – LAI 9.7

	day of	time	Ts	Ta	RH	v	Tmrt	PET
date	year	h:mm	°C	°C	%	m/s	°C	°C
28.2.2010	59	15:00	51.7	31.0	70.1	0.2	31.4	31.5
28.2.2010	59	15:00	51.1	31.2	65.1	0.3	29.2	30.5
28.2.2010	59	15:00	52.8	31.2	65.2	0.1	32.3	32.4
28.2.2010	59	15:00	49.8	32.1	65.2	0.6	51.8	42.0
28.2.2010	59	15:00	48.5	30.6	69.8	0.6	33.1	31.6
28.2.2010	59	15:00	49.9	31.5	65.9	0.5	52.4	42.2
28.2.2010	59	15:00	51.7	30.9	70.9	0.2	34.5	33.2
28.2.2010	59	15:00	48.6	31.4	66.1	0.7	31.6	31.3
28.2.2010	59	15:00	51.6	31.7	61.4	0.3	41.9	37.2
28.2.2010	59	15:00	45.4	31.1	61.3	1.3	67.8	47.8
28.2.2010	59	15:00	51.7	31.0	62.3	0.2	29.1	30.4
28.2.2010	59	15:00	47.5	31.4	62.9	0.9	52.8	41.2

RayMan 1.2 © 2000

Meteorological Institute, University of Freiburg, Germany

place: Malaysia (Putrajaya)

Horizon limitation: 0.0% sky view factor: 1.000

geogr. longitude: 101°42' latitude: 3°8' timezone: UTC +7.5 h

personal data: clothing: 0.5 clo activity: 80.0 W

CONDITION D – LAI 9.7; ALBEDO 0.8

	day of	time	Ts	Ta	RH	v	Tmrt	PET
date	year	h:mm	°C	°C	%	m/s	°C	°C
28.2.2010	59	15:00	50.9	30.1	70.9	0.2	31.0	31.0
28.2.2010	59	15:00	50.7	30.8	66.2	0.3	27.6	29.5
28.2.2010	59	15:00	52.3	30.6	66.5	0.1	30.3	31.1
28.2.2010	59	15:00	49.6	31.9	67.0	0.6	49.8	40.7
28.2.2010	59	15:00	48.4	30.5	69.8	0.6	33.1	31.5
28.2.2010	59	15:00	48.8	31.0	66.9	0.6	50.1	40.3
28.2.2010	59	15:00	51.1	30.3	70.9	0.2	31.5	31.4
28.2.2010	59	15:00	48.6	31.4	67.1	0.7	31.0	31.1
28.2.2010	59	15:00	51.6	31.7	61.9	0.3	39.8	36.1
28.2.2010	59	15:00	44.7	30.4	61.7	1.3	67.8	47.2
28.2.2010	59	15:00	45.6	30.4	62.5	1.1	27.5	28.2
28.2.2010	59	15:00	47.5	31.4	63.9	0.9	52.4	40.9

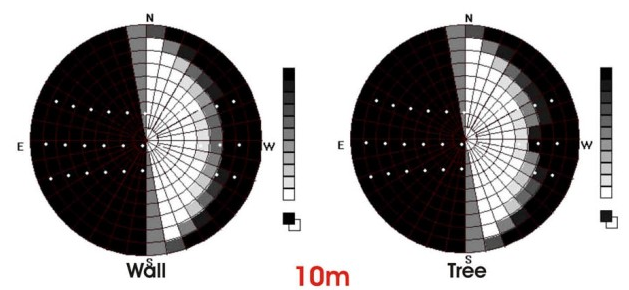
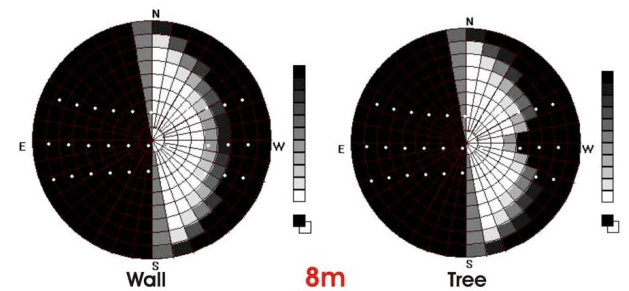
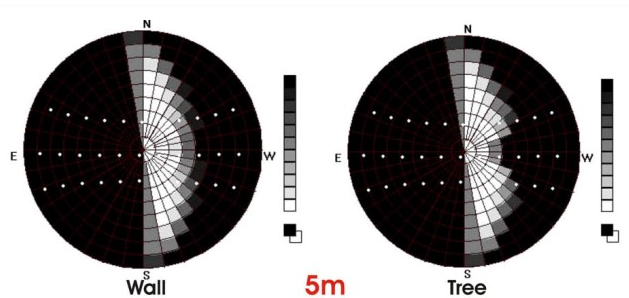
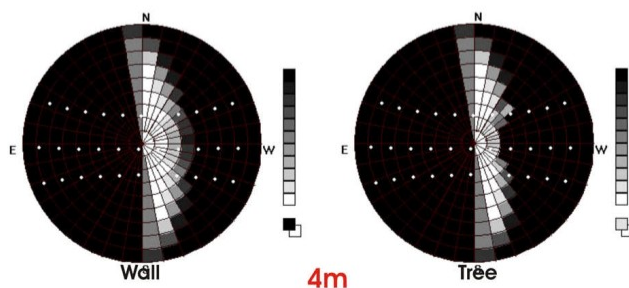
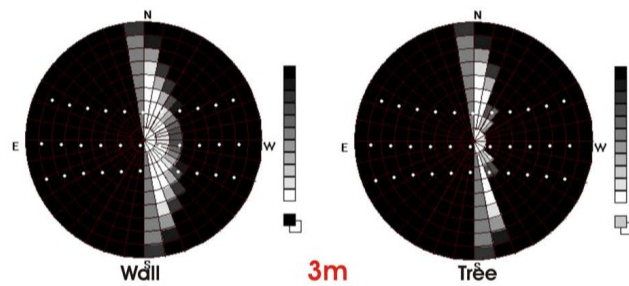
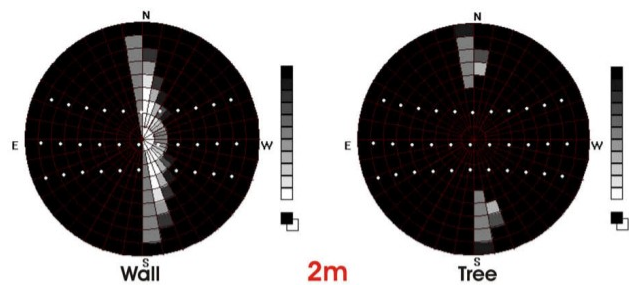

Correlation coefficients - Without tree condition

		Correlations							
		TAMeasured	0.0	0.5	0.8	1.0	2.0	5.0	10.0
TAMeasured	Pearson Correlation	1	.973**	.987**	.986**	.983**	.958**	.887**	.825**
	Sig. (2-tailed)		.000	.000	.000	.000	.000	.000	.000
	N	25	25	25	25	25	25	25	25
0.0	Pearson Correlation	.973**	1	.988**	.975**	.966**	.917**	.814**	.736**
	Sig. (2-tailed)	.000		.000	.000	.000	.000	.000	.000
	N	25	25	25	25	25	25	25	25
0.5	Pearson Correlation	.987**	.988**	1	.998**	.994**	.967**	.894**	.830**
	Sig. (2-tailed)	.000	.000		.000	.000	.000	.000	.000
	N	25	25	25	25	25	25	25	25
0.8	Pearson Correlation	.986**	.975**	.998**	1	.999**	.982**	.922**	.866**
	Sig. (2-tailed)	.000	.000	.000		.000	.000	.000	.000
	N	25	25	25	25	25	25	25	25
1.0	Pearson Correlation	.983**	.966**	.994**	.999**	1	.989**	.937**	.886**
	Sig. (2-tailed)	.000	.000	.000	.000		.000	.000	.000
	N	25	25	25	25	25	25	25	25
2.0	Pearson Correlation	.958**	.917**	.967**	.982**	.989**	1	.978**	.944**
	Sig. (2-tailed)	.000	.000	.000	.000	.000		.000	.000
	N	25	25	25	25	25	25	25	25
5.0	Pearson Correlation	.887**	.814**	.894**	.922**	.937**	.978**	1	.992**
	Sig. (2-tailed)	.000	.000	.000	.000	.000	.000		.000
	N	25	25	25	25	25	25	25	25
10.0	Pearson Correlation	.825**	.736**	.830**	.866**	.886**	.944**	.992**	1
	Sig. (2-tailed)	.000	.000	.000	.000	.000	.000	.000	
	N	25	25	25	25	25	25	25	25

** . Correlation is significant at the 0.01 level (2-tailed).

Correlation coefficients – With tree shading condition (Direct Effect)

		Correlations							
		TAMeasured	0.0	0.5	0.8	1.0	2.0	5.0	10.0
TAMeasured	Pearson Correlation	1	.958**	.967**	.960**	.952**	.915**	.845**	.791**
	Sig. (2-tailed)		.000	.000	.000	.000	.000	.000	.000
	N	25	25	25	25	25	25	25	25
0.0	Pearson Correlation	.958**	1	.980**	.959**	.944**	.881**	.780**	.706**
	Sig. (2-tailed)	.000		.000	.000	.000	.000	.000	.000
	N	25	25	25	25	25	25	25	25
0.5	Pearson Correlation	.967**	.980**	1	.996**	.991**	.958**	.889**	.833**
	Sig. (2-tailed)	.000	.000		.000	.000	.000	.000	.000
	N	25	25	25	25	25	25	25	25
0.8	Pearson Correlation	.960**	.959**	.996**	1	.999**	.979**	.925**	.878**
	Sig. (2-tailed)	.000	.000	.000		.000	.000	.000	.000
	N	25	25	25	25	25	25	25	25
1.0	Pearson Correlation	.952**	.944**	.991**	.999**	1	.988**	.942**	.899**
	Sig. (2-tailed)	.000	.000	.000	.000		.000	.000	.000
	N	25	25	25	25	25	25	25	25
2.0	Pearson Correlation	.915**	.881**	.958**	.979**	.988**	1	.983**	.956**
	Sig. (2-tailed)	.000	.000	.000	.000	.000		.000	.000
	N	25	25	25	25	25	25	25	25
5.0	Pearson Correlation	.845**	.780**	.889**	.925**	.942**	.983**	1	.994**
	Sig. (2-tailed)	.000	.000	.000	.000	.000	.000		.000
	N	25	25	25	25	25	25	25	25
10.0	Pearson Correlation	.791**	.706**	.833**	.878**	.899**	.956**	.994**	1
	Sig. (2-tailed)	.000	.000	.000	.000	.000	.000	.000	
	N	25	25	25	25	25	25	25	25

** . Correlation is significant at the 0.01 level (2-tailed).

Correlation coefficients – Without tree shading condition (Indirect Effect)

		Correlations							
		TAMeasured	0.0	0.5	0.8	1.0	2.0	5.0	10.0
TAMeasured	Pearson Correlation	1	.955**	.965**	.953**	.944**	.902**	.828**	.772**
	Sig. (2-tailed)		.000	.000	.000	.000	.000	.000	.000
	N	25	25	25	25	25	25	25	25
0.0	Pearson Correlation	.965**	1	.979**	.957**	.942**	.882**	.785**	.715**
	Sig. (2-tailed)	.000		.000	.000	.000	.000	.000	.000
	N	25	25	25	25	25	25	25	25
0.5	Pearson Correlation	.965**	.979**	1	.996**	.991**	.960**	.895**	.843**
	Sig. (2-tailed)	.000	.000		.000	.000	.000	.000	.000
	N	25	25	25	25	25	25	25	25
0.8	Pearson Correlation	.953**	.957**	.996**	1	.999**	.981**	.930**	.886**
	Sig. (2-tailed)	.000	.000	.000		.000	.000	.000	.000
	N	25	25	25	25	25	25	25	25
1.0	Pearson Correlation	.944**	.942**	.991**	.999**	1	.989**	.946**	.907**
	Sig. (2-tailed)	.000	.000	.000	.000		.000	.000	.000
	N	25	25	25	25	25	25	25	25
2.0	Pearson Correlation	.902**	.882**	.960**	.981**	.989**	1	.984**	.959**
	Sig. (2-tailed)	.000	.000	.000	.000	.000		.000	.000
	N	25	25	25	25	25	25	25	25
5.0	Pearson Correlation	.828**	.785**	.895**	.930**	.946**	.984**	1	.994**
	Sig. (2-tailed)	.000	.000	.000	.000	.000	.000		.000
	N	25	25	25	25	25	25	25	25
10.0	Pearson Correlation	.772**	.715**	.843**	.886**	.907**	.959**	.994**	1
	Sig. (2-tailed)	.000	.000	.000	.000	.000	.000	.000	
	N	25	25	25	25	25	25	25	25

** . Correlation is significant at the 0.01 level (2-tailed).

179: Plant Canopy Design in Modifying Urban Thermal Environment: Theory and Guidelines

Mohd Fairuz Shahidan ^{1*}, Philip Jones ²

Welsh School of Architecture, Cardiff University, Cardiff, United Kingdom^{1,2}
mfsc01@yahoo.com, JonesP@cardiff.ac.uk

Abstract

Recent growing interests in the urban heat island phenomenon originate from the consequences from improper design planning, increased urbanization and deterioration in the outdoor environment. This phenomenon invites understanding of the basic theories in modifying urban thermal environment by integrating the key microclimate components of the dynamic outdoor thermal cycle (wind velocity, humidity, temperature and radiation) in the whole design process. Such approach has been demonstrated in the use of vegetations and plant canopies in the fields of urban and landscape planning, architectural design and environmental engineering. In addition, good plant canopy arrangements and design approach had been shown to promote latent-heat evaporation and solar shading in significant way. These approaches, incorporated into the design process, could provide an equilibrium cycle in mitigating urban heat island. However, despite these and existing architectural planning and landscape design principles, many planting schemes are poorly constructed. Therefore, such schemes can be improved through understanding and implementation of effective urban thermal environment design theories and guidelines. This paper will describe the importance of investigating the impact of comprehensive relationships between plant canopy design parameter for thermal comfort and outdoor thermal environment.

Keywords: Plant Canopy Design, Outdoor Urban Microclimate Modification, Theory and Guidelines

1. Introduction

The culprits of the urban heat island phenomenon are recognised to be the consequences of improper design planning, increased urbanization and abrupt changes in the outdoor environment [1]. These man-made urbanization developments have created significant undesirable changes to the natural ecosystem and/or landscape. There are concerns about climate change worldwide and landscapes are increasingly replaced by stiff and sharp-edged roughness of building blocks with associated roads and hard surfaces. Now, rising concrete buildings have crowded out vegetation and trees [2]. On top, the variety of urban grids and buildings generates a wide range of different streets, squares, courts and open spaces that modify local climate into urban microclimates [3]. These changes posed deterioration in the urban areas, giving rise to problems with urban heat island.

Katzshner and colleagues defined *the* 'ideal' urban climate as an atmospheric situation within the Urban Canopy Layer with a high variation in time and space to develop inhomogeneous thermal conditions for man within a distance of 150 m. This should be free from air pollution and thermal stress by means of more shadow, ventilation and wind protection [4]. Combining good natural elements and effective landscape

design may provide the approach to create both sustainable urban development and desirable urban climate.

The modification of the urban climate can be targeted at four key microclimate components of the dynamic outdoor thermal cycle: wind velocity, humidity, temperature and radiation. A good quality landscape, with its own characteristic can be adapted on its technical and functionality to address these microclimates in the whole design development. This approach emphasises better appreciation of the climates in the basic design principles to provide a potential solution to the urban heat island phenomenon. For instance, by creating as much outdoor shading as possible, prevent solar radiation on building and ground, and actively utilize the cooling effect of the latent heat of evaporation [5].

In this paper, we describe the use of plant canopy design that integrates the microclimate components and landscape design, utilising the principles of basic sustainable design theories and guidelines. This design approach encompasses urban and landscape planning, architectural design and environmental engineering approach that are relevant to mitigate the effect of urban heat island.