EXPLORING NEW METHODOLOGIES FOR THE SYNTHESIS OF GARLIC METABOLITES



A Thesis Submitted to Cardiff University
in Fulfilment of the Requirement for the
Degree of Doctor of Philosophy
by **Andreia Filipa Ferreira da Silva Santos**

PhD thesis February 2019

Cardiff University

DECLARATION

This work has not been submitted in substance for any other degree or award at this or any other university or place of learning nor is being submitted concurrently in candidature for any degree or other award.

Signed(Andreia Filipa Ferreira da Silva Santos) Date

STATEMENT 1

This thesis is being submitted in partial fulfilment of the requirement for the degree of (insert MCh, MD, MPhil. PhD etc, as appropriate).

Signed (Andreia Filipa Ferreira da Silva Santos) Date

STATEMENT 2

This thesis is the result of my own independent work/investigation, except where otherwise stated, and the thesis has not been edited by third part beyond what is permitted by Cardiff University's Policy in the Use of Third Party Editors by Research Degree Students. Other sources are acknowledged by explicit references. The views expressed are my own.

Signed(Andreia Filipa Ferreira da Silva Santos) Date

STATEMENT 3

I hereby give consent for my thesis, if accepted, to be available online in the University's Open Access repository and for inter-library loan, and for the title and summary to be made available to outside organisations.

Signed(Andreia Filipa Ferreira da Silva Santos) Date

STATEMENT 4: PREVIOUSLY APPROVED BAR ON ACCESS

I hereby give consent for my thesis, if accepted, to be available online in the University's Open Access repository and for inter-library loan after expiry of a bar on access previously approved by the Academic Standards & Quality Committee.

Signed(Andreia Filipa Ferreira da Silva Santos) Date

ACKNOWLEDGEMENTS

This PhD thesis would have not been possible without the great support and help of many people. There are no words that can fully express how thankful I am for the time that these persons dedicated to me. I will try my best not to name all the important ones without whom this journey would not have been the same.

Frist, I would like to thank Professor Thomas Wirth, my supervisor, for giving me the opportunity to join his research group and work on this project. It allowed me to improve my general skills in organic chemistry and develop as scientist. I am grateful for his knowledge and guidance during my studies.

I am also grateful to Neem Biotech for sponsoring this project and for all the support along this journey. Thanks to Michael, Rob, Gareth and Danielle. A special thanks to Shaista, who I worked more closely, for all the positive support, suggestions and guidance.

Next, I would like to thank everyone that has been part of the Wirth research group as well as members of other research group at Cardiff University who have been of great support along this PhD. Baker, Rich, Mat, Simon, Florence, Ana, Ravi, Micol, Jihan, Tobi, Agatha, Rosaria, Xiaoping, Wenchao, Xiang-Yang, Marina, Mohamed, Paulina, Nasser, Haifa, Guilherme, Rossana, Adele, Tom, Alena, Saira, Frauke, Abdul, Nikklas, Joey, Chrissi, James, Kurt, Ben, Nichola, it's been a pleasure. I would also like to special thank my students James, Sabrina, Laura, Jarno and Matt for their work and contributions to my thesis.

I would like to acknowledge all the technical and non-technical staff at the school of chemistry, specially to Dr Rob Jenkins, Robin Hicks, Simon Waller and Tom Williams. I also need to say thanks to the staff at the EPSRC National Mass Spectrometry Service Centre for their excellent service providing spectrometric data.

I would like to thank all my family and friends in Portugal for their support. Special thanks to my parents Alvaro and Carla, my sisters Rita and Mariana and my lovely grandmother Maria. Also to my mother-in-law, Ana and my great friend Tixa. This would have not been possible without your support and endless encouragement.

Finally, I would like to thank my husband Joel, who since the beginning supported my decision to move from Portugal to UK. Thanks for moving your life with me and for supporting every instant of this journey. Definitely I would have not make it without you and your unconditional love.

Filipa Silva

Dedicated to Joel and “Ervilhinha”

LIST OF ABBREVIATIONS

°C	Degree Celsius
μL	Microliter
A	Amperes
AIBN	Azobisisobutyronitrile
ACCN	1,1'-Azobis(cyanocyclohexane)
aq.	Aqueous
APCI	Atmospheric pressure chemical ionisation
Ar	Aryl
BPR	Back-pressure regulator
C	Concentration
Cat.	Catalytic
Conv.	Conversion
CV	Column volume
<i>d.r</i>	Diastereomeric ratio
EDG	Electron donating group
eq.	Equivalent(s)
ESI	Electrospray ionisation
Et	Ethyl
EtOH	Ethanol
EWG	Electron withdrawing group
F mol ⁻¹	Faraday per mole
g	Gram
GP	General procedure
h	Hour(s)
HFIP	1,1,1,3,3,3-Hexafluoro-2-propanol
HOMO	Highest occupied molecular orbital
HRMS	High resolution mass spectroscopy
Hz	Hertz
IR	Infrared
J	Coupling constant
LUMO	Lowest unoccupied molecular orbital
M	Molarity [mol/l]

mA	Milliamperes
m.p.	Melting point
m/Z	Mass over charge ratio
m-CPBA	m-chloroperbenzoic acid
Me	Methyl
MHz	Megahertz
min	Minute(s)
mL	Millilitre
mmol	Millimole
mL/min	Millilitre per minute
mol%	Mole percentage
nm	Nanometre
NMR	Nuclear magnetic resonance
ppm	Parts per million
Ph	Phenyl
psi	Pounds per square inch
PTFE	Polytetrafluoroethylene
Rf	Retention factor
rt	Room temperature
sat.	Saturated
TFA	Trifluoroacetic acid
THF	Tetrahydrofuran
TLC	Thin layer chromatography
r.t.	Residence time (Flow system)
vs	versus
V	Volts

ABSTRACT

The therapeutic benefits of garlic are related to the high concentrations of organosulfur compounds present. Allicin is the main biologically active component of garlic extracts. Due to its instability, it rapidly decomposes into a variety of organosulfur compounds. Among the decomposition products of allicin, ajoene is biologically more stable and active.

In this thesis, an efficient total synthesis of ajoene was accomplished from easily available starting materials. In addition, the protocol allowed the synthesis of several ajoene derivatives. Moreover, the protocol proved to be amendable to scale-up and provided 169 g of ajoene in ~90% purity.

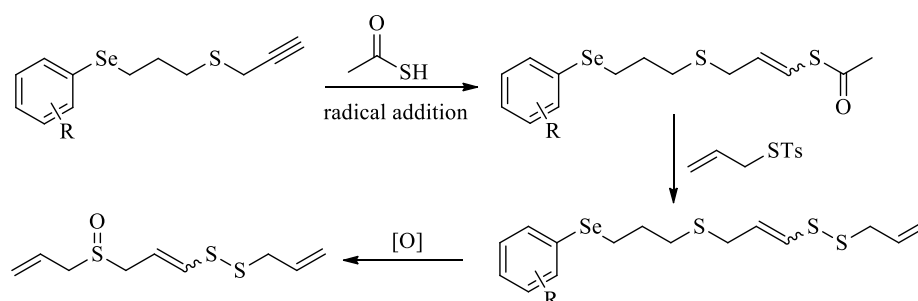

A second synthetic protocol for the synthesis of ajoene from simple and easily available starting materials has also been investigated in batch and in flow.

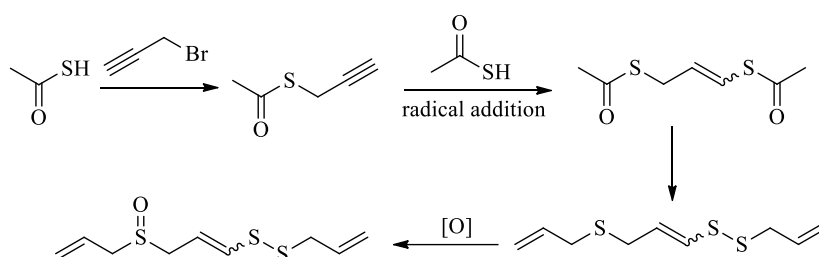

Finally, a rapid, versatile and selective oxidation system has been developed for a variety of sulfides and disulfides. The method allowed the synthesis of allicin in moderate yields.

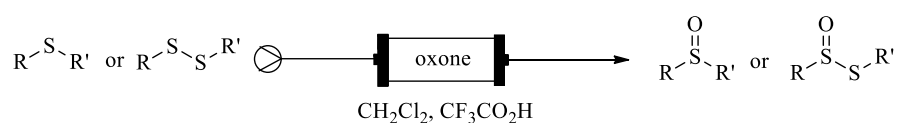

TABLE OF CONTENTS

Chapter 1: Introduction	1
1.1. Organosulfur chemistry of garlic	2
1.1.1. Introduction.....	2
1.1.2. Chemistry of the constituents of garlic	2
1.1.3. Therapeutic properties of garlic metabolites.....	10
1.2. Introduction to continuous flow chemistry	11
1.2.1. Continuous flow chemistry set-up	11
1.2.2. Benefits of continuous flow chemistry	12
1.3. References	21
Chapter 2: Introduction to Selenoxide Elimination	25
2.1. Introduction	26
2.2. Oxidation of selenides	27
2.2.1. Rate of oxidation.....	27
2.3. Rate of selenoxide elimination.....	27
2.3.1. Influence of the substituent on the alkyl group.....	27
2.3.2. Influence of the substituent on the aryl group	28
2.4. Side reactions in selenoxide <i>syn</i> -eliminations.....	30
2.5. Conclusion.....	32
2.6. References	33
Chapter 3: Short (total) synthesis of ajoene	35
3.1. Ajoene	36
3.2. Methods for the synthesis of Ajoene and analogues	37
3.2.1. Block's biomimetic synthesis	37
3.2.2. University of Cape Town (UCT) synthesis	39
3.2.3. Limitation of the synthesis.....	42
3.3. Objectives.....	42
3.4. Short (total) synthesis of ajoene	43
3.5. Synthesis of aryl selenide precursors	44

3.5.1.	Synthesis of propargylic thioether containing the aryl selenide moiety	44
3.5.2.	Radical addition of thioacetic acid to the alkyne	46
3.5.3.	S-Sulfenylation.....	49
3.5.4.	Oxidation of the sulfide and selenide / selenoxide elimination	50
3.5.5.	Synthesis of ajoene and derivatives	53
3.6.	Scale-up of the synthesis	54
3.7.	Conclusions	56
3.8.	References	57
Chapter 4: An alternative approach to the synthesis of ajoene.....		59
4.	Introduction and objective	60
4.1.	An alternative approach to the synthesis of ajoene	61
4.1.1.	Propargylation of thioacetic acid	62
4.1.2.	Radical addition reaction of thioacetic acid.....	62
4.2.	Selective substitution of the bis-thioacetate	69
4.2.1.	Batch reaction	69
4.2.2.	Flow reaction	72
4.3.	Oxidation of compound 127.....	75
4.4.	Conclusions and future work	76
4.5.	References	77
Chapter 5: Selective oxidation of sulfides in flow chemistry		78
5.	Introduction	79
5.1.	Sulfoxides.....	79
5.2.	Methods for the oxidation of sulfides to sulfoxides.....	79
5.2.1.	Methods for oxidation of sulfides in flow.....	80
5.3.	Synthesis of Allicin via oxidation of diallyl disulfide.....	82
5.4.	Objectives.....	84
5.5.	Selective oxidation of sulfides in a packed-bed reactor with oxone	84
5.5.1.	Previous results	84
5.5.2.	Optimization of the reaction conditions using thioanisole	86
5.5.3.	Substrate scope of sulfides.....	88

5.5.4.	Optimization of the reaction conditions using dibenzyl disulfide	90
5.5.5.	Substrate scope of disulfides.....	92
5.5.6.	Synthesis of allicin via oxidation of diallyl disulfide	93
5.5.7.	Proposed mechanism	94
5.6.	Conclusions	95
5.7.	References	96
Chapter 6:	Experimental Part	98
6.1.	General considerations	99
6.2.1.	Thin-layer chromatography	100
6.2.2.	Column Chromatography.....	100
6.3.	Physical Data.....	100
6.3.1.	¹ H NMR Spectroscopy.....	100
6.3.2.	¹³ C NMR Spectroscopy.....	101
6.3.3.	Mass Spectroscopy.....	101
6.3.4.	IR Spectroscopy	101
6.3.5.	Melting points	101
6.4.	Experimental data for Chapter 3: Short (total) synthesis of Ajoene	102
6.4.1.	Synthesis of aryl selenide precursors	102
6.4.2.	Radical addition of thioacetic acid to the alkyne	105
6.4.3.	<i>S</i> -Sulfenylation.....	109
6.4.4.	Oxidation of the sulfide and selenide/selenoxide elimination	111
6.4.5.	Synthesis of <i>S</i> -Sulfenylating reagents.....	115
6.4.6.	Synthesis of ajoene derivatives	119
6.5.	Experimental data for Chapter 4: An alternative approach to the synthesis of ajoene	126
6.5.1.	Propargylation of thioacetic acid	126
6.5.2.	Radical addition reaction of thioacetic acid to alkyne	127
6.5.3.	Selective substitution of the bis-thioacetate.....	129
6.5.4.	Oxidation of compound 127	134
6.6.	Experimental data for Chapter 5: Selective oxidation of sulfides	
	in flow chemistry.....	135
6.6.1.	Fixed Bed Column Preparation.....	135

6.6.2. General Procedure for oxidation of sulfides and disulfides.....	135
6.7. References	145

CHAPTER 1: Introduction

1.1. Organosulfur chemistry of garlic

1.1.1. Introduction

Garlic (*Allium sativum*) is a specie in the genius *Allium* and member of the amaryllis family (Amaryllidaceae), along with onions, chives and shallots. It is known for its strong and pungent smell which is conferred by the organosulfur compounds produced when the garlic cloves are crushed or damaged.

For a long time, garlic has been used worldwide not only as food or seasoning, but also as folk remedy for the treatment of several ailments. As early as 3000 B.C, civilizations including Egyptians, Greeks, Indian, Romans and Chinese documented the use of garlic for the treatment of heart conditions, headache, bites, wounds, ulcers, and tumours.^[1] Nowadays, products based on garlic extracts are the best-selling preventive medicines being used as a dietary supplement by many people. Garlic possesses prophylactic properties, a term that includes antibacterial, antiviral, antifungal and antiprotozoal properties.^[2] In addition, it also has beneficial effects on the cardiovascular and immune systems.^[3] Although, at the beginning, the cause of the therapeutic benefits of garlic was unknown, later was confirmed to be due to presence of organosulfur compounds. These compounds are released when the garlic cloves are damaged as a mechanism of defence against potential threats.

1.1.2. Chemistry of the constituents of garlic

Although scientific research on garlic started more than 200 years ago, it was only in the 19th century that the first investigations towards the molecule or molecules responsible for garlic's properties were carried out. Throughout the investigations, several extraction techniques were used to extract the organosulfur compounds from garlic. The composition of the garlic oil extract, the material isolated from garlic, depended on the conditions of extraction employed.

1.1.1.1. Diallyl Monosulfide, diallyl sulfide and other polysulfides

In 1844, the German chemist Wertheim undertook the earliest chemical studies of garlic.^[4] He attributed garlic's appeal "mainly to the presence of sulfur-containing, liquid body, the so called "garlic oil" obtained by steam distillation of the garlic bulbs. Wertheim suggested for the garlic oil extract, the name of "allyl sulfur", from the Latin name of the plant *Allium Sativum*, and for the hydrocarbon group in the oil the name allyl.

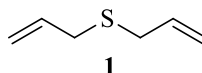

Figure 1.1. Diallyl sulfide

In 1891, another German chemist, Semmler, isolated diallyl disulfide **2**, as a major compound, along with small amounts of diallyl trisulfide **3**, diallyl tetrasulfide **4** and diallyl polysulfides by carrying out a fractional distillation of the garlic bulbs under reduced pressure.^[5] The diallyl sulfide **1** isolated by Wertheim was not isolated under the milder conditions applied by Semmler. This led to the conclusion that diallyl sulfide was product of the degradation of the polysulfides due to the prolonging heating at elevated temperature employed by Wertheim.

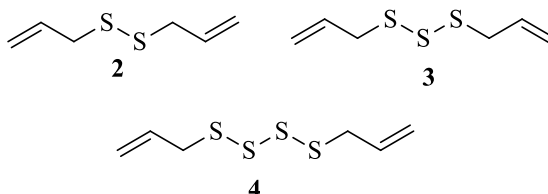

Figure 1.2 Diallyl polysulfides isolated by Semmler.

In 1991, Lawson *et al.* demonstrated that the composition of the garlic oil obtained by steam distillation is more complex, since many others sulfides could be identified using high performance liquid chromatography analysis (Figure 1.3).^[5]

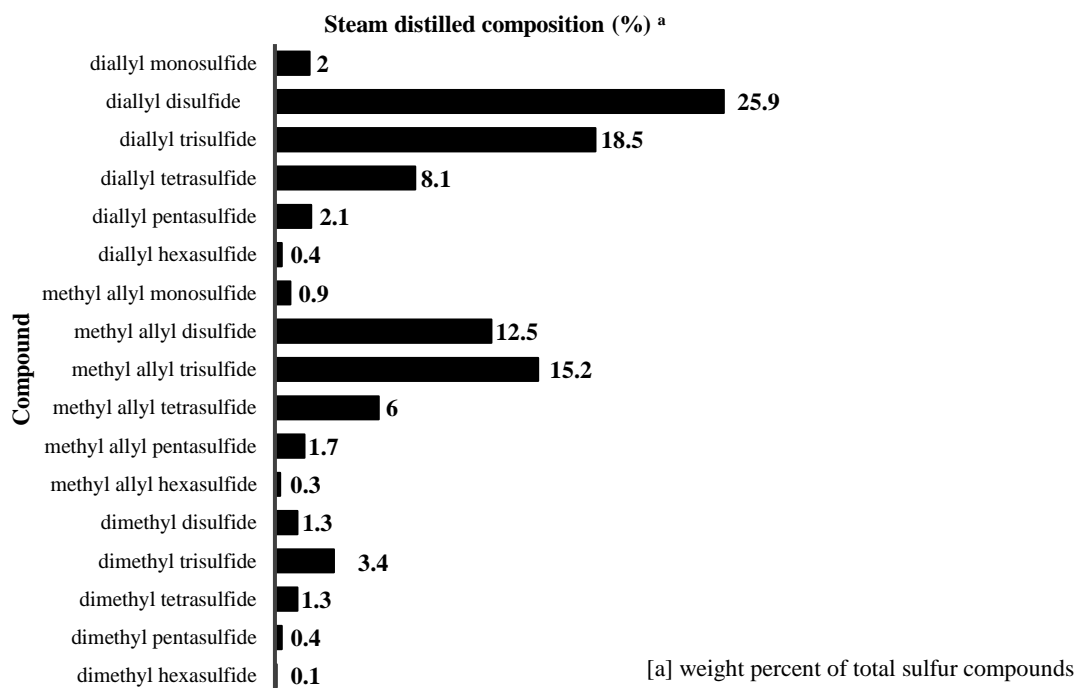

Figure 1.3 Composition of steam-distilled garlic oil

1.1.2.1. Allicin

In 1944, Cavallito and Bailey carried out investigations regarding the antibacterial properties of garlic. They observed that whilst raw garlic was a potent inhibitor to the growth of Gram-negative and Gram-positive bacteria, the compounds of Semmler's fractional distillations exhibited greatly reduced antibacterial activity. At this stage, they postulated that extraction methods less vigorous than steam distillation would produce rather different sulfur compounds. Thus, by performing an ethanolic extraction of garlic at room temperature and subsequent filtration, they isolated an oily compound, with a smell characteristic of crushed garlic which they termed allicin **5** (Figure 1.4), from the Latin name of the garlic plant, *Allium sativum*.^[6]

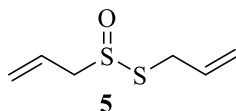

Figure 1.4 Allicin 5

The same authors shown that allicin **5** possessed about 1% of the antibacterial activity of penicillin and was effective against the Gram-negative organism which were practically unaffected by penicillin.^[6]

Alliin is a thermally unstable thiosulfinate that rapidly forms diallyl disulfide upon heating. It is soluble in water to the extent of approximately 2.5% at 10 °C and miscible with alcohol, benzene and ether. In 1947, Stoll and Seebeck synthesized allicin through mild oxidation of diallyl disulfide, effectively proving its chemical structure.^[7]

The discovery of allicin and characterization of its properties explained the loss in antibacterial activity on steam distillations of garlic, and also the characteristic odour of crushed garlic. However, the absence of odour in intact garlic was not understood.

In 1945, Cavallito *et. al.* carried out a dried low-temperature acetone extraction of garlic and neither diallyl disulfide **2** or allicin **5** were produced. Therefore, he suggested that none of these compounds were present in intact garlic cloves, and that allicin is produced on crushing of garlic via enzymatic conversion of thermostable precursor present in the whole garlic.^[8]

1.1.2.2. Alliin and the formation of allicin

In 1948, Stoll and Seebeck, using low temperature ethanol extraction of frozen garlic bulbs, isolated and identified an oxygenated sulfur compound amino acid that is present in large quantities in garlic cloves and which they named alliin **6** (Figure 1.5).^[9]

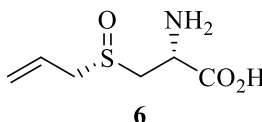

Figure 1.5 Alliin **6**

Alliin **6** was found to be the stable precursor that is converted to allicin **6** by the action of an enzyme named alliinase which is also present in the cloves. Only one isomer of alliin ((+)-*S*-allyl-*L*-cysteine-sulfoxide) was found to be present, which itself did not exhibited antimicrobial activity.

In 1958, Fujiwara *et al.* demonstrated that garlic cloves also contain minor quantities of other *S*-alk(en)yl cysteine sulfoxides (ACSOs) such as, methiin **7** and isoalliin **8**.^[10] Alliin **6** is the most abundant ACSOs in garlic cloves (85% total ACSOs), followed by methiin **7** (10%) and the least abundant is isoalliin **8** (5%) (Figure 1.6). The amounts of ACSOs are dependent on garlic's growth conditions.^[11]

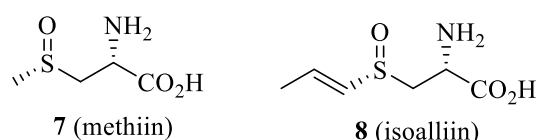
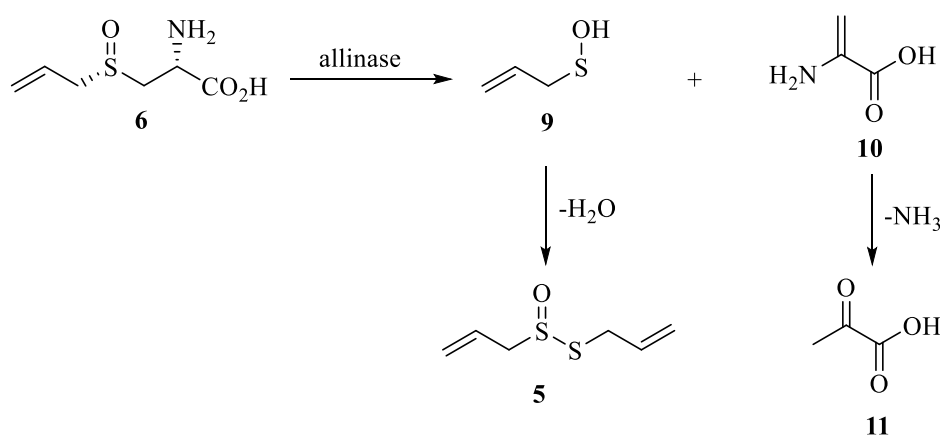

Figure 1.6. *S*-alkyl-L-cysteine sulfoxide found in garlic

In 1950, Stoll and Seebeck reported the synthesis of racemic alliin **6** via alkylation of L-cysteine with allyl bromide to form deoxyalliin, followed by oxidation with hydrogen peroxide.^[12] In the following year, the same authors proved possible the separation of the stereoisomers. Using fractional recrystallisation with 60% aqueous acetone, they isolated the chiral (*R_cS_c*)-(+)-*S*-allyl-L-cysteine-sulfoxide.^[13]

As mentioned earlier, allinase is the enzyme responsible for the conversion of alliin **6** to allicin **5**. It was first isolated by Stoll and Seebeck in 1949.^[14] In garlic, the enzyme allinase is stored in the vacuole, while alliin **6** is stored in the cytosol. This compartmentalization explains the reason why formation of allicin **5** only occurs on damage to the clove, which brings the enzyme and substrate molecules into contact.



Scheme 1.1 Allinase-catalyzed conversion of alliin **6** to allicin **5**

Alliin **6** is converted into 2-propenesulfenic sulfenic acid **9** and 2-amino acrylate **10** via interaction with allinase (Scheme 1.1). Since allyl sulfenic acid **9** is a very unstable

compound, it rapidly self-condenses eliminating water and producing alliin **5**. Hydrolysis of 2-amino acrylic acid **10** gives ammonia and pyruvic acid **11**.

1.1.2.3. Alliin degradation and related products

Alliin **5** is an unstable and reactive compound that can react in many ways yielding a variety of products. In aqueous environments at 20 °C, alliin is completely converted into diallyl disulfide (66%), diallyl sulfide (14%) and diallyl trisulfide (9%) after 24 hours.^[15] In polar solvents, such as methanol, alliin is predominantly decomposed into *E*-ajoene and *Z*-ajoene.^[16] In non-polar solvents, such as hexane, alliin decomposes producing 2-vinyl-1,3-dithiin and 3-vinyl-1,2-dithiin.^[16] The reactions and intermediates involved in the degradation of alliin and which afford these products are discussed below.^[17]

Alliin **5** can undergo intramolecular decomposition via a Cope-type rearrangement producing 2-propenesulfenic acid **9** and thioacrolein **12** (Scheme 1.2).^[18]

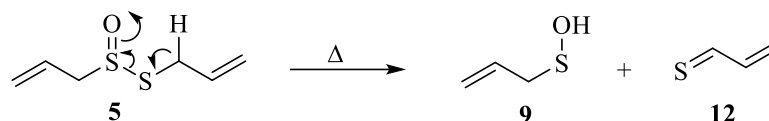

Scheme 1.2 Thermal decomposition of alliin **5 via Cope-type rearrangement**

Thioacrolein **12** is highly reactive and readily dimerizes with itself, through a Diels-Alder reaction yielding two regioisomeric vinyl dithiins, 3-vinyl-4*H*-1,3-dithiin **13** and 2-vinyl-4*H*-1,2-dithiin **14** (Scheme 1.3). The vinyl dithiin **13** is produced as the major isomer and the vinyl dithiin **14** as the minor isomer in a 4.4:1 ratio of **13:14**.^[1]

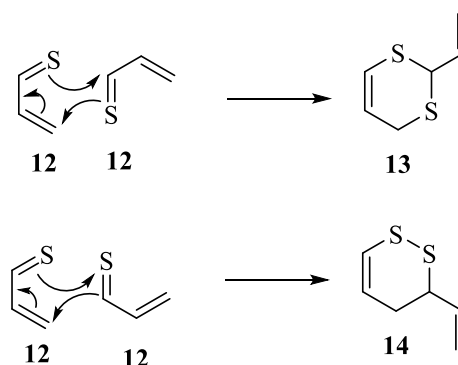

Scheme 1.3. Dimerization of thioacrolein **12 producing vinyl dithiins **13** and **14****

2-Propenesulfenic acid **9** is also very reactive and readily condenses with itself regenerating alliin **5** (Scheme 1.4).^[19]

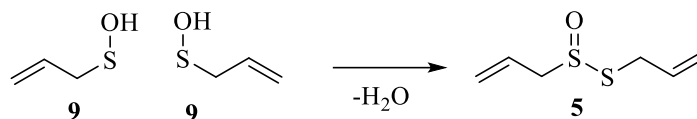

Scheme 1.4. Self-condensation of allyl sulfenic acid 9 producing alliin 5

Alliin **5** can undergo *S*-thiolation affording the trisulfide cation intermediate **15** (Scheme 1.5). Hydrolysis of intermediate **15** gives allyl alcohol **17**, together with a second trisulfide intermediate **16**. The latter is hydrolysed to compound **18** and perthiol, 2-propene-1-sulfenothioic acid **19**. The reaction of perthiol **19** with another molecule of alliin **5** affords diallyl trisulfide **3** along with 2-propenesulfenic acid **9**.

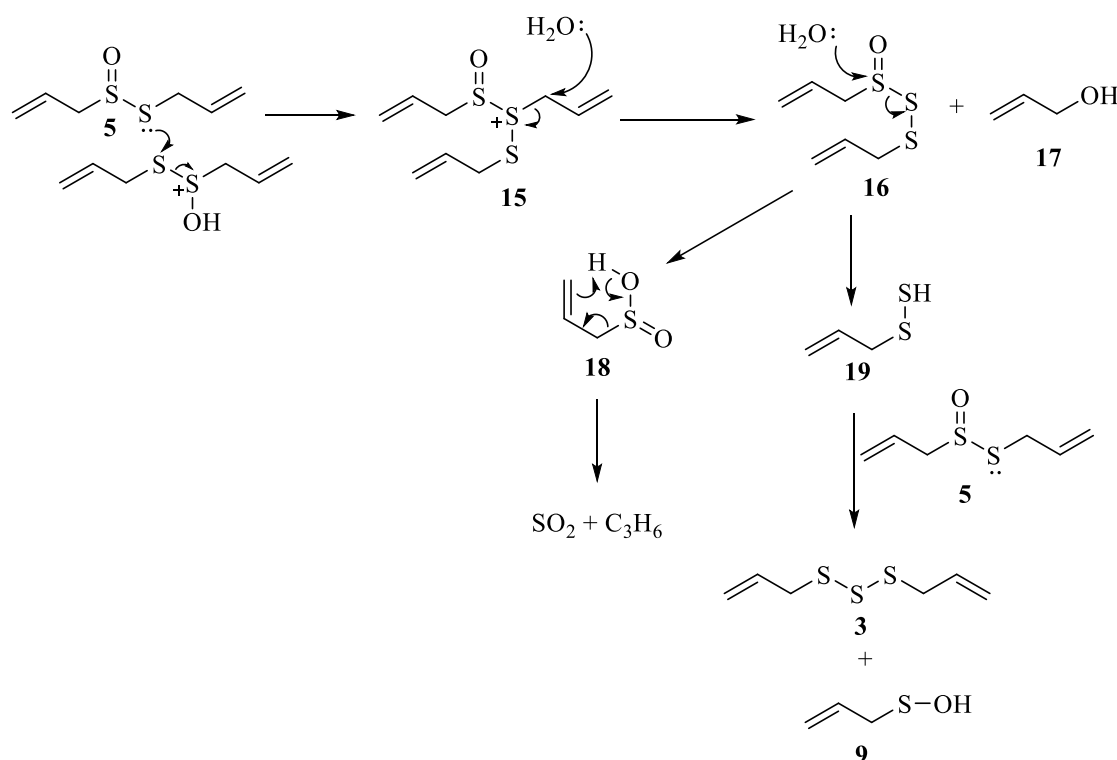

Scheme 1.5. Proposed mechanism for the formation of trisulfide 3

Alternatively, trisulfide cation intermediate **15** can undergo β -elimination to give carbocation **20**. 1,4-Nucleophilic addition of 2-propene sulfenic acid **9** forms (*E/Z*)-ajoene **21** (Scheme 1.6).

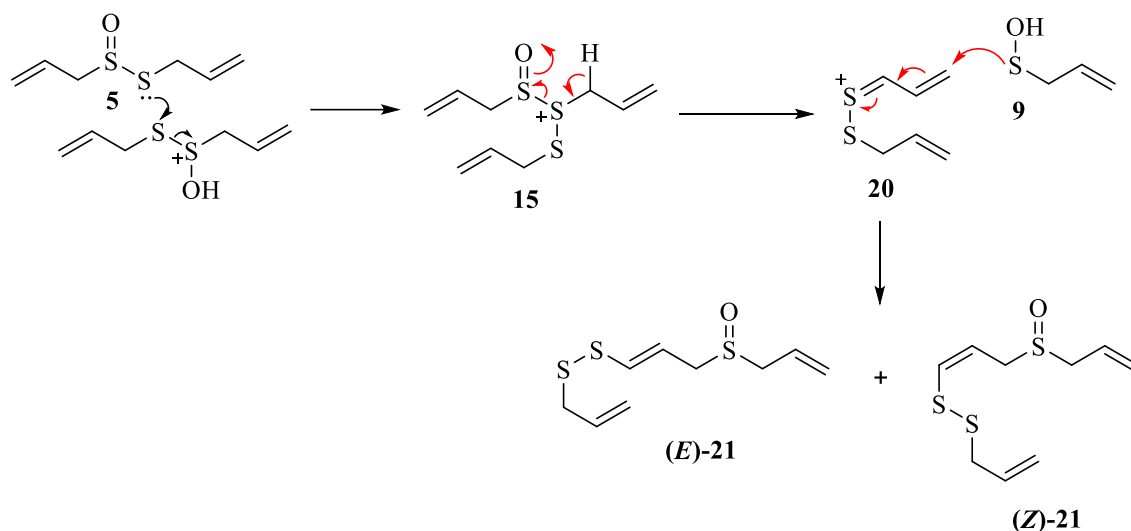

Scheme 1.6. Proposed mechanism for the formation of (*E/Z*)-ajoene

Alliin **5** undergoes hydrolysis producing 2-propenethiol **22** and 2-propenesulfinic acid **18** (Scheme 1.7). Compound **18** is unstable and rapidly decomposes into sulfur dioxide and propene via retro-ene type reaction. Compound **22** reacts with a molecule of alliin **5** producing diallyl disulfide **2** and 2-propenesulfinic acid **9**.

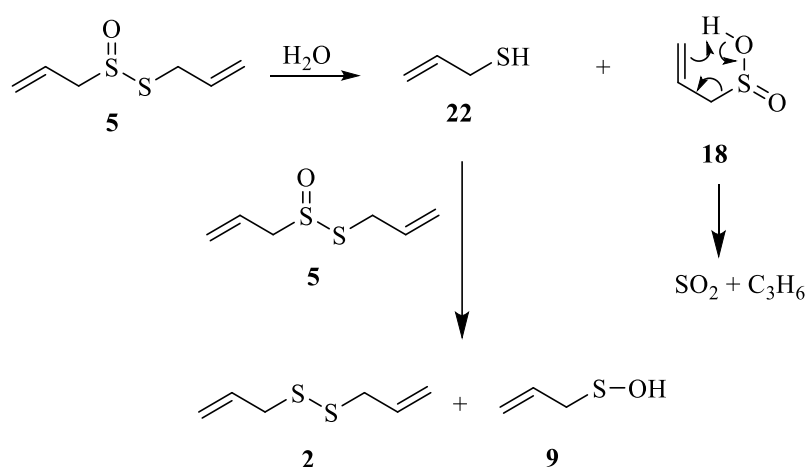

Scheme 1.7. Proposed mechanism for the formation of diallyl disulfide 2

As mentioned before, diallyl sulfide is thought to be produced by decomposition of diallyldi- and diallyltrisulfide.

1.1.3. Therapeutic properties of garlic metabolites

For many years, garlic has been used for the treatment and prevention of several diseases. Although the active ingredients responsible for garlic's therapeutic benefits were unknown, research on garlic has led to the identification of such ingredients. It has been demonstrated that allicin and/or its breakdown products are the main biologically active ingredients in garlic.^[20]

The antimicrobial activity of garlic is widely attributed to allicin. It was shown that allicin has sulfhydryl modifying activity and is capable of inhibiting sulfhydryl enzymes.^[21] Pure allicin has demonstrated i) antibacterial activity against a wide range of Gram-negative and Gram-positive bacterias, including multidrug-resistant strains of *Escherichia coli*;^[22] ii) antifungal activity, particularly against *Candida albicans*;^[23] iii) antiparasitic activity, including some major human intestinal protozoan parasites, e.g. *Giardia lamblia*;^[24] and iv) antiviral activity.^[25] In addition, allicin has also exhibited anticancer properties.^[26]

Allyl sulfenic acid is postulated to be responsible for the antioxidant properties of garlic.^[18] Dithiins have shown to possess antithrombotic activity.^[27]

Diallyl sulfide, diallyl disulfide and diallyl trisulfide have shown i) antibacterial activity against antibiotic resistant *S. aureus*;^[28] ii) antiprotozoal activity against *Candida albicans*;^[29] and iii) anticancer activity against different cancer cell lines.^[30-32]

Ajoene is considered one of the most important breakdown products of allicin due to its greater stability and similar biological properties to allicin. It has been reported to be responsible for the antithrombotic effects of garlic.^[17] Moreover, ajoene has exhibited antimicrobial,^[33] hepatoprotective,^[34] anticancer^[35] and anti-diabetic effects.^[36] More recently, ajoene has shown the ability to act as a quorum sensing inhibitor (QSI) against *Pseudomonas aeruginosa* and *Staphylococcus aureus* and it could be utilized for the treatment of chronic biofilm infections.^[37]

1.2. Introduction to continuous flow chemistry

Over the past decade, continuous flow technologies have received immense interest in academia and industry. An increasing number of organic reactions have been successfully performed using this methodology and reported in the literature.^[38,39] On laboratory scale, a typical continuous flow process is conducted in microreactors, a small-diameter device (≤ 1 mm inner diameter) in which the reaction takes place. Reagents are pushed into these microreactor devices at well-defined flow rates. In organic chemistry, the microreactor is therefore compared to a round bottom flask generally used to perform reactions. Conducting organic synthesis in flow chemistry offers several benefits over conventional batch chemistry, such as better mixing, more efficient heat transfer and easy scale-up. These benefits are related to the small diameters of the channels of the microreactors. The high surface area to volume ratio and the small reactor volumes within the microreactors offer unique transport capabilities for matter and energy.^[40,41] However, there are some drawbacks to flow chemistry. Due to the small sized diameters within the microreactors, all reactants, reagents, intermediates and products must be all in solution in order to prevent clogging. The use of viscous solvents and the back pressure created in the system can cause issues which could also limit certain reactions. Nevertheless, with the variety of microreactors commercially available nowadays, continuous flow set-ups can be designed in order to suit specific reactions needs. Although microreactors can sometimes outperform batch, financial and time costs of some processes can outweigh the benefits flow has to offer.

1.2.1. Continuous flow chemistry set-up

A general continuous flow chemistry setup is described in Scheme 1.8. The reagents are pumped through a micromixer into the reactor at predetermined flow rates using pumps. The reaction time in a flow process is defined as the residence time (RT) and is determined by the ratio between the reactor volume and the total flow rate. The reactors can be customized according with the reaction needs in terms of length and reactor type, such as coils (polytetrafluoroethylene (PTFE)), perfluoroalkoxy (PFA), stainless steel, among others), microchips, fixed-bed reactors and tube-in-tube reactors. In addition, the reactor can also be heated or cooled allowing a precise control of the temperature.

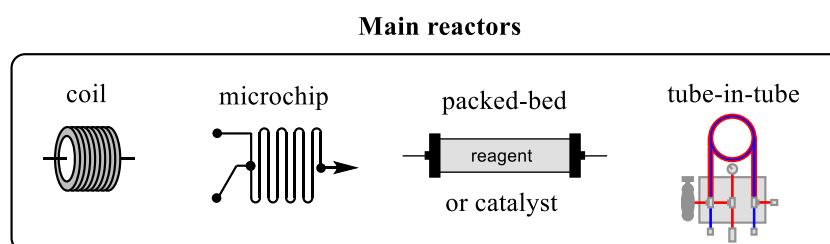
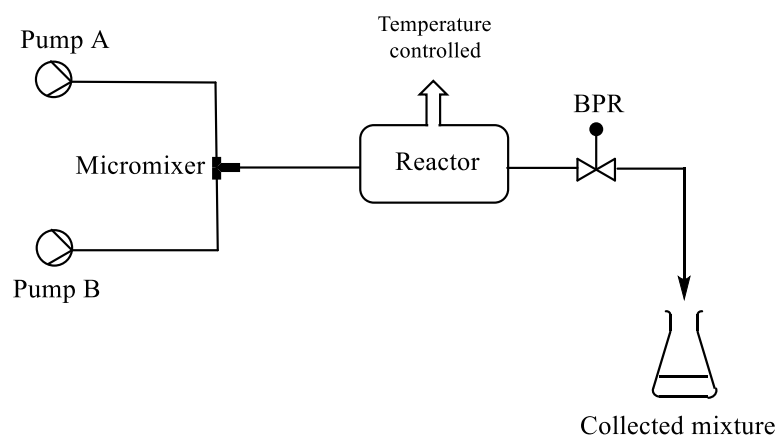

Scheme 1.8. General scheme for a continuous flow chemistry setup

Right after the reactor, a back-pressure regulator is normally installed which allow the control of the reaction pressure. This gives researchers the opportunity to carried out reactions which were not possible in batch set-up, such as heating organic solvents at much higher temperatures than the corresponding boiling point.

1.2.2. Benefits of continuous flow chemistry

As mentioned in Section 1.2, the benefits of using flow reactor technology are related to the small diameters of the channels of the microreactors. The high surface area to volume ratio and the small reactor volumes within the microreactors offer unique transport capabilities for matter and energy.^[40,41] Therefore, the major benefits for using flow conditions are:

- Rapid and efficient mixing of reagents;
- Improved thermal control;
- Small volumes of reagents;
- Handling of dangerous/intermediates;
- Residence time control;
- Easy to scale-up;
- In-line analysis;
- Multistep processes;

- Automated process optimization;
- Reduced overall costs (consumption of reagents/solvents);

1.2.2.1. Rapid and efficient mixing

In all chemical reactions, mixing is important as it allows for a rapid association of the reagents. Batch reactors exhibit different mixing mechanism compared to microreactors. The Reynolds number (Re) is used to predict flow patterns in fluids as it describes the relationship between the inertial forces and the viscous forces. This is represented in the following equation:

$$Re = \frac{\text{inertial forces}}{\text{viscous forces}} = \frac{vL}{\nu}$$

Equation 1. Reynolds equation

[v] velocity of the object relative to the fluid (m/s);

[L] travelled length/diameter of the fluid (m), [ν] kinematic viscosity

Ranges of Re divide mixing into three different mixing mechanisms: laminar, transitional, and turbulent. Low Re values ($Re < 2000$) describes laminar flow, whereas high Re values ($Re > 3000$) describe turbulent flow.

In conventional batch chemistry mixing achieved using mechanical or magnetic stirrers is laminar or transitional. The turbulent mixing near the stir bar forces the movement of molecules to the outer parts via diffusion. Diffusion times are dependent on the surface area of the reactor. In a round bottom flask, due to generally large surface areas, diffusion is slow leading to concentration gradients of the reagents. This could be problematic, in case of exothermic reactions, leading to the formation of hot spots and undesired side reactions, thus decreasing the reaction yields and selectivity. Moreover, for fast reactions this is can also lead to low yields or poor selectivity as homogeneity of the solution is not reached before the reaction proceeds.^[42]

In flow microreactors, as the surface areas are smaller than in a round bottom flask, diffusion is faster, which gives a more uniform and rapid distribution of the reagents. Therefore, it can be used to overcome the problems encountered in batch. More efficient mixing within the microreactors leads to better conversions as well as better control of reaction selectivity.

Yoshida *et al.* have been using the increased mixing of flow chemistry in the field of alkyl lithium chemistry to allow for selective reactions of such highly reactive compounds.^[43] Their work shows the ability to control reactions effectively where the speed of the reaction is faster than the mixing and consequently how the small diffusion distances in microreactors leads to selectivity. An example of this is shown in Scheme 1.9.

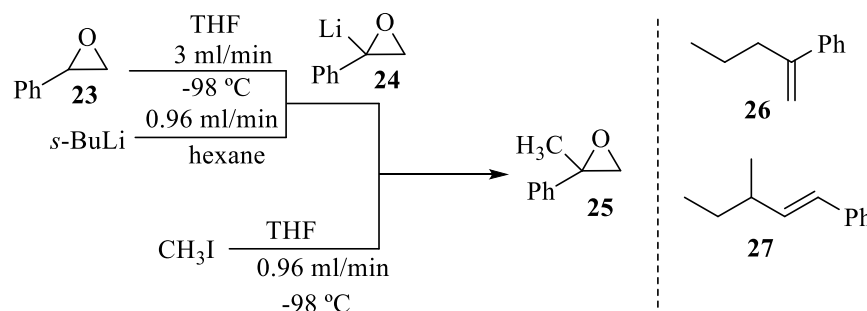

Scheme 1.9 Lithiation of styrene epoxide followed by quenching with MeI in a microreactor

The authors showed that the use of microreactor technologies could allow for a huge increase in selectivity, avoiding the formation of side products **26** and **27**. The small diffusion distances allow for sufficient concentrations of MeI to interact with the lithiated species **24**. With a reaction time in the order of seconds, product **25** was obtained in 88% yield. In addition, this was achieved without the use of TMEDA needed for high selectivity in batch procedure.

1.2.2.2. Improved heat control

The temperature at which a chemical reaction takes place is the most important parameter influencing the reaction kinetics and product quality. Increasing a reaction temperature usually increases the reaction rate, but in most cases, also decreases product selectivity associated with the formation of side products.

In the case of exothermic reactions, removing heat is important in order to avoid the formation of hot spots which can lead to unfavorable selectivities and formation of by-products. Therefore, precise temperature control is an important factor to achieve optimal reaction conditions. One of the most important advantages of microreactors is the efficient heat control. Due to the high surface-area to volume ratio within the microreactors, the rate of heat transfer is directly proportional to the heat-transferring surface area, making

the ability to exchange heat orders of magnitude better than can be achieved in batch.^[44] Thus, the formation of hot spots, associated with batch mode, can be reduced and uncontrolled hazardous exothermic processes avoided.

Exothermic and potentially explosive reactions such as, for example, the nitration of aromatics, have benefited from the improved heat control achieved in flow chemistry. Roberge *et al.* described an highly efficient and rapid method for the nitration of phenol in a microreactor.^[45]

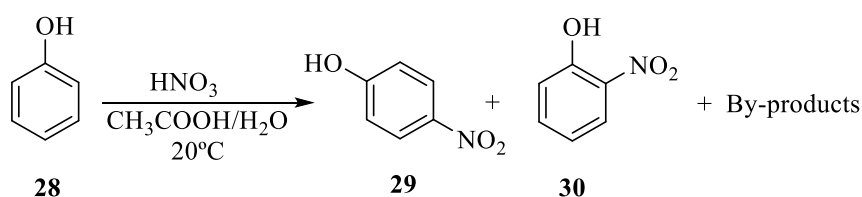

Conditions	Yield (%)	Ratio of 29:30	By-products (area %)*
Batch	21%	0.6	77
Flow	77	1	17

* Nitrated solution was analyzed by GC

Scheme 1.10 Nitration of phenol in continuous flow

This reaction generally yields products **29** and **30**. However, it also leads the formation of many by-products, such as dinitro compounds, hydroquinone and polymeric products which can be associated to hazardous runaway scenarios. In order to achieve higher selectivities and avoid runaway scenarios, the temperature of the reaction needs to be precisely controlled, which can be challenging in such exothermic reactions, especially when performed in large batches. In fact, the authors demonstrated that in batch conditions, products **29** and **30** were obtained in poor yields along with a large amount of by-products and the reaction temperature was difficult to control. Best results were obtained when the reaction was performed in a glass microreactor demonstrating the greater control of heat control achieved within flow chemistry compared to batch chemistry.

On the other hand, due to stability of the microreactors, higher temperatures can be employed. Solvents can be superheated above their boiling point with high level of safety

by pressurizing the system.^[46] An example of the application of “superheating” conditions was described by Ley *et al.* (Scheme 1.11).^[47]

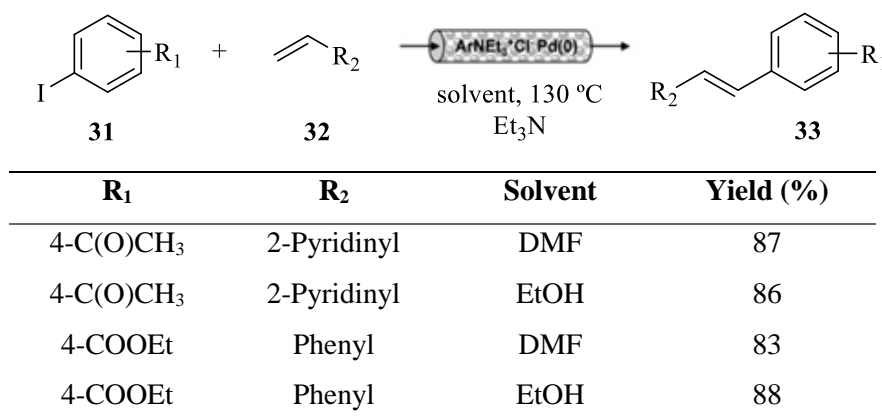

Scheme 1.11 Heck coupling reactions using ligand-free monolithic Pd(0) in continuous flow mode

The authors showed that in an automated reactor for performing Heck coupling reactions in continuous flow conditions, DMF, a solvent commonly used for Heck reactions could be replaced by more benign ethanol. This solvent in superheating conditions under pressure not only gave high yields but also provided easier workup conditions (Scheme 1.11).

1.2.2.3. Residence time control

In conventional batch chemistry, reaction time usually ranges from minutes to hours. If a reaction is completed within seconds it can be difficult to control or impossible to perform in batch. Microreactors are ideal platforms to perform this type of reactions since residence times can be adjusted to less than seconds using the required flow rate. Thus, this feature of microreactor enables reactions involving transient and reactive intermediates, that could not be otherwise handled or stored in traditional batch mode.^[45]

Kemperman *et al.* showed the importance of this benefit of flow chemistry during the investigation of the Moffatt-Swern oxidation of different alcohols.^[48]

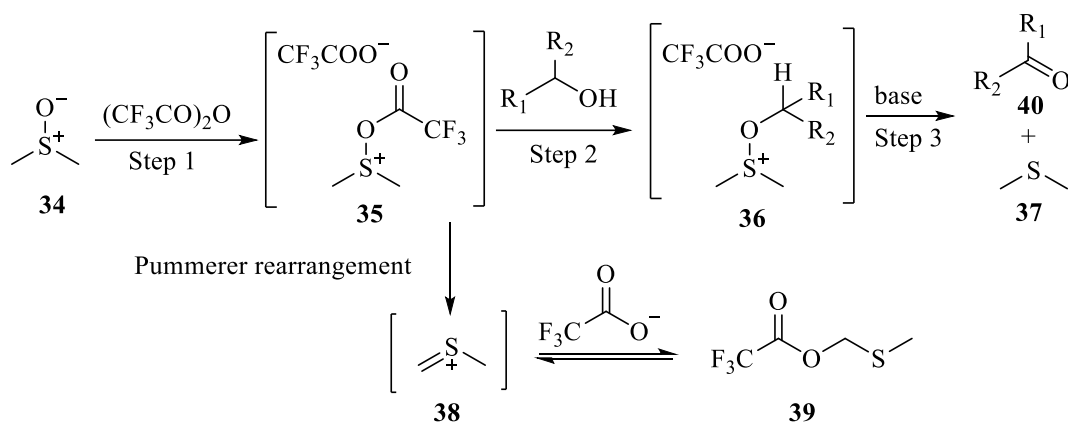

Scheme 1.12 Moffatt-Swern oxidation in continuous flow

Short residence times applied in the microreactor, reduced side-reactions such as, the exothermic Pummerer rearrangement of the unstable intermediate **35**. As a consequence, the process could be operated at remarkably high temperature in comparison with batch, 0-20 °C instead of -70 °C.

1.2.2.4. Safety

The small volumes of reagents required in the microreactor lead to high levels of safety by limiting the exposure and handling of potentially hazardous or toxic materials. Furthermore, the small dimensions of microreactors promote efficient heat exchange and allow high-pressure conditions, thus reducing dangers involved with runaway reactions and extreme conditions, respectively. For these reasons, many highly exothermic reactions and reactions involving explosive or aggressive reagents have been performed in microreactors.^[49]

Among these reactions are organometallic chemistry,^[50] hydrogenations,^[51] ozonolysis,^[52] nitrations,^[53] diazonium salts^[54] as well as reactions with diazo compounds,^[55] azides,^[56] hydrazine,^[57] fluorine gas,^[58] phosgene^[59], cyanide,^[60] and concentrated sulfuric acid.^[61]

An example of the increased safety achieved within flow chemistry was demonstrated by Villani *et al.* during studies of the ring-expansion reaction of *N*-Boc-4-piperidone with ethyl diazoacetate (Scheme 1.13).^[62]

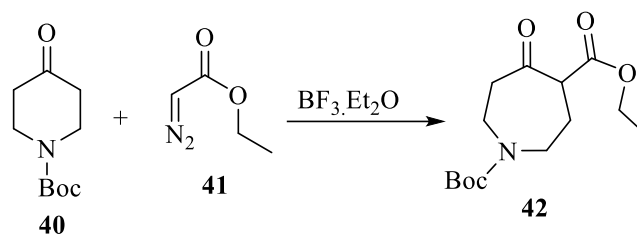

Scheme 1.13 Ring-expansion reaction

In batch, the reaction occurred with good yield (90%) at -25°C but it was limited to small scale because it is highly exothermic. In fact, after the addition of the diazo reagent the temperature raised to 45°C and the evolution of N_2 caused overpressure in the reactor. In order to safely scale up the process, the authors performed the reaction under flow conditions. The ring expansion proceed smoothly and safely with precise control to give the desired product **42** in 89% yield, with a residence time of 1.8 min and with throughput of 91 g/h.

1.2.2.5. Easy scale-up

In conventional batch chemistry, scaling-up a chemical reaction often represents a challenging process since many problems such as, runaway reactions, inefficient mixing or by-product formation, may arise. Modifications of laboratory synthetic protocols and optimization of the reaction parameters are often required in order to avoid such issues and achieve mass production. Microreactors can provide a good platform for scaling up reactions as parameters such temperature, pressure and flow rate can be well controlled with respect to batch process. Synthetic conditions set up for few milligrams can be easily used for grams or even kilograms without requiring optimization.

There are three approaches for scaling up flow reactions: increasing the reactor size, numbering up and scaling out.^[63] The simplest method is to increase the tubing diameter and therefore the reactor volumes. This can be useful for reactions that are not highly dependent on the heat transfer and diffusion. Numbering up is the process of using several reactors in parallel, therefore running the same system without changing concentration, residence times or heat transfer. This is advantageous as original conditions don't need to be modified, although, the drawback is the requirement of multiple pumps which may demand high investment cost. Finally, the third method that is being employed in industrial processes is scaling out. This means running a process over a longer period to

obtain more product. Although very useful for scaling up reactions, from milligrams to grams, this process cannot be used to prepare multikilogram amounts of materials. An example of this approach in use has been demonstrated by Styring *et al.* (Scheme 1.14)^[64]

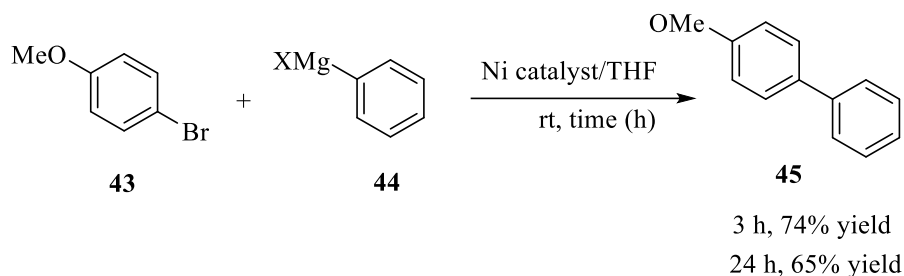

Scheme 1.14 Kumada coupling of 4-bromoanisole with phenylmagnesium halide to form 3-methoxybiphenyl under Ni catalysis in flow.

The authors demonstrated a Kumada coupling of 4-bromoanisole with aryl magnesium halides within a meso flow reactor under Ni catalysis. Simply running the reaction for 24 h, they were able to produce 137 g of product **45** without significant loss of the reactor efficiency.

1.2.2.6. Multistep synthesis

Flow process can allow integration of separation and purification methods to enable multistep synthesis in continuous fashion. This could lead to a very flexible and rapid manufacture of small quantities of drugs or similar molecules on-demand. Technologies such as, solvent switching systems,^[65] liquid/liquid separation, ^[66] in line chromatography,^[67] in-line filtration ^[68] have been developed to enable multistep synthesis.

Many multistep syntheses have been published in the literature using such technologies.^[69] Jamison *et al.* reported a multistep synthesis of ibuprofen **49** in continuous flow (Scheme 1.15).^[70] The synthesis was completed in three steps including an in-flow extraction from readily available starting materials within 3 min residence time. They showed that 8.09 g of ibuprofen **49** could be produced every hour making this protocol a powerful tool for chemical processing.

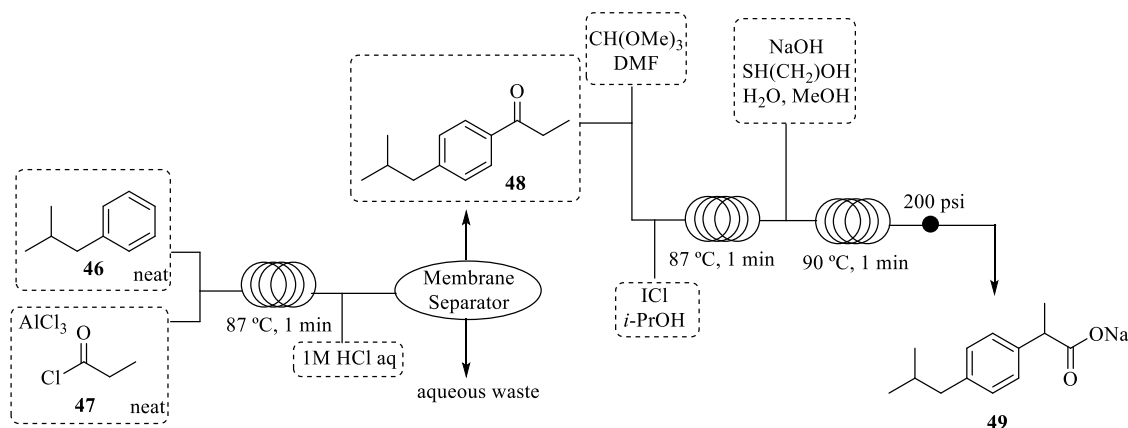

Scheme 1.15 Multistep synthesis of ibuprofen

Ley *et al.* developed a multistep protocol for the synthesis of natural products such as Oxomariditine^[71] and Spiregnien A,^[72] as well as drug molecules such as Tamoxifen^[50].

1.2.2.7. In-line analysis

The small amounts of reagents required for experiments and the high level of control over the reaction conditions makes flow chemistry the ideal platform for rapid optimization and analysis of reactions. For this purpose, several techniques for in-line analysis of reactions have been developed. These includes spectroscopic techniques such as, UV/Vis and Raman spectroscopy,^[73] NMR,^[74] infrared spectroscopy,^[75] mass spectrometry,^[76] gas chromatography,^[77] and HPLC analysis^[78].

1.3. References

- [1] E. Block, *Garlic and Other Alliums: The Lore and the Science*, Thomas Graham House, Science Park, Cambridge, **2010**.
- [2] J. C. Harris, S. L. Cottrell, S. Plummer, D. Lloyd, *Appl. Microbiol. Biotechnol.* **2001**, *57*, 282–286.
- [3] H. D. Reuter, *Phytomedicine* **1995**, *2*, 73–91.
- [4] T. Wertheim, *Liebigs Ann.* **1844**, *51*, 289–291.
- [5] L. D. Lawson, Z. Y. J. Wang, B. G. Hughes, *Planta Med.* **1991**, *57*, 363–370.
- [6] C. J. Cavallito, J. H. Bailey, *J. Am. Chem. Soc.* **1944**, *66*, 1950–1951.
- [7] A. Stoll, E. Seebeck, *Experientia* **1947**, *3*, 114–115.
- [8] C. J. Cavallito, J. H. Bailey, J. S. Buck, *J. Am. Chem. Soc.* **1945**, *67*, 1032–1033.
- [9] A. Stoll, E. Seebeck, *Helv. Chim. Acta* **1948**, *31*, 189–210.
- [10] M. Fujiwara, H. Watanabe, K. Matsui, *J. Biochem.* **1954**, *41*, 29–39.
- [11] E. Block, *Angew. Chem. Int. Ed* **1992**, *31*, 1135–1178.
- [12] A. Stoll, E. Seebeck, *Experientia* **1950**, *6*, 330–332.
- [13] A. Stoll, E. Seebeck, *Helv. Chim. Acta* **1951**, *34*, 481–487.
- [14] A. Stoll, E. Seebeck, *Helv. Chim. Acta* **1949**, *32*, 197–205.
- [15] M. H. Brodnitz, V. J. Pascale, L. Van Derslice, *J. Agric. Food Chem.* **1971**, *19*, 273–275.
- [16] H. P. Koch, L. D. Lawson, *Garlic: The Science and Therapeutic Application of Allium Sativum L. and Related Species*, Williams & Wilkins, Baltimore, **1996**.
- [17] E. Block, S. Ahmad, J. L. Catalfamo, M. K. Jain, R. Apitz-Castro, *J. Am. Chem. Soc.* **1986**, *108*, 7045–7055.
- [18] V. Vaidya, K. U. Ingold, D. Pratt, *Angew. Chem. Int. Ed.* **2009**, *48*, 157–60.
- [19] V. Gupta, K. S. Carroll, *Biochim. Biophys. Acta* **2014**, *1840*, 847–875.
- [20] L. D. Lawson, *Phytomedicines Eur.* **1998**, *691*, 176–209.
- [21] E. D. Wills, *Enzyme* **1956**, *63*, 514–520.
- [22] S. Ankri, D. Mirelman, *Microbes Infect.* **1999**, *1*, 125–129.
- [23] S. R. Davis, *Mycoses* **2005**, *48*, 95–100.
- [24] D. Mirelman, D. Monheit, S. Varon, *J. Infect. Dis.* **1987**, *156*, 243–244.

- [25] Y. Tsai, L. Cole, L. Davis, S. Lockwood, V. Simmons, G. Wild, *Planta Med.* **1985**, *5*, 460–461.
- [26] A. S. Weisberger, J. Pensky, *Cancer Res.* **1958**, *18*, 1301–1308.
- [27] H. Nishimura, C. Hanny Wijaya, J. Mizutani, *J. Agric. Food Chem.* **1988**, *36*, 563–566.
- [28] S. M. Tsao, M. C. Yin, *J. Antimicrob. Chemother.* **2001**, *47*, 665–670.
- [29] P. Avato, F. Tursi, C. Vitali, V. Miccolis, V. Candido, *Phytomedicine* **2000**, *7*, 239–243.
- [30] J. G. Lin, G. W. Chen, C. C. Su, C. F. Hung, C. C. Yang, J. H. Lee, J. G. Chung, *Am. J. Chin. Med.* **2002**, *30*, 315–325.
- [31] G. C. Wallace IV, C. P. Haar, W. A. Vandergrift, P. Giglio, Y. N. Dixon-Mah, A. K. Varma, S. K. Ray, S. J. Patel, N. L. Banik, A. Das, *J. Neurooncol.* **2013**, *114*, 43–50.
- [32] A. Borkowska, N. Knap, J. Antosiewicz, *Nutr. Cancer* **2013**, *65*, 711–717.
- [33] R. Naganawa, N. Iwata, K. Ishikawa, H. Fukuda, T. Fujino, A. Suzuki, *Appl. Environ. Microbiol.* **1996**, *62*, 4238–4242.
- [34] A. Hattori, N. Yamada, T. Nishikawa, H. Fukuda, T. Fujino, *Biosci. Biotechnol. Biochem.* **2001**, *65*, 2555–2557.
- [35] T. Nishikawa, N. Yamasa, A. Hattori, H. Fukuda, T. Fujino, *Biosci. Biotechnol. Biochem.* **2002**, *66*, 2221–2223.
- [36] A. Hattori, N. Yamada, T. Nishikawa, H. Fukuda, T. Fujino, *J. Nutr. Sci. Vitaminol.* **2005**, *51*, 382–384.
- [37] T. H. Jakobsen, M. Van Gennip, R. K. Phipps, M. S. Shanmugham, L. D. Christensen, M. Alhede, M. E. Skindersoe, T. B. Rasmussen, K. Friedrich, F. Uthe, et al., *Antimicrob. Agents Chemother.* **2012**, *56*, 2314–2325.
- [38] V. H. F. Darvas, G. Dormán, Ed. , *Flow Chemistry*, Walter De Gruyter GmbH, Berlin/Boston, **2014**.
- [39] T. Wirth, Ed. , *Microreactors in Organic Chemistry and Catalysis*, Wiley-VCH, Weinheim, **2003**.
- [40] E. G. Verugo, *Chemical Reactions and Processes under Flow Conditions*, RSC Green Chemistry, **2010**.
- [41] J. Y. V. Hessel, J. C. Schouten, A. Renken, Y. Wang, Ed. , *Handbook of Micro*

- Reactors*, Wiley-VCH, Weinheim, **2009**.
- [42] P. Watts, C. Wiles, *Chem. Commun.* **2007**, 5, 443–467.
- [43] A. Nagaki, E. Takizawa, J. I. Yoshida, *Chem. Eur. J.* **2010**, 16, 14149–14158.
- [44] S. Taghavi-Moghadam, A. Kleemann, G. Golbig, *Org. Process Res. Dev.* **2001**, 5, 652–658.
- [45] J. I. Yoshida, A. Nagaki, T. Yamada, *Chem. Eur. J.* **2008**, 14, 7450–7459.
- [46] J. Wegner, S. Ceylan, A. Kirschning, *Adv. Synth. Catal.* **2012**, 354, 17–57.
- [47] N. Nikbin, M. Ladlow, S. V. Ley, *Org. Process Res. Dev.* **2007**, 11, 458–462.
- [48] J. J. M. Van Der Linden, P. W. Hilberink, C. M. P. Kronenburg, G. J. Kemperman, *Org. Process Res. Dev.* **2008**, 12, 911–920.
- [49] M. Movsisyan, E. I. P. Delbeke, J. K. E. T. Berton, C. Battilocchio, S. V. Ley, C. V. Stevens, *Chem. Soc. Rev.* **2016**, 45, 4892–4928.
- [50] P. R. D. Murray, D. L. Browne, J. C. Pastre, C. Butters, D. Guthrie, S. V. Ley, *Org. Process Res. Dev.* **2013**, 17, 1192–1208.
- [51] M. Irfan, T. N. Glasnov, C. O. Kappe, *Chem. Sus. Chem.* **2011**, 4, 300–316.
- [52] F. Lévesque, P. H. Seeberger, *Angew. Chem. Int. Ed.* **2012**, 51, 1706–1709.
- [53] A. A. Kulkarni, *Beilstein J. Org. Chem.* **2014**, 10, 405–424.
- [54] N. Oger, E. Le Grogne, F. X. Felpin, *Org. Chem. Front.* **2015**, 2, 590–614.
- [55] S. T. R. Müller, T. Wirth, *Chem. Sus. Chem.* **2015**, 8, 245–250.
- [56] M. M. E. Delville, P. J. Nieuwland, P. Janssen, K. Koch, J. C. M. van Hest, F. P. J. T. Rutjes, *Chem. Eng. J.* **2011**, 167, 556–559.
- [57] A. Deangelis, D. H. Wang, S. L. Buchwald, *Angew. Chem. Int. Ed.* **2013**, 52, 3434–3437.
- [58] G. Sandford, in *Mod. Synth. Process. React. Fluorinated Compd. Prog. Fluor. Sci.*, Elsevier Inc., **2016**, pp. 339–348.
- [59] S. Fuse, N. Tanabe, T. Takahashi, *Chem. Commun.* **2011**, 47, 12661–12663.
- [60] D. R. J. Acke, C. V. Stevens, *Green Chem.* **2007**, 9, 386–390.
- [61] L. Audiger, K. Watts, S. C. Elmore, R. I. Robinson, T. Wirth, *Chem. Sus. Chem.* **2012**, 5, 257–260.
- [62] X. Zhang, S. Stefanick, F. J. Villani, *Org. Process Res. Dev.* **2004**, 8, 455–460.
- [63] N. G. Anderson, *Org. Process Res. Dev.* **2012**, 16, 852–869.

- [64] P. Styring, A. I. R. Parracho, *Beilstein J. Org. Chem.* **2009**, *5*, 1–10.
- [65] B. J. Deadman, C. Battilocchio, E. Sliwinski, S. V. Ley, *Green Chem.* **2013**, *15*, 2050–2055.
- [66] X. Jiang, J. Li, R. Zhang, Y. Zhu, J. Shen, *Org. Process Res. Dev.* **2008**, *12*, 888–891.
- [67] A. G. O’Brien, Z. Horváth, F. Lévesque, J. W. Lee, A. Seidel-Morgenstern, P. H. Seeberger, *Angew. Chem. Int. Ed.* **2012**, *51*, 7028–7030.
- [68] R. J. Ingham, C. Battilocchio, D. E. Fitzpatrick, E. Sliwinski, J. M. Hawkins, S. V. Ley, *Angew. Chem. Int. Ed.* **2015**, *54*, 144–148.
- [69] D. Webb, T. F. Jamison, *Chem. Sci.* **2010**, *1*, 675–680.
- [70] D. R. Snead, T. F. Jamison, *Angew. Chem. Int. Ed.* **2015**, *54*, 983–987.
- [71] I. R. Baxendale, J. Deeley, C. M. Griffiths-Jones, S. V. Ley, S. Saaby, G. K. Tranmer, *Chem. Commun.* **2006**, *24*, 2566–2568.
- [72] C. F. Carter, H. Lange, D. Sakai, I. R. Baxendale, S. V. Ley, *Chem. Eur. J.* **2011**, *17*, 3398–3405.
- [73] W. Ferstl, T. Klahn, W. Schweikert, G. Billeb, M. Schwarzer, S. Loebbecke, *Chem. Eng. Technol.* **2007**, *30*, 370–378.
- [74] M. V. Gomez, H. H. J. Verputten, A. Díaz-Ortíz, A. Moreno, A. De La Hoz, A. H. Velders, *Chem. Commun.* **2010**, *46*, 4514–4516.
- [75] C. F. Carter, H. Lange, S. V. Ley, I. R. Baxendale, B. Wittkamp, J. G. Goode, N. L. Gaunt, *Org. Process Res. Dev.* **2010**, *393*, 393–404.
- [76] D. L. Browne, S. Wright, B. J. Deadman, S. Dunnage, I. R. Baxendale, R. M. Turner, S. V. Ley, *Rapid Commun. Mass Spectrom.* **2012**, *26*, 1999–2010.
- [77] P. L. Mills, J. F. Nicole, *Ind. Eng. Chem. Res.* **2005**, *44*, 6435–6452.
- [78] M. Rasheed, T. Wirth, *Chem. Today* **2011**, *29*, 54–56.

**CHAPTER 2: Introduction to Selenoxide
Elimination**

2.1. Introduction

The selenoxide *syn*-elimination is a powerful synthetic method in olefin-forming reactions and it has been used in the preparation of many synthetically useful compounds including natural products. It was first discovered by Jones *et al.* in 1970, during the synthesis of a chiral steroidal selenoxide.^[1] The required selenoxides can be easily prepared by oxidation of the corresponding selenides with a variety of readily available oxidants. The presence of a β -hydrogen leads to the *syn*-elimination producing an alkene together with selenenic acid (Scheme 2.1). The reaction is driven by the strong polarization of the Se-O bond and the high basicity of the oxygen atom, as well as the cleavage of the relatively weak C-Se bond. The reaction requires milder conditions than other pyrolytic *syn*-eliminations such as ester pyrolysis,^[2] Chugaev,^[3] Cope^[4] and sulfoxide eliminations,^[5] etc., often carried out at or below room temperature.

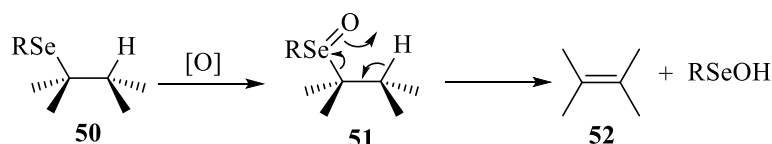

Scheme 2.1 Selenoxide elimination leading to alkenes

Jones *et al.* proposed an intramolecular mechanism via a five-membered ring transition state to explain the *syn*-elimination. This mechanism was supported by Sharpless, who applied the method utilized by Cram to determine the stereochemistry of amine oxides and related pyrolytic eliminations (Scheme 2.2)^[6] Thus, oxidation of *erythro*-selenide **53** afforded *Z*-alkene **55** as a minor product, while that of *threo*-selenide **57** gave only *E*-alkene **59**.

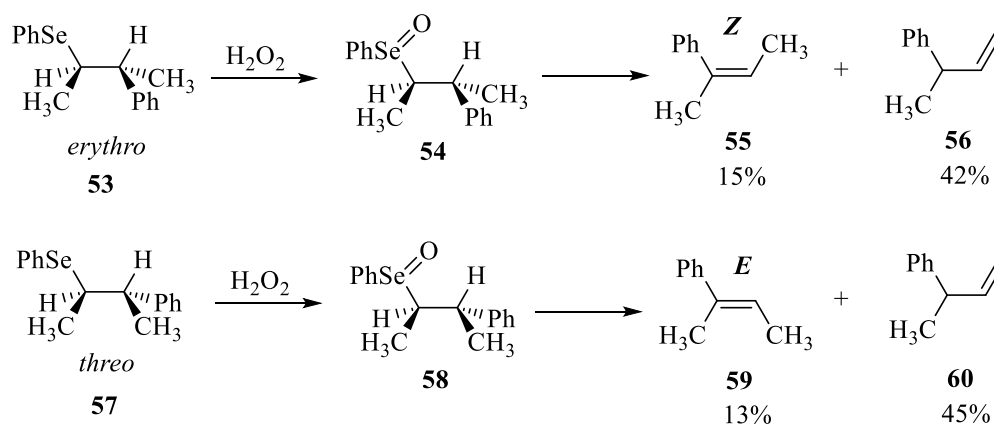

Scheme 2.2. Reaction pathway for selenoxide proved by Sharpless

2.2. Oxidation of selenides

The selenoxide elimination usually occurs *in situ* by oxidation of alkyl aryl selenides with a suitable oxidizing agent. Aqueous hydrogen peroxide is widely employed, most often in dichloromethane or THF at 0 °C or room temperature.^[7] Stronger oxidizing agents (e.g. peracids, ozone) are used in the preparation of the selenoxides at low temperatures (e.g. –78 °C), followed by subsequent pyrolysis to promote the elimination.^{[8][9]} Peracetic acid and *m*-CPBA are generally used in chloroform, dichloromethane or THF. Ozone is typically used in solvents such as ether and dichloromethane. Sodium metaperiodate in aqueous methanol is used sometimes as mild alternative to the preceding reagents.^[10] Other oxidizing agents that have been used for this purpose includes *t*-butyl hydroperoxide,^[11] *t*-butyl hypochlorite,^[12] *N*-bromo- and *N*-chlorosuccinimide,^[12] singlet oxygen,^[13] Jones reagent,^[14] sodium perborate,^[15] oxaziridines,^[16] potassium superoxide and 2-nitrobenzenesulfonyl chloride.^[17]

2.2.1. Rate of oxidation

In 2008, Schiesser *et al.* demonstrated by simple competitive experiments that electron-withdrawing substituents stabilize aryl selenides toward oxidative elimination, while electron-donating groups accelerate the oxidation process.^[18] Electron-withdrawing substituents on the aryl group (e.g. NO₂, CF₃) are assumed to decrease the rate of the oxidation by reducing the electron density on selenium, while donating groups (e.g. MeO, Me) should have the opposite effect.

2.3. Rate of selenoxide elimination

Alkyl aryl selenides are generally used as starting compounds when selenoxide elimination is used to introduce a double bond into the alkyl group unambiguously. The rate of elimination is influenced by the introduction of substituents into either aryl or alkyl group.

2.3.1. Influence of the substituent on the alkyl group

In 1977, Reich *et al.* studied the effect of substituents on the alkyl group in the rate of selenoxide elimination (Scheme 2.3)^[19] They showed that the rate of elimination was

increased by the introduction of α -substituents and decreased by the introduction of β -substituents, regardless of the electron-donating or withdrawing nature of the substituent.

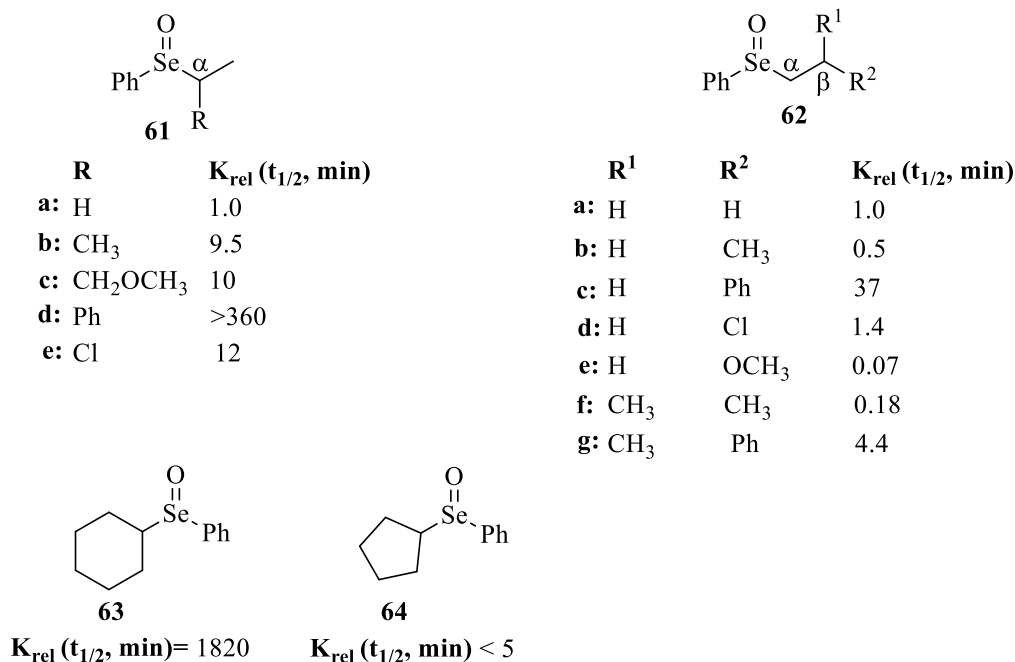

Scheme 2.3 Rates of elimination of a series of alkyl selenoxides measured in CDCl₃ at 38 °C.

They also observed an unusually fast elimination in the case of cyclopentyl phenyl selenoxide **64** and an unusually slow elimination in the case of cyclohexyl phenyl selenoxide **63**. The authors attributed this result to the favourable and unfavourable dihedral angle between carbon-selenium and carbon hydrogens bond for the selenoxide elimination.

2.3.2. Influence of the substituent on the aryl group

In 1975, Sharpless and Young reported that an *ortho* or *para* electron-withdrawing substituent on the benzene ring not only accelerated the selenoxide *syn*-elimination of alkyl aryl selenoxides but also gave better yields (Scheme 2.4).^[7] The results obtained are summarized in Scheme 2.4.

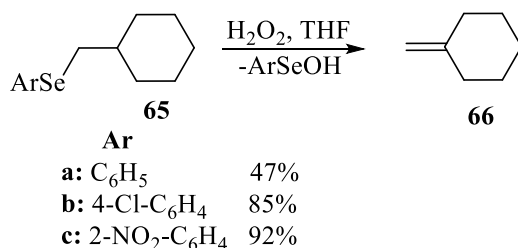

Scheme 2.4. Elimination of alkyl aryl selenoxide with electron withdrawing substituents

The same year, Grieco *et al.* used this effect in the formation of a double bond in the total synthesis of natural products such as vernolepin^[20] and moenocinol^[21] (Scheme 2.5).

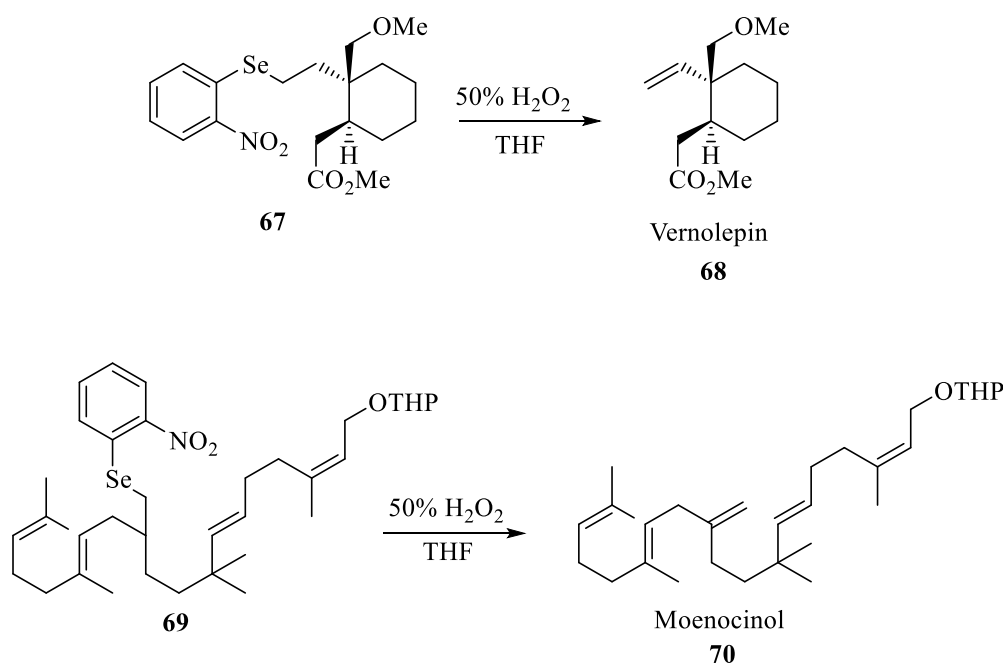

Scheme 2.5. Synthesis of natural products

In 2000, Sayama and Onami compared the selenoxide elimination of *n*-alkyl *ortho*-substituted phenyl selenides with the corresponding *para*-substituted isomers using hydrogen peroxide (Scheme 2.6).^[22] Alkyl aryl selenides with an electron-withdrawing *ortho* substituent on the benzene ring were more suitable starting materials than the corresponding isomers for the preparation of terminal olefins. Indeed, the reaction with selenoxides of the *para*-substituted isomers afforded unwanted primary alcohols as by-products.

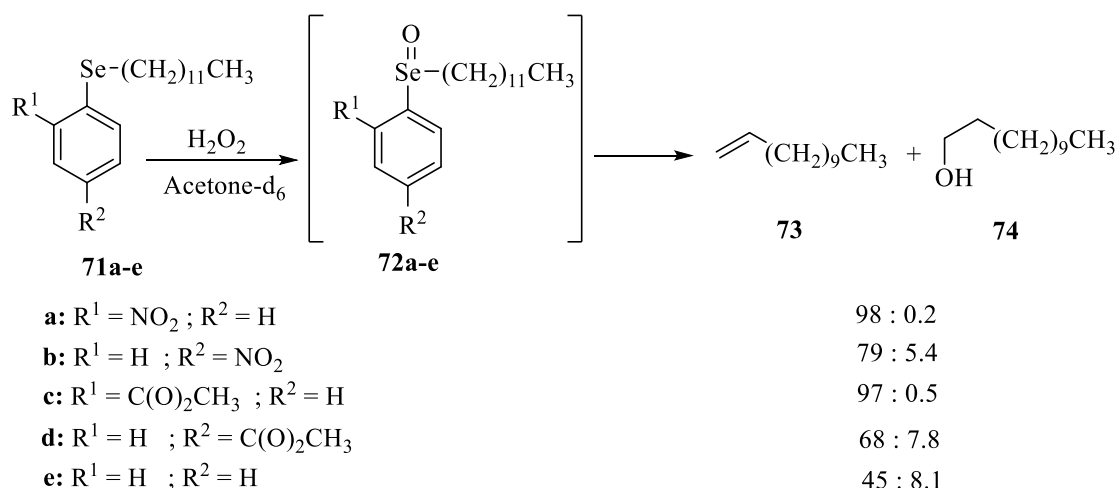

Scheme 2.6. Selenoxide elimination of *n*-alkyl *ortho* and *para*-substituted phenyl selenides

The rate of elimination of *ortho*-substituted selenoxides was shown to be faster than the corresponding *para*-substituted isomers. A plausible explanation was that the selenium atom in the *ortho*-substituted selenoxides could adopt a trigonal bipyramidal geometry rather than pyramidal due to coordination of the substituents with the selenium atom in the *ortho* position. Consequently, the selenoxide oxygen atom is closer to the leaving hydrogen atom which leads to a faster decomposition of the selenoxide.^[23]

2.4. Side reactions in selenoxide *syn*-eliminations

Although selenoxides *syn*-eliminations commonly afford olefins in good yields, some side reactions have been reported. The selenenic acid by-product has been described to be involved in undesirable side reactions, such as electrophilic addition to the product. It is well established that selenenic acids disproportionate into the corresponding selenenic acid and diselenide (Equation 2.1). The opposite reaction is called comproportionation.



Equation 2.1 Disproportionation of selenenic acid

Reich *et al.* reported the formation of β -hydroxyethyl phenyl selenide during the decomposition of ethyl phenyl selenoxide **75** (Scheme 2.7).^[19] The olefin formed by the *syn* elimination reacts with selenenic acid to give the β -hydroxy selenide **77**. Nevertheless, the formation of the β -hydroxy selenide **77** was completely suppressed by the addition of dimethylamine. The secondary amine reacted with the selenenic acid preventing its addition to the olefinic product.

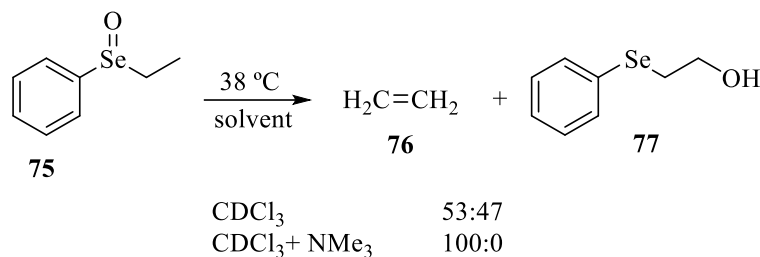

Scheme 2.7. *Syn* elimination of ethyl phenyl selenoxide

The authors showed that the selenenic acid added to the olefin is mostly produced by the comproportionation reaction, rather than the acid initially formed adding directly to the olefin as it is formed.^[19] In fact, Sharpless and Tori reported a procedure for the conversion of an olefin to a rearranged allylic alcohol via electrophilic addition of phenyl selenenic acid to olefins followed by subsequent oxidation.^[24] In this procedure, the phenyl selenenic acid was generated *in situ* by comproportionation of phenyl seleninic acid and diphenyldiselenide followed by the addition of an olefin to give a β -hydroxyphenyl selenide adduct.

Reich et *al.* suggested the use of an excess of hydrogen peroxide, when performing selenoxide *syn* eliminations, to convert the initially formed selenenic acid into its selenenic counterpart, and therefore avoid the addition of selenenic acid to olefins (Scheme 2.8). However, hydrogen peroxide is catalytically decomposed by selenoxides, and so large excess may be required to fully oxidize the starting material. In certain cases, such conditions can lead to other side reactions, such epoxidation of the olefinic product or Baeyer-Villiger oxidation of existing ketone functions.

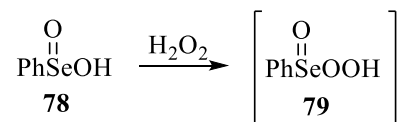

Scheme 2.8 Oxidation of the selenenic acid to its selenenic counterpart

Indeed, Grieco et *al.* reported the formation of epoxides during the oxidation and subsequent elimination of phenylseleno groups adjacent to carbonyls.^[25] In the presence of an excess of hydrogen peroxide, benzeneseleninic acid, the product of disproportionation selenenic acid, was converted in benzeneperoxyseleonic acid, which reacted further with the substituted olefin (Scheme 2.9).

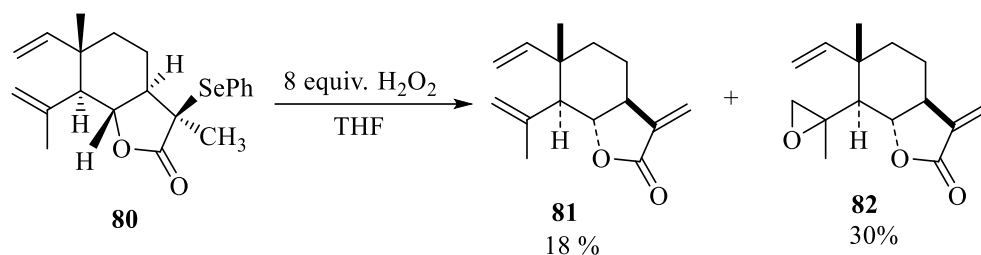

Scheme 2.9. Epoxidation of olefins with benzeneseleninic acid and hydrogen peroxide

However, Sharpless and Hori demonstrated that epoxidation of tri- or tetrasubstituted olefins either present initially in the molecule or being formed as a result of the selenoxide elimination can be avoided by using *tert*-butyl hydroperoxide instead of hydrogen peroxide.^[24]

Performing the oxidation of the selenide with a strong oxidant (e.g. *m*-CPBA or Ozone) at low temperatures, followed by heating it under reflux in non-polar solvent such as benzene, hexane, or carbon tetrachloride has also been reported as preventing side reactions. Moreover, the use of *o*-nitrophenyl alkyl selenoxides has also been used as strategy because of faster elimination rates.

2.5. Conclusion

Selenoxide elimination is a mild synthetic method in double bond forming reactions and it has been used in the preparation of natural products. Although side reactions have been reported to accompany selenoxide eliminations, there are several improved procedures that can be employed to avoid such reactions.

2.6. References

- [1] D. N. Jones, D. Mundy, R. D. Whitehouse, *J. Chem. Soc. D* **1970**, 86–87.
- [2] C. D. Hurd, F. H. Blunck, *J. Am. Chem. Soc.* **1938**, *60*, 2419–2425.
- [3] H. R. Nace, in *Org. React.*, John Wiley And Sons, Inc, **2011**.
- [4] C. H. DePuy, R. W. King, *Chem. Rev.* **1960**, *60*, 431–457.
- [5] B. M. Trost, T. N. Salzmann, K. Hiroi, *J. Am. Chem. Soc.* **1976**, *98*, 4887–4902.
- [6] K. B. Sharpless, M. W. Young, R. F. Lauer, *Tetrahedron Lett.* **1973**, *14*, 1979–1982.
- [7] K. B. Sharpless, M. W. Young, *J. Org. Chem.* **1975**, *40*, 947–949.
- [8] K. Haraguchi, Y. Itoh, *J. Org. Chem.* **1991**, *56*, 5401–5408.
- [9] G. Ayrey, D. Barnard, D. T. Woodbridge, *J. Chem. Soc.* **1962**, 2089–2099.
- [10] V. A. Potapov, M. V Musalov, E. O. Kurkutov, M. V Musalova, A. I. Albanov, S. V Amosova, *Russ. J. Org. Chem.* **2016**, *52*, 339–342.
- [11] D. Labar, L. Hevesi, W. Dumont, A. Kriefe, *Tetrahedron Lett.* **1978**, *13*, 1141–1144.
- [12] M. R. Detty, *J. Org. Chem.* **1980**, *45*, 274–279.
- [13] A. Krief, F. Lonez, *Tetrahedron Lett.* **2002**, *43*, 6255–6257.
- [14] M. Sevrin, A. Krief, *Tetrahedron Lett.* **1978**, *19*, 187–190.
- [15] G. W. Kabalka, N. K. Reddy, C. Narayana, *Synth. Commun.* **1993**, *23*, 543–548.
- [16] F. A. Davis, O. D. Stringer, J. M. Billmers, *Tetrahedron Lett.* **1983**, *24*, 1213–1216.
- [17] M. Tiecco, L. Testaferri, A. Temperini, R. Terlizzi, L. Bagnoli, F. Marini, C. Santi, *Tetrahedron Lett.* **2005**, *46*, 5165–5168.
- [18] P. E. Macdougall, N. A. Smith, C. H. Schiesser, *Tetrahedron* **2008**, *64*, 2824–2831.
- [19] H. J. Reich, S. Wollowitz, J. E. Trend, F. Chow, D. F. Wendelborn, *J. Org. Chem.* **1978**, *43*, 1697–1705.
- [20] P. A. Grieco, K. Hiroi, J. J. Reap, J. A. Noguez, *J. Org. Chem.* **1975**, *40*, 1450–1453.
- [21] P. A. Grieco, Y. Masaki, D. Boxler, *J. Am. Chem. Soc.* **1975**, *97*, 1597–1599.
- [22] S. Sayama, T. Onami, *Tetrahedron Lett.* **2000**, *41*, 5557–5560.
- [23] B. Hargittai, I.;Rozsondai, *The Chemistry of Organic Selenium and Tellurium*

Compounds, JohnWiley & Sons, New York, **1986**.

[24] T. Hori, K. B. Sharpless, *J. Org. Chem.* **1978**, *43*, 1689–1697.

[25] P. A. Grieco, Y. Yokoyama, S. Gilman, M. Nishizawa, *J. Org. Chem.* **1977**, *42*, 2034–2036.

CHAPTER 3: Short (total) synthesis of ajoene

3. Introduction

3.1. Ajoene

Ajoene (Figure 3.1) has been found as a major sulfur-containing compound in an oil-macerated garlic extract. It was first characterized by Block and Apitz-Castro in 1980, as a stable product of allicin self-condensation.^[1]

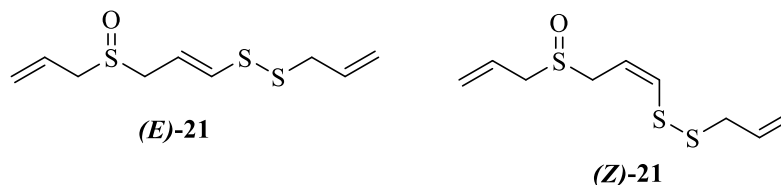

Figure 3.1 Natural occurring ajoene isomers in oil-macerated garlic extracts

Its remarkable structure contains several features of interest. First, an unusual vinyl disulfane functionality, rarely seen in the structures of natural compounds, which is likely to account for its range of biological activities via acting as a sulfenylating agent towards protein sulfhydryl groups.^[2] The *E* and *Z* diastereomers are formed from allicin and have slightly different types of biological activity, the *Z*-isomer being slightly more potent.^[3] Second, a sulfoxide functional group which can exist in two stereoisomeric forms (*R* and *S*). Davidson *et. al.* isolated the enantiomers of ajoene and demonstrated that *Z*-(-)-ajoene is at least four times more active than its *Z*-(+) counterpart, racemic *E*-ajoene, or the 3:1 mixture of racemic *Z*- and *E*-ajoene.^[4]

Although, the original focus of ajoene biological activity centred around its anti-thrombotic activity,^[5,6] in subsequent years it has been demonstrated it possesses a range of other biological activities such as anti-obesity,^[7,8] antifungal,^[9] antimicrobial,^[10–12] and anti-cancer^[13–15] activities.

3.2. Methods for the synthesis of Ajoene and analogues

3.2.1. Block's biomimetic synthesis

In 1986, Block reported a synthetic protocol for ajoene by mimicking how it is formed in nature. Readily available diallyl disulfide was converted via mono-oxidation by peracetic acid into alliin 5, which was refluxed in 40% aqueous acetone to form ajoene 21 (17% yield, after chromatography) (Scheme 3.1).

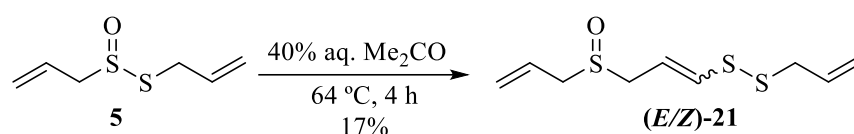

Scheme 3.1 Rearrangement of alliin to (*E/Z*)-ajoene

The mechanism of ajoene 21 formation was described by Block as a self-condensation of alliin 5 (Scheme 3.2), involving *S*-thioallylation of alliin to form a sulfonium ion 15, which upon Cope-type elimination of 2-propenesulfenic acid 9 leads to vinylthionium ion (*E/Z*)-20. Subsequent, Michael addition of 2-propenesulfenic acid 9 to the vinylthionium (*E/Z*)-20 affords ajoene as a mixture of *E/Z* stereoisomers (Scheme 3.2).

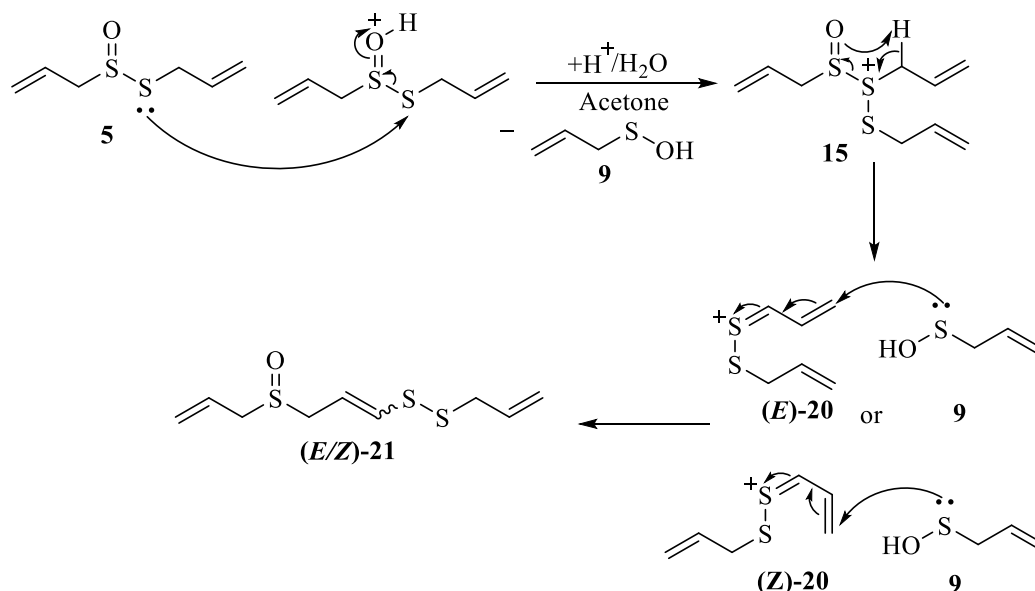

Scheme 3.2. Mechanism proposed by Block for ajoene formation

Although the synthesis is a one-pot conversion, it suffers from being low-yielding due to the formation of side products. Since the side products formed are organosulfur compounds with similar physical properties, ajoene purification is quite challenging. Another issue with this procedure is the fact it demands the presence of an *S*-allyl group (or substituted allyl) in the substituted thiosulfinate starting material, which results in an obligatory allyl group at the disulfide end of the molecule. Therefore, chemical modifications to the structure of the ajoene molecule are limited, being the only possible way the introduction of different substituents in the double bond of the corresponding allicin precursor.

Indeed, Block *et al.* reported the synthesis of a fluorinated analogue of ajoene (*E/Z*)-**84** *via* acid-catalyzed rearrangement of difluoroallicin **83** in 1,1,1,3,3,3-hexafluoro-2-propanol at room temperature for 16 hours (Scheme 3.3). Although the reaction afforded trifluoroajoene (*E/Z*)-**84** in 59% yield (based on converted difluoroallicin), its isolation was not possible with the chromatographic methods employed.^[16]

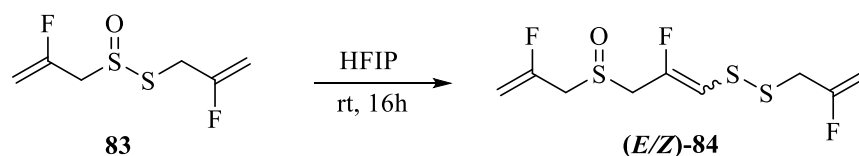

Scheme 3.3 Rearrangement of difluoroallicin **83** to form trifluoroajoene **84**

As mentioned before, the method developed by Block is the only synthetic procedure reported to access ajoene. Over the years, several patents based on this procedure have been published. For example, one of them (U.S. Patent (No. 5,612,077) utilizes edible oil to produce a macerate containing mainly *Z*-ajoene. Another example, (U.S. Patent (No. 5,741,932) describes the use of cyclodextrins in a complicated multi-step method. The disadvantage of both methods is the production of small volumes at a low concentration of ajoene.

3.2.2. University of Cape Town (UCT) synthesis

In 2008, Hunter *et al.* reported a four-step synthetic protocol to access a range of ajoene analogues containing the central vinyl disulfide/sulfoxide core while varying the end groups (Scheme 3.4). The key step in the synthesis utilizes a regioselective radical addition of thioacetic acid to a terminal alkyne to produce a vinylthio functionality. The steps of the synthesis are discussed within the next section.

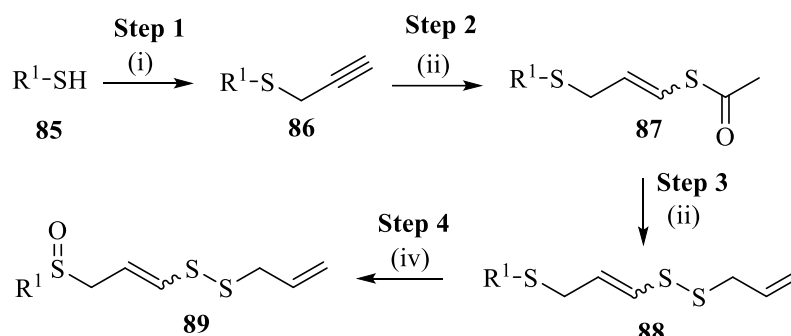

Reagents and conditions: (i) KOH, MeOH, propargyl bromide; (ii) CH₃COSH (1.1 equiv), AIBN (2 mol%), Toluene, 85 °C; (iii) (a) KOH (1.05 equiv), MeOH, -78 °C; (b) *p*-TolSO₂Sallyl (1.1 equiv); *m*-CPBA (1.1 equiv), CH₂Cl₂, -78 °C to rt.

Scheme 3.4 Synthesis of terminally-substituted ajoene analogues

3.2.2.1. Step 1: Propargylation

A propargylic thioether **86** is prepared by propargylation of a thiol **85** (Scheme 3.5). The latter can be obtained commercially or via S_N2 reaction of a halide or tosylate **90** with thiourea **91** to form an isothiuronium salt **92**. Given the pungent nature of thiols, the hydrolysis of the salt with potassium hydroxide is performed *in situ* followed by direct addition of propargyl bromide to produce the desired thioether **86**.

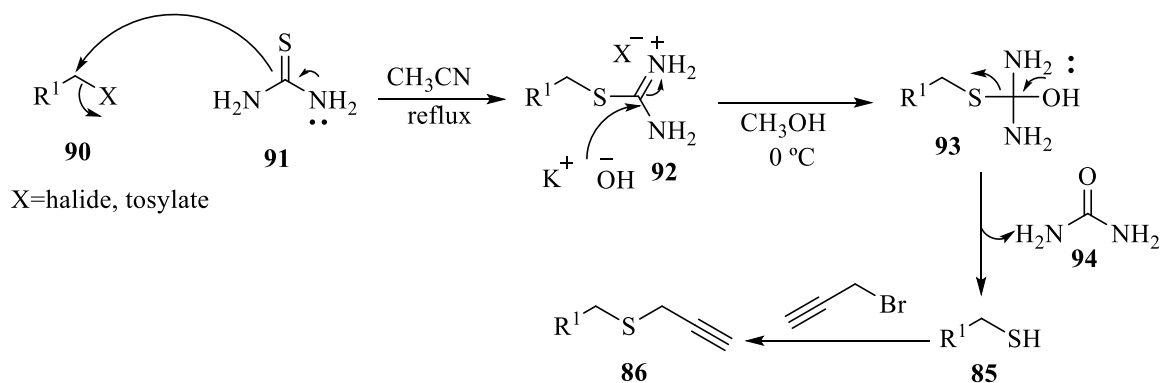

Scheme 3.5 Preparation, hydrolysis and propargylation of a thiol

3.2.2.2. Step 2: Radical addition reaction

This step involves the regioselective radical addition of thioacetic acid **95** to the terminal alkyne to form a vinyl thioacetate (*E/Z*)-**86** using AIBN **97** as radical initiator (Scheme 3.6). This step was inspired by the known addition of thioacetic acid to the terminal position of 1-hexyne reported by Kampmeier *et al.*^[17] This transformation is considered the key step in the synthesis, as it was at this point that the *E/Z* stereoselectivity was established, based on a kinetic preference for the *Z*-isomer. The reaction proceeds by classical initiation, propagation and termination sequence.

i) Initiation

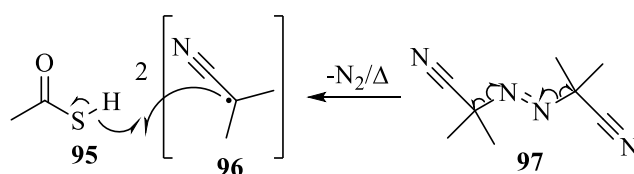

ii) Propagation

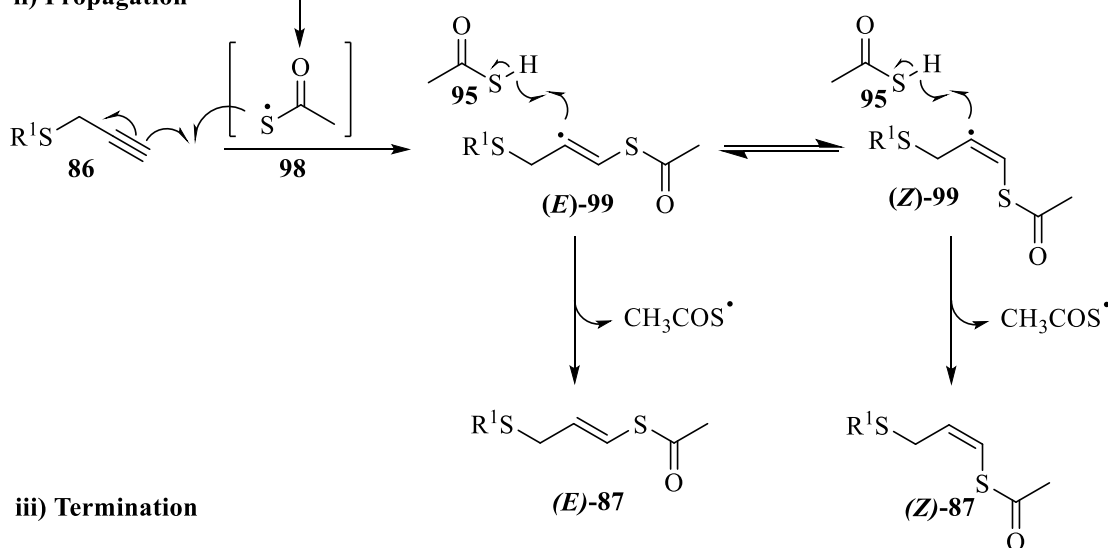

iii) Termination

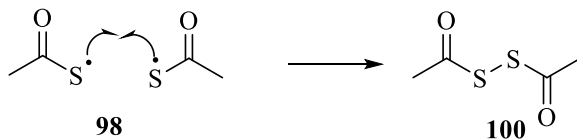

Scheme 3.6 Radical addition reaction mechanism

Thermal cleavage of the radical initiator **97** yields an active α -cyano radical **96**, which then abstracts a hydrogen from the thioacetic acid **95** generating a thiyl radical **98**. The latter adds regioselectively to the less hindered position of the propargylic thioether **86** and gives a vinyl radical intermediate **99** as an *E/Z*-mixture of isomers in equilibrium.

Hydrogen abstraction from the thioacetic acid **95** by the resulting vinyl radical **99** leads to the *E*- and *Z*- vinyl sulfides **87**. The reversible addition of a thiyl radical to the propargyl sulfide promotes the isomerization of the kinetically favoured *Z*-isomer into the thermodynamically more stable *E*-vinyl sulfide. The reaction terminates with the dimerization of two thiyl radicals **98** to form a disulfide diacetate **100**.

3.2.2.3. Step 3: *S*-Sulfenylation

The vinyl thioacetate **87** is subsequently hydrolysed *in situ* to the thioenolate **101**, which in the presence of a sulfenylating agent **102** rapidly displaces the tosyl leaving group to form the disulfide **88** via a soft-soft interaction between the two divalent sulfurs (Scheme 3.7). The hydrolysis was carried out at -40 °C to minimize isomerization from the *Z*-isomer to the more stable *E*-isomer via a protonation, tautomerism (to the thioaldehyde), conformational switch, and re-deprotonation sequence.

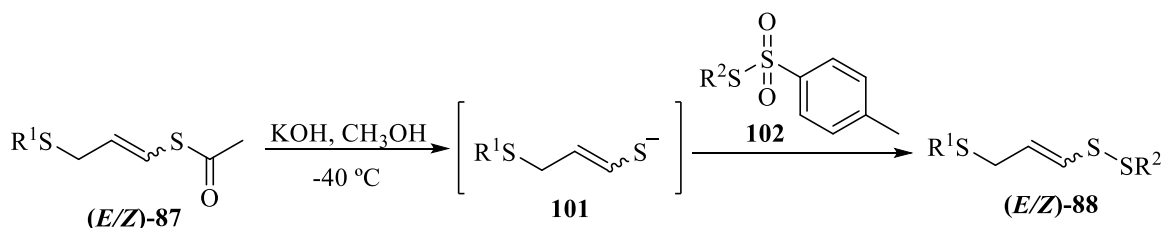

Scheme 3.7 Hydrolysis and sulfenylation reaction of the (*E/Z*)-vinylthioacetate **87**

3.2.2.4. Step 4: Oxidation

In the last step of the synthesis, the more nucleophilic sulfide of the vinyl disulfide/sulfide **88** is chemoselectively mono-oxidized with *m*-CPBA at very low temperatures.

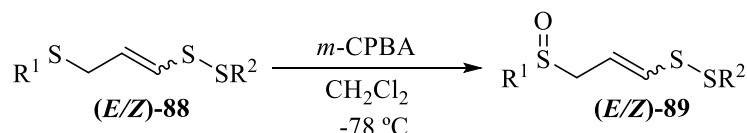

Scheme 3.8 Oxidation reaction of the sulfide

3.2.3. Limitation of the synthesis

The procedure developed by Hunter *et al.* allowed the synthesis of a range of terminally-substituted ajoene analogues in very good yields. However, the method could not be used to prepare ajoene itself. According with the UCT protocol, allyl propargylic sulfide **103** would be required as a starting material to obtain the allyl sulfoxide moiety of ajoene. However, it was anticipated that the vinyl radical **104**, formed after the addition of the thiyl radical **98** to terminal alkyne of sulfide **103**, would cyclise onto the allyl group via a 5-*exo*-trig or 6-*endo*-trig process to give products **105** and **106** (Scheme 3.9). This reaction was not further investigated though.^[18]

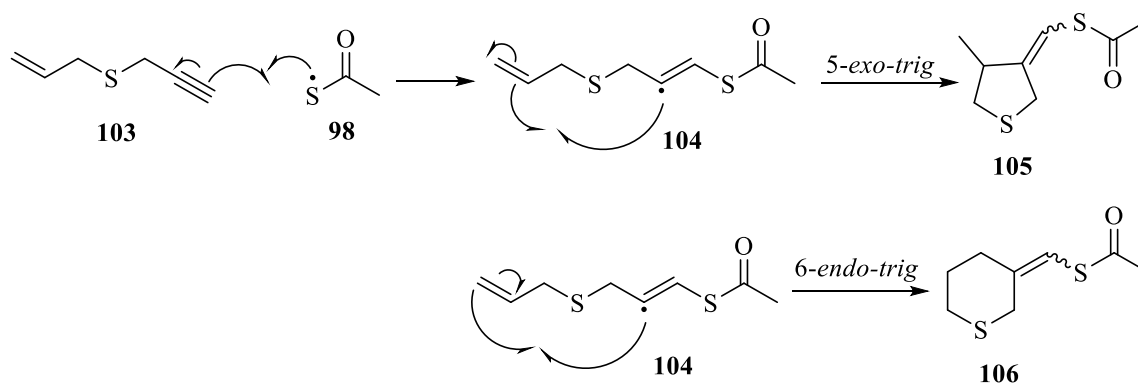

Scheme 3.9 Postulated mechanism for the addition of a thiyl radical to an alkyne containing an allyl group

3.3. Objectives

The demand for ajoene is growing and the low yield and purity is a limiting factor of Block's biomimetic synthesis. Although, the UCT protocol allows the synthesis of a range of terminally-substituted ajoene analogues, it cannot be used to prepare ajoene itself due to postulated side reactions. The aim of this project was to develop a protocol for the synthesis of ajoene based on the UCT synthesis. Selenoxide elimination was employed to overcome the limitation of the synthesis and to produce the allyl sulfoxide moiety of ajoene.

3.4. Short (total) synthesis of ajoene

An approach to the synthesis of ajoene via selenoxide elimination was developed. The retrosynthetic strategy is described in Scheme 3.10. Aryl selenide **110** was envisioned as precursor of ajoene. It was anticipated that compound **110** would afford ajoene (*E/Z*)-**21** in one-pot reaction, *via* selective oxidation of the sulfide and selenide to the corresponding sulfoxide and selenoxide, followed by selenoxide elimination. Vinyl disulfide **110** could be prepared according with UCT protocol from the corresponding halide **107**.

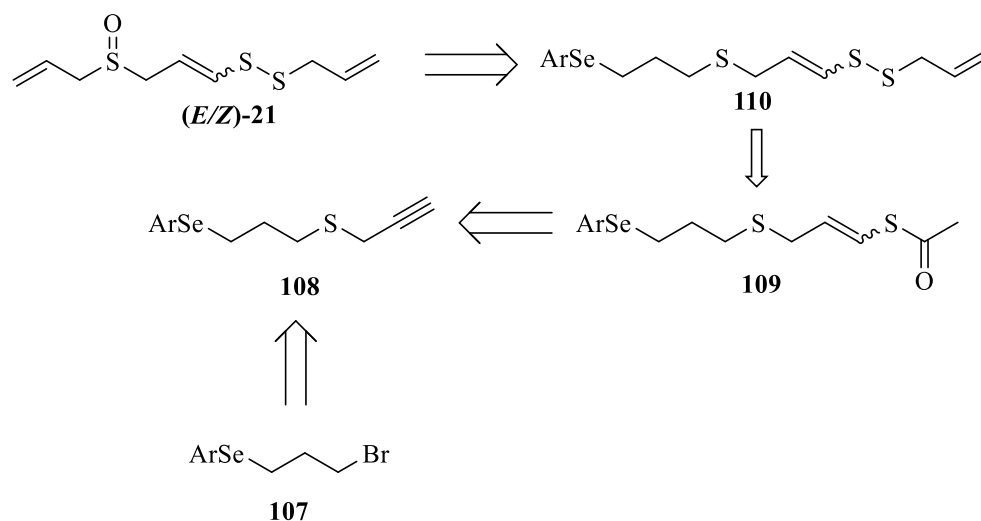

Scheme 3.10 Proposed precursor for the synthesis of ajoene

This chapter describes the short (total) synthesis of ajoene and is divided into three segments. In the first one, the preparation of aryl selenide precursors is described (Section 3.5). After that, the optimization of oxidation/selenoxide elimination is presented (Section 3.5.4). In the final segment, the synthesis of ajoene derivatives is described (Section 3.5.5).

3.5. Synthesis of aryl selenide precursors

The key step of the synthesis is the one-pot oxidation of sulfur and selenium and subsequent selenoxide elimination to form the allyl sulfoxide moiety of ajoene. It has been reported that the use of aryl groups with electron-withdrawing substituents give better yields in selenoxide eliminations.^[19] In order to understand if that would be the case, two aryl selenide precursors containing a phenyl group and a 2-nitrophenyl group, were prepared. The pathway towards the synthesis of the aryl selenide precursors was divided in three main steps: i) synthesis of a propargylic thioether containing the aryl selenide moiety; ii) radical addition of thioacetic acid to the alkyne; iii) *S*-sulfenylation.

3.5.1. Synthesis of propargylic thioether containing the aryl selenide moiety

The synthesis of the phenyl selenide precursor started with the treatment of 1,3-dibromide **111** with phenylselenide anion, generated *in situ* by reduction of diphenyl diselenide with sodium borohydride at 0 °C, to provide the selenide **107a** in good yield (Scheme 3.11). By using an excess of 1,3-dibromide, the formation of the disubstituted product was minimized. However, a small amount was always detected. Compound **107a** was subsequently reacted with thiourea in acetonitrile at reflux temperature to afford the isothiuronium salt **112** in 81% yield (Scheme 3.11).

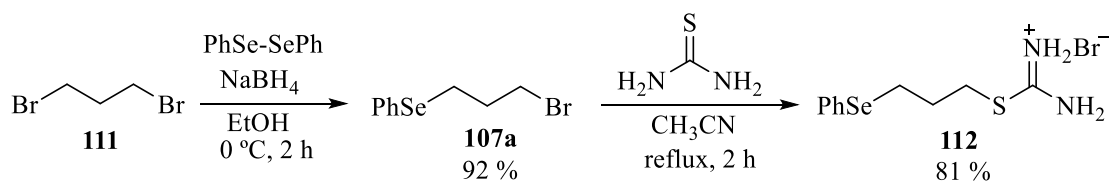

Scheme 3.11 Synthesis of the isothiuronium salt **112**

Next, the hydrolysis of compound **112** with potassium hydroxide provided the corresponding thiol, which was propargylated *in situ* with propargyl bromide to afford the propargylic thioether **108a** in good yield (89%) (Scheme 3.14). It was necessary to use 2.5 equivalents of potassium hydroxide to completely hydrolyse the isothiuronium salt to the corresponding thiol as well as to neutralise the hydrobromic acid generated from the propargylation step.

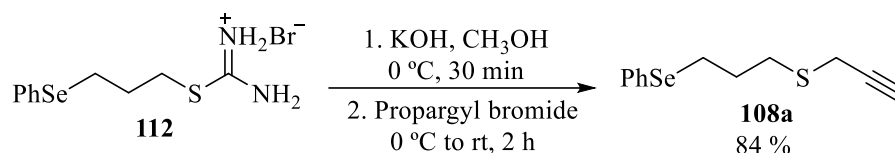

Scheme 3.12 Synthesis of the propargylic thioether 108a

The synthesis of 2-nitrophenyl selenide precursor started from commercially available 3-chloro-1-propanol **113** (Scheme 3.13). The reaction of the hydroxy group with 2-nitrophenyl selenocyanate and tributylphosphine produced the selenide **107b** in 52% yield *via* a nucleophilic substitution on the electron-deficient selenium. However, the reaction of selenide **107b** with thiourea failed to afford the desired salt **114**.

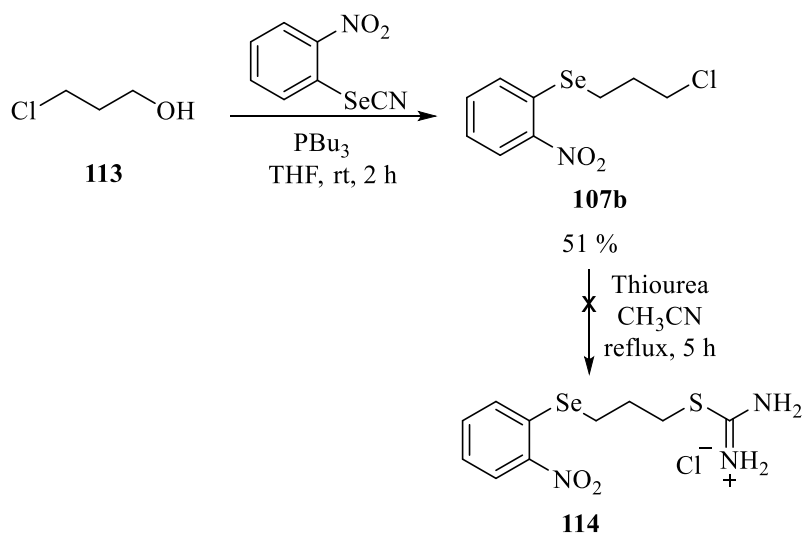

Scheme 3.13. Attempt to synthesize the isothiuronium salt 114

Alternatively, 3-chloropropanol **113** was first reacted with thiourea to form the isothiuronium salt **115**, which was then hydrolysed with potassium hydroxide to the thiol, and subsequent propargylated *in situ* to afford the propargylic thioether **116** in 56% yield. Next, the reaction of the hydroxy group with 2-nitrophenyl selenocyanate and tributylphosphine gave selenide **108b** in 65% yield (Scheme 3.14).

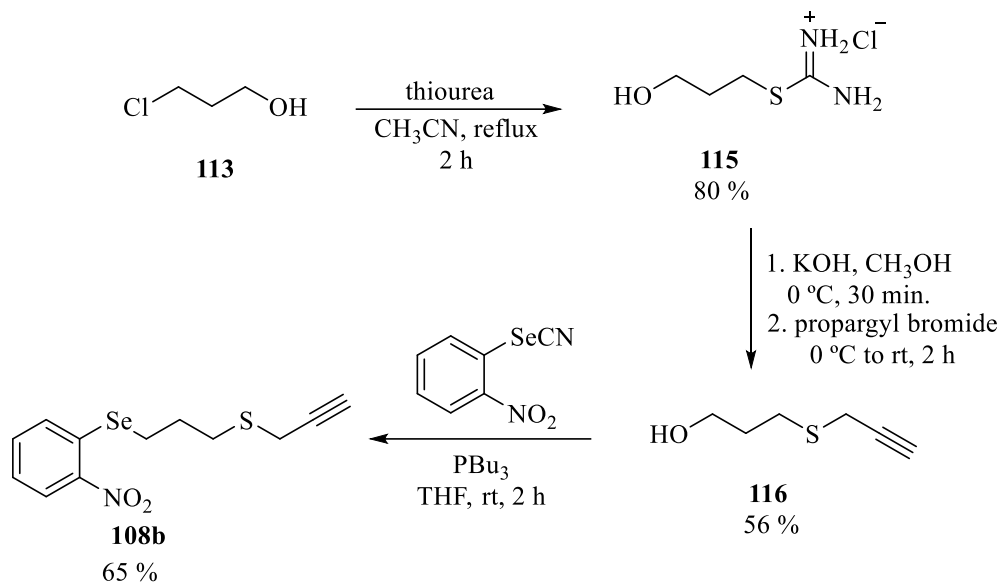
Scheme 3.14. Synthesis of compound **108b**

3.5.2. Radical addition of thioacetic acid to the alkyne

The next step involved the regioselective addition of thioacetic acid to the terminal alkyne **108a** and **108b** to form a vinyl thioacetate. The reaction was investigated in batch and in flow.

3.5.2.1. Batch

The use of different radical initiators was investigated in order to find the best reaction conditions. The reaction was carried out by dissolving alkyne **108a** or **108b** in degassed toluene and heating to 85 °C with the radical initiator added to the solution, followed by the dropwise addition of thioacetic acid over 40 minutes using a syringe pump (Scheme 3.15).

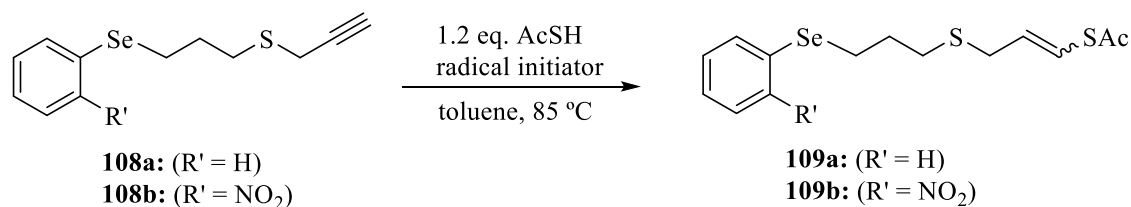
Scheme 3.15 Radical addition of thioacetic acid to alkynes **108a** and **108b**

The use of different radical initiators showed slight differences in yields. When ACCN [azobis(cyclohexanecarbonitrile)] was used as radical initiator, compound **109a** was obtained as 2:3 mixture of *E/Z* stereoisomers in 64% yield (**109b**: 2:3 *E/Z*, 50%). For **109a** the yield was slightly improved to 71% when AIBN [azobis(isobutyronitrile)] was used instead ACCN. Decreasing the amount of radical initiator to 5 mol% (Table 3.1, entry 3,4) led to lower yields of compound **109a**, while the yields of **109b** were only slightly affected.

Table 3.1 Optimization conditions for radical reaction with compounds 81a and 81b

Entry	Radical initiator	Yield (%)	
		109a	109b
1	ACCN (10 mol%)	64	50
2	AIBN (10 mol%)	71	30
3	AIBN (5 mol%)	43	28
4	ACCN (5 mol%)	26	45

In all cases, starting material was recovered at the end of the reaction. When an extra amount of thioacetic acid (1 equiv.) was added to the reaction of compound **108a** in the presence of AIBN and the reaction left for another hour, the starting material was still not fully consumed, and the formation of other impurities was observed. At this stage the separation of the *E* and *Z* stereoisomers was possible by chromatography. However, the mixture was used in the next reaction, as it is not stereospecific.

An alternative protocol was investigated to perform the same reaction. The thiyl radical is described to be easily formed by manganese(III) oxidation with ethanethiol or benzenethiol, which reacts with alkynes to give vinyl sulfides.^[20] A reaction of compound **108a** with thioacetic acid in the presence of manganese(III) acetate dihydrate in acetic acid was performed (Scheme 3.16). Compound **109a** was obtained as a 1:2 mixture of *E/Z* stereoisomers but in lower yields (35% yield).

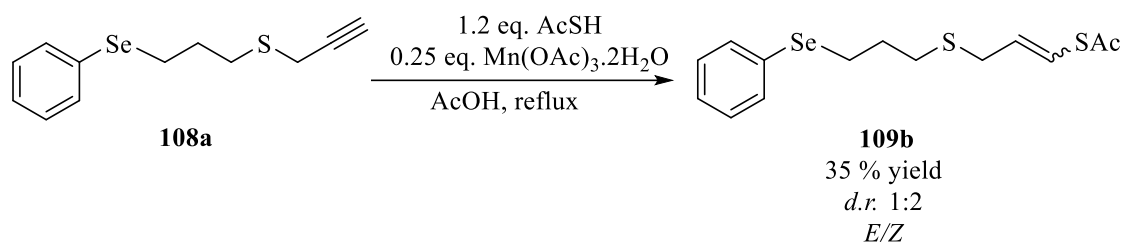

Scheme 3.16. Radical addition of thioacetic acid in the presence of manganese (III) acetate dihydrate

3.5.2.2. Flow chemistry

In recent years, the use of microreactors have made significant impact on chemical synthesis in terms of their advantageous characteristics, which include efficient mixing, efficient mass and heat transfer. It has been reported that thermally-induced radical reactions are facilitated by flow reaction technology.^[21–24]

The radical addition reaction of thioacetic acid to the terminal alkyne using flow chemistry was briefly investigated. An initial reaction was carried out by pumping a 1 M solution of alkyne **108a**, AIBN and thioacetic acid in toluene, through a PTFE reactor coil placed at 100 °C (Scheme 3.17).

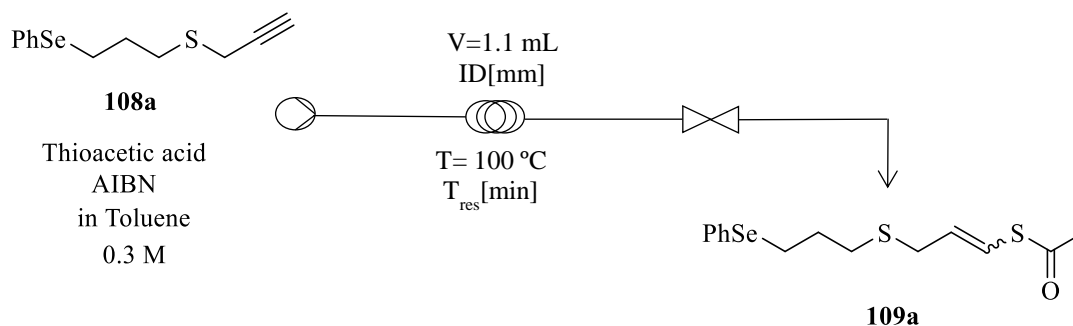

Scheme 3.17 Flow set-up for the radical addition reaction

Residence time and internal diameter of the reactor coil were the parameters investigated. The results obtained are shown in Table 3.2. Longer residence times lead to higher yields than short residence times (Table 3.2. Entry 1,3). On the other hand, the coil internal diameter did not affect the yields significantly (Table 3.2, Entry 1-4). All four experiments afforded compound **109a** as 1:2 mixture of *E/Z* stereoisomers, which was slightly different to the diastereomeric ratio obtained when the reaction was carried out in batch.

Table 3.2 Flow experiment of the radical addition of thioacetic acid to the alkyne 108a

Entry	t _{res} [min]	ID [mm]	Yield (%)*
1	20	0.5	28
2	20	0.175	32
3	40	0.5	46
4	40	0.175	52

* isolated yield

Although the reaction worked under flow chemistry conditions, the yields were lower than in batch. Further optimization studies needed to find the optimal conditions. However, these studies were not carried out further.

3.5.3. S-Sulfenylation

At this stage, the vinyl thioacetate was coupled with the thiosulfonic acid *S*-alkyl ester to afford the core vinyl disulfide of ajoene. This was achieved by hydrolysis of **109a-b** to the thioenolate with potassium hydroxide in methanol and subsequent sulfenylation with thiosulfonic acid *S*-alkyl ester **117** (Scheme 3.18). The reaction gave compounds **110a** and **110b** in good yields (73-87%).

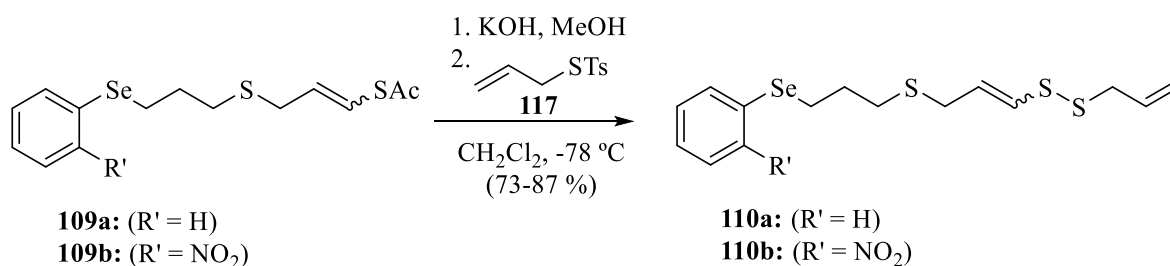
**Scheme 3.18 Synthesis of disulfide 110a and 110b**

The reaction was performed at $-40\text{ }^{\circ}\text{C}$ in order to avoid side reactions of the highly reactive thioenolate and also to reduce the possibility of tautomerism to the thermodynamically more stable *E*-isomer. The reaction with compound **109a** (1:1 mixture of *E/Z* stereoisomers) afforded **110a** in 87% yield and the ratio of *E/Z* stereoisomers changed to 2:3. When the reaction was performed with compound **109b** (2:3 mixture of *E/Z* stereoisomers), compound **110b** was obtained in 73% yield with the same *E/Z* ratio. Since the stereoisomers could be separated by chromatography, a reaction with **Z-109a** was performed to verify if isomerization to the *E*-isomer occurs even at very

low temperatures. Indeed, the reaction starting with **Z-109a** afforded **110a** as a 3:2 mixture of *E/Z* stereoisomers in 85% yield.

3.5.4. Oxidation of the sulfide and selenide / selenoxide elimination

The oxidation of the two ajoene precursors **110a-b** was first investigated using hydrogen peroxide and *m*CPBA, as oxidants (Scheme 3.19). When compounds **110a-b** were treated with two equivalents of 30% w/w hydrogen peroxide solution, ajoene **21** was produced as a 2:3 mixture of *E/Z* stereoisomers in 23% (**110a**) and 27% (**110b**) yield. Changing the oxidant to *m*CPBA did not improved the yields as well as did not altered the ratio of *E/Z* stereoisomers.

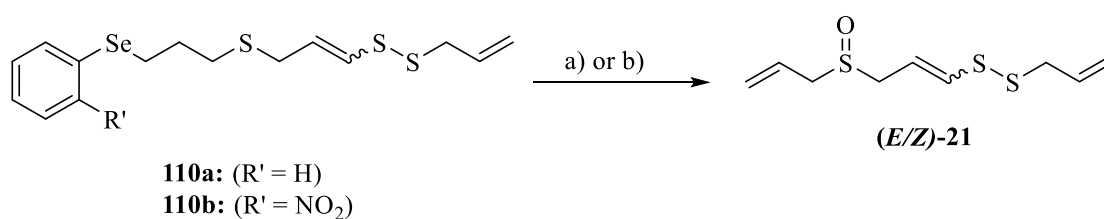

Reaction conditions:

- a)** 2 eq. H₂O₂ (30% w/w), THF, 0 °C - rt (3 h). Yields: **110a** (23%), **110b** (27%)
b) 2 eq. *m*CPBA, CHCl₃, 0 °C - rt (3 h). Yields: **110a** (21%), **110b** (23%)

Scheme 3.19 Synthesis of ajoene **21**

It is known that electron-withdrawing substituents on the aromatic ring increase both the rate of elimination and the yield of the alkene. However, the use of the selenium derivative with an electron withdrawing substituent **110b** did not show any advantage when compared with compound **110a** as the yields were almost identical. Despite the full consumption of the starting material, the reaction provided product **21** in low yields. This could be due to side reactions, since formation of smaller amounts of other products was observed. However, due to the complexity of the TLC of the crude mixture, characterization of those products was not possible. Side reactions in selenoxide elimination have been reported and are discussed in Chapter 2.

3.5.4.1. Optimization Studies

Further optimization studies were performed in order to improve the yields of the target molecule. For this study, selenide **109a** was used instead of selenide **110a**, as product **118** could also be used as ajoene precursor. Different oxidation conditions were investigated, and the results are shown in Table 3.3.

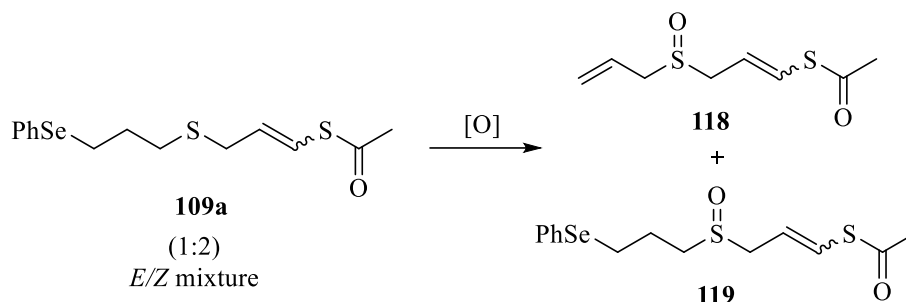

Table 3.3 Optimization studies

Entry	Oxidation conditions	Yield (%)		
		109a	118	119
1	2 equiv. H ₂ O ₂ (50% w/w), THF 0 °C (1 h) – rt (2 h)	20	23	19
2	3 equiv. H ₂ O ₂ (50% w/w), THF 0 °C (1 h) – rt (2 h)	21	20	25
3	4 equiv. H ₂ O ₂ (50% w/w), THF 0 °C (1 h) – rt (2 h)	-	12	9
4	2 equiv. UHP, CH ₂ Cl ₂ 0 °C (1 h) – rt (2 h)	8	33	17
5	4 equiv. UHP, CH ₂ Cl ₂ 0 °C (1 h) – rt (2 h)	-	32	18
6	2 equiv. NaIO ₄ , CH ₃ OH/H ₂ O 0 °C (1 h) – rt (6 h)	-	9	50
7	2 equiv. <i>m</i> -CPBA, CHCl ₃ 0 °C (1 h) – rt (2 h)	-	37	16
8	2 equiv. H ₂ O ₂ (50% w/w), CH ₂ Cl ₂ , 1.5 equiv. DIPA, 0 °C (1 h) – rt (2 h)	20	27	-
9	2 equiv. <i>m</i> -CPBA, CH ₂ Cl ₂ , 2 equiv. DIPA, 0 °C (1 h) – rt (2 h)	-	46	-
10	2 equiv. <i>m</i> -CPBA, CH ₂ Cl ₂ , 2 equiv. DIPA, 0 °C(1h) – rt (24h)	-	44	-

The reaction of compound **109a** with 2 equivalents of H₂O₂ (50% w/w) afforded the desired product **118** in 23% yield (Table 3.3, entry 1). The yield was comparable with the one obtained with compound **110a**. However, in this reaction, a second product was isolated in 19% yield, which was identified as being compound **119**. Although a similar side product was not isolated when the same reaction was carried out with compound **110a**, it was probably formed as well.

Increasing the amount of hydrogen peroxide to 3 or 4 equivalents did not avoid the formation of selenide **119** as well as did not improve the yields. In order to investigate the effect of water in the reaction, the complex urea-hydrogen peroxide was tested as an alternative to the use of aqueous hydrogen solutions. The presence of water in selenoxide elimination reactions is described to slow down the rate of elimination, therefore promoting side reactions.^[25] Although the yield was slightly higher, compound **119** was also formed (Table 3.3, entry 4). Increasing the amount of UHP did not affect the yields significantly (Table 3.3, entry 5). Interestingly, when the reaction of compound **109a** was carried out in the presence of NaIO₄, selenide **119** was isolated as a major compound in 50% yield (Table 3.3, entry 6). *meta*-Chloroperbenzoic acid was also investigated as a suitable oxidant and demonstrated to react giving comparable yields (Table 3.3, entry 7). Preventive measures to avoid side reactions in selenoxide elimination are discussed in Chapter 2. The addition of alkyl amines is one of those measures. When 1.5 equivalents of diisopropylamine (DIPA) was added to the reaction with H₂O₂, the formation of compound **119** was suppressed, but compound **118** was only isolated in 27% yield (Table 3.3, entry 8). Adding 2 equivalents of DIPA to the reaction with *m*CPBA not only stopped the formation of compound **119**, but also improved the yield of product **118** to 46% (Table 3.3, entry 9). The same reaction conditions with a longer reaction time did not affect the yield of compound **118** (Table 3.3, entry 9).

3.5.5. Synthesis of ajoene and derivatives

With compound **91** in hands, ajoene **23** was prepared in 92% yield via hydrolysis of compound **91** to the thioenolate with potassium hydroxide in methanol and subsequent sulfenylation with thiosulfonic acid S-alkyl ester **90**.

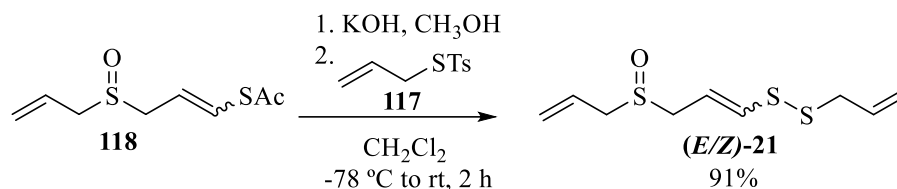

Scheme 3.20 Synthesis of ajoene

The same procedure was used to prepare several ajoene derivatives **121a-g** in good yields. Reagents **120a-g** employed in the synthesis of the derivatives were prepared *via* reaction of the corresponding halide with potassium *p*-toluenethiosulfonate in dimethylformamide. All the synthesized derivatives were investigated regarding their biological activities.

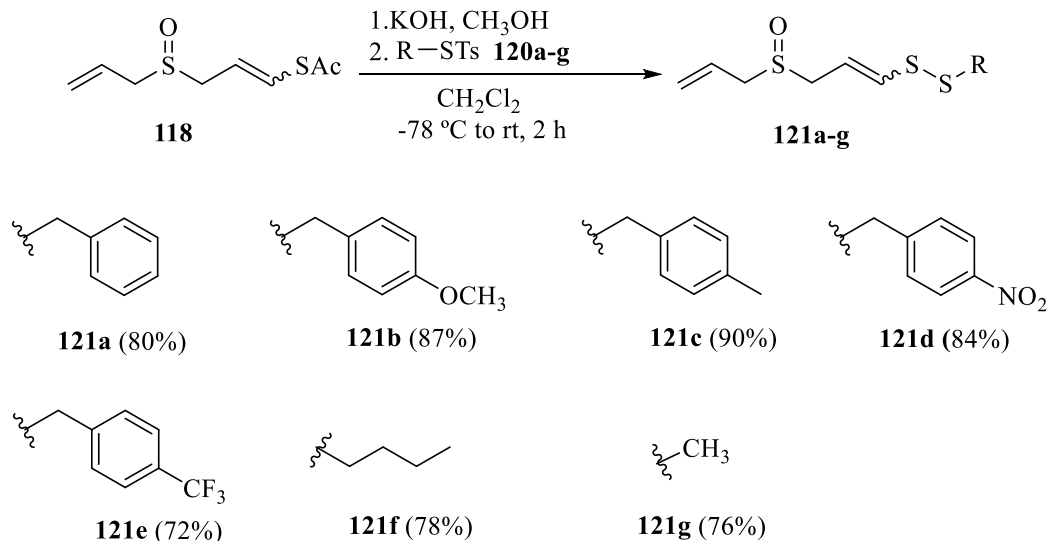

Scheme 3.21. Synthesized ajoene derivatives **121a-g**

3.6. Scale-up of the synthesis

The complete synthesis of ajoene was scaled up by Onyx Scientific Ltd., UK. As expected, slight modifications to the reaction conditions and work-up were introduced to allow an easier scale up of the synthesis. The main differences between the two processes are highlighted below.

The synthesis of **107a** proceeded with 58% yield on a 4 mol scale. The reaction was quenched with MeOH instead of water and the extraction solvent was changed from diethyl ether to heptane. Toluene azeotropes were used to remove the excess of 1,3-dibromopropane which avoided the need of purification *via* column chromatography to obtain the pure compound.

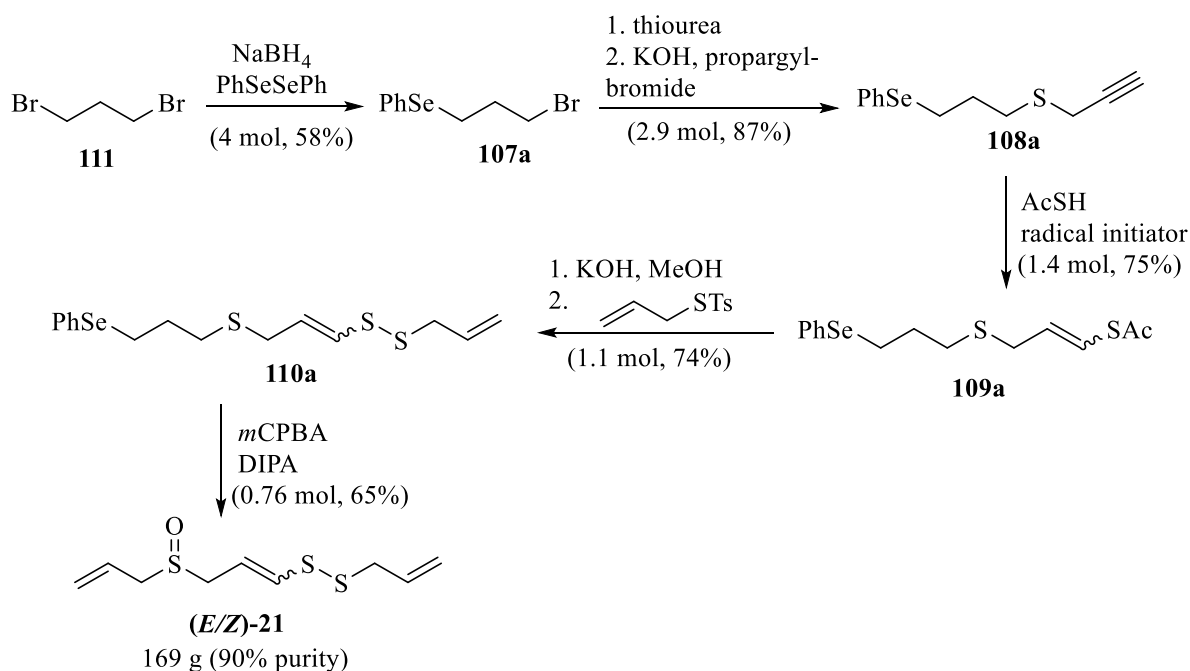

Scheme 3.22 Scale-up of the synthesis by Onyx Scientific Ltd., UK

The isothioronium salt (1.68 mmol) was prepared according with the initial protocol extending the reaction time to 10 h. The subsequent thiol formation and propargylation led to **108a** in 87% (2.9 mol) which was an improvement of the small-scale synthesis (56% yield). Longer reaction times were employed to drive the reaction further. The reaction work-up was also modified (refer to section 6.4.1, page 102). Firstly, the reaction was diluted with heptane and then quenched with the dropwise addition of water.

Extraction of the aqueous layer was performed with heptane instead of dichloromethane. The column chromatography used in the initial protocol was replaced by a silica plug. Radical addition of thioacetic acid to alkyne **108a** proceeded similarly well compared to the small-scale synthesis (**108a**: 75%, 1.4 mol). However, an additional amount of radical initiator had to be added to the reaction after 2 h to drive the reaction further. As at this stage, compound **109a** was an oil, an attempt to obtain a solid was performed using thiobenzoic acid. The aim was to explore crystallization as a way of purifying the product instead of a column chromatography. Similar yields were obtained comparatively to the reaction with thioacetic acid, however, despite all the efforts, it was not possible to solidify the product. The thioacetate cleavage and *S*-sulfenylation to **110a** (74%, 1.1 mol) also proceeded similarly to the small-scale synthesis with no relevant modifications needed. The final oxidation of **110a** to ajoene **21** had superior yields (65%) as compared to the small-scale synthesis. Optimized reaction conditions found to oxidize intermediate **109a** were utilized instead. 169 g (0.72 mol) of ajoene **21** were isolated in ~90% purity as determined by HPLC and NMR.

3.7. Conclusions

In conclusion, an efficient total synthesis of ajoene was accomplished in six steps from easily available starting materials. The key feature of the synthesis was the simultaneous introduction of the allyl moiety and the sulfoxide in the final step, which allowed a straightforward generation of the target molecule. The overall yield varied between 17 to 20% yield depending on the precursor utilized. This synthetic approach was utilized to prepare several ajoene analogues with different terminal groups on the disulfide side. The protocol developed proved to be amendable to scale-up and provided 169 g of ajoene in ~90% purity.

3.8. References

- [1] E. Block, S. Ahmad, M. K. Jain, R. W. Creceley, R. Apitz-Castro, M. R. Cruz, *J. Am. Chem. Soc.* **1984**, *106*, 8295–8296.
- [2] H. Gallwitz, S. Bonse, A. Martinez-Cruz, I. Schlichting, K. Schumacher, R. L. Krauth-Siegel, **1999**, *58*, 364–372.
- [3] H. Yoshida, H. Katsuzaki, R. Ohta, K. Ishikawa, H. Fukuda, T. Fujino, A. Suzuki, *Biosci. Biotechnol. Biochem.* **1999**, *63*, 588–590.
- [4] J. B. Davidson, A. V. Tatarintsev, A. S. Turgiev, J. E. K. Hildreth, *WO 0204413 A1*, **2001**.
- [5] F. Rendu, D. Daveloose, J. C. Debouzy, N. Bourdeau, S. Levy-Toledano, M. K. Jain, R. Apitz-Castro, *Biochem. Pharmacol.* **1989**, *38*, 1321–1328.
- [6] R. Apitz-Castro, J. J. Badimon, L. Badimon, *Thromb. Res.* **1994**, *75*, 243–249.
- [7] J. Yang, M. A. Della-Fera, C. Nelson-Dooley, C. A. Baile, *Obesity* **2006**, *14*, 388–397.
- [8] J. Y. Yang, M. A. Della-Fera, D. B. Hausman, C. A. Baile, *Apoptosis* **2007**, *12*, 1117–1128.
- [9] G. San-Blas, F. San-Blas, F. Gil, L. Marino, R. Apitz-Castro, *Antimicrob. Agents Chemother.* **1989**, *33*, 1641–1644.
- [10] R. Naganawa, N. Iwata, K. Ishikawa, H. Fukuda, T. Fujino, A. Suzuki, *Appl. Environ. Microbiol.* **1996**, *62*, 4238–4242.
- [11] J. A. Urbina, E. Marchan, K. Lazard, G. Visbal, R. Apitz-Castro, F. Gil, T. Aguirre, M. M. Piras, R. Piras, *Biochem. Pharmacol.* **1993**, *45*, 2381–2387.
- [12] S. Yoshida, S. Kasuga, N. Hayashi, T. Ushiroguchi, H. Matsuura, S. Nakagawa, *Appl. Environ. Microbiol.* **1987**, *53*, 615–617.
- [13] K. Scharfenberg, R. Wagner, K. G. Wagner, *Cancer Lett.* **1990**, *53*, 103–108.
- [14] H. T. Hassan, *Leuk. Res.* **2004**, *28*, 667–671.
- [15] J. Terrasson, B. Xu, M. Li, S. Allart, J. L. Davignon, L. H. Zhang, K. Wang, C. Davrinche, *Fundam. Clin. Pharmacol.* **2007**, *21*, 281–289.
- [16] E. Block, B. Bechand, S. Gundala, A. Vattekkatte, K. Wang, S. Mousa, K. Godugu, M. Yalcin, S. Mousa, *Molecules* **2017**, *22*, 2081.
- [17] J. A. Kampmeier, G. Chen, *J. Am. Chem. Soc.* **1965**, *87*, 2608–2613.

- [18] R. Hunter, C. H. Kaschula, I. M. Parker, M. R. Caira, P. Richards, S. Travis, F. Taute, T. Qwebani, *Bioorganic Med. Chem. Lett.* **2008**, *18*, 5277–5279.
- [19] M. W. Y. K. B. Sharpless, *J. Org. Chem.* **1975**, *40*, 947–949.
- [20] V.-H. Nguyen, H. Nishino, S. Kajikawa, K. Kurosawa, *Tetrahedron* **1998**, *54*, 11445–11460.
- [21] T. Fukuyama, M. T. Rahman, N. Kamata, I. Ryu, *Beilstein J. Org. Chem.* **2009**, *5*, 1–5.
- [22] I. C. Wienhöfer, A. Studer, T. Rahman, T. Fukuyama, I. Ryu, *Org. Lett.* **2009**, *11*, 2457–2460.
- [23] T. Fukuyama, T. Kawamoto, M. Kobayashi, I. Ryu, *Beilstein J. Org. Chem.* **2013**, *9*, 1791–1796.
- [24] T. Fukuyama, M. Kobayashi, M. T. Rahman, N. Kamata, L. Ryu, *Org. Lett.* **2008**, *10*, 533–536.
- [25] K. B. Sharpless, M. W. Young, R. F. Lauer, *Tetrahedron Lett.* **1973**, *14*, 1979–1982.

**CHAPTER 4: An alternative approach to the
synthesis of ajoene**

4. Introduction and objectives

Among the constituents of garlic, ajoene is considered one of the most important not only because it possess similar biological profile to its natural precursor allicin but is also more stable.^[1] Thus, due to proven biological activities and stability, many are beginning to acknowledge the potential of ajoene as active pharmaceutical ingredient, specially, in antibacterial drug candidates.^[2] However, the limitations of the only reported synthetic protocol as well as other methodologies to prepare ajoene, has hampered further advances in the area (Chapter 3:). In order to address the current limitations, an efficient six-step protocol to synthesise ajoene from easily available starting materials was developed (Chapter 3). The protocol proved to be amendable to scale-up and provide large amounts of ajoene in high level of purity. This could offer the possibility of producing necessary amounts of ajoene to be used for clinical studies.

Despite of the efficiency in producing ajoene, the protocol has some inherent drawbacks, such as: i) the use of toxic selenium compounds, ii) the selenoxide *syn* elimination as a key step, since the elimination of areneselenenic acid makes the synthesis less atomic-efficient and by-products are produced. Therefore, the aim of this project was to investigate an alternative approach for the synthesis of ajoene in order to avoid the use of selenium compounds and, at same time a synthesis that would allow an easy scale up.

4.1. An alternative approach to the synthesis of ajoene

An alternative approach towards the synthesis of ajoene was proposed (Scheme 4.1). Ajoene could be prepared from compound **127** via chemoselective oxidation of the monosulfide with an oxidizing agent. The synthesis would start with alkyne **123** which could be easily prepared via propargylation reaction of commercially available thioacetic acid **122**. Radical addition reaction of thioacetic acid to alkyne **123** would afford the bis-thioacetate **124**. Selective hydrolysis of the bis-thioacetate **124** and subsequent S_N2 reaction with allyl bromide and thiosulfonic acid *S*-alkyl ester would produce compound **127**. Compounds **125** and **126** were proposed as two possible precursors of compound **127** since it was difficult to predict at this point which thioacetate would react first.

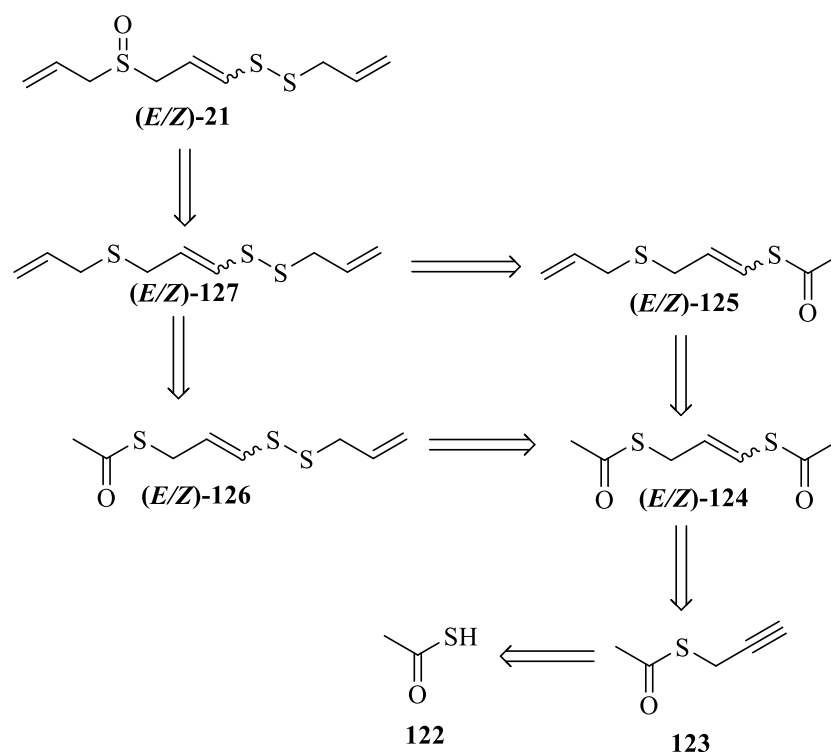

Scheme 4.1 Retrosynthetic strategy for ajoene

The synthetic sequence was developed in batch and transformed into a flow sequence with the aim of comparing the efficiency of both processes and also to investigate a continuous flow process for the synthesis of ajoene.

4.1.1. Propargylation of thioacetic acid

The first step towards the synthesis of ajoene involved the propargylation of thioacetic acid **122** with propargyl bromide. An initial attempt was performed using sodium hydride as base in THF (Table 4.1, entry 1).^[3] After 90 minutes reaction time, the reaction was complete, and the desired compound isolated in 50% yield. The yield was slightly improved using triethylamine as base in a mixture Et₂O/CH₂Cl₂, however the reaction time was longer (Table 4.1, entry 2).^[4] The reaction carried out with potassium carbonate as base in THF not only gave a cleaner reaction but also gave higher yield (Table 4.1, entry 3). In addition, no further purification of the product was necessary.

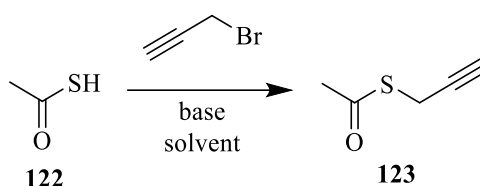

Table 4.1 Conditions of the reaction of thioacetic acid **122 with propargyl bromide**

Entry	Base	Solvent	Conditions	Yield [%]
1 ^[3]	NaH	THF	0 °C to RT, 1.5 h	50
2 ^[4]	NEt ₃	Et ₂ O/CH ₂ Cl ₂ ,	0 °C to RT, 24 h	63
3	K ₂ CO ₃	THF	RT, 3 h	75

4.1.2. Radical addition reaction of thioacetic acid

The next step comprises the radical addition reaction of thioacetic acid to the alkyne **123** to form vinylthioacetate **124**. This transformation was employed in section 3.5.2 for the same purpose. Thus, the reaction conditions in batch and flow were already established. In addition, the reaction was also performed using a flow electrochemical reactor developed in the group.

4.1.2.1. Batch reaction

The reaction was performed by dissolving alkyne **123** in degassed toluene and heating to 85 °C with the radical initiator (10 mol%) added to the solution, followed by the dropwise addition of thioacetic acid over 40 minutes using a syringe pump. The results in chapter 3 varied with the use of different radical initiators, AIBN being the one leading to higher

yields. To verify if similar results would be obtained in case of using alkyne **123**, the reaction was carried out with AIBN and ACCN. Both reactions afforded the product with similar yields, however, with a slightly different *E/Z* ratio (Scheme 4.2).

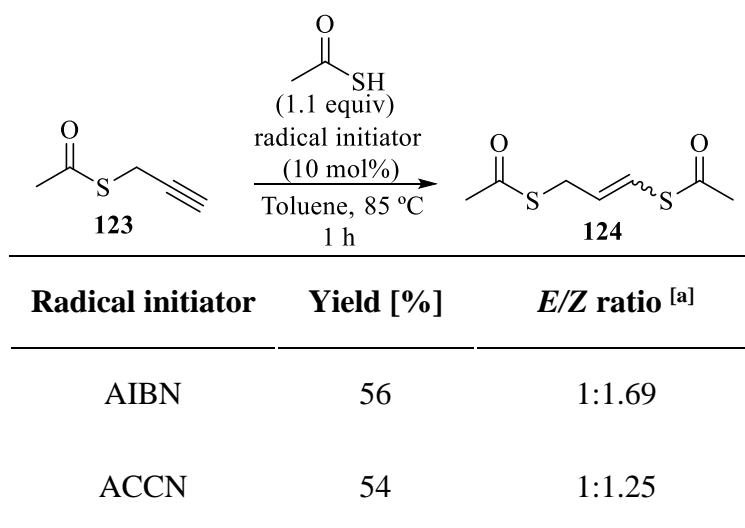

^[a] Determined by NMR.

Scheme 4.2 Radical addition of thioacetic acid to alkyne **123 using different radical initiators**

Further attempts to optimise this transformation were investigated by increasing the amount of radical initiator to 15 mol%, equivalents of thioacetic acid and reaction time, but unfortunately the yield could not be improved. Such conditions led mostly to the formation of side products, most likely a result of further reactions of the double bond of compound **124**.

4.1.2.2. Flow reaction

The radical addition reaction of thioacetic acid to alkyne **123** was investigated in continuous flow. The reaction was first performed by pumping a solution of alkyne **123**, AIBN and thioacetic acid in toluene through a PTFE reactor coil (inner diameter: 0.5 mm, volume: 1 mL) immersed in a water bath and heated up to 100 °C (Table 4.3). At the end of the coil a back-pressure regulator (BPR) with 2.7 bar back pressure was attached. With a flow rate of 0.2 mL min⁻¹ which corresponds to a 5 minute residence time, the product was obtained in 15% yield (Table 4.2, entry 1).

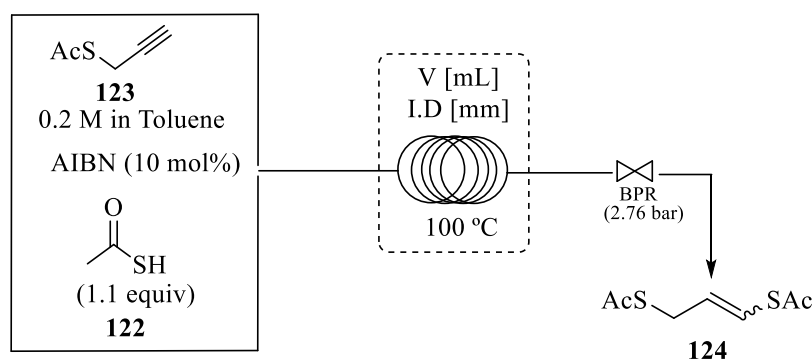

Scheme 4.3. Flow set-up for the radical addition reaction

In order to improve the outcome of the reaction, parameters such as flow rate and different reactor coils were investigated. The flow rate was decreased in order to increase the residence time (Table 4.2, entry 2 and 3). With these conditions the yield improved but only to 35%. The reactor coil was then changed to another with a smaller diameter (inner diameter: 0.175 mm). With 10 minutes residence time, the yield was improved to 54% (Table 4.2, entry 4). Increasing the residence time to 20 minutes led to slightly higher yields, however, prolonging the reaction further did not significantly affect the yields (Table 4.2, entry 5 and 6).

Table 4.2 Flow experiment of the radical addition of thioacetic acid to the alkyne 123

Entry	Flow rate [mL min ⁻¹]	Residence time [min]	Coil inner diameter [mm]	Yield [%]
1	0.2	5	0.5	15
2	0.1	10	0.5	21
3	0.05	20	0.5	35
4	0.11	10	0.175	54
5	0.055	20	0.175	71
6	0.036	30	0.175	68

Comparison of the results of entry 3 and entry 5 shows that using a smaller diameter coil drastically improved the yields. This could be explained by the better mixing, heat-transfer and increased surface-to-volume ratio achieved in smaller size reactors. All the

experiments afforded compound **124** as a 1:1.6 mixture of *E/Z* stereoisomers, which was similar to the ratio obtained in batch.

4.1.2.3. Flow electrochemistry

The radical addition reaction of thioacetic acid to alkyne **123** was investigated using a flow electrochemical reactor developed and manufactured by Wirth *et al.*^[5] The flow reactor is shown in Figure 4.1. The reactor consists of two aluminum bodies, where the electrodes are placed. They are separated by a fluorinated ethylene propylene (FEP) foil (Figure 1b) of different thicknesses, into which a reaction channel is cut. The electrodes are connected to a copper plate from which contains a wire that connects to the power supply. A solution containing the starting material is pumped through the reaction channel where the reaction occurs (Figure 1c). The reaction outcome can vary according with different parameters, such as: i) electrode material, ii) current, iii) spacer thickness, iv) flow rate.

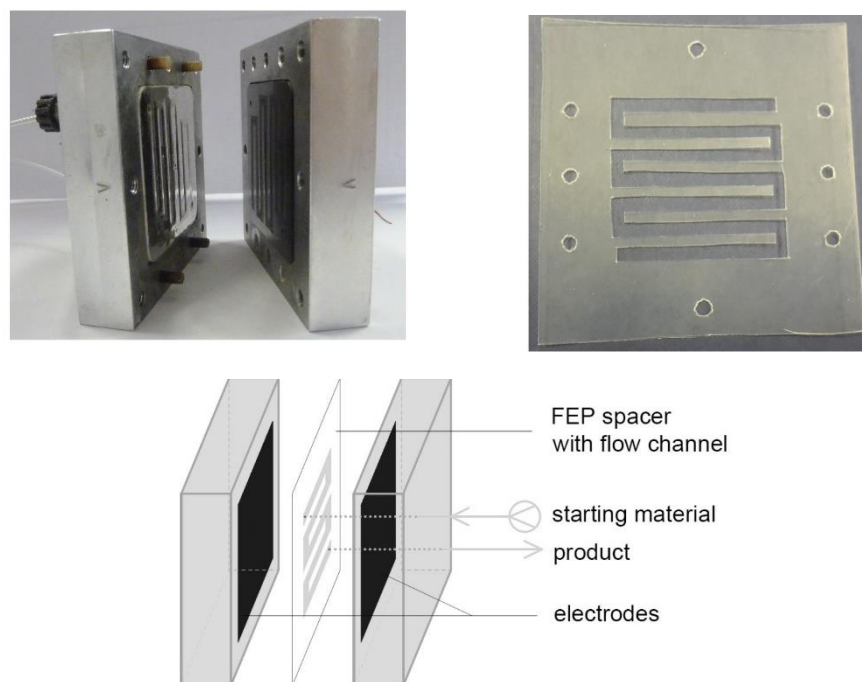

Figure 4.1. a) Flow electrochemical reactor; b) FEP spacer; c) Schematic representation of the reactor

In order to achieve full conversion of a reactant to the desired product, it is important to apply the right amount of charge to the cell. This is usually done via galvanostatic (constant current), controlling the number of electron equivalents (measured as Faradays per mole, $F \text{ mol}^{-1}$) given to the reaction medium. In theory, one mole of product needs 96

485 A s (Faraday constant F = charge of 1 mole of electrons), multiplied by the stoichiometric number of electrons required in the reaction. The theoretical current I (A) needed for a reaction performed in continuous-flow can be calculated using the following equation:^[6]

$$I = nFQ_v c$$

Equation 4.1

Where n is the number of electrons required in the electrochemical transformation; F is the Faraday constant (A s mol^{-1}); Q_v is the volumetric flow rate of the reaction solution (mL s^{-1}); and c is the concentration of the reaction solution (mol mL^{-1}).

In the previous reactions, the thiyl radical was generated due to the use of a radical initiator (e.g. AIBN or ACCN). Under electrochemical conditions, the same radical is generated by simply using current to promote the electrolysis of thioacetic acid. The reaction was investigated under different electrochemical conditions using 2 eq. of thioacetic acid and 2 F, which according to Equation 4.1, it is the minimum theoretical current required, as it is a two-electron oxidation transformation. The results are shown in Table 3. Due to the overlapping peaks of solvent, starting material and product on the ^1H NMR spectra, the reaction was analyzed and optimized using the yields of the product obtained after purification.

The formation of the desired product **124** was not detected after varying different reaction parameters such as solvent, anode and cathode material (Scheme 4.3, entry 1-4). In all the experiments the starting material was recovered together with a new compound which was identified as the dimerization product of thioacetic acid.

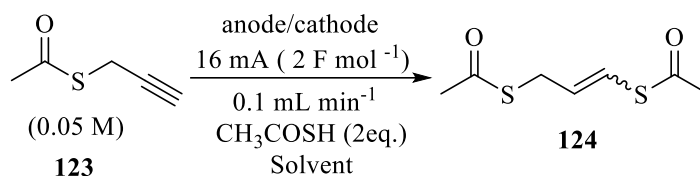

Table 4.3. Radical addition of thioacetic acid to alkyne 123 using flow electrochemistry

Entry	Anode	Cathode	Solvent	Yield [%]
1	Graphite	Pt	CH ₃ CN	n.r.
2	Pt	Graphite	CH ₃ CN	n.r.
3	Graphite	Pt	CH ₃ OH:CH ₃ CN (1:1)	n.r.
4	Pt	Graphite	CH ₃ OH:CH ₃ CN (1:1)	n.r.
5	Graphite	Pt	CH ₃ OH:HFIP (1:1)	22
7	Pt	Graphite	CH ₃ OH:HFIP (1:1)	12
8	Graphite	Pt	HFIP	52

* n.r. = no reaction

These results suggest that, under such conditions, the thiyl radical formed dimerise rather than reacting with the triple bond. It was postulated that stabilization of the formed radical would lead to better results. To explore this hypothesis, HFIP was used as solvent, since it is known to be a good radical stabiliser.^[7] Using a 1:1 mixture of methanol and HFIP as solvent led to product formation, although with low yields (Table 4.3, entry 5-7). The dimer was still detected albeit in smaller amounts. Only when HFIP was used as single solvent the yield was improved to 52% and the formation of the dimer was no longer detected. This proves not only the role of HFIP but also how crucial is for the reaction to proceed.

Having found a good solvent for the reaction, different electrode materials were investigated using the same conditions as shown in Table 4.4.

Table 4.4. Screening of different electrode materials

Entry	Anode	Cathode	Yield [%]
1	Pt	Graphite	35
2	Graphite	Graphite	13
3	Pt	Pt	n.r
4	Pt	BDD	Traces
5	BDD	Pt	Traces

It was observed that exchanging platinum and graphite for cathode and anode did not improve the yield (Table 4.4, entry 1). Using graphite as the anode and cathode led to poor yield, while no reaction was observed when the electrodes were swapped with platinum. The electrode combination of platinum and boron-doped diamond (BDD) proved inefficient since only traces amount of the product were detected (Table 4.4, entries 4 and 5). In order to further improve the result shown in Table 4.3, entry 8, different amounts of electricity were investigated.

Table 4.5. Screening of different amount of electricity

Entry	Concentration [mol L ⁻¹]	Current [mA]	F mol ⁻¹	Yield [%]
1		20	2.5	59
2	0.05	24	3	63
3		32	4	21
4	0.1	48	3	55

The results shown that by increasing the amount of electricity from 2 F to 2.5 F and 3 F, the yields were slightly improved (Table 4.5, entry 1 and 2). However, using 4 F led to degradation of the starting material and consequently to low yields (Table 4.5, entry 3).

Increasing the concentration of the reaction while using 3 F gave similar yields, which proved that higher concentrations could be tolerated in the reactor.

4.2. Selective substitution of the bis-thioacetate

This step of the synthesis consists in a S_N2 selective substitution reaction of the bis-thioacetate **124**. This transformation could be achieved by selective hydrolysis of one of the thioacetates to the corresponding thioenolate with a base and subsequent addition of an electrophilic agent. Both thioacetates in molecule **124** were expected to show almost similar reactivity towards hydrolysis. However, it was anticipated that by limiting the stoichiometric amount of base would be possible to perform the substitution reaction selectively.

4.2.1. Batch reaction

In order to verify which thioacetate group was substituted first, a preliminary attempt was performed using bis-thioacetate **124** (1:1.25 mixture of *E/Z*), potassium hydroxide as base and allyl bromide as an electrophilic agent (Scheme 3). The temperature of the reaction was kept at $-40\text{ }^\circ\text{C}$ to avoid side reactions of the highly reactive thioenolate as well as to avoid tautomerism to the thermodynamically more stable *E*-isomer. The reaction proceeded smoothly to afford compound **128** as a major compound in 42% yield. This result proved that the reaction occurs preferentially on the enolate moiety of the molecule.

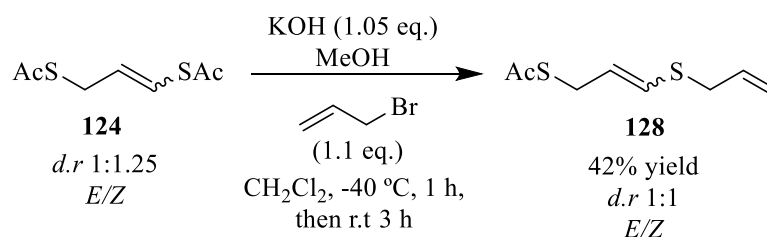

Scheme 4.4 Selective substitution reaction of bis-thioacetate **124** using potassium hydroxide and allyl bromide

The aim was to introduce a disulfide on the enolate moiety of the molecule, therefore, a reaction was carried out using the same conditions shown in Scheme 4.5, but replacing the allyl bromide with thiosulfonic acid *S*-alkyl ester. Although the desired product **126** was obtained in 43% yield (Scheme 4.5), a considerable amount of unreacted starting material **124** was recovered (31%). In order to push the reaction further, the amount of

potassium hydroxide was increased to 1.2 equivalents, however similar results to the previous reaction were obtained.

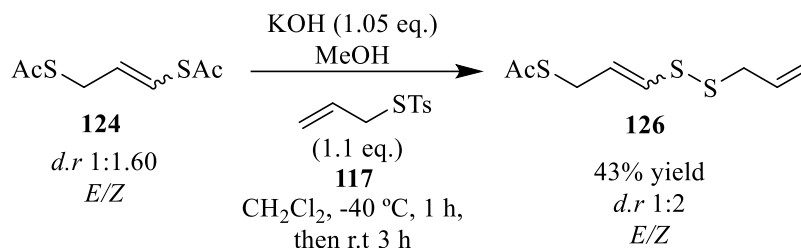

Scheme 4.5. Selective substitution reaction of the thioacetate group on the right side of molecule 124 using potassium hydroxide

Further attempts to improve the reaction were investigated by using different bases. When the reaction was performed using cesium carbonate as base, the product was obtained in slightly better yield, but starting material was still recovered (Table 4.6, entry 1). Using potassium carbonate, as a cheaper alternative to cesium carbonate gave inferior yield and a larger amount of starting material remained unreacted (Table 4.6, entry 2). Increasing the amount of caesium carbonate to 1.2 equivalents led to almost similar results. Performing the reaction at slightly higher temperatures led to full conversion of the starting material. However, the yields were diminished, and the formation of side products was detected (Table 4.6, entries 4 and 5).

Table 4.6. Different conditions for the selective substitution reaction of the thioacetate group on the right side of molecule 124

Entry	Base (eq.)	Temperature [°C]	Yield [%]	
			126	124 (recovered)
1	Cs ₂ CO ₃ (1.05)		54 ^a	15
2	K ₂ CO ₃ (1.05)	-40	37 ^a	35
3	Cs ₂ CO ₃ (1.2)		49 ^a	10
4	Cs ₂ CO ₃ (1.05)	-10	31 ^b	0
5		0	21 ^b	0

^a Product obtained as a 1:2 mixture of *E/Z* stereoisomers; ^b Product obtained as a 1:1 mixture of *E/Z* stereoisomers;

All the experiments carried out at -40 °C afforded the product as 1:2 mixture of *E/Z* stereoisomers. Surprisingly, this ratio changed to 1:1 when the reaction was performed at slightly higher temperatures (Table 4.6, entries 4 and 5), which could be explained by ene-thiolate intermediate tautomerism to the thermodynamically more stable *E*-isomer. The proposed mechanism for the tautomerism is shown in Scheme 4.6.

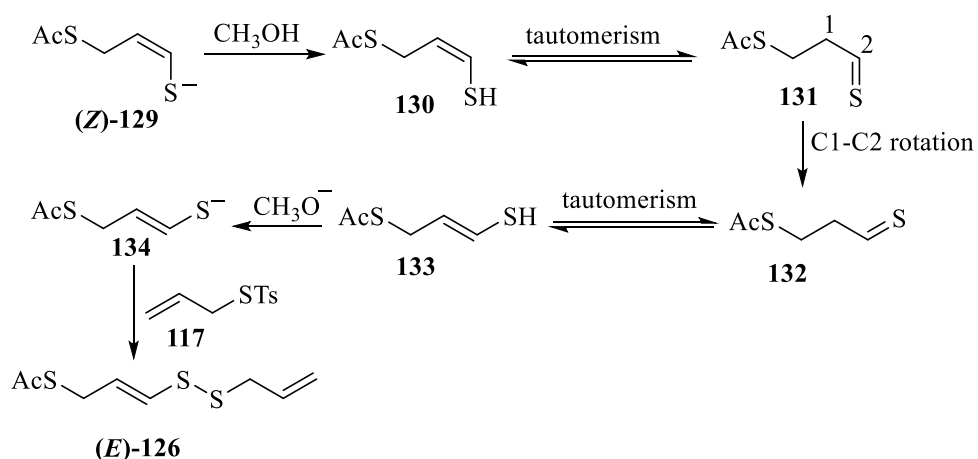
**Scheme 4.6. Proposed mechanism for ene-thiolate tautomerism**

First, the ene-thiolate **129** undergoes proton exchange with methanol to form the ene-thiol **130**, which tautomerises to the corresponding thioaldehyde **131**. Free rotation about C1-C2 single bond to minimise steric strain followed by second tautomerism gives the thermodynamically more stable *E*-ene-thiol **133**. Subsequent deprotonation by methoxide produces the *E*-ene-thiolate **134**, which reacts with thiosulfonic acid *S*-alkyl ester to form the stable *E*-vinyl disulfide (*E*)-**126**.

With compound **126** (1:2 mixture of *E/Z* stereoisomers) in hand, the substitution reaction of the thioacetate on left-hand side was carried out using cesium carbonate as base (Scheme 4.7). The desired product **127** was isolated as 1:0.5 mixture of *E/Z* stereoisomers in 47% yield. Potassium hydroxide was avoided as base in this reaction, because, as a nucleophilic base, beside cleaving the thioacetate group it would also cleave the disulfide bond.

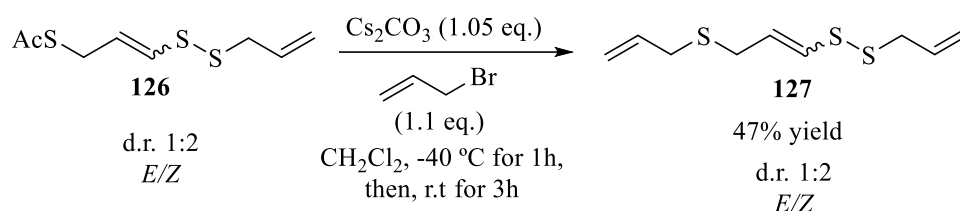

Scheme 4.7. Substitution reaction of the thioacetate group of compound 126

4.2.2. Flow reaction

The selective substitution of the bis-thioacetate **124** was investigated in continuous flow. An initial attempt was carried out by pumping two separated solutions, one containing the bis-thioacetate **124** and thiosulfonic acid *S*-alkyl ester **117** in a mixture of methanol/dichloromethane, and the other with the cesium carbonate in methanol through a T-piece mixer connected to a 1 mL PTFE reactor coil (inner diameter: 0.5 mm) placed at -40 °C. At a flow rate of 0.2 mL min⁻¹ which corresponded to a 5 min residence time, the reaction proceeded well to afford product **126** in 58% yield, however full consumption of the starting material could not be observed.

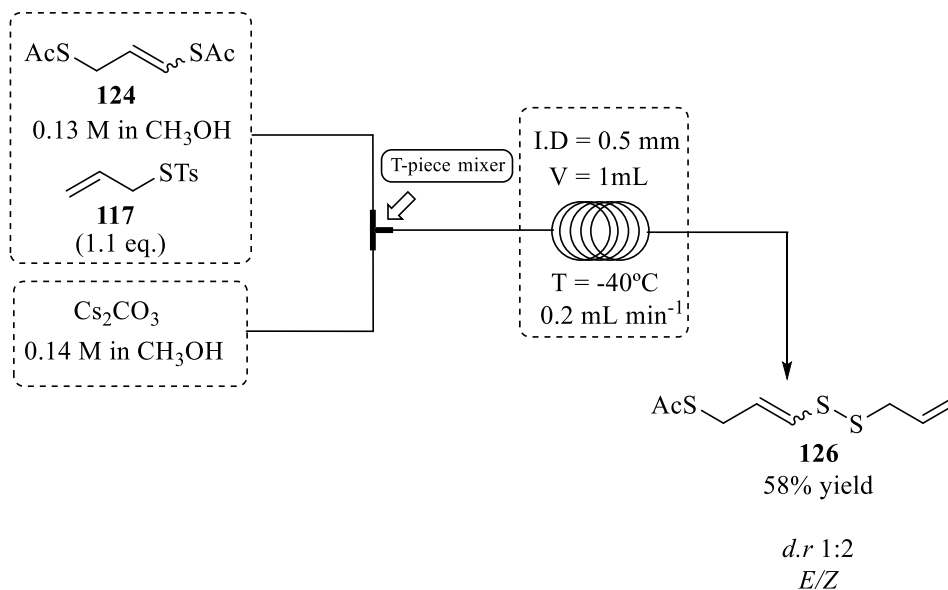

Scheme 4.8. Flow set-up for the selective substitution reaction of the thioacetate group on the right side of molecule 124

To explore the reaction further, parameters such as base, residence time, temperature and inner diameter of the reactor coil were investigated. Under same reaction conditions but extending the residence time to ten minutes did not significantly affect the outcome of the reaction (Table 4.7, entry 1). Increasing the temperature had no significant effect on the yields (Table 4.7, entry 2 and 4). It is worth it to mention that the ratio of *E/Z* stereoisomers of the product was also not affected by the temperature, contrarily to what was observed in batch. This could perhaps be explained by a faster reaction between the intermediate ene-thiolate with thiosulfonic acid *S*-alkyl ester achieved in the coil reactor due to the increased surface-to-volume ratio and better mixing. Using a small diameter reactor coil did not show any further impact in the reaction, as the yields were similar to what attained with the initial coil (Table 4.7, entry 5). Increasing the amount of cesium carbonate led to a drop in the yield, and in addition the formation of side products was observed. Potassium hydroxide as base did not improve the reaction and comparable results to caesium carbonate were obtained at 0 °C (compare Table 4.7, entries 8 and 9). Carrying the reaction for longer time at room temperature led to poor yield and again the formation of side products was detected. In all the attempts, except Table 4.7, entry 6, total consumption of the starting material was not observed.

Table 4.7. Different conditions for the selective substitution reaction of the thioacetate group on the right of molecule 124 in continuous flow

Entry	Base	Internal diameter [mm]	Flow rate [mL min ⁻¹]	Residence time [min]	Temperature [°C]	Yield [%]
1		0.5	0.1	10	-40	56
2		0.5	0.2	5	0	51
3	Cs ₂ CO ₃	0.5	0.06	15	0	44
4		0.5	0.2	5	r.t.	55
5		0.175	0.22	5	0	57
6 ^a		0.175	0.22	5	0	21
7		0.175	0.22	5	0	58
8	KOH	0.175	0.11	10	0	44
9		0.175	0.11	5	r.t.	31

^a 2 equivalents of Cs₂CO₃

Next, the substitution of the thioacetate on the left side was performed using a similar flow set-up by mixing two solutions, one containing compound **126**, allyl bromide in methanol, and the other with the cesium carbonate in methanol (Scheme 4.9). They were pumped through a PTFE reactor coil (inner diameter: 0.175) placed at 0 °C at a flow rate of 0.22 mL min⁻¹ (residence time: 5 minutes). Under these conditions, the desired product **127** was isolated as a 1:2 mixture of *E/Z* stereoisomers in 53% yield.

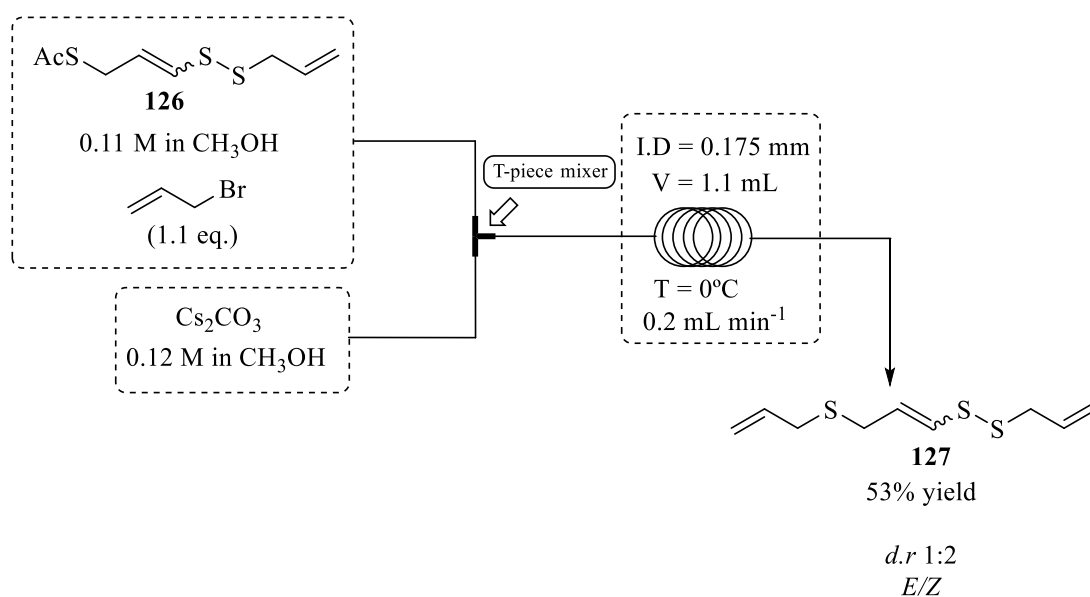

Scheme 4.9. Flow set-up for the selective substitution reaction of the thioacetate group of compound **126**

4.3. Oxidation of compound **127**

The final step towards the synthesis of ajoene involved the chemoselective oxidation of compound **127** using *m*CPBA as the oxidizing agent at low temperatures (Scheme 4.10). The reaction proceeded well to afford ajoene as a 1:1 mixture of *E/Z* stereoisomers in 89% yield. The selectivity of the reaction towards the oxidation of the sulfide over the vinyl disulfide functionality may be explained due to the greater nucleophilicity of the sulfide.

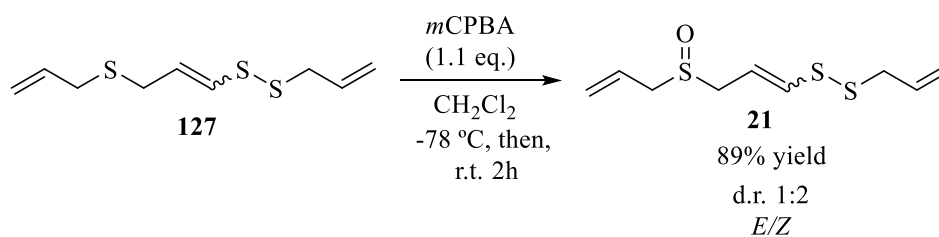

Scheme 4.10. Oxidation reaction of compound **127** using *m*CPBA

4.4. Conclusions and future work

In conclusion, a new synthetic protocol for the synthesis of ajoene has been developed from simple and easily available starting materials. The synthetic sequence was carried out in batch and in flow. Although both processes gave similar yields of products, the flow process had the benefit of reducing the reaction times, improve the safety profile of the reactions and offer the possibility of an easy scale-up. The radical addition reaction of thioacetic acid to compound **123** proved possible under flow electrochemistry conditions. Under the reaction conditions the radical initiator, usually employed to generate the thiyl radical in normal conditions, was replaced by electricity, thus making the reaction more environmentally friendly. One advantage of this methodology over the protocol developed in Chapter 3 is the use of simpler and less toxic starting materials. However, the overall yield of the synthesis (batch: 7% and flow: 8%) was much lower than the previous synthesis.

Future work:

As most of the reactions of the synthetic sequence were already attempted and shown possible in continuous flow, as multistep synthesis of ajoene could be investigated. This could lead to a very flexible and faster protocol to produce of ajoene in a continuous fashion.

4.5. References

- [1] E. Block, *Garlic and Other Alliums: The Lore and the Science*, Thomas Graham House, Science Park, Cambridge, **2010**.
- [2] T. H. Jakobsen, M. Van Gennip, R. K. Phipps, M. S. Shanmugham, L. D. Christensen, M. Alhede, M. E. Skindersoe, T. B. Rasmussen, K. Friedrich, F. Uthe, et al., *Antimicrob. Agents Chemother.* **2012**, *56*, 2314–2325.
- [3] H. He, S. Averick, E. Roth, D. Luebke, H. Nulwala, K. Matyjaszewski, *Polymer* **2014**, *55*, 3330–3338.
- [4] J. Castro, A. Moyano, M. A. Pericàs, A. Riera, *Synthesis* **1997**, *5*, 518–520.
- [5] A. A. Folgueiras-Amador, K. Philipps, S. Guilbaud, J. Poelakker, T. Wirth, *Angew. Chem. Int. Ed.* **2017**, *56*, 15446–15450.
- [6] R. A. Green, R. C. D. Brown, D. Pletcher, *J. Flow Chem.* **2015**, *5*, 31–36.
- [7] L. Eberson, O. Persson, M. P. Hartshorn, *Angew. Chem. Int. Ed. English* **1995**, *34*, 2268–2269.

**CHAPTER 5: Selective oxidation of sulfides in
flow chemistry**

5. Introduction

5.1. Sulfoxides

Sulfoxides are very important moieties widely used in the preparation of biologically and pharmaceutically significant compounds. They constitute a relevant motif in marketed therapeutics^[1,2] and in ligands for transition-metal catalyzed transformations.^{[3][4]} Moreover, they commonly occur in natural products with active biological character.^[5,6] In fact, the sulfoxide moiety can be found in several organosulfur compounds derived from garlic. Some examples are the cysteine amino acids, such as allin **6** and methiin **7**, present in intact garlic and the thiosulfinates, such as allicin **5** and dimethyl thiosulfinate **135**, generated via enzymatic cleavage of **6** and **7** upon the crushing of garlic. Also, ajoene **21** contains a sulfoxide within its structure. The oxidation of sulfides is the most straightforward and frequently used method for the synthesis of the corresponding sulfoxides.

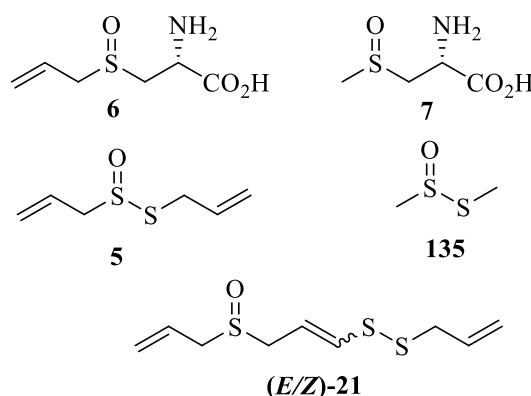
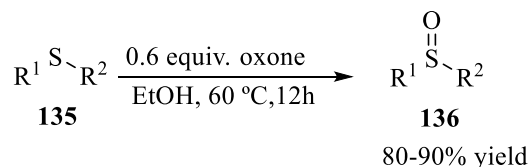

Figure 5.1 Sulfoxide-containing compounds from garlic

5.2. Methods for the oxidation of sulfides to sulfoxides

Research in sulfur chemistry has addressed the selective oxidation of sulfides to sulfoxides without overoxidation to sulfones or other undesired side reactions. A wide variety of oxidizing agents have been reported, such as, hydrogen peroxide,^[7] *m*-chloroperbenzoic acid,^[8] urea/hydrogen peroxide,^[9] sodium hypochlorite,^[10] sodium periodate^[11], *tert*-butyl hydroperoxide,^[12] and dioxiranes.^[13] Most of these methods require either stoichiometric amounts of reagents or a transition metal catalyst.

In 2012, Li *et al.* reported a selective oxidation of sulfides by employing Oxone[®] as the oxidant without the utilization of any catalyst/additive under mild conditions (Scheme 5.1).^[14] The degree of oxidation was achieved by solvent selection that preferentially produced the sulfoxide.



Scheme 5.1. Oxidation of sulfide to sulfoxide using oxone

5.2.1. Methods for oxidation of sulfides in flow

Microreactors have been used in many organic synthesis transformations due to their efficiency, selectivity and high degree of safety. There are few reports regarding the selective oxidation of sulfides in continuous-flow microreactors.

In 2008, Noguchi *et al.* reported the selective oxidation of sulfides to sulfoxides by using 30% hydrogen peroxide without catalyst in a stainless-steel capillary microreactor (Scheme 5.2).^[15] The rapid mixing provided by the micromixer allowed the oxidation of sulfides in shorter reaction time and regulation of the relative amount of hydrogen peroxide by using syringe pumps prevented over-oxidation. A variety of sulfides were oxidized to the corresponding sulfoxides in yields up to 80%.

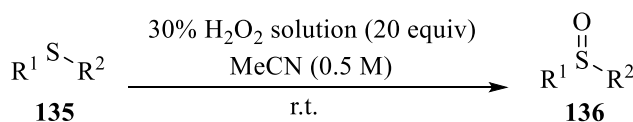

Microflow conditions:

- reactor: stainless steel capillary tubing
- size: 1 mm ID, 730 μL

Scheme 5.2. Oxidation of sulfides with a 30% solution of H₂O₂ in a stainless-steel capillary microreactor

In 2011, Maggi *et al.* published the oxidation of sulfides with diluted hydrogen peroxide, catalysed by Amberlite IR-120aH in a continuous flow reactor.^[16] Several aryl alkyl sulfides **137** were oxidised to the corresponding sulfoxides **138** in high yields. The process has the advantage of not requiring the use of any metal for the activation of the oxidizing reagent.

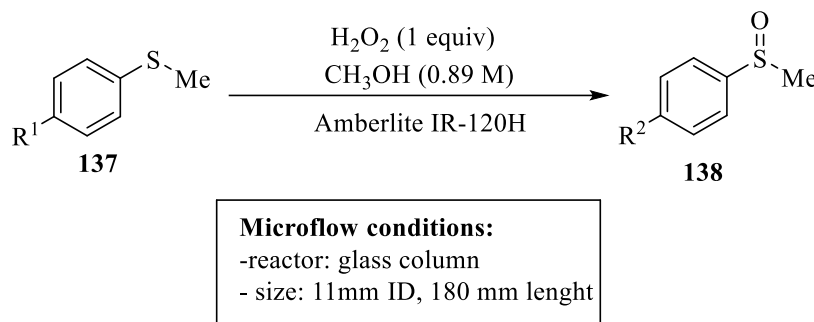

Scheme 5.3. Continuous flow oxidation of various sulfides with a 3% aqueous H₂O₂ catalyzed by Amberlite IR 120aH

In 2015, Doherty, Hardacre *et al.* reported a segmented flow process for the oxidation of sulfides based on a catalyst cartridge packed with a mixture of [PO₄{WO(O₂)₂}₄]@PIILP and silica (Scheme 5.4). The method gave good conversions and high selectivity for sulfoxide in methanol at short residence times. The catalyst proved to be remarkably robust, ideally suited for scale-up and remained active for 8 hours under continuous flow conditions with a stable activity-selectivity profile.

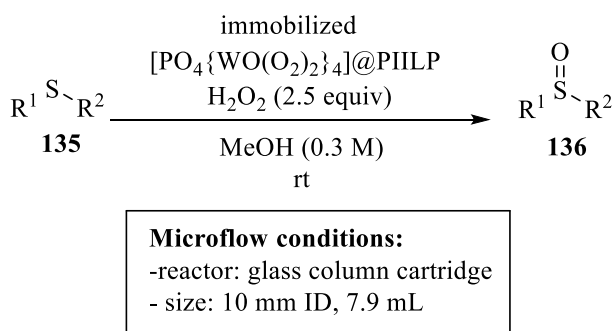

Scheme 5.4. Oxidation of thioanisole with a 30% solution of H₂O₂ in a microreactor using a peroxometalate-based polymer immobilized ionic liquid phase catalyst

Previous members in Wirth group investigated the use of a packed-bed reactor in the selective oxidation of sulfides.^[17] The packed-bed reactor setup is shown in Figure 1. The reactor consisted in an Omnifit glass column (150 mm length, 6.6 mm internal diameter) placed inside of a glass heating jacket and connected to a Vapourtec E-series. The heating jacket allowed the precise control of the temperature. The glass column was packed with Oxone[®] and connected to a backpressure regulator (BRP). The reaction only proceeds with low concentration of sulfide at determined temperatures and solvent. This method was investigated in this chapter in order to improve the previous results on the selective

oxidation of sulfides. For this reason, a summary of the best results will be given in more detail in Section 5.5.1

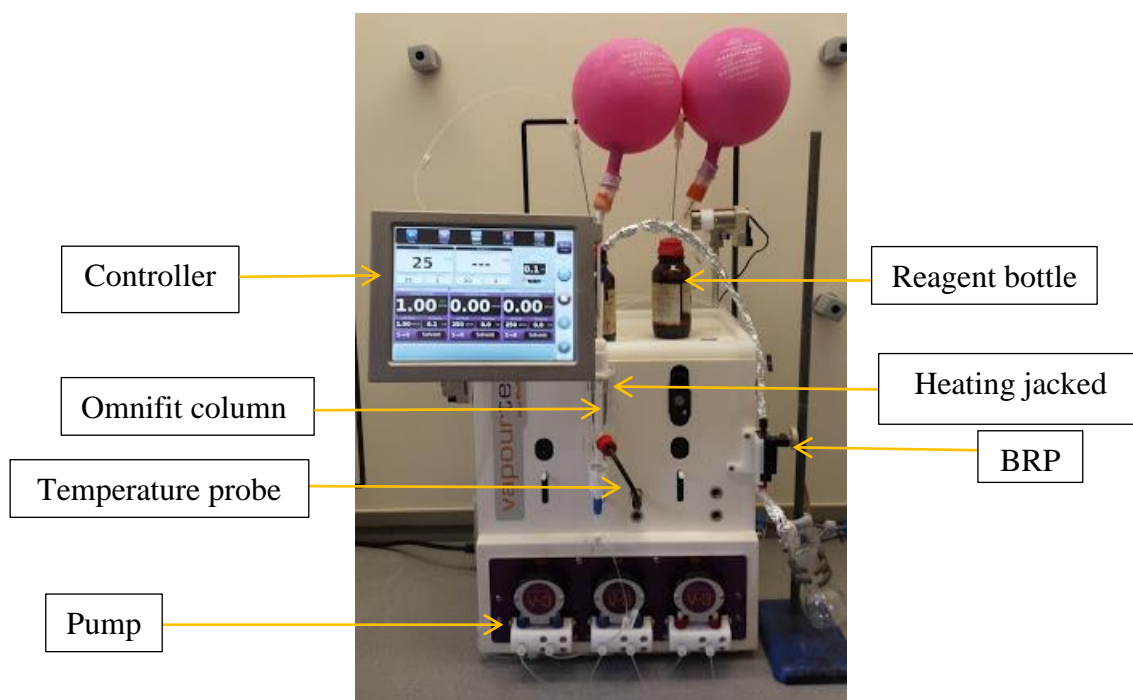

Figure 5.2 Packed-bed reactor setup

5.3. Synthesis of Allicin via oxidation of diallyl disulfide

The importance of allicin in the chemistry of garlic is already explained in chapter 1. In this section, only the literature regarding the synthesis of allicin is presented.

In 1947, Small *et al* described the first synthesis of allicin via oxidation of diallyl disulfide using perbenzoic acid.^[18] This approach became the main procedure to synthesise allicin. Several oxidants to perform the reaction were investigated over the years.

In 1986, Block *et al.* oxidised commercially available diallyl disulfide using peracetic acid at 0 °C to produce allicin in 90% yield after chromatography.^[19] In 1998, Freeman and Kodera performed the same reaction using hydrogen peroxide and acetic acid to obtain allicin with 93% purity (Scheme 5.5).^[20]

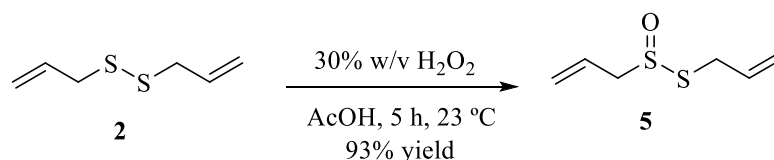

Scheme 5.5. Oxidation of diallyl disulfide 2 using hydrogen peroxide

In 2009, Pratt *et al.* utilized *meta*-chloroperoxybenzoic acid (*m*CPBA) in chloroform. Allicin was obtained in 85% yield after chromatography (Scheme 5.6).^[21]

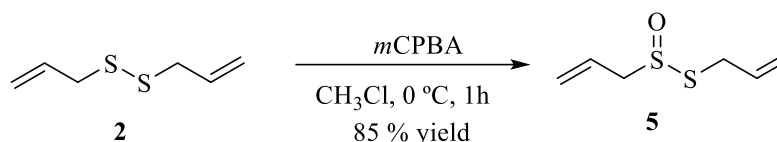

Scheme 5.6. Oxidation of diallyl disulfide 2 using *m*CPBA

The packed-bed reactor with Oxone[®] described in Section 5.2.1 was also investigated in the oxidation of diallyl disulfide to produce allicin.^[17] However, the protocol only gave moderate conversions (35-65%) and the isolated yields were not reported.

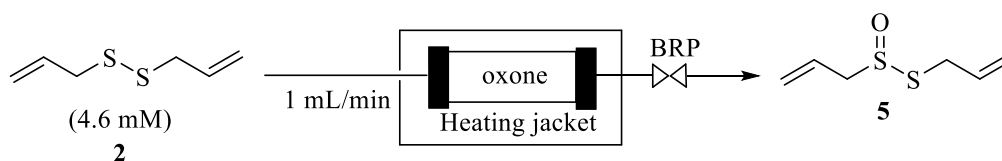

Scheme 5.7. Oxidation of diallyl disulfide 2 in a packed-bed reactor with oxone

In 2010, Neem Biotech patented a procedure in which Oxone in 50% aqueous ethanol is used to oxidise diallyl disulfide thereby producing the crude allicin in 90% purity.^[22] Another patent describes the use of oxone to generate DMDO solution, which is subsequently used to produce allicin in 96% yield after chromatography. Although the yields of this process are high, low temperatures, low concentrations of DMDO and inert atmosphere are required, which creates challenges on large scale.^[23] The most recent patent utilized L-proline and hydrogen peroxide in THF to produce allicin in 80% yield with 90% purity after chromatography.^[24]

5.4. Objectives

The selective oxidation of sulfides to sulfoxides without overoxidation to sulfones is an important reaction for the preparation of garlic metabolites. The aim of this project was to improve the outcome of the selective oxidation of sulfides in flow chemistry utilizing a packed-bed reactor with Oxone[®] developed by a previous member in the group and described above in section 6.2.1. Furthermore, the developed protocol was applied to the oxidation of sulfides with different substituent groups, disulfides, more specifically, diallyl disulfide to produce allicin.

5.5. Selective oxidation of sulfides in a packed-bed reactor with oxone

This section regarding the work on the selective oxidation of sulfides in a packed-bed reactor with Oxone[®] comprises: i) the summary of the results obtained by previous members, ii) the optimization of the reaction conditions using thioanisole and substrate scope, iii) the optimization of the reaction conditions using dibenzyl disulfide and substrate scope, iv) synthesis of allicin

5.5.1. Previous results

As mentioned before, previous members in the group investigated the use of a packed-bed reactor with Oxone[®] in the selective oxidation of sulfides. In this work, a solution containing thioanisole **137a** (4.6 mM) was pumped through a packed-bed reactor with oxone with a flow rate of 1.0 mL/min, which corresponded to a residence time of approximately 2 minutes within the reactor.

Parameters, such as solvent and temperature within the column were screened. A summary of the results obtained is given in Table 5.1. The reaction carried out in acetone gave the sulfoxide **138a** in good conversion at 45 °C (Table 5.1, entry 1). No oxidation reaction was observed when dichloromethane was used as a solvent, independently of the temperature. The reaction performed in ethanol at 25 °C afforded the sulfoxide **138a** only in 40% conversion at 25 °C (Table 5.1, entry 3). Increasing the temperature led to the formation of the corresponding sulfone. Better results were obtained when anhydrous solvents were utilized. Anhydrous ethanol at 45 °C produced the desired sulfoxide with

99% conversion (Table 5.1, entry 4), while anhydrous acetone produced the sulfoxide in 77% conversion at 65 °C (Table 5.1, entry 5).

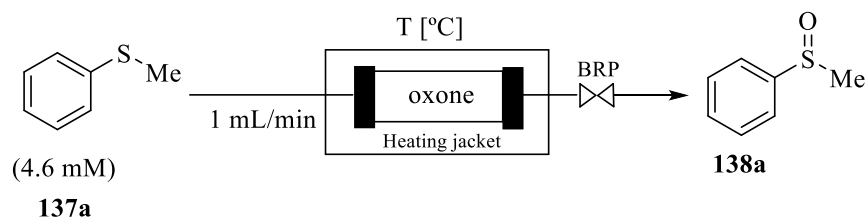

Table 5.1 Summary of the best results

Entry	Solvent	T [°C]	Conversion [%]
1	CH ₃ CO	45	84
2	CH ₂ Cl ₂	25 to 45	0
3	EtOH	25	40
4*	CH ₃ CO	65	77
5*	EtOH	45	99

*anhydrous conditions

^a Determined by ¹H NMR spectroscopic analysis.

The selective oxidation of diallyl disulfide **2** to produce allicin **5** was also investigated using the same protocol. A solution of diallyl disulfide **2** (4.6 mM) in acetone was pumped through a packed-bed reactor with oxone with a flow rate of 1.0 mL/min. The temperature of the column was investigated in order to find the optimum conditions to perform the reaction. The results showed that higher temperatures improve the conversion of the diallyl disulfide into allicin (Table 5.2). Other parameters such solvent and retention time were not investigated. The isolated yields of allicin were not reported.

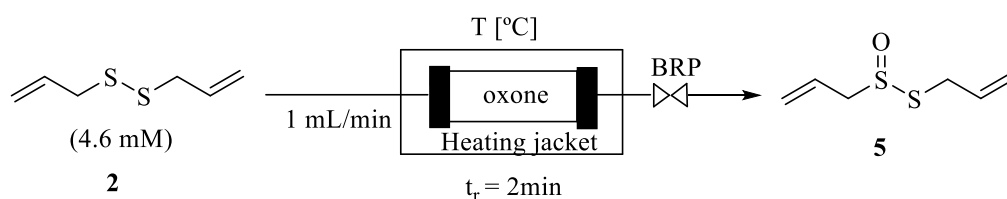

Table 5.2. Summary of the best results

Entry	T [°C]	Conversion [%]
1	25	35
2	35	44
3	45	26
4	65	31
5	75	51
6	85	65

Although the results obtained were promising, the protocol showed some limitations, such as: i) low concentrations of sulfide or disulfide solution is necessary, ii) the need of high temperatures in the column to achieve good conversions, ii) reproducibility issues. The disadvantage of using elevated temperatures is related with the increase of oxone solubility, which causes precipitation and consequently blockage of the BPR. In addition, it was observed that an increase in temperature led to lower selectivity (sulfoxide vs. sulfone).

5.5.2. Optimization of the reaction conditions using thioanisole

For this study, thioanisole **137a** was kept as the model substrate to find suitable reaction conditions. Initial reactions were carried out by pumping a 0.05 M solution of sulfide **137a** in 15% trifluoroacetic acid (TFA) in dichloromethane through an Omnifit column packed with oxone (Table 5.3, entry 1). The flow rate of 0.5 mL/min corresponded to a residence time of 4 minutes within the reactor. Upon collection, it was shown that conversion of 100% was achieved, as shown by ^1H NMR spectroscopic analysis.

In order to increase the production rate, higher concentrations of the substrate were investigated. Increasing the concentration of the sulfide **137a** solution to either 0.1, 0.15 or 0.2 M (Table 5.3, entries 2-4) led to identical results. However, when the concentration

of the sulfide solution **137a** was further increased to 0.4 M, the conversion dropped to 55% (Table 5.3, entry 5).

Table 5.3. Optimization of the reaction conditions in a solution of TFA in CH₂Cl₂

Entry	Concentration [mol L ⁻¹]	TFA [vol-%]	Residence time [min]	Conversion [%] ^a
1	0.05	15	4	100
2	0.1	15	4	100
3	0.15	15	4	100
4	0.2	15	4	100
5	0.4	15	4	55
6	0.2	10	4	20
7	0.2	10	17	33
8	0.2	10	30	50
9	0.2	10	60	68

^a Determined by ¹H NMR spectroscopic analysis.

The presence of trifluoroacetic acid in dichloromethane proved to be crucial as in its absence the reaction did not occur. The minimum percentage of TFA to perform the reaction was accessed by decreasing the percentage from 15% to 10% which resulted in a massive conversion drop to 20% (Table 5.3, entry 6). Using 10 % TFA but prolonging the residence time increased the conversion substantially, but full conversion was not even obtained after 60 minutes reaction time (Table 5.3, entry 9).

To show the potential of the develop method, a larger scale reaction (10 mmol of thioanisole **137a**) was performed using the same packed-bed reactor with oxone. The corresponding sulfoxide was obtained in 99% conversion (95 % yield). This demonstrates that the reaction can be easily scaled-up without affecting the conversion and with no change in the residence time.

To verify if the same oxone could be used with different substrates, after performing a reaction with thioanisole **137a**, the oxone was washed with dichloromethane and used to perform a second reaction with 4-(methylthio)toluene. The corresponding sulfoxide was obtained in 99% conversion without contamination of thioanisole. This shows that the

packed bed reactor could be simply washed with dichloromethane and reused with a different substrate until the oxone was fully consumed.

5.5.3. Substrate scope of sulfides

With the optimised conditions in hand (Table 5.3, entry 4), the substrate scope was explored (Scheme 5.8). Different sulfides were reacted affording the desired sulfoxides in good to excellent yields.

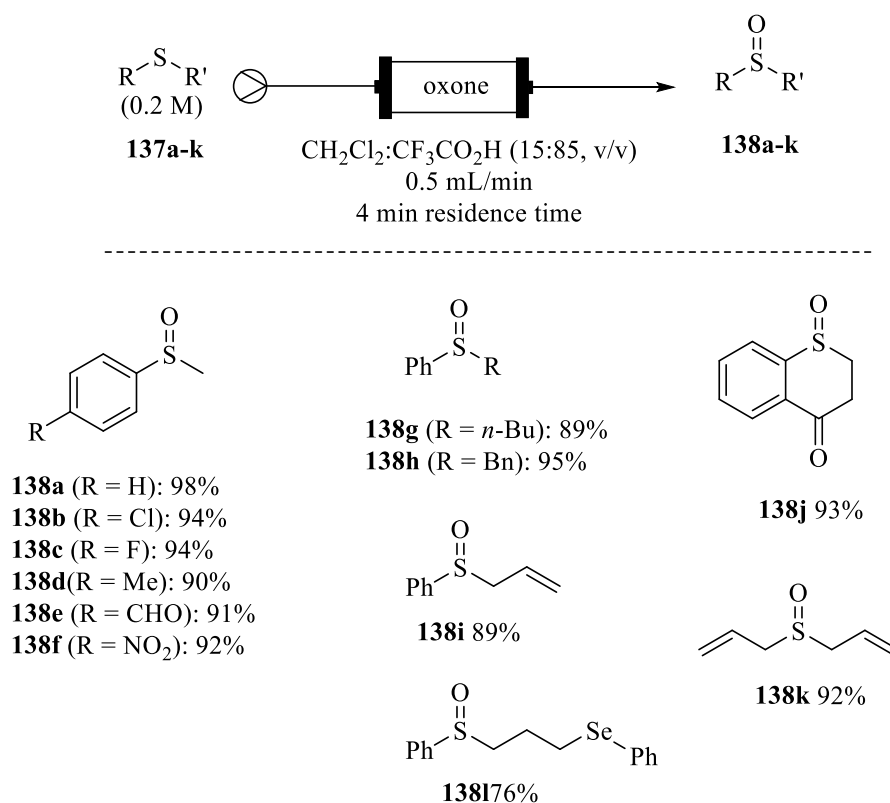

Scheme 5.8. Substrate scope for the oxidation of sulfides using flow conditions

Specifically, phenyl sulfides bearing aliphatic (**137g**), benzyl (**137h**) and allyl (**137i**) substituents afforded the sulfoxides in high yields. The yields were not affected by the electronic structure of the phenyl sulfides.

As it can be seen in Scheme 12, *para*-substituted phenyl sulfides (**137b-137f**) with electron-donating or electron-withdrawing groups gave the sulfoxides **138** in good yields. Similarly, sulfide **137j** bearing a ketone also underwent efficient oxidation to afford the corresponding sulfoxide **138j** and a possible Baeyer-Villiger reaction was not observed. Moreover, the present protocol could be also applicable to oxidation of diallyl sulfide **137k**. In the case of allyl sulfides no epoxide formation was observed.

Interestingly, compound **137l** contains both a phenyl sulfide and a phenyl selenide moiety (Scheme 5.8), but the only product obtained was the sulfoxide **138l** in 76% yield. To demonstrate the chemoselectivity of this procedure, the same substrate **137l** was treated with one equivalent of *m*CPBA under batch conditions. The reaction now afforded sulfoxide **138l** in very low yield (7%), together with compound **137i** (8%) and **138i** (10%) (Scheme 5.9). The starting material was recovered in 43% yield. Under the oxidizing conditions, the selenide was partially oxidized to the selenoxide, which then underwent elimination generating the corresponding alkenes **138i** and **137i** (Scheme 5.9). However, when the oxidation with *m*CPBA was carried out in the presence of 10 vol-% TFA, only compound **138l** was obtained in 70% yield. This result suggests the same effect of TFA in the reaction performed with a different peroxy acid.

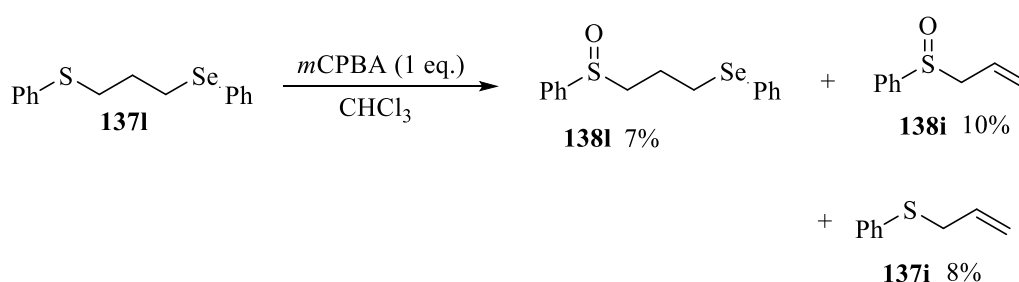

Scheme 5.9. Oxidation of compound 137l with *m*CPBA.

In order to understand this result, the cyclic voltammetry of compound **137l** was measured in the absence and in presence of 10 vol-% TFA. In the absence of TFA, the cyclic voltammetry showed two different oxidation potentials (1.17 V and 1.70 V). In the presence of 10 vol-% TFA a slight decrease of the two oxidation potentials (1.00 V and

1.50 V) was observed. This result may suggest the protonation of the selenide which, therefore, prevents its oxidation in the presence of TFA.

5.5.4. Optimization of the reaction conditions using dibenzyl disulfide

The optimal reaction conditions found for oxidizing sulfides were initially employed in the oxidation of dibenzyl disulfide **139a**. The ^1H NMR of the crude reaction mixture revealed the presence of disulfide **139a** (35%), thiosulfinate **140a** (35%) and thiosulfonate **141** (30%). Further optimization studies were carried in order to obtain the thiosulfinate selectively (Table 5.4).

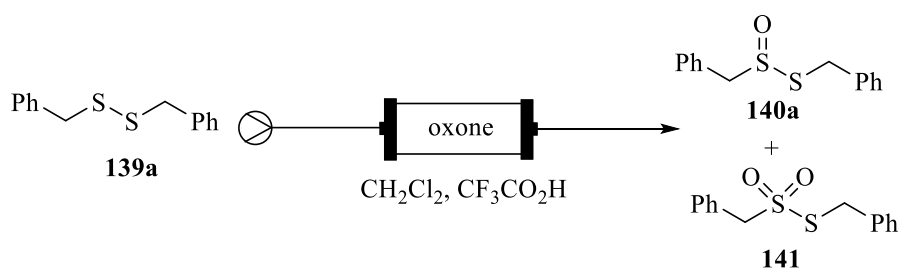

Table 5.4. Optimization of the reaction conditions in a solution of TFA in CH₂Cl₂

Entry	Concentration [mol L ⁻¹]	TFA [vol-%]	Residence time [min.]	Conversion [%] ^a		
				139a	140a	141
1	0.200	15	4	35	35	30
2	0.100	15	4	23	50	27
3	0.050	15	4	20	53	27
4	0.025	15	4	8	82	8
5	0.025	10	4	3	97	0
6	0.050	10	4	7	87	6
7	0.100	10	4	28	66	6
8	0.100	10	8	14	70	16

^a Determined by ^1H NMR spectroscopic analysis.

The first parameter being investigated was the concentration of the substrate solution. It was observed that decreasing the concentration of the disulfide **139a** from 0.2 M to 0.1 M and 0.05 M slightly increased the conversion. However, thiosulfonate **141** was still detected at lower concentrations (Table 5.4, entry 2). Only when the concentration of

139a was reduced to 0.025 M, the conversion increased to 82% (Table 5.4, entry 4). The percentage of TFA in the mixture was the second parameter evaluated. Reducing the percentage of TFA in the mixture from 15% to 10%, resulted in almost full conversion to thiosulfinate **140a** and thiosulfonate **141** was no longer detected by ^1H NMR (Table 5.4, entry 5). This result demonstrated that a 5% excess of TFA led to a lower selectivity (thiosulfinate vs thiosulfonate). Increasing the concentration of disulfide **137a** to 0.05 M and 0.1 M, while using 10 vol.% TFA led to a diminished conversion (Table 5.4, entries 6 and 7). Under such conditions but increasing the residence time barely affected the conversion (Table 5.4, entry 8).

The oxidation reaction with disulfides proved to be more sensitive to the amount of TFA in comparison with the sulfides. In fact, the percentage of TFA had to be decreased to 10 vol.-% in order to avoid overoxidation to the corresponding thiosulfonate. In addition, the reaction gave better conversions when the concentration of disulfide was decreased to 0.025 M.

5.5.5. Substrate scope of disulfides

With optimized reaction conditions in hand (Table 4, entry 5), the oxidation of various symmetric disulfides was examined to explore the scope of the protocol. Disulfides **139a-b** with an electron-withdrawing group in the aromatic ring were oxidized to thiosulfinate **140a-b** in good yield (89%). Moreover, the oxidation of cinnamyl and allyl disulfides proceeded chemoselectively to the corresponding sulfoxides in moderate yields without the epoxidation of the double bonds. This system was also applicable to the oxidation of dialkyl disulfides into the corresponding thiosulfinates **140a-e** (72%) and **140a-f** (59%), even in the case of the hindered *tert*-butyl disulfide **139a-e**.

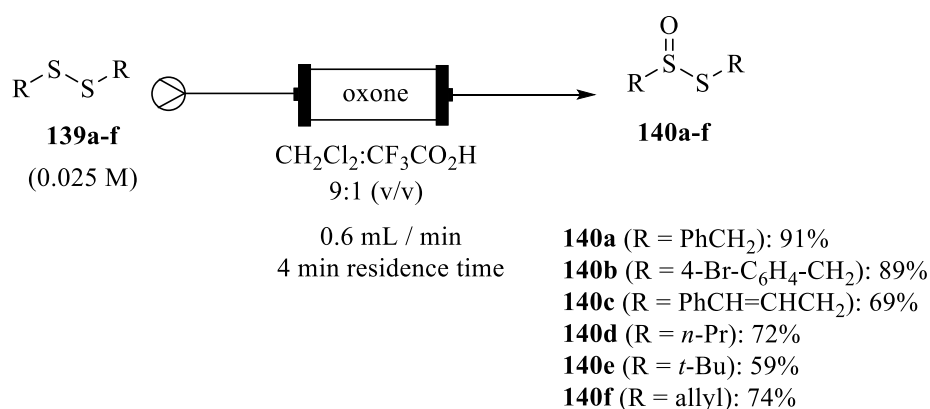

Scheme 5.10. Substrate scope for the oxidation of disulfides **139** using flow conditions.

In comparison with the sulfoxides, thiosulfinates were obtained in lower yields. This is explained by the lower stability of the thiosulfinates. In fact, thiosulfinates undergo Cope elimination to form sulfenic acids, along with thioaldehydes or thioketones. This process does not require elevated temperatures as it is necessary in the case of sulfoxides, because the S-S bond in the thiosulfinate is much weaker than the S-C bond in the sulfoxide. Cope elimination is even more facile for allyl, cinnamyl, benzyl thiosulfinates, because of the weak β -carbon-hydrogen bond in these compounds.

5.5.6. Synthesis of allicin via oxidation of diallyl disulfide

In order to develop an efficient synthesis of allicin using the packed-bed reactor, the oxidation of diallyl disulfide was investigated in more detail. Under the optimised conditions found to oxidise dibenzyl disulfide, diallyl disulfide was oxidised to allicin in good yield (74%) (Table 5.5, entry 1). Increasing the residence time slightly decreased the yield as well as led to the formation of the corresponding thiosulfonate.

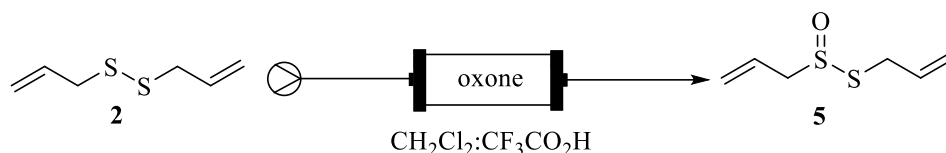

Table 5.5. Optimization of the reaction conditions for the oxidation of diallyl disulfide

Entry	Concentration [mol L ⁻¹]	TFA [vol-%]	Residence time [min.]	Yield [%]
1	0.025	10	4	74
2	0.025	10	8	61
3	0.05	10	4	72
4	0.1	10	4	31
5	0.1	10	8	49
6	0.1	10	12	48
7	0.1	15	4	19

Higher concentrations were investigated in order to increase the production rate of allicin **5**. The results showed that increasing the concentration to 0.05 M did not affect the yield significantly (Table 5.5, entry 3). However, a significant drop in yield was observed when the concentration was increased to 0.1 M. Under the same reaction conditions with longer residence times led to slightly higher yields but at the same time to the formation of thiosulfonate (Table 5.5, entry 5 and 6). Increasing the percentage of TFA to 15% not only did not improve the yield but also caused degradation of allicin **5** (Table 5.5, entry 7).

5.5.7. Proposed mechanism

The presence of trifluoroacetic acid (TFA) proved to be crucial for the reaction to occur in the packed-bed reactor. Oxone in the presence of trifluoroacetic acid has been used for the oxidation of diarylacetylenes to 1,2-diketones,^[25] ketones or alkynes to carboxylic acids^[26] and perfluoroalkyl iodides to the corresponding bis(trifluoroacetoxy)iido derivatives.^[27] However, none of the reports suggest a mechanism how oxone is activated in the presence of TFA.

Venier *et al.* reported trifluoroperacetic acid as quick, convenient and selective reagent for the oxidation of sulfides to either sulfoxides or sulfones.^[28] The reagent was prepared by mixing 30% hydrogen peroxide and trifluoroacetic acid and then added to the sulfide mixture. Several sulfides were selectively oxidised to either the sulfoxide or sulfone by controlling the stoichiometric amount of the oxidant. Indeed, trifluoroperacetic acid has been also used for the oxidation of unreactive alkenes, selenoethers and Baeyer-Villiger oxidation of ketones.^[29]

Based on the literature, we postulate that the oxidizing species involved in the oxidation reaction of sulfides in the packed-bed reactor is trifluoroperacetic acid produced *via* reaction of oxone with trifluoroacetic acid (Scheme 5.11). It is noteworthy that the oxidation of sulfides does not proceed in the absence of TFA. Trifluoroacetic acid is stronger oxidant than peroxymonosulfuric acid (oxidising agent in oxone) due to the presence of an electron-withdrawing trifluoromethyl group.

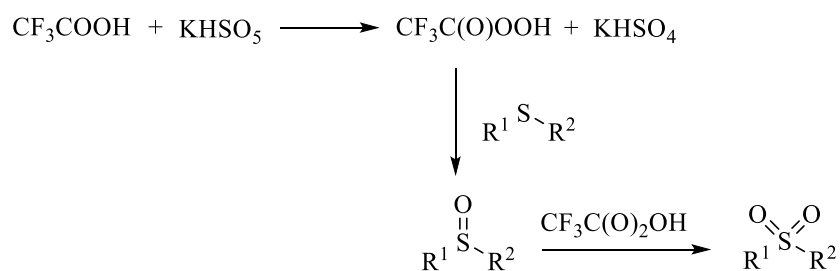

Scheme 5.11. Proposed mechanism for the oxidation of sulfides to sulfoxides and sulfones

5.6. Conclusions

In conclusion, a rapid, versatile and selective oxidation system has been developed for a variety of sulfides and disulfides. The use of oxone has the advantages of being readily available, inexpensive and non-toxic. The packed-bed reactor with oxone could be washed with dichloromethane and reused. The method showed high functional group tolerance. Compounds bearing both sulfur and selenium atoms were selectively oxidized to the sulfoxides with no formation of other products. The oxidation reaction with disulfides proved to be more difficult and sensitive to overoxidation. However, the corresponding thiosulfates were prepared in moderate yields. The synthesis of allicin was possible using the packed-bed reactor. However, further optimisation studies are necessary for a more efficient and sustainable scale-up of the synthesis.

5.7. References

- [1] L. Lafton, *Patent US4927855*, **1990**.
- [2] P. Lindberg, L. Weidolf, *Patent US5877192*, **1998**.
- [3] B. M. Trost, M. Rao, *Angew. Chemie Int. Ed.* **2015**, *54*, 5026–5043.
- [4] J. A. Ellman, T. D. Owens, T. P. Tang, *Acc. Chem. Res.* **2002**, *35*, 984–995.
- [5] M. El-Aasr, Y. Fujiwara, M. Takeya, T. Ikeda, S. Tsukamoto, M. Ono, D. Nakano, M. Okawa, J. Kinjo, H. Yoshimitsu, et al., *J. Nat. Prod.* **2010**, *73*, 1306–1308.
- [6] K. Suwanborirux, K. Charupant, S. Amnuoyopol, S. Pummangura, A. Kubo, N. Saito, *J. Nat. Prod.* **2002**, *65*, 935–937.
- [7] K. Kamata, T. Hirano, N. Mizuno, *Chem. Commun.* **2009**, *26*, 3958–3960.
- [8] R. J. Griffin, A. Henderson, N. J. Curtin, A. Echaliier, J. A. Endicott, I. R. Hardcastle, D. R. Newell, M. E. M. Noble, L. Z. Wang, B. T. Golding, *J. Am. Chem. Soc.* **2006**, *128*, 6012–6013.
- [9] R. S. Varma, K. P. Naicker, *Org. Lett.* **1999**, *1*, 189–192.
- [10] N. Fukuda, T. Ikemoto, *J. Org. Chem.* **2010**, *75*, 4629–4631.
- [11] V. Mirkhani, S. Tangestaninejad, M. Moghadam, I. Mohammadpoor-Baltork, H. Kargar, *J. Mol. Catal. A Chem.* **2005**, *242*, 251–255.
- [12] N. Komatsu, M. Hashizume, T. Sugita, S. Uemura, *J. Org. Chem.* **1993**, *58*, 4529–4533.
- [13] S. Colonna, N. Gaggero, *Tetrahedron Lett.* **1989**, *30*, 6233–6236.
- [14] B. Yu, A.-H. Liu, L.-N. He, B. Li, Z.-F. Diao, Y.-N. Li, *Green Chem.* **2012**, *14*, 957–962.
- [15] T. Noguchi, Y. Hirai, M. Kiriwara, *Chem. Commun.* **2008**, 3040–3042.
- [16] R. Maggi, S. Chitsaz, S. Loebbecke, C. G. Piscopo, G. Sartori, M. Schwarzer, *Green Chem.* **2011**, *13*, 1121–1123.
- [17] A. Baker, Flow Reactors for the Continuous Synthesis of Garlic Metabolites, PhD thesis, Cardiff University, **2015**.
- [18] L. D. Small, J. H. Bailey, C. J. Cavallito, *J. Am. Chem. Soc.* **1947**, *69*, 1710–1713.
- [19] E. Block, S. Ahmad, J. L. Catalfamo, M. K. Jain, R. Apitz-Castro, *J. Am. Chem. Soc.* **1986**, *108*, 7045–7055.
- [20] F. Freeman, Y. Kodera, *J. Agric. Food Chem.* **1995**, 2332–2338.

- [21] V. Vaidya, K. U. Ingold, D. Pratt, *Angew. Chem. Int. Ed.* **2009**, *48*, 157–60.
- [22] D. Williams, R. Saunders, G. Evans, *Patent EP2403827 B1*, **2010**, Vol.EP2403827 B1.
- [23] T. Bjarnsholt, L. D. Christensen, M. Van Gennip, M. Givskov, N. Hoiby, T. H. Jakobsen, P. Ø. Jensen, T. O. Larsen, R. Phipps, M. S. Shanmugham, et al., *Patent PCT/DK2011/050467*, **2012**.
- [24] J. Biao, Z. Chen, L. Jinhua, C. Siyuan, *Patent CN103058903 B*, **2013**.
- [25] J. H. Chu, Y. J. Chen, M. J. Wu, *Synthesis* **2009**, 2155–2162.
- [26] K. A. Aravinda Kumar, V. Venkateswarlu, R. A. Vishwakarma, S. D. Sawant, *Synthesis* **2015**, *47*, 3161–3168.
- [27] A. A. Zagulyaeva, M. S. Yusubov, V. V. Zhdankin, *J. Org. Chem.* **2010**, *75*, 2119–2122.
- [28] C. G. Venier, T. G. Squires, Y. Y. Chen, B. F. Smith, *J. Org. Chem.* **1982**, *47*, 3773–3774.
- [29] R. Ruiz, C. Jiménez-Sanchidrián, *Tetrahedron* **2011**, *64*, 2011–2026.

CHAPTER 6: Experimental Part

6.1. General considerations

The reactions were performed using standard laboratory equipment. Air sensitive reactions were carried out under argon or nitrogen atmosphere using oven-dried glassware. Reactions were stirred using magnetic stirring and heated to specified temperatures using hotplates with temperature probe control and an adapted heating block.

Lower temperatures were obtained using ice/water (0 °C), dry ice/acetonitrile (-40 °C), dry ice/acetone (-78 °C). Büchi B-461, B-481 or B-490 were used for solvent evaporations (reduced pressure up to 15 mbar) and high vacuum apparatus was used to further dry the products.

All chemicals were purchased from Sigma Aldrich, Alfa Aesar, Fisher Scientific, TCI UK, Fluorochem and used without further purification. Dry diethyl ether, tetrahydrofuran, toluene and acetonitrile were obtained from an MBRAUN SPS-800 solvent purification system. Dry dichloromethane was distilled over calcium hydride under nitrogen atmosphere.

For flow chemistry, Vapourtec© E series pumps, KR Analytical Ltd Fusion 100 Touch syringe pumps were used.

6.2. Chromatographic Methods

6.2.1. Thin-layer chromatography

All the reactions were monitored by thin-layer chromatography (TLC) which was performed on Merck Silica gel 60 F254 (0.20 m) and visualised by UV radiation (254 nm) or/and by staining with potassium permanganate solution (1.5 g KMnO_4 , 10 g K_2CO_3 , 1.25 mL 10% NaOH, 200 mL distilled H_2O).

6.2.2. Column Chromatography

6.2.2.1. Manual column chromatography

Manual column chromatography was performed using silica gel 60 (Merck, 230-400 mesh) under increased pressure (Flash Chromatography) or as gravitational column chromatography. The solvents used for the purification are indicated in the text and were purchased from Fisher Scientific as laboratory grade.

6.2.2.2. Automated chromatography (Biotage)

Automated column chromatography was performed on a Biotage[®] Isolera Four using Biotage[®] cartridges SNAP Ultra 10g, SNAP Ultra 25g, SNAP Ultra 50g, SNAP Ultra 100g. The solvents used for the purification are indicated in the text and were purchased from Fisher Scientific as laboratory grade.

6.3. Physical Data

6.3.1. ^1H NMR Spectroscopy

^1H NMR spectra were measured on Bruker DPX 500 (500 MHz), Bruker DPX 400 (400 MHz), Bruker DPX 300 (300 MHz) instruments. The chemical shifts δ are given in ppm downfield of tetramethylsilane ($\delta = 0$ ppm). Compounds or crude reaction mixtures were dissolved in either deuterated chloroform, deuterated methanol or deuterated acetonitrile. Coupling constants (J) are given in Hertz. The multiplicity of signals is designated: s = singlet, d = doublet, t = triplet, q = quartet, quin = quintet, dt = doublet of triplet, m = multiplet. Residual solvent peaks are 7.26 ppm for chloroform, 3.31 ppm for methanol and 1.94 ppm for acetonitrile.

6.3.2. ^{13}C NMR Spectroscopy

^1H NMR spectra were measured on Bruker DPX 500 (500 MHz), Bruker DPX 400 (400 MHz), Bruker DPX 300 (300 MHz) instruments. The chemical shifts δ are given in ppm downfield of tetramethylsilane ($\delta = 0$ ppm). Compounds or crude reaction mixtures were dissolved in either deuterated chloroform, deuterated methanol or deuterated acetonitrile. Residual solvent peaks are 77.16 ppm for chloroform, 49.00 ppm for methanol.

6.3.3. Mass Spectroscopy

Mass spectrometric measurements were performed by EPSRC Mass Spectrometry Service Centre, Swansea University. Ions were generated by atmospheric pressure chemical ionization (APCI), Electrospray (ES) or Electron Ionisation (EI). Mass fragments usually are in atomic mass units per elementary charges (m/z) with relative abundance of ion percentage (%). The molecular ion peaks values quoted for molecular ion (M^+), molecular ion plus hydrogen ($\text{M}+\text{H}^+$), molecular ion plus sodium ($\text{M}+\text{Na}^+$).

6.3.4. IR Spectroscopy

IR spectra were recorded on Shimadzu IR Affinity-1S apparatus. Wavenumbers are quoted in cm^{-1} . All compounds were measured neat directly on the crystal of the IR instrument.

6.3.5. Melting points

Melting points were measured using a Gallenkamp variable heater with samples in open capillary tubes.

6.4. Experimental data for Chapter 3: Short (total) synthesis of Ajoene

6.4.1. Synthesis of aryl selenide precursors

(3-Bromopropyl)(phenyl)selane (**107a**):

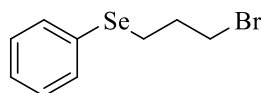

Procedure.^[1] To a stirred solution of diphenyl diselenide (0.312 g, 1 mmol) in ethanol (5 mL), sodium borohydride (0.076 g, 2 mmol) was added portionwise at 0 °C under nitrogen atmosphere. During this process the yellow colour of the reaction mixture fades away. Then 1,3-dibromopropane (0.4 mL, 4 mmol) was added dropwise, and the reaction mixture was stirred for 2 h. After completion, water (10 mL) was added to the reaction and the resulting mixture extracted with diethyl ether (3 x 10 mL). The organic layer was washed with brine (20 mL), dried over Mg₂SO₄, and the solvent evaporated. The crude was purified by chromatography using Biotage Isolera (gradient: 100 % hexane for 10 column volume (CV), then increased to 90:10 hexane: ethyl acetate over 10 CV) to give compound **107a** (0.512 g, 92% yield) as a colourless oil.

¹H NMR (400 MHz, CDCl₃): δ = 2.15 – 2.23 (m, 2H, CH₂), 3.03 (t, J = 6.5 Hz, 2H, CH₂), 3.51 (t, J = 6.5, 2H, CH₂), 7.24 – 7.31 (m, 3H, ArH), 7.48 – 7.54 (m, 2H, ArH) ppm. ¹³C NMR (100 MHz, CDCl₃): δ = 25.9 (CH₂), 32.7 (CH₂), 33.2 (CH₂), 127.3 (C_{Ar}H), 129.3 (C_{Ar}H), 129.5 (C_{Ar}), 133.0 (C_{Ar}H) ppm. Spectra in accordance to literature.^[1]

2-(3-Hydroxypropyl)isothiuronium bromide (**115**):

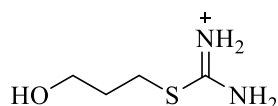

General Procedure. Thiourea (0.198 g, 2.60 mmol) was dissolved in acetonitrile (5 mL) under N₂ atmosphere and 3-bromo-1-propanol (0.18 mL, 2 mmol) was added to the solution which was then refluxed for 2 h. The reaction was cooled in an ice-bath to afford a white solid product that was filtered on a Büchner funnel. The product was washed with ice-cold acetonitrile (20 mL) and dried further on the high vacuum pump to yield the isothiuronium salt **115** (0.344 g, 80% yield) as a colourless solid.

^1H NMR (400 MHz, CH_3OD): $\delta = 1.93$ (t, $J = 6.5$ Hz, 2H, CH_2), 3.26 (t, $J = 6.5$, 2H, CH_2), 3.69 (t, $J = 6.5$, 2H, CH_2), 4.86 - 4.83 (m, 5H, $-\text{NH}_2$ an $-\text{OH}$) ppm; ^{13}C NMR (100 MHz, CH_3OD): $\delta = 28.6$ (CH_2), 32.4 (CH_2), 60.1 (CH_2), 173.3 ($\text{C}(\text{NH}_2)_2$) ppm. HRMS (ESI) $[\text{M}-\text{Br}]^+$ calc. 135.0587, found 135.0583 $[\text{C}_4\text{H}_{11}\text{N}_2\text{OS}]^+$. IR (neat): 3184, 3063, 1651, 1634, 1040, 1016, 914, 474 cm^{-1} . m.p. = 89 – 91 $^\circ\text{C}$.

2-(3-(Phenylselanyl)propyl)isothiuronium bromide (112):

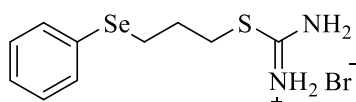

Synthesized according to the general procedure using **107a** (0.512 g, 3.7 mmol). The isothiuronium salt **112** (1.06 g, 81% yield) as a colourless solid.

^1H NMR (400 MHz, CH_3OD): $\delta = 2.01$ (qt, $J = 7.2$ Hz, 2H, CH_2), 3.01 (t, $J = 7.2$ Hz, 2H, CH_2), 3.23 (t, $J = 7.2$, 2H, CH_2), 7.24 – 7.29 (m, 3H, ArH), 7.49 – 7.52 (m, 2H, ArH) ppm. ^{13}C NMR (100 MHz, CH_3OD): $\delta = 26.1$ (CH_2), 30.2 (CH_2), 31.5 (CH_2), 128.3 (C_{ArH}), 130.3 (C_{ArH}), 130.5 (C_{Ar}), 140.0 (C_{Ar}), 172.6 ($\text{C}(\text{NH}_2)_2$) ppm. HRMS (NSI): $[\text{M}-\text{Br}]^+$ calc. 275.0116, found 275.0112 $[\text{C}_{10}\text{H}_{15}\text{N}_2\text{SSe}]^+$. IR(neat): 3057, 1647, 1435, 1070, 737, 688, 460 cm^{-1} . m.p. = 126 - 128 $^\circ\text{C}$.

3-(Prop-2-yn-1-ylthio)propan-1-ol (116):

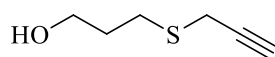

Procedure. To a stirring solution of KOH (0.324 g, 5.60 mmol) in degassed CH_3OH (5.6 mL) at 0 $^\circ\text{C}$, the isothiuronium salt **88** (0.303 g, 2.24 mmol) was added. After 30 min, propargyl bromide (80% in toluene, 0.35 mL, 3.36 mmol) was added dropwise and the mixture left to warm up gradually to room temperature. The methanol was removed under vacuum, H_2O (5 mL) was added and the residue extracted with CH_2Cl_2 (2 x 10 mL). Following drying and removal of solvent, the residue was purified by column chromatography using Biotage Isolera (gradient: 100 % hexane for 3 column volume (CV), then increased to 90:10 hexane: ethyl acetate over 5 CV and held over 3 CV), giving the propargylic alcohol **89** (0.157 g, 56% yield) as a colourless oil.

^1H NMR (400 MHz, CDCl_3): δ = 1.65 (bs, 1H, OH), 1.78 – 2.03 (m, 2H, CH_2), 2.24 (t, J = 2.6 Hz, 1H, $\text{CH}_2\text{C}\equiv\text{CH}$), 2.68 – 2.91 (m, 2H, CH_2), 3.18-3-3.33 (m, 2H, $\text{CH}_2\text{C}\equiv\text{CH}$), 3.77 (td, J = 6.1, 1.4 Hz, 2H, CH_2) ppm. ^{13}C NMR (100 MHz, CDCl_3): δ = 19.3 ($\text{CH}_2\text{C}\equiv\text{CH}$), 28.4 (CH_2), 31.5 (CH_2), 71.2 ($\text{CH}_2\text{C}\equiv\text{CH}$); 80.0 ($\text{CH}_2\text{C}\equiv\text{CH}$) ppm. HRMS (NSD): $[\text{M}+\text{H}]^+$ calc. 131.1, found 131.0 [$\text{C}_6\text{H}_{11}\text{OS}$] $^+$. IR (neat): 3298, 1265, 1045, 733 cm^{-1} .

(3-(Phenylselanyl)propyl)(prop-2-yn-1-yl)sulfane (108a):

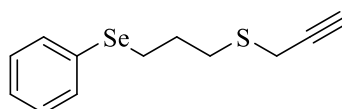

Synthesized according to the general procedure using isothiuronium salt **112** (0.885 g, 2.5 mmol); **108a** (0.838 g, 84% yield) was obtained as a colourless solid.

^1H NMR (400 MHz, CDCl_3): δ = 2.00 (qt, J = 7.1 Hz, 2H, CH_2), 2.22 (t, J = 2.6 Hz, 1H, $\text{CH}_2\text{C}\equiv\text{CH}$), 2.80 (t, J = 7.2, 2H, CH_2), 3.01 (t, J = 7.2 Hz, 2H, CH_2), 3.21 (d, J = 2.6, 2H, $\text{CH}_2\text{C}\equiv\text{CH}$), 7.23 – 7.29 (m, 3H, ArH), 7.49 – 7.51 (m, 2H, ArH) ppm; ^{13}C NMR (100 MHz, CDCl_3): δ = 19.3 ($\text{CH}_2\text{C}\equiv\text{CH}$), 26.5 (CH_2), 29.2 (CH_2), 31.4 (CH_2), 71.2 ($\text{CH}_2\text{C}\equiv\text{CH}$), 80.0 ($\text{CH}_2\text{C}\equiv\text{CH}$), 127.1 (C_{ArH}), 129.2 (C_{ArH}), 130.0 (C_{ArSe}), 132.9 (C_{ArH}) ppm. HRMS (ASAP): $[\text{M}+\text{H}]^+$ calc. 271.0053, found 271.0059 [$\text{C}_{12}\text{H}_{15}\text{SSe}$] $^+$. IR (neat): 3047, 1265, 736 cm^{-1} .

(3-((2-nitrophenyl)selanyl)propyl)(prop-2-yn-1-yl)sulfane (108b):

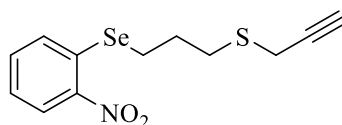

Procedure. Alcohol **116** (0.195 g, 1.5 mmol) and 2-nitrophenylselenium cyanate (0.340 g, 1.5 mmol) were dissolved in THF (5 mL) under argon atmosphere at room temperature. Tributylphosphine (0.38 mL, 1.5 mmol) was added and the reaction mixture was left stirring for 2h. After completion, the reaction was quenched with NH_4Cl solution (10 mL) and extracted with ethyl acetate (3 x 20 mL). The combined organic phases were dried over Mg_2SO_4 , filtered and concentrated. The crude product was purified by column chromatography using Biotage Isolera (gradient: 100% hexane for 3 column volume

(CV), then increased to 90:20 hexane: ethyl acetate over 15 CV and held over 3 CV) to give compound **108b** (306 mg, 65% yield) as a yellow oil.

^1H NMR (400 MHz, CDCl_3): δ = 2.08 (qt, J = 7.0 Hz, 2H, CH_2), 2.24 (t, J = 2.6 Hz, 1H, $\text{CH}_2\text{C}\equiv\text{CH}$), 2.85 (t, J = 7.0, 2H, CH_2), 3.03 (t, J = 7.0 Hz, 2H, CH_2), 3.25 (d, J = 2.6, 2H, $\text{CH}_2\text{C}\equiv\text{CH}$), 7.31 (ddd, J = 8.4, 6.0, 2.4 Hz, 1H, ArH), 7.48 – 7.59 (m, 2H, ArH), 8.24 – 8.29 (m, 1H, ArH) ppm. ^{13}C NMR (100 MHz, CDCl_3): δ = 19.3 ($\text{CH}_2\text{C}\equiv\text{CH}$), 24.6 (CH_2), 27.5 (CH_2), 31.7 (CH_2), 71.4 ($\text{CH}_2\text{C}\equiv\text{CH}$), 79.7 ($\text{CH}_2\text{C}\equiv\text{CH}$), 125.5 (C_{ArH}), 126.5 (C_{ArH}), 129.0 (C_{ArH}), 133.1 (C_{ArSe}), 133.7 (C_{ArH}), 146.9 (C_{ArNO_2}) ppm. HRMS (ASAP): $[\text{M}+\text{NH}_4]^+$ calc. 333.0176, found 333.0172 $[\text{C}_{12}\text{H}_{17}\text{N}_2\text{O}_2\text{SSe}]^+$. IR (neat): 3298, 2939, 2862, 1512, 1330, 908, 729 cm^{-1} .

6.4.2. Radical addition of thioacetic acid to the alkyne

6.4.2.1. Batch

General procedure 1 (GPI). The propargylic sulfide (0.96 mmol) was dissolved in degassed toluene (2 mL) and the solution heated to 85 °C under N_2 . AIBN (10 mol%) or ACCN (10 mol%) was added to the solution directly, followed by the dropwise addition of thioacetic acid (1.06 mmol) in toluene (1 mL) over 40 minutes using a syringe pump. The mixture was left stirring for 1 h. The reaction was then quenched with aqueous saturated solution of sodium carbonate (3 mL) and the toluene removed under vacuum. The remaining residue was extracted with CH_2Cl_2 (2 x 10 mL) and the combined extracts were washed with brine (2 x 10 mL) and dried over MgSO_4 . The solvent was removed under vacuum and the resulting residue purified by column chromatography using Biotage Isolera (gradient: 100% hexane for 3 column volume (CV), then increased to 80:20 hexane: diethyl ether over 15 CV, then hexane: diethyl ether over 3 CV) to afford the expected product, respectively.

General procedure 2 (GP2).^[2] Thioacetic acid (33 μ L, 0.46 mmol) was added to a refluxing mixture of propargylic sulfide (0.100 g, 0.37 mmol), acetic acid (3 mL) and manganese (III) acetate dihydrate (0.025 g, 25 mol%). The dark-brown colour of Mn(III) disappeared within a few seconds. The solvent was removed *in vacuum*, the residue washed with water and extracted with CH_2Cl_2 . The combined extracts were washed dried over MgSO_4 and the solvent was removed under vacuum. The resulting residue was purified by column chromatography using Biotage Isolera (gradient: 100% hexane for 3 column volume (CV), then increased to 80:20 hexane: diethyl ether over 15 CV, then hexane: diethyl ether over 3 CV) to afford the expected product.

(*E/Z*)-3-((3-(phenylselanyl)propyl)thio)prop-1-en-1-yl) ethanethioate (109a):

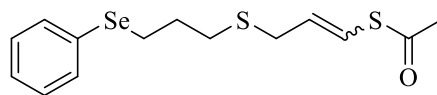

Synthesized according to the GP1 using propargylic sulfide **108a** (0.260 g, 0.96 mmol). **109a** (AIBN: 0.235 g, 71% yield; ACCN: 0.211 g, 64%, *d.r.* *E/Z* = 0.50:1) was obtained as a pale-yellow oil.

Synthesized according to the GP2. **109a** (0.045 g, 35%, *d.r.* *E/Z* = 1:2) was obtained as a pale-yellow oil.

E-isomer: ^1H NMR (400 MHz, CDCl_3): δ = 1.93 (quin, J = 8.0 Hz, 2H, CH_2), 2.36 (s, 3H, CH_3), 2.53 (t, J = 7.1, 2H, CH_2), 2.95 (td, J = 7.3, 3.6, 2H, CH_2), 3.14 (t, J = 8.3 Hz, 2H, $\text{CH}_2\text{CH}=\text{CH}$), 5.72 – 5.85 (m, 1H, $\text{CH}_2\text{CH}=\text{CH}$), 6.49 (d, J = 15.6 Hz, $\text{CH}_2\text{CH}=\text{CH}$, 1H), 7.24-7.26 (m, 3H, *ArH*), 7.48-7.50 (m, 2H, *ArH*) ppm. ^{13}C NMR (100 MHz, CDCl_3): δ = 26.6 (CH_2), 29.5 (CH_2), 30.5 (CH_2), 30.7 (CH_3), 34.1 (CH_2), 119.3 ($\text{CH}_2\text{CH}=\text{CH}$), 127.0 (C_{ArH}), 129.1 (2C_{ArH}), 130.1 (C_{ArSe}), 130.2 ($\text{CH}_2\text{CH}=\text{CH}$), 132.8 (2C_{ArH}), 192.9 ($\text{C}=\text{O}$) ppm. HRMS (ASAP): $[\text{M}+\text{Na}]^+$ calc. 347.0042, found 347.0042 [$\text{C}_{14}\text{H}_{19}\text{OS}_2\text{Se}$] $^+$. IR (neat): 1699, 1126, 736, 626 cm^{-1} .

Z-isomer: ^1H NMR (400 MHz, CDCl_3): δ = 1.93 (quin, J = 8.0 Hz, 2H, CH_2), 2.36 (s, 3H, CH_3), 2.53 (t, J = 7.1, 2H, CH_2), 2.95 (td, J = 7.3, 3.6, 2H, CH_2), 3.14 (t, J = 8.3 Hz, 2H, $\text{CH}_2\text{CH}=\text{CH}$), 5.72 – 5.85 (m, 1H, $\text{CH}_2\text{CH}=\text{CH}$), 6.65 (d, J = 9.6 Hz, 1H, $\text{CH}_2\text{CH}=\text{CH}$), 7.24-7.26 (m, 3H, *ArH*), 7.48-7.50 (m, 2H, *ArH*) ppm. ^{13}C NMR (100

MHz, CDCl₃): δ 26.5 (CH₂), 29.8 (CH₂), 30.9 (CH₂), 31.0 (CH₃), 119.6 (CH₂CH=CH), 127.0 (C_{Ar}H), 128.6 (CH₂CH=CH), 129.1 (2C_{Ar}H), 130.1 (C_{Ar}Se), 132.8 (2C_{Ar}H), 191.3 (C=O) ppm. IR (neat): 1699, 1126, 736, 626 cm⁻¹. HRMS (ASAP): [M+Na]⁺ calc. 347,0042, found 347.0042 [C₁₄H₁₉OS₂Se]⁺.

(*E/Z*)-3-((3-((2-nitrophenyl)selenyl)propyl)thio)prop-1-en-1-yl) ethanethioate
(109b):

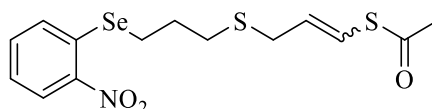

Synthesized according to the GP1 using propargylic sulfide **108b** (0.300 g, 0.96 mmol). **109b** (AIBN: 0.112 g, 30% yield; ACCN: 0.187 g, 50% yield, *d.r.* *E/Z* = 0.47:1) was obtained as a pale-yellow oil.

E-isomer: ¹H NMR (400 MHz, CDCl₃): δ = 1.97-2.08 (m, 2H, CH₂), 2.35 (s, 3H, CH₃), 2.59-2.65 (m, 2H, CH₂), 3.02 (t, *J* = 8.0 Hz, 2H, CH₂), 3.22 (dd, *J* = 7.5, 1.2 Hz, 2H, CH₂CH=CH), 5.77-5.87 (m, 1H, CH₂CH=CH), 6.53 (dt, *J* = 15.6, 1.2 Hz, 1H, CH₂CH=CH), 7.29 – 7.34 (m, 1H, ArH), 7.52 – 7.54 (m, 2H, ArH), 8.27 – 8.29 (m, 1H, ArH) ppm. ¹³C NMR (100 MHz, CDCl₃) δ = 24.7 (CH₂), 28.0 (CH₂), 30.6 (CH₃), 30.9 (CH₂), 34.2 (CH₂CH=CH), 119.7 (CH₂CH=CH), 125.6 (C_{Ar}H), 126.7 (C_{Ar}H), 129.1 (C_{Ar}H), 129.9 (CH₂CH=CH), 133.4 (C_{Ar}Se), 133.8 (C_{Ar}H), 147.0 (C_{Ar}NO₂), 193.0 (C=O) ppm. HRMS (ESI): [M+Na]⁺ calc. 413. 9712, found 413.9703 [C₁₄H₁₇NO₃S₂SeNa]⁺. IR (neat): 1699, 1514, 1330, 1303, 904, 727 cm⁻¹.

Z-isomer: ¹H NMR (400 MHz, CDCl₃): δ = 1.97 – 2.08 (m, 2H, CH₂), 2.38 (s, 3H, CH₃), 2.59 – 2.65 (m, 2H, CH₂), 3.00 (t, *J* = 8.0 Hz, 2H, CH₂), 3.19 (dd, *J* = 7.7, 1.0 Hz, 2H, CH₂CH=CH), 5.77 – 5.87 (m, 1H, CH₂CH=CH), 6.67 (dt, *J* = 9.6, 0.9 Hz, 1H, CH₂CH=CH), 7.29 – 7.34 (m, 1H, ArH), 7.52 – 7.54 (m, 2H, ArH), 8.27 – 8.29 (m, 1H, ArH) ppm. ¹³C NMR (100 MHz, CDCl₃): δ = 24.8 (CH₂), 28.2 (CH₂), 31.0 (CH₂), 31.1 (CH₃), 31.2 (CH₂CH=CH), 119.9 (CH₂CH=CH), 125.6 (C_{Ar}H), 126.7 (C_{Ar}H), 128.4 (CH₂CH=CH), 129.1 (C_{Ar}H), 133.4 (C_{Ar}Se), 133.8 (C_{Ar}H), 147.0 (C_{Ar}NO₂), 191.3 (C=O) ppm. HRMS (ESI): [M+Na]⁺ calc. 413. 9712, found 413.9703 [C₁₄H₁₇NO₃S₂SeNa]⁺. IR (neat): 1699, 1514, 1330, 1303, 904, 727 cm⁻¹.

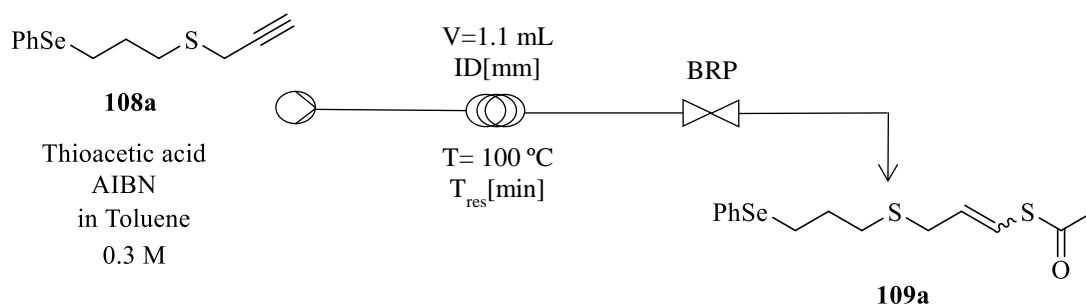
6.4.2.2. Flow chemistry

Compound **108a** (0.260 g, 0.96 mmol), thioacetic acid (76 μ L, 1.06 mmol) and AIBN (0.048 g, 0.048 mmol) were dissolved in degassed toluene (3 mL). The solution was pumped through the reactor (1.1 mL, with variable inner diameters) at different flow rate, placed at 100 °C, using a syringe pump. After reaching the steady state, the solution was collected. The outlet was quenched with aqueous saturated NaHCO_3 (5 mL), the toluene evaporated *in vacuo* and the residue extracted with diethyl ether (3 x 5 mL). The combined extracts were washed with brine, and dried over MgSO_4 and the solvent evaporated *in vacuo*. The product was purified by column chromatography using Biotage Isolera (gradient: 100% hexane for 3 column volume (CV), then increased to 80:20 hexane: diethyl ether over 15 CV, then hexane: diethyl ether over 3 CV) to afford compound **109a** as a pale-yellow oil. Experimental conditions and results are shown in Section 3.5.2.2.

6.4.3. S-Sulfenylation

(E/Z)-1-allyl-2-(3-((3-((2-nitrophenyl)selenyl)propyl)thio)prop-1-en-1-yl)disulfane (110b):

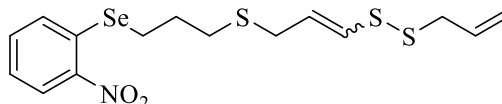

General Procedure. The vinyl thioacetate **109b** (0.190 g, 0.46 mmol) was dissolved in degassed CH₃OH (0.5 mL) and the solution was cooled to -40 °C and stirred under N₂. KOH (26.9 mg, 0.48 mmol) in degassed methanol (0.5 mL) was added slowly and the reaction left stirring for 45 minutes, after which it was cooled down to -78 °C. S-allyl 4-methylbenzenesulfonothioate (0.116 g, 0.51 mmol) dissolved in CH₂Cl₂ (0.5 mL) was added and the reaction allowed to stir for an hour at -78 °C before being allowed to warm up. The reaction was quenched with saturated ammonium chloride (5 mL), the solvents were removed under vacuum on the rotary evaporator, and the resulting residue extracted with CH₂Cl₂ (3 x 10 mL). The combined extracts were washed with brine (2 x 10 mL) and dried over MgSO₄. The solvent was removed under vacuum and the resulting residue purified by column chromatography using Biotage Isolera (gradient: 100% hexane for 3 column volume (CV), then increased to 90:10 hexane: diethyl ether over 20 CV, then 90:10 hexane: diethyl ether over 3 CV) to give compound **110b** (0.141 g, 73% yield, *d.r.* *E/Z* = 0.50:1) as a yellow oil.

E-isomer: ¹H NMR (400 MHz, CDCl₃): δ = 1.99 – 2.12 (m, 2H, CH₂), 2.60 – 2.66 (m, 2H, CH₂), 3.03 (t, *J* = 7.5 Hz, 2H, CH₂), 3.21 (d, *J* = 7.8 Hz, 2H, CH₂CH=CH), 3.34 (d, *J* = 7.5 Hz, 2H, CH₂CH=CH₂), 5.12 – 5.23 (m, 2H, CH₂CH=CH₂), 5.78 – 5.89 (m, 2H, CH₂CH=CH₂ and CH₂CH=CH), 6.11 (d, *J* = 14.7 Hz, 1H, CH₂CH=CH), 7.30 – 7.35 (m, 1H, ArH), 7.51 – 7.56 (m, 2H, ArH), 8.29 (dd, *J* = 8.5, 1.5 Hz, 1H, ArH) ppm. ¹³C NMR (100 MHz, CDCl₃): δ = 24.6 (CH₂), 27.9 (CH₂), 30.9 (CH₂), 33.6 (CH₂CH=CH), 41.3 (CH₂CH=CH₂), 119.0 (CH₂CH=CH₂), 125.5 (C_{Ar}H), 126.6 (C_{Ar}H), 127.6 (CH₂CH=CH), 128.2 (CH₂CH=CH), 129.0 (C_{Ar}H), 132.7 (CH₂CH=CH₂), 133.1 (C_{Ar}Se), 133.6 (C_{Ar}H), 147.0 (C_{Ar}NO₂) ppm. HRMS (ASAP): [M+H]⁺ calc. 421.9820, found 421.9823 [C₁₅H₂₀NO₂S₃Se]⁺. IR (neat): 1589, 1566, 1514, 1330, 1303, 731 cm⁻¹.

Z-isomer: ^1H NMR (400 MHz, CDCl_3): $\delta = 1.99 - 2.12$ (m, 2H, CH_2), 2.60 – 2.66 (m, 2H, CH_2), 3.03 (t, $J = 7.5$ Hz, 2H, CH_2), 3.26 (d, $J = 7.8$ Hz, 2H, $\text{CH}_2\text{CH}=\text{CH}$), 3.36 (d, $J = 7.5$ Hz, 2H, $\text{CH}_2\text{CH}=\text{CH}_2$), 5.12 – 5.23 (m, 2H, $\text{CH}_2\text{CH}=\text{CH}_2$), 5.62 – 5.72 (m, 1H, $\text{CH}_2\text{CH}=\text{CH}$), 5.78 – 5.89 (m, 1H, $\text{CH}_2\text{CH}=\text{CH}_2$), 6.25 (d, $J = 9.3$, 1H, $\text{CH}_2\text{CH}=\text{CH}$), 7.30 – 7.35 (m, 1H, *ArH*), 7.51 – 7.56 (m, 2H, *ArH*), 8.29 (dd, $J = 8.5, 1.5$ Hz, 1H, *ArH*) ppm. ^{13}C NMR (100 MHz, CDCl_3): $\delta = 24.7$ (CH_2), 28.3 (CH_2), 29.4 ($\text{CH}_2\text{CH}=\text{CH}$), 31.2 (CH_2), 45.1 ($\text{CH}_2\text{CH}=\text{CH}_2$), 119.7 ($\text{CH}_2\text{CH}=\text{CH}_2$), 125.4 ($\text{C}_{\text{Ar}}\text{H}$), 126.5 ($\text{C}_{\text{Ar}}\text{H}$), 127.9 ($\text{CH}_2\text{CH}=\text{CH}$), 129.0 ($\text{C}_{\text{Ar}}\text{H}$), 132.4 ($\text{CH}_2\text{CH}=\text{CH}$), 132.8 ($\text{CH}_2\text{CH}=\text{CH}_2$), 133.2 ($\text{C}_{\text{Ar}}\text{Se}$), 133.6 ($\text{C}_{\text{Ar}}\text{H}$), 147.0 ($\text{C}_{\text{Ar}}\text{NO}_2$) ppm. HRMS (ASAP): $[\text{M}+\text{H}]^+$ calc. 421.9820, found 421.9823 $[\text{C}_{15}\text{H}_{20}\text{NO}_2\text{S}_3\text{Se}]^+$. IR (neat): 1589, 1566, 1514, 1330, 1303, 731 cm^{-1} .

(*E/Z*)-1-Allyl-2-(3-((3-(phenylselanyl)propyl)thio)prop-1-en-1-yl)disulfane (110a):

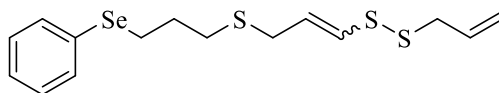

Synthesized according to the general procedure using **109a** (0.160 g, 0.46 mmol). **110a** (0.150 g, 87% yield, *d.r.* *E/Z* = 0.64:1) was obtained as a pale-yellow oil.

E-isomer: ^1H NMR (400 MHz, CDCl_3): $\delta = 1.91 - 2.03$ (m, 2H, CH_2), 2.56 – 2.63 (m, 2H, CH_2), 3.00 (t, $J = 7.3$ Hz, 2H, CH_2), 3.16 (d, $J = 7.4$ Hz, 2H, $\text{CH}_2\text{CH}=\text{CH}$), 3.35 (d, $J = 7.1$ Hz, 2H, $\text{CH}_2\text{CH}=\text{CH}_2$), 5.13 – 5.23 (m, 2H, $\text{CH}_2\text{CH}=\text{CH}_2$), 5.80 – 5.90 (m, 2H, $\text{CH}_2\text{CH}=\text{CH}_2$ and $\text{CH}_2\text{CH}=\text{CH}$), 6.08 (d, $J = 14.7$, 1H, $\text{CH}_2\text{CH}=\text{CH}$), 7.25 – 7.31 (m, 3H, *ArH*), 7.50 – 7.52 (m, 2H, *ArH*) ppm. ^{13}C NMR (100 MHz, CDCl_3): $\delta = 26.5$ (CH_2), 29.6 (CH_2), 30.7 (CH_2), 33.5 (CH_2), 41.4 (CH_2), 119.1 ($\text{CH}_2\text{CH}=\text{CH}_2$), 127.1 ($\text{C}_{\text{Ar}}\text{H}$), 127.9 ($\text{CH}_2\text{CH}=\text{CH}$), 128.0 ($\text{CH}_2\text{CH}=\text{CH}$), 129.2 ($2\text{C}_{\text{Ar}}\text{H}$), 130.0 ($\text{C}_{\text{Ar}}\text{Se}$), 132.8 ($2\text{C}_{\text{Ar}}\text{H}$), 132.9 ($\text{CH}_2\text{CH}=\text{CH}_2$) ppm. HRMS (ASAP): $[\text{M}+\text{H}]^+$ calc. 376.9969, found 376.9969 $[\text{C}_{15}\text{H}_{21}\text{S}_3\text{Se}]^+$. IR (neat): 1577, 1477, 1072, 1022, 910, 732, 690 cm^{-1} .

Z-isomer: ^1H NMR (400 MHz, CDCl_3): $\delta = 1.91 - 2.03$ (m, 2H, CH_2), 2.56 – 2.63 (m, 2H, CH_2), 3.00 (t, $J = 7.3$ Hz, 2H, CH_2), 3.25 (d, $J = 7.8$ Hz, 2H, $\text{CH}_2\text{CH}=\text{CH}$), 3.33 (d, $J = 7.1$ Hz, 2H, $\text{CH}_2\text{CH}=\text{CH}_2$), 5.13 – 5.23 (m, 2H, $\text{CH}_2\text{CH}=\text{CH}_2$), 5.60 – 5.71 (m, 1H, $\text{CH}_2\text{CH}=\text{CH}$), 5.80 – 5.90 (m, 1H, $\text{CH}_2\text{CH}=\text{CH}_2$), 6.23 (d, $J = 9.3$, 1H, $\text{CH}_2\text{CH}=\text{CH}$), 7.25 – 7.31 (m, 3H, *ArH*), 7.50 – 7.52 (m, 2H, *ArH*) ppm. ^{13}C NMR (100 MHz, CDCl_3):

δ = 26.6 (CH₂), 29.3 (CH₂CH=CH), 29.9 (CH₂), 31.1 (CH₂), 42.2 (CH₂CH=CH₂), 119.2 (CH₂CH=CH₂), 127.0 (C_{Ar}H), 128.3 (CH₂CH=CH), 129.3 (2C_{Ar}H), 130.1 (C_{Ar}Se), 132.3 (CH₂CH=CH), 132.8 (2C_{Ar}H), 132.9 (CH₂CH=CH₂) ppm. HRMS (ASAP): [M+H]⁺ calc. 376.9969, found 376.9969 [C₁₅H₂₁S₃Se]⁺. IR (neat): 1577, 1477, 1072, 1022, 910, 732, 690 cm⁻¹.

6.4.4. Oxidation of the sulfide and selenide/selenoxide elimination

(*E/Z*)-1-allyl-2-(3-(allylsulfinyl)prop-1-en-1-yl)disulfane “Ajoene” (**21**):

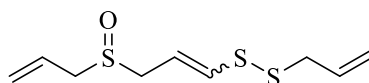

General procedure: The vinyl disulfide **110a** (0.140 g, 0.33 mmol) dissolved in THF (3 mL) was cooled to 0 °C under N₂, and H₂O₂ (30% w/w in H₂O, 0.075 mL, 0.66 mmol) added dropwise. The reaction was allowed to proceed for 1 h at 0 °C and then warmed to rt (2h). Saturated NaHCO₃ aqueous solution (5 mL) was added and the residue was extracted with EtOAc (2×10 mL). The combined fractions were washed with brine (2×10 mL) and dried over Mg₂SO₄. The solvent was removed under vacuum and the resulting residue purified by column chromatography using Biotage Isolera (gradient 100% hexane for 2 column volume (CV), then increased to 20:80 hexane: diethyl ether over 10 CV, held over 5 CV, increased to 0:100 over 5 CV and held over 10 CV diethyl ether) to afford ajoene **21** (21 mg, 27%, d.r. *E/Z* = 0.56:1) as a pale yellow oil.

Following the general procedure, compound **110b** (0.120 g, 0.33 mmol) was also used to synthesise ajoene **21** (17.7 mg, 23%, d.r. *E/Z* = 0.60:1).

E-isomer: ¹H NMR (400 MHz, CDCl₃): δ = 3.29 (d, *J* = 7.6 Hz, 2H, CH₂CH=CH₂), 3.26 – 3.54 (m, 4H, CH₂CH=CH₂, CH₂CH=CH), 5.11 – 5.19 (m, 2H, CH₂CH=CH₂), 5.27 – 5.44 (m, 2H, CH₂CH=CH₂), 5.69 – 5.93 (m, 3H, CH₂CH=CH₂, CH₂CH=CH and CH₂CH=CH₂), 6.31 (d, *J* = 14.8 Hz, 1H, CH₂CH=CH) ppm. ¹³C NMR (100 MHz, CDCl₃): δ = 41.3 (CH₂), 52.9 (CH₂), 54.4 (CH₂), 116.8 (CH₂CH=CH), 119.3 (CH₂CH=CH₂), 123.7 (CH₂CH=CH₂), 125.6 (CH₂CH=CH₂), 132.4 (CH₂CH=CH₂), 134.7 (CH₂CH=CH) ppm. Spectra in accordance with the literature.^[3]

Z-isomer: ^1H NMR (400 MHz, CDCl_3): δ = 3.37 (d, J = 7.3 Hz, 2H, $\text{CH}_2\text{CH}=\text{CH}_2$), 3.39 – 3.67 (m, 4H, $\text{CH}_2\text{CH}=\text{CH}_2$, $\text{CH}_2\text{CH}=\text{CH}$), 5.11 – 5.24 (m, 2H, $\text{CH}_2\text{CH}=\text{CH}_2$), 5.35 – 5.50 (m, 2H, $\text{CH}_2\text{CH}=\text{CH}_2$), 5.69 – 5.99 (m, 3H, $\text{CH}_2\text{CH}=\text{CH}_2$, $\text{CH}_2\text{CH}=\text{CH}$ and $\text{CH}_2\text{CH}=\text{CH}_2$), 6.56 (d, J = 9.5 Hz, 1H, $\text{CH}_2\text{CH}=\text{CH}$) ppm. ^{13}C NMR (100 MHz, CDCl_3): δ = 42.1 (CH_2), 49.6 (CH_2), 54.9 (CH_2), 118.0 ($\text{CH}_2\text{CH}=\text{CH}$), 119.3 ($\text{CH}_2\text{CH}=\text{CH}_2$), 123.7 ($\text{CH}_2\text{CH}=\text{CH}_2$), 125.6 ($\text{CH}_2\text{CH}=\text{CH}_2$), 132.6 ($\text{CH}_2\text{CH}=\text{CH}_2$), 138.6 ($\text{CH}_2\text{CH}=\text{CH}$) ppm. IR (neat): 1037, 931, 733 cm^{-1} . Spectra in accordance with the literature. ^[3]

(*E/Z*)-S-(3-(allylsulfinyl)prop-1-en-1-yl) ethanethioate (118):

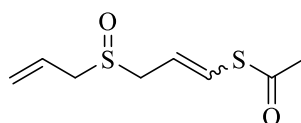

Procedure 1: The vinyl disulfide **109a** (0.100 g, 0.29 mmol) dissolved in THF (3 mL) was cooled to 0 °C under N_2 , and H_2O_2 (50% w/w in H_2O , 0.039 mL, 0.58 mmol) added dropwise. The reaction was allowed to proceed for 1 h at 0 °C and then warmed to rt (2h). Saturated NaHCO_3 aqueous solution (5 mL) was added and the residue was extracted with EtOAc (2×10 mL). The combined fractions were washed with brine (2×10 mL) and dried over Mg_2SO_4 . The solvent was removed under vacuum and the resulting residue purified by column chromatography using Biotage Isolera (gradient 100% hexane for 2 column volume (CV), then increased to 20:80 hexane: diethyl ether over 10 CV, held over 5 CV, increased to 0:100 over 5 CV and held over 10 CV diethyl ether) to afford compound **118** (13 mg, 23%, *d.r.* *E/Z* = 0.56:1) as a pale yellow oil and compound **119** (19.8 mg, 19%, *d.r.* *E/Z* = 1:2)

Procedure 2: The vinyl thioacetate **109a** (0.200 g, 0.58 mmol) dissolved in CH_2Cl_2 (6 mL) was cooled to 0 °C under N_2 , and *m*-CPBA (0.200 g, 1.16 mmol) was added in one portion. The reaction proceeded for 1 h at 0 °C and before being allowed to warm to room temperature, DIPA (0.16 mL, 1.16 mmol) was added. After 2 hours reaction, saturated NaHCO_3 aqueous solution (5 mL) was added and the residue was extracted with CH_2Cl_2 (3×10 mL). The combined fractions were washed with brine (2×10 mL) and dried over Mg_2SO_4 . The solvent was removed under vacuum and the resulting residue purified by column chromatography using Biotage Isolera (gradient: 100% hexane for 2 column

volume (CV), then increased to 20:80 hexane: ethyl acetate over 10 CV, held over 5 CV, increased to 0:100 over 5 CV and held over 10 CV ethyl acetate) to give compound **118** (57 mg, 48% yield, d.r. *E/Z* = 0.67:1) as a pale-yellow oil.

E-isomer: ^1H NMR (400 MHz, CDCl_3): δ = 2.37 (s, 3H, CH_3), 3.32 – 3.68 (m, 4H, CH_2), 5.36 – 5.50 (m, 2H, $\text{CH}_2\text{CH}=\text{CH}_2$), 5.80 – 6.00 (m, 2H, $\text{CH}_2\text{CH}=\text{CH}_2$ and $\text{CH}_2\text{CH}=\text{CH}$), 6.85 (dt, J = 15.9, 1.2 Hz, 1H, $\text{CH}_2\text{CH}=\text{CH}$) ppm. ^{13}C NMR (100 MHz, CDCl_3): δ 30.6 (CH_3), 53.5 (CH_2), 54.5 (CH_2), 120.3 ($\text{CH}_2\text{CH}=\text{CH}_2$), 124.1 ($\text{CH}_2\text{CH}=\text{CH}_2$), 125.5 ($\text{CH}_2\text{CH}=\text{CH}$), 126.2 ($\text{CH}_2\text{CH}=\text{CH}$), 192.1 ($\text{C}=\text{O}$) ppm. HRMS (NSI): $[\text{M}+\text{H}]^+$ calc. 205.0351, found 205.0352 $[\text{C}_8\text{H}_{13}\text{O}_2\text{S}_2]^+$. IR (neat): 1697, 1034, 952, 731, 621 cm^{-1} .

Z-isomer: ^1H NMR (400 MHz, CDCl_3): δ 2.41 (s, 3H, CH_3), 3.32 – 3.68 (m, 4H, CH_2), 5.36 – 5.50 (m, 2H, $\text{CH}_2\text{CH}=\text{CH}_2$), 5.80 – 6.00 (m, 2H, $\text{CH}_2\text{CH}=\text{CH}_2$ and $\text{CH}_2\text{CH}=\text{CH}$), 7.01 (dt, J = 9.8, 1.0 Hz, 1H, $\text{CH}_2\text{CH}=\text{CH}$). ^{13}C NMR (100 MHz, CDCl_3): δ 31.9 (CH_3), 51.3 (CH_2), 54.9 (CH_2), 118.6 ($\text{CH}_2\text{CH}=\text{CH}_2$), 124.0 ($\text{CH}_2\text{CH}=\text{CH}_2$), 125.6 ($\text{CH}_2\text{CH}=\text{CH}_2$), 126.1 ($\text{CH}_2\text{CH}=\text{CH}$), 190.5 ($\text{C}=\text{O}$) ppm. HRMS (NSI): $[\text{M}+\text{H}]^+$ calc. 205.0351, found 205.0352 $[\text{C}_8\text{H}_{13}\text{O}_2\text{S}_2]^+$. IR (neat): 1697, 1034, 952, 731, 621 cm^{-1} .

(*E/Z*)-S-(3-((3-(phenylselanyl)propyl)sulfinyl)prop-1-en-1-yl) ethanethioate (119):

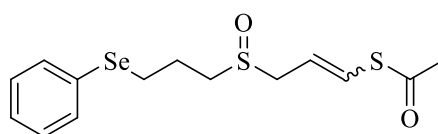

The vinyl thioacetate **109a** (0.100 g, 0.28 mmol) dissolved in mixture of CH_3OH (1.5 mL) and H_2O (0.45 mL) was cooled to 0 °C under N_2 , and NaIO_4 (0.123 g, 0.57 mmol) was added in one portion. The reaction proceeded for 1 h at 0 °C and before being allowed to warm to room temperature. After 4 hours reaction, saturated NaHCO_3 aqueous solution (5 mL) was added and the residue was extracted with CH_2Cl_2 (3 \times 10 mL). The combined fractions were washed with brine (2 \times 5 mL) and dried over Mg_2SO_4 . The solvent was removed under vacuum and the resulting residue purified by column chromatography using Biotage Isolera (gradient: 100% hexane for 3 column volume (CV), increased to 10% ethyl acetate over 3 CV, then increased to 0:100 over 5 CV and held over 5 CV ethyl acetate) to give compound **119** (50 mg, 50% yield, d.r. *E/Z* = 0.55:1) as a pale-yellow oil.

E-isomer: ^1H NMR (400 MHz, CDCl_3): $\delta = 2.08 - 2.23$ (m, 2H, CH_2), 2.38 (s, 3H, CH_3), 2.73 – 2.85 (m, 2H, CH_2), 3.02 (t, $J = 7.0$ Hz, 2H, CH_2), 3.36 – 3.66 (m, 2H, CH_2), 5.79 – 5.97 (m, 1H, $\text{CH}_2\text{CH}=\text{CH}$), 6.83 (dt, $J = 15.9, 1.2$ Hz, 1H, $\text{CH}_2\text{CH}=\text{CH}$), 7.20 – 7.32 (m, 3H, ArH), 7.48 – 7.51 (m, 2H, ArH) ppm. ^{13}C NMR (100 MHz, CDCl_3): $\delta = 23.3$ (CH_2), 26.5 (CH_2), 30.6 (CH_3), 50.7 (CH_2), 55.3 (CH_2), 120.2 ($\text{CH}_2\text{CH}=\text{CH}$), 126.1 ($\text{CH}_2\text{CH}=\text{CH}$), 127.5 (C_{ArH}), 129.3 (C_{ArSe}), 129.4 (2C_{ArH}), 133.2 (2C_{ArH}), 192.0 (C=O) ppm. HRMS (ASAP): $[\text{M}+\text{H}]^+$ calc. 362.9991, found 362.9989 [$\text{C}_{14}\text{H}_{19}\text{OS}_2\text{Se}$] $^+$. IR (neat): 1699, 1126, 1045, 956, 736, 626 cm^{-1} .

Z-isomer: ^1H NMR (400 MHz, CDCl_3): $\delta = 2.08 - 2.23$ (m, 2H, CH_2), 2.38 (s, 3H, CH_3), 2.73 – 2.85 (m, 2H, CH_2), 3.02 (t, $J = 7.0$ Hz, 2H, CH_2), 3.36 – 3.66 (m, 2H, CH_2), 5.79 – 5.97 (m, 1H, $\text{CH}_2\text{CH}=\text{CH}$), 7.01 (dt, $J = 9.8, 1.0$ Hz, 1H, $\text{CH}_2\text{CH}=\text{CH}$), 7.20 – 7.32 (m, 3H, ArH), 7.48 – 7.51 (m, 2H, ArH) ppm. ^{13}C NMR (100 MHz, CDCl_3): $\delta = 23.4$ (CH_2), 26.6 (CH_2), 31.1 (CH_3), 50.9 (CH_2), 52.8 (CH_2), 118.6 ($\text{CH}_2\text{CH}=\text{CH}$), 126.2 ($\text{CH}_2\text{CH}=\text{CH}$), 127.4 (C_{ArH}), 129.3 (C_{ArSe}), 129.4 (2C_{ArH}), 133.2 (2C_{ArH}), 190.4 (C=O) ppm. HRMS (ASAP): $[\text{M}+\text{H}]^+$ calc. 362.9991, found 362.9989 [$\text{C}_{14}\text{H}_{19}\text{OS}_2\text{Se}$] $^+$. IR (neat): 1699, 1126, 1045, 956, 736, 626 cm^{-1} .

6.4.5. Synthesis of *S*-Sulfenylating reagents

S-allyl 4-methylbenzenesulfonothioate (117):

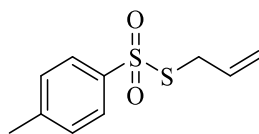

General procedure. Allyl chloride (0.16 mL, 2 mmol) and potassium *p*-toluenethiosulfonate (0.588 g, 2.6 mmol) were dissolved in DMF (3 mL) and stirred at room temperature for 2 h. The solution was then suspended in water (20 mL), which was extracted with EtOAc (2×10 mL). The combined extracts were washed with water (2×20 mL) to remove any residual DMF. Following drying over MgSO₄ and solvent evaporation the product was obtained as a colourless oil (0.319 g, 70% yield).

¹H NMR (400 MHz, CDCl₃): δ = 2.45 (s, 3H, CH₃), 3.67 (dt, *J* = 7.1, 1.2 Hz, 2H, CH₂C=CH₂), 5.11 (dd, *J* = 10.0, 0.9, 1H, CH₂CH=CH₂), 5.20 (dd, *J* = 16.9, 1.2, 1H, CH₂CH=CH₂), 5.62 – 5.79 (m, 1H, CH₂CH=CH₂), 7.34 (d, *J* = 8.0, 2H, ArH), 7.81 (d, *J* = 8.0, 2H, ArH) ppm. ¹³C NMR (100 MHz, CDCl₃): δ = 21.8 (CH₃), 38.9 (CH₂CH=CH₂), 120.1 (CH₂CH=CH₂), 127.3 (2C_{Ar}H), 129.9 (2C_{Ar}H), 130.7 (CH₂CH=CH₂), 142.2 (C_{Ar}), 144.9 (C_{Ar}) ppm. Spectra in accordance with literature.^[4]

S-benzyl 4-methylbenzenesulfonothioate (120a):

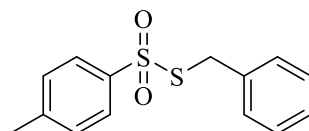

Synthesized according to the general procedure using benzyl chloride (0.18 mL, 1.6 mmol). **120a** (0.423 g, 98% yield) was obtained as a colourless solid.

¹H NMR (300 MHz, CDCl₃): δ = 2.47 (s, 3H, CH₃), 4.28 (s, 2H, CH₂), 7.20 - 7.32 (m, 7H, ArH), 7.76 (d, *J* = 8.3, 2H, ArH) ppm; ¹³C NMR (100 MHz, CDCl₃): δ = 21.8 (CH₃), 40.4 (CH₂), 127.1 (2C_{Ar}H), 128.1 (C_{Ar}H), 128.9 (2C_{Ar}H), 129.2 (2C_{Ar}H), 129.9 (2C_{Ar}H), 133.8 (C_{Ar}), 142.1 (C_{Ar}), 144.8 (C_{Ar}) ppm. Spectra in accordance with literature.^[5]

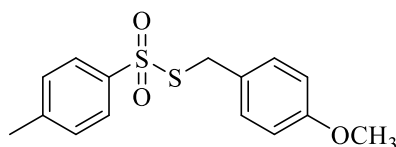
S-(4-methoxybenzyl) 4-methylbenzenesulfonothioate (120b):

Synthesized according to the general procedure using 4-methoxybenzyl chloride (0.17 mL, 1.3 mmol). **120b** (0.419 g, 95% yield) was obtained as a colourless solid.

^1H NMR (300 MHz, CDCl_3): δ = 2.45 (s, 3H, CH_3), 3.77 (s, 3H, OCH_3), 4.22 (s, 2H, CH_2), 6.77 (d, J = 8.5, 2H, ArH), 7.11 (d, J = 8.5, 2H, ArH), 7.30 (d, J = 8.2, 2H, ArH), 7.75 (d, J = 8.2, 2H, ArH) ppm. ^{13}C NMR (100 MHz, CDCl_3): δ = 21.6 (CH_3), 39.9 (CH_2), 55.3 (OCH_3), 114.2 (2C_{ArH}), 125.2 (C_{Ar}), 126.9 (2C_{ArH}), 129.8 (2C_{ArH}), 130.4 (2C_{ArH}), 141.9 (C_{Ar}), 144.6 (C_{Ar}), 159.3 (C_{Ar}) ppm. Spectra in accordance with literature.^[6]

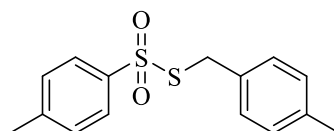
S-(4-methylbenzyl) 4-methylbenzenesulfonothioate (120c):

Synthesized according to the general procedure using 4-methoxybenzyl bromide (0.17 mL, 1.4 mmol). **120c** (0.403 g, 97% yield) was obtained as a colourless solid.

^1H NMR (300 MHz, CDCl_3): δ = 2.31 (s, 3H, CH_3), 2.46 (s, 3H, CH_3), 4.23 (s, 2H, CH_2), 7.03 – 7.10 (m, 4H, ArH), 7.30 (d, J = 8.4, 2H, ArH), 7.76 (d, J = 8.4, 2H, ArH) ppm. ^{13}C NMR (100 MHz, CDCl_3): δ = 21.6 (CH_3), 21.7 (CH_3), 40.1 (CH_2), 127.0 (2C_{ArH}), 129.1 (2C_{ArH}), 129.5 (2C_{ArH}), 129.8 (2C_{ArH}), 130.4 (C_{Ar}), 137.9 (C_{Ar}), 141.9 (C_{Ar}), 144.7 (C_{Ar}) ppm. Spectra in accordance with literature.^[7]

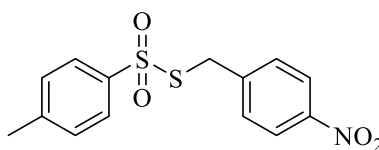
S-(4-nitrobenzyl) 4-methylbenzenesulfonothioate (120d):

Synthesized according to the general procedure using 4-nitrobenzyl bromide (0.200 g, 0.92 mmol) at 60°C. **120d** (0.280 g, 94% yield) was obtained as a colourless solid.

^1H NMR (300 MHz, CDCl_3): δ = 2.41 (s, 3H, CH_3), 4.32 (s, 2H, CH_2), 7.20 – 7.25 (m, 2H, ArH), 7.32 – 7.43 (m, 2H, ArH), 7.60 – 7.70 (m, 2H, ArH), 7.96 – 8.12 (m, 2H, ArH) ppm. ^{13}C NMR (100 MHz, CDCl_3): δ = 21.8 (CH_3), 39.4 (CH_3), 123.9 (2C_{ArH}), 127.1 (2C_{ArH}), 129.9 (2C_{ArH}), 130.0 (2C_{ArH}), 141.8 (C_{Ar}), 141.9 (C_{Ar}), 145.3 (C_{Ar}), 147.4 (C_{Ar}) ppm. Spectra in accordance with literature.^[5]

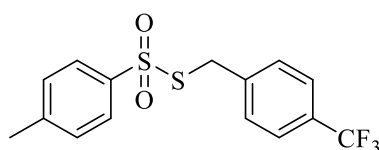
S-(4-(trifluoromethyl)benzyl) 4-methylbenzenesulfonothioate (120e):

Synthesized according to the general procedure using 4-(trifluoromethyl)benzyl chloride (0.15 mL, 1 mmol). **120e** (0.330 g, 95% yield) was obtained as a colourless solid.

^1H NMR (300 MHz, CDCl_3): δ = 2.35 (s, 3H, CH_3), 4.26 (s, 2H, CH_2), 7.12 – 7.17 (m, 2H, ArH), 7.23 (d, J = 8.0 Hz, 2H, ArH), 7.38 (d, J = 8.0 Hz, 2H, ArH), 7.53 – 7.58 (m, 2H, ArH) ppm. ^{13}C NMR (100 MHz, CDCl_3): δ = 21.7 (CH_3), 39.8 (CH_3), 125.4-125.6 (m, CF_3 and 2C_{ArH}), 126.9 (2C_{ArH}), 129.4 (2C_{ArH} and C_{Ar}), 129.7 (2C_{ArH}), 138.2 (C_{Ar}), 141.9 (C_{Ar}), 144.9 (C_{Ar}) ppm. HRMS (ASAP): $[\text{M}+\text{H}]^+$ calc. 347.0384, found 347.0387 [$\text{C}_{15}\text{H}_{14}\text{F}_3\text{O}_2\text{S}_2$] $^+$. IR (neat): 1315, 1134, 1066, 813, 651, 582, 516 cm^{-1} .

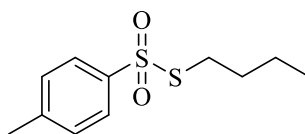
S-butyl 4-methylbenzenesulfonothioate (120f):

Synthesized according to the general procedure using 1-bromobutane (0.16 mL, 1.4 mmol). **120f** (0.339 g, 95% yield) was obtained as a clear solid.

^1H NMR (300 MHz, CDCl_3): δ = 0.84 (t, J = 7.3 Hz, 3H, CH_3), 1.32 (h, J = 7.3 Hz, 3H, CH_2), 1.56 (q, J = 7.6 Hz, 3H, CH_2), 2.45 (s, CH_3), 2.97 (t, J = 7.4 Hz, 3H, CH_2), 7.34 (d, J = 7.9 Hz, 2H, ArH), 7.81 (d, J = 8.2 Hz, 2H, ArH) ppm. ^{13}C NMR (100 MHz, CDCl_3): δ = 13.5 (CH_3), 21.8 (CH_2), 30.6 (CH_2), 35.8 (CH_2), 127.1 (2C_{ArH}), 129.9 (2C_{ArH}), 142.0 (C_{Ar}), 144.8 (C_{Ar}) ppm. Spectra in accordance with literature.^[5]

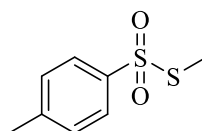
S-methyl 4-methylbenzenesulfonothioate (120g):

Synthesized according to the general procedure using methyl iodide (0.09 g, 1.4 mmol). **120g** (0.279 g, 98% yield) was obtained as a clear solid.

^1H NMR (300 MHz, CDCl_3): δ = 2.45 (s, 3H, CH_3), 2.49 (s, 3H, CH_3), 7.35 (d, J = 8.0 Hz, 2H, ArH), 7.80 (d, J = 8.3 Hz, 2H, ArH) ppm. ^{13}C NMR (100 MHz, CDCl_3): δ = 18.2 (CH_3), 21.8 (CH_3), 127.3 (2C_{ArH}), 129.9 (2C_{ArH}), 140.8 (C_{Ar}), 144.9 (C_{Ar}) ppm. Spectra in accordance with literature.^[5]

6.4.6. Synthesis of ajoene derivatives

(*E/Z*)-1-(3-(allylsulfinyl)prop-1-en-1-yl)-2-benzylsulfane (**121a**):

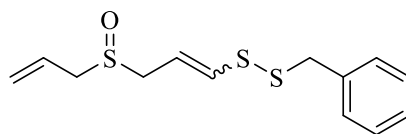

General procedure: The vinyl thioacetate **118** (0.060 g, 0.29 mmol) was dissolved in CH₂Cl₂ (0.3 mL) and the solution was cooled to -40 °C and stirred under N₂. KOH (0.017 g, 0.3 mmol) in degassed methanol (0.3 mL) was added slowly and the reaction left stirring for 45 minutes, after which it was cooled down to -78 °C. Sulfonylthioate **120a** (0.089 mg, 0.32 mmol) dissolved in CH₂Cl₂ (0.3 mL) was added and the reaction allowed to stir for an hour at -78 °C before being allowed to warm up. The reaction was quenched with saturated ammonium chloride (3 mL), the solvents were removed under vacuum on the rotary evaporator, and the resulting residue extracted with CH₂Cl₂ (3×10 mL). The combined extracts were washed with brine (2×10 mL) and dried over MgSO₄. The solvent was removed under vacuum and the resulting residue purified by column chromatography using Biotage Isolera (gradient: 100% hexane for 2 column volume (CV), then increased to 20:80 hexane: diethyl ether over 10 CV, held over 5 CV, increased to 0:100 over 5 CV and held over 10 CV diethyl ether) to afford **121a** (0.067 g, 80% yield, *d.r.* *E/Z* = 0.67:1) as a pale-yellow oil.

E-isomer: ¹H NMR (300 MHz, CDCl₃): δ = 3.20 – 3.53 (m, 4H, CH₂), 3.84 (s, 3H, CH₃), 5.27 – 5.40 (m, 2H, CH₂CH=CH₂), 5.65 – 5.88 (m, 2H, CH₂CH=CH₂ and CH₂CH=CH), 6.06 (d, *J* = 14.8 Hz, 1H, CH₂CH=CH), 7.19 – 7.25 (m, 5H, H-Ar). ¹³C NMR (100 MHz, CDCl₃): δ = 42.8 (CH₂), 52.9 (CH₂), 54.4 (CH₂), 116.8 (CH₂CH=CH), 123.8 (CH₂CH=CH₂), 125.5 (CH₂CH=CH₂), 127.7 (C_{Ar}), 128.6 (2C_{Ar}H), 129.4 (2C_{Ar}H), 134.7 (CH₂CH=CH), 136.7 (C_{Ar}) ppm. HRMS (ESI): [M+H]⁺ calc. 285.0442, found 285.0440 [C₁₃H₁₇OS₃]⁺. IR (neat): 1037, 929, 698 cm⁻¹.

Z-isomer: ¹H NMR (400 MHz, CDCl₃): δ = 3.20 – 3.53 (m, 4H, CH₂), 3.86 (s, 3H, CH₃), 5.27 – 5.40 (m, 2H, CH₂CH=CH₂), 5.52 (dt, *J* = 9.5, 8.0 Hz, 1H, CH₂CH=CH), 5.65 – 5.88 (m, 1H, CH₂CH=CH₂), 6.15 (d, *J* = 9.5 Hz, 1H, CH₂CH=CH), 7.19-7.25 (m, 5H, H-Ar). ¹³C NMR (100 MHz, CDCl₃): δ = 43.5 (CH₂), 49.5 (CH₂), 54.8 (CH₂), 117.8

(CH₂CH=CH), 123.9 (CH₂CH=CH₂), 125.6 (CH₂CH=CH₂), 127.7 (C_{Ar}), 128.6 (2C_{Ar}H), 129.5 (2C_{Ar}H), 136.6 (C_{Ar}), 138.1 (CH₂CH=CH) ppm. HRMS (ASAP): [M+H]⁺ calc. 285.0442, found 285.0440 [C₁₃H₁₇OS₃]⁺. IR (neat): 1037, 929, 698 cm⁻¹.

(*E/Z*)-1-(3-(allylsulfinyl)prop-1-en-1-yl)-2-(4-methoxybenzyl)disulfane (121b):

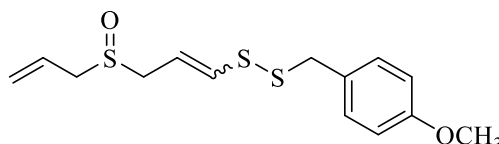

Synthesized according to the general procedure on a 0.26 mmol scale using **120b**; **121b** (0.072 g, 87 % yield, d.r. *E/Z* = 0.76:1) was obtained as a clear oil.

E-isomer: ¹H NMR (300 MHz, CDCl₃): δ = 3.15 – 3.61 (m, 4H, CH₂CH=CH₂ and CH₂CH=CH), 3.72 (s, 3H, OCH₃), 3.81 (s, 2H, CH₂), 5.23 – 5.42 (m, 2H, CH₂CH=CH₂), 5.65 – 5.95 (m, 2H, CH₂CH=CH₂ and CH₂CH=CH), 6.09 (d, *J* = 15.6 Hz, 1H, CH₂CH=CH), 6.77 (d, *J* = 8.6 Hz, 2H, ArH), 7.12 – 7.16 (m, 2H, ArH) ppm. ¹³C NMR (100 MHz, CDCl₃): δ = 42.2 (CH₂), 52.9 (CH₂), 54.2 (CH₂), 55.3 (OCH₃), 114.0 (2C_{Ar}H), 116.5 (CH₂CH=CH), 123.8 (CH₂CH=CH₂), 125.6 (CH₂CH=CH₂), 128.5 (C_{Ar}), 130.6 (2C_{Ar}H), 134.4 (CH₂CH=CH), 159.1 (C_{Ar}) ppm. HRMS (ASAP): [M+H]⁺ calc. 315.0547, found 315.0546 [C₁₄H₁₈O₂S₃]⁺. IR (neat): 1608, 1510, 1301, 1028, 995, 831 cm⁻¹.

Z-isomer: ¹H NMR (400 MHz, CDCl₃): δ = 3.15 – 3.61 (m, 4H, CH₂CH=CH₂ and CH₂CH=CH), 3.73 (s, 3H, OCH₃), 3.83 (s, 2H, CH₂), 5.23 – 5.42 (m, 2H, CH₂CH=CH₂), 5.55 (dt, *J* = 9.5, 8.0 Hz, 1H, CH₂CH=CH), 5.65 – 5.95 (m, 1H, CH₂CH=CH₂ and CH₂CH=CH), 6.19 (d, *J* = 9.5 Hz, 1H, CH₂CH=CH), 6.77 (d, *J* = 8.6 Hz, 2H, ArH), 7.12 – 7.16 (m, 2H, ArH) ppm. ¹³C NMR (100 MHz, CDCl₃): δ = 43.0 (CH₂), 49.6 (CH₂), 54.8 (CH₂), 55.3 (OCH₃), 114.0 (2C_{Ar}H), 117.7 (CH₂CH=CH), 123.9 (CH₂CH=CH₂), 125.7 (CH₂CH=CH₂), 128.4 (C_{Ar}), 130.6 (2C_{Ar}H), 138.4 (CH₂CH=CH), 159.2 (C_{Ar}) ppm. HRMS (ASAP): [M+H]⁺ calc. 315.0547, found 315.0546 [C₁₄H₁₈O₂S₃]⁺. IR (neat): 1608, 1510, 1301, 1028, 995, 831 cm⁻¹.

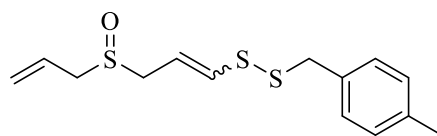
(*E/Z*)-1-(3-(allylsulfinyl)prop-1-en-1-yl)-2-(4-methylbenzyl)disulfane (121c):

Synthesized according to the general procedure on a 0.28 mmol scale using **120c**; **121c** (0.075 g, 90% yield, *d.r.* *E/Z* = 0.76:1) was obtained as a clear oil.

E-isomer: ^1H NMR (300 MHz, CDCl_3): δ = 2.32 (s, 3H, CH_3), 3.23 – 3.66 (m, 4H, $\text{CH}_2\text{CH}=\text{CH}_2$ and $\text{CH}_2\text{CH}=\text{CH}$), 3.87 (s, 2H, CH_2), 5.32 – 5.48 (m, 2H, $\text{CH}_2\text{CH}=\text{CH}_2$), 5.71 – 5.97 (m, 2H, $\text{CH}_2\text{CH}=\text{CH}_2$ and $\text{CH}_2\text{CH}=\text{CH}$), 6.15 (d, J = 14.8 Hz, 1H, $\text{CH}_2\text{CH}=\text{CH}$), 7.07 – 7.20 (m, 4H, ArH) ppm. ^{13}C NMR (100 MHz, CDCl_3): δ = 21.2 (CH_3), 42.5 (CH_2), 52.9 (CH_2), 54.1 (CH_2), 116.8 ($\text{CH}_2\text{CH}=\text{CH}$), 123.8 ($\text{CH}_2\text{CH}=\text{CH}_2$), 125.5 ($\text{CH}_2\text{CH}=\text{CH}_2$), 129.3 (4C_{ArH}), 133.5 (C_{Ar}), 134.4 ($\text{CH}_2\text{CH}=\text{CH}$), 137.4 (C_{Ar}) ppm. HRMS (ASAP): $[\text{M}+\text{H}]^+$ calc. 299.0598, found 299.0597 [$\text{C}_{14}\text{H}_{19}\text{OS}_3$] $^+$. IR (neat): 1037, 927, 812, 524 cm^{-1} .

Z-isomer: ^1H NMR (400 MHz, CDCl_3): δ = 2.32 (s, 3H, CH_3), 3.23 – 3.66 (m, 4H, $\text{CH}_2\text{CH}=\text{CH}_2$ and $\text{CH}_2\text{CH}=\text{CH}$), 3.90 (s, 2H, CH_2), 5.32 – 5.48 (m, 2H, $\text{CH}_2\text{CH}=\text{CH}_2$), 5.61 (dt, J = 9.5, 7.9 Hz, 1H, $\text{CH}_2\text{CH}=\text{CH}$), 5.71 – 5.97 (m, 1H, $\text{CH}_2\text{CH}=\text{CH}_2$), 6.26 (d, J = 9.5 Hz, 1H, $\text{CH}_2\text{CH}=\text{CH}$), 7.07 – 7.20 (m, 4H, ArH) ppm. ^{13}C NMR (100 MHz, CDCl_3): δ = 21.2 (CH_3), 43.3 (CH_2), 49.5 (CH_2), 54.8 (CH_2), 117.8 ($\text{CH}_2\text{CH}=\text{CH}$), 123.9 ($\text{CH}_2\text{CH}=\text{CH}_2$), 125.6 ($\text{CH}_2\text{CH}=\text{CH}_2$), 129.5 (4C_{ArH}), 133.4 (C_{Ar}), 137.5 (C_{Ar}), 138.2 ($\text{CH}_2\text{CH}=\text{CH}$) ppm. HRMS (ASAP): $[\text{M}+\text{H}]^+$ calc. 299.0598, found 299.0597 [$\text{C}_{14}\text{H}_{19}\text{OS}_3$] $^+$. IR (neat): 1037, 927, 812, 524 cm^{-1} .

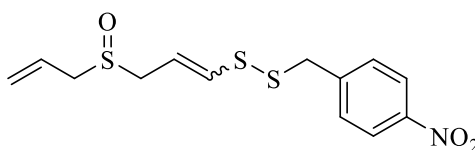
(*E/Z*)-1-(3-(allylsulfinyl)prop-1-en-1-yl)-2-(4-nitrobenzyl)disulfane (121d):

Synthesized according to the general procedure on a 0.24 mmol scale using **120d**. **121d** (0.067 g, 84 % yield) was obtained as a clear oil. The *Z*-isomer was the major isomer formed (d.r. *E/Z* = 0.78:1).

E-isomer: ^1H NMR (300 MHz, CDCl_3): δ = 3.16 – 3.22 (m, 4H, $\text{CH}_2\text{CH}=\text{CH}_2$ and $\text{CH}_2\text{CH}=\text{CH}$), 3.94 (s, 2H, CH_2), 5.28 – 5.47 (m, 2H, $\text{CH}_2\text{CH}=\text{CH}_2$), 5.73 – 5.95 (m, 2H, $\text{CH}_2\text{CH}=\text{CH}_2$ and $\text{CH}_2\text{CH}=\text{CH}$), 6.16 (d, J = 14.8 Hz, 1H, $\text{CH}_2\text{CH}=\text{CH}$), 7.44 (d, J = 8.3 Hz, 2H, ArH), 8.14 (d, J = 8.3 Hz, 2H, ArH) ppm. ^{13}C NMR (100 MHz, CDCl_3): δ = 41.4 (CH_2), 52.7 (CH_2), 54.8 (CH_2), 118.1 ($\text{CH}_2\text{CH}=\text{CH}$), 123.8 (2C_{ArH}), 123.9 ($\text{CH}_2\text{CH}=\text{CH}_2$), 125.5 ($\text{CH}_2\text{CH}=\text{CH}_2$), 130.3 (2C_{ArH}), 133.2 ($\text{CH}_2\text{CH}=\text{CH}$), 144.4 (C_{Ar}), 147.4 (C_{Ar}) ppm. HRMS (ASAP): $[\text{M}+\text{H}]^+$ calc. 330.0292, found 330.0290 $[\text{C}_{14}\text{H}_{15}\text{F}_3\text{OS}_3]^+$. IR (neat): 1516, 1344, 1041 cm^{-1} .

Z-isomer: ^1H NMR (400 MHz, CDCl_3): 3.16 – 3.22 (m, 4H, $\text{CH}_2\text{CH}=\text{CH}_2$ and $\text{CH}_2\text{CH}=\text{CH}$), 3.97 (s, 2H, CH_2), 5.28 – 5.47 (m, 2H, $\text{CH}_2\text{CH}=\text{CH}_2$), 5.63 (dt, J = 9.5, 8.0 Hz, 1H, $\text{CH}_2\text{CH}=\text{CH}$), 5.73 – 5.95 (m, 1H, $\text{CH}_2\text{CH}=\text{CH}_2$), 6.24 (d, J = 9.5 Hz, 1H, $\text{CH}_2\text{CH}=\text{CH}$), 7.44 (d, J = 8.3 Hz, 2H, ArH), 8.14 (d, J = 8.3 Hz, 2H, ArH) ppm. ^{13}C NMR (100 MHz, CDCl_3): δ = 42.3 (CH_2), 49.5 (CH_2), 55.0 (CH_2), 119.0 ($\text{CH}_2\text{CH}=\text{CH}$), 123.8 (2C_{ArH}), 124.0 ($\text{CH}_2\text{CH}=\text{CH}_2$), 125.5 ($\text{CH}_2\text{CH}=\text{CH}_2$), 130.3 (2C_{ArH}), 137.4 ($\text{CH}_2\text{CH}=\text{CH}$), 144.4 (C_{Ar}), 147.4 (C_{Ar}) ppm. HRMS (ASAP): $[\text{M}+\text{H}]^+$ calc. 330.0292, found 330.0290 $[\text{C}_{14}\text{H}_{15}\text{F}_3\text{OS}_3]^+$. IR (neat): 1516, 1344, 1041 cm^{-1} .

(*E/Z*)-1-(3-(allylsulfinyl)prop-1-en-1-yl)-2-(4-(trifluoromethyl)benzyl)disulfane (121e):

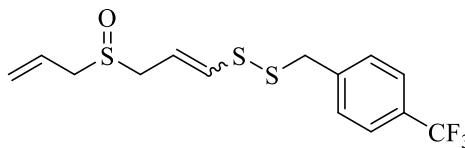

Synthesized according to the general procedure on a 0.24 mmol scale using **120e**; **121e** (0.062 g, 72 % yield, d.r. *E/Z* = 0.75:1) was obtained as a clear oil.

E-isomer: ¹H NMR (300 MHz, CDCl₃): δ = 3.16 – 3.67 (m, 4H, CH₂CH=CH₂ and CH₂CH=CH), 3.92 (s, 2H, CH₂), 5.29 – 5.47 (m, 2H, CH₂CH=CH₂), 5.71 – 5.96 (m, 2H, CH₂CH=CH₂ and CH₂CH=CH), 6.11 (d, *J* = 14.9 Hz, 1H, CH₂CH=CH), 7.35 – 7.44 (m, 2H, ArH), 7.55 (d, *J* = 7.9 Hz, 2H, ArH) ppm. ¹³C NMR (100 MHz, CDCl₃): δ = 41.9 (CH₂), 52.8 (CH₂), 54.6 (CH₂), 117.5 (CH₂CH=CH), 123.9 (CH₂CH=CH₂), 125.5 (CH₂CH=CH₂), 125.6-125.9 (m, CF₃ and 2C_{Ar}H), 129.8 (2C_{Ar}H and C_{Ar}), 133.8 (CH₂CH=CH), 140.9 (C_{Ar}) ppm. HRMS (ASAP): [M+H]⁺ calc. 353.0315, found 353.0308 [C₁₄H₁₅F₃OS₃]⁺. IR (neat): 1321, 1066, 1018, 937 cm⁻¹.

Z-isomer: ¹H NMR (400 MHz, CDCl₃): δ = 3.16 – 3.67 (m, 4H, CH₂CH=CH₂ and CH₂CH=CH), 3.94 (s, 2H, CH₂), 5.29 – 5.47 (m, 2H, CH₂CH=CH₂), 5.60 (dt, *J* = 9.5, 7.9 Hz, 1H, CH₂CH=CH), 5.71 – 5.96 (m, 1H, CH₂CH=CH), 6.23 (d, *J* = 9.5 Hz, 1H, CH₂CH=CH), 7.35 – 7.44 (m, 2H, ArH), 7.55 (d, *J* = 7.9 Hz, 2H, ArH) ppm. ¹³C NMR (100 MHz, CDCl₃): δ = 42.7 (CH₂), 49.6 (CH₂), 54.9 (CH₂), 118.5 (CH₂CH=CH), 124.0 (CH₂CH=CH₂), 125.5 (CH₂CH=CH₂), 125.6-125.9 (m, CF₃ and 2C_{Ar}H), 129.8 (2C_{Ar}H and C_{Ar}), 137.8 (CH₂CH=CH), 140.9 (C_{Ar}) ppm. HRMS (ASAP): [M+H]⁺ calc. 353.0315, found 353.0308 [C₁₄H₁₅F₃OS₃]⁺. IR (neat): 1321, 1066, 1018, 937 cm⁻¹.

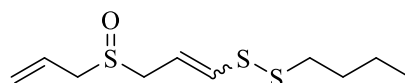
(E/Z)- 1-(3-(allylsulfinyl)prop-1-en-1-yl)-2-butyldisulfane (121f):

Synthesized according to the general procedure on a 0.24 mmol scale using **120f**; **121f** (0.048 g, 78 % yield, *d.r.* *E/Z* = 0.68:1) was obtained as a clear oil.

E-isomer: ^1H NMR (300 MHz, CDCl_3): δ = 0.89 (t, J = 7.3 Hz, 3H, CH_3), 1.38 (sex, J = 7.3 Hz, 2H, CH_2), 1.55 – 1.71 (m, 2H, CH_2), 2.69 (t, J = 7.9 Hz, 2H, CH_2), 3.31 – 3.68 (m, 4H, CH_2), 5.31 – 5.48 (m, 2H, $\text{CH}_2\text{CH}=\text{CH}_2$), 5.78 – 5.97 (m, 2H, $\text{CH}_2\text{CH}=\text{CH}_2$ and $\text{CH}_2\text{CH}=\text{CH}$), 6.36 (d, J = 14.8 Hz, 1H, $\text{CH}_2\text{CH}=\text{CH}$) ppm. ^{13}C NMR (100 MHz, CDCl_3): δ = 13.7 (CH_3), 21.6 (CH_2), 31.2 (CH_2), 38.1 (CH_2), 53.0 (CH_2), 54.3 (CH_2), 116.1 ($\text{CH}_2\text{CH}=\text{CH}$), 123.8 ($\text{CH}_2\text{CH}=\text{CH}_2$), 125.6 ($\text{CH}_2\text{CH}=\text{CH}_2$), 134.9 ($\text{CH}_2\text{CH}=\text{CH}$) ppm. HRMS (ASAP): $[\text{M}+\text{H}]^+$ calc. 251.0598, found 251.0598 $[\text{C}_{10}\text{H}_{18}\text{OS}_3]^+$. IR (neat): 1037, 925, 732 cm^{-1} .

Z-isomer: ^1H NMR (400 MHz, CDCl_3): δ = 0.89 (t, J = 7.3 Hz, 3H, CH_3), 1.38 (sex, J = 7.3 Hz, 2H, CH_2), 1.55 – 1.71 (m, 2H, CH_2), 2.71 (t, J = 7.9 Hz, 2H, CH_2), 3.31 – 3.68 (m, 4H, CH_2), 5.31 – 5.48 (m, 2H, $\text{CH}_2\text{CH}=\text{CH}_2$), 5.72 (dt, J = 9.6, 7.9 Hz, 1H, $\text{CH}_2\text{CH}=\text{CH}$), 5.78 – 5.97 (m, 1H, $\text{CH}_2\text{CH}=\text{CH}_2$), 6.56 (d, J = 9.6 Hz, 1H, $\text{CH}_2\text{CH}=\text{CH}$) ppm. ^{13}C NMR (100 MHz, CDCl_3): δ = 13.7 (CH_3), 21.5 (CH_2), 31.0 (CH_2), 38.9 (CH_2), 49.6 (CH_2), 54.9 (CH_2), 117.6 ($\text{CH}_2\text{CH}=\text{CH}$), 123.9 ($\text{CH}_2\text{CH}=\text{CH}_2$), 125.7 ($\text{CH}_2\text{CH}=\text{CH}_2$), 139.1 ($\text{CH}_2\text{CH}=\text{CH}$) ppm. HRMS (ASAP): $[\text{M}+\text{H}]^+$ calc. 251.0598, found 251.0598 $[\text{C}_{10}\text{H}_{18}\text{OS}_3]^+$. IR (neat): 1037, 925, 732 cm^{-1} .

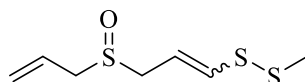
(*E/Z*)- 1-(3-(allylsulfinyl)prop-1-en-1-yl)-2-methyldisulfane (121g):

Synthesized according to the general procedure on a 0.24 mmol scale using **120g**; **121g** (0.039 g, 76 % yield, d.r. *E/Z* = 1:1) was obtained as a clear oil.

E-isomer: ^1H NMR (300 MHz, CDCl_3): δ = 2.39 (s, 3H, CH_3), 3.29 – 3.71 (m, 4H, CH_2), 5.29 – 5.49 (m, 2H, $\text{CH}_2\text{CH}=\text{CH}_2$), 5.70 – 6.01 (m, 2H, $\text{CH}_2\text{CH}=\text{CH}_2$ and $\text{CH}_2\text{CH}=\text{CH}$), 6.36 (d, J = 14.8 Hz, 1H, $\text{CH}_2\text{CH}=\text{CH}$) ppm. ^{13}C NMR (100 MHz, CDCl_3): δ = 23.2 (CH_3), 52.9 (CH_2), 54.4 (CH_2), 116.5 ($\text{CH}_2\text{CH}=\text{CH}$), 123.7 ($\text{CH}_2\text{CH}=\text{CH}_2$), 125.6 ($\text{CH}_2\text{CH}=\text{CH}_2$), 133.5 ($\text{CH}_2\text{CH}=\text{CH}$) ppm. HRMS (ASAP): $[\text{M}+\text{H}]^+$ calc. 209.0128, found 209.0127 [$\text{C}_7\text{H}_{12}\text{OS}_3$] $^+$. IR (neat): 1032, 925, 798 cm^{-1} .

Z-isomer: ^1H NMR (400 MHz, CDCl_3): δ = 2.43 (s, 3H, CH_3), 3.29 – 3.71 (m, 4H, CH_2), 5.29 – 5.49 (m, 2H, $\text{CH}_2\text{CH}=\text{CH}_2$), 5.70 – 6.01 (m, 2H, $\text{CH}_2\text{CH}=\text{CH}_2$ and $\text{CH}_2\text{CH}=\text{CH}$), 6.59 (d, J = 9.5 Hz, 1H, $\text{CH}_2\text{CH}=\text{CH}$) ppm. ^{13}C NMR (100 MHz, CDCl_3): δ = 22.1 (CH_3), 49.5 (CH_2), 54.9 (CH_2), 118.6 ($\text{CH}_2\text{CH}=\text{CH}$), 123.9 ($\text{CH}_2\text{CH}=\text{CH}_2$), 125.6 ($\text{CH}_2\text{CH}=\text{CH}_2$), 137.9 ($\text{CH}_2\text{CH}=\text{CH}$) ppm. HRMS (ASAP): $[\text{M}+\text{H}]^+$ calc. 209.0128, found 209.0127 [$\text{C}_7\text{H}_{12}\text{OS}_3$] $^+$. IR (neat): 1032, 925, 798 cm^{-1} .

6.5. Experimental data for Chapter 4: An alternative approach to the synthesis of ajoene

6.5.1. Propargylation of thioacetic acid

S-(prop-2-yn-1-yl) ethanethioate (**123**):

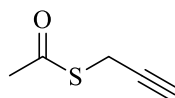

Procedure I.^[8] To a solution of propargyl bromide (0.43 mL, 5 mmol) and triethylamine (0.73 mL, 5.25 mmol) in diethyl ether (1.6 mL) at 0 °C, a solution of thioacetic acid (0.37 mL, 5.25 mmol) in dry dichloromethane (0.65 mL) was added dropwise. The reaction was stirred at 0 °C for 1 hour and then at room temperature for 24h. The reaction mixture was then filtered and washed with water (3 x 5 mL). The organic phase was dried over MgSO₄ and concentrated *in vacuo*. After purification by column chromatography (0 to 10% Et₂O in hexane) the pure product **123** was obtained as a yellow oil (0.379 g, 63% yield).

Procedure II.^[9] To a suspension of NaH (80% suspension in mineral oil, 0.413 g, 17.3 mmol) in dry tetrahydrofuran (20 mL) at 0 °C, a solution of thioacetic acid (13 mmol, 0.92 mL) in dry tetrahydrofuran (3 mL) was added dropwise. The resulting mixture was stirred at room temperature for 30 minutes, until hydrogen evolution ceased and the solution became transparent. After cooling again to 0 °C, propargyl bromide (6.5 mmol, 0.5 mL) was added dropwise and the reaction stirred for 1 hour at room temperature. After quenching the reaction with water (50 mL), the organic phase was extracted with diethyl ether (3 x 50 mL), dried over MgSO₄ and concentrated *in vacuo*. After purification by column chromatography (0 to 10% Et₂O in hexane) the pure product **123** was obtained as a yellow oil (0.750 g, 50% yield).

Procedure III. To a solution of thioacetic acid (0.35 mL, 5 mmol) in THF (15 mL) were added propargyl bromide (0.43 mL, 5 mmol) and anhydrous K₂CO₃ (0.691 g, 5 mmol). The mixture was stirred at room temperature for 3 hours. The separated solid was filtered and washed with dichloromethane (15 mL x 2). The solvent was evaporated *in vacuo* at 30 °C to furnish the pure product **123** as a yellow oil (0.428 g, 75 % yield).

^1H NMR (400 MHz, CDCl_3): δ = 2.18 (t, J = 2.7 Hz, 1H, $\text{CH}_2\text{C}\equiv\text{CH}$), 2.37 (s, 3H, CH_3), 3.64 (d, J = 2.7 Hz, 1H, $\text{CH}_2\text{C}\equiv\text{CH}$) ppm. ^{13}C NMR (100 MHz, CDCl_3): δ = 17.6 ($\text{CH}_2\text{C}\equiv\text{CH}$), 30.3 (CH_3), 70.9 ($\text{CH}_2\text{C}\equiv\text{CH}$), 78.9 ($\text{CH}_2\text{C}\equiv\text{CH}$), 193.9 (C=O) ppm. Spectra in accordance to literature.¹⁹¹

6.5.2. Radical addition reaction of thioacetic acid to alkyne

(*E/Z*)-*S,S'*-(prop-1-ene-1,3-diyl) diethanethioate (**124**):

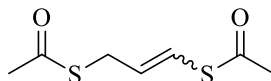

E-isomer: ^1H NMR (500 MHz, CDCl_3): δ = 2.33 (s, 3H, CH_3), 2.34 (s, 3H, CH_3), 3.55 d, J = 7.3 Hz, 2H, CH_2), 5.78 – 5.86 (m, 1H, $\text{CH}_2\text{CH}=\text{CH}$), 6.70 (d, J = 15.7 Hz, 1H, $\text{CH}_2\text{CH}=\text{CH}$) ppm. ^{13}C NMR (100 MHz, CDCl_3): δ = 30.5 (CH_3), 30.6 (CH_3), 31.5 ($\text{CH}_2\text{CH}=\text{CH}$), 120.8 ($\text{CH}_2\text{CH}=\text{CH}$), 128.2 ($\text{CH}_2\text{CH}=\text{CH}$), 192.7 (C=O), 194.9 (C=O) ppm. HRMS (ASAP): $[\text{M}+\text{H}]^+$ calc. 191.0201, found 191.0203 [$\text{C}_7\text{H}_{11}\text{O}_2\text{S}_2$] $^+$. IR (neat): 1682, 1352, 1124, 1103, 948, 619 cm^{-1} .

Z-isomer: ^1H NMR (500 MHz, CDCl_3): δ = 2.34 (s, 3H, CH_3), 2.40 (s, 3H, CH_3), 3.55 d, J = 8.4 Hz, 2H, CH_2), 5.83 (dt, J = 9.6, 7.7 Hz, 1H, $\text{CH}_2\text{CH}=\text{CH}$), 6.69 (d, J = 9.6 Hz, 1H, $\text{CH}_2\text{CH}=\text{CH}$) ppm. ^{13}C NMR (100 MHz, CDCl_3): δ = 28.7 ($\text{CH}_2\text{CH}=\text{CH}$), 30.5 (CH_3), 31.1 (CH_3), 120.7 ($\text{CH}_2\text{CH}=\text{CH}$), 126.7 ($\text{CH}_2\text{CH}=\text{CH}$), 191.1 (C=O), 195.1 (C=O) ppm. HRMS (ASAP): $[\text{M}+\text{H}]^+$ calc. 191.0201, found 191.0203 [$\text{C}_7\text{H}_{11}\text{O}_2\text{S}_2$] $^+$. IR (neat): 1682, 1352, 1124, 1103, 948, 619 cm^{-1} .

6.5.2.1. Batch

The propargylic sulfide **123** (0.321 g, 2.8 mmol) was dissolved in degassed toluene (2 mL) and the solution heated to 85 °C under N_2 . Radical initiator (10 mol%, 0.28 mmol,) was added to the solution directly, followed by the dropwise addition of thioacetic acid (0.22 mL, 3.08 mmol) in toluene (3 mL) over 40 minutes using a syringe pump. The mixture was left stirring for 1 h. The reaction was then quenched with aqueous saturated solution of sodium carbonate (3 mL) and the toluene removed under vacuum. The remaining residue was extracted with dichloromethane (2 x 10 mL) and the combined extracts were washed with brine (2 x 10 mL) and dried over MgSO_4 . The solvent was evaporated *in vacuo* and the resulting residue purified by column chromatography using

Biotage Isolera (gradient: 100% hexane for 3 column volume (CV), then increased to 80:20 hexane: diethyl ether over 15 CV, then hexane: diethyl ether over 3 CV) to afford compound **124** (AIBN: 0.298 g, 56 % yield, d.r. *E/Z* = 1:1.60; ACCN: 0.287 g, 54 % yield, d.r. *E/Z* = 1:1.25) as a pale-yellow oil.

6.5.2.2. Flow chemistry

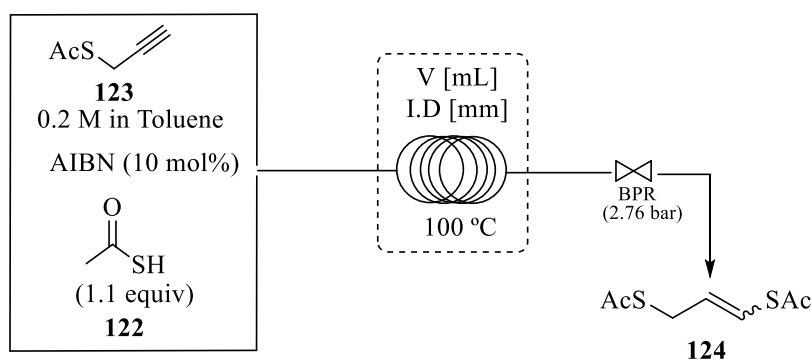

S-(prop-2-yn-1-yl) ethanethioate **123** (0.100 g, 0.87 mmol), thioacetic acid (0.138 mL, 1.74 mmol) and AIBN (0.014 mg, 0.087 mmol) were dissolved in degassed toluene (4 mL). The solution was pumped through the reactor (1.1 mL inner 0.175 mm internal diameter) placed at 100 °C, using a syringe pump (0.055 mL/min). After reaching the steady state, the solution was collected for 36 minutes. The outlet was quenched with aqueous saturated NaHCO₃ (5 mL), the toluene evaporated *in vacuo* and the residue extracted with diethyl ether (3 x 5 mL). The combined extracts were washed with brine and dried over MgSO₄ and the solvent evaporated *in vacuo*. The product was purified by column chromatography using Biotage Isolera (gradient: 100% hexane for 3 column volume (CV), then increased to 80:20 hexane: diethyl ether over 15 CV, then hexane: diethyl ether over 3 CV) to afford compound **124** (0.055 g, 71 % yield, d.r. *E/Z* = 0.33:1.68) as a pale-yellow oil.

6.5.2.3. Flow electrochemistry

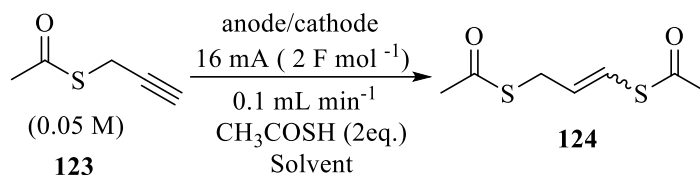

S-(prop-2-yn-1-yl) ethanethioate **123** (0.034 g, 0.3 mmol) and thioacetic acid (0.023 mL, 0.33 mmol) were dissolved in 1,1,1,3,3,3-hexafluoro-2-propanol (6 mL). The solution was pumped through the electrochemical reactor (0.205 mL inner volume; 16 mA; 2 F/mol, 14-16V) using a syringe pump (0.1 mL/min). After reaching the steady state, the solution was collected for 50 minutes. The outlet was quenched with aqueous saturated NaHCO_3 (5 mL), extracted with diethyl ether (3 x 5 mL) and washed with brine. The combined extracts were dried over anhydrous MgSO_4 and the solvent evaporated *in vacuo*. The product was purified by preparative TLC (hexane/diethyl ether, 8:2), giving compound **96** (0.025 g, 52 % yield, d.r. *E/Z* = 1:1.36) as a pale-yellow oil.

6.5.3. Selective substitution of the bis-thioacetate

(E/Z)-*S*-(3-(allyldisulfanyl)allyl) ethanethioate (**126**):

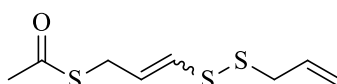

E-isomer: $^1\text{H NMR}$ (400 MHz, CDCl_3): δ = 2.34 (s, 3H, CH_3), 3.30 – 3.33 (m, 2H, $\text{CH}_2\text{CH}=\text{CH}_2$), 3.58 (dd, J = 7.4, 1.1 Hz, 2H, $\text{CH}_2\text{CH}=\text{CH}$), 5.11 – 5.22 (m, 2H, $\text{CH}_2\text{CH}=\text{CH}_2$), 5.77 – 5.88 (m, 2H, $\text{CH}_2\text{CH}=\text{CH}_2$ and $\text{CH}_2\text{CH}=\text{CH}$), 6.23 (dt, J = 14.7, 1.1 Hz, 1H, $\text{CH}_2\text{CH}=\text{CH}$). $^{13}\text{C NMR}$ (100 MHz, CDCl_3): δ = 30.5 (CH_3), 30.8 ($\text{CH}_2\text{CH}=\text{CH}$), 41.2 ($\text{CH}_2\text{CH}=\text{CH}_2$), 119.0 ($\text{CH}_2\text{CH}=\text{CH}_2$), 125.9 ($\text{CH}_2\text{CH}=\text{CH}$), 129.2 ($\text{CH}_2\text{CH}=\text{CH}$), 132.7 ($\text{CH}_2\text{CH}=\text{CH}_2$), 194.9 (C=O) ppm. HRMS (ASAP): $[\text{M}+\text{H}]^+$ calc. 221.0128, found 221.0130 $[\text{C}_8\text{H}_{12}\text{OS}_3]^+$. IR (neat): 1685, 1352, 1130, 1105, 918, 621 cm^{-1} .

Z-isomer: $^1\text{H NMR}$ (400 MHz, CDCl_3): δ = 2.34 (s, 3H, CH_3), 3.34 – 3.37 (m, 2H, $\text{CH}_2\text{CH}=\text{CH}_2$), 3.65 (dd, J = 7.8, 0.9 Hz, 2H, $\text{CH}_2\text{CH}=\text{CH}$), 5.11 – 5.22 (m, 2H,

$\text{CH}_2\text{CH}=\text{CH}_2$), 5.63 (dt, $J = 9.2, 7.8$ Hz, 1H, $\text{CH}_2\text{CH}=\text{CH}$), 5.77 – 5.88 (m, 1H, $\text{CH}_2\text{CH}=\text{CH}_2$), 6.21 (dt, $J = 9.2, 1.0$ Hz, 1H, $\text{CH}_2\text{CH}=\text{CH}$) ppm. ^{13}C NMR (100 MHz, CDCl_3): $\delta = 27.3$ ($\text{CH}_2\text{CH}=\text{CH}$), 30.4 (CH_3), 42.0 ($\text{CH}_2\text{CH}=\text{CH}_2$), 119.1 ($\text{CH}_2\text{CH}=\text{CH}_2$), 126.6 ($\text{CH}_2\text{CH}=\text{CH}$), 132.7 ($\text{CH}_2\text{CH}=\text{CH}_2$), 132.9 ($\text{CH}_2\text{CH}=\text{CH}$), 195.2 (C=O) ppm. HRMS (ASAP): $[\text{M}+\text{H}]^+$ calc. 221.0128, found 221.0130 $[\text{C}_8\text{H}_{12}\text{OS}_3]^+$. IR (neat): 1685, 1352, 1130, 1105, 918, 621 cm^{-1} .

Batch procedure:

The vinyl thioacetate **124** (50 mg, 0.26 mmol) was dissolved in degassed CH_3OH (0.25 mL) and the solution was cooled to -40 °C and stirred under N_2 . Then, KOH (15 mg, 0.48 mmol) dissolved in degassed methanol (0.25 mL) or Cs_2CO_3 (87 mg, 0.26 mmol) was added followed by the immediate addition of *S*-allyl 4-methylbenzenesulfonothioate (73 mg, 0.26 mmol) in CH_2Cl_2 (0.25 mL). The reaction was left stirring for 45 minutes at -40 °C, after which it was warmed up to rt for 3h. The reaction was quenched with saturated ammonium chloride (5 mL), the solvents removed under vacuum on the rotary evaporator, and the resulting residue extracted with CH_2Cl_2 (3 x 10 mL). The combined extracts were washed with brine (2 x 10 mL) and dried over MgSO_4 . The solvent was removed under vacuum and the resulting residue purified by preparative TLC (hexane/diethyl ether, 9.5:0.5) to give compound **97** as a mixture of *E/Z* diastereomers (KOH: 25 mg, 43% yield, *d.r.* *E/Z* = 0.35:1; Cs_2CO_3 : 56 % yield, *d.r.* *E/Z* = 0.35:1.0) as a pale-yellow oil.

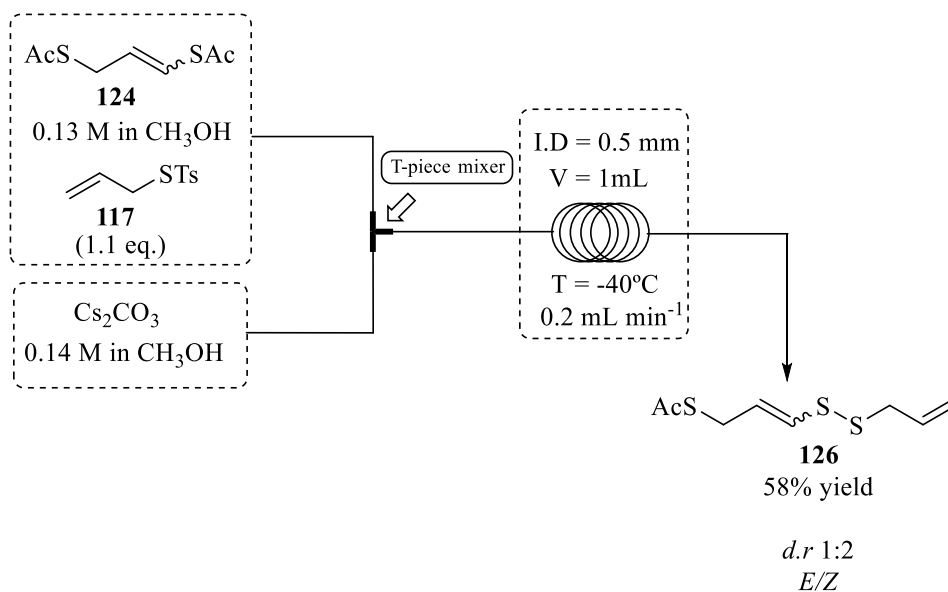
Flow chemistry procedure:

(*E/Z*)-*S,S'*-(prop-1-ene-1,3-diyl) diethanethioate **124** (0.050 g, 0.26 mL), *S*-allyl 4-methylbenzenesulfonothioate (0.080 g, 0.29 mmol) were dissolved in a mixture of methanol/dichloromethane (1:1, 2 mL) and a 4 mL syringe was loaded with the mixture. Then, caesium carbonate (0.089 mg, 0.27 mmol) was dissolved in methanol (2 mL) and another 4 mL syringe was loaded with this solution. The two syringes were connected to a flow set-up with a T-piece mixer and a 1 mL PTFE coil. The solutions were pumped through a flow reactor with a flow rate of 0.2 mL/min. After reaching the steady state, the solution was collected for 30 min. The outlet was quenched with aqueous saturated NaHCO₃, extracted with diethyl ether (3 x 5 mL) and washed with brine. The combined organic layers were dried over anhydrous MgSO₄. After evaporating the solvent *in vacuo*, the product was purified by preparative TLC (hexane/diethyl ether, 9:1) to give compound **126** as a mixture of *E/Z* diastereomers (31 mg, 58% yield, d.r. *E/Z* = 1:2) as a pale-yellow oil.

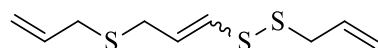
(*E/Z*)-1-allyl-2-(3-(allylthio)prop-1-en-1-yl)disulfane (127):

E-isomer: ^1H NMR (400 MHz, CDCl_3): δ = 3.30 – 3.32 (m, 2H, $\text{CH}_2\text{CH}=\text{CH}_2$), 3.33 (dt, J = 7.2, 1.2 Hz, 2H, $\text{CH}_2\text{CH}=\text{CH}_2$), 3.37 (dd, J = 7.7, 1.0 Hz, 2H, $\text{CH}_2\text{CH}=\text{CH}$), 5.11 – 5.22 (m, 4H, $\text{CH}_2\text{CH}=\text{CH}_2$, $\text{CH}_2\text{CH}=\text{CH}_2$), 5.60 (dt, J = 15.1, 7.7 Hz, 1H, $\text{CH}_2\text{CH}=\text{CH}$), 5.77 – 5.94 (m, 2H, $\text{CH}_2\text{CH}=\text{CH}_2$, $\text{CH}_2\text{CH}=\text{CH}_2$), 6.12 (dt, J = 15.1, 1.0 Hz, 1H, $\text{CH}_2\text{CH}=\text{CH}$) ppm. ^{13}C NMR (100 MHz, CDCl_3): δ = 35.7 ($\text{CH}_2\text{CH}=\text{CH}_2$), 42.1 ($\text{CH}_2\text{CH}=\text{CH}$), 42.7 ($\text{CH}_2\text{CH}=\text{CH}_2$), 117.9 ($\text{CH}_2\text{CH}=\text{CH}_2$), 118.6 ($\text{CH}_2\text{CH}=\text{CH}_2$), 123.5 ($\text{CH}_2\text{CH}=\text{CH}$), 127.7 ($\text{CH}_2\text{CH}=\text{CH}$), 133.5 ($\text{CH}_2\text{CH}=\text{CH}_2$), 133.6 ($\text{CH}_2\text{CH}=\text{CH}_2$) ppm. HRMS (ASAP): $[\text{M}+\text{H}]^+$ calc. 219.0336, found 219.0336 $[\text{C}_6\text{H}_{15}\text{S}_3]^+$. IR (neat): 3080, 2978, 2912, 1633, 1423, 1205, 985, 916, 756 cm^{-1} .

Z-isomer: ^1H NMR (400 MHz, CDCl_3): δ = 3.30 – 3.32 (m, 2H, $\text{CH}_2\text{CH}=\text{CH}_2$), 3.37 (dt, J = 7.4, 1.0 Hz, 2H, $\text{CH}_2\text{CH}=\text{CH}_2$), 3.50 (dd, J = 7.8, 0.9 Hz, 2H, $\text{CH}_2\text{CH}=\text{CH}$), 5.11 – 5.22 (m, 4H, $\text{CH}_2\text{CH}=\text{CH}_2$, $\text{CH}_2\text{CH}=\text{CH}_2$), 5.70 (dt, J = 9.5, 0.9 Hz, 1H, $\text{CH}_2\text{CH}=\text{CH}$), 5.77 – 5.94 (m, 2H, $\text{CH}_2\text{CH}=\text{CH}_2$, $\text{CH}_2\text{CH}=\text{CH}_2$), 6.15 (dt, J = 9.5, 0.9 Hz, 1H, $\text{CH}_2\text{CH}=\text{CH}$) ppm. ^{13}C NMR (100 MHz, CDCl_3): δ = 36.8 ($\text{CH}_2\text{CH}=\text{CH}_2$), 37.5 ($\text{CH}_2\text{CH}=\text{CH}$), 42.3 ($\text{CH}_2\text{CH}=\text{CH}_2$), 117.8 ($\text{CH}_2\text{CH}=\text{CH}_2$), 118.7 ($\text{CH}_2\text{CH}=\text{CH}_2$), 124.5 ($\text{CH}_2\text{CH}=\text{CH}$), 128.9 ($\text{CH}_2\text{CH}=\text{CH}$), 133.5 ($\text{CH}_2\text{CH}=\text{CH}_2$), 134.1 ($\text{CH}_2\text{CH}=\text{CH}_2$) ppm. HRMS (ASAP): $[\text{M}+\text{H}]^+$ calc. 219.0336, found 219.0336 $[\text{C}_6\text{H}_{15}\text{S}_3]^+$. IR (neat): 3080, 2978, 2912, 1633, 1423, 1205, 985, 916, 756 cm^{-1} .

Batch Procedure:

The vinyl thioacetate **126** (50 mg, 0.26 mmol) was dissolved in degassed CH_3OH (0.25 mL) and the solution was cooled to $-40\text{ }^\circ\text{C}$ and stirred under N_2 . Then, Cs_2CO_3 (87 mg, 0.26 mmol) was added followed by the immediate addition of allyl bromide (0.022 mL, 0.26 mmol). The reaction was left stirring for 45 minutes at $-40\text{ }^\circ\text{C}$, after which it was warmed up to rt for 3h. The reaction was quenched with saturated ammonium chloride (5 mL), the solvents were removed under vacuum on the rotary evaporator, and the resulting residue extracted with CH_2Cl_2 (3 x 10 mL). The combined extracts were washed with brine (2 x 10 mL) and dried over MgSO_4 . The solvent was removed under vacuum and the resulting residue purified by preparative TLC (hexane/diethyl ether, 9:1) to give

compound **127** as a mixture of *E/Z* diastereomers (47 % yield, *d.r.* *E/Z* = 1:2) as a yellow oil.

Flow procedure:

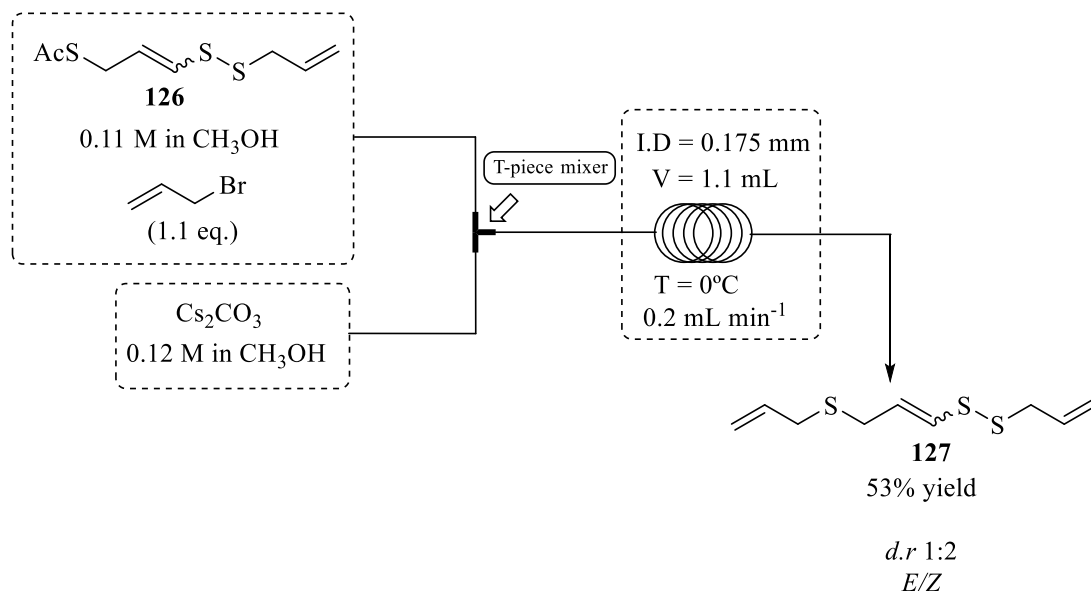

(*E/Z*)-*S*-(3-(allyldisulfanyl)allyl) ethanethioate **126** (0.100 g, 0.45 mmol), allyl bromide (0.042 mL, 0.49 mmol) were dissolved in degassed methanol and a 4 mL syringe was loaded with the mixture. Then, caesium carbonate (0.154 mg, 0.47 mmol) was dissolved in methanol (4 mL) and another 4 mL syringe was loaded with this solution. The two syringes were connected to a flow set-up with a T-piece mixer and a 1 mL PTFE coil. The solutions were pumped through a flow reactor with a flow rate of 0.2 mL/min. After reaching the steady state, the solution was collected for 30 min. The outlet was quenched with aqueous saturated NaHCO₃, extracted with diethyl ether (3 x 10 mL) and washed with brine. The combined organic layers were dried over anhydrous MgSO₄. After evaporating the solvent *in vacuo*, the product was purified by preparative TLC (hexane/diethyl ether, 9:1) to give compound **127** as a mixture of *E/Z* diastereomers (39 mg, 53% yield, *d.r.* *E/Z* = 1:2) as a pale-yellow oil.

6.5.4. Oxidation of compound 127

(*E/Z*)-1-allyl-2-(3-(allylsulfinyl)prop-1-en-1-yl)disulfane “Ajoene” (**21**):

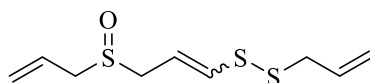

(*E/Z*)-1-allyl-2-(3-(allylthio)prop-1-en-1-yl)disulfane **21** (0.025g, 0.11 mmol) dissolved in CH₂Cl₂ (1 mL) was cooled to -78 °C under N₂, and *m*-CPBA (0.022 g, 0.12 mmol) was added in one portion. The reaction proceeded for 1 h at -78 °C and before being warmed up to r.t. After 2 hours, saturated NaHCO₃ aqueous solution (1 mL) was added and the residue was extracted with CH₂Cl₂ (3×2 mL). The combined fractions were washed with brine (2×2 mL) and dried over Mg₂SO₄. The solvent was removed under vacuum and the resulting residue was purified by preparative TLC (hexane/diethyl ether, 1:9) to give compound ajoene **23** as a mixture of *E/Z* diastereomers (22 mg, 89% yield, *d.r.* *E/Z* = 1:2) as a pale-yellow oil.

E-isomer: ¹H NMR (400 MHz, CDCl₃): δ = 3.29 (d, *J* = 7.6 Hz, 2H, CH₂CH=CH₂), 3.26 – 3.54 (m, 4H, CH₂CH=CH₂, CH₂CH=CH), 5.11 – 5.19 (m, 2H, CH₂CH=CH₂), 5.27 – 5.44 (m, 2H, CH₂CH=CH₂), 5.69 – 5.93 (m, 3H, CH₂CH=CH₂, CH₂CH=CH and CH₂CH=CH₂), 6.31 (d, *J* = 14.8 Hz, 1H, CH₂CH=CH) ppm. ¹³C NMR (100 MHz, CDCl₃): δ = 41.3 (CH₂), 52.9 (CH₂), 54.4 (CH₂), 116.8 (CH₂CH=CH), 119.3 (CH₂CH=CH₂), 123.7 (CH₂CH=CH₂), 125.6 (CH₂CH=CH₂), 132.4 (CH₂CH=CH₂), 134.7 (CH₂CH=CH) ppm. Spectra in accordance with the literature.^[3]

Z-isomer: ¹H NMR (400 MHz, CDCl₃): δ = 3.37 (d, *J* = 7.3 Hz, 2H, CH₂CH=CH₂), 3.39 – 3.67 (m, 4H, CH₂CH=CH₂, CH₂CH=CH), 5.11 – 5.24 (m, 2H, CH₂CH=CH₂), 5.35 – 5.50 (m, 2H, CH₂CH=CH₂), 5.69 – 5.99 (m, 3H, CH₂CH=CH₂, CH₂CH=CH and CH₂CH=CH₂), 6.56 (d, *J* = 9.5 Hz, 1H, CH₂CH=CH) ppm. ¹³C NMR (100 MHz, CDCl₃): δ = 42.1 (CH₂), 49.6 (CH₂), 54.9 (CH₂), 118.0 (CH₂CH=CH), 119.3 (CH₂CH=CH₂), 123.7 (CH₂CH=CH₂), 125.6 (CH₂CH=CH₂), 132.6 (CH₂CH=CH₂), 138.6 (CH₂CH=CH) ppm. IR (neat): 1037, 931, 733 cm⁻¹. Spectra in accordance with the literature.^[3]

6.6. Experimental data for Chapter 5: Selective oxidation of sulfides in flow chemistry

6.6.1. Fixed Bed Column Preparation

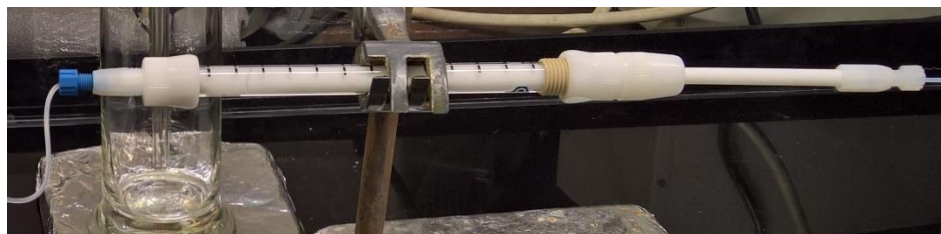

Figure 6.1 Omni-Fit column packed with Oxone

Oxone was ground with a mortar and pestle. After inserting the end-cap (with a 10–40 μm filter) into a 150 mm Omni-Fit column (6.6 mm ID), the oxone (5.6 g, 9.1 mmol) was packed by tapping on the benchtop and priming with solvent. The column was sealed with an end-cap. The column was further packed by flowing CH_2Cl_2 through the column at 1 mL/min until no air bubbles were observed. The column volume, averaging 2.4 mL, was determined from the difference between the anhydrous and wet weights divided by the density of the solvent (CH_2Cl_2).

6.6.2. General Procedure for oxidation of sulfides and disulfides

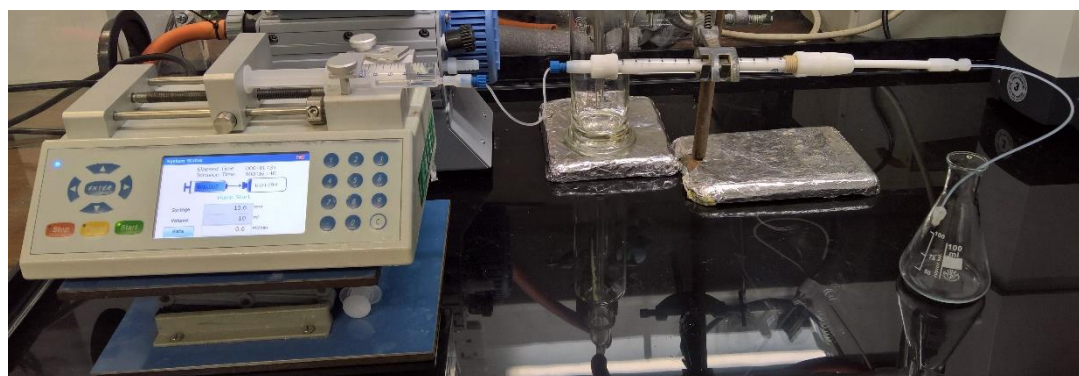

Figure 6.2. Flow set-up for the oxidation of sulfides and disulfides

Sulfide (2 mmol) dissolved in a solution of 15 vol% CF_3COOH in CH_2Cl_2 (10 mL, 0.2 M). After flushing the column with CH_2Cl_2 , the reagent solution was pumped through the column with a flow rate of 0.6 mL/min by using Vapourtec E-series equipment (with a peristaltic pump). Alternatively, a syringe pump can be used. After reaching the steady state, the solution was collected for 10 min. The solution was washed with saturated solution of NaHCO_3 (x 5 mL), dried over MgSO_4 , filtered, and the solvent was removed

in vacuo. The crude mixture was loaded onto a Biotage Snap Ultra 10g Flash Column (15 mL column volume). The gradient was performed 20% ethyl acetate for 3 CV and held at 20 % ethyl acetate for 5CV.

Disulfide (0.25 mmol) dissolved in a solution of 10 vol% CF₃COOH in CH₂Cl₂ (10 mL, 0.025 M). After flushing the column with CH₂Cl₂, the reagent solution was pumped through the column with a flow rate of 0.6 mL/min by using a syringe pump. After reaching the steady state, the solution was collected for 10 min. The solution was washed with saturated solution of NaHCO₃ (x 5 mL), dried over MgSO₄, filtered, and the solvent was removed in vacuo. The crude mixture was loaded onto a Biotage Snap Ultra 10g Flash Column (15 mL column volume). The gradient was performed 20% ethyl acetate for 3CV, then 30% ethyl acetate for 3 CV and held at 30 % ethyl acetate for 3 CV.

Methyl phenyl sulfoxide (138a):

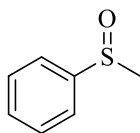

Synthesized according to the general procedure using **137a**; **138a** (98 % yield, 0.164 g, 1.18 mmol) was obtained as a clear oil.

¹H NMR (300 MHz, CDCl₃): δ = 2.66 (s, 3H, CH₃), 7.41 – 7.51 (m, 3H, ArH), 7.55 – 7.62 (m, 2H, ArH) ppm. ¹³C NMR (75 MHz, CDCl₃): δ = 43.9 (CH₃), 123.4 (C_{Ar}H), 129.3 (C_{Ar}H), 130.9 (C_{Ar}H), 145.6 (C_{Ar}) ppm. IR (neat): 3054, 2996, 2911, 1657, 1035, 958 cm⁻¹. Spectroscopic data in agreement with literature.^[10]

***p*-Chlorophenyl methyl sulfoxide (138b):**

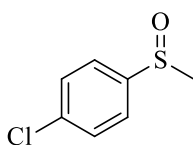

Synthesized according to the general procedure using **137b**; **138b** (94 % yield, 0.196 g, 1.13 mmol) was obtained as a clear oil.

¹H NMR (300 MHz, CDCl₃): δ = 2.63 (s, 3H, CH₃), 7.36 – 7.44 (m, 2H, ArH), 7.48 – 7.55 (m, 2H, ArH) ppm; ¹³C NMR (75 MHz, CDCl₃): δ = 43.8 (CH₃), 124.8 (C_{Ar}H), 129.4 (C_{Ar}H), 136.9 (C_{Ar}H), 144.0 (C_{Ar}H) ppm. IR (neat): 1475, 1039, 950, 738 cm⁻¹. Spectroscopic data in agreement with literature.^[11]

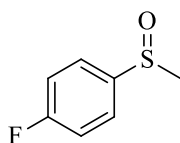
***p*-Fluorophenyl methyl sulfoxide (138c):**

Synthesized according to the general procedure using **137c**; **138c** (94 % yield, 0.178 g, 1.13 mmol) was obtained as a clear oil.

^1H NMR (300 MHz, CDCl_3): δ = 2.69 (s, 3H, CH_3), 7.05 – 7.29 (m, 2H, ArH), 7.59 – 7.66 (m, 2H, ArH) ppm; ^{13}C NMR (75 MHz, CDCl_3): δ = 44.1 (CH_3), 116.7 (d, J = 22.5 Hz, C_{ArH}), 125.9 (d, J = 8.9 Hz, C_{ArH}), 141.0 (d, J = 3.1 Hz, C_{Ar}), 164.3 (d, J = 251.4 Hz, C_{Ar}) ppm. IR (neat): 1490, 1219, 1031, 831 cm^{-1} . Spectroscopic data in agreement with literature.^[12]

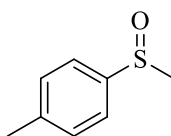
Methyl *p*-methylphenyl sulfoxide (138d):

Synthesized according to the general procedure using **137d**; **138d** (90 % yield, 0.166 g, 1.08 mmol) was obtained as a white solid.

^1H NMR (300 MHz, CDCl_3): δ = 2.40 (s, 3H, CH_3), 2.69 (s, 3H, CH_3), 7.31 (d, J = 8.0 Hz, 2H, ArH), 7.52 (d, J = 8.0 Hz, 2H, ArH) ppm; ^{13}C NMR (75 MHz, CDCl_3): δ = 21.5 (CH_3), 44.1 (CH_3), 123.6 (C_{ArH}), 130.1 (C_{ArH}), 141.6 (C_{Ar}), 142.5 (C_{Ar}) ppm. IR (neat): 1494, 1033, 808 cm^{-1} . Spectroscopic data in agreement with literature.^[13]

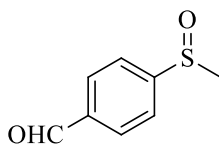
***p*-Formylphenyl methyl sulfoxide (138e):**

Synthesized according to the general procedure using **137e**; **138e** (91 % yield, 0.183 g, 1.09 mmol) was obtained as a white solid.

^1H NMR (300 MHz, CDCl_3): δ = 2.74 (s, 3H, CH_3), 7.78 (d, J = 8.4 Hz, 2H, ArH), 8.00 (d, J = 8.4 Hz, 2H, ArH), 10.04 (s, 1H, CHO) ppm; ^{13}C NMR (75 MHz, CDCl_3): δ = 43.8 (CH_3), 124.2 (C_{ArH}), 130.4 (C_{ArH}), 138.1 (C_{Ar}), 152.4 (C_{Ar}), 191.2 (CHO) ppm. IR (neat): 1700, 1041, 813 cm^{-1} . Spectroscopic data in agreement with literature.^[12]

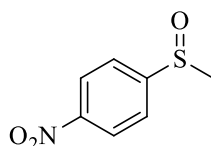
***p*-Nitrophenyl methyl sulfoxide (138f):**

Synthesized according to the general procedure using **137f**; **138f** (92 % yield, 0.200 g, 1.10 mmol) was obtained as a white solid.

^1H NMR (300 MHz, CDCl_3): δ = 2.78 (s, 3H, CH_3), 7.83 (d, J = 8.8 Hz, 2H, ArH), 8.38 (d, J = 8.7 Hz, 2H, ArH) ppm; ^{13}C NMR (75 MHz, CDCl_3): δ = 43.9 (CH_3), 124.6 (C_{ArH}), 124.7 (C_{ArH}), 149.5 (C_{Ar}), 153.3 (C_{Ar}) ppm. IR (neat): 1516, 1340, 1045, 960, 740 cm^{-1} . Spectroscopic data in agreement with literature.^[12]

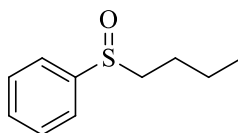
***n*-Butyl phenyl sulfoxide (138g):**

Synthesized according to the general procedure using **137g**; **138g** (89 % yield, 0.182 g, 1.06 mmol) was obtained as a clear oil.

^1H NMR (300 MHz, CDCl_3): $\delta = 0.91$ (t, $J = 7.2$ Hz, 2H, CH_3), 1.38 – 1.78 (m, 4H, CH_2) 2.78 (t, $J = 7.7$ Hz, 2H, CH_2), 7.50 – 7.62 (m, 5H, ArH), ppm; ^{13}C NMR (75 MHz, CDCl_3): $\delta = 13.8$ (CH_3), 22.0 (CH_2), 24.3 (CH_2), 57.2 (CH_2), 124.1 (C_{ArH}), 129.3 (C_{ArH}), 131.0 (C_{Ar}), 144.1 (C_{Ar}) ppm. IR (neat): 1442, 1031, 748 cm^{-1} . Spectroscopic data in agreement with literature.^[14]

Benzyl phenyl sulfoxide (138h):

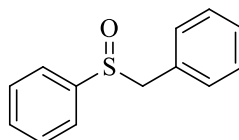

Synthesized according to the general procedure using **137h**; **138h** (95 % yield, 0.246 g, 1.14 mmol) was obtained as a white solid.

^1H NMR (300 MHz, CDCl_3): $\delta = 3.91$ (ABq, $J_{\text{AB}} = 12.6$ Hz, 1H, CH_2), 4.00 (ABq, $J_{\text{AB}} = 12.6$ Hz, 1H, CH_2), 6.84 – 6.93 (m, 2H, ArH), 7.09 – 7.24 (m, 3H, ArH), 7.27 – 7.46 (m, 5H, ArH) ppm; ^{13}C NMR (75 MHz, CDCl_3): $\delta = 63.6$ (CH_2), 124.5 (C_{ArH}), 128.3 (C_{Ar}), 128.5 (C_{ArH}), 128.9 (C_{ArH}), 129.1 (C_{Ar}), 130.4 (C_{ArH}), 131.2 (C_{Ar}), 142.8 (C_{Ar}) ppm. IR (neat): 3059, 2960, 1033, 893 cm^{-1} . Spectroscopic data in agreement with literature.^[15]

Allyl phenyl sulfoxide (138i):

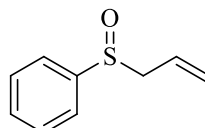

Synthesized according to the general procedure using **137i**; **138i** (89 % yield, 0.166 g, 1.14 mmol) was obtained as a clear oil.

^1H NMR (300 MHz, CDCl_3): $\delta = 3.50$ (qd, $J = 12.8, 7.5$ Hz, 2H, CH_2), 5.15 (dd, $J = 17.1, 1.3$ Hz, 1H, $\text{CH}=\text{CH}_2$), 5.28 (d, $J = 10.2$ Hz, 1H, $\text{CH}=\text{CH}_2$), 5.60 (ddt, $J = 17.6, 10.2, 7.5$ Hz, 1H, $\text{CH}=\text{CH}_2$), 7.50 – 7.54 (m, 3H, ArH), 7.58 – 7.62 (m, 2H, ArH) ppm; ^{13}C NMR (75 MHz, CDCl_3): $\delta = 61.0$ (CH_3), 124.0 ($\text{CH}_2\text{CH}=\text{CH}_2$), 124.5 (C_{ArH}), 125.4 ($\text{CH}_2\text{CH}=\text{CH}_2$), 129.2 (C_{ArH}), 131.2 (C_{ArH}), 143.1 (C_{Ar}) ppm. IR (neat): 1443, 1037, 748, 690 cm^{-1} . Spectroscopic data are in agreement with literature.^[12]

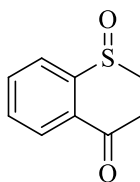
Thiochroman-4-one 1-oxide (138j):

Synthesized according to the general procedure using **137j**; **138j** (93 % yield, 0.201 g, 1.12 mmol) was obtained as a yellow oil.

^1H NMR (300 MHz, CDCl_3): δ = 2.62 – 2.89 (m, 1H, $\text{S}(\text{O})\text{CH}$), 3.18 – 3.50 (m, 3H, $\text{C}(\text{O})\text{CH}_2$, $\text{S}(\text{O})\text{CH}$), 7.54 (td, J = 7.5, 1.5 Hz, 1H, ArH), 7.65 (td, J = 7.5, 1.5 Hz, 1H, ArH), 7.78 (dd, J = 7.7, 1.2 Hz, 1H, ArH), 8.01 (dd, J = 7.7, 1.2 Hz, 1H, ArH) ppm; ^{13}C NMR (75 MHz, CDCl_3): δ = 30.1 (CH_2), 46.4 (CH_2), 128.3(C_{ArH}), 128.7(C_{ArH}), 128.9 (C_{ArH}), 131.9 (C_{ArH}), 134.4 (C_{ArH}), 145.2 (C_{ArH}), 191.9 ($\text{C}=\text{O}$), ppm. IR (neat): 1685, 1281, 1031, 733 cm^{-1} . Spectroscopic data in agreement with literature.^[12]

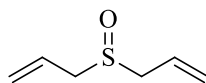
Diallyl sulfoxide (138k):

Synthesized according to the general procedure using **137k**; **138k** (92 % yield, 0.144 g, 1.10 mmol) was obtained as a clear oil.

^1H NMR (300 MHz, CDCl_3): δ = 3.66 (qd, J = 13.2, 7.5 Hz, 2H, $\text{CH}_2\text{CH}=\text{CH}_2$), 5.60 (ddt, J = 17.6, 10.2, 7.5 Hz, 1H, $\text{CH}_2\text{CH}=\text{CH}_2$), 5.41 – 5.62 (m, 1H, $\text{CH}_2\text{CH}=\text{CH}_2$), 5.87 (ddt, J = 17.5, 10.2, 7.4 Hz, 1H, $\text{CH}_2\text{CH}=\text{CH}_2$) ppm; ^{13}C NMR (75 MHz, CDCl_3): δ = 52.7 ($\text{CH}_2\text{CH}=\text{CH}_2$), 124.2 ($\text{CH}_2\text{CH}=\text{CH}_2$), 125.6 ($\text{CH}_2\text{CH}=\text{CH}_2$) ppm. IR (neat): 1635, 1028, 924 cm^{-1} . Spectroscopic data in agreement with literature.^[11]

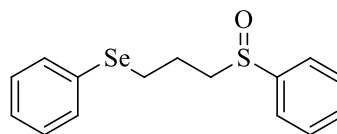
Phenyl(3-(phenylsulfinyl)propyl)selane (138l):

Synthesized according to the general procedure using **118l**; **119l** (76 % yield, 0.295 g, 0.91 mmol) was obtained as a clear oil.

^1H NMR (300 MHz, CDCl_3): δ = 1.81 – 1.92 (m, 1H, $\text{CH}_2\text{CH}_2\text{CH}_2$), 1.98 – 2.18 (m, 1H, $\text{CH}_2\text{CH}_2\text{CH}_2$), 2.77 (ddd, J = 13.2, 9.0, 5.3 Hz, 1H, SeCH_2), 2.83 – 2.96 (m, 3H, S(O)CH_2), 7.29 – 7.39 (m, 2H, ArH), 7.36 – 7.44 (m, 3H, ArH), 7.40 – 7.53 (m, 2H, ArH) ppm; ^{13}C NMR (75 MHz, CDCl_3): δ = 22.5 ($\text{CH}_2\text{CH}_2\text{CH}_2$), 26.5 (SeCH_2), 56.3 (S(O)CH_2), 123.9 (C_{ArH}), 127.3 (C_{ArH}), 129.1 (C_{ArSe}), 129.2 (C_{ArH}), 129.2 (C_{ArH}), 130.9 (C_{ArH}), 133.1 (C_{ArH}), 143.5 ($\text{C}_{\text{ArS(O)}}$) ppm. IR (neat): 1477, 1438, 1037, 734, 688 cm^{-1} . HRMS (ESI): $[\text{M}+\text{H}]^+$ calc. 325.0165, found 325.0173 [$\text{C}_{15}\text{H}_{17}\text{OSSe}$] $^+$.

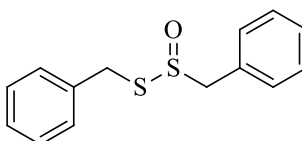
S-Benzyl phenylmethanesulfinothioate (140a):

Synthesized according to the general procedure using **139a**; **140a** (91 % yield, 0.286 g, 1.09 mmol) was obtained as a white solid.

^1H NMR (400 MHz, CDCl_3): δ = 4.24 – 4.35 (m, 4H, CH_2), 7.26 – 7.38 (m, 10H, ArH) ppm; ^{13}C NMR (75 MHz, CDCl_3): δ = 36.3 (SCH_2), 62.27 (S(O)CH_2), 127.9 (C_{ArH}), 128.8 (C_{ArH}), 128.9 (C_{ArH}), 129.2 (C_{ArH}), 130.0 (C_{ArS}), 130.5 (C_{ArH}), 136.7 ($\text{C}_{\text{ArS(O)}}$) ppm. IR (neat): 1055, 761, 692, 470 cm^{-1} . Spectroscopic data are in agreement with the literature.^[16]

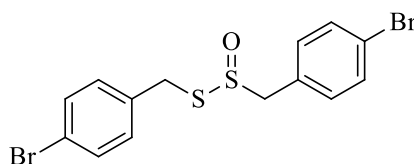
S-(4-Bromobenzyl) (4-bromophenyl)methanesulfinothioate (140b):

Synthesized according to the general procedure using **139a**; **140b** (89 % yield, 0.449 g, 1.07 mmol) was obtained as a clear oil.

^1H NMR (400 MHz, CDCl_3): δ = 4.15 (ABq, J_{AB} = 12.0 Hz, 1H, S(O)CH_2), 4.22 (s, 2H, SCH_2), 4.31 (ABq, J_{AB} = 12.0 Hz, 1H, S(O)CH_2), 7.16 (d, J = 5.1 HZ, 1H, ArH), 7.18 (d, J = 5.1 Hz, 2H, ArH), 7.44 (d, J = 8.4 Hz, 2H, ArH), 7.50 (d, J = 8.5 Hz, 2H, ArH) ppm; ^{13}C NMR (75 MHz, CDCl_3): δ = 35.8 (SCH_2), 61.4 (S(O)CH_2), 122.0 (C_{Ar}), 123.4 (C_{Ar}), 128.8 (S_{Ar}), 130.9 (C_{ArH}), 132.0 (C_{ArH}), 132.1 (C_{ArH}), 132.2 (C_{ArH}), 135.8 (S(O)C_{Ar}) ppm. IR (neat): 1066, 902, 725, 650 cm^{-1} . HRMS (ESI): $[\text{M}+\text{H}]^+$ calc. 418.8597, found 418.8599 [$\text{C}_{14}\text{H}_{13}\text{Br}_2\text{OS}_2$] $^+$.

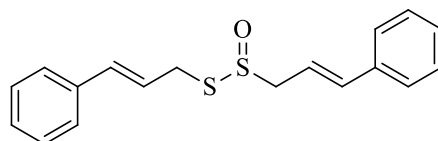
S-cinnamyl (*E*)-3-phenylprop-2-ene-1-sulfinothioate (140c)

Synthesized according to the general procedure using **139c**; **140c** (69 % yield, 0.260 g, 0.83 mmol) was obtained as a clear oil.

^1H NMR (400 MHz, CDCl_3): δ = 3.89 – 4.07 (m, 4H, CH_2), 6.23 – 6.35 (m, 2H, $\text{SCH}_2\text{CH}=\text{CH}$, $\text{S(O)CH}_2\text{CH}=\text{CH}$), 6.63 (d, J = 15.7 Hz, 1H, $\text{SCH}_2\text{CH}=\text{CH}$), 6.72 (d, J = 15.7 Hz, 1H, $\text{S(O)CH}_2\text{CH}=\text{CH}$), 7.42 – 7.25 (m, 10H, ArH) ppm; ^{13}C NMR (75 MHz, CDCl_3): δ = 35.1 (SCH_2), 59.9 (S(O)CH_2), 116.9 ($\text{CH}_2\text{CH}=\text{CH}$), 124.2 ($\text{CH}_2\text{CH}=\text{CH}$), 126.9 (C_{ArH}), 127.0 (C_{ArH}), 128.3 (C_{ArH}), 128.7 (C_{ArH}), 128.9 (C_{ArH}), 129.0 (C_{ArH}), 134.4 ($\text{CH}_2\text{CH}=\text{CH}$), 136.2 ($\text{CH}_2\text{CH}=\text{CH}$), 136.4 (C_{Ar}), 138.8 (C_{Ar}) ppm. IR (neat): 1510, 1249, 1028, 833 cm^{-1} .

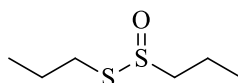
***n*-Propyl propane-1-sulfinothioate (140d):**

Synthesized according to the general procedure using **139d**; **140d** (72 % yield, 0.144 g, 0.86 mmol) was obtained as a clear oil.

^1H NMR (400 MHz, CDCl_3): δ = 1.04 (t, J = 7.3 Hz, 3H, SCH_3), 1.09 (t, J = 7.4 Hz, 3H, S(O)CH_3), 1.77 – 1.92 (m, 4H, CH_2), 3.03 – 3.19 (m, 4H, CH_2), ppm; ^{13}C NMR (75 MHz, CDCl_3): δ = 13.1 (CH_3), 13.2 (CH_3), 17.2 (CH_2), 24.3 (CH_2), 34.9 (SCH_3), 58.0 (S(O)CH_3) ppm. IR (neat): 1078, 720 cm^{-1} . Spectroscopic data in agreement with the literature.^[16]

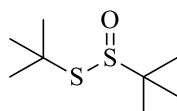
***S*-(*tert*-Butyl) 2-methylpropane-2-sulfinothioate (140e):**

Synthesized according to the general procedure using **139e**; **140e** (59 % yield, 0.138 g, 0.71 mmol) was obtained as a clear oil.

^1H NMR (400 MHz, CDCl_3): δ = 1.37 (s, 9H, CH_3), 1.55 (s, 9H, CH_3), ppm; ^{13}C NMR (75 MHz, CDCl_3): δ = 24.2 (CH_3), 32.3 (CH_3), 48.6 ($\text{SC}(\text{CH}_3)_3$), 59.4 ($\text{SOC}(\text{CH}_3)_3$) ppm. IR (neat): 1070, 513 cm^{-1} . Spectroscopic data in agreement with the literature.^[16]

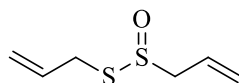
***S*-Allyl prop-2-ene-1-sulfinothioate (140f):**

Synthesized according to the general procedure using **139f**; **140f** (74 % yield, 0.144 g, 0.89 mmol) was obtained as a pale-yellow oil.

^1H NMR (400 MHz, CDCl_3): δ = 3.71 – 3.89 (m, 4H, CH_2), 5.48 – 5.19 (m, 4H, $\text{CH}_2\text{CH}=\text{CH}_2$), 5.87 – 6.00 (m, 2H, $\text{CH}_2\text{CH}=\text{CH}_2$) ppm; ^{13}C NMR (75 MHz, CDCl_3): δ = 35.1 (SCH_2), 59.9 (S(O)CH_2), 119.2 ($\text{CH}_2\text{CH}=\text{CH}_2$), 124.2 ($\text{CH}_2\text{CH}=\text{CH}_2$), 125.9 ($\text{CH}_2\text{CH}=\text{CH}_2$), 132.9 ($\text{CH}_2\text{CH}=\text{CH}_2$) ppm. Spectroscopic data in agreement with the literature.^[16]

6.7. References

- [1] C. Schnabel, M. Hiersemann, *Org. Lett.* **2009**, *11*, 2555–2558.
- [2] V.-H. Nguyen, H. Nishino, S. Kajikawa, K. Kurosawa, *Tetrahedron* **1998**, *54*, 11445–11460.
- [3] E. Block, S. Ahmad, M. K. Jain, R. W. Crecely, R. Apitz-Castro, M. R. Cruz, *J. Am. Chem. Soc.* **1984**, *106*, 8295–8296.
- [4] C. H. Kaschula, R. Hunter, N. Stellenboom, M. R. Caira, S. Winks, T. Ogunleye, P. Richards, J. Cotton, K. Zilbeyaz, Y. Wang, et al., *Eur. J. Med. Chem.* **2012**, *50*, 236–254.
- [5] N. Taniguchi, *J. Org. Chem.* **2015**, *80*, 1764–1770.
- [6] G. Y. Zhang, S. S. Lv, A. Shoberu, J. P. Zou, *J. Org. Chem.* **2017**, *82*, 9801–9807.
- [7] S. Yoshida, Y. Sugimura, Y. Hazama, Y. Nishiyama, T. Yano, S. Shimizu, T. Hosoya, *Chem. Commun.* **2015**, *51*, 16613–16616.
- [8] H. He, S. Averick, E. Roth, D. Luebke, H. Nulwala, K. Matyjaszewski, *Polymer* **2014**, *55*, 3330–3338.
- [9] J. Castro, A. Moyano, M. A. Pericàs, A. Riera, *Synthesis* **1997**, *5*, 518–520.
- [10] Y. Yuan, X. Shi, W. Liu, *Synlett* **2011**, *4*, 559–564.
- [11] K. Kamata, T. Hirano, N. Mizuno, *Chem. Commun.* **2009**, *26*, 3958–3960.
- [12] S. Gan, J. Yin, Y. Yao, Y. Liu, D. Chang, D. Zhu, L. Shi, *Org. Biomol. Chem.* **2017**, *15*, 2647–2654.
- [13] B. Yu, A.-H. Liu, L.-N. He, B. Li, Z.-F. Diao, Y.-N. Li, *Green Chem.* **2012**, *14*, 957–962.
- [14] Y. Yuan, X. Shi, W. Liu, *Synlett* **2011**, *4*, 559–564.
- [15] P. C. Bulman Page, B. R. Buckley, C. Elliott, Y. Chan, N. Dreyfus, F. Marken, *Synlett* **2016**, *27*, 80–82.
- [16] T. Waag, C. Gelhaus, J. Rath, A. Stich, M. Leippe, T. Schirmeister, *Bioorganic Med. Chem. Lett.* **2010**, *20*, 5541–5543.