

This is an Open Access document downloaded from ORCA, Cardiff University's institutional repository:<https://orca.cardiff.ac.uk/id/eprint/147995/>

This is the author's version of a work that was submitted to / accepted for publication.

Citation for final published version:

Xia, Junqiang, Dong, Boliang, Zhou, Meirong, Ahmadian, Reza , Falconer, Roger A. , Li, Qijie and Zhang, Xiaolei 2022. A unified formula for discharge capacity of street inlets for urban flood management. *Journal of Hydrology* 609 , 127667. 10.1016/j.jhydrol.2022.127667

Publishers page: <http://dx.doi.org/10.1016/j.jhydrol.2022.127667>

Please note:

Changes made as a result of publishing processes such as copy-editing, formatting and page numbers may not be reflected in this version. For the definitive version of this publication, please refer to the published source. You are advised to consult the publisher's version if you wish to cite this paper.

This version is being made available in accordance with publisher policies. See <http://orca.cf.ac.uk/policies.html> for usage policies. Copyright and moral rights for publications made available in ORCA are retained by the copyright holders.



Journal Pre-proofs

Research papers

A Unified Formula for Discharge Capacity of Street Inlets for Urban Flood Management

Junqiang Xia, Boliang Dong, Meirong Zhou, Reza Ahmadian, Roger A. Falconer, Qijie Li, Xiaolei Zhang

PII: S0022-1694(22)00242-6
DOI: <https://doi.org/10.1016/j.jhydrol.2022.127667>
Reference: HYDROL 127667

To appear in: *Journal of Hydrology*

Received Date: 3 September 2021
Revised Date: 19 February 2022
Accepted Date: 24 February 2022

Please cite this article as: Xia, J., Dong, B., Zhou, M., Ahmadian, R., Falconer, R.A., Li, Q., Zhang, X., A Unified Formula for Discharge Capacity of Street Inlets for Urban Flood Management, *Journal of Hydrology* (2022), doi: <https://doi.org/10.1016/j.jhydrol.2022.127667>

This is a PDF file of an article that has undergone enhancements after acceptance, such as the addition of a cover page and metadata, and formatting for readability, but it is not yet the definitive version of record. This version will undergo additional copyediting, typesetting and review before it is published in its final form, but we are providing this version to give early visibility of the article. Please note that, during the production process, errors may be discovered which could affect the content, and all legal disclaimers that apply to the journal pertain.

© 2022 Published by Elsevier B.V.

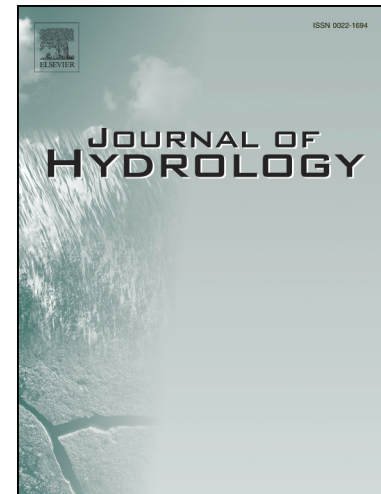

A Unified Formula for Discharge Capacity of Street Inlets for Urban Flood Management

Junqiang Xia¹, Boliang Dong¹, Meirong Zhou*¹,
Reza Ahmadian², Roger A. Falconer^{2,3}, Qijie Li¹, Xiaolei Zhang⁴

1 State Key Laboratory of Water Resources and Hydropower Engineering Science, Wuhan University, Wuhan 430072, China; Email: ZMR@whu.edu.cn

2 School of Engineering, Cardiff University, Cardiff, CF24 3AA, UK

3 Yangtze Institute for Conservation and Development, Hohai University, Nanjing 210024, China

4 School of Water Conservancy, North China University of Water Resources and Electric Power, Zhengzhou 450011, China

Abstract: Street inlets play a key role in intercepting surface runoff into underground drainage systems, which can reduce the hazard degree during urban flood events. An accurate calculation of the discharge capacity of street inlets is vitally important in numerically modelling urban floods and managing flood resilience. A series of laboratory experiments were combined with a theoretical analysis in this study to investigate the conveyance characteristics of a typical street grate inlet. A large-scale laboratory platform was constructed, consisting of an upper-layer model street and an underground measuring system installed with a V-notch weir structure. A model street inlet was used to connect the upper and underground layers, which had a complete drainage structure including: an inlet grate, a drain box, and a connection tube. A total of 78 experimental runs were conducted using this laboratory platform, and the discharges intercepted by the grate inlet were measured for a range of incoming water depths and flow velocities, where the approaching Froude number varied from 0.05 to 0.89. These experimental results showed that the drainage pattern of the street inlet was converted from weir flow to orifice flow after the drain box was fully pressurized. In addition, a power function was derived between the relative drainage velocity through the inlet and the approaching Froude number, based on the method of dimensional analysis, and a unified formula was

proposed to calculate the discharge capacity of street inlets. The corresponding coefficients in the formula were calibrated using the laboratory measurements. The unified discharge capacity formula was verified using other experimental results obtained from previous studies, and the results indicated that the calculated results using the unified formula agreed well with these measurements, with the regression coefficients of $R^2 > 0.90$. Therefore, the unified formula for discharge capacity of street inlets obtained from the study reported herein has a high predictive accuracy, which can be used in numerical modelling and risk management of urban floods.

Keywords: Street inlet; Discharge capacity; Laboratory experiment; Dimensional analysis; Urban drainage;

Urban flooding

1 Introduction

Due to the effects of climate change and rapid urbanization, the frequency of extreme urban flood events is expected to increase significantly in future years (Tabari, 2020). This increase in flood events can lead to severe damage and heavy casualties on a global scale, especially in China (Zheng et al., 2016). Urban drainage systems are usually designed for stormwater events with a return period of 2-10 years, which usually consist of combined surface and underground infrastructures. The hydraulic performance of drainage structures such as street inlets, manholes and drop shafts, as well as sewer pipes, can affect the overall conveyance efficiency of the whole storm drainage system and also affect the flood inundation extent of streets and roadways during stormwater events (Chanson, 2004; Djordjević et al., 2005; León et al., 2010; Leandro and Martins, 2016; Kim et al., 2018). A detailed numerical model study of an urban flood occurring in a campus indicated that about 70% of the total stormwater volume was released from various street inlets into the underground drainage

system (Liu et al., 2019). Therefore, it is appropriate to conduct an in-depth investigation into the discharge capacity of a specified street grate inlet, using both experimental and theoretical studies, to ensure confidence in modelling of extreme urban flood events.

The type of street inlets can be generally divided into grate inlets, curb inlets, and combination inlets, with grate inlets being one of the most common type of street inlets in China. The discharge capacity of a grate inlet depends on various influencing factors, including the size and shape of the grate inlet, the drain box, the capacity of connection pipe, the approaching water depth and flow velocity on the street, and the drainage pattern within the sewer system (Guo, 2000; Rubinato et al., 2018). In the early 1950s, Li et al. (1951) conducted a series of laboratory experiments to investigate the hydraulic behavior of storm water inlets and proposed various discharge capacity formulas. In the recent decade, weir and orifice formulas have been widely used to calculate the discharge capacity of grate inlets (Noh et al., 2016; Jang et al., 2018; Palla et al., 2018). However, due to the diversity of inlet types, there is much uncertainty in characterizing the discharge modes in practice. Spaliviero et al. (2000) investigated the hydraulic performance of six types of inlet grates, and proposed a method for predicting the hydraulic efficiency based on the geometric parameters of inlet grates and the flow characteristics. Rubinato et al. (2018) conducted experimental and numerical model studies on the weir and orifice coefficients for typical circular inlets, and the calibrated results indicated that the discharge coefficients varied significantly for different inlet types. Mustaffa et al. (2006) found that the discharge coefficient in the orifice formula decreased with an increase in the incoming Froude number. Cosco et al. (2020) conducted real-scale laboratory experiments on discharge coefficients of street inlets in situations where the inlet grates were fully submerged. The corresponding results indicated that the discharge coefficients varied significantly with the incoming Froude number,

particularly under supercritical flow conditions.

In general, an inlet grate gradually submerges with an increase in the surface water depth, and the drainage flow pattern is converted from a weir flow to an orifice flow under a specific critical condition. The discharge coefficient for street inlets can therefore adjust according to the change in the drainage flow patterns. Therefore, it is important to propose a formula for the discharge capacity of street inlets, which takes account of the variation in the drainage pattern as it is converted from a weir flow to an orifice flow. Chanson et al. (2002) suggested adopting a ratio of water depth to the short orifice dimension as the criterion to distinguish between these two drainage patterns. However, the ratio varies with the grate type, which needs to be determined according to laboratory experiments or field observations. Guo et al. (2009) proposed a formula to characterize the discharge capacity of street inlets under the transition state between weir flow and orifice flow, and suggested using the smallest one among the values calculated by the weir, orifice, and transition formulas as the discharge intercepted by the street inlet. Many researchers have investigated the discharge capacity of inlet grates, but little attention has been paid to the influence of drain box and connection tube on the overall discharge capacity (Lee et al., 2012; Gómez et al., 2013, 2016; Kemper and Schlenkhoff, 2019). Noh et al. (2016) conducted ensemble experimental and numerical model studies on the flow interaction between different parts of a sewer system. Leandro et al. (2009) considered the complex connection structure between the surface and underground systems, and generalized the whole structure into five control sections.

In order to investigate the hydraulic characteristics of street grate inlets that are widely used across China and many other countries, such as the UK, an experimental programme was conducted for a wide range of parameter variations. Based on an analysis of the experimental results and the use

of dimensional analysis method, a unified formula is proposed to calculate the discharge capacity of street inlets for a wide range of drainage patterns. The current study covers three parts, with Section 2 describing the experimental facility and procedure; Section 3 presents the experimental details and results, including the drainage characteristics of a street inlet, the derivation of the unified discharge capacity formula, and the comparison between different discharge capacity formulas. This section also discusses the accuracy, universality and verification of the unified formula. Finally, Section 4 includes the key conclusions from the study.

2 Methodology

2.1 Experimental facility

The experiments were conducted in the hydraulic laboratory of North China University of Water Resources and Electric Power, China. As shown in Fig. 1a, the laboratory flume is composed of an upper layer and a lower layer, and the upper layer of the flume is 20 m long, 3 m wide (Dong et al., 2021). The flume bed is made of tempered glass and the joints between glass panels are connected with silicone sealant. The whole flume bed is horizontal with a vertical tolerance of less than 3 mm. In a physical hydraulic model, the flow conditions would be similar to those in the prototype if the model were to satisfy the principles of geometric, kinematic and dynamic similarity (i.e., Froude number similarity) (Zhang and Xie, 1993; Chanson, 2004). The hydraulic model for the discharge capacity of a street inlet was designed to be undistorted, with a geometric scale ratio $\lambda_L = 1.5$ governed by the flume dimensions. The prototype grate inlet with the type of 16S518 is widely used in urban environments, with the dimensions of $0.75 \times 0.45 \times 0.75$ m. Therefore, the scaled model grate inlet made of transparent acrylic had the dimensions of $0.50 \times 0.30 \times 0.50$ m, with the inlet being placed in

the centre of the flume (Fig. 1b and 1c). The inlet grate had a void ratio of 34%, and the grate bars were orientated parallel to the flume centerline and distributed in 3 columns and 10 rows. A rectangular drain box was connected to the inlet grate to collect the flow intercepted by the grate. A circular connection tube, of diameter 0.15 m, was placed near the bottom of the drain box to release the flow to the underground measuring system, which included a V-notch weir. In the experimental programme, the connection tube was always setup to operate as a free drainage state. Therefore, this study mainly investigated the discharge capacity of a street inlet under a normal drainage condition, without considering the influence of a sewer system surcharge on the inlet discharge capacity. The magnitude of the incoming discharge in the flume was controlled by a valve and an electromagnetic flowmeter, with the downstream water level being controlled by a sluice gate.

Insert Fig. 1

2.2 Experimental procedure

During each experimental run, the flow was pumped from the underground reservoir to the water tower, which was connected to the inlet tank of the flume to provide a steady upstream discharge. Part of the surface runoff was intercepted by the street inlet and drained into the underground discharge measuring system installed with a V-notch weir structure. The remaining flow passing through the flume was collected in the outlet tank. Both the upper and lower-level flows were discharged back into the underground reservoir and the flow was then recirculated. It was assumed that the flow in the flume had reached a steady state when the water level upstream of the weir remained unchanged for more than 5 minutes. The water depth and flow velocity of the surface runoff were then measured at a specified point located 1.0 m upstream of the street inlet. The water depth was measured by an ultrasonic water level gauge, with a sampling frequency of 4 Hz and a

measurement accuracy of about ± 0.2 mm. Flow velocity was measured by a propeller-type current meter, with a measurement accuracy of ± 0.03 m/s. The measurement time for both water depth and flow velocity was set to 60 s and the time-averaged values were treated as the final results of each experimental run. Based on observations of the experimental flow structure, the existence of the street inlet appeared to have little influence on the surface flow pattern beyond 1.0 m away from the inlet. Therefore, the measured water depth and flow velocity were regarded as being equal to the values for the incoming runoff. Correspondingly, the intercepted discharge by the inlet was measured by the underground flow measuring system using the V-notch weir.

The whole experimental programme included 78 runs to reproduce the hydraulic features of a street grate inlet for a range of inflow conditions. The incoming discharge varied from 0.031 to 0.052 m^3/s (equivalent to a unit width discharge between 1.033×10^{-2} - 17.33×10^{-2} m^2/s), with the runoff water depth ranging from 2.8 to 18.3 cm, and the discharge intercepted by the street inlet varied from 0.0148 to 0.0342 m^3/s . Except in the near vicinity of the inlet, the flow in the flume maintained a subcritical state, with the approaching Froude number varying between 0.05 and 0.89.

3 Results and discussion

3.1 Observation of drainage patterns

The variation in the drainage pattern in the vicinity of the street inlet for a range of water depths is illustrated in the following 3D schematic diagrams (Fig. 2). With an increase in the surface water depth, the drainage pattern around the inlet changed from a weir flow to an orifice flow, and the flow structures on the street surface and in the drain box showed different characteristics in three stages.

(i) In stage I, the flow under a small incoming surface water depth was drained from the border of

the grate in the form of a weir flow, and the water depth in the drain box was small (Fig. 3a).

(ii) In stage II, the inlet grate was almost fully submerged with a further increase in the surface water depth, and the flow was intercepted by the grate inlet in the form of a vortex, with intense air entrainment. Under these conditions the drain box was almost full.

(iii) In stage III, the vortex of surface flow around the street inlet was intensified for a large upstream water depth, but the phenomenon of air entrainment did not occur. In this case, the drainage status was similar to orifice flow, and the discharge capacity intercepted by the inlet was controlled by the capacity of connection tube (Fig. 2b).

Insert Fig. 2

The above-mentioned 2nd and 3rd drainage stages had a similar flow pattern to free surface vertical vortex flows (Echávez and McCann, 2002; Li et al., 2008). Most of the previous studies only considered the discharge capacity of the inlet grate and did not consider the fact that the discharge capacity of a street inlet was restricted by the connection tube for a larger surface water depth. For such large depths and vortex-induced flows, it is therefore deemed necessary to conduct a further detailed investigation into the discharge capacity using a complete structure of grate inlet. A direct use of the capacity formula of grate inlets may therefore lead to an over-estimation of the discharge intercepted by the inlet under large surface water depth conditions. In addition, it should be mentioned that in these experiments, the connection tube was relatively short and was operated in a free drainage state which was different from the actual situation. Sewer drainage systems are often surcharged during heavy rainfall processes with sewer pipes fully or almost fully pressurized. The surcharge of sewer pipes may reduce the drainage capacity of street inlets. However, due to the limitations of the experimental facility, it is difficult to investigate the effect of sewer pipe water head on the inlet

discharge capacity. More in-depth experimental studies need to be conducted in the future, which can consider the interaction between street inlet and sewer pipe.

3.2 Discharge characteristics of street inlet

When the surface water depth in front of the inlet is relatively small, the flow is drained by the inlet in the pattern of weir flow. Therefore, the discharge capacity of the inlet can be determined using the weir formula:

$$Q = C_w P \sqrt{2g} H^{1.5} \quad (1)$$

where Q is the discharge through the inlet; C_w is the discharge coefficient of the inlet for the weir flow pattern; g is the gravitational acceleration; H is the upstream specific energy, with $H = h + u^2/2g$, where h and u are the surface water depth and corresponding velocity measured at 1 m upstream of the inlet; and P is the inlet grate perimeter, equaling the length of the outer border of a grate. An analysis of the water depth and velocity measurements showed that the velocity head accounted for a relatively small proportion of the upstream specific energy, with an average percent of about 8.5%. Therefore, the effect of the velocity head was neglected in the following analysis, with the water depth at the measurement point being regarded as the upstream specific energy.

For the case of a relatively large water depth, the drain box is fully pressurized, and the discharge capacity of the street inlet reduces slightly, owing to the effect of air entrainment. For a large water depth, the flow interaction between the surface and the underground sewer systems can be generalized as an orifice flow. The discharge capacity of the inlet can then be formulated as follows:

$$Q = C_n A_s \sqrt{2gH_1} \quad (2)$$

where C_n is the discharge coefficient for orifice flow; A_s is the inner area of the connection tube; H_1 is the depth of the connection tube center below free surface ($H_1 = h + D_0$), where D_0 is the height

between the inlet grate and the center of the connection tube.

The discharge coefficients were respectively calibrated for the weir and orifice formulas, using the experimental results before and after the critical state, with a weir coefficient $C_w = 0.440$ and an orifice coefficient $C_n = 0.540$ being obtained. Fig. 3 compares the calculated and measured discharges intercepted by this grate inlet under different surface water depths, and the results calculated using the calibrated formulas generally agree well with the experimental data. If the surface water depth was small (i.e., $h < 0.045$ m), the increased rate of the discharge intercepted by the grate inlet was relatively large, with an increase in the water depth. The increased rate reduced for a large surface water depth (i.e., $h > 0.064$ m). Although the weir and orifice formulas can accurately characterize the discharge capacity of the street inlet under laboratory conditions, there are certain limitations in practical applications. Firstly, the weir and orifice formulas neglect the influence of the approaching surface flow velocity, although earlier studies (Cosco et al., 2020) have highlighted that the surface velocity can greatly influence the discharge capacity. Secondly, it is hard to determine the critical water depth between weir and orifice flows, which is vital in selecting the correct discharge formula. The conversion between weir pattern and orifice pattern of a street inlet is related to the discharge capacity for both inlet grate and connection tube under different flow conditions. Different street inlets with different inlet grate and connection tube characteristics may not only have different discharge capacities but also have different critical water depths, which will further increase uncertainties in the application of the weir and orifice formulae. Therefore, it is necessary to propose a simple and straightforward discharge capacity formula for street grate inlets, which can provide a further technical support for numerical modelling and risk management of urban floods.

Insert Fig. 3

3.3 Formula derivation and coefficient calibration

Due to the limitations of the weir and orifice formulas, it is necessary to propose a simple but accurate formula to give a quantitative description of the discharge capacity of street inlets for different drainage patterns. A method of dimensional analysis is widely used in developing the relationship between different physical variables for a specified hydrodynamic phenomenon, and it is assumed that a physical problem involves n variables and m fundamental units ($n > m$), and these variables can construct $n-m$ dimensionless parameters. The first step in deriving the discharge capacity formula is to determine the physical quantities related to the discharge capacity of street inlets. Based on the analysis of the weir and orifice formulas, the magnitude of the discharge capacity for street inlets is related to the geometric features of the inlet, the surface flow patterns, and the gravitational acceleration. It is known that the discharge capacity for a specified street inlet is related to its size, and the drainage velocity (U) is then used in this analysis to establish a more universal function. Here the drainage velocity is defined as the drainage discharge per unit grate area:

$$U = Q / A \quad (3)$$

where A is the area of the inlet grate.

The variables then selected in the analysis include: the water depth h , the flow velocity u , the gravitational acceleration g , and the inlet drainage velocity U , with the function between these variables being written in this form:

$$f(U, h, u, g) = 0 \quad (4)$$

Insert Table 1

The dimensional matrix of the selected variables is presented in Table 1. Here u and g are selected as the basic variables according to the pi-theorem (Brand, 1957), and h and U can be written as the

functions of these basic variables. The dimensional relationships can then be expressed by:

$$\begin{pmatrix} 1 & 1 \\ -1 & -2 \end{pmatrix} \times \begin{pmatrix} x_1 \\ x_2 \end{pmatrix} = \begin{pmatrix} 1 \\ -1 \end{pmatrix} \quad \text{and} \quad \begin{pmatrix} 1 & 1 \\ -1 & -2 \end{pmatrix} \times \begin{pmatrix} y_1 \\ y_2 \end{pmatrix} = \begin{pmatrix} 1 \\ 0 \end{pmatrix} \quad (5)$$

where $x_1=1$, $x_2=0$, $y_1=2$, and $y_2=-1$. Accordingly, the two relationships $U = k_1 u$ and $h = k_2 u^2 / g$ are obtained, giving $\Pi_1 = \frac{U}{u} = R_U$ and $\Pi_2 = \frac{u^2}{gh} = Fr^2$, respectively. Thus, the relationship between Π_1 and Π_2 can be written as:

$$f(R_U, Fr) = 0 \quad (6)$$

where $R_U (=U/u)$ is the relative drainage velocity, which equals the ratio of the drainage velocity through an inlet grate to the incoming surface velocity in front of the inlet, and Fr is the Froude number of the flow in front of the street inlet.

Based on these experimental data, the relationship between R_U and Fr is given in Fig. 4, which indicates an obvious power function between these variables. Therefore, Eq. (6) can be further re-written in the following form:

$$R_U = a \times Fr^b \quad (7)$$

where a and b are dimensionless coefficients, with the calibrated values being 0.302 and -0.816, respectively. The results obtained using this power function are in close agreement with the measurements. Correspondingly, the discharge capacity for this street inlet can be calculated using the following formula:

$$Q = 0.302 u A Fr^{-0.816} \quad (8)$$

Insert Fig. 4

3.4 Verification and evaluation of the proposed formula

In order to test the accuracy and universality of the proposed formula, a process of formula

validation was conducted, using the experimental data obtained from previous studies (Cosco et al., 2020; Hao et al., 2021). Cosco et al. (2020) conducted laboratory experiments on the discharge capacity for different grate inlets (such as Barcelona1 and E-25 grates) under supercritical flow conditions, and provided details of their experimental parameters. However, only the drainage characteristics of inlet grates were investigated in the experiments of Cosco et al. (2020), and the influences were not considered of connection tube and drain box. The second experimental project selected for formula validation was performed by Hao et al. (2021). Their experiments were conducted under subcritical flow conditions, with a complete inlet structure and different inlet grate clogging degrees being considered. The supplementary material in Hao et al. (2021) only provided part of the experimental results, especially for the measured data such as the surface flow velocity. Therefore, the mean approaching velocity was approximated to the ratio of the upstream discharge to the wetted cross-sectional area. Some of the previous experimental studies were not selected for formula validation because detailed flow velocity data were not provided (Lee et al., 2012) or only a small range of Froude numbers were considered in the experiments (Rubinato et al., 2018) or the number of data points was not adequate for parameter calibration (Li et al., 1951).

Fig. 5 shows the relationships between the relative drainage velocity R_U and the Froude number Fr using different experiments conducted by Cosco et al. (2020) and Hao et al. (2021), and there exist obvious power functions between these two variables of R_U and Fr . These relations are similar to the experimental results obtained from the current study reported herein. Therefore, Eq. (7) was further used to describe the relationship, with the coefficients a and b being re-calibrated using the measurements from each set of the experimental projects undertaken independently. High correlation coefficients (R^2) were obtained, with the values ranging from 0.932 to 0.976, which indicated the

accuracy and universality of the proposed formula based on the dimensional analysis method reported herein. The model grate inlet used in Hao's experiments had the same prototype grate inlet of this study with the type of 16S518, and the reason for the difference between the calibrated coefficients was thought to be related to the location of the inlet. In the current experiments, the street inlet was placed at the centerline of the laboratory flume, whereas the inlet in Hao's experiments was placed near the boundary of the laboratory flume (Hao et al., 2021). Therefore, the discharge capacity of such a street inlet was related not only to its geometric features and flow patterns, but also to the location and local topography where the inlet was placed. In-depth investigations need to be conducted in the future to ascertain the influence of the location on the discharge capacity. Besides, the drainage of street inlets can influence the upstream water depth and flow velocity in subcritical regimes, and the location where the flow pattern is measured will affect the coefficient values. This should be noted when the formula is applied in numerical modelling, especially in finding appropriate datum to obtain incoming water depth and flow velocity values.

Insert Fig. 5

Fig. 6 illustrates a comparison between the drainage discharge for the prototype inlet calculated using the unified formula, and the results calculated using the weir and orifice formulas. The velocity head in the weir formula is included to reflect the influence of the flow velocity on the drainage discharge. The surface water depth ranges from zero to 0.50 m, with the corresponding flow velocity varying between zero and 0.9 m/s. For large surface water depths, the drainage discharges calculated using the unified formula are larger than those calculated using the weir and orifice formulas. Furthermore, the unified discharge capacity formula proposed in this study is more sensitive to any variation in the approaching flow velocity. For a water depth of 0.4 m, the discharges calculated using

the unified formula are $0.1166 \text{ m}^3/\text{s}$ and $0.1570 \text{ m}^3/\text{s}$, corresponding to the approaching velocities of 0.1 m/s and 0.5 m/s , respectively. However, the discharges calculated using the weir and orifice formulas are equal to $0.0965 \text{ m}^3/\text{s}$ which are independent of the flow velocity. According to the previous experimental studies, the discharge coefficients decreased with an increase in the Froude number, especially under supercritical conditions (Mustaffa et al., 2006; Cosco et al., 2020). If a constant discharge coefficient is therefore used for the weir and orifice formulas, then the calculated discharges for different drainage patterns will reduce the predictive accuracy of the inlet discharge.

Insert Fig. 6

4 Conclusions

In this study, laboratory experiments were undertaken to estimate the discharge capacity for a specified street inlet. Based on the experimental results, the discharge coefficients were calibrated respectively for the weir and orifice formulas. Furthermore, a unified discharge capacity formula was derived, based on the method of dimensional analysis. The accuracy and applicability of the unified formula were also validated. The following conclusions are drawn from this study:

- (i) The laboratory experiments conducted in this study show that the drainage patterns for the selected street inlet varied from a weir flow to an orifice flow, as the surface water depth increased. Based on the measurements reported herein, the calibrated weir and orifice coefficients were found to be 0.440 and 0.540 , respectively in the weir and orifice formulas for the discharge of street inlets.
- (ii) Based on the method of dimensional analysis, a power function was developed between the relative drainage velocity (R_U) and the incoming Froude number (Fr), with a unified discharge capacity formula being derived accordingly. The proposed formula is simple in form and can be

directly used regardless of the drainage status. The accuracy of the unified formula was validated through testing its applicability against various measurements reported in the literature, and the resulting correlation coefficients (R^2) were greater than 0.90.

(iii) According to previous studies for grate inlets, the discharge coefficients for the weir and orifice formulas usually decrease with an increase in the Froude number, especially under supercritical conditions. The unified discharge capacity formula can reflect the influence of the approaching Froude number on the discharge capacity for street inlets without modifying the discharge coefficient, which greatly reduces the uncertainty in applying the formula.

Acknowledgments

This study was supported by the National Natural Science Foundation of China (Grant Nos. 51725902; 41890823); the Royal Academy of Engineering through the Urban Flooding Research Policy Impact Programme (Grant No. UUFRIIP\100031); and the Newton Advanced Fellowships from the NSFC and the UK Royal Society (Grant Nos. 52061130219; NAF\R1\201156).

Notation

Parameter	Description	Unit
Q	Discharge through the inlet	m^3/s
C_w	Discharge coefficient of the inlet for the weir flow pattern	-
C_n	Discharge coefficient for orifice flow	-
g	Gravitational acceleration	m/s^2
H	Upstream specific energy	m
h	Surface water depth	m
u	Surface flow velocity	m/s
P	Inlet grate perimeter	m
A	Area of the inlet grate	m^2
A_s	Inner area of the connection tube	m^2
H_1	Depth of the connection tube center below free surface	m
D_0	Hight between the inlet grate and the center of the connection tube	m
U	Drainage velocity	m/s
R_U	Relative drainage velocity	-

References

- Brand, L., 1957. The Pi theorem of dimensional analysis. *Archive for Rational Mechanics and Analysis* 1, 35–45. <https://doi.org/10.1007/BF00297994>
- Chanson, H., 2004. Hydraulics of Rectangular Dropshafts. *Journal of Irrigation and Drainage Engineering* 130, 523–529. [https://doi.org/10.1061/\(ASCE\)0733-9437\(2004\)130:6\(523\)](https://doi.org/10.1061/(ASCE)0733-9437(2004)130:6(523))
- Chanson, H., Aoki, S.-I., Maruyama, M., 2002. Unsteady two-dimensional orifice flow: a large-size experimental investigation. *Journal of Hydraulic Research* 40, 63–71. <https://doi.org/10.1080/00221680209499874>
- Cosco, C., Gómez, M., Russo, B., Tellez-Alvarez, J., Macchione, F., Costabile, P., Costanzo, C., 2020. Discharge coefficients for specific grated inlets. Influence of the Froude number. *Urban Water Journal* 17, 656–668. <https://doi.org/10.1080/1573062X.2020.1811881>
- Djordjević, S., Prodanović, D., Maksimović, Č., Ivetić, M., Savić, D., 2005. SIPSON – Simulation of Interaction between Pipe flow and Surface Overland flow in Networks. *Water Science and Technology* 52, 275–283. <https://doi.org/10.2166/wst.2005.0143>
- Echávez, G., McCann, E., 2002. An experimental study on the free surface vertical vortex. *Experiments in Fluids* 33, 414–421. <https://doi.org/10.1007/s00348-002-0463-2>
- Gómez, M., Rabasseda, G.H., Russo, B., 2013. Experimental campaign to determine grated inlet clogging factors in an urban catchment of Barcelona. *Urban Water Journal* 10, 50–61. <https://doi.org/10.1080/1573062X.2012.690435>
- Gómez, M., Recasens, J., Russo, B., Martínez-Gomariz, E., 2016. Assessment of inlet efficiency through a 3D simulation: numerical and experimental comparison. *Water Science and Technology* 74, 1926–1935. <https://doi.org/10.2166/wst.2016.326>
- Guo, J.C.Y., 2000. Street Storm Water Conveyance Capacity. *Journal of Irrigation and Drainage Engineering* 126, 119–123. [https://doi.org/10.1061/\(ASCE\)0733-9437\(2000\)126:2\(119\)](https://doi.org/10.1061/(ASCE)0733-9437(2000)126:2(119))
- Guo, J.C.Y., MacKenzie, K.A., Mommandi, A., 2009. Design of Street Sump Inlet. *Journal of Hydraulic Engineering* 135, 1000–1004. [https://doi.org/10.1061/\(ASCE\)HY.1943-7900.0000094](https://doi.org/10.1061/(ASCE)HY.1943-7900.0000094)
- Hao, X., Mu, J., Shi, H., 2021. Experimental Study on the Inlet Discharge Capacity under Different Clogging Conditions. *Water* 13, 826. <https://doi.org/10.3390/w13060826>
- Jang, J.H., Chang, T.H., Chen, W.B., 2018. Effect of inlet modelling on surface drainage in coupled urban flood simulation. *Journal of Hydrology* 562, 168–180. <https://doi.org/10.1016/j.jhydrol.2018.05.010>
- Kemper, S., Schlenkhoff, A., 2019. Experimental study on the hydraulic capacity of grate inlets with supercritical surface flow conditions. *Water Science and Technology* 79, 1717–1726. <https://doi.org/10.2166/wst.2019.171>
- Kim, J., Jo, J., Yoon, S., 2018. Head Loss Reduction in Surcharged Four-Way Junction Manholes. *Water* 10, 1741. <https://doi.org/10.3390/w10121741>
- Leandro, J., Chen, A.S., Djordjević, S., Savić, D.A., 2009. Comparison of 1D/1D and 1D/2D Coupled (Sewer/Surface) Hydraulic Models for Urban Flood Simulation. *Journal of Hydraulic Engineering* 135, 495–504. [https://doi.org/10.1061/\(ASCE\)HY.1943-7900.0000037](https://doi.org/10.1061/(ASCE)HY.1943-7900.0000037)

- Leandro, J., Martins, R., 2016. A methodology for linking 2D overland flow models with the sewer network model SWMM 5.1 based on dynamic link libraries. *Water Science and Technology* 73, 3017–3026. <https://doi.org/10.2166/wst.2016.171>
- Lee, S., Nakagawa, H., Kawaike, K., Zhang, H., 2012. Study on inlet discharge coefficient through the different shapes of storm drains for urban inundation analysis. *Journal of Japan Society of Civil Engineers, Ser. B1 (Hydraulic Engineering)* 68, I_31-I_36. https://doi.org/10.2208/jscejhe.68.I_31
- León, A.S., Liu, X., Ghidaoui, M.S., Schmidt, A.R., García, M.H., 2010. Junction and Drop-Shaft Boundary Conditions for Modeling Free-Surface, Pressurized, and Mixed Free-Surface Pressurized Transient Flows. *Journal of Hydraulic Engineering* 136, 705–715. [https://doi.org/10.1061/\(ASCE\)HY.1943-7900.0000240](https://doi.org/10.1061/(ASCE)HY.1943-7900.0000240)
- Li, H., Chen, H., Ma, Z., Zhou, Y., 2008. Experimental and Numerical Investigation of Free Surface Vortex. *Journal of Hydrodynamics* 20, 485–491. [https://doi.org/10.1016/S1001-6058\(08\)60084-0](https://doi.org/10.1016/S1001-6058(08)60084-0)
- Li, W.H., Geyer, J.C., Benton, G.S., 1951. Hydraulic Behavior of Storm-Water Inlets: I. Flow into Gutter Inlets in a Straight Gutter without Depression. *Sewage and Industrial Wastes* 23, 34–46.
- Liu L., Sun J., Yuan B., Lin B., 2019. Surface flooding in urban areas under heavy downpours: Case study of Tsinghua University campus. *Journal of Hydroelectric Engineering* 38, 98-109. (in Chinese) <https://doi.org/10.11660/slfdx.20190809>
- Mustaffa, Z., Rajaratnam, N., Zhu, D.Z., 2006. An experimental study of flow into orifices and grating inlets on streets. *Canadian Journal of Civil Engineering* 33, 837–845. <https://doi.org/10.1139/106-031>
- Noh, S.J., Lee, S., An, H., Kawaike, K., Nakagawa, H., 2016. Ensemble urban flood simulation in comparison with laboratory-scale experiments: Impact of interaction models for manhole, sewer pipe, and surface flow. *Advances in Water Resources* 97, 25–37. <https://doi.org/10.1016/j.advwatres.2016.08.015>
- Palla, A., Colli, M., Candela, A., Aronica, G.T., Lanza, L.G., 2018. Pluvial flooding in urban areas: the role of surface drainage efficiency: The role of surface drainage on pluvial flooding. *Journal of Flood Risk Management* 11, S663–S676. <https://doi.org/10.1111/jfr3.12246>
- Rubinato, M., Lee, S., Martins, R., Shucksmith, J.D., 2018. Surface to sewer flow exchange through circular inlets during urban flood conditions. *Journal of Hydroinformatics* 20, 564–576. <https://doi.org/10.2166/hydro.2018.127>
- Spaliviero, F., May, R., Escarameia, M., 2000. Spacing of road gullies hydraulic performance of BS EN 124 gully gratings and kerb inlets.
- Tabari, H., 2020. Climate change impact on flood and extreme precipitation increases with water availability. *Scientific Reports* 10, 13768. <https://doi.org/10.1038/s41598-020-70816-2>
- Zheng, Z., Gao, J., Ma, Z., Wang, Z., Yang, X., Luo, X., Jacquet, T., Fu, G., 2016. Urban flooding in China: main causes and policy recommendations. *Hydrological Processes* 30, 1149–1152.

Table 1. Dimensional matrix of the selected variables related to the discharge capacity of a street inlet

Unit	Variables			
	u	g	U	h
L	1	1	1	1
T	-1	-2	-1	0

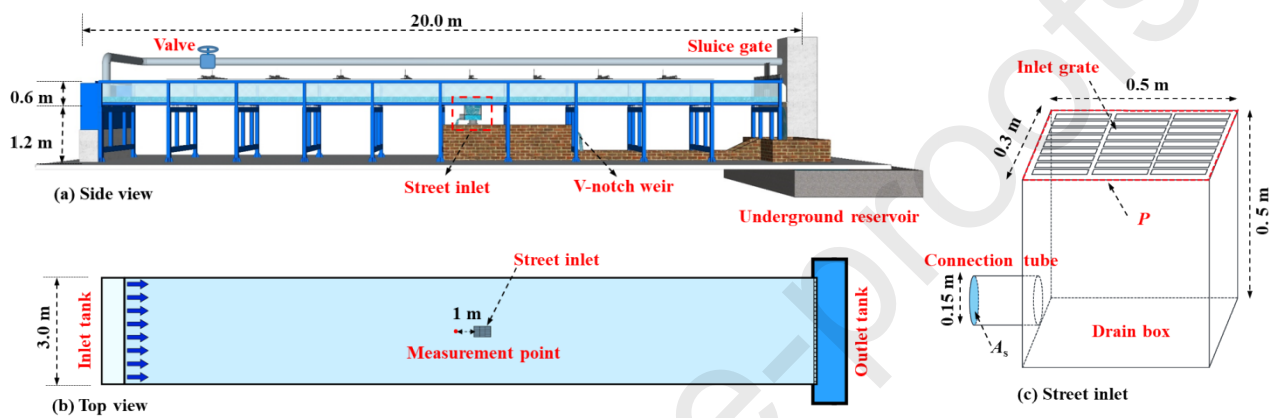

Figure 1. Sketch of the experimental model setup for measuring the discharge capacity of a street inlet.

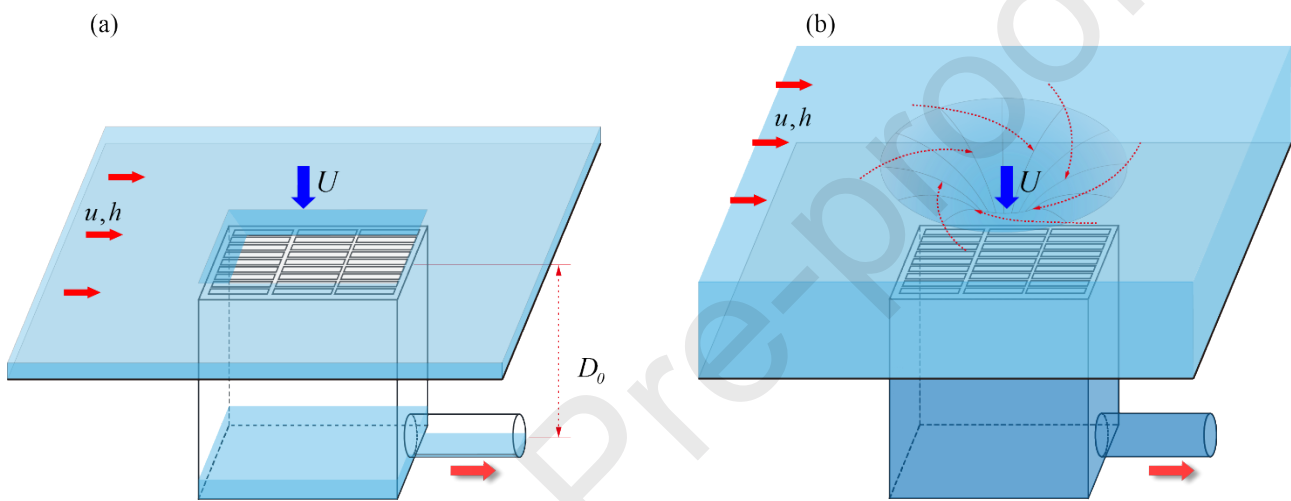

Figure 2. Sketch maps of different drainage patterns for a street inlet: (a) weir flow, (b) orifice flow.

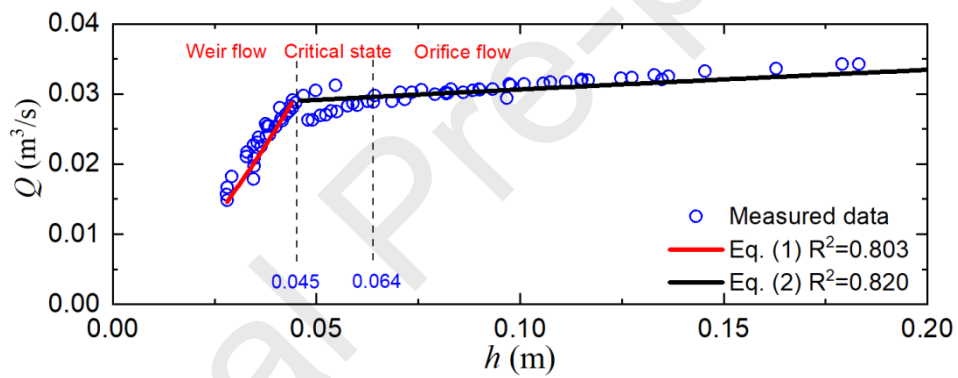

Figure 3. Comparison between the calculated and measured discharges intercepted by the street inlet for different surface water depths.

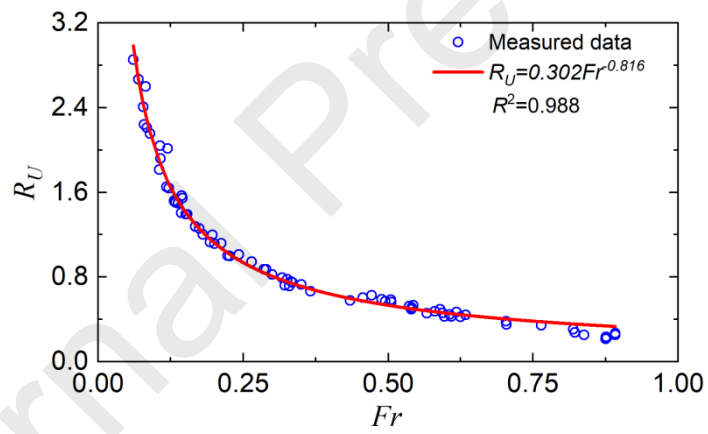

Figure 4. Relationship between the relative drainage velocity (R_U) and the incoming Froude number (Fr).

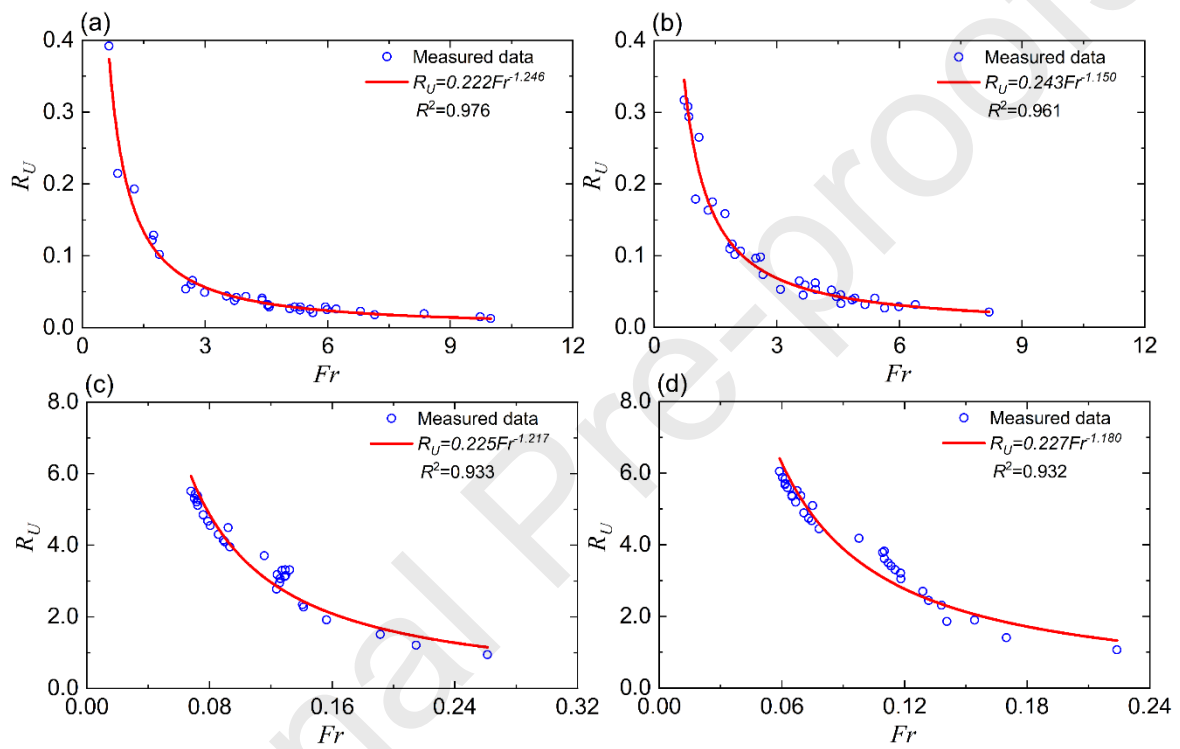

Figure 5. Relationships between the relative drainage velocity (R_U) and the incoming Froude number (Fr) using different types of street inlets: (a, b) Barcelona1 and E-25 grates used by Cosco et al. (2020); and (c, d) Inlet 16S518 under no clogging and quarter-clogging used by Hao et al. (2021).

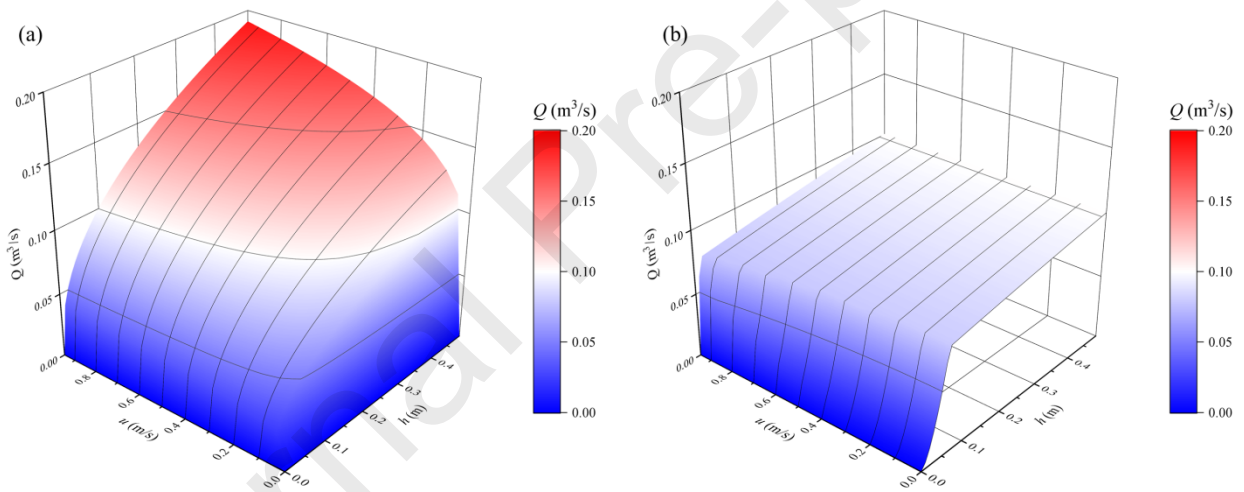

Figure 6. Drainage discharges for different water depths and flow velocities calculated using: (a) the unified formula proposed in this study; (b) the weir and orifice formulas including the effect of the velocity head.

Table 1. Dimensional matrix of the selected variables related to the discharge capacity of a street inlet

Unit	Variables			
	u	g	U	h
L	1	1	1	1

A Unified Formula for Discharge Capacity of Street Inlets for Urban Flood Management

Junqiang Xia¹, Boliang Dong¹, Meirong Zhou*¹,
Reza Ahmadian², Roger A. Falconer^{2,3}, Qijie Li¹, Xiaolei Zhang⁴

1 State Key Laboratory of Water Resources and Hydropower Engineering Science, Wuhan University, Wuhan 430072, China; Email: ZMR@whu.edu.cn

2 School of Engineering, Cardiff University, Cardiff, CF24 3AA, UK

3 Yangtze Institute for Conservation and Development, Hohai University, Nanjing 210024, China

4 School of Water Conservancy, North China University of Water Resources and Electric Power, Zhengzhou 450011, China

Abstract: Street inlets play a key role in intercepting surface runoff into underground drainage systems, which can reduce the hazard degree during urban flood events. An accurate calculation of the discharge capacity of street inlets is vitally important in numerically modelling urban floods and managing flood resilience. A series of laboratory experiments were combined with a theoretical analysis in this study to investigate the conveyance characteristics of a typical street grate inlet. A large-scale laboratory platform was constructed, consisting of an upper-layer model street and an underground measuring system installed with a V-notch weir structure. A model street inlet was used to connect the upper and underground layers, which had a complete drainage structure including: an inlet grate, a drain box, and a connection tube. A total of 78 experimental runs were conducted using this laboratory platform, and the discharges intercepted by the grate inlet were measured for a range of incoming water depths and flow velocities, where the approaching Froude number varied from 0.05 to 0.89. These experimental results showed that the drainage pattern of the street inlet was

converted from weir flow to orifice flow after the drain box was fully pressurized. In addition, a power function was derived between the relative drainage velocity through the inlet and the approaching Froude number, based on the method of dimensional analysis, and a unified formula was proposed to calculate the discharge capacity of street inlets. The corresponding coefficients in the formula were calibrated using the laboratory measurements. The unified discharge capacity formula was verified using other experimental results obtained from previous studies, and the results indicated that the calculated results using the unified formula agreed well with these measurements, with the regression coefficients of $R^2 > 0.90$. Therefore, the unified formula for discharge capacity of street inlets obtained from the study reported herein has a high predictive accuracy, which can be used in numerical modelling and risk management of urban floods.

Keywords: Street inlet; Discharge capacity; Laboratory experiment; Dimensional analysis; Urban drainage; Urban flooding

CRediT author statement

19-2-2022

Subject: A Unified Formula for Discharge Capacity of Street Inlets for Urban Flood Management

Junqiang Xia: Resources, Methodology, Writing - Review & Editing. **Boliang Dong:** Methodology, Investigation, Writing - Original Draft. **Meirong Zhou*:** Conceptualization, Formal analysis. **Reza Ahmadian:** Funding acquisition. **Roger A. Falconer:** Writing - Review & Editing. **Qijie Li:** Writing - Review & Editing. **Xiaolei Zhang :** Resources.

Declaration of interests

The authors declare that they have no known competing financial interests or personal relationships that could have appeared to influence the work reported in this paper.

The authors declare the following financial interests/personal relationships which may be considered as potential competing interests:

Notation

Parameter	Description	Unit
Q	Discharge through the inlet	m^3/s
C_w	Discharge coefficient of the inlet for the weir flow pattern	-
C_n	Discharge coefficient for orifice flow	-
g	Gravitational acceleration	m/s^2
H	Upstream specific energy	m
h	Surface water depth	m
u	Surface flow velocity	m/s
P	Inlet grate perimeter	m
A	Area of the inlet grate	m^2
A_s	Inner area of the connection tube	m^2

H_1	Depth of the connection tube center below free surface	m
D_0	Hight between the inlet grate and the center of the connection tube	m
U	Drainage velocity	m/s
R_U	Relative drainage velocity	-
Fr	Flow Froude number	-

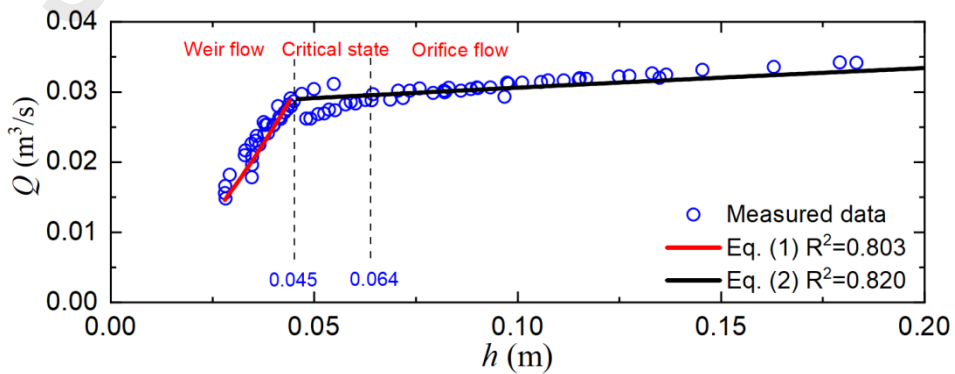
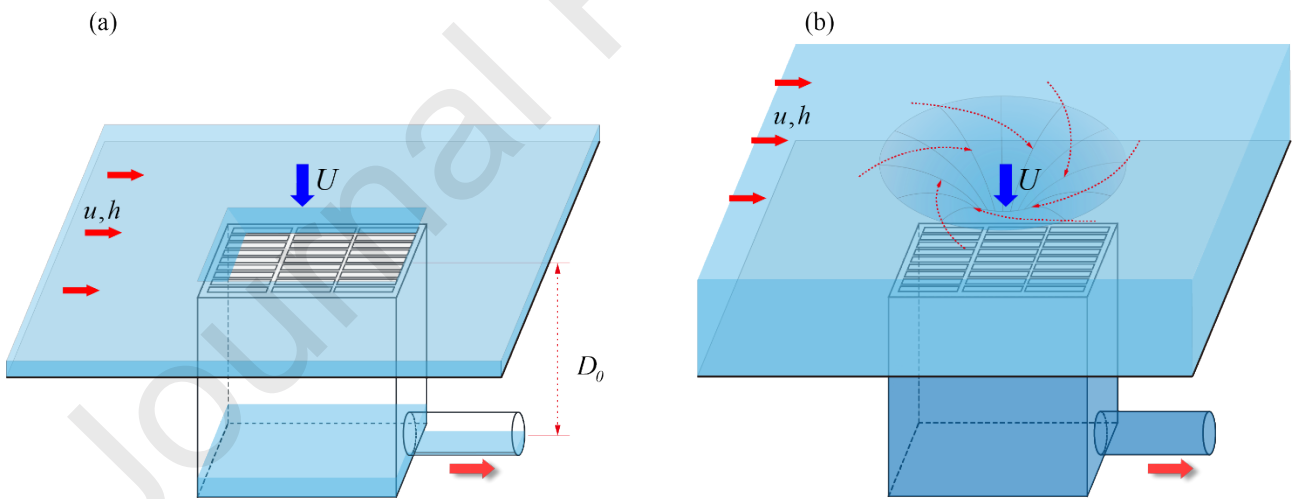
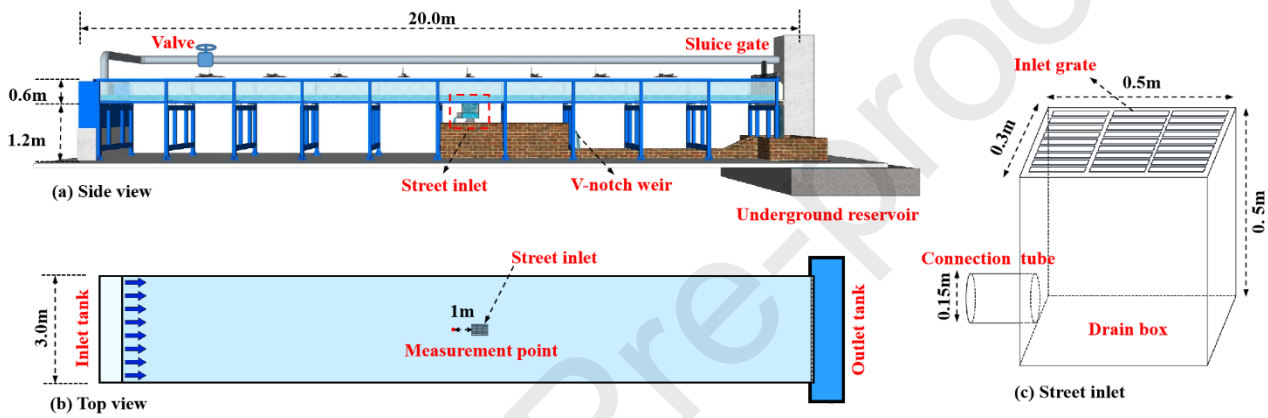

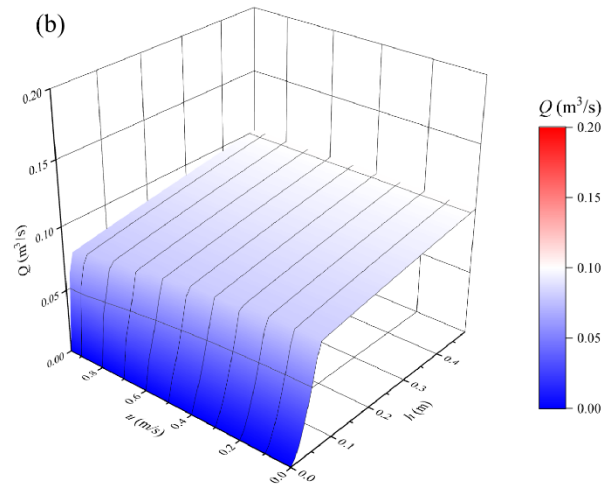
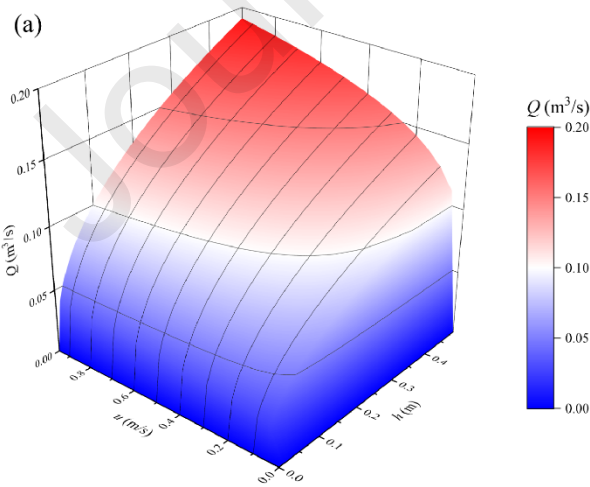
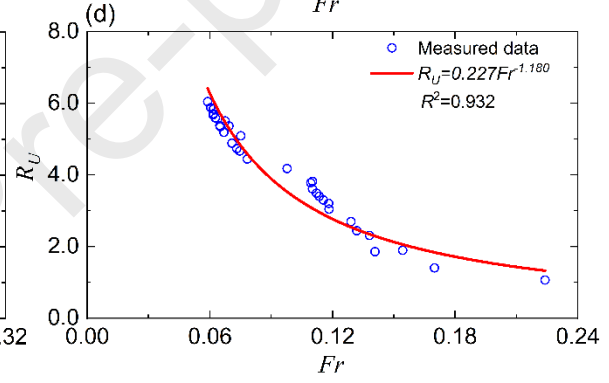
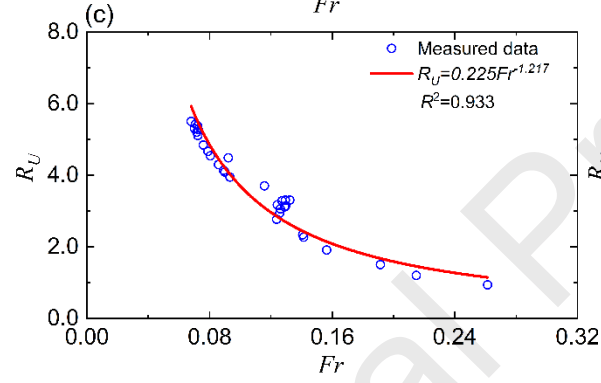
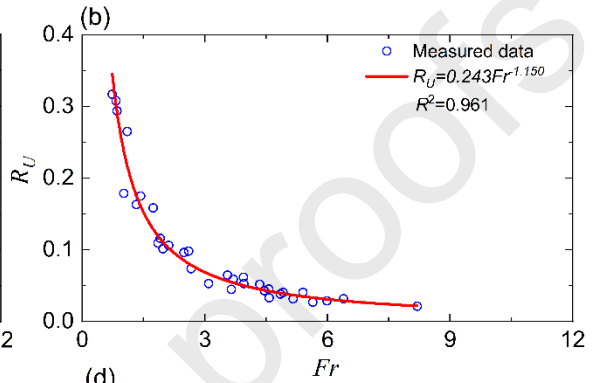
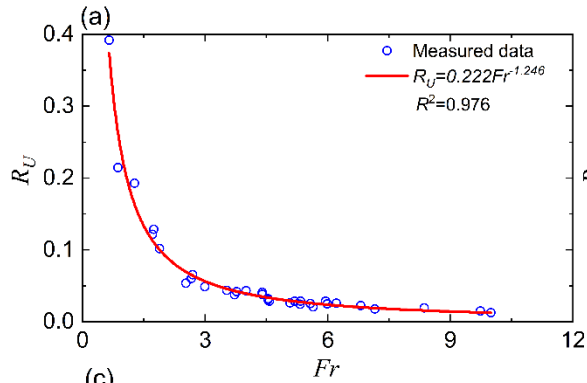
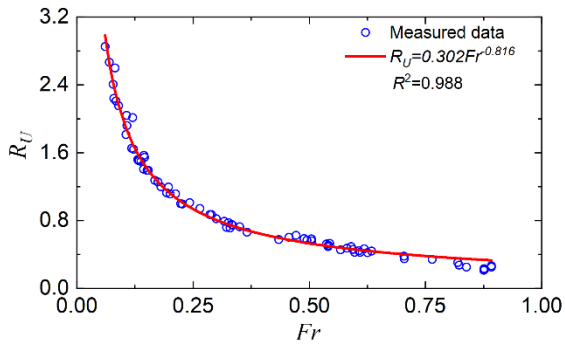

Highlights :

- A large-scale laboratory platform was constructed with a two-layer structure
- Laboratory experiments were conducted to study discharge capacity of street inlet
- A unified discharge formula was proposed using the dimensional analysis method
- The accuracy and universality of the unified formula were validated in detail

Journal Pre-proofs