



Ammonia combustion in furnaces: A review

A. Valera-Medina^{a,*}, M.O. Viguera-Zuniga^b, H. Shi^a, S. Mashruk^a, M. Alnajideen^a,
A. Alnasif^{a,c}, J. Davies^a, Y. Wang^{d,e}, X. Zhu^d, W. Yang^f, Y.B. Cheng^{d,e}

^a College of Physical Sciences and Engineering, Cardiff University, Wales, UK

^b Universidad Veracruzana, Veracruz, Mexico

^c Engineering Technical College of Al-Najaf, Al-Furat Al-Awsat Technical University, Najaf, Iraq

^d Foshan Xianhu Laboratory, Guangdong, China

^e Wuhan University of Technology, China

^f Korea Institute of Industrial Technology, South Korea

ARTICLE INFO

Handling editor: D.-V. No. Vo

Keywords:

Ammonia combustion

Furnaces

Co-firing

NOx emissions

ABSTRACT

Ammonia is a formidable chemical that has been investigated over 150 years for its use in the chemical processing field. The potential of the molecule to be used in farming applications has enabled a demographic explosion whilst its implementation in refrigeration technologies ensure continuous operation of cooling systems at high efficiencies. Other areas have also benefited from ammonia, whilst the use of the molecule in fuelling applications was scarce until the 2010s. A combination of factors that include climate change and energy dependency have reignited the interest of using ammonia as an energy vector that can potentially support applications that range from small devices to large power applications, thus supporting the transition to a net zero economy. Therefore, ammonia appears as a tangible option towards the reduction of emissions that can support a truly carbon-free energy transition in the coming years. As the recognition of the molecule increases, research areas based on combustion processes have also expanded towards the utilization of ammonia. The research around the topic has considerably augmented not only in the academic community, but also across governmental institutions and industrial consortia willing to demonstrate the potential of such a chemical. Therefore, this review approaches the latest findings and state-of-the-art research on the use of ammonia as a combustion fuel for furnaces. Different to other reviews, the present work attempts to gather the latest fundamental research, the most critical technologies evaluating ammonia for system operation, and novel approaches that suggest various breakthrough concepts that will ensure the reliable, cleaner consumption of the molecule as furnace fuel. Further, the present manuscript includes the latest research from all corners of the world, in an attempt to summarise the extensive work that dozens of groups are currently conducting. Finally, future trends and requirements are also addressed, providing guidance to those interested in doing research and development in ammonia-fuelling systems.

1. Introduction

The International Energy Agency (IEA) has forecasted a continuous increase in energy demand over the next decade, a demand that will potentially reach a five-fold increment by 2050. The economic rises of developing regions will be the main driver of this scenario, hence increasing the stress caused on both ecosystems and the environment to ensure that enough power is produced at the time. The picture denotes a background where large carbon dioxide emissions are emitted, hence posing one of the most critical challenges to humanity over its entire

history.

Climate change, as documented and followed by the Intergovernmental Panel on Climate Change (IPCC), has been mainly caused by the large production of carbon dioxide and other greenhouse emissions, which have increased the planets temperature up to 1.2 °C. Estimations and further calculations predict that the situation could lead to temperatures reaching above 2 °C from the current averages [1], a situation that can culminate in the irreversible destruction of ecosystems across the world. Therefore, industrialization combined with continuous emission of greenhouse gases will have a direct impact on living

* Corresponding author.

E-mail address: valeramedinaa1@cardiff.ac.uk (A. Valera-Medina).

<https://doi.org/10.1016/j.ijhydene.2023.10.241>

Received 24 May 2023; Received in revised form 18 September 2023; Accepted 23 October 2023

Available online 14 November 2023

0360-3199/© 2023 The Authors. Published by Elsevier Ltd on behalf of Hydrogen Energy Publications LLC. This is an open access article under the CC BY-NC-ND license (<http://creativecommons.org/licenses/by-nc-nd/4.0/>).

standards whilst also reshaping the global economy [2].

For this reason novel methods for energy generation have been conceived. Mainly wind, solar and marine energy are now under scrutiny for the recovery of sustainable energy. Wind energy, in particular, has received considerable support across nations due to its clean nature. On the basis of rotating dispositives, wind turbines can produce electrical energy when connected to electrical generators. According to the International Energy Agency (IEA) [3], the total installed capacity of wind energy was 467.4 GW in 2016, a trend that continues to increase yearly reaching a 68 GW annual addition by 2022 [4]. The reduction in production costs, increase in subsidies, and a well-known technology, all have contributed to the increase in electricity generated via wind sources [5–7]. Simultaneously, solar energy has gained extensive acceptance. Solar photovoltaics (PV), solar thermal electricity and solar heating-cooling are now well-established technologies [8–10]. The cumulative installed capacity of solar thermal installations reached an estimated 456 GWh by the end of 2016 [9] with a surging capacity of Photovoltaic generation of 994 TWh by 2021 [11]. Finally, marine energy has also a great potential to support renewable energy. However, due to the immature nature of the technology, only 0.5 GW capacity was documented in 2018 [12], with an increase of 400 GWh from 2019 to 2020 [13].

However, wind and solar energy present a tremendous challenge. Wind and solar exposition vary based on weather and seasonal conditions, making these energy types intermittent in nature. Moreover, vast amounts of these energies, stranded in difficult-to-access locations, cannot be recovered economically using direct connections to the local grids. In terms of marine energy, the high costs, complex market and fluctuating energy production are still the main barriers to full deployment of marine-based technologies. These facts, combined with political, social and public perception factors can halt the harvesting of renewable energies capable of reducing both fossil fuel dependency and climate change emissions.

Amongst the methods for energy storage that can be used to recover these resources, chemical energy storage has been used for centuries. Fossil fuels are testimony to our great dependence on chemical energy storage. Thus, the use of chemicals with low or null carbon content presents a unique solution for the recovery of renewable, intermittent resources. Out of the possibilities, hydrogen storage presents an opportunity to use a chemical with zero carbon content and high gravimetric energy density. Unfortunately, hydrogen also presents challenges associated to its intrinsic nature. The molecule, the smallest in the universe, tends to permeate a great variety of materials, whilst its control in large power generation systems (i.e. combustion-based) possesses stability issues. Finally, the explosive nature of the molecule combined with fast burning velocities makes hydrogen a molecule difficult to handle compared to other conventional sources. Simultaneously, it is estimated that the costs of hydrogen storage for long periods can be economically unviable for many applications, as the molecule needs to be cooled down to cryogenic conditions below 20K (–253 °C). It is for these reasons that other molecules are under assessment, hence supporting the concept of a “hydrogen economy”.

Ammonia, a molecule that has been used for over 180 years, presents a unique platform for hydrogen storage and renewable energy delivery. Ammonia from coal distillation has been obtained since the 1860s for fertilizing applications. Ammonium sulphate, a product of ammonia and sulphuric acid, was produced to support a growing industry that at the time reached ~140,000 tons/year [14]. Ludwig Mond, a German-British chemist, discovered a new process to produce ammonia via the combustion of coal with air and steam in 1889 [15]. His findings denoted how low-quality coal could produce valuable gases when exposed to superheated steam. Around 220,000 tons/year of ammonia were produced every week via this process, reaching efficiencies close to 80% [16]. By 1923, 90% of all coke oven plants in the Ruhr district used this process [17] hence making this one of the preferred methods of ammonia production before World War II. It would be the onset of the

Haber-Bosch (H-B) process that would see the era of coke-based ammonia reach its end [18].

Currently, the main method for ammonia production is the Haber-Bosch process [19] via super large scale plants capable of producing between 2000 and 3000 t/day, a capacity that is expected to increase substantially in the coming years. Overall, the synthesis of the molecule follows a reversible exothermal reaction (R1) [20–22],

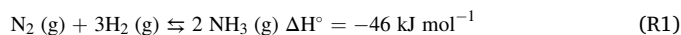

As in (R1), ammonia from the H-B process can be produced with hydrogen from any source. When hydrogen is produced using green sources, the ammonia product is catalogued as “green ammonia”. If the hydrogen comes from fossil sources, the final product is termed “grey ammonia”. In case carbon capture and storage (CCS) is used as part of the process of cleaning up the hydrogen, the final ammonia product is considered to be “blue”. In cases where the hydrogen comes from coal or waste, “brown ammonia” is produced. Finally, the production of hydrogen and ammonia via nuclear energy will deliver “pink” chemicals [23].

Irrespective of the type of ammonia that is produced, there is currently a large infrastructure to move and distribute ammonia globally. It is estimated that around \$200 Billion USD of ammonia are traded across the world, mainly for fertilizer applications. However, and as previously emphasized, climate change protocols are leading to the deployment of either “green” or “blue” ammonia. Pink ammonia, potentially feasible at a large scale with the maturity of technologies such as fusion reactors, is still far away in most economic forecasts.

On those lines, several projects seek to establish the foundations for the production, distribution, storage and utilization of green ammonia. Recently, RWE announced the construction of an ammonia terminal in Brunsbüttel, Germany. The company sees green ammonia as one of the most competitive hydrogen vectors due to its technological maturity [24]. In support of an LNG terminal, the green energy project will ensure the transition to low-carbon molecules. The announcement has been welcomed across the community and governmental bodies, especially under the geopolitical situation of Europe in 2022. It is estimated that 300,000 tons/year of green ammonia will be distributed from the terminal by 2026. The site will also operate an ammonia cracker, thus delivering green hydrogen via dedicated pipelines [24]. On a similar announcement, Gasunie, HES International and Vopak have joined forces to develop an ammonia terminal in Rotterdam, the Netherlands. The terminal will be complemented with ammonia crackers capable of delivering hydrogen as a fuel by 2026 [25].

Japan, the leading country in the use of ammonia, has also ambitious plans for the chemical in both the process and energy industries. NEDO (New Energy and Industrial Technology Development Organization) currently announced a ~\$500 Million USD program dedicated to ammonia R&D. Under that umbrella, JERA, Japan’s power utility company, has recently launched an international bidding to procure 500,000 tonnes/year of fuel. The contract will run from 2027 to the 2040s. The fuel will be used for co-firing applications with coal in the Hekinan power plan, which aims to demonstrate the co-firing of up to 20% ammonia by 2024 [26]. The project, in collaboration with IHI, seeks to demonstrate up to 50% co-firing by 2030.

Similarly, Mitsubishi Power announced the development of 100% ammonia-fed boilers for industrial heat applications. Demonstration of the reliability of these systems will be conducted by JERA in their coal power stations by 2028, in parallel to their Hekinan demonstration project [27]. The initiative comes in hand with the announcement of the first gas turbine running on pure ammonia. Mitsubishi Heavy Industries communication rose stakes across Asia, delivering news that a 40 MW H-25 Series power unit would employ solely ammonia to produce energy by 2025 [28]. The announcement came in conjunction with a 2 MW IM270 gas turbine that IHI corporation intends to operate using liquid ammonia [27]. Finally, all these works seek to have an impact on the

ASEAN countries through collaboration agreements that will ensure that ammonia-based technologies from Japan are implemented for carbon reduction in the region. Evidence of these agreements is the MoU signed between IHI, Kowa and Adani Power to perform feasibility studies of ammonia-coal co-firing at the Mundra power plant in Gujarat, India. From 20% ammonia, the study will seek to reach up to 100% ammonia in the process burners [29].

Toward carbon neutralization by 2050, South Korea announced that 2.1% of total electricity generation would be conducted by hydrogen and ammonia by 2030, and will increase to 7.1% by 2036 [30]. Due to limitations in renewable sources, most green hydrogen should be imported in the form of green ammonia. It shows that most combustion applications such as thermal power, industrial boilers and furnaces will be made by direct combustion of the chemical. In 2021, the Ministry of Industry, Trade and Energy (MOTIE) launched a promotion team for power generation demonstration purposes using hydrogen/ammonia. The team includes Korea Electric and Power Corporation (KEPCO), five public power generation companies and private companies related to value chains of hydrogen/ammonia provision [31]. Industries such as steel and cement are also performing feasibility studies and participating in governmental R&D projects on ammonia combustion.

Co-firing to coal power plants is expected to be the first commercial application using ammonia combustion. KEPCO and various public power generation companies funded a \$12 M USD (KRW 15.8B) project that started in 2022 [32]. The project consists of four sub-projects: Ammonia co-firing to (1) pulverized coal (PC) boilers, (2) circulating fluidized bed (CFB) boilers and (3) gas turbines + (4) ammonia supply chains. Major Korean boiler makers and chemical companies as well as research institutes and universities are engaged in this project and are conducting preliminary studies for two years. Successive to the project, in 2023, MOTIE has funded a 5-year demonstration project aiming at 20% ammonia co-firing to four commercial-scale power plants: two PC boilers including Shin Boryeong power plant (owned by Korea Midland Power Co., 1000 MWe \times 2 units) and two CFB boilers including Samcheok power plant (owned by Korea Southern Power co., 550 MWe \times 4 units). After the demonstration project, the 20% co-firing will be extended to other 24 coal-power generation units which have enough remaining life to fully characterise the advancement of using ammonia as a fuelling vector for industrial power scales [31]. After successful commercial operation of 20% co-firing, higher co-firing rates are planned after expected combustion system modifications.

Having a similar vision, China has recently jumped on the train of ammonia energy. In January 2022, the Chinese government took a significant step towards promoting the development of new energy storage, releasing the “14th Five-Year Plan for New Energy Storage Development Implementation Plan” jointly with the National Development and Reform Commission (NDRC) and National Energy Administration (NEA) [33]. Notably, ammonia was included as an energy

storage medium for the first time. Later that year, the Ministry of Science and Technology (MOST) and National Natural Science Foundation (NSFC) announced at least three major national R&D projects to investigate the fundamentals of ammonia combustion and to develop ammonia co-combustion technology with coal and natural gas. These initiatives aim to decarbonise the primary energy sectors and represent a further commitment by the Chinese government to sustainable development.

China’s growing interest in ammonia energy can be attributed to the spatial and temporal mismatch between green energy production and consumption. As shown in Fig. 1, wind and solar resources are primarily located in the northwestern areas of the Chinese mainland, while energy consumption is concentrated in the south and east. Liu et al. [34] indicated that the potential for wind and solar power in the northwestern provinces exceeds 3000 TWh/year, while in the east and south, it is less than 800 TWh/year. However, the projected electricity demand in the east and south in 2050 is over 1000 TWh/year, necessitating the storage and transportation of green energy over long distances. Such necessity is also enhanced by the inherently unstable output of wind and solar power plants due to variations in weather conditions. Hydrogen and ammonia are both zero-carbon energy carriers that can be utilized for large-scale energy storage and transport. In comparing the two, ammonia is widely recognized as having further advantages over hydrogen because of the easiness of its liquefaction as well as the already existing infrastructure of ammonia handling and transportation as discussed previously. Therefore, it is expected that ammonia will play an increasingly important role in helping China achieve its “2060 Carbon Neutrality Target” announced by the government in 2020.

As illustrated in Fig. 2, the majority of China’s CO₂ emissions are generated through the combustion of hydrocarbon fuels for electricity and heat generation from coal (45%), manufacturing and construction industries (36%), and transportation (11%). The Chinese government has enforced regulations to reach peak CO₂ emissions before 2030, mounting significant pressures on these industrial sectors to decarbonise. As a result, technologies that can facilitate decarbonisation, such as ammonia energy, are gaining increasingly more attraction in power generation and manufacturing sectors. For instance, last year, the China Energy Group, a state-owned mining and energy corporation, successfully demonstrated the co-firing of 35% ammonia with coal at the Yantai coal power plant in Shandong Province [35] and Foshan Xianhu Laboratory produced the world’s first ceramic tile in an industrial kiln using pure ammonia as the fuel [36]. More cases and details on the application of ammonia energy in industry will be discussed in Section 3.

Interestingly, current works and developments point to Asia as the location where the dawn of an ammonia economy will occur. As previously raised, Japan, China, Singapore and South Korea are heavily developing these technologies for decarbonisation purposes of many processes, including coal power plants. India is also joining the race to

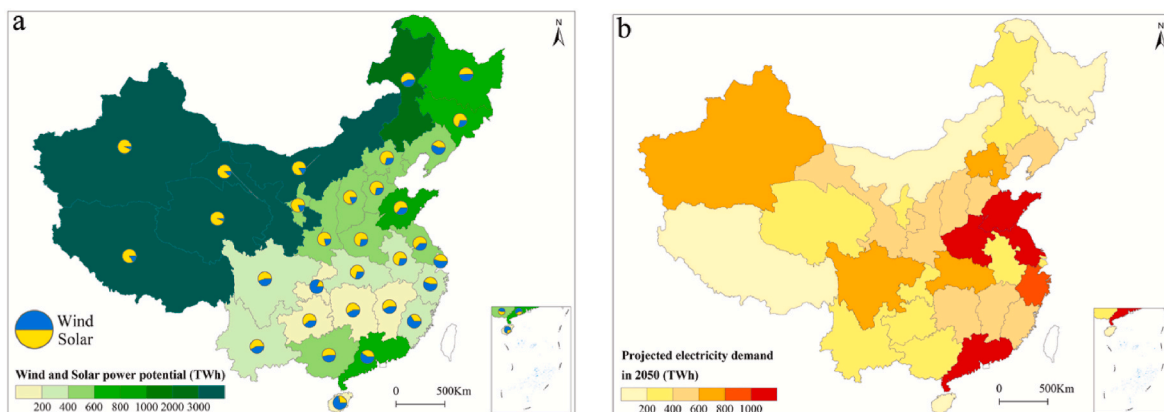

Fig. 1. China’s wind and solar power potential and projected electricity demands in 2050 [34].

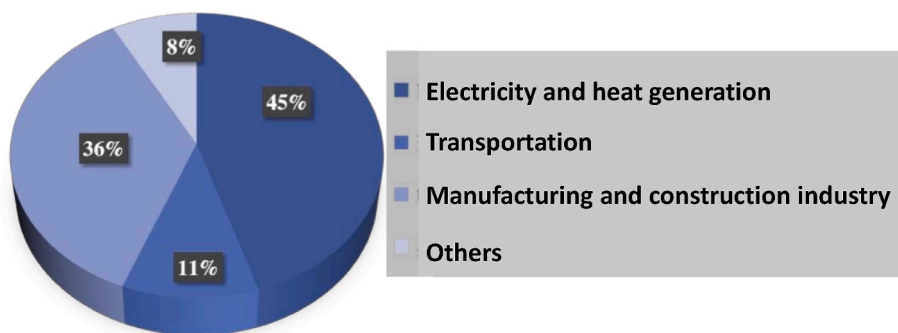

Fig. 2. China's CO₂ emission sources (from China Energy Statistical Yearbook 2020 [37]).

develop unique technologies capable of employing ammonia efficiently. Environmental sustainability is critical for current and future generations, hence requiring programs where carbon-zero fuels such as ammonia can be used to mitigate greenhouse emissions whilst providing energy requirements of such growing economies. From advanced powertrains where ammonia/hydrogen combinations have been assessed to determine emissions and performance impacts under a variety of conditions (ie. compression ratios, ignition timing, blending percentage and substitution, etc.) [38–40] to large power units modified to receive ammonia [29], India presents a unique set of opportunities not only due its formidable farming background, but also due its large ammonia production capacity which represents 8% of the global production [41]. India's excellent renewable potential (ie. with the lowest installed solar PV cost globally at \$591 USD/kW in 2021), farming infrastructure and heavy industries capacity are ideal for the production of green ammonia that can support global decarbonisation [42] whilst serving to power many of the industries of the third largest economy of Asia [43].

Research and development agendas have also opened for the use and demonstration of ammonia and hydrogen vectors to decarbonise heat, power and cooling across Europe. A recent project worth \$13.1 Million USD was granted to a consortium led by Strathclyde University, UK. The project seeks to demonstrate the feasible and economic production of green hydrogen from offshore facilities, whilst delivering the chemical via ammonia and other vectors to various locations of such a country. Potential analyses have envisaged the production of green ammonia and its distribution from Oakney, Scotland, to the Teesside Free Port, England, where further distribution to “ammonia city gate” terminals will be studied for delivery of either cracked hydrogen to cities or fuel ammonia to rural locations [44]. Similarly, a project granted by the Department of Energy Security and Net Zero (DESZN) is pursuing the development of industrial boilers that can be fired using ammonia blends to replace propane gas. Although several studies have proposed using ammonia as a vector for delivering hydrogen, this concept requires the cracking of ammonia to hydrogen at the end-use site. This is an energy-intensive, high-temperature catalytic process that increases costs and/or carbon emissions of the supply chain. Ammonia-fueled boilers remove the requirement for cracking, reducing costs and carbon emissions compared to ammonia used to deliver hydrogen. With the phasing out of fossil fuels (including propane), the approach will enable the decentralization of heat and power generation in small communities and small/medium farming and industrial complexes, thus opening the possibility to decarbonise these locations without incurring in greater costs product of the creation of hydrogen pipelines or electrical grid connections. It is expected that units of 1.5 MW will operate under these principles by 2025 [45].

Further announcements fill both social media and other dissemination sites. P2XFloater, the first floating production unit for green ammonia has been conceived to extend the life of very large gas carriers by converting them to floating ammonia plants. Using renewable sources, seawater will be desalinated onboard to feed 140 MW electrolyzers

and produce green ammonia. The chemical will then be transferred directly to vessels, bunkering vessels or other onshore infrastructure [46]. Marine systems might become the first technologies to commercially use ammonia for fuelling purposes, hence projects such as those led by Wärtsilä [47] with a multimillion support from the European Union will see the advancement of two-stroke version engines retrofitted to work with such a chemical by 2025. Innovative concepts such as “subsea fluid storage systems” will support fuelling applications for offshore ammonia storage and cargo [48]. It is clear that these and many other projects currently ongoing across the world seek the development of technologies capable of delivering green ammonia at affordable prices and flexible conditions.

Finally, it has been recently announced that ammonia will also be used in aerospace applications in the U.S.A. Previous announcements, done by Reaction Engines, denoted the potential of using ammonia for cracking purposes to deliver hydrogen into their engines [49]. Similarly, a \$10 million USD program between the University of Central Florida, Georgia Institute of Technology, Purdue University, GE and Boeing seeks to use liquid ammonia for the production of hydrogen through cracking, which will be combusted for propulsion purposes. Excess ammonia will be used to reduce NO_x emissions in a 737-8 Boeing aircraft. The team hopes that ammonia will be used commercially for these applications between 2040 and 2050 [50]. Similarly, Aviation H2 in Australia have selected liquid ammonia as combustion fuel towards the development of hydrogen-powered aircrafts. Based on the existing Dassault Falcon 50, the project aims to have a demonstrator by 2023 [51].

Ammonia has gained considerable acceptance from the industrial sector for the production of power, heat and propulsion employing combustion systems. However, there are still unanswered questions that require further research and development to reduce emissions such as NO and N₂O, unburned ammonia and carbon monoxide when co-firing. Concurrently, improvements in efficiencies for better economics are still critical for the advancement of this technology. All these points, in conjunction with better reaction mechanisms, better computational models, a greater understanding of fundamental phenomena and practical implications of using ammonia, make this review an important contributor to the dissemination of the latest research and development in the field of ammonia combustion for furnace applications.

2. Combustion impacts on thermal systems

2.1. Materials

In the development of combustors and other high-temperature components, both design, dimensions and materials selection are highly dependent on the gas temperatures, compositions, flow rates and stresses exerted by the combustion environment on the components. However, literature towards the suitability of existing materials for ammonia-based combustion is scarce. Properties of ammonia-based blends vary considerably from traditional hydrocarbon blends, causing

some of the following challenges in the utilization of existing component designs and materials.

An interesting finding obtained by the U.S. Army program revealed that Inconel 600 barely denoted deterioration whilst being exposed to hot flows. Components such as nozzles, scrolls or liners resisted the impact of these hot flows. Inconel X and 713C also showed satisfactory resistance. Transient tests were inconclusive at the time [52]. Similarly, initial tests conducted by AIST have demonstrated that the use of ammonia can deteriorate various materials due to hydrogen embrittlement, nitration and the impact of acids (ie. nitric acid) or bases (ie. ammonium). However, the use of thermal coatings based on zeolites and yttrium can be employed. Preliminary results [53] denote the higher resistance of these coatings to avoid metal degradation during combustion operations that are known to generate a series of species from basic (i.e. NH_4^+) to acid (HNO_3) environments. However, further analyses are required to fully understand the material science behind these effects.

Ammonia is also frequently blended with hydrogen, which has a higher laminar burning velocity and propensity for flashback (compared to lean blow-off promoted by ammonia). Mashruk et al. [54] and Khatteb et al. [55] have shown that adding ammonia in blends of premixed ammonia/methane and ammonia/hydrogen decreases the range of stable equivalence ratios, with the equivalence ratio at which lean blow-out occurs increasing almost linearly, and then more rapidly above a critical ammonia fraction. Cracking to produce a hydrogen/nitrogen blend does not change the stability limits significantly to that of the equivalent ammonia/air blend. Poor flame stability can lead to flame detachment from the burner or flashback, both of which can cause damage or overheating in the combustion device. This is similar to the review of Nazari et al. [56] which highlights the issues of hydrogen fuel flashback and its potential to cause damage, with the potential solution of adding nitrogen as a dilutant to the fuel blend.

Recent work [57] studied the behaviour of nickel-base alloys exposed to premixed hydrogen/ammonia/air flames finding that ~ 5 times higher hydrogen desorption from the metal compared to premixed methane/air flames. The significance of metals to hydrogen in ammonia-based flames (for example from fuel hydrogen or increased water vapour content), is due to the ability of hydrogen to insert into the metal and modify its mechanical properties. These modes can be classified into hydrogen embrittlement, stress corrosion cracking or hydrogen-induced cracking. However, under the conditions of this study, hydrogen exposure levels were too low to significantly impact mechanical properties at room temperatures, warranting future studies to further explore the effects of more extreme exposure conditions and mechanical properties at elevated temperatures. Significant efforts have been made to understand the impact of hydrogen desorption on high-temperature materials, often through cathodic hydrogen polarisation at slightly elevated temperatures to accelerate the impact of hydrogen concentrations at slightly elevated temperatures, Fig. 3.

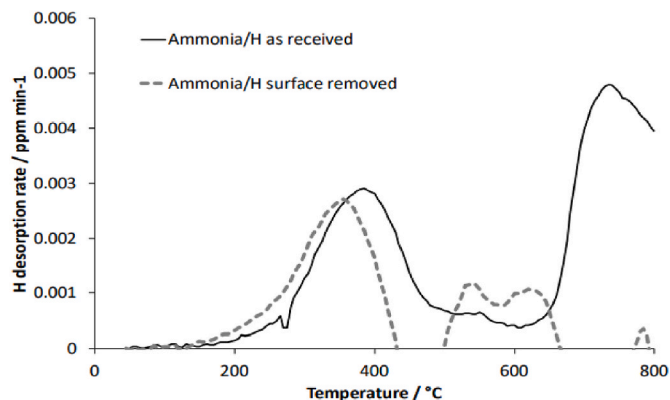

Fig. 3. TDA results for samples exposed to ammonia/hydrogen [58].

Further studies conducted by Wang et al. [59] evaluated the use of materials commonly employed for steel nitriding (SACM645) and for structural/ducting components (SUS304 and SUS301S). The materials were exposed to ammonia flames, showing deterioration caused by nitriding effects, Fig. 4. The results were correlated to the diffusion of nitrogen atoms that diffuse at various depths (ie. 25–50 μm under the analysed conditions) depending on the crystallographic structure of the material of interest with cubic-centred structures being more prone to diffusion than face-centred ones. However, higher nitrogen atoms for SUS were observed at the centreline of the experimental setup, a condition attributed to the higher solubility of nitrogen atom in $\gamma\text{-Fe}$ (4.5 wt %) than that in $\alpha\text{-Fe}$ (0.1 wt%). However, these are the first analyses of its kind around the subject, requiring further studies to properly understand the impact of ammonia flames on various materials.

It is common practice to use ammonia solutions (such as ammonium hydroxide) in boilers to increase pH, thus reducing corrosion in various components. The injection of NH_3 in these systems brings not only brings to safer pH the solutions, but also limits the dissolution of corrosive metal ions [60]. Interestingly, this diluted ammonia can also change its corrosive nature depending on the exposure conditions. Going from uniform corrosion, cracks, corrosion under stress, nitration, etc. temperature and pressure play important roles in the impact of ammonia on materials. Hence, it is critical that for operating systems such as furnaces a good understanding of the effect of ammonia combustion is acquired.

An interesting parameter considered for other systems but not for fuelling yet is the corrosion that ammonia can cause when exposed to carbon oxides. Ammonium carbonate, which starts forming with only 5ppmV of COx, has severe effects on the integrity of various materials. Hence, the use of some steels is not desirable when operating with ammonia flows. However, lower corrosivity at ambient temperature of micro-alloyed carbon steels improves these characteristics, thus making these materials the preferred option for ammonia storage tanks. Care needs to be taken in the presence of residual stress, which can propagate discontinuities and lead to fracture. The problem can be solved by thermal processes that reduce the residual stress and by the addition of small water quantities (circa 0.2%). Stress corrosion cracking (SCC) is another recurrent problem that occurs under cold temperatures and the presence of residual stress as a consequence of the anodic dissolution caused by thin layers of iron oxides [61]. Oxygen content and carbon dioxide also favour corrosion, hence requiring inhibitors and coatings that can protect both metallic and ceramic layers.

It is also important to notice that ammonia can be easily contaminated by other molecules that industrially tend to be present in various processes. For example, HCl and ammonia have a severe impact on the integrity of containers [62]. Similarly, the addition of CO_2 , greater water contents, oxygen, etc. can have damaging effects on carbon steels even at atmospheric conditions. A recurrent material that is regularly avoided when using ammonia is copper. Interestingly, copper alloys would not be attacked by ammonia solutions under the right conditions (ie. $\text{pH} > 7.0$ and the right potential, thus leading to material passivity), forming protective oxides at slow pace without material detachment [63]. However, and as expected, these conditions are very specific and uncommon in regular practice. Under most conditions, water and ammonia lead to the production of NH_4OH which has an aggressive nature towards copper-based materials. If residual stress is present, an almost negligible 1ppmV of ammonium can lead to cracking of brass components.

As previously pointed out, one of the main contaminants of ammonia is oxygen, which at just 1ppmV can start corrosion. The issue becomes more acute when the components exposed to these blends have been welded or cold formed. If the steels contain Ni or Mo, these materials are also very vulnerable to this corroding effect. Therefore, the presence of small quantities of water (as previously depicted) can reduce the problem by mitigating the oxygen impact when present in up to 200 ppmV concentrations.

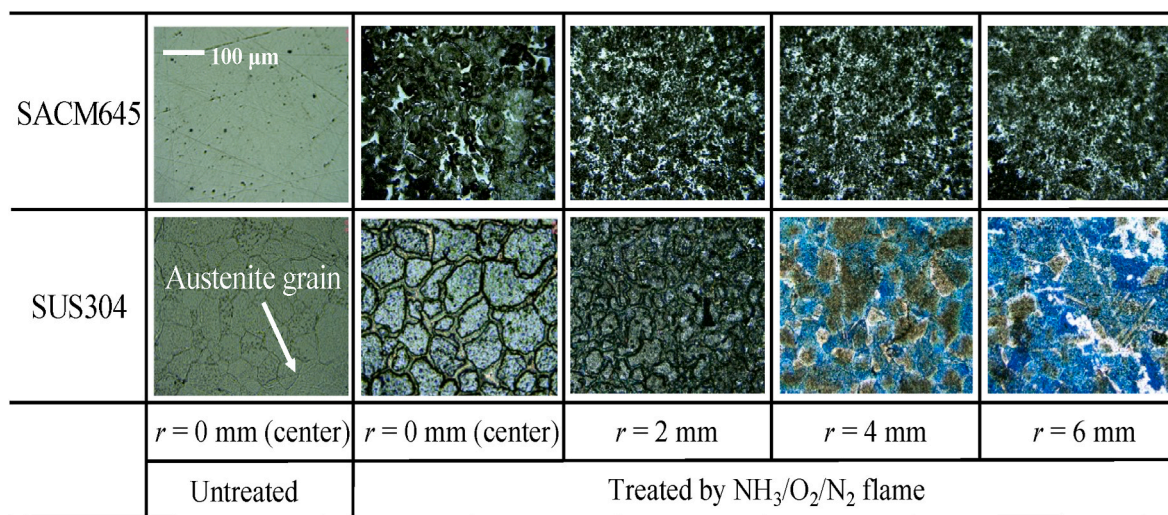

Fig. 4. Optical micrographs of the SACM645 and SUS304 test plate surfaces after being exposed to the $\text{NH}_3/\text{O}_2/\text{N}_2$ flame at 550 °C for 5 h [59].

Other materials suffer the impacts of ammonia-based solutions, such as rubber or various plastics, hence requiring the change of these components in practical applications for materials that can withstand the impact of NH_3 . It must be remembered that for many applications, especially those concerning furnaces, the study of these impacts is still unknown. High-temperature flows comprised by unburned ammonia, water streams, hot molecular and atomic hydrogen, and oxygen traces can have various impacts that are still unaccounted for. Therefore, the subject requires its own investigation and a dedicated line of research.

As previously mentioned, the science behind these effects is just forming, hence requiring more robust programs to depict the impact of ammonia combustion at the molecular level of various materials.

2.2. Emissions

One of the main obstacles in the deployment of ammonia as a fuel is its proficiency in fuel NO_x production. Fuel NO_x is formed when nitrogen is chemically bonded to the fuel -which is the case for ammonia (NH_3)- through the production of intermediate products such as CN, HCN, HNO and NH_i , and further oxidation. Considerable amounts of thermal NO_x can also be generated with high enough flame temperatures [64]. Nitrogen oxides present a significant risk to both health and the environment. These emissions can affect drinking water distribution [65], cause eutrophication [66] and aggravate lung diseases if inhaled [67]. Nitrous oxide (N_2O), another prospective product of ammonia combustion at certain operating conditions, has 280 times 20-year global warming potential (GWP_{20}) than that of CO_2 [68]. Recent studies [69] on ammonia/hydrogen blends have reported 240 ppm of N_2O emissions to have approximately equal global warming impact of CO_2 emitted from pure methane flame operating at dry low NO_x (DLN) scenarios.

According to the fact that flame stability control has an effective role in combustion efficiency and pollutant emission, an experimental study on the measurement of premixed ammonia-hydrogen-air mixtures flammability limits was carried out and the effects of diverse ammonia concentrations and temperature on the flammability limits were perused [70]. Results proved that the flammability limits of lean mixtures were overall unchanged for temperatures between 673 and 873 K. As a comparison to premixed flames, the stability limits of non-premixed ammonia-hydrogen-air flames were studied to investigate the effect of ammonia substitution on the flame stability range and NO_x emissions [71]. Results indicated that ammonia addition improved the safety of hydrogen implementation and caused suitable quantities of NO_x emission. Further tests indicated the high efficiency of a porous burner in ammonia

combustion systems. Probe measurements were also used to evaluate the quantity of nitric oxide emission of methane-ammonia-oxygen-nitrogen post-flame zone by Konnov et al. [72]. They revealed that the maximum concentration of NO_x occurred near stoichiometry conditions. Increasing interests in non-premixed ammonia mixture flames caused more investigations in this field. Woo et al. [73] examined non-premixed ammonia-methane flame focusing on the effective parameters of NO_x formation. They showed a monotonous increase of NO_x formation with increasing ammonia concentration while the maximum NO_x emission was observed at an oxygen ratio of 0.7. Results proved that the NO_x formation process depends mainly on the reacting flow structure. Investigation of premixed ammonia-hydrogen-air flame through a porous media was carried out focusing on the flame stability limit [74]. Silicon-carbide was used as the flame holder porous medium and the mixture was examined with high ammonia concentrations at standard temperature and pressure conditions. Decreases in flame stability limits were reported with increasing the ammonia mixture fraction. The study revealed that the NO formation decreased with increasing the equivalence ratio. Also, results suggested decreases in ammonia content increased the upper and lower flame stability limits.

Fuel NO_x production routes from ammonia have been extensively studied by many researchers [75–77]. Ammonia reacts with OH radicals to produce NH_2 radicals in both rich and lean conditions, which convert to HNO directly by reacting with O radicals and via NH radicals by reacting with OH. Nitroxyl (HNO) is the main source of fuel NO production in ammonia flame through reactions with molecular oxygen, H and O radicals, as well as through disassociation processes [78]. NH radicals also produce NO by reacting with molecular and atomic oxygen. Substantial amounts of NO in the flame react with NH radicals to produce N_2O which mostly converts to N_2 by reacting with H radicals and through the third body reaction $\text{N}_2\text{O}(+\text{M}) \leftrightarrow \text{N}_2 + \text{O} (+\text{M})$. Other prominent sources of NO reduction are through the chain branching reaction $\text{NH}_2 + \text{NO} \leftrightarrow \text{NNH} + \text{OH}$ and the terminating reaction $\text{NH}_2 + \text{NO} \leftrightarrow \text{N}_2 + \text{H}_2\text{O}$ [79].

Other studies [80] dedicated to fuel-rich conditions have identified NNH disassociation pathway to play an important role in producing N_2 without forming NO under fuel-rich conditions. The initial work by Dean et al. [81] led to the development of the NNH mechanism by Dean and Bozzelli [82] which identified the reactions between NNH intermediate and atomic O as follows: $\text{NNH} + \text{O} \leftrightarrow \text{NH} + \text{NO}$, $\text{NNH} + \text{O} \leftrightarrow \text{N}_2\text{O} + \text{H}$, and $\text{NNH} + \text{O} \leftrightarrow \text{N}_2 + \text{OH}$. Later on, Klippenstein et al. [83] calculated reaction rates for these reactions based on an improved model by Miller and Glarborg [84]. When it comes to the reaction of ammonia with carbonaceous species such as methane, the production of CH_x species

critically impacts the production of NO_x and CO_x emissions. Methane mainly reacts with OH and H radicals to produce methyl (CH_3) radicals which mostly convert to singlet CH_2 by reacting with OH radicals which can transform to triplet CH_2 . Substantial amounts of CH_3 directly convert to CH_2O by reacting with O radicals or via CH_3O . HCO, a great contributor to CO formation, is produced from the reactions between CH_2O and H/OH radicals. Some of the CH_3 directly converts to CO by reacting with O radicals. Nearly all of this CO converts to CO_2 by reacting with OH radicals. Some of the produced CO_2 react with NH radicals to produce HNO which is the biggest source of fuel NO formation as described earlier.

Recently, Mashruk et al. [54] investigated methane/ammonia/hydrogen ternary blends for the first time in a swirl burner at a constant equivalence ratio of 1.2 under atmospheric conditions. With increasing ammonia content (30/75 (vol%)) in the fuel mixtures, methane content decreased (70%/0% (vol.)) and hydrogen content increased by a small margin (10/30 (vol%)). Minimum N_2O and NO_2 emissions were observed for all the fuel blends at the rich condition. Significant NO emissions were observed at high methane mixtures due to the OH radical availability while NO emissions decreased significantly with increasing ammonia content in the fuel due to the increased availability of NH_2 radicals. NH_3 slip increased at first with decreasing methane content in the mixtures due to reduced OH and H radical availability but then dropped again as hydrogen content increased. At this stage, hydrogen chemistry became dominant and finally significant increase in ammonia slip was observed as ammonia chemistry took over.

Similarly, unburned ammonia emissions play an important role in the emissions profile of these systems. Any unburned ammonia will be part of any regulation, and therefore affect the design of these combustors. Ammonia at the exhaust can precede the formation of particle matter via ammonium sulfides and nitrates, hence deteriorating the environment. This is a problem for combustion systems running on ammonia at the planned power scales. Therefore, the systems need to be designed to ensure that slip ammonia is mitigated, avoiding nuisance caused by smells whilst ensuring the reduction of particle matter. However, the science behind the mitigation of these emissions is still being developed, with reaction mechanisms still showing discrepancies, materials denoting a variety of impacts in the production of emissions as third bodies, and conditions with various blends still waiting to be discovered.

3. Combustion applications

The possibility of using ammonia in combustion systems such as furnaces has been suggested since the nineteenth century. As a carbon-free fuel, ammonia shows very promising applications in the future low-carbon economy, motivating interest for ammonia combustion studies. Table 1 compares some main properties of NH_3 (e.g., burning velocity, auto-ignition temperature, and minimum ignition energy) with other commonly used hydrocarbon fuels, such as hydrogen, methanol, and gasoline.

A furnace is an “enclosed structure for intense heating by fire”. These systems are the basic building block of industrialised societies, with the main objective of reaching higher processing temperatures than those obtainable in open fires. They can facilitate chemical processes and

reactions, or support physical processes such as annealing or drying. Overall, furnaces can be classified in many ways, although one commonly used is based on the heat transfer concepts (sources and sinks) which are highly dependent on geometries, fuel types and heat transfer mechanisms [87]. Thus, ammonia furnaces can be separately categorized from their fossil-based counterparts, as the use of ammonia in these systems will present different sink/sources that will bring forward new technological concepts, and concepts that are under current evaluation by several companies. Examples include the development of medium size units that will support chemical processes and steam production in locations far from the grid, Fig. 5. Similarly, the use of ammonia at a large scale has found a niche application in Japan, where companies such as JERA are investing on R&D for the co-firing and replacement of coal by ammonia in power plants. Large facilities such as Hekinan Thermal Power Station are currently under development to push the maximum ammonia concentration that can be replaced in these systems. Particular to this site, it is expected that Unit 4 will switch to 20% ammonia by the late 2020s, requiring the process of up to 500,000 tons/year of ammonia [88].

Therefore, the point to address in this section is the use of furnaces fed with ammonia-blends. Ammonia furnaces can be used for processes, kilns and cement production, steam generation for power and chemical reactions, and other industrial areas where high heat is required [89]. One of the great advantages of using a furnace is that they are more robust and easier to operate than other energy production media with flexible systems that enable high accessibility for maintenance and retrofitting purposes, making these devices long-lasting. Although these devices tend to have large dimensions and very robust structures, their implementation across the industrial sectors make them a preferred solution when it comes to simple heat recovery applications or the use of alternative fuels such as ammonia.



Fig. 5. Commissioning of a 1.5MW unit operating with ammonia blends for steam production. Cardiff University Centre of Excellence on Ammonia Technologies.

Table 1

Key properties of ammonia and common fuels [85,86].

	Ammonia	Hydrogen	Methane	Propane	Methanol	Ethanol	Gasoline
Lower heating value (MJ/kg)	18.8	120.1	50	46.4	19.7	26.8	44.5
Maximum laminar burning velocity (m/s)	0.07	2.91	0.37	0.43	0.50	0.47	0.47
Flammability limit (Equivalence ratio)	0.63–1.4	0.10–7.1	0.50–1.7	0.51–2.5	0.55–2.9	0.66–2.4	0.7–4
Auto-ignition temperature (°C)	651	571	537	450	470	365	230
Minimum ignition energy (mJ)	8	0.011	0.28	0.25	0.14	0.28	0.8
Density (g/L, 25 °C, 1 atm)	0.703	0.082	0.657	493	787	789	740

3.1. Large scale furnaces

Ammonia has been a by-product of many processes, especially those that concern the use of large quantities of fossil fuels. This is evident especially in industries such as steel making, COG production, oil and gas exploration/exploitation, gasification processes, etc. However, since ammonia has not been considered as a viable fuel until recently, most of these facilities tend to flare or discard the chemical to the atmosphere. Therefore, several applications can be pursued to recover and employ this “waste” ammonia for the production of heat to support processes or the generation of steam for power applications.

Ammonia combustion in industrial furnaces has been conducted over the years by the company Duiker Combustion Engineers. Their approach seeks the use of ammonia as a heat source capable of raising water and steam temperatures for additional power generation. The concept also seeks to support processes such as Sour Water Stripping (SWS) in oil refineries, as the fumes from those locations contain ammonia traces with other chemicals that increase corrosion problems during the recovery of sulphur [90]. Since the removal of ammonia increases costs, the chemical needs to be used for additional heat production to reduce natural gas consumption on site, hence decreasing operation costs and levelling the use of ammonia recovery systems. The furnace design is based on the use of Stoichiometric Controlled Oxidation (SCO), which through a couple of chambers ensures rich combustion followed by leaner oxidation after quenching of the flame. The concept, similar in nature to the use of Rich-quench-Lean (RQL) technology for ammonia combustion in gas turbines [91], enables the stoichiometric control of the flame at the source, ensuring that unburned ammonia from the first stages is properly reacted with nitrogen oxides formed through the combustion process. Large nitrogen, water, and any remanent reactants (ie. ammonia and/or hydrogen) are finally combusted with the addition of excess air in the secondary combustion zone, completing the reaction and delivering high heating profiles. Results have ensured emissions <80 ppm (vol%) and temperatures ranging from 2000 to 1100 K between sections [90], Fig. 6. Ammonia flowrates have reached up to 2.684 kg/h in the latest commercial systems commissioned by the company.

Similarly, Uber Industries Ltd, Japan, have used ammonia for the production of cement in large production kilns [92]. Their program demonstrated that waste ammonia can be used to support the production of cement, whilst the final product (clinker) retains most properties when using ammonia fuelling. It has been estimated that the replacement of 1% of coal by ammonia in the sector could have massive CO₂ reduction implications (up to 160,000 CO₂ tons annually) [92].

Another tentative option for the use of furnaces is to employ oxygen

enriched atmospheres. Oxygen, product of air separation units used for nitrogen and ammonia production, could be employed to enhance the combustion process and increase ammonia burning stability. Co-firing ammonia with methane under oxygen-enriched atmospheres has been attempted experimentally and numerically using small-scale burners (10 kW). Emissions were controlled, whilst the combustion performance was improved [93]. An important issue when using ammonia is its low radiant heat flux due to no carbon. Thus, further work performed by Murai et al. [93] using a calibrated FTIR-C-20-120 spectrometer and IF fibres compared the radiation produced by pure ammonia, methane and oxygenated ammonia blends. An increase of oxygen content up to 30% (vol) considerably augments the radiation heat flux whilst bringing upstream the highest radiation point, Fig. 7. Values of oxygenated ammonia were even higher than those of methane, presenting a promising solution for furnace operation. Although the effect is mainly due to the increase in temperature (thus wall radiation), the use of oxygen-enriched ammonia for these processes is feasible for industrial purposes. In addition, the same results were confirmed by a demonstration study using a 100 kW class model furnace, which is closer to the practical scale of industrial furnaces used by industry [94].

Studies by Xiao et al. [95] also demonstrated that the use of the technique increases laminar burning velocity, whilst NO_x emissions remain constant at oxygen values up to 40% (vol). Employing a reduced version of Konnov’s mechanism, the study also demonstrated that the reaction $H + O_2 \rightarrow O + OH$ remains the most sensitive to the burning velocity. However, the reaction $HCO + M \rightarrow CO + H + M$ contributes more than $NH_2 + NO \rightarrow NNH + OH$ under oxygen enriched conditions. Further numerical analyses also denoted the impact of pressure, as previously described. The increase from 0.1 to 1.7 MPa has a drastic reduction in NO emissions, which are mainly produced via HNO. Similarly, CO emissions from NH₃/CH₄ co-firing are considerably reduced with the increase of pressure, Fig. 8. Methane consumed in the presence of high O/OH seems to produce CH₃, which through the production of CH₂O leads to large HCO pools that procure the CO emissions [95]. However, higher pressures tend to thin the flame whilst enhancing reactivity at both the flame and post-combustion zones, reducing both emissions. Further research running at ~40 kW denoted stable flames, where fuel-rich conditions showed low NO_x combined with large quantities of steam and nitrogen production [96], a point discussed in previous sections.

Numata et al. [97] also studied the use of ammonia in degreasing steel sheets using an impinging jet burner. Due to the challenges of the use of ammonia for these applications, an improved burner needed to be design specifically for the use of ammonia-natural gas co-firing. Different geometries, designs and arrangements were studied to

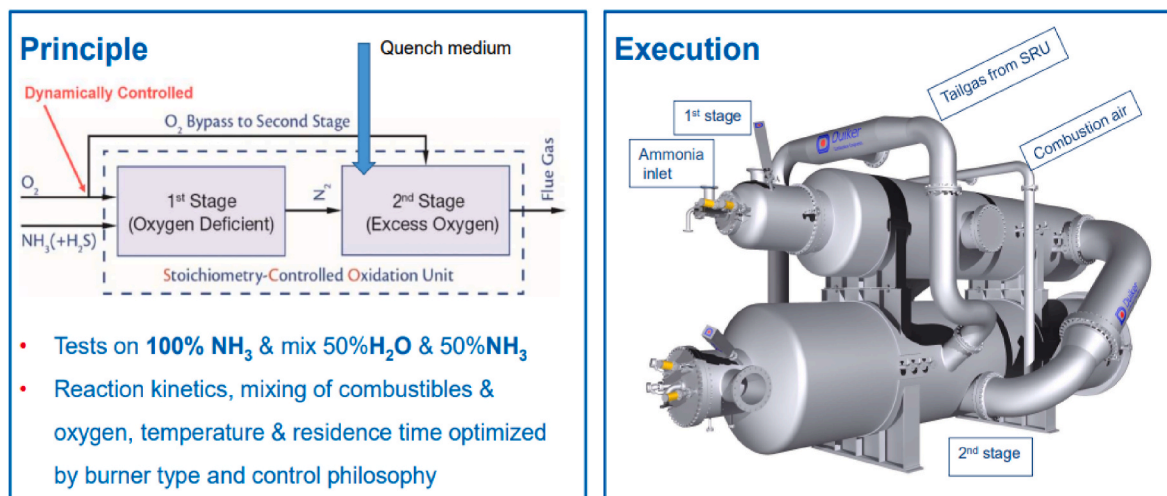

Fig. 6. Stoichiometric Controlled Oxidation (SCO) technology developed by Duiker [89]. (Courtesy of Duiker Combustion Engineers, reprint with permission).

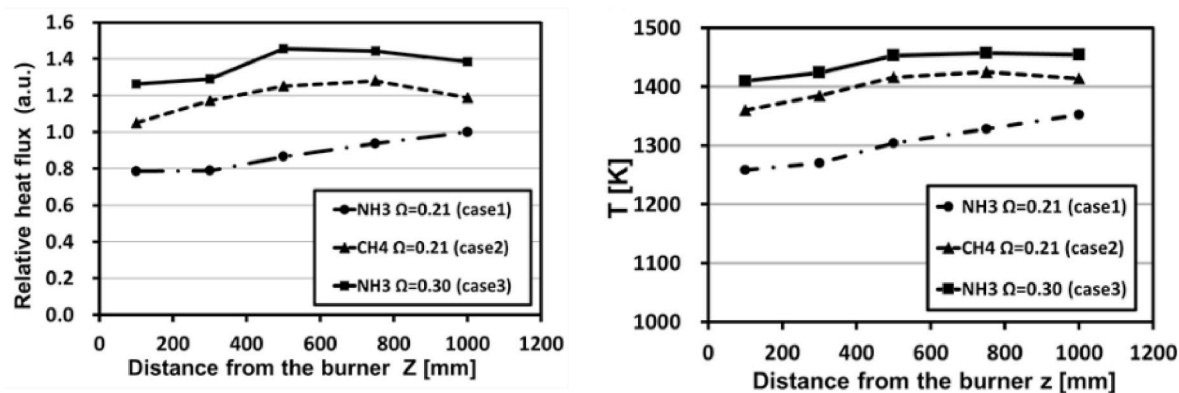

Fig. 7. Relative heat flux (left) and temperature (right) measurements using ammonia, methane and oxygenated ammonia blends [93]. (Reprint with permission).

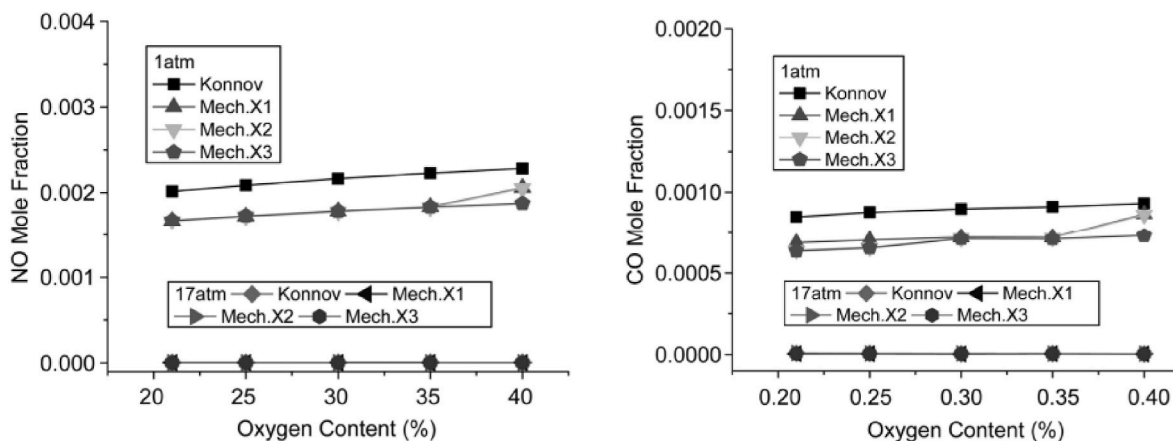

Fig. 8. Emissions from oxygen enriched ammonia-methane co-firing [95]. (Reprint with permission).

improve the heating profile for degreasing purposes of galvanized steel sheets used for the automotive, appliance and construction industries. It was found that the appropriate design makes feasible the use of ammonia for such an application, Fig. 9.

Ammonia combustion in furnaces has also been assessed as a substitute in coal power stations. The Japanese company Chugoku Electric Power Co., engaged in a program to employ ammonia as a substitute of ammonia in large boilers [98]. The Mizushima Power Station was retrofitted to enable the use of ammonia for power generation. A 156 MW unit was used for the test campaign. In order to use ammonia efficiently, the chemical was pre-vaporized and accumulated before accessing the boiler under the required flowrates. Up to 450 kg/h of ammonia (equivalent to 400 kg/h of coal) were used to produce 1 MW power at a

mixing rate of 0.6%. The results denoted that a slight increase in moisture content (~0.4%) was not detrimental to the combustion process, whilst no corrosion in the system was observed. Further, the recombination of ammonia in post-combustion sections reduced NOx fumes, leaving the final emissions level similar to those without retrofitting (340 ppm in vol.). Finally, The demonstration test confirmed that CO₂ emissions were reduced by the amount of NH₃ co-firing.

Follow-up work from IHI corporation, Japan, demonstrated experimentally and numerically the use of ammonia-coal co-firing in an existing coal-fired boiler [99]. As previously raised, emissions and heat flux on the boiler walls were the key topics of concern in the research. NOx was evaluated using a 10 MW thermal input facility using an ammonia-pulverized coal burner, Fig. 10. By injecting ammonia into the

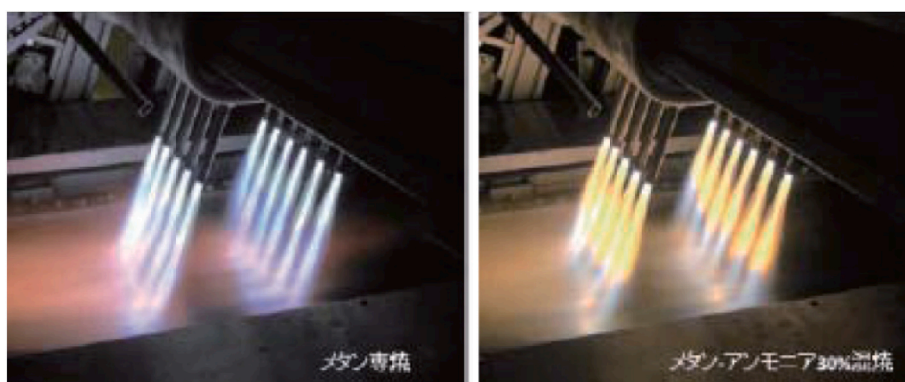

Fig. 9. Methane (left) and blended (right) combustion for degreasing steel sheets [97]. (Reprint with permission).

reduction zone, NO emissions were controlled, and it was confirmed that up to 20% (calorific base) can be used to replace coal without major detrimental to the process, emissions and combustion system. Concurrently, the heat flux on the wall was addressed numerically using a 1000 MWe power unit. Although the gas temperatures using ammonia co-firing are lower than with coal, the difference between heat fluxes were not too pronounced, Fig. 11. Ishihara et al. [100] conducted further tests at various co-firing ratios (0–80%) using detailed chemistry from Hashemi et al. model designed to simulate NOx formation and reduction in coal combustion. Soot (C166) and char (C412N5) were also included.

A reactor network, representing IHI burner, Fig. 12, and three different modes of ammonia injection was used for that purpose, Fig. 13. Results found that low CO₂ and NOx could be produced by the reduction of coal and various processes such as ammonia DeNOxing, lower temperatures and char-NO reducing effects, respectively. Additional work [102] showed that the increase of water content from ammonia combustion could also reduce CO by the water gas shift reaction,



The work also addressed the difference in reaction paths between the 20% and 80% cases with the 40% and 60% scenarios, Fig. 13. NO emissions are considerably reduced at 20% due to post-combustion reactions, whilst at 80% there are more effective reactions that do not involve NO production and that lead to N₂ via NH_i recombinations. Although 40% and 60% NO at the flame are kept low via reactions that produce N₂H₂ and NNH, the higher temperatures in the post-combustion zone elevate thermal NOx.

Supporting works also took place by the Central Research Institute of Electric Power Industry who investigated various methods to reduce NOx emissions in several test furnaces employing ammonia-coal co-firing [103,104]. Initial results denoted that with the increase up to 20% of low heat value using ammonia the concentrations of NOx were just slightly increased. It was also noted that the injection of ammonia in specially localized ports can also decrease NOx emissions. Thus, results demonstrated that strategic injection of ammonia in these systems has the potential of reducing unwanted emissions whilst achieving high combustion efficiency.

Further tests using various nozzle tips were conducted to see the effect of the injection strategy on the production of emissions and unburned ammonia. Tamura et al. [105] from IHI Corporation numerically and experimentally analysed the coal-ammonia burner, Fig. 10, using different injection strategies (coal and ammonia mixed, injected separately with diffusive ammonia injection, or injected horizontally) with different nozzles, Fig. 14, at various ammonia co-firing ratios at 1.2 MW_{th} power. Results show that NOx emissions remain stable up to 30% ammonia content when ammonia is premixed with coal, whilst NOx increases from 35 to 47% co-firing. When ammonia is injected diffusively, NOx levels are just slightly higher than under premixed

conditions. This suggests that co-firing ammonia below 30% leads to similar NOx levels than burning pure coal. As for the use of different nozzle tips, numerical results were run at 35% ammonia content. It was evident that the geometry of the nozzle had a critical effect on both NOx and unburned carbon content, Fig. 14. The differences were mainly caused by the injection of ammonia into the recirculation central zone (tip B) compared to the injection into the coal stream (tips A and C). Further, the ammonia content in the recirculation zone increases the size of the coherent structure, pushing the coal particles out into the combustion air flow, and reducing unburned coal. Additional tests were conducted for emissions such as N₂O and unburned ammonia, and radiative heat transfer analyses were characterised using premixed coal-ammonia. Results show a sudden increase in NH₃ emissions further down the flame zone, although these emissions are finally reduced with a slight increase of NO and total annihilation of N₂O. In terms of radiation, the higher ammonia content leads to the transition to a more non-luminous flame. However, since temperatures are similar between the pure coal and ammonia-coal co-firing cases, and the field has enough carbon particles, it was believed that there was no acute change in radiative heat transfer [105].

Studies conducted by Xia et al. [106] report the flame propagation mechanism for pulverized coal co-fired with ammonia. The research team observed that ammonia/coal co-firing produced higher flame propagation velocities than pure coal, whilst the use of pure ammonia would be dependent on the equivalence ratio employed. The study expanded on the explanation of the losses/gains during the combustion process of these blends through three zones (coal combustion zone, preheat zone, unburned mixture), Fig. 15. During lean combustion, most of the ammonia reacts within the reaction zone between the coal combustion zone and the preheat zone. However, rich conditions change these dynamics, as most oxygen is consumed by the reaction with ammonia and volatile matter in the reaction front. Coal particle devolatilization are within the reactions taking place in the process, whilst the formation of soot is also enhanced at the reaction front. The coal particle follows a sequence of heating up (by the reaction zone and radiation), the release of volatile matter and its combustion, and char combustion, all occurring simultaneously. Soot particles form as part of a secondary pyrolysis process that comprises the consumption of volatile matter. It was observed that using ammonia under lean conditions leads to some positive effects (ie. radiation and volatile matter production) that are greater than the heat absorption of the coal particles. However, the increase of volatile matter, which increases the local equivalence ratio, is detrimental under rich conditions. This results in lower flame propagation velocities compared to pure ammonia. Stoichiometric conditions show a balanced performance between these phenomena, making pure ammonia and coal/ammonia flames similar in terms of their propagation velocity.

Zhang et al. [107] numerically approached the influence of ammonia (0–80% vol) in such a burner at 8.5 MW_{th} conditions using a refined mechanism, Fig. 16. Excess air ratio and staging air ratio were kept constant at 1.18 and 30%, respectively, over 7 different cases. Results showed that the increase on ammonia content drastically shifts the flame shape. When ammonia content exceeds 40%, the central recirculation zone is completely penetrated by the ammonia jet, hence forming a long, thin flame. This affects the swirl number (S), bringing it down to values between 0.2 and 0.3 S. Further, heat flux distribution on the walls also changes passed 20% (vol) ammonia addition, whilst unburned ammonia content increases considerably from this point. While the proportion of radiative heat decreases with ammonia, the proportion of convective heat increases due to the amount and velocity of the gas. Conclusions are drawn on the high potential of ammonia-coal co-firing when ammonia content is below 40%.

Therefore, Stocks et al. suggests that displacing 20% of Japan's projected coal by 2030 would require around 22.7 Mtons of ammonia annually. The avoided coal combustion would result in 40 Mtons of avoided emissions per annum. Assuming that the ammonia comes from

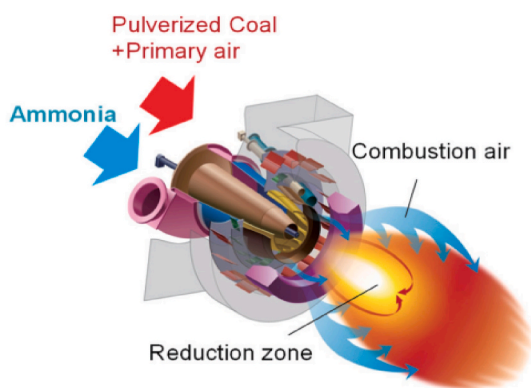

Fig. 10. IHI Burner [100]. (Reprint with permission).

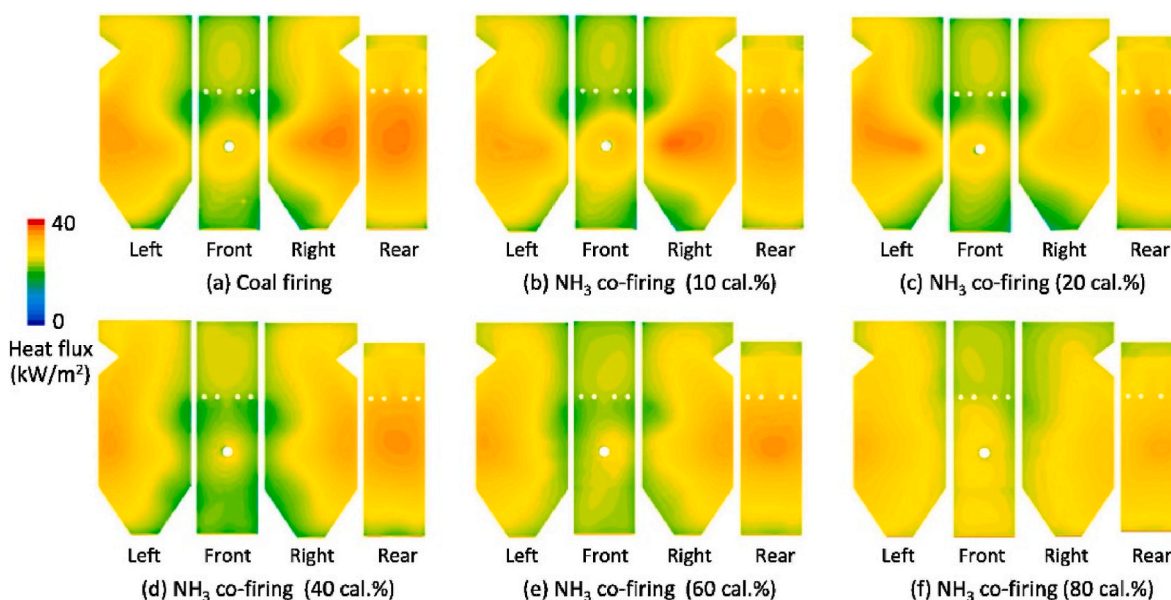

Fig. 11. Heat flux on the wall of a boiler with different NH₃ co-firing ratios [101]. (Reprint with permission).

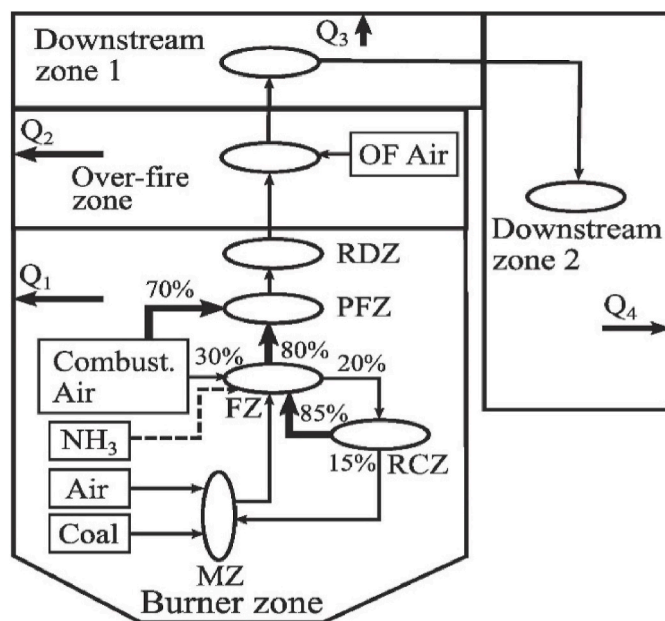

Fig. 12. Reactor network representing a pulverized coal-fired boiler with NH₃ co-firing. MZ: mixing zone, FZ: flame zone, RCZ: recirculation zone, PFZ: post-flame zone, RDZ: reduction zone, OF Air: over-fire air. Q₁–Q₄: Local heat absorption in each zone [100]. (Reprint with permission).

Australia, this would also lead to the reduction of fugitive emissions, considerably supporting the zero carbon Japanese agenda [108].

As previously mentioned, China has also started an ambitious campaign to work with ammonia as a substitute of fossil fuels. In January of 2022, ammonia-coal co-firing of 35% ammonia was for the first time successfully achieved in a 40 MW coal-boiler at the China Energy Group Yantai coal power plant. Shandong province and further work is underway to increase the ammonia content [35]. The test rig is shown in Fig. 17. The work has demonstrated that stable ignition and combustion of coal can be achieved with the addition of up to 35% ammonia, with the co-firing combustion efficiency even higher than that of pure coal combustion. Emission-wise, the use of staged combustion technology with an over-fire-air ratio of up to 20% has shown the

potential to reduce NO_x emissions to a level lower than that of pure coal combustion. Further increase in the over-fire-air ratio did not significantly reduce NO_x emissions, but did result in a decrease in CO and carbon-in-ash, potentially improving thermal efficiency. More recently, a 300 MW coal power plant in Anhui Province was co-fired with up to 35% ammonia at the Tongling Power Plant, Fig. 18 [109]. The project was a collaboration between the Institute of Energy, the Hefei Comprehensive National Science Center and the An Hui Wenergy Company Ltd. An 8.3 MW pure ammonia burner was developed and tested in the coal boilers. The power plant operated at a thermal load of 100–300 MW with 10–35% ammonia additions, resulting in a maximum ammonia consumption rate of 21 tons per hour. The main conclusions were that ammonia burn-off efficiency was greater than 99.99% (with unburnt ammonia less than 2 ppm), NO_x emissions were reduced to lower than that of pure coal combustion, and thermal efficiency was equivalent to that of burning coal. Moreover, the electricity generated by the ammonia-coal co-firing was directly connected to the local electricity grid for residential and industrial consumption, with a stable electricity supply of 100–300 MW and an ammonia fraction of 35% during the 2-h test period.

In support of these works, a vast number of research groups working on ammonia combustion have joined the efforts to combust the fuel whilst increasing efficiencies and reducing emissions. Xu et al. [110] conducted simulations of a 600 Mwe coal power plant whilst replacing coal at ratios from 5 to 20% in increments of 5%. Using two different scenarios that accounted for either identical Adiabatic Flame Temperatures or identical Excess Air Coefficients, their analysis evaluated the impact of coal content in carbon dioxide reduction and ammonia impact on the system's exergy. The analysis depicted the reduction in unwanted emissions (CO₂ and SO₂) with a considerable increase in water content. Around 96 ton/hr of carbon dioxide were mitigated when a 20% ammonia content (in heating value basis) was added to the blend. However, the process also increased exergy losses product to irreversibilities during the combustion of ammonia. Exergy losses of heat exchangers and fans were lower with ammonia due to a decrease in heat transfer temperature difference and reduced airflow into the furnace, respectively. It was also observed that the identical Adiabatic Flame Temperature scenario delivered lower exergy efficiencies, whilst the increase of water also can improve the acid dew point of the flue gas, an issue with corrosive implications that need further evaluation [110].

Studies conducted by Chen et al. [111] investigated the reduction of

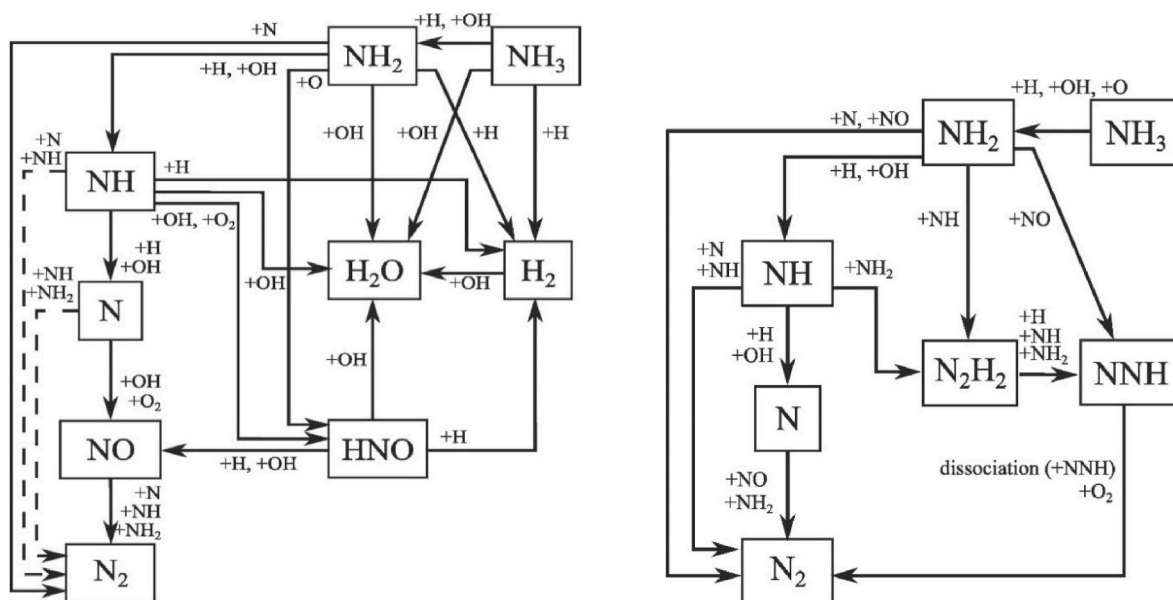

Fig. 13. Comparison between ammonia-coal reactions at (left) 20% and 80% (dashed line), and (right) 40% and 60% ammonia content [100]. (Reprint with permission).

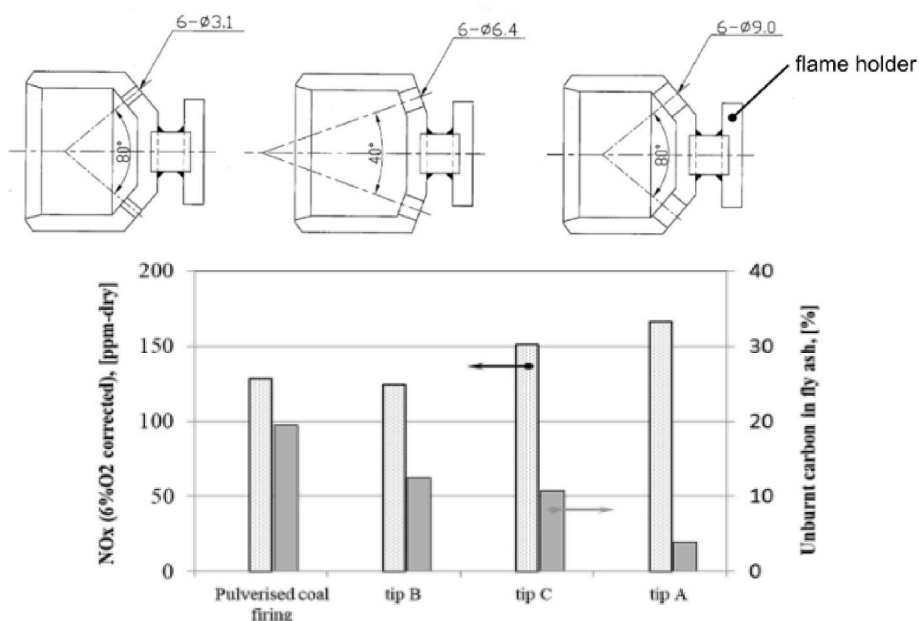

Fig. 14. Various ammonia tips (A, B, C from left to right) and emission results at 35% ammonia co-firing content (vol) [105].

NO by char/ammonia when using ammonia-coal co-firing. Initial quantum chemistry studies evaluated the oxidation paths of various species, showing that processes take place under homogeneous and heterogeneous conditions. These calculations revealed the importance of HNO and the formation path of N_2O . Further, results also improved the development of migration and transformation mechanisms of N during the NH_3 -pulverized coal co-combustion. Additional analyses depicted that rate-determining constants in NH - NO reactions are greater than those in NH_3 - NO and NH_2 - NO heterogeneous reactions. These findings strengthen the leading role of imidogen in ammonia denitrification processes, but also provide clarity in the role that char plays when supporting NO reduction by NH [112]. Further, it is observed that OH located on the char surface is a key component in NO decrease by NH at high temperatures. Other compounds such as Fe and CO were also

examined [113]. As previously mentioned, char seems to be a reduction agent for NO emissions. Using a high temperature tube-furnace and quantum chemistry, the group found that iron-impregnated char possesses less reduction efficiency than demineralized char/ammonia as a consequence of the not conducive adsorption of NH and NO of Fe. Similarly, theoretical results exhibit CO as a promoter of a synergistic effect with amino agents contributing to NO reduction. When char, NH , CO and NO are combined, hydrogen atoms weaken the N-C bond, thus promoting NO heterogeneous reductions. Carbon monoxide fills active sites on the char surface, hence inhibiting NO reduction. Experiments indicate that CO improves NO reduction in ammonia, char and NO fields. Simultaneously, CO plays various roles in the reduction of NO by NH (as previously mentioned), results that depict a greater contribution to emissions reduction compared to NO reduction rates caused by

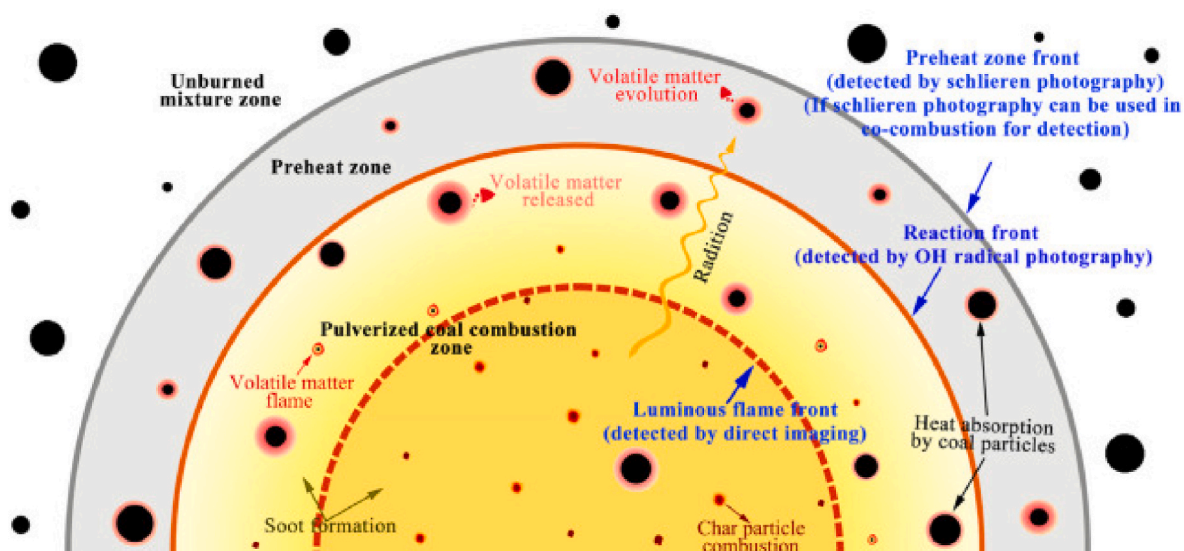

Fig. 15. One dimensional assumption of co-combustion flame structures [106].

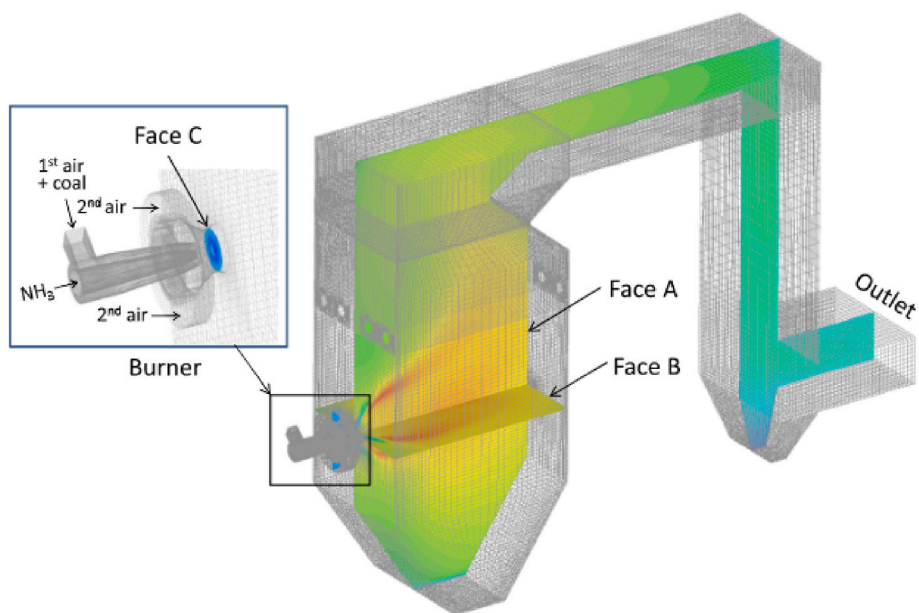

Fig. 16. Numerical mesh used for various ammonia-coal co-firing conditions in an industrial boiler [107].

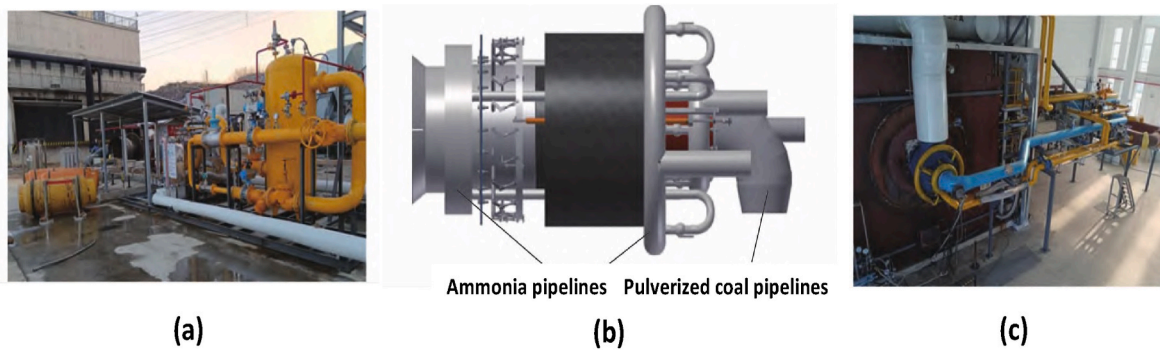

Fig. 17. Ammonia-coal co-firing test rig: (a) ammonia supply system; (b) ammonia-coal co-firing burner; (c) combustion system (Courtesy of China Energy Group [35]).



Fig. 18. Tongling power plant, anhui province, China [109].

CO-coordinated char [114].

An important parameter in the use of coal is the production of volatile and particle matter, as previously depicted. Zhu et al. [115] employed coal pellets to evaluate the impact of having ammonia in the reaction stream. They observed that using ammonia improved the devolatilization of coal and the release of volatile matter, which led to earlier ignition. The study, that evaluated the time-resolved evolution of volatile matter and soot formation at various positions through the flame, denotes a change in temperature profiles (ie. higher with ammonia content) whilst emphasizing the reduced concentration of soot when NH_3 was injected in the reacting flow. This comes as a result of the consumption of soot-forming species such as C_2H_2 and C_4H_5 , inhibiting the formation and growth of soot by competing carbon, an effect that was more pronounced under lean conditions due to the excess of oxygen.

3.2. Small to medium scale furnaces

Further works are being led by Portugal in this front. The work of [116] has looked at the use of ammonia-coal co-firing in fluidized bed reactors both numerically and experimentally. With the potential of using ammonia-coal co-firing to reduce up to 74% of CO_2 emissions, different ammonia-coal ratios were investigated (from 0 to 80% in mass) to determine the impacts on heat release, carbon species, NO and unburned ammonia emissions. Air staging was also addressed in the study. As expected, ammonia addition reduces CO_2 emissions compared to pure coal firing, whilst 10% ammonia substitution delivered similar NO emissions to those of pure coal. Higher ammonia content increases NO emissions, although air staging (at 20% flow rate) brought down the pollutant by up to 50%. CO emissions are also considerably lower, probably as a consequence of the enhancement of reaction (R2) above. Conclusions showed that a 20% ammonia injection is attainable with minor detrimental to heat flux and temperature, whilst NO abatement can be achieved by the proper location of the ammonia injection systems. The research is complemented by further tests [117] using coal, biomass and ammonia, attaining to eliminate coal (bituminous) from the blend. It was found that CO and CO_2 decrease with the use of biomass, whilst NO emissions were also decreased since biomass contains less nitrogen than coal and high volatile content can also reduce the pollutant. Thus, the potential of this technology in low-emissions industrial systems is vast.

Slefarski et al. [118] detailed experimental trials where ammonia was used for the replacement of methane. Ammonia was replaced in up to 10% concentration with N_2 and CO_2 as diluents, respectively, whilst NOx and CO emissions and temperature profiles were obtained. As expected, high levels of emissions were observed particularly under stoichiometric conditions. However, the use of either nitrogen or carbon dioxide threw some interesting findings as the latter produced more

NOx. Surprisingly, the opposite was initially thought from the use of nitrogen, which under thermal reaction was initially seen as another source of nitrogen oxides. It was conceived that the phenomenon was based on the recombination of NOx emissions and amino radicals such as NH_2 in combination with greater heat removal for carbon dioxide (ie. 1.3 vs 1.2), hence affecting dissociation mechanisms in a different percentage. The group continued works aiming at the use of 50% replacement in such a unit [118]. Further analyses conducted by Jójka and Slefarski [119] were performed under lean methane conditions (ie. equivalence ratio 0.71) to observe the impact of ammonia doping (up to 5% vol) and preheated conditions (473K). The group also used different swirl values by changing blade angles to observe the effect of this parameter on CO and NO emissions. It was found that the change in blade angle, thus Swirl number, had a considerable impact on NO emissions, changing from 1950 to 1585 ppm (vol) at the highest ammonia concentrations. Doubling power from 15 to 30 kW did not seem to have a major change in these high levels of emissions. It was concluded that the shorter residence time and high local temperatures near the wall tend to increase NO formation.

Hewlett et al. [121] demonstrates that the use of ammonia from the product of coke production (which account for quantities as high as 32% in the waste streams) in combination with the coke oven gas obtained from the process (which is rich in hydrogen and carbon monoxide) at concentrations between 10 and 20% (vol) can be a viable solution for the production of power. Results show that at high equivalence ratios ~ 1.2 the emissions obtained from the combustion process tend to be lower than those established as a threshold in current legislation, with values below 96 ppm, Fig. 19. The products of combustion could be employed to power a gas turbine, which in combination with a bottoming Rankine cycle can generate >4 MW at efficiencies close to 48%. Further studies conducted by Hewlett et al. [120] also depict the potential of using humidified ammonia in these processes. Experimental results, Fig. 19, show the shift of reactions by the addition of water in blends that use COG (15% vol) and anhydrous ammonia or humidified (60% water) ammonia blends. Although NO emissions follow the same trend, NH_3 measurements at the exhaust have a higher slope when largely humidified ammonia blends are employed. This is believed to be a consequence of the lower rate of reaction caused by the inhibiting presence of water in the fuel. Thus, it is evident, that water content in the combustion of ammonia can shift the reaction to lower equivalence ratios, likely a consequence of greater H/OH/O pools that are highly reactive with ammonia, whilst higher concentrations can be detrimental to the final operation of the system.

Recent work performed at Foshan Xianhu Laboratory in Guangdong province of China has shown that ammonia is a promising substitute for natural gas in the industrial production of ceramic tiles [36]. In order to achieve stable ignition and combustion, low NOx emissions, and high combustion efficiency, a swirl burner was developed and tested for ammonia combustion in the laboratory, Fig. 20. Stable combustion of pure ammonia was achieved over a wide range of operating conditions, as demonstrated in Fig. 20(a), by optimizing the swirlers and other major burner components. Based on the promising laboratory results, 15 different industrial burners with a power output of approximately 45 kW were designed and further tested in an experimental tile kiln. An optimized burner, as shown in Fig. 20(b), enables easy ignition of pure ammonia, and stable combustion with adjustable heat power output in a wide range of 3–45 kW. To address NOx emissions, which is a key concern in ammonia combustion, a staged combustion technology was implemented by injecting a secondary air flow into the combustor nozzle downstream of the primary flame. This technique effectively reduced NOx emissions to below 100 ppm (normalized to 18% O_2 as specified by the regulatory standards of the Chinese ceramic industry), as compared to the single-stage combustion, which can result in NOx emissions of 300–500 ppm (18% O_2).

Throughout 2022, a consortium comprised of the Foshan Xianhu Laboratory and two local industrial companies, DLT Technology Co. Ltd

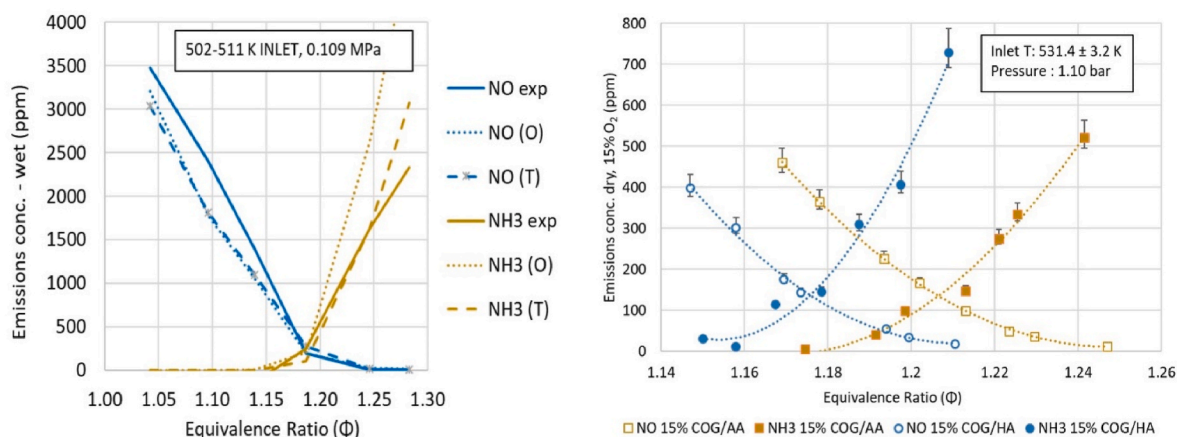

Fig. 19. Emissions concentrations using (left) COG (20% vol) and ammonia, and (right) COG (15%), anhydrous ammonia (AA) or humidified ammonia (HA) [120]. (Reprint with permission).

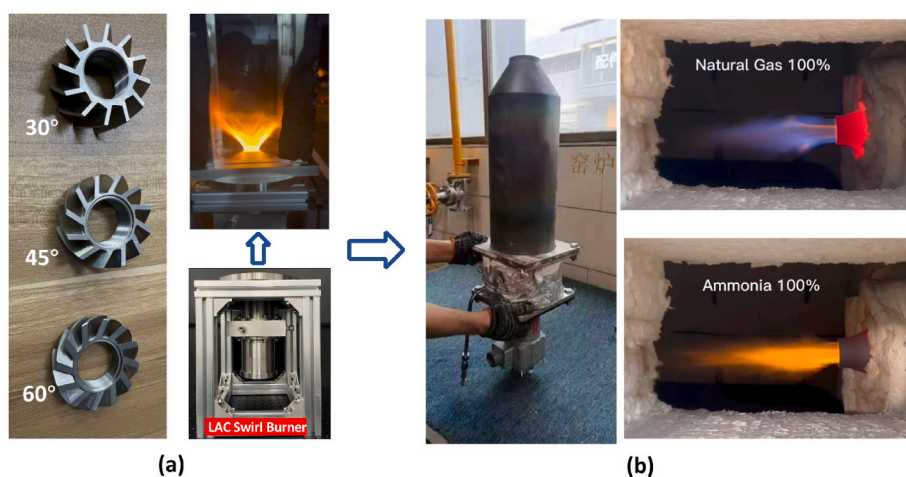

Fig. 20. Laboratory scale burner (~5 kW) (a) and tile kiln swirl burner (~40 kW) (b) developed by Cheng's group at the Foshan Xianhu Laboratory for ammonia combustion.

(a tile kiln manufacturer) and Foshan Oceano Tile Co. Ltd (a ceramic tile manufacturer) worked collaboratively to modify a pilot tile production kiln. As seen in Fig. 21(a), the 30-m-long kiln was originally designed for natural gas combustion. The original 36 natural gas burners in the kiln were replaced with the newly designed ammonia burners. An ammonia supply system, including a liquid ammonia supply station, an ammonia evaporator, pipelines, pressure regulators, flow meters and ammonia sensors, were constructed to provide sufficient ammonia fuel safely. An in-situ flue gas measurement system based on the laser absorption technique was developed and installed to monitor the emissions (unburnt ammonia and NO_x) in real time. To make sure the NO_x and unburnt ammonia emission levels met the regulations, a SCR system was built in to perform the final NO_x reduction in the flue gases. On December 18, 2022, the world's first ceramic tiles fired by 100% carbon-free ammonia fuel were produced, Fig. 21(b). Results confirmed stable ignition and combustion for pure ammonia throughout the two-day operation, and achieved excellent properties for the floor tiles of 750 × 750mm in size. The successful application of ammonia energy in producing "green tiles" has drawn wide attention from the Chinese industry.

For the ammonia-fired ceramic production, the greatest challenge was to control the fuel NO_x emission to meet the regulations. Fig. 22 shows the strategies taken by the team to achieve a very low NO_x emission. Firstly, the air-staging combustion burners could reduce

40–70% of NO_x generated in the combustion. Along the kiln, there exists a region around 800–1150 °C, where gaseous ammonia was injected to perform Selective Non-Catalytic Reduction (SNCR) of NO_x emission. By the SNCR, around 20% of the NO_x emission from the staged combustion burners could be further mitigated. Finally, at the exhaust outlet of the kiln, a Selective Catalytic Reduction (SCR) system is applied to bring the amount of NO_x emission well below the regulation level. Experimental results show that the NO_x emission is lower than 15 ppm (18% O₂) in all of the cases; at the same time, the NH₃ emission was controlled below 5 ppm. This work has demonstrated that the so-called multi-level De-NO_x strategy works very well in the ceramic tile kiln as it has sufficient space to apply the different De-NO_x techniques.

In parallel, the combustion research team at Korea Institute of Industrial Technology (KITECH) performed an experiment on ammonia co-firing using a pulverized coal combustion system in their 80 kW scale furnace. Fig. 23 shows pictures of the combustion test rig and ammonia co-fired burner installed into the furnace. The system used a swirl-type burner, and the team tested several ammonia injection nozzles through the burner, obtaining NO_x concentrations between 150 and 1000 ppm (at 6% O₂) without ammonia slip. Side wall injection for various axial locations was conducted for 20% ammonia co-firing and ammonia slips between 0 and 5 ppm were observed in the combustion gas. Overall, the team showed that up to 20% ammonia co-firing can be achieved through minimum burner modification for ammonia injection.

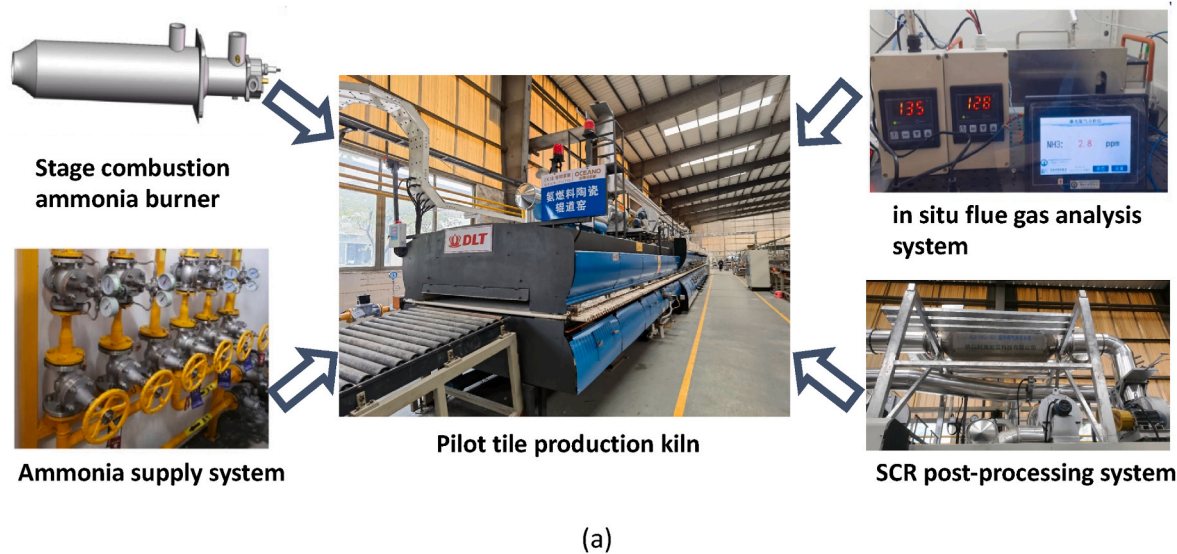

Fig. 21. Manufacturing ceramic tile with pure ammonia fuel: (a) modifications of a pilot tile production kiln for pure ammonia combustion. (b) the world's first "zero-carbon ammonia fuel made tile" rolling out of the kiln.

Currently, the research group is testing ammonia co-combustion into another industrial burner where pulverized coal and coke oven gas are simultaneously combusted. KEPRI is performing a similar experiment in their 700 kW-scale down-fired furnace. They have obtained similar results up to 30% co-firing and combustion optimization of the burner is ongoing. Through experiments in bench-scale facilities, up to 20–30% co-firing of ammonia was revealed to have a minor effect on combustion efficiency and NO_x emission, using minor modification and optimization of existing burners.

Regarding bench-scale developments in Circulating Fluidized Bed (CFB) combustion facilities, KIER (Korea Institute of Energy Research) has performed an ammonia co-firing test in their 100 kW circulating fluidized bed (CFB) combustion facility using up to 20% ammonia rates. They obtained similar or lower NO_x concentrations in the flue gas when they introduced ammonia by mixing the chemical with primary air (fluidizing air). KEPRI is currently performing a similar experiment in their 100 kW (CFB) combustion facility by testing various methods of ammonia co-firing. They will develop a new combustion guideline for plant operators, and have a plan to extend the ammonia co-firing to industrial CFB boilers. They are also considering using start-up burners for ammonia co-firing as a supporting extra method, whilst bench-scale experiments are under plan, expecting the success of a 100% ammonia-firing burner. For a commercial-scale application using coal

boilers, Doosan Enerbility has been developing a 3 MW scale ammonia co-combusted burner. They plan to start testing by 2023 to prepare commercial-scale demonstration systems scheduled by 2026–2027. BHI, a Korean boilermaker which owns the boiler business of Foster Wheeler, is also developing an ammonia co-fired burner, with plans to apply their burner technology at a utility scale. Currently, KEPRI is leading the commercial-scale demonstration of CFB burners, whilst Hyundai power system (HPS) is also participating in the program in collaboration with Doosan Enerbility and BHI. Fig. 24 shows pictures of the Shin Boryeong power plant and the Samcheok power plant, respectively, which are considered as candidates for the demonstration site.

Technologies such as those based on Moderate or Intense Low-oxygen Dilution (MILD) have been also recently employed to evaluate the use of ammonia for fuelling applications in furnaces. MILD combustion uses elevated temperature reactants and low temperature increase during the combustion process, thus ensuring that emissions such as thermal NO_x are minimised [122]. In terms of ammonia, it is known that lower reaction temperatures promote the path $\text{NH}_3 \rightarrow \text{NH}_2 \rightarrow \text{NH} \rightarrow \text{N}_2$, thus minimizing emissions. However, to fully assess this parameter and the impact of the technology whilst using ammonia, several experimental and numerical campaigns have been dedicated to the study of ammonia blends. Recent analyses [123] evaluated the use of gases at moderate temperature close to 1450 K and

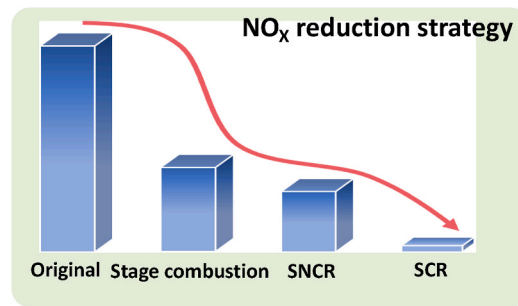

(a)

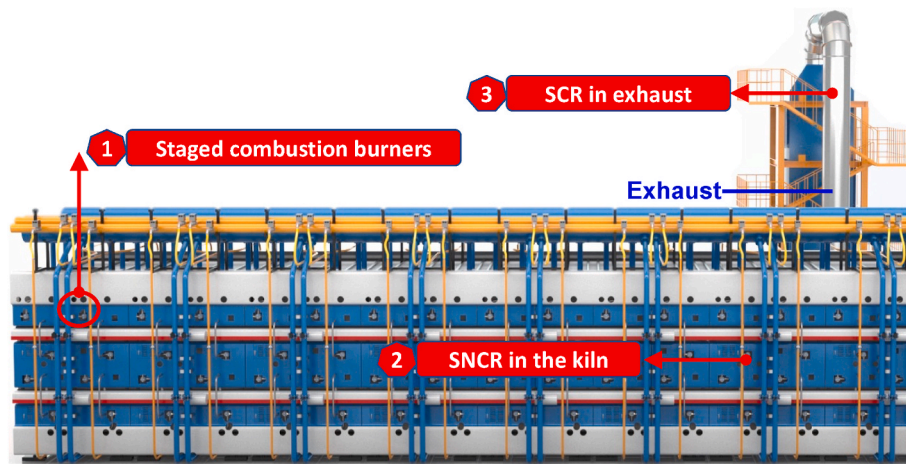

(b)

Fig. 22. Illustrations of (a) the multi-level De-NO_x strategy; (b) application of multi-level De-NO_x approaches in the tile kiln.



Fig. 23. Test facilities and ammonia co-firing burner in KITECH.

short residence times ($<0.5s$), confirming that at equivalence ratios between 1.1 and 1.7 the final NO_x emissions were below 10 ppm. Findings also revealed that low inlet temperatures $<900K$ produced higher NO_x profiles. The phenomenon can be linked to the DeNO_x effect of hot unburned ammonia, which reached high concentration values > 100 ppm for these conditions [124].

Concurrently, it is known that hydrogen and other doping agents promote the reaction of ammonia at high temperatures. However, the role of these doping agents on the oxidation process of ammonia for low-intermediate temperature regimes ($900 K < T < 1350 K$) required

further investigation for their implementation in MILD combustion processes. Manna et al. [125] investigated numerically and experimentally a Jet Stirred Flow Reactor (JSFR) in the range of $1200 K < T_{in} < 1350 K$ at 0.14 MPa in a wide equivalence ratio ranging from 0.2 to 1.2. High dilution (up to 90%) was achieved with up to 15% (vol) H₂ content in the fuel. Results show how hydrogen moderately enhances the reactivity of the system under these conditions, whilst lean, stoichiometric and rich cases behave similarly within the low-intermediate temperature regime. Notably, NO emissions under lean conditions and low H₂ content increase at lean conditions, whilst under rich cases NO

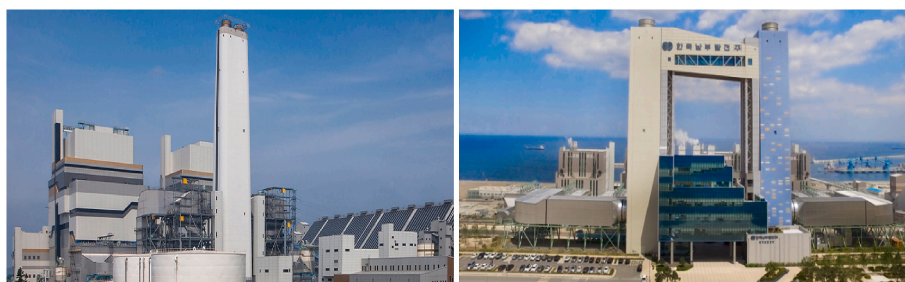

Fig. 24. Left) Shin Bo-ryeong power plant (1000 MWe X 2); Right) Samcheok power plant (550 MWe X 4).

remains similar between different hydrogen contents. Thermo-kinetic instabilities were also assessed. It was observed that as H_2 is added to the mixture, the damped oscillations window becomes narrower and it is shifted towards lower inlet temperatures, Fig. 25. It is notorious that under fuel-rich conditions >1.0 there are no instabilities. Simultaneously, various mechanisms were used to reproduce the observed conditions. From those used, Zhang mechanism [126] was shown to be the one closest for validation. Modelling denoted the high reactivity between ammonia and OH, thus partially inhibiting the direct oxidation of hydrogen, which also reacts with NH_2 to revert back to NH_3 . However, it was evident that models were not able to properly reproduce the NO trends under these conditions, probably due to the uncertainties involved in the NO production route through NH_2 (ie. $NH_2 \rightarrow H_2NO \rightarrow HNO \rightarrow NO$) and the concurrent NH_2 pathway to N_2H_x species, a point that requires further consideration by reaction kinetic developers. Finally, it was concluded that the mutual inhibiting interaction between ammonia and hydrogen vanishes at high temperatures where NH_2 gets involved in faster reactions, decoupling the oxidation chemistry between the former species [125].

Further studies [127] using ammonia-methane showed stability and operability limits under MILD combustion conditions, denoting the impact of methane on the operability of the system. Similarly, NOx emissions were observed at various conditions, with peaks located in the intermediate regions of 25%–50% ammonia content. Finally, chemical kinetics showed that methane boosts the production of OH radicals, thus sustaining the ammonia conversion rate. It was also observed that OH

consumes NH_2 along the methane conversion path, thus limiting the DeNOxing effect of NH_2 via $NH_2+NO \rightarrow H_2O + N_2$, increasing NO emissions.

Other findings that are of practical interest have also been obtained using various types of confinement materials whilst burning ammonia. Manna et al. [128] demonstrated through various experimental campaigns that the use of various materials can have a variety of responses to the production of emissions when ammonia is used. The work was based on the use of quartz and metals to confine the combustion rig. The results showed that there is a difference in the kinetics of various species as they react through different heterogeneous surface reactions. This is a critical parameter that needs to be addressed and that not only will impact combustion features but also material wearing, as previous described in the previous sections.

4. Future trends

Based on common practices for ammonia production and decarbonisation agendas, it is predicted that green ammonia production will surpass other methods of ammonia production (ie. blue, brown, etc.) in the near future. Due to its special properties, using ammonia in sectors such as processing industries, transportation, power generation and heating will extend quickly, hence supporting the development and optimization of systems for implementing ammonia-based fuels. As part of this vision, a great variety of concepts and ideas have been conceived for their utilization in furnaces, as presented in the previous sections.

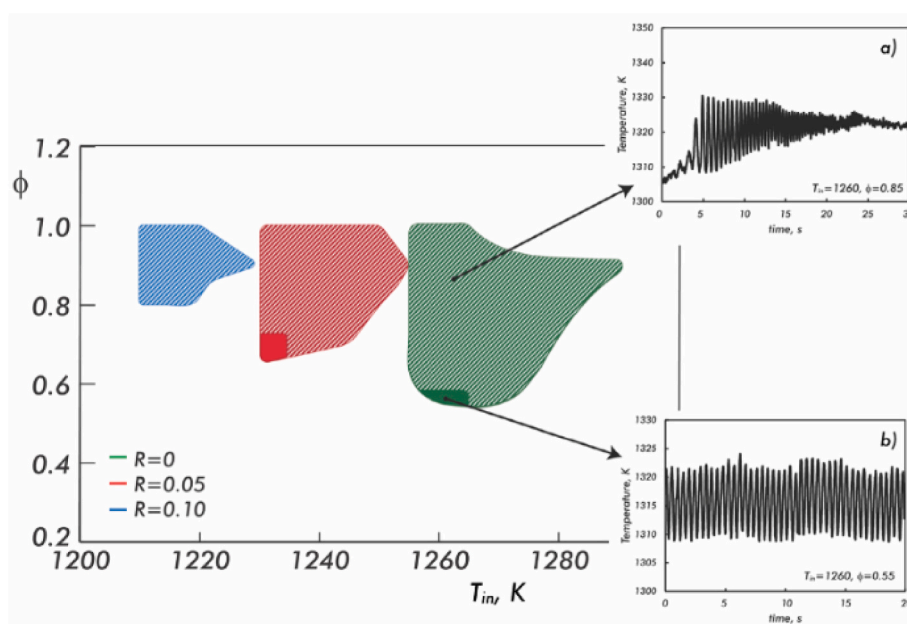

Fig. 25. Experimental maps of behaviour for various ammonia/hydrogen blends with 86% nitrogen dilution (colour areas show periodic oscillations, whilst dashed regions denote damped oscillations) [125].

Each of them has important paths towards further development and progression. Some of these paths are briefly addressed in this section to provide a vision of the topics and areas that will require further research, development and investment.

Much contemporary research has focussed on the development of detailed chemical reaction mechanisms to simulate the behaviour of fuel blends. A range of fuels can be mixed with NH_3 to enhance reactivity, and from a design perspective, it is important that chemistry can be accurately represented in numerical simulations, particularly with regard to the formation of NO_x . More research will be published to validate the co-combustion of NH_3 with other fuels, and autoignition delay time measurements are an essential component of these studies. There may be scope to evaluate the potential impact of NO_x reduction concepts, such as reactant humidification, on reactivity and any changes in autoignition delay time. This has significance for the practical application of NH_3 mixtures, and there will also be increased work at specific system-relevant conditions. There will also be enhanced work in the field of improving NH_3 flame stability, and there is scope to increase the fraction of NH_3 that can be achieved in both small- and large-scale systems. This may require enhancements in both reactant and combustor ambient temperatures, and under such conditions, NO_x formation presents a significant barrier to the wider implementation of pure NH_3 as a future zero-carbon fuel. It is a crucial challenge for researchers to develop and employ advanced combustor concepts with NH_3 , whilst reducing NO_x emissions. Several concepts previously addressed can bring down NO_x and unburned ammonia, including but not limited to a) humidification that can shift the reactions whilst bringing down temperatures that can enhance DeNOxing regimes; b) stratified fuel injection and control to ensure the production of radicals that can interact between themselves to reduce fugitive ammonia whilst consuming early produced NO_x ; c) multi-stage combustion for the staged consumption of species; d) use of SNCR with reduced utilization of SCR to cap emissions whilst ensuring lower running costs; e) flow control and increase recirculation via buffers or swirling flows; f) amongst many others.

Similarly, novel studies on the impact of ammonia combustion in various materials are required. Currently, the use of steels appears to be settling some of these inconveniences, whilst nickel-based compounds might also be resistant to the aggressive atmospheres produced when combusting ammonia. However, longer running times and a diversity of demonstrators are still needed to elucidate more insights into the phenomena occurring at a molecular level between ammonia, emissions, radicals, hydrogen radicals and material structure.

The current trend shows an increasing interest in retrofitting coal furnaces for their use with co-firing ammonia. Although methane and propane are also on track to be displaced by ammonia for decarbonisation purposes in medium size furnaces, ammonia injected in large coal power systems is directly proportional to the reduction of carbon dioxide emitted to the atmosphere, hence making very attractive the use of this fuel to keep running coal-based large thermal cycles. However, the increase in ammonia content can also trigger the production of larger CO emissions combined with greater NO_x formation, reducing the benefits of using a zero-carbon fuel. Therefore, future trends will see the onset of novel, improved technologies similar to those developed recently as part of a trend of incipient methods to efficiently burn ammonia. A better understanding of the combustion process of multi-phase reactions using coal and ammonia will expand with further studies in the field. Similarly, the use of other ammonia combinations (ie. butane, heavier hydrocarbons, etc.) will start appearing in the literature as a method of transitioning towards clean electrofuels' combustion. Processes such as cement production, glass and steel making, raw materials cleaning, etc. will be all within the technologies that will likely evaluate ammonia as a fuel for combustion. Finally, the use of the chemical in such applications will depend on the performance of the combustion units, their environmental features (ie. pollution formation), and the impact on components and materials that hot

ammonia can produce. These points, combined with the right economics and ammonia production methods (ie. since the production of ammonia would need to ramp up several times from current rates), will make ammonia as one of the preferred molecules to decarbonise furnaces in the near future.

5. Conclusions

A comprehensive review of recent trends in ammonia combustion for furnaces was represented in this article. Experimental techniques and tools in the field of ammonia-based fuels combustion were investigated and several recent reports were presented. Emissions such as NO , NO_2 and N_2O are also brought up to depict the challenges of burning ammonia with its nitrogen-bonding nature. Other emissions were also mentioned, whilst material impact demonstrates that there is a lack of critical research still needed for the use of ammonia in fuelling systems. A large compilation of data around the use of NH_3 in state-of-the-art systems seeking for novel injection solutions, operating regimes and innovative designs capable of using ammonia furnaces was presented. Furnaces using ammonia and fuel co-firing were explored as a solution to minimise the consumption of fossil fuels whilst delivering high heating rates needed for several industrial processes. Although CO and unburned ammonia are still generated with high NO_x levels, these emissions appear to be below national standards, hence generating positive perspectives for the development of these technologies. It must be emphasized that these national/local thresholds will be lowered as time passes by, hence requiring further research to unravel the phenomena behind ammonia combustion and emissions traces coming from these systems. It was found that several sectors and the large energy requirements across Asian countries are driving the industrial use of ammonia, whilst combustion fundamentals using coal and other solid particles are still needed to avoid the production of unwanted emissions. Large-size furnaces are already demonstrating the potential for the utilization of ammonia under efficient combustion conditions, although higher ammonia contents are still in need of further demonstration. As for the medium to small-size units, novel designs employ concepts that range from swirl stabilization, to gasification and humidified conditions, all combined with either SCR or SNCR methods to decrease NO_x production, hence making the use of ammonia feasible for these applications. Finally, the future challenges in the field of ammonia-based fuels within combustion systems needed to reach both optimum and improved systems were discussed, addressing the need for these systems and the high potential of seeing large furnace facilities running on NH_3 in the near future.

Declaration of competing interest

The authors declare that they have no known competing financial interests or personal relationships that could have appeared to influence the work reported in this paper.

Acknowledgements

Cardiff University authors gratefully acknowledge the support from the EPSRC through the program SAFE AGT (EP/T009314/1), OceanREFuel (EP/W005018/1), MariNH3 (EP/W016656/1) and Optimal fuel blends for ammonia fueled thermal propulsion systems (EP/T033800/1). <http://orca.cf.ac.uk/XXXXX>

References

- [1] IPCC Summary for Policymakers [Internet]. Global Warming of 1.5°C. An IPCC Special Report on the impacts of global warming of 1.5°C above pre-industrial levels and related global greenhouse gas emission pathways. The context of strengthening the global response to the threat of climate change; 2018. [cited 2023 Feb 1]; Available from: <https://www.ipcc.ch/sr15/chapter/summary-for-policy-makers/>.

- [2] Tol R.S.J. The economic impact of climate change. *Perspektiven der Wirtschaftspolitik*; 2010 May;11(Supplement):13-37.
- [3] IEA. Key World Energy Statistics [Internet]. IEA Publications 2020 [cited 2023 Jan 19]; Available from: https://webstore.iea.org/download/direct/4093?fileName=Key_World_Energy_Statistics_2020.pdf.
- [4] IEA. Wind [internet]. Forecast overview. 2021. Available from: <https://www.iea.org/reports/renewables-2020/wind>.
- [5] Yu F, Guo Y, Le-Nguyen K, Barnes SJ, Zhang W. The impact of government subsidies and enterprises' R&D investment: a panel data study from renewable energy in China. *Energy Pol* 2016; 89(C):106-113.
- [6] Yang X, He L, Xia Y, Chen Y. Effect of government subsidies on renewable energy investments: the threshold effect. *Energy Pol* 2019; 132: 156-166.
- [7] Whittlesey R, Letcher TM. Wind energy engineering. Academic Press; 2017. p. 185–202.
- [8] Kabir E, Kumar P, Kumar S, Adelodun AA, Kim KH. Solar energy: potential and future prospects. *Renew Sustain Energy Rev*; 2018; 82(1): 894-900.
- [9] IEA. Solar Energy [Internet]. Renewables 2019 [cited 2023 Feb 1]; Available from: <https://www.iea.org/topics/renewables/solar/>.
- [10] Aswathanarayana U, Harikrishnan T, Kadher-Mohien TS, editors. Solar energy. In: Green energy: technology, economics and policy; 2010.
- [11] IEA. Solar [internet]. Forecast overview 2022 [cited 2023 Feb 2]; Available from: <https://www.iea.org/fuels-and-technologies/solar>.
- [12] World Energy Council. Marine Energy [Internet]. World Energy Resources 2016 [cited 2023 Jun 18]; Available from: <https://www.marineenergywales.co.uk/wp-content/uploads/2016/01/World-Energy-Council-Marine-Energy-Resources-2016.pdf>.
- [13] IEA. Ocean power [internet]. Forecast overview, 2022 [cited 2023 Feb 18]; Available from: <https://www.iea.org/reports/ocean-power>.
- [14] Valera-Medina A, Roldan A. Ammonia from steelworks. *Sustainable Ammonia Production* 2020:69–80.
- [15] Wikipedia. Mond gas [internet]. Wikipedia [cited 2023 Apr 27]; Available from: https://en.wikipedia.org/wiki/Mond_gas.
- [16] Gasworks Claire. Profile D: produced gas plants, 2014 [internet] [cited 2023 Apr 27]. Available from: <https://www.claire.co.uk/component/phocadownload/category/9-other-cl-airedocuments?download=433:gasworks-profile-d-producer-gas-plants>.
- [17] Dierschke A. Development of the Coke Oven Industry, 1955 [Internet] [cited 2023 Apr 27]. Available from: https://www.jstage.jst.go.jp/article/jie1922/35/3/35_3_157/_pdf.
- [18] Gowariker V, Krishnamurthy VN, Gowariker S, Dhanorkar M, Paranjape K. The fertilizer encyclopedia. John Wiley & Sons; 2009.
- [19] Kandemir T, Schuster ME, Senyshyn A, Behrens M, Schlögl R. The Haber-Bosch process revisited: on the real structure and stability of “ammonia iron” under working conditions. *Angewandte Chemie - Int Ed* 2013;52:12723–6.
- [20] Cherkasov N, Ibhaddon AO, Fitzpatrick P. A review of the existing and alternative methods for greener nitrogen fixation. *Chem Eng Process: Process Intensif* 2015; 90:24–33.
- [21] Lan R, Irvine JTS, Tao S. Ammonia and related chemicals as potential indirect hydrogen storage materials. *Int J Hydrogen Energy* 2012;37:1482–94.
- [22] Brown DE, Edmonds T, Joyner RW, McCarroll JJ, Tennison SR. The genesis and development of the commercial BP doubly promoted catalyst for ammonia synthesis. *Catal Lett* 2014;144:545–52.
- [23] NARUC. Coal and carbon management guidebook: coal-to-hydrogen opportunities and challenges, 2021 [internet] [cited 2023 Apr 25] Available from: <https://pubs.naruc.org/pub/63211779-1866-DAAC-99FB-C7D38972AEB8>.
- [24] RWE Press. Import of Green Energy, 2022 [Internet] [cited 2023 Apr 10]; Available from: <https://www.rwe.com/en/press/rwe-ag/2022-03-18-import-of-green-energy-rwe-builds-ammonia-terminal-in-brunsbuettel>.
- [25] Atchison J. ACE Terminal: importing ammonia to Rotterdam from 2026 [Internet]. Ammonia Energy Association, 2022 [cited 2023 Apr 09]; Available from: <https://www.ammoniaenergy.org/articles/ace-terminal-importing-ammonia-to-rotterdam-from-2026/>.
- [26] Atchison J. JERA opens tender for long term ammonia supply contract [Internet]. Ammonia Energy Association, 2022 [cited 2023 Apr 11]; Available from: https://www.ammoniaenergy.org/articles/jera-opens-tender-for-long-term-ammonia-supply-contract/?mc_cid=efb9cfd83f&mc_eid=81cd7b883e.
- [27] Atchison J. JERA Targets 50% ammonia-coal co-firing by 2030 [Internet]. Ammonia Energy Association, 2022 [cited 2023 Apr 11]; Available from: <https://www.ammoniaenergy.org/articles/jera-targets-50-ammonia-coal-co-firing-by-2030/>.
- [28] Mitsubishi Heavy Industries Group. Mitsubishi power commences development of world's first ammonia-fired 40MW class gas turbine system, 2021 [internet] [cited 2023 Feb 15]; Available from: <https://power.mhi.com/news/20210301.html>.
- [29] Atchison J. Trailing Ammonia-coal co-firing in India [Internet]. Ammonia Energy Association, 2022 [cited 2023 Apr 11]; Available from: <https://www.ammoniaenergy.org/articles/trailing-ammonia-coal-co-firing-in-india>.
- [30] Korea Ministry of Trade Industry and Energy. Announcement 2023-036 [Internet]. [cited 2023 May 22]; Available from: https://www.motie.go.kr/motie/ms/nt/announce3/bbs/bbsView.do?bbs_seq_n=68162&bbs_cd_n=6¤tPage=1&search_key_n=&cate_n=&dept_v=&search_val_v=&biz_anc_yn_c=
- [31] Korea Ministry of Trade Industry and Energy. Press release 2021. 11. 8 [Internet]. [cited 2023 May 22]; Available from: http://www.motie.go.kr/motie/ne/press/press2/bbs/bbsView.do?bbs_cd_n=81&cate_n=1&bbs_seq_n=164964.
- [32] Ji J. Status of technology development of power generation using ammonia. *News and Information for Chemical Engineers*; 2022. p. 408–19.
- [33] Grantham Research Institute. 14th Five-Year Plan for New Energy Storage Development Implementation Plan [Internet]. Climate Change Laws of the World, 2022 [cited 2023 Apr 27]; Available from: https://www.climate-laws.org/document/14th-five-year-plan-for-new-energy-storage-development-implementation-plan_3960.
- [34] Liu L, Wang Y, Wang Z, Li S, Li J, He G, et al. Potential contributions of wind and solar power to China's carbon neutrality. *Resour Conserv Recycl* 2022;180: 106155.
- [35] Niu T, Zhang W, Liu X, Hu D, Wang T, Xie Y, et al. Industrial-scale experimental investigation of ammonia-coal cofiring in coal-fired boiler. *Clean Coal Technol* 2022;28:193–200.
- [36] Ecological China Network, The world's first green ceramic tile fired with zero-carbon ammonia fuel was released in Foshan (In Chinese) [Internet]. Ecological China Network, 2022 [cited 2023 Apr 27]; Available from: http://www.eco.gov.cn/news_info/60897.html.
- [37] National Bureau of Statistics of China. China Energy Statistical Yearbook 2020 [Internet]. China Energy Statistical Yearbook, 2020 [cited 2023 Apr 27]; Available from: <https://www.yearbookchina.com/navibooklist-n3020013309-1.html>.
- [38] Pandey JK, Dinesh MH, Kumar GN. A comparative study of NOx mitigating techniques EGR and spark delay on combustion and NOx emission of ammonia/hydrogen fuelled SI engine. *Energy* 2023;276. 127611.
- [39] Dinesh MH, Kumar GN. Experimental investigation of variable compression ratio and ignition timing effects on performance, combustion, and Nox emission of an ammonia/hydrogen-fuelled SI engine. *Int J Hydrogen Energy* 2023;48(9): 35139–52.
- [40] Dinesh MH, Pandey JK, Kumar GN. Study of performance, combustion, and NOx emission behavior of an SI engine fuelled with ammonia/hydrogen blends at various compression ratio. *Int J Hydrogen Energy [Internet]* 2022;47(60): 25391–403.
- [41] Rouwenhorst K. India. a future ammonia energy giant. Ammonia Energy Association, 2023 [Internet] [cited 2023 Mar 23]; Available from: <https://www.ammoniaenergy.org/articles/windia-a-future-ammonia-energy-giant/>.
- [42] Pawar ND, Heinrichs HU, Winkler C, Heuser PM, Ryberg SD, Robinus M, et al. Potential of green ammonia production in India. *Int J Hydrogen Energy* 2021;46: 27247–67.
- [43] Reuters Media. India sets targets for green hydrogen use by some industries [Internet] [cited 2023 Apr 27]; Available from: <https://www.reuters.com/business/energy/india-sets-hydrogen-ammonia-consumption-targets-some-industries-govt-2023-01-13/>.
- [44] Cardiff University Press. Harnessing the oceans for energy, 2021 [internet] [cited 2023 Feb 12]; Cardiff university news. Available from: <https://www.cardiff.ac.uk/news/view/2536400-harnessing-the-oceans-for-energy>.
- [45] Cardiff University Press. University Cardiff Achieving net zero using ammonia, 2023 [Internet] [cited 2023 Jul 23]; Available from: <https://www.cardiff.ac.uk/news/view/2730915-achieving-net-zero-using-ammonia>.
- [46] H2 carrier. The P2X floater, 2022 [internet] [cited 2023 Feb 11]; Available from: <https://www.h2carrier.com/the-p2x-floater>.
- [47] Atchison J. Wartsilä to coordinate EU-funded program for ammonia engine development [internet]. Ammonia Energy Association, 2022 [cited 2023 Jan 13]; Available from: https://www.ammoniaenergy.org/articles/wartsila-to-coordinate-eu-funded-program-for-ammonia-engine-development/?mc_cid=2a42e48cc3&mc_eid=81cd7b883e.
- [48] Atchison J. NOV: subsea storage of fuel ammonia [internet]. Ammonia Energy Association, 2022 [cited 2023 Jan 27]; Available from: <https://www.ammoniaenergy.org/articles/nov-subsea-storage-of-fuel-ammonia/>.
- [49] Brown T. Zero emission aircraft: ammonia for aviation [internet]. Ammonia Energy Association, 2020 [cited 2023 Jul 16]; Available from: <https://www.ammoniaenergy.org/organization/reaction-engines/>.
- [50] University of Central Florida. UCF to lead \$10M NASA project to develop zero carbon jet engines, 2022 [internet] [cited 2023 Mar 23]. Available from: <https://www.ucf.edu/news/ucf-to-lead-10m-nasa-project-to-develop-zero-carbon-jet-engines/>.
- [51] Atchison J. Aviation H2 chooses ammonia to develop carbon-free flight in Australia [Internet]. Ammonia Energy Association, 2022 [cited 2023 Apr 14]; Available from: <https://www.ammoniaenergy.org/articles/aviation-h2-chooses-ammonia-to-develop-carbon-free-flight-in-australia/>.
- [52] Valera-Medina A, Xiao H, Owen-Jones M, David WIF, Bowen PJ. Ammonia for power. *Prog Energy Combust Sci* 2018;69:63–102.
- [53] Kurata O, Iki N, Inoue T, Fujitani T, Fan Y, Matsunuma T, et al. Pure ammonia combustion micro gas turbine system. In: *AiChE annual meeting*; 2019: 10-15.
- [54] Mashruk S, Viguera-Zuniga MO, Tejada-del-Cueto ME, Xiao H, Yu C, Maas Y, et al. Combustion features of CH₄/NH₃/H₂ ternary blends. *Int J Hydrogen Energy* 2022;47(7):30315–27.
- [55] Khateeb AA, Guiberti TF, Zhu X, Younes M, Jamal A, Roberts WL. Stability limits and NO emissions of technically-premixed ammonia-hydrogen-nitrogen-air swirl flames. *Int J Hydrogen Energy* 2020;45:22008–18.
- [56] Alhuyi Nazari M, Fahim Alavi M, Salem M, Assad MEH. Utilization of hydrogen in gas turbines: a comprehensive review. *Int J Low Carbon Technol* 2022;17:513–9.
- [57] Kovaleva M, Dziedzic D, Mashruk S, Evan S, Valera-Medina A, Galindo-Nava E. The evaluation of ammonia/hydrogen combustion on the H permeation and embrittlement of nickel-base superalloys. *Proc ASME Turbo Expo* 2022;2022: GT2022-82239.
- [58] Kovaleva M, Dziedzic D, Mashruk S, Evan S, Valera-Medina A, Galindo-Nava E. The evaluation of ammonia/hydrogen combustion on the H permeation and

- embrittlement of nickel-base superalloys. *Proc ASME Turbo Expo 2022*;2022: GT2022-82239.
- [59] Wang D, Lee M, Suzuki Y. Nitriding effects of ammonia flames on iron-base metal walls. *J Ammonia Energy* 2023;1:1–10.
- [60] Pedferri P, Ormellesse M. *Corrosion science and engineering*. Springer; 2018.
- [61] Lunde L, Nyborg R. Effect of oxygen and water on stress corrosion cracking of mild steel in liquid and vaporous ammonia. *Ammon Plant Saf*; 1987.
- [62] Groysman A. Physicochemical behavior of engineering materials in ammonia and its derivatives. page 15–6. In: *Proceedings of the “new and old in the ammonia world” 2017 conference*; 2017.
- [63] Hamidah I, Solehudin A, Hamdani A, Hasanah L, Khairurrijal K, Kurniawan T, et al. Corrosion of copper alloys in KOH, NaOH, NaCl, and HCl electrolyte solutions and its impact to the mechanical properties. *Alex Eng J* 2021;60: 2235–43.
- [64] Mashruk S, Kovaleva M, Alnasif A, Tung Chong C, Hayakawa A, Okafor EC, et al. Nitrogen oxide emissions analyses in ammonia/hydrogen/air premixed swirling flames. *Energy* 2022;260:125183.
- [65] Vitousek PM, Aber JD, Howarth RW, Likens GE, Matson PA, Schindler DW, et al. Human alteration of the global nitrogen cycle: sources and consequences. *Ecol Appl* 1997;7:737–50.
- [66] Swain W, Colborn T, Bason C, Howarth R, Lamey L, Palmer B, et al. Exposure and effects of airborne contamination. 1994.
- [67] Price D, Birnbaum R, Batiuk R, McCullough M, Smith R. *Nitrogen oxides: impacts on public health and the environment*. Washington, DC (United States). Office: Environmental Protection Agency; 1997.
- [68] Costa C, Wironen M, Racette K, Wollenberg EK. *Global Warming Potential* (GWP*): understanding the implications for mitigating methane emissions in agriculture*. 2021.
- [69] Zhu X, Khateeb AA, Guiberti TF, Roberts WL. NO and OH* emission characteristics of very-lean to stoichiometric ammonia–hydrogen–air swirl flames. *Proc Combust Inst* 2021;38:5155–62.
- [70] Ciccarelli G, Jackson D, Verreault J. Flammability limits of NH₃–H₂–N₂–air mixtures at elevated initial temperatures. *Combust Flame* 2006;144:53–63.
- [71] Um DH, Joo JM, Lee S, Kwon OC. Combustion stability limits and NO_x emissions of nonpremixed ammonia-substituted hydrogen–air flames. *Int J Hydrogen Energy* 2013;38:14854–65.
- [72] Konnov AA. Implementation of the CN₂ pathway of prompt-NO formation in the detailed reaction mechanism. *Combust Flame* 2009;156(11):2093–105.
- [73] Woo M, Choi BC, Ghoniem AF. Experimental and numerical studies on NO_x emission characteristics in laminar non-premixed jet flames of ammonia-containing methane fuel with oxygen/nitrogen oxidizer. *Energy* 2016;114: 961–72.
- [74] Nozari H, Karaca G, Tuncer O, Karabeyoglu A. Porous medium based burner for efficient and clean combustion of ammonia–hydrogen–air systems. *Int J Hydrogen Energy* 2017;42:14775–85.
- [75] Klippenstein SJ, Pfeifle M, Jasper AW, Glarborg P. Theory and modeling of relevance to prompt-NO formation at high pressure. *Combust Flame* 2018;195: 3–17.
- [76] Alnasif A, Mashruk S, Shi H, Alnajideen M, Wang P, Pugh D, et al. Evolution of ammonia reaction mechanisms and modeling parameters: a review. *Appl Energy Combust Sci* 2023;15:100175.
- [77] Konnov AA. Yet another kinetic mechanism for hydrogen combustion. *Combust Flame* 2019;203:14–22.
- [78] Lindstedt RP, Lockwood FC, Selim MA. Detailed kinetic modelling of chemistry and temperature effects on ammonia oxidation. *Combust Sci Tech* 1994;99: 253–76.
- [79] Mashruk S, Xiao H, Pugh D, Chiong MC, Runyon J, Goktepe B, et al. Numerical analysis on the evolution of NH₂ in ammonia/hydrogen swirling flames and detailed sensitivity analysis under elevated conditions. *Combust Sci Tech* 2023; 195:1251.
- [80] Mashruk S, Xiao H, Valera-Medina A. Rich-Quench-Lean model comparison for the clean use of humidified ammonia/hydrogen combustion systems. *Int J Hydrogen Energy* 2021;46:4472–84.
- [81] Dean AM, Chou M, Stern D. Kinetics of rich ammonia flames. *Int J Chem Kinet* 1984;16:633–53.
- [82] Dean AM, Bozzelli JW. *Combustion chemistry of nitrogen*. In: *Gas-phase combustion chemistry*. Springer; 2000. p. 125–341.
- [83] Klippenstein SJ, Harding LB, Glarborg P, Miller JA. The role of NNH in NO formation and control. *Combust Flame* 2011;158:774–89.
- [84] Miller JA, Glarborg P. Modeling the thermal De-NO_x process: closing in on a final solution. *Int J Chem Kinet* 1999;31:757–65.
- [85] Chai WS, Bao Y, Jin P, Tang G, Zhou L. A review on ammonia, ammonia-hydrogen and ammonia-methane fuels. *Renew Sustain Energy Rev* 2021;147: 111254.
- [86] Li J, Huang H, Kobayashi N, Wang C, Yuan H. Numerical study on laminar burning velocity and ignition delay time of ammonia flame with hydrogen addition. *Energy* 2017;126:796–809.
- [87] Baukal CE. *Industrial burners*. CRC Press, 2003.
- [88] JERA. IHI to start a demonstration project related to ammonia Co-firing at a large-scale commercial coal-fired power plant. JERA; 2021 [Internet] [cited 2023 Feb 14]; Available from: https://www.jera.co.jp/en/news/information/20210524_677.
- [89] Valera-Medina A, Banares-Alcantara R. Techno-economic challenges of green ammonia as an energy vector. 1st ed. Academic Press, Elsevier; 2020.
- [90] Lanser A. Controlled industrial-scale combustion of Ammonia for high-temperature applications. In: *NH₃ European conference*; 2019.
- [91] Mashruk S, Xiao H, Valera-Medina A, Mashruk S, Xiao H, Valera-Medina A. Rich-Quench-Lean model comparison for the clean use of humidified ammonia/hydrogen combustion systems. *Int J Hydrogen Energy* 2020;46:4472–84.
- [92] Kujiraoka H, Izumi T., Yoshizuru Y., Suemasy T., Ueda M., Niki T., et al. Evaluation of the cement clinker fired in the combustion furnace of heavy-oil and NH₃ [Internet]. *Ammonia Energy Association*, 2018 [cited 2023 Feb 11]. Available from: https://nh3fuelassociation.org/wp-content/uploads/2018/12/1700-549g181031_Kujiraoka_UBE_NoAPP.pdf; 2018.
- [93] Murai R, Omori R, Kano R, Tada Y, Higashino H, Nakatsuka N, et al. The radiative characteristics of NH₃/N₂/O₂ non-premixed flame on a 10 kW test furnace. *Energy Procedia* 2017;120:325–32.
- [94] Murai R, Nakatuka N, Higashino H, Akamatsu F. Review of fundamental study on ammonia direct combustion in industrial furnaces. *J Combust Soc Jpn* 2019;61.
- [95] Xiao H, Wang Z, Valera-Medina A, Pjpp Bowen. Study on characteristics of Co-firing ammonia/methane fuels under oxygen enriched combustion conditions. *J Therm Sci* 2018;27.
- [96] Valera-Medina A, Marsh R, Runyon J, Pugh D, Beasley P, Hughes T, et al. Ammonia–methane combustion in tangential swirl burners for gas turbine power generation. *Appl Energy* 2017;185:1362–71.
- [97] Numata M, Matsuda T, Hagiwara Y, Yamamoto Y. Development of impinging jet burner using ammonia fuel for degreasing steel sheets. *J Combust Soc Jpn* 2019; 61.
- [98] Tanigawa H. Test results of the ammonia mixed combustion at mizushima power station unit No.2 and related patent applications [internet]. *Ammonia Energy Association*, 2018 [cited 2023 Feb 11]. Available from: <https://nh3fuelassociation.org/wp-content/uploads/2018/12/1530-Chugoku-Electric-Power-Co.pdf>.
- [99] Ito T, Zhang J, Ishihara S, Ishii H, Suda T, Fujimori T. Development of the coal Co-firing technology with ammonia and numerical evaluation of the boiler performance. *J Combust Soc Jpn* 2019;61.
- [100] Ishihara S, Zhang J, Ito T. Numerical calculation with detailed chemistry of effect of ammonia co-firing on NO emissions in a coal-fired boiler. *Fuel* 2020;266: 116924.
- [101] Zhang J, Ito T, Ishii H, Ishihara S, Fujimori T. Numerical investigation on ammonia co-firing in a pulverized coal combustion facility: effect of ammonia co-firing ratio. *Fuel* 2020;267:117166.
- [102] Ishihara S, Zhang J, Ito T. Numerical calculation with detailed chemistry on ammonia co-firing in a coal-fired boiler: effect of ammonia co-firing ratio on NO emissions. *Fuel* 2020;274:117742.
- [103] Kimoto M, Yamamoto A, Ozawa Y, Hara S. Ammonia Co-firing technology applicable to pulverized coal fired boilers. *J Combust Soc Jpn* 2019;61.
- [104] Yamamoto Akira, Kimoto M, Ozawa Y, Hara S. Basic Co-firing characteristics of ammonia with pulverized coal in a single burner test furnace. *AICHE Annual Meeting* 2018;2018:1–14.
- [105] Tamura M, Gotou T, Ishii H, Riechelmann D. Experimental investigation of ammonia combustion in a bench scale 1.2 MW-thermal pulverised coal firing furnace. *Appl Energy* 2020;277:115580.
- [106] Xia Y, Hadi K, Hashimoto G, Hashimoto N, Fujita O. Effect of ammonia/oxygen/nitrogen equivalence ratio on spherical turbulent flame propagation of pulverized coal/ammonia co-combustion. *Proc Combust Inst* 2021;38:4043–52.
- [107] Zhang J, Ito T, Ishii H, Ishihara S, Fujimori T. Numerical investigation on ammonia co-firing in a pulverized coal combustion facility: effect of ammonia co-firing ratio. *Fuel* 2020;267:117166.
- [108] Stocks M, Fazeli R, Hughes L, Beck F. Global emissions implications from co-combusting ammonia in coal fired power stations: an analysis of the Japan-Australia supply chain. *J Clean Prod* 2022;336:130092.
- [109] Anhui Energy Group. A breakthrough in ammonia energy clean combustion power generation (In Chinese) [Internet]. *Anhui State Enterprise Network*, 2023 [cited 2023 Mar 14]. Available from: http://xhs.anhuinews.com/ahgq1/snyjt/202304/t20230412_6790419.html.
- [110] Xu Y, Wang H, Liu X, Zhu J, Xu J, Xu M. Mitigating CO₂ emission in pulverized coal-fired power plant via co-firing ammonia: a simulation study of flue gas streams and exergy efficiency. *Energy Convers Manag* 2022;256:115328.
- [111] Chen P, Wang Y, Wang P, Gu M, Jiang B, Luo K, et al. Experimental and density functional theory investigation of the NO formation mechanism during ammonia combustion in a pulverized coal-fired furnace. *SSRN Electron J* 2022.
- [112] Chen P, Fang Y, Wang P, Gu M, Luo K, Fan J. The effect of ammonia co-firing on NO heterogeneous reduction in the high-temperature reduction zone of coal air-staging combustion: experimental and quantum chemistry study. *Combust Flame* 2022;237:111857.
- [113] Chen P, Jiang B, Wang H, Gu M, Fang Y, Wang P. Experimental and theoretical calculations study on heterogeneous reduction of NO by char/NH₃ in the reduction zone of ammonia co-firing with pulverized coal: influence of mineral Fe. *Fuel* 2022;310:122374.
- [114] Chen P, Wang H, Jiang B, Wang Y, Gu M, Chen G, et al. An experimental and theoretical study of NO heterogeneous reduction in the reduction zone of ammonia co-firing in a coal-fired boiler: influence of CO. *Fuel Process Technol* 2022;231:107184.
- [115] Zhu J, Liu X, Xu Y, Xu J, Wang H, Zhang K, et al. Probing into volatile combustion flame and particulate formation behavior during the coal and ammonia Co-firing process. *Energy Fuels* 2022;36:9347–56.
- [116] Sousa Cardoso J, Silva V, Eusebio D, Tarelho LAC, Hall MJ, Grinberg Dana A. Numerical modelling of ammonia-coal co-firing in a pilot-scale fluidized bed reactor: influence of ammonia addition for emissions control. *Energy Convers Manag* 2022;254:115226.

- [117] Cardoso JS, Silva V, Chavando JAM, Eusébio D, Hall MJ. Numerical modelling of the coal phase-out through ammonia and biomass co-firing in a pilot-scale fluidized bed reactor. *Fuel Communications* 2022;10:100055.
- [118] Ślęfarski Rafał and Czyżewski PGM. Experimental study on CH₄/NH₃ fuels combustion process in industrial furnace with high regeneration of heat. In: 14th international SDEWES conference. Croatia: Dubrovnik; 2019.
- [119] Jójka J, Ślęfarski R. Emission characteristics for swirl methane–air premixed flames with ammonia addition. *Energies* 2021;14:662.
- [120] Hewlett S. Investigating the potential of industrial waste stream ammonia as a fuel for low carbon, gas turbine power generation, PhD Thesis, Cardiff University, 2021.
- [121] Hewlett SG, Valera-Medina A, Pugh DG, Bowen PJ. Gas turbine Co-firing of steelworks ammonia with coke oven gas: a fundamental and cycle analysis. In: Proc ASME turbo expo. Phoenix, Arizona; 2019.
- [122] Cavaliere A, De Joannon M. Mild combustion. *Prog Energy Combust Sci*; 2004; 30 (4): 329-366.
- [123] Sorrentino G, Sabia P, Bozza P, Ragucci R, de Joannon M. Low-NO_x conversion of pure ammonia in a cyclonic burner under locally diluted and preheated conditions. *Appl Energy* 2019;254.
- [124] Okafor EC, Somarathne KDKA, Hayakawa A, Kudo T, Kurata O, Iki N, et al. Towards the development of an efficient low-NO_x ammonia combustor for a micro gas turbine. *Proc Combust Inst* 2019;37:4597–606.
- [125] Manna MV, Sabia P, Sorrentino G, Viola T, Ragucci R, de Joannon M. New insight into NH₃-H₂ mutual inhibiting effects and dynamic regimes at low-intermediate temperatures. *Combust Flame* 2022;111957.
- [126] Zhang Y, Mathieu O, Petersen EL, Bourque G, Curran HJ. Assessing the predictions of a NO_x kinetic mechanism on recent hydrogen and syngas experimental data. *Combust Flame* 2017;182:122–41.
- [127] Ariemma GB, Sorrentino G, Ragucci R, de Joannon M, Sabia P. Ammonia/Methane combustion: stability and NO_x emissions. *Combust Flame* 2022;241: 112071.
- [128] Manna M, Sabia P, Ragucci R, Joannon M de. Experimental study of ammonia oxidation in a jet stirred flow reactor: data consistency with kinetic mechanism results and wall effects. In: 14th international conference on energy for a clean environment. Portugal: Madeira; 2019.