

# Learning by imitation: A hierarchical approach

## Richard W. Byrne

Scottish Primate Research Group, School of Psychology,  
University of St. Andrews, Fife KY16 9JU, Scotland  
rwb@st-andrews.ac.uk  
psych.st-and.ac.uk: 8080/people/lect/rwb.html

## Anne E. Russon

Department of Psychology, Glendon College, York University,  
Toronto M4N 3M6, Canada  
arusson@erda.glendon.yorku.ca

**Abstract:** To explain social learning without invoking the cognitively complex concept of imitation, many learning mechanisms have been proposed. Borrowing an idea used routinely in cognitive psychology, we argue that most of these alternatives can be subsumed under a single process, *priming*, in which input increases the activation of stored internal representations. Imitation itself has generally been seen as a “special faculty.” This has diverted much research towards the all-or-none question of whether an animal can imitate, with disappointingly inconclusive results. In the great apes, however, voluntary, learned behaviour is organized *hierarchically*. This means that imitation can occur at various levels, of which we single out two clearly distinct ones: the “action level,” a rather detailed and linear specification of sequential acts, and the “program level,” a broader description of subroutine structure and the hierarchical layout of a behavioural “program.” Program level imitation is a high-level, constructive mechanism, adapted for the efficient learning of complex skills and thus not evident in the simple manipulations used to test for imitation in the laboratory. As examples, we describe the food-preparation techniques of wild mountain gorillas and the imitative behaviour of orangutans undergoing “rehabilitation” to the wild. Representing and manipulating relations between objects seems to be one basic building block in their hierarchical programs. There is evidence that great apes suffer from a stricter capacity limit than humans in the hierarchical depth of planning. We re-interpret some chimpanzee behaviour previously described as “emulation” and suggest that all great apes may be able to imitate at the program level. Action level imitation is seldom observed in great ape skill learning, and may have a largely social role, even in humans.

**Keywords:** emulation; great apes; hierarchical organisation; imitation; priming

In recent years, many behavioural scientists have come to see imitation as an important manifestation of intelligence in nonhuman species. This is a remarkable sea change in attitude, because less than a generation ago imitation was regarded as more of a nuisance. True intelligence, it used to be thought, is indicated by insight. The “cheap trick” of imitating allowed nonhuman species to simulate intellectual capacities they did not have. Even now, this remains the lay view: imitation may be the sincerest form of flattery, but it is not a sign of intelligence. (A tradition of distinguishing certain kinds of imitation as cognitively complex can be traced back to the last century, as we note in sect. 1.1, so the sea change is in some ways more of a renaissance.) Imitation’s recent promotion to the status of an intellectual asset in cognitive science has been accompanied by a wealth of evidence that many nonhuman species are unable to learn by imitating the actions they see others perform, whereas even newborn humans are now reported to show imitation. A generation ago, behavioural scientists (as laymen do even today) routinely explained the spread of novel habits among nonhuman species as the result of imitation,



RICHARD BYRNE is Professor of Evolutionary Psychology at the University of St. Andrews, Scotland, and works on the behavioural ecology and cognition of primates. In addition to writing 93 articles, he is co-editor of three books and author of *The thinking ape: The evolutionary origins of intelligence* (Oxford University Press, 1995), which was awarded the British Psychology Society’s Book Award, 1997.



ANNE RUSSON is Associate Professor of Psychology at Glendon College of York University (Toronto, Canada) and the author of over 20 scientific publications in the area of primate cognition, including a recent edited volume on great ape intelligence.

but any scientific report of nonhuman imitation now attracts the closest scrutiny. Most reports can indeed be satisfactorily accounted for by simpler mechanisms of learning (“simpler” in the sense of Lloyd Morgan’s scale of complexity, and in involving only mechanisms *already* thought to be necessary to account for other data). All these simpler mechanisms depend at root on the behaviourist notion of associative conditioning.

We do not question the essential rightness of these changes, but we believe they have not yet led to a good understanding of what the process of imitation involves, and what imitation might be useful for in the lives of other species. In discarding the murky bathwaters of loose definitions and weak scientific control, the baby may have been temporarily lost as well.

In this target article, we review briefly the theoretical apparatus that has been found useful in explaining how nonhuman species can seem to learn by imitating when they are not. Definitions of “true” imitation abound already, but none are universally accepted. Given this state of affairs, we have concentrated on the empirical data that researchers accept (or would accept) as conclusive evidence of imitation, irrespective of how they define imitation. We single out one of the currently favoured diagnostic tests of imitation, the bidirectional control procedure, which incorrectly identifies imitation on the basis of behaviour that can be explained more simply in other ways. Using priming, a common explanatory concept in cognitive psychology, we show that a single mechanism can account effectively for most cases of animal social learning with no need for any “special purpose” explanations. *Novelty* will prove to be a cardinal requirement of imitation.

With this background, we attempt to develop an approach that can describe the richness of imitative behaviour in humans and some of the great apes. Our aim is to go beyond the question “Is it imitation, or not?” to ask instead “What sort of imitation is it, and why is it used?” Examples of behaviour observed in gorillas and orangutans substantiate our view. These examples are not intended to “prove” that the apes can imitate; that vexed question has been discussed in the original publications and is not the central issue here. Instead, we develop a new way of looking at imitation, arguing that rather than being a distinct “special faculty,” it is one of a range of cognitive mechanisms for manipulating hierarchical representations of behaviour. This calls into question the widespread current use of “simple” actions to test for imitative ability experimentally. The adaptive role of imitation may be to help acquire complex, novel behaviour; it may be inappropriate in other situations. Our interpretation has implications not only for animal behaviour and developmental psychology, but for evolutionary aspects of anthropology and neuropsychology. If our approach has merit, it should serve to draw theory in all these areas closer to those of cognitive developmental psychology and artificial intelligence.

## 1. Nonimitative learning resembling imitation

**1.1. Sorting wheat from chaff.** The idea that there is a “scale” of imitative faculties that vary in complexity has existed since the times of Romanes (1884; 1889). The standard belief is that the highest levels of perfection of the imitative faculty are achieved in humans, but that rudimentary forms occur in other species. Various terms have been proposed to capture the difference between this highest level

imitation and the simpler processes that generate behaviour merely simulating it. These include “reflective imitation” (vs. instinctive imitation, Morgan 1900); “imitation” (vs. pseudo- or semi-imitative phenomena, Thorndike 1898); “sensorimotor stage 6 imitation” (vs. stages 1 – 5 imitation, Piaget 1945/1962); “true imitation” (vs. local enhancement, Thorpe 1956), “level 4 imitation” (vs. levels 1 – 3, Mitchell 1987); “observational learning” (vs. other social learning processes, Galef 1988); “impersonation” (vs. emulation, Tomasello 1990, citing Wood 1989). [See also Tomasello et al.: “Cultural Learning” *BBS* 16(3) 1993.]

A host of definitions and criteria have been proposed to sort out the “wheat” of evidence for the special faculty of imitation, from the “chaff” of material that can be explained by other, simpler processes; these have been extensively reviewed and discussed (e.g., Galef 1988; Moore 1992; Tomasello et al. 1987; Visalberghi & Fragaszy 1990; Whiten & Ham 1992). This approach, of sorting out wheat from chaff, derives from scholars working in the tradition of comparative psychology, especially animal learning theory, who originally took on the task of assessing the capacity for imitation in all nonhuman species. All the resulting definitions of imitation, of which Thorndike’s classic “learning to do an act from seeing it done” (1898, p. 50) is perhaps as good as any, are therefore “threshold” definitions that establish only minimal criteria for imitation and thereby portray imitation as a single capacity. None of these comparative definitions address the possibility that, even for imitation in the strong sense of the term, there may exist multiple forms, nor do they aid dissection of what is cognitively involved in imitation. This has been less uniformly true of cognitive-developmental approaches to imitation (e.g., Mitchell 1987; Piaget 1945/1962). But although scholars working within this latter tradition have applied their models of cognition to nonhuman primates for the last 20 years, they have only recently begun to consider cognitive processes operating beyond sensory-motor levels. It is perhaps no coincidence that our own backgrounds are in cognitive psychology and information processing; we aim to show the relevance of models of higher level cognitive processes to nonhuman imitation.

Our primary objectives in this article are (1) to set up a heuristic distinction between two different kinds of imitation: copying the organisational structure of behaviour *versus* copying the surface form of behaviour; and (2) to argue that at least the first of these, program level imitation, depends on the organism having the ability to build hierarchical structures of actions, an ability with more general consequences.

We must first follow a more traditional line, however, to set aside the phenomena that we do not wish to discuss from the cases of significance where something new about behaviour is acquired by seeing another individual do it. To do this, we must undertake a discussion of the other mental processes that can generate copies of demonstrated actions. Extensive mulling over the issue of imitation has generated a long list of hypothetical mental processes that can, independently or in combination, generate copies of demonstrated actions. As the list has lengthened, many attempts have been made to categorize the different possibilities into a systematic and meaningful psychological framework and to standardize terminology (e.g., Galef 1988; Heyes 1993; Whiten & Ham 1992). To our minds, none of the existing classification systems offers a package that clarifies all the important psychological distinctions, or leads to an under-

standing of how, given the processes that have been identified, genuinely imitative behaviour can best be identified. Terminological proliferation suggests that several distinct processes are involved in producing “pseudo-imitation,” but we argue that a single process will suffice for most of them. We now offer our own attempt to impose order on the plethora of processes proposed, and on this basis identify phenomena that do not qualify as imitation.

**1.2. Stimulus enhancement.** The great majority of observations that suggest nonhuman imitation are vulnerable to reinterpretation as stimulus enhancement coupled with individual learning (Spence 1937; “local enhancement,” Thorpe 1956). Stimulus enhancement is the tendency to pay attention to, or aim responses towards, a particular place or objects in the environment after observing a conspecific’s actions at that place or in conjunction with those objects. (In the most powerful formulation, this tendency would be specific to cases where the conspecific is obtaining valued rewards by its actions; see Byrne 1994.) The result of this narrowing of behavioural focus is that the individual’s subsequent behaviour becomes concentrated on these key variables. Naturally, this increases the chance that the animal will learn to gain the reward it has seen its conspecific obtain, often by performing the same actions, whereas an individual on its own would seldom do so. However, the mechanism that generates this apparent copy is the conventional one of individual trial-and-error learning. Observation of the conspecific’s pattern of behaviour is not causal to changing the observer’s pattern of behaviour. Here we agree with others in the field, that copying that can be explained in terms of stimulus enhancement coupled with individual learning does not qualify as an instance of imitation.

Stimulus enhancement, however, can be subsumed under a class of mechanism very general in cognitive psychology. A hypothetical example will serve to explain this idea (numerous real cases explained as stimulus enhancement are given in Byrne 1994; Moore 1992; Whiten & Ham 1992; Zentall & Galef 1988). Suppose a monkey observes another monkey eating under a coconut tree. Stimulus enhancement focuses the observing monkey’s attention on the large nuts on the ground under the tree and it begins to experiment with the nuts and discovers how to crack them open, using actions in its own repertoire. It will consequently learn more quickly and successfully than if it had come on the coconut tree alone. It may happen to end up using the same technique as the other monkey, but not because the other monkey showed it. In cognitive terms, the social contribution to this learning process can be rather simply described as *priming*: increasing the activation of stored internal representations that correspond to those particular environmental stimuli that co-occur with the sight of a conspecific gaining a reward. The concept of priming assumes that there exist structures (“records”) in memory that represent familiar or identifiable items (Baddeley 1990, p. 172). For any recognizable locations or objects, this must be the case. Identification of these locations or objects, in the context of a conspecific gaining rewards, increases the “activation” or “salience” of the corresponding records. The “primed” records then channel conventional exploratory behaviour and trial-and-error learning towards the now-salient objects, often producing the semblance of imitation.

**1.3. Emulation.** Whereas stimulus enhancement changes

the salience of certain stimuli in the environment, emulation changes the salience of certain goals. In the simplest formulations (Kohler 1925/1976; Tomasello 1990, citing Wood 1989; “goal emulation,” Whiten & Ham 1992), the purpose or the goal towards which the demonstrator is striving is made overt as a result of its actions, and so becomes a goal for the observer, too. The observer attempts to “reproduce the completed goal . . . by whatever means it may devise” (Tomasello 1990, p. 284). Tomasello et al. (1987) liken this process to “a variant of the stimulus enhancement hypothesis” in which the observer learns something about the environment but nothing about the behaviour of another. How the observer reaches that goal is a matter of individual learning or prior knowledge, neither of which is directly influenced by the techniques it has observed. Nevertheless, the observer working towards this emulated goal may happen by chance to use the same techniques as the demonstrator, thereby giving the appearance of imitation. Seeing the actions of the other is not important; what matters is that the concrete result of them is identified, and so can be emulated. Again, we agree with others in the field that such emulation does not qualify as imitation.

In cognitive terms, goal emulation, too, can be described as a matter of priming (Byrne 1994; 1995a). Whereas stimulus enhancement primes brain records of stimuli, emulation primes brain records of goals. All that is necessary for this model is that the goals themselves are familiar or identifiable. Primed, activated goals are addressed before unprimed ones.

The meaning of “emulation” has recently shifted, however, to include a wider range of phenomena. This shift in usage is illustrated in interpretations made of the findings from three experiments on imitation in chimpanzees and orangutans. In all three, subjects who observed a demonstrator raking in out-of-reach food with a rake tool subsequently used a similar tool themselves to attain the food, yet they failed to copy some details of the model’s technique (Call & Tomasello 1994; Nagell et al. 1993; Tomasello et al. 1987). Tomasello and his colleagues described all these effects as emulation, arguing that the subjects reproduced the observed goal and learned about the “affordances” of the tool, but used idiosyncratic behavioural techniques to attain it. The affordances of a tool are said to encompass its function as a tool, the fact that the goal could be obtained with the tool, or something about the relationship between the rake and the food (Tomasello et al. 1987; 1993). The meaning of “emulation learning” (Call & Tomasello 1994) has thus expanded to incorporate observational learning about the properties of objects and potential relationships among them. This sort of learning seems to us a cognitively complex phenomenon open to very different interpretations, and one that may require psychological processes distinct from those that can account for simple goal emulation. We return to this issue in section 2.7.

**1.4. Response facilitation.** In the processes of both stimulus enhancement and goal emulation, the influence of the conspecific on an observer’s learning is an indirect one. Its actions direct attention to places and objects, but the actions themselves are not copied. Indeed, under some circumstances, the other individual need not even be present to produce the effects. Simply finding coconuts beneath a certain tree, cracked open but still containing a little flesh, may increase the salience of the location and features of co-

conuts (stimulus enhancement), or stimulate the aim of eating coconut meat (goal emulation). To discover whether specific actions have been copied – imitation – many researchers have resorted to an experimental test. An individual is given the sight of a conspecific (the demonstrator) performing an action of a specific type. The subsequent probability of the test animal performing the same action is then compared with its original, baseline probability of doing so. Imitation is operationally defined as a significant elevation in the frequency of an observed action over the normal probability of its occurrence. In an improved version of this method, two groups of test animals are used, each seeing the same problem solved by a conspecific but in different ways. Then, not only can their baseline frequencies of performing the actions be compared, but the groups can be compared with each other in the frequencies of using each technique (see Galef 1988; 1992; Heyes 1993; Whiten & Ham 1992). Imitation is then defined as a significant divergence between the groups in the frequencies of using the two actions, matching the actions observed. In these animal experiments, the test actions used have always been part of the existing repertoires of the subjects, actions whose spontaneous probability of occurrence is not low.

This experimental technique has also been used extensively in developmental psychology to ask whether very young humans can imitate (e.g., Meltzoff & Moore 1977; 1983). Typically, one of a set of several different target gestures is repeatedly performed by an adult in front of an infant whose responses are filmed. The crucial test of imitation is considered to be a selective increase in the frequencies of matching gestures: for example, significantly more infant tongue protrusion after adult tongue protrusion than after adult mouth opening, and vice versa for mouth opening. Positive results have been confirmed in many laboratories, and it is now accepted that several different facial gestures are copied by infants, even when tested only a few hours after birth. The simple gestures have sometimes been “novel” ones for the very youngest infants, in the sense that they have not yet performed them, unlike the case in the animal work. Nevertheless, the spontaneous probability of these actions occurring is not low, so the actions are evidently in the (as yet unexpressed) repertoire of the neonate. The researchers probably have little choice in this, because the neonate or weeks-old babies used in the experiments lack the ability to copy a wide range of gestures.

There is now a mutually supportive consensus among many developmental and comparative psychologists that this sort of experimental paradigm is conclusive evidence of imitation. By this criterion, the ability to imitate has now been detected in a few species of animal (e.g., budgerigars, Dawson & Foss 1965 and Galef et al. 1986; rats, Heyes & Dawson 1990 and Heyes et al. 1992; chimpanzees, Whiten et al. 1996), and in near-helpless neonatal human babies. However, we dispute that any of these experiments, using either animal or human subjects, provide evidence of imitation. In the case of animal data, we again propose priming as the explanation.

If the salience of stimuli can be increased and goals can be highlighted, by observation of a conspecific's actions, then surely an individual's responses might also be facilitated by what it sees. In cognitive terms, just as brain records of stimuli and goals may be primed or activated by the observation of others, so those of responses might also be primed, making them more likely to occur (Byrne 1994;

1995a). If an individual were to see another gaining a reward while performing a response that physically resembled one in its own repertoire, then the corresponding brain record would be primed and a matching response made more likely in its own subsequent behaviour. As before, all that is required is the existence of structures in memory corresponding to the facilitated actions, which has to be the case for actions in the existing repertoire. Like stimulus enhancement and goal emulation, this simple phenomenon of “response facilitation” would simulate imitation under some circumstances (Byrne 1994). It is important to distinguish this theoretical proposal from two different phenomena. In “contagion” (Thorpe 1956), actions that an individual sees performed by another may trigger the same actions in the observer, as in contagious yawning. But here the linkage is innate and involuntary, whereas in response facilitation the effect has the potential to occur with any action in the individual's repertoire, voluntary as well as involuntary, provided the individual's perceptual system registers the physical resemblance. In “social facilitation” (e.g., Bandura 1986; Galef 1988), the motivational homogeneity among a group of individuals is increased and they may tend therefore to perform the same behaviours at the same time, but no specific performance of a motor act is influenced, as happens in response facilitation.

Any experiment that uses changes in the relative frequencies of actions already present in the individual's repertoire as evidence of imitation is potentially vulnerable to reinterpretation as response facilitation (Byrne 1994; Byrne & Tomasello 1995). Of course, if an action appears radically different in form when viewed from the perspective of demonstrator versus performer, or is invisible to its performer as in the case of the tongue-protrusion used in neonatal human work, this criticism has no weight. Priming can only apply once the identity is registered, and the very means of recognition is what requires explanation in neonatal imitation. (It remains possible that contagion could account for babies' matching of maternal gestures, because only a few gestures are involved [Anisfeld 1991]; close behavioural matching between mother and infant is potentially beneficial for the relationship, so the evolution of innate linkages for a few discrete actions is not implausible.) In contrast, the animal work has employed responses that look essentially the same to the test animal when performed by the animal itself or another. We believe that this sort of experiment, which relies on existing responses, is in principle insufficient for any convincing demonstration of imitation in animals or humans (see Byrne & Tomasello 1995, for a detailed critique of one claim to the contrary).

**1.5. Implications of priming.** We would thus unify three apparently different phenomena and explain them all by a single theoretical mechanism, one already found to have explanatory power in cognitive psychology where it is extensively used. In contrast to the several supposed mechanisms that are sometimes invoked to explain behaviour mimicking imitation (and some behaviour claimed to *be* imitation), we propose a single mechanism of extreme simplicity, thus reducing the amount of “special purpose” theory needed to understand behaviour. When this mechanism, observational priming, operates on records of stimuli in the immediate environment, responses in the individual's repertoire and goals it might choose, the result can indeed look very much like imitation (as discussed in Byrne 1994).

Priming can never produce an entirely new behaviour, or an entirely novel arrangement of “old” behaviours. Novel behaviour can only arise from other processes, possibly enhanced by priming: individual trial-and-error learning, insightful planning and thought, or imitation. Novel behaviour that arises from trial and error will have a characteristic signature in the history of reinforcement. Novel behaviour might arise from insightful planning and thought, but we take this to be an even less parsimonious explanation than imitation where the latter is also possible, as in all cases discussed in this target article. We argue, therefore, that novelty of behaviour is an essential part of any proper definition of animal imitation. In many past definitions the acquisition of new behaviour was not stressed or was seen as only one aspect of imitation, such as Thorpe’s “copying of a novel or otherwise improbable act” (Thorpe 1956). We support Zentall’s firm ruling that to be sure of imitation, the act should not already be part of the animal’s repertoire, whether improbable or not (Zentall 1996). Humans, as we know from conscious experience, sometimes imitate actions that they can perform already; but if this were shown by animals, other explanations for their behaviour would always remain possible.

## 2. Imitation by animals

Turning now to manifestations of social learning that appear to be cognitively more complex and not explicable on a simple priming and trial-and-error model, we will first consider how animal behaviour should be properly described. We argue that, at least for certain species of animal, behaviour is hierarchical – at levels that allow functional control by the individual, not merely in the underlying organisation of units to which the individual has no access and no possibility of control. For these species, it is a real issue to determine at which level or levels in the hierarchy of behaviour imitation would take place, if it were to occur. The case that some animals *can* control the hierarchical organisation of their behaviour will be made with data from the routine food-preparation activities of mountain gorillas, engaged in their daily activity of eating plants. We aim to establish that great apes have the ability to imitate behaviour at an organisational level of description, the “program level.” We then go on to use behavioural records of orangutans engaged in attempts to copy the actions of human caretakers, to dissect program level imitation into its components, most crucially the observational learning of how to manipulate object-object relationships. Finally, we apply these ideas to a better interpretation of some existing data from chimpanzees. It is not our primary aim to attempt to convince sceptics that great apes can imitate. Although we do consider this to be the most parsimonious interpretation of current evidence (and we both made that argument in the original data papers), here our intention is to propose and defend a new interpretation of how imitation works and what it is for. We suggest that imitation, in the sense of acquiring skills by observation, can best be recognized by its organisational structure, that its biological function is to allow observation to be used (in conjunction with other methods) to facilitate the building up of novel, complex, hierarchical organisations of simpler units of behaviour, and that, in principle, only species with control over the hierarchical organisation of their behaviour can imitate in this way.

**2.1. Hierarchical organisation of behaviour.** It has long been hypothesized that behaviour is hierarchical in organisation. Lashley (1951) argued that the linear serial order of actions concealed an underlying hierarchical structure, and this structure rendered stimulus-response models inadequate; the issue for Lashley was hierarchical structure that is under some voluntary control. More recently, Dawkins (1976) proposed hierarchical organisation as pivotal to understanding the evolution of behaviour, arguing by analogy with many other cases in developmental and neural biology, which had already been found to be hierarchical, and on grounds of efficiency. He showed that hierarchical organisations of control are easier than linear ones to repair when they fail, allow the economy of multiple access to common subroutines, and combine efficient local action at low hierarchical levels while maintaining the guidance of an overall structure. In human behaviour, hierarchical structuring has long been argued to be essential for many acquired skills, such as language, problem solving, and everyday planning (Byrne 1977; Chomsky 1957; Miller et al. 1960; Newell et al. 1958; Newell & Simon 1972). In addition, theories of cognitive and linguistic development argue that age-related increases in cognitive and linguistic complexity are the products of hierarchical mental construction processes (Case 1985; Gibson 1990; 1993; Greenfield 1991; Langer 1993).

The proposal that behaviour is hierarchical may apply in at least three ways. First, evolution may tend to favour hierarchical structuring, as Dawkins (1976) has argued, in behaviours whose execution is under tight genetic guidance. Second, automatic processes of learning may organize groups of behaviours, learned singly and linearly, into hierarchical structures. In animal learning theory the possibility of “second-order” or hierarchical association has sometimes been proposed, for example, between a discriminative stimulus and a response-reinforcer relationship (Rescorla 1991). Even this limited amount of hierarchical organisation is not fully accepted, however (Mackintosh 1994). In neither of these first two cases does the individual organism have voluntary access to, or control over, the hierarchical structure; the structures are simply induced and triggered by constellations of stimuli.

We wish to consider a third and more radical possibility (already entertained by Lashley 1951), that individuals of some species of animal have access to the hierarchical structure of their own behaviour, and control over its organisation, just as humans show in planning or problem-solving. In distinguishing this case from the first two, the crucial issue is whether behaviour is controlled by an elaborate but modifiable structure of goals and subgoals. If so, then the interesting question for imitation becomes the extent to which individuals can and do imitate this organisation of behaviour, rather than the old issue of whether they can imitate a particular action. The answer to this new question impacts on the nature of intelligence in spontaneous behaviour. We would be reluctant to describe as intelligent any sequence of behaviour whose mental organisation is a single unit of action connected to a goal-representation, a long sequence of linear associative connections, or a rigid hierarchical structure. Thus, whether a behavioural structure is modifiable by the individual becomes crucial in diagnosing it as “intelligent.”

We now turn to two “case studies” on gorillas and orangutans that we think point to Lashley’s proposal as applying in this most radical form, at least in the great apes.

**2.2. Case study: Hierarchical order in mountain gorilla food preparation.**

Gorillas inhabit rainforests over a wide area of west and central Africa. As in other great apes, ripe, fleshy fruit forms a major portion of their diet, and as with other apes eating fleshy fruit, their eating techniques are typically not subtle or complex. However, gorillas have also colonized a quite different habitat, and one small population inhabits the subalpine moss forest and temperate meadows of volcanoes in Rwanda, Zaire, and Uganda. In these habitats, there is almost no fleshy fruit, and these mountain gorillas feed instead on the leaves and pithy stems of herbaceous plants (Watts 1984). This diet is nutritionally superior to relying on ripe fruit, as it is rich in protein and trace elements (Waterman et al. 1983). This largely obviates the need for the supplementation with animal and fungal matter seen in lowland gorillas, orangutans, and chimpanzees. However, the favoured leaves and stems are protected by physical defences like spines or stings, or encased in hard and indigestible material. The only other mammals that regularly eat these plants are ungulates, which have stomachs that are either specialized or very large, in both cases allowing bacterial digestion of plant matter. Gorillas, like other great apes and humans, have simple stomachs. Gorillas cope with the problems in quite a different way, using manual skill (Byrne & Byrne 1991; 1993).

In describing gorilla feeding, we will concentrate on just two plants, nettle *Laportea alatis*, covered in painful stings, and bedstraw *Galium ruwenzoriense*, covered in tiny hooks that enable the plant to clamber. The gorillas' techniques for preparing nettle and bedstraw to eat appear to be adjusted to minimize the unpleasantness caused by

these physical problems. For nettle, their technique effectively removes the worst stings, those found on the main stem and leaf petiole, and enfolds others on the leaf margins. A flowchart representation of the process (Figure 1A) emphasizes the need for bimanual coordination, as well as the overall complexity. After pulling a plant into range, one hand is formed into a cone shape, cupping the base of the stem, and swept upward, stripping a whorl of leaves from the stem. This process may be repeated, while holding the already-stripped whorl(s) with the lower fingers as another whorl is obtained, until a good handful is ready. Then, the leaf blades are firmly gripped, and with the other hand the petioles are grasped; the two hands are twisted or rocked against each other, detaching the petioles, which are discarded.

As an alternative to simply repeating the process of stripping, the whole of the first few stages may be iterated, again holding the bundle(s) of prepared leaf blades with the lower fingers while another bundle is added, until a good handful is ready. If there is any dry or otherwise inedible debris, it is then picked out from the mass of leaf blades held in the half-open hand. Next, the handful of leaf blades is partially pulled out from the closed hand, folded over the thumb, and grasped again, forming a "sandwich," with the powerful stings of the leaf margin enclosed within a parcel that presents to the outside only the less sting-infested under-surface of the leaf. This parcel is then popped through the sensitive lips, without contacting them. By this means, all major areas of stings are removed or enfolded, and a substantial handful of nutritious leaves is eaten at once.

The technique for processing galium (Figure 1B) is sim-

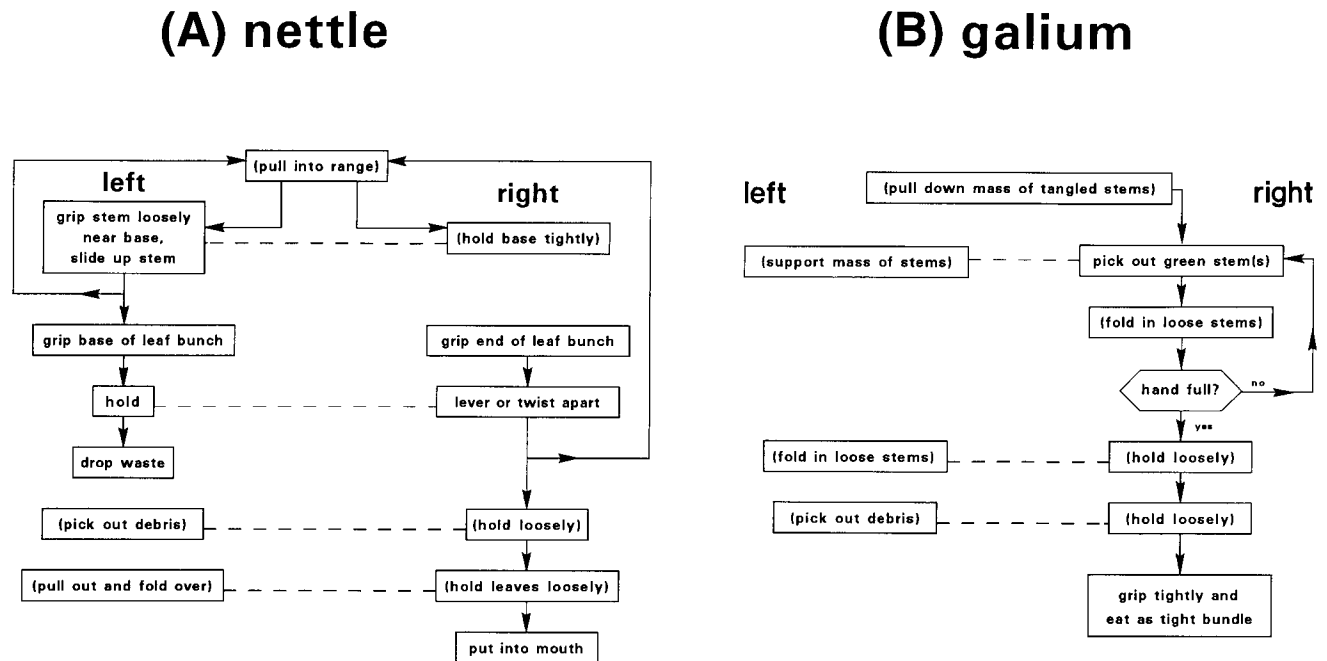

Figure 1. Gorilla plant preparation. Flow-chart representations of the data on processing sequences seen in a gorilla eating (A) nettle *Laportea alatis* and (B) galium *Galium ruwenzoriense*. Where the logical structure is asymmetric, the mirror form will also occur; the form shown is for a left-handed individual. As is conventional with flow-chart representation, the sequence of actions – which begins here when the gorilla finds a food plant to eat – starts at the top and moves down. Rectangular boxes show actions, described by the words in them; parentheses indicate actions that are optional, depending on environmental conditions. Dotted lines indicate bilateral coordination between the separate actions of the two hands. Boxes are arranged to the left and right of the midline to indicate significant lateralities in the hand used (actions with nonsignificant laterality are represented on the midline). Diamonds represent branch points in the process, with the approximate criteria for the decision indicated in words in the diamond: A process may repeat or iterate until the criterion is reached. The sequence ends with putting processed food in the mouth.

ilarly complicated, but has different functions. Here, the problem is that tiny hooks on trailing stems would tend to catch on throat and mouth surfaces, making eating inefficient and causing a risk of choking. The gorillas' technique works here by compressing a bundle of stems to eat with slicing bites, so that the tiny hooks cannot attach to the interior of the mouth. Once a mass of bedstraw is hauled into range, tender green stems are picked out, the picked stem(s) being repeatedly held with the lower fingers while others are added, until an adequate mass is built up. Loose stems are folded into the bundle, both during and after this iterative accumulation, either using the other hand or – if the gorilla is in a tree and that hand is already being used to hold on – by rocking the hand back and forth, grasping and regrasping the stems that gravity causes to fold. Like nettle, bedstraw often includes dead leaves and other debris that must be removed before ingestion; and where this is the case the actions of removing these inedible items are identical in both techniques. The manner of ingestion, however, is quite different: the bundle is rolled against the chin or hard palate to compress it, then sliced with shearing bites of the molars, rather like chopping herbs on a board.

Because these techniques are found only in a small population of gorillas, and indeed are valueless outside the very limited altitudinal zones in which temperate plants like nettle and bedstraw grow in Africa, there is no serious doubt that they are learned. But is their structure the sort of thing that an associative mental process could produce, or are there signs of complex hierarchical organisation under voluntary control? No field experiments have been, or could be, carried out on the members of this highly endangered subspecies of gorilla. Fortunately, however, food preparation is not a rare activity, and the data from hundreds of hours of focal-individual observation are available to help us understand the structure of the techniques.

For a start, we know that at the most detailed level of description of manual actions, each gorilla uses several variants of each behavioural element in the process (Byrne & Byrne 1993). These variants apparently have no functional significance – each works just as well, and the variant chosen is most likely partly determined by the environment, the plant itself – just the sort of low-level, local decision making that Dawkins (1976) pointed out as an advantage of hierarchical structure. An associative, probabilistic process may well be an adequate representation of this process of selection. (However, a choice hierarchy cannot be ruled out; see Dawkins 1976 for the criteria that enable a choice hierarchy to be distinguished from a Markov model.)

Turning next to the processes' structural organisation, does this show any clearer signs of hierarchical structure of the sort that the individuals can control voluntarily? The strongest evidence that it does is given by the animals' ability to iterate parts of each process, as already noted. Miller et al. (1960) first pointed out the importance of iteration until some predefined criterion was reached, a test-operate-test-exit loop. A loop is not a hierarchical structure, but it betrays the presence of a subroutine that can be iterated. Figure 2 uses this evidence to show the hierarchy that is implied for processing nettle. The presence of optional processes (those shown in parentheses in the flow chart of Figure 1) serves both to parse the string into definite components, and to show that a linear chain would be an insufficient description, because one link in a chain cannot be "dropped" without losing the place in the sequence alto-

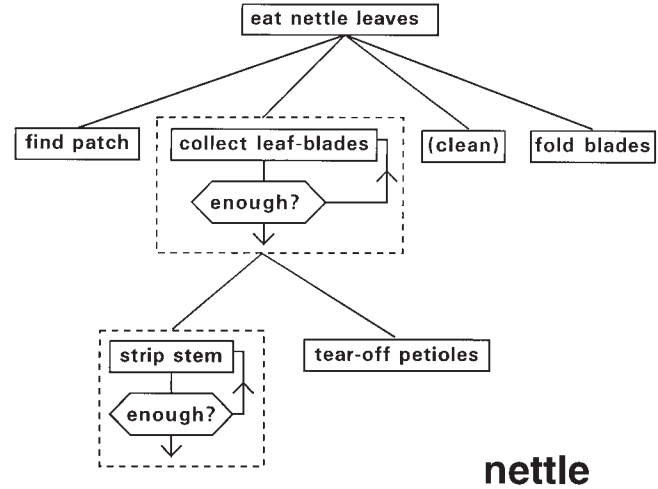

Figure 2. *Goal hierarchy for nettle.* The hypothetical program of minimum hierarchical complexity needed to produce the actual behaviour observed in a mountain gorilla preparing nettle leaves to eat. The "top goal" is placed at the top of the figure, indicating its control of the goals below it, and this may occur recursively, increasing hierarchy "depth."

gether. The tree structure of Figure 2 displays the *minimum* necessary complexity that is implied by the observed presence of loops and optional processes. In reality, there may well be further hierarchical organisation accessible to modification in some of the "single act" stages, but we have no evidence for this at present.

In linguistics, rewrite rules are often used as a compact way of representing the branching tree structure that logically results from a goal hierarchy, and the nettle technique can easily be represented as a phrase-structure grammar of goal and subgoals:

nettle → find + collect + (clean) + fold  
 collect → strip + tearoff + (collect)  
 strip → strip + (strip)

When a goal hierarchy of this nature is expanded, the system must somehow keep track of where the process has got to; this requires a working memory. As the problem is "unpacked" into component subgoals, the system needs to be able to retrace up the hierarchy, after dealing with one subgoal, to proceed with subsequent ones; some memory has to keep track of where to return to. In a computer, this is often done with a push-down stack. As the search delves deeper into the branching structure, subgoals are added to the top of the stack. When one goal is satisfied (popped off the stack), the next is automatically available (pops up). The size of the heap on the stack varies with the depth of unpacking. In a real system, such as the mind of a gorilla or a human, short-term memory capacity might set a limit on how deep a hierarchy it could expand without getting into a muddle.

With a physical task, as opposed to that of constructing a sentence, the "external memory" of the current state of a problem may relax this capacity constraint on working memory, and for gorilla feeding, the state of a part-processed handful is continuously in view. This makes a production system, in which productions are selected successively by the current state of the problem, a particularly appropriate representation of this sort of behaviour (see Fig. 4, and Byrne 1995b). By definition, a linear, chain-like process has no equivalent mechanism for jumping from one

**galium****nettle**

Figure 3. *Linear models of feeding technique.* Hypothetical linear chains of action generators (partly overlapping) that might be proposed to account for sequential regularity in gorilla preparation of nettle and galium (see text).

point to another. If a routine were shared between two food-processing sequences – as is the case in gorilla feeding for the delicate operations involved in cleaning out debris from leaf bundles during preparation of nettle or bedstraw – confusion must be expected (see Fig. 3). Were such a chain-like model to be correct, errors should sometimes occur, of a distinctive sort: for example, suddenly treating a bundle of nettle leaf blades as if they were bedstraw stems, and rolling the bundle against the chin. Nothing of the sort occurs. The processes of mountain gorilla food preparation are simply not well described as linear and chainlike: their organisation is hierarchical.

“Hierarchical organisation” should not be taken to imply one in which control is always imposed “top-down.” As noted above, it is likely that many decisions about manual actions are local ones, dependent on the precise detail of plants encountered. All we mean is that the organisation of goals and subgoals is hierarchical; the subprocess working towards each subgoal may well have considerable autonomy, so there may be periods of “heterarchical” control. Nor do we suggest that the hierarchical organisation of skilled manual actions by gorillas is in all ways similar to human action in skilled manual tasks. For example, there may be a quantitative difference in depth of hierarchical expansion. Gorilla food preparation appears organized into shallow hierarchies, and perhaps gorillas can only keep track of two embedded goals even with the aid of the “external memory” present in physical tasks.

Finally, we would emphasize that we do not suggest that gorillas’ organisation of behaviour is inflexible in structure, like some conventional computer programs. The evidence that we have used, to show that gorillas have functional control over hierarchical structures of actions, shows that such rigidity is unlikely. Representation of their techniques as production systems captures this sensitivity nicely: if a stage is unnecessary, the corresponding subprocess is never evoked (see Fig. 4).

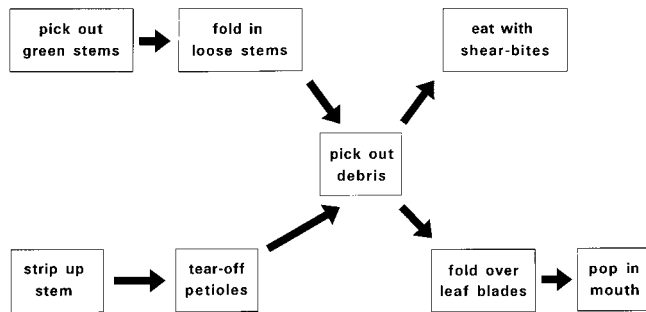
**2.3. Hierarchical levels of imitation.** Having illustrated the hierarchical nature of gorilla techniques of plant feeding, we turn to the implications for imitation. How might the complex techniques used by mountain gorillas be acquired? There seems little doubt that learning *what* to eat is

- 1 (galium bundle is tight) &  
(galium bundle free of debris) &  
(galium in neat bundle) &  
(enough galium for mouthful) &  
(galium in hand) &  
(galium in view) => (eat with shear bites)
- 2 (galium bundle free of debris) &  
(galium in neat bundle) &  
(enough galium for mouthful) &  
(galium in hand) &  
(galium in view) => (roll against chin)
- 3 (galium in neat bundle) &  
(enough galium for mouthful) &  
(galium in hand) &  
(galium in view) => (loosen grip and pick out debris)
- 4 (enough galium for mouthful) &  
(galium in hand) &  
(galium in view) => (fold in trailing stems)
- 5 (galium in hand) &  
(galium in view) => (pick out green stem and add to handful)
- 6 (galium in view) => (pull down mass of stems)

Figure 4. *Production system for galium.* A P-S model that is consistent with the hierarchical structure of behaviour observed when gorillas prepare handfuls of galium to eat.

straightforward for infant gorillas, because they are showered with food remains by the mother from the first day of life. In addition, the priming effect of stimulus enhancement would tend to focus a young gorilla’s attention on the growing plant as a potential object to investigate. The interesting question becomes, how does a gorilla first acquire the elaborate sequence of coordinated actions that converts, say, nettle plants to edible mouthfuls? The answer must be consistent with two facts. After 3 years of age, the age of weaning, there is no further change in efficiency as measured by time to prepare a handful of food (Byrne & Byrne 1991): techniques are learned quickly. Second, for an infant mountain gorilla the only potential direct social influences on feeding are the mother, whom an infant usually accompanies when foraging, and the silverback leader male. Other individuals are intolerant of the presence of nearby conspecifics when feeding, and the dense herb vegetation means that animals are out of sight when only a few metres apart.

Unlike the imitative behaviours usually studied by comparative psychologists, learning a new gorilla feeding technique is not a matter of adding a unitary action to a limited repertoire. Instead, many acts must be built up into one particular logical structure, out of a vast range of potential structures (the term “structure” is used to include sequential regularity, bimanual coordination, and the organisation of subroutines). The novelty lies in the arrangement, and the skill is to arrange some basic repertoire of actions into novel and complex patterns rather than to learn new basic actions. The lowest level in the hierarchy would consist of the smallest possible elements of action that can be independently controlled by the individual. In a great ape, extensive neural representation of the hands allows rather



precise control, and this set of basic elements may be very large. Integrated groups of these basic elements, assembled together during the animal's interactions with the world, form higher-level units of behaviour, and this process of hierarchical grouping can continue to arbitrary complexity, though in practice it may be limited by the available mental capacity. The repertoire of the individual therefore consists of all the lowest-level elements plus the already-assembled, higher-level groups of elements, because each of these behavioural complexes functions as a single unit once it has been learned. Novelty is found in those patterns of behavioural units (including basic elements and already-integrated groups of elements) that are assembled for the first time. In linguistics, it is common for the multiple levels of patterning in speech – distinctive features, phonemes, morphemes, words, sentences – to enable a discrete, and indeed quite small, set of features in speech to encode an almost infinite range of utterances. The mechanism of this “productivity” in speech lies in the hierarchical structuring of groups of elements, in novel orderings and circumstances. Following Lashley (1951), we suggest that the same applies to skilled action.

In a hierarchical system, the way in which the process of learning new skills can be aided by imitation similarly becomes a less straightforward matter. With hierarchically structured behaviour, there exists a range of possibilities for how imitation might take place, beyond the simple dichotomy of “imitation” versus “no imitation.” Imitation allows the assembly of novel sequences of units by observation, but, given the possibility of several degrees of hierarchical embedding, imitation might occur at many different levels, with radically different consequences for what we would observe. Table 1 depicts in words a number of possible levels at which the gorilla skill of processing bedstraw might be copied. At one extreme, the resulting behaviour would be indistinguishable from goal emulation: bedstraw is chosen as a goal, after watching another indi-

vidual eating it. At the other extreme, comparative psychologists would be confident that imitation, in Tomasello's (1990) sense of “impersonation,” was occurring throughout, because the details of manual style, hand preference, and idiosyncratic movements would closely match in the behaviour of model and observer. The emphasis on rather exact duplication of the detail of behaviour is an inevitable result of comparative psychologists' use of simple, nonhierarchical actions in their experiments (Custance et al. 1995; Heyes & Dawson 1990; Tomasello et al. 1987; Whiten & Custance 1996). It is also possible, however, that the overall form might be imitated, but the fine detail acquired by trial and error. This would result in a striking match of behaviour at coarse levels of description (i.e., higher hierarchical levels), contrasting with nonmatching actions at fine levels of detail. Or, some subroutines might be imitated within an overall form that is independently constructed. Thus, imitation operating at different hierarchical levels would produce distinctively different patterns of behavioural similarity and difference at different levels of analysis. What pattern do gorillas show?

**2.4. Program level and action level imitation.** Beginning at the bottom of the hierarchy, there are two reasons to think that the precise details of the manual actions and individual uses are learned without imitation. At a fine-grained level of description, where each element of behaviour is distinguished by an exact hand configuration and movement pattern, each animal was found to have a different preferred set of functionally equivalent variants (Byrne & Byrne 1993). This striking idiosyncrasy is a hallmark of trial-and-error acquisition. Moving up to a slightly coarser level, at which minor style differences are ignored but left- and right-handed forms remain distinct, the pattern of hand preferences (which are very strong in every animal) can be used to trace any copying. Because only the mother or the male leader are potential models, if this level of detail were

Table 1. *Levels of imitation*<sup>a</sup>

<b>Impersonation</b>	<p>Pick out a strand of green galium from the mass with any precision grip of the left hand and transfer the hold to a power grip by the other fingers of this hand, then repeat this cycle while still holding the picked strands in a power grip of the other fingers of the left hand, until the bundle is sufficiently large. Then fold in any loose strands by using the right hand to bend in any loose strands while loosening and regripping the mass of stems in the left hand, or, if this is easier at the time, by letting go with the finger and thumb of the left hand so that the bundle is held only by other fingers, then rocking the hand to allow grasping of both loose and gripped strands by finger and thumb again, then repeat this process so that the other fingers grasp the bundle firmly, and repeat the whole cycle until all strands are held. Then grip the bundle of galium loosely with the left hand half-open, pick out any debris with a pad-to-pad precision grip of the first finger and thumb of the right hand. Then grip the bundle tightly with the left hand and eat by feeding into the mouth until full, then shear off the rest by a molar bite, repeating when mouth empty again.</p> <p>Pick out a strand of green galium from the mass, then repeat this while still holding already picked strands until the bundle is sufficiently large. Then fold in any loose strands with the other hand (or with a rocking motion of the hand holding the bundle with repeated letting go and regripping of strands if this is easier at the time). Then grip the bundle of galium loosely with the hand half open, pick out debris with the first finger and thumb of the other hand. Then grip tightly and eat with shearing bites.</p>
<b>Program level</b>	<p>Repeatedly pick green strands of galium with one hand, then use the other hand to fold in loose strands, then hold the bundle loosely with one hand and remove debris with the other hand, then eat.</p> <p>Pick a bundle of galium, tidy it up, remove debris from it, then eat.</p>
<b>Goal emulation</b>	Eat galium.

<sup>a</sup>Described in words, some hypothetical levels of detail at which galium preparation technique might be represented. Some levels are identified with the terms that would be used to describe copying at that level.

learned by imitation, hand preferences would strongly tend to run “in families.” The hand preference of an offspring would correlate either with that of the mother or that of the silverback male. In fact, they correlated with neither: their distribution was just what one would expect by chance (Byrne & Byrne 1991). At these low levels, there seems to be no need to invoke imitation as an explanation.

A very different pattern emerges when we move up to the level of overall form of the process. Once sets of low-level elements, each member of which achieves the same function, are lumped into classes, the variability of technique largely vanishes. At this level, instead of idiosyncrasy, the sequence of actions is a rather fixed one, and in every animal, the organisation of each technique is essentially the same (Byrne & Byrne 1993). Even when treating right- and left-handed versions of the exact same sequence of acts as “different,” animals were 70–80% reliant on just one technique for each species of plant. Given the very large number of possible sequences in which the 6–10 different sub-processes could be combined, this standardization is remarkable, and contrasts strikingly with the variability we found among element repertoires. Of course, many of the sequences that are theoretically possible do not succeed in processing the food, but plenty do. Even the very simplest technique, structurally unrelated to the adult gorilla’s method (picking off nettle leaves, one by one, and eating each leaf blade while holding the stalk), allows feeding, albeit slowly. Environmental influences can mould regularity from trial-and-error learning, and some of the more “absurd” sequences of actions could quickly be rejected. It is highly implausible, however, that the constraints of the environment would be so tight that every animal would end up with the same hierarchical structure, yet so weak that the fine details of the techniques are highly variable between individuals. It would be convenient if there just happened to exist, distributed among the gorilla population, two or more equally efficient techniques for processing a plant; we could then observe if techniques, unlike laterality and details of hand configuration, ran in families. However, this situation is unlikely in any natural ecosystem (in fact, we believe it to be unknown), and the harsh montane environment of these gorillas would exact a heavy toll for feeding inefficiency. As it stands, the sharp difference between individual variation at one level of organisation and group consistency at a higher level, in a learned behaviour pattern, leads us to suggest that gorillas may indeed be able to imitate at intermediate hierarchical levels, effectively copying structural organisation but not minor details: a kind of observational learning one of us has described as “program level imitation” (Byrne 1993; 1994). Learning by individual experience is not completely disproven by these data, but it becomes a contrived alternative.

Program level imitation may be defined as copying the structural organisation of a complex process (including the sequence of stages, subroutine structure, and bimanual coordination), by observation of the behaviour of another individual, while furnishing the exact details of actions by individual learning. We refer to this as the “program” of behaviour because it makes up a recipe for coordinating and scheduling acts, and when it is enacted some result is produced by the individual. Imitation at the program level, then, would consist of copying a novel arrangement. By observation of an individual that already possesses a certain program, the observer, using elements already in its reper-

toire, learns to replicate the sequential regularity and coordination of elements and any subroutines and loops in the flow of control (Byrne 1994; Byrne & Byrne 1991; 1993).

The process by which program level imitation might be achieved is not necessarily a mysterious one. In the mountain gorillas’ plant processing techniques, the crucial subgoals are visible (by their results) in the sequence of action. These states necessarily recur in every effective sequence, whereas the irrelevant details of precisely how each of these states is achieved will vary between occasions without affecting efficiency (see Fig. 5). Thus, an individual observing a skilled model would be in a position to identify not only the final result to aim for, but also the appropriate subgoals along the way. The detail of how each subgoal is met can be acquired by individual learning, a process that may in this instance be much more efficient than the imitation of all the movements themselves. To imitate in this way, the individual must have mental apparatus that allows hierarchical frameworks to be assembled, to organize this goal structure, and to hold the goal structure while its detailed enactment is built up. Novel frameworks could also be assembled on the basis of trial-and-error exploration, and no doubt in simple cases this is quite sufficient; but imitation confers benefit in boosting the rate of acquisition – important where long sequences produce “combinatorial explosion” – or introducing features unlikely to be invented independently.

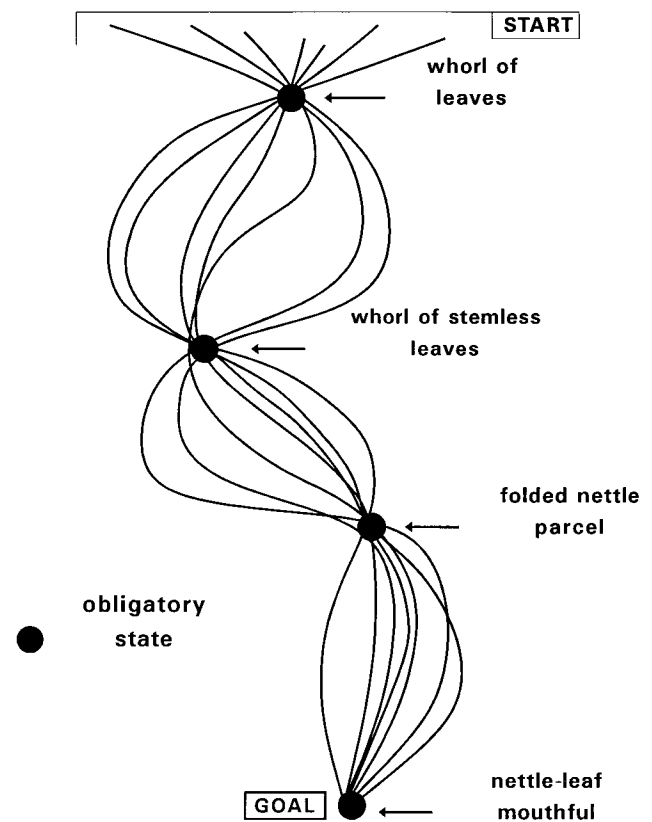

Figure 5. *State-space representation of nettle preparation.* Visualization of the possible range of states to which a nettle plant can be changed by manual processing, as a 2D surface. Actual processing sequences are seen as “paths” from the top line (unaltered plants, of various forms) to the single ultimate goal of a ready-to-eat handful (bottom). States (plant configurations) through which any successful sequence must pass are highlighted.

The results expected from program level imitation are quite different from those sought by comparative psychologists as evidence of “true imitation” or “impersonation,” in which a novel action is added – as an unmodified whole – to an individual’s motor repertoire (Tomasello 1990; Whiten & Ham 1992). The hallmark of this sort of imitation is that style and minor details should match between mimic and model; for consistency, we call this action level imitation. Because (almost) no theorist would wish to restrict “imitation” to the observational copying of single muscle twitches, it might be argued that the only possible (detectable) imitation is program level imitation (e.g., Whiten et al. 1996). This is an empirical question, however. Action level imitation might occur, for example, by a process of kinesthetic-visual matching, in conjunction with cognitively simple (associationist or sensorimotor) processes, as envisaged by Mitchell (1993, championing an idea originally proposed by Guillaume 1926). This could certainly copy a sequence of acts, each of which organizes a complex sequence of muscle twitches, but the contributions of action level imitation would remain entirely linear in structure. Imitation at the program level necessarily implies an intelligent ability to operate with task structure and hierarchical organisation of behaviour. Lacking this organisation, action level imitation might be parodied as the sort of imitation a video recorder is good at: exact duplication of details and stylistic quirks, but without any implicit understanding of organisation.

We suggest that the everyday use of “imitation,” and the sense often used in traditional developmental psychology, are closer to program level imitation. Consider, for example, the imitation described by Bauer and Mandler (1989) when they studied 16-month-old children’s copies of adults’ sequences of action. They found that the children required less observation and were more accurate if the sequences were of actions that were causally related, such as the steps in bathing a teddy bear. Any actions unrelated to the job at hand tended to be missed in the children’s imitations. Although the individual elements of action are unlikely to have been new for the children, the task’s structural organisation – not simply an ordered string of actions – was copied, characteristic of program level imitation (see also Abravanel & Gingold 1985).

In section 3, we will consider whether humans make much use of action level imitation, and if so, for what purpose. Wood (1989), who introduced the term “impersonation,” noted that some children go on to become stage impersonators or actors in adult life, implying that the faculty of action level imitation has a limited usefulness. Nor is the empirical discrimination between action level and program level imitation necessarily straightforward. When there are clear signs of idiosyncratic, individual learning at lower levels of organisation, as in our gorillas, action level imitation can be ruled out; but if this were less clear-cut, then the observable behaviour, whatever its true origin, might look a lot like the result of action level imitation.

Despite these reservations, many recent experimental and observational studies investigate whether animals imitate by focusing on the action level (impersonation). As we and others have amply charted, unequivocally establishing this fact is very difficult, because of the difficulties of excluding stimulus enhancement, response facilitation, and goal emulation as alternative explanations for putative cases of imitation.

The problem becomes more, not less, tractable when species with very flexible action repertoires are considered, such as the great apes. Indeed, the whole concept of an action “repertoire” may be inappropriate for these species, implying as it does a fixed and enunciable list of discrete actions. As humans, we accept that folding, twisting, pulling apart, and squeezing together are “single actions,” but each is composed of more elementary motor movements programmed together to achieve their results. In turn, the integrated behavioural complexes of pulling-apart-while-twisting, and squeezing-together-while-twisting, once they are acquired (perhaps by trial and error), will function as single units of behaviour in the future. It is perhaps no coincidence that few ethological studies of great apes, unlike those of cockroaches or salmon, have considered the species’ repertoire – its “ethogram” – as a useful research tool. Finite repertoires of basic, natural units of behaviour are not obvious to observers of apes, presumably because almost all combinations of movements occasionally occur together in spontaneous behaviour. In addition, behavioural mechanisms other than trial-and-error learning and imitation may augment an individual’s repertoire. For instance, play with companions or with objects may function to build up a range of routines that achieve specific results. In play, by definition, the results themselves have no biological function, but once a relation between some behavioural sequence and its result is noticed, this new routine may in the future be elicited in genuine problem solving. Because every individual is liable to have had a different history of play experiences, in principle it is probably impossible to describe “repertoires” in species that learn in this way. This makes identification of “new” behaviour very difficult, and detection of imitation consequently less likely.

The good news is that, if we move instead to a higher level of organisation in the hierarchy of behaviour, then “novelty” actually becomes easier to define. In lengthy sequences of behaviour, the probability of replicating a demonstrated arrangement by chance or independent invention quickly diminishes. We would argue that the important novelty in animal or human behaviour usually consists in novel rearrangements of elements that are themselves not novel. Our principal aim in section 2.6 will be to focus on this sort of imitation as it functions within the process of hierarchy construction. Examples of imitation employed in the process of constructing novel behaviour – as opposed to the final products shown in the well-coordinated routines of the mountain gorillas – will be seen in orangutan behaviour. As preparation, we turn to cognitive-developmental psychology for insights into the acquisition of novel, complex behaviour.

**2.5. Assembling programs by relational learning.** The importance of structure has long been recognized in cognitive-developmental psychology. There, following Piaget (e.g., 1937/1954), complex behaviour is seen as constructed, by combining and coordinating low-level components (e.g., mental, perceptual, or motor schemes) into novel sequences. Such a sequence may become integrated or fused, so it can operate as a unified “routine”; then it can in turn be used as a component, a subroutine, in building higher level complexes (see Case 1985; Gibson 1990; 1993; Greenfield 1991; Langer 1993). It is important that the coordination and integration of components into higher level routines implies flexible modification of individual compo-

nents: components must be adjustable to coordinate effectively with one another.

Hierarchical processes are thought to underlay the emergence of symbolic abilities in children, and simple physical relationships between objects, like in-ness, on-ness, between-ness, or together-ness, are often found to lie at the core of this early hierarchical behaviour. Young children between about 1½ and 5 years of age have been found capable of resolving problems by analyzing them in terms of the object-object relationships involved, and generating goals and routines that manipulate these relationships (e.g., Case 1985). They play with “in-ness,” for example, by repeatedly putting objects in, then out of, containers. From about their third year, they generate behavioural complexes that combine and coordinate several relational routines together (e.g., Case 1985; Greenfield 1991; Langer 1996). These coordinated routines show the features of hierarchically organized behaviour, making them simple examples of behavioural programs (Case 1985; Langer 1996). (And a number of researchers have suggested that discovering a new way to manipulate a relationship is what nonhuman primates acquire when they learn imitatively: Russon & Galdikas 1995; Russon et al. 1998; Visalberghi & Fragaszy 1990.)

Though this approach derives from child psychology, there is reason to expect it to apply to great apes as well. Great apes and humans show very similar patterns in their early cognitive development (e.g., Gibson 1990; 1993; Greenfield 1991; Parker & Gibson 1991); even as juveniles, they can achieve logical and causal reasoning skills beyond sensorimotor levels (e.g., Langer 1993; 1996; Spinozzi 1993). In adult chimpanzees, Boysen (1993; 1996) has shown numerical abilities approaching that of 3- and 4-year-old-children, including counting, summation, and subtraction. Matsuzawa (1994) found that some adult wild chimpanzees who used stone hammers and anvils to crack open hard nuts also added a third stone as a wedge to level their anvil rocks; human children he tested did not master this strategy until they were 6 to 7 years old. At 3 to 4 years of age, children are already beyond the developmental threshold at which hierarchical organisation of routines appears (Langer 1996).

We argue here that young great apes do in fact structure their learned behaviour in ways very similar to young children. Cognitive developmental psychology points to several diagnostics of hierarchical organisation in behaviour, some of which we have already illustrated in gorilla food preparation and used to argue for their hierarchical organisation: the iterative repetition of subroutines, and the capacity to handle optional operations interrupting the main process. Others we shall see in section 2.6 include self-correction of parts of routines to meet predefined criteria and substitution of functionally equivalent components. Child psychology points to object-object relations as one underlying basis of hierarchically organized behaviour; we turn now to orangutans to illustrate the object-object relations that underlie the construction of novel behavioural programs in great apes, and the use of imitation in this process.

**2.6. Case study: Relational learning in orangutan imitation.** Rehabilitant orangutans in Tanjung Puting National Park (Central Kalimantan, Indonesia) have provided some of the most complex examples of great ape behaviour acquired, in part, by imitation (Russon 1996; Russon & Galdikas 1993). These orangutans copied many unusual

and standardized behavioural techniques used in the camp, including techniques for siphoning fuel from a drum into a jerrican, sweeping and weeding paths, mixing ingredients for pancakes, tying up hammocks and riding in them, and washing dishes or laundry. In some cases, their goals were clearly those of the humans; in others, copying the behaviour for its own sake was apparently intended. Most of the incidents showing imitation entailed organizing many individual actions in an elaborate way. In most cases, the essence of their imitation was not specific motor actions, but rather the organisation of sets of actions into larger programs. Many of these programs incorporated manipulations of relations between objects, like pouring liquid into a container, threading rope through a ring, untying a knot, sweeping a path with a broom, or fanning a fire with a lid (Russon & Galdikas 1995).

To support a broad understanding of these orangutans' imitations, we looked at a larger data set of their spontaneous manipulations of object-object relations (700 incidents, from 700 hours of systematic observation in 1990 and 1991). Some were organized as integrated, higher order programs, showing: (1) flexibility in component objects and actions (e.g., orangutans could pour water into a soda bottle, kerosene into a cup, or sand into a bag; and pouring could be done holding lip, base, or handle of a cup); (2) subordination of components to higher level goals (e.g., pouring rate was modulated to control the transfer of the substance); (3) iteration to criterion (e.g., one orangutan copied the camp technique for getting water out of a floating dugout canoe, repeatedly rocking it so that the water sloshed out; she paused periodically to inspect the water levels, then resumed rocking, and stopped finally only when almost all of the water was removed); (4) self-correction (e.g., handed a pen upside down, the orangutans would rotate it as soon as they noticed it would not write); and (5) interruption management (e.g., one managed to pour insect repellent from a bottle onto her hand while simultaneously warding off her son and daughter as they tried to butt in). This suggests that orangutans have a clear functional understanding of some object-object relations. We have not yet developed an exhaustive list of the physical relations these orangutans understand, but some of the common ones they have manipulated in this integrated manner include: in-out (e.g., absorb by immerse, soak, and squeeze, embed by implant or scrape out, contain by pour in and scoop out, and enclose by wrap-unwrap and loosen-tighten); on-off (e.g., support something on a rigid or floating base, cover by putting lid on or off); together (e.g., join, mix, gather up, pile, tie-untie); contact (e.g., touch, lean, poke, wipe, chop, hammer); and through (e.g., thread, weave). Not all the orangutans showed the ability to create programs manipulating all these relations; presumably, differences were a function of their varied histories.

The orangutans regularly embedded simple programs for manipulating relations within larger behavioural programs, showing how an individual's repertoire of relational programs can serve as the basis for complex behaviour. The adult female Supinah, for example, used a “pouring” program, imitated from humans, several times as a subroutine within her elaborate imitation of the local behavioural strategy for making fire. She poured kerosene from a large can into a cup, poured it from the cup into the original can, poured it from the cup onto a stick, and poured it from the cup onto the fire's embers. Sometimes she poured with two

hands, sometimes with one. Another imitated subset of her repertoire consisted of elaborations of two relational programs, scraping or rubbing one object across another, and wetting objects in liquids. She organized these as subroutines along with a variety of actions and objects into many novel programs. This part of her behavioural “kit” probably allowed her to copy more complex behavioural programs, including sharpening axe blades, reshaping a blowgun dart, washing clothes and floors, sawing wood, sweeping paths, and painting walls (for detailed discussions, see Russon & Galdikas 1995). Other orangutans also made use of these particular programs as subroutines. One copied a technique for removing bark from a branch by tool-assisted scraping, and another incorporated both rubbing and wetting within her reproduction of the whole ritual tooth brushing program used by (human) camp visitors.

Although imitation of relational manipulations themselves constitutes a simple form of program level imitation, some of our cases were considerably more complex. We offer three examples to suggest the heights of hierarchical complexity these orangutans achieved and the varied levels at which their imitation could occur. Our goal here is to highlight the hierarchical structure of behavioural routines in which imitation was used rather than to repeat arguments for the presence of imitation itself, which are detailed in Russon and Galdikas (1993). The two most complex examples are also represented diagrammatically, in an effort to clarify their organisation. Diagrams represent the behavioural sequence observed, along with its inferred organisation and the orangutan’s probable goal and behavioural strategy. For brevity – these incidents involved 15 to 20 minutes of continuous activity – we describe sequences at the level of manipulations of relations between objects rather than that of the individual motor actions.

**Example 1: Supinah steals soap and laundry by canoe** (See Fig. 6). The bottom line of the figure shows the behavioural sequence observed. Those relational manipulations that were identified as integrated programs for Supinah are underlined and shown in boxes to indicate their operation as behavioural units. Shown on upper levels of the figure is the organisation of her behavioural sequence inferred from the description (Russon & Galdikas 1993). In the figure, behavioural units are joined upwards by lines to the immediately superordinate program. Supinah’s overall program and her goal, again inferred, appear at the topmost level of the figure. The organisation of the incident is most apparent reading from the highest level (top), down.

Supinah’s goal appeared to be using the soap and laundry possessed by camp staff, who were washing laundry on a floating raft just off the end of the camp dock: this is what she achieved, she had worked to achieve this goal in the past, and her behaviour made sense only with this goal in mind. Although she could take the goods from the staff directly by intimidating them (they were afraid of her), they were protected by a guard stationed on the dock to block her access. Her overall strategy to get the soap and laundry required foiling the humans (Fig. level 1) and this entailed two different tactics: bypassing the guard, and then taking the goods from the staff (Fig. level 2). Bypassing the guard meant detouring around him, which meant travelling through water because the end part of the dock where Supinah lurked stood in knee-deep water. Below this part of the dock was a dugout canoe; these orangutans are well known for cruising down the river in pilfered canoes, but this one was moored and half full of water. Supinah dealt with this situation with two more subroutines: preparing the canoe for use, then riding it past the guard to the raft (Fig. level 4). Preparing the canoe had two

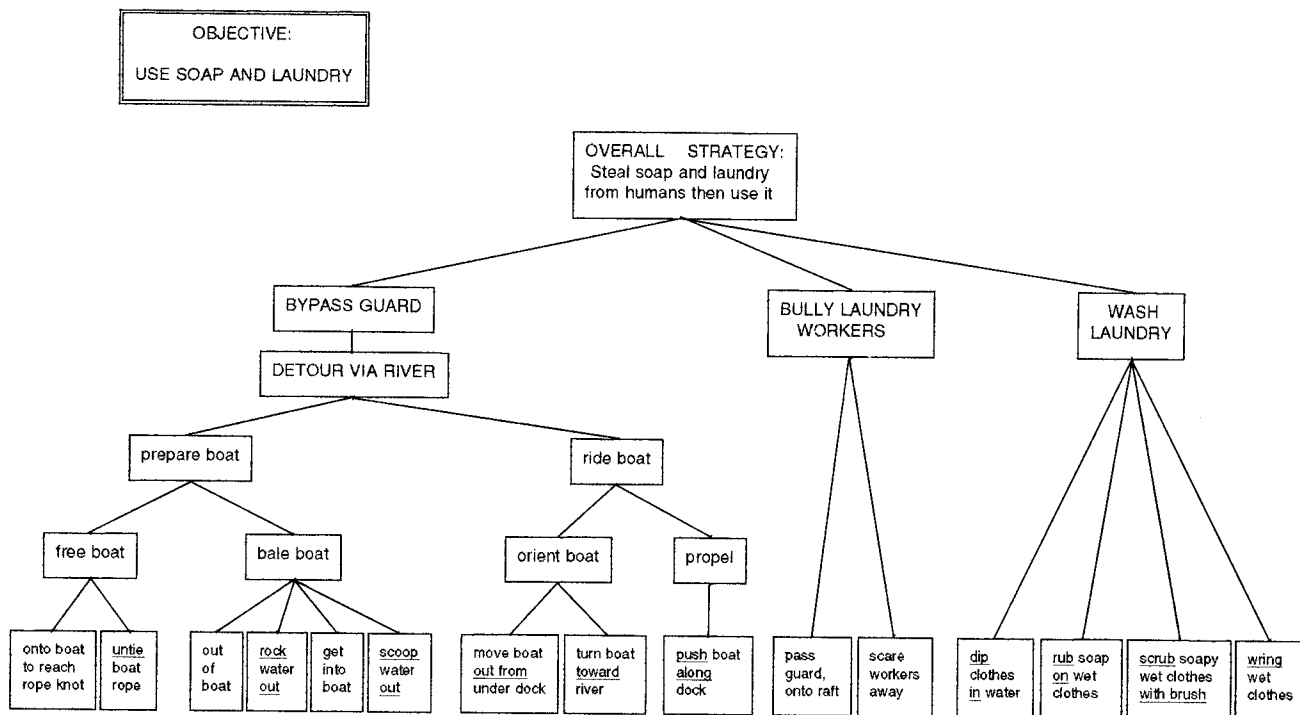

Figure 6. Goal hierarchy for stealing soap and laundry by canoe. (See text for explanation.)

subroutines: freeing it and bailing it out (Fig. level 5). Each involved several minutes of detailed manipulation and several relational manipulations, including untying a knot and two iterative techniques for removing water from the canoe (Fig. bottom level). Not shown in the figure is that Supinah interrupted her canoe preparation to climb back up the side of the dock and peek over its edge towards the guard; the guard was still there and she immediately climbed back down and resumed canoe preparation. Riding the canoe required reorienting it relative to the dock and the raft, then propelling it alongside the dock towards the raft (Fig. levels 5 and bottom). Taking soap and laundry from the staff was then easy: Supinah merely hopped onto the raft and the staff obligingly shrieked and jumped into the water, abandoning the soap and laundry. Supinah immediately set to work washing the clothes using most of the manipulations used in the overall washing technique standardized at the camp (e.g., rub soap on wet clothes or brush with soap, scrub clothes with brush, wring wet clothes).

The overall plan appears to have been a one-time, independent concoction, and motor actions were varied flexibly in accordance with immediate needs. Supinah appeared to have used imitation, however, for the relational manipulations she deployed, sometimes in organized packages. Most clearly, she copied a standard camp technique to remove water from a boat (by rocking the floating boat side to side on the water, thereby sloshing water out of the boat over its gunwales), and possibly also the component manipulations for the particular local technique of washing laundry as well, but not its organisation, because she performed the components in idiosyncratic order.

**Example 2. Weeding paths.** During one of the periodic bouts of cleanup around the camp, Mr. Mursiman, a long-time staff member, was cleaning paths by removing weeds that had grown along their edges. The standard technique used in the camp was to slice weeds off at ground level with a hoe, then toss the cuttings well back into the bush. In addition, Mr. Mursiman piled the cuttings into a straight row behind him along the centre of the path before disposing of them. He reported that Siswoyo, an adult female orangutan, had followed him, watched his weeding, then started weeding herself. Anne Russon arrived to find Siswoyo about 3 m behind Mr. Mursiman on the same path, also removing weeds from the side of the path and likewise piling the cuttings behind her in the path. She mostly chopped roughly at the weeds with a 5-m long stick, but she sometimes pulled them out by hand, and her row of cuttings was ragged rather than straight.

Siswoyo imitated Mursiman's overall weeding program (remove weeds until a section of path is clean, pile cuttings, move to a new section of weeds, then iterate this routine until the path is clean), but she may have acquired individual components independently. Both Mursiman's and Siswoyo's weed removal techniques incorporated two subroutines, tool-assisted weed removal and weed piling. Mursiman's weed removal technique required coordinating two object-object relations, hoe-chop weeds and hoe-shave ground (so as not to disturb the soil). Siswoyo's version of weed removal was less sophisticated, incorporating only one object-object relation (tool-chop weeds), and she substituted a stick for a hoe as her tool (Mursiman had the camp's only hoe). Mursiman's weed-piling technique coordinated two object-object relations (collect cuttings to-

gether, arrange cuttings in a straight row). Siswoyo's version of piling again involved manipulating only a single relationship, collect cuttings together. Siswoyo's weeding activity shows program level imitation in reproducing the hierarchical organisation of the whole activity. She also copied Mursiman's programs for clearing weeds and piling them, albeit in poorly differentiated versions. Lower levels of imitation were notably absent: for example, she substituted a stick for a hoe, and used pulling rather than a tool-based technique for removing weeds.

**Example 3. Fire-making.** This incident lasted some 20 minutes and entailed a wide range of manipulations on 12 objects of 7 types. Figure 7 diagrams the incident, using the same notation as Figure 6. The four physical elements central to Supinah's activities are indicated as H (heat), A (air), W (wood), and K (kerosene); two elements concatenated indicate a relationship existing independently of her manipulations (e.g., HW is hot wood, wood already burning) and two elements hyphenated indicate a relationship that Supinah created (e.g., H-W is wood Supinah tried to heat, for example by poking a stick into a fire).

Supinah's overall objective appeared to be making an active fire because, with skill, all the techniques she tried would have generated one. The elements available to her included embers of cooking fires, a large can of kerosene, a lid, a small plastic cup, and various sticks (some of them glowing hot). Her overall strategy seemed to be to combine heat, air, wood, and kerosene (Fig. top level). Supinah tried manipulating the relationships between these elements in three different patterns:

A-HW (blow air on hot wood)

K-HW (combine kerosene with hot wood)

A-W-K (blow air on wood after immersing it in kerosene)

We classified each of these three relational manipulations as integrated units, or small "programs," because she enacted each more than once, with variation. Her attempts were as follows (numbers indicate the sequential position of the relevant boxed descriptions on the bottom of Fig. 7, counting from left to right):

1. A-HW blow on burning tip of stick (6 blows).
4. HW-K immerse hot stick in cup of kerosene (twice, changing the kerosene between attempts).
5. KW-HW touch kerosene-soaked stick to hot stick.
8. A-W-K fan with lid over stick she had immersed in cup of kerosene.
9. A-KW blow on tip of kerosene-soaked stick.
10. K-HW pour cup of kerosene on burning embers.
13. K-HW dip stick in cup of kerosene, drip kerosene on burning embers.
14. K-HW pour kerosene on stick, drip kerosene on burning embers.

It is perhaps significant that Supinah managed to combine three but not all four of the elements needed to make an active fire, perhaps reflecting a working memory constraint to the level of hierarchical complexity that can be achieved by a great ape.

Despite failure to execute the entire program of fire-making effectively, Supinah's attempts show use of imitation in several ways. She probably imitated the overall strategy for making a fire, in the sense of "combine these four elements," although her version of this strategy was imprecise and inaccurate. Most clearly, she imitated several of the component techniques, each of which represents a smaller

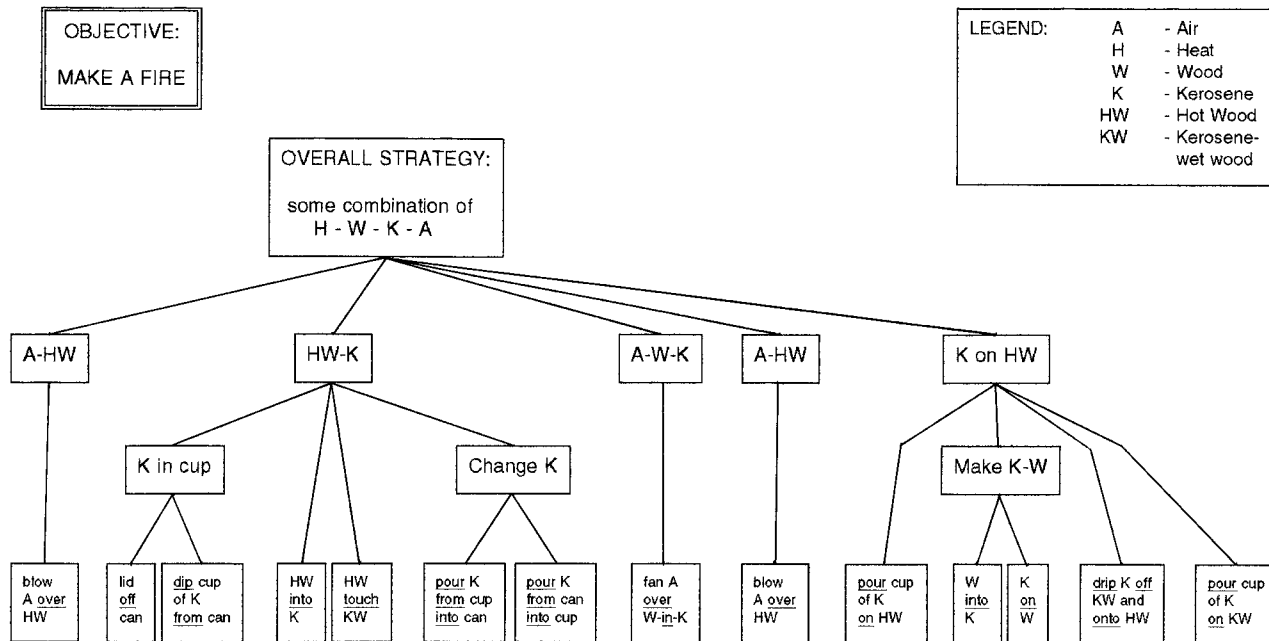

Figure 7. Goal hierarchy for illicit fire-making. (See text for explanation.)

program used as a subroutine, especially scooping a cup of kerosene from the can for use in starting a fire, wetting wood with kerosene before attempting to light it, and fanning a would-be fire with a particular lid. There are also signs that she made limited use of action level imitation. For example, Supinah's fanning with a lid copied the specific motor technique used by camp cooks when they fanned with this same lid for this same purpose.

These examples have been chosen to show how orangutans use imitation. Under other circumstances, however, orangutans, like humans, may well fail to show imitation: the situational context, the level of skill "gap" between model and observer (Parker 1996; Vygotsky 1962), and many other considerations may be influential. For example, when tested with a device with an internal operation that was opaque, but which could be set to deliver a reward when a handle was moved in a particular way, no imitation of a human model was found (Call & Tomasello 1995). It is interesting that one of the subject animals in this experiment was a home-reared orangutan, Chantek, that has often shown an ability to imitate arbitrary human actions (Miles et al. 1996). Just such action level imitation would have been efficient for Call and Tomasello's opaque task. In section 3, we will argue that action level imitation may have evolved for functions other than skill-learning, which could help explain why it is not easily recruited for skill acquisition.

**2.7. Emulation of relationships or program level imitation?** It would be strange if chimpanzees lacked abilities found in gorillas, orangutans, and humans – their closest relatives. We believe that imitation may have been overlooked in chimpanzee studies, in light of our distinction between program level and action level imitation. In particular, the "emulation" that Tomasello and his colleagues elicited in their experiments on imitation in chimpanzees (Call & Tomasello 1994; Nagell et al. 1993; Tomasello et al. 1987) can be understood as program level imitation. Recall,

they had seen demonstrators get out-of-reach food with a rake tool. In the first experiment, a demonstrator used a two-stage technique with a metal T-bar rake to get food against a wall, reaching the rake beyond the food and then dragging the food in. In later experiments the demonstrator used a more standard rake with widely spaced tines but with the rake head on its back edge; in one condition, the demonstrator even showed subjects how to flip the rake from its tines onto its edge. Chimpanzees that observed these demonstrations did use the rake to bring the food within reach, but they did not imitate important details of the technique demonstrated.

Tomasello rejected this behaviour as imitation, the observational learning of behavioural strategies, and attributed it instead to emulation, the observational learning of the result or goal that a demonstrator is seen to achieve (Tomasello 1990, citing Wood 1989). However, what the chimpanzees copied was not so much a result – "food-in-hand" – as a usage – "rake-as-tool" – apparently learning about the functional relationship between tool and food. We stress the relationship because the task was a tool task and tools are in essence relational: "tool" rightfully refers to objects only in terms of the particular types of relations they enter into with other objects, when they mediate attaining external goals (Beck 1980; Reynolds 1982). Flexible tool use requires the ability to manipulate physical causal relations in a generalized manner (e.g., Parker & Gibson 1977), and the ability to imitate tool-using tasks requires understanding the causal relations involved (e.g., Kohler 1925/1976; Piaget 1937/1954; Visalberghi & Fragaszy 1990; Visalberghi & Limongelli 1996).

If great ape subjects learned something about the rake-as-tool by watching, what they learned was de facto relational. Using what has been learned about the rake-food relationship necessarily entails translating this relational learning into a behavioural strategy to bring about the goal, food-within-reach, by manipulating the relationship between tool and food. In addition, the behavioural strategy

that the chimpanzees used was basically the same as the strategy that was demonstrated. Whereas great apes trying to solve rake problems independently have been observed using throwing, tapping, and poking among other idiosyncratic relational manipulations (Parker 1969), here they specifically enacted raking, and they raked with the head end rather than the handle. Thus their raking behaviour *does* match the behavioural strategy demonstrated, but at the program level rather than the action level. Chimpanzee performance on these tasks may be better captured by our concept of program level imitation than by the concept of emulation. We do not doubt that chimpanzees sometimes learn the affordances of objects by observation (although we do not see how this learning is cognitively less complex than imitation); however, in this case it seems an unlikely explanation. What we would have to assume is that the chimpanzees already knew about raking (the relational manipulation), but did not know that a stick is a suitable rake (the tool), and this is what they learned by watching successful performance. No evidence of this prior ignorance is presented, and it seems improbable: What else might they have been used to raking with, if not sticks?

Examination of the techniques chimpanzees used shows that their programs of behaviour were hierarchically constructed. Their raking in the first experiment was described as simple “sweeping” motions with the T-bar rake (Tomasello et al. 1987). To be effective, however, even sweeping must operate as a relational routine, not a simple action, because it must establish a relationship of hooking behind the food, then maintain the hooked food-rake relationship throughout the sweeping arc of movement. In the process, the position of the food changes continuously, so sweeping must be modulated or corrected to track this effectively. In the other two experiments with a standard rake, effective raking requires positioning the rake head beyond the food and then dragging it in (and “beyond” is itself a relational state). Once correctly positioned, the rake’s position relative to the food must be continually modulated to effect dragging. Several chimpanzee subjects succeeded in obtaining the food by dragging with the rake’s tines rather than its edge, a very touchy relational balancing act requiring exquisite modulation to keep the food from slipping out between the tines. When food did slip, as it usually did (Call, personal communication; Nagell et al. 1993), corrective measures must have been taken. The simplest correction is iterative, repositioning the rake beyond the food, then resuming dragging. These characteristics – incorporating integrated relational routines as subroutines, self-correction, iteration to predefined criteria, and substitution of functionally equivalent components (e.g., rake flipped over, or on its tines) – all show that the chimpanzees were using hierarchically structured behavioural strategies when they manipulated the rake–food relationship, not simple actions.

We accordingly conclude that these chimpanzees did imitate the program demonstrated, although they did so at a coarse level of description. That they did not mimic some of the details demonstrated is not necessarily a sign of general cognitive weakness, but shows that program level imitation begins at higher hierarchical levels. And because the chimpanzees often succeeded, the pressure to overhaul their strategies by copying demonstrated details may have been absent under the artificial conditions of captivity and the constraints imposed by experimentation. (Compare the case of mountain gorillas, huge animals existing only on

plant nutrients in a cold environment: they have considerably more to lose from retaining inefficient routines.) We conclude that chimpanzees, even without home-rearing or experience with sign languages, probably imitate in ways similar to orangutans and gorillas. Because this imitation is typically at program level whereas researchers have sought evidence of action level imitation, and because the frequency and extent to which chimpanzees imitate at this lower level is very limited (see Custance & Bard 1994), their imitative capacity has seemed equivocal.

### 3. Discussion and conclusions

We began this assessment of imitation in nonhumans in the conventional way, attempting to sort the wheat of cognitively complex behaviour from the chaff that can be explained by simpler mechanisms. We argued that most of the cases currently claimed to be animal imitation should be rejected in favour of one of these simpler explanations, response facilitation, and that, conversely, some great ape copying that has been discounted as emulation may warrant reevaluation as imitation. With these restrictions, we concluded that several of the “simple” processes that guide social learning (stimulus enhancement, response facilitation, and goal emulation) can be computationally described by a single mechanism, priming of brain records. Aside from the obvious parsimony, this should help to highlight genuine cognitive complexity where it is found.

We then attempted to show that great ape imitation is hierarchically organized, using evidence from gorillas, orangutans, and chimpanzees. When behaviour is viewed hierarchically, imitation is a high-level constructional ability; it is not a “special faculty,” but one expression of the more general ability to construct hierarchical cognitive structures. Imitation, therefore, is generally found embedded within the whole process of constructing novel behavioural strategies, at various hierarchical levels. Equally, imitation typically will not be isolated from simpler processes, such as instrumental or associative mechanisms, but will occur in conjunction with them. Failure to recognize these facts has led to a failure to recognize imitation in great apes.

Hierarchical organisation is pervasive in the nervous system, and has long been believed to apply to the coding of behaviour. Using the skilled food-gathering techniques of mountain gorillas as an illustrative example, we argued that – more than this – at least in the great apes, behaviour is organized hierarchically, not simply at genetic and physiological levels, but in a way that is available to learning mechanisms under voluntary control. The hierarchical structure is made up of integrated complexes of elements, including relational combinations, generated recursively. Cognitive developmental psychologists have informed the analysis of hierarchically structured voluntary behaviour in humans; they, too, have found the application of such analyses to nonhuman primates to be fruitful (Gibson 1993; Langer 1993; 1996; Parker & Gibson 1990; and Mitchell 1987, whose description of “Level 4 imitation” has elements in common with our analysis).

This view of hierarchically structured animal behaviour under voluntary control has implications for imitation. In particular, it suggests that imitation can in principle occur at many levels. For heuristic purposes, we distinguish action level imitation (imitation of basic elements of behaviour, singly or in sequential strings) from program level im-



itation (imitation of the organisational structure at any higher level, from single relational manipulations to the overarching program). At the program level, the matching that indicates imitation will be found not in motor action details, but in their arrangement within functional programs. These can range from the program representing the overall strategy for behaviour, to programs representing any of its constituents. However, not even action level imitation can involve copying of single muscle twitches: motor organisation must be copied. Potentially, then, action level imitation might be interpreted as one end of a continuum with program level imitation at the other, varying only in the level at which organisation is copied. Be that as it may, the evidence of imitation in humans (see below) and great apes fits rather neatly into the two discrete categories, with little sign of intermediates at present. The distinction may be more than heuristic, and two distinct mechanisms may be involved.

In addition to the highly practised routines of gorillas that are essential to their survival and show signs of earlier acquisition by program level imitation, we offered cases of complex, goal-directed behaviour in free-ranging captive orangutans to illustrate the use of program level and action level imitation in the service of constructing new procedures. For both species, we found suggestions of limits to the hierarchical complexity that a great ape can handle mentally. Nevertheless, our interpretation is that mountain gorillas and orangutans can imitate at the program level. Finding it hard to believe that chimpanzees should lack an ability found in their close relatives, we reexamined data previously interpreted as a sort of emulation, in which knowledge of relationships is acquired by observation. We argue that these data are better seen as signs of program level imitation, albeit at coarse levels of detail and lacking complexity, and suggest, therefore, that all great apes can and do imitate at the program level. Although none of our data are by any means perfect, they are the best that is presently available; our current research is aimed at gaining developmental perspective on the gorilla and orangutan behaviour we describe.

It is likely that great apes also can imitate at the action level, but the importance of this for survival is more questionable. Great apes have repeatedly shown us that fine details of motor behaviour can be efficiently acquired by trial-and-error learning. Action level imitation of these details from other individuals, although able to produce convincing mimicry, may be an inefficient way of acquiring new abilities. By contrast, inefficient program organisation would be tedious and sometimes impossible to "debug" by trial and error, and the organisational structure of behaviour can often be seen readily in its intermediate steps. Program level imitation makes ergonomic sense. From this perspective, it follows that imitation serving the acquisition of instrumental behaviour does not commonly operate independently, in isolation from other learning processes. Indeed it may not be designed to do so. This type of imitation builds on existing behaviour structures, and it relies on other processes like individual learning for efficiency and attunement to specific environmental contingencies. Perhaps we should reexamine how we formulate our search for "pure" imitation, imitation unadulterated by other learning processes, a conundrum that has frustrated empirical research on imitation for almost a century.

We believe that program level imitation is the major con-

tributor to the acquisition of skilled instrumental behaviour even in humans, and that action level imitation plays a minor role. When children learn imitatively to tie shoelaces, play elaborate games, write, and draw, we suspect that they seldom copy idiosyncratic details of their teachers' actions, because they more often fill in such detail by individual learning. What they imitate is the efficient hierarchical organisation of actions, including bimanual coordinations and subroutine structure. Children's vocal imitation in acquiring speech might seem a flagrant exception to this generalization. However, recall that the supralaryngeal tract of a young child is much smaller and less mature than that of the adult whose words are imitated; the available frequency range and articulatory capacities are quite different, and indeed the frequencies of vowel formants and phonemic pronunciation are not replicated. Instead of physical matching of sounds, achieved so spectacularly by myna birds, the entire vowel register is shifted to a region of higher pitch. Children imitate spoken words at the program level, copying the organisations of phonemes that make up words, not the physical sounds. Action level imitation might contribute to skill learning, but it is perhaps more common as a way to retain poorly understood demonstrations in memory or to elicit further social exchange with the demonstrator than a way to learn new instrumental behaviour (e.g., Abravanel 1991; Moerk 1989; Russon 1996).

Completing our argument requires accounting for why action level imitation has been accepted as the prototype of imitation, although it is misleading to do so. There is little doubt that action level imitation does occur, even in great apes (Custance & Bard 1994; Hayes & Hayes 1952; Miles et al. 1996; Nagell et al. 1993; Tomasello et al. 1993) and exact behavioural copying is a prominent feature in human development. (We suspect, however, that action level imitation is less common in children than it seems, and that, often, children's "imitation" may reflect response facilitation.) Many developmental psychologists have argued that action level imitation serves a social function for children, facilitating, for example, the meshing of mother-infant behaviour and attachment, or the taking on of desired social roles by "impersonation" (Meltzoff & Gopnik 1993; Mitchell 1987; Nadel 1986; Russon & Galdikas 1995; Uzgiris 1981; Yando et al. 1978). And it has been pointed out that imitation can contribute to efficient social functioning, because standardization of form is valuable in communication (Boyd & Richerson 1988).

Perhaps, then, in great apes and humans alike, the main function of action level imitation is social. The impersonation of others' behaviour may be funny, or flattering, or an entry into a new societal role, but in all these cases, it is the look of the thing, not its effectiveness that matters. Yando et al. (1978) proposed dual functions for human imitation, and our work with great apes leads to a similar conclusion. If this interpretation is correct, action level and program level are not simply prominent modes in a continuum of levels of imitative copying, but are independent processes that have evolved in response to very different needs, and thus have a very different pattern of occurrence. This would be consistent with suggestions that they are subserved by very different mechanisms: kinesthetic-visual matching for action level imitation, but hierarchical plan construction for program level imitation.

We believe that our "hierarchical approach" to imitation accounts for the existing results on great ape imitation bet-

ter than alternative models, and helps explain the wildly discrepant views of those (mostly fieldworkers) who are sure that apes can imitate, and those (mostly laboratory workers) convinced that they cannot. In addition, it suggests new approaches to experimentation and to analysing subjects' responses:

1. Tasks should be constructed differently:

(a) If program level imitation is a process adapted to aid acquisition of complex, novel structures of behaviour, then it can only be studied with tasks having significant organisational components, a "program" that is worth copying. The logical relationships of components in the demonstrated routine need to be visible to the subjects, unlike the case in Call and Tomasello (1995), or else the task is reduced to an assay of "meaningless," action level imitation. So far, the closest experimental approach to this requirement is a sequence of two different actions, incorporated into the design of an "artificial fruit" (Whiten & Cusance 1996, p. 308). In fact, however, no sequence was demonstrated to chimpanzee subjects, and the "organisation" of two sequential actions was not sufficiently complex to make for unambiguous analysis of copying.

(b) If action level imitation is adapted to social function, special care must be devoted to the social circumstances that will evoke imitation.

(c) If both processes can sometimes be recruited to the same learning task (a view already foreshadowed by cognitive developmental research), appropriate tasks need to incorporate complexity at several levels.

(d) If program level imitation operates in conjunction with mental apparatus capable of allowing hierarchical programs to be assembled, and with individual trial-and-error learning, then it would be unreasonable to expect skills to be acquired entirely by imitation. Imitation will most likely be invoked in the face of difficulty, and to short-cut combinatorial complexity of possible sequences, not for trivial problems.

2. Analyses of potentially imitative behaviour need to partition the variance into hierarchical levels. Rates of copying actions, relational manipulations, and overall task organisation should be worked out separately. At the very least, reproduction of organisational structure must be separated from reproduction of motor details.

#### ACKNOWLEDGMENTS

We would like to thank Bob Mitchell, Juan-Carlos Gomez, and several anonymous referees for a great deal of help in improving earlier drafts of this paper. For support of the field work from which the ideas in the paper grew, we thank the National Geographic Society, the Carnegie Trust for the Universities of Scotland, and the Natural Sciences and Engineering Council of Canada. For permission and assistance for our work with the great apes, we thank the Dian Fossey Gorilla Fund, L'Office Rwandaise du Tourisme et Parcs Nationaux, the Indonesian Forestry Department and its Nature Protection Agency (PHPA), the Indonesian Institute of Sciences (LIPI), the Faculty of Biology at the Universitas Nasional, and B. Galdikas's Orangutan Research and Conservation/Project.

## Open Peer Commentary

*Commentary submitted by the qualified professional readership of this journal will be considered for publication in a later issue as Continuing Commentary on this article. Integrative overviews and syntheses are especially encouraged.*

### If it is inevitable, it need not be imitated

Patricia J. Bauer

*Institute of Child Development, University of Minnesota, Minneapolis, MI 55455-0345.*

[pbauer@maroon.tc.umn.edu](mailto:pbauer@maroon.tc.umn.edu)

**Abstract:** Byrne & Russon provide illustrative examples of imitative abilities in nonhuman primates. The convincing aspects of the examples are not, however, their hierarchical or structured nature: Such organization may be inevitable and hence, does not require explanation via imitation. Rather, examples of imitation are derived from reproduction of behaviors and sequences that, from the organism's perspective, are arbitrary.

My own conviction that humans are not alone in their capacity to imitate predates Byrne & Russon's (B&R's) argument. The target article contains examples that add to the body of observations on which that conviction is based. The best evidence, however, is not derived from where the authors instruct us to look. Rather, it is to be found in the bushes around the light post to which they point.

B&R argue that convincing evidence of imitation in nonhuman primates is relatively meager because we tend to test apes on simple actions, the apparent imitation of which can be explained by other processes (e.g., emulation). B&R suggest that we look instead to production of hierarchically structured behavioral sequences that are unlikely to be acquired via individual learning or to be innate (in any strong sense). Thus, a process of elimination, the mechanism of acquisition of such structured sequences is imitation.

My concern with this argument stems from doubt that we can observe the product of a behavioral sequence and draw valid conclusions about its origin: to show that behavior is structured is not to show anything about its acquisition. There is nothing about an organized sequence per se that precludes its accomplishment through a variety of processes, only one of which is imitation. There are numerous examples of complex behavioral sequences that are the result of low-level controls on behavior, such as the tension between approach and avoidance that produces the zigzag swimming pattern in stickleback fish (Pelkewijk & Tinbergen 1937, as cited in Bates 1979). Although I agree with B&R that we must look elsewhere for an explanation of the behavioral sequences they describe, I think that for many of them we should examine more closely the possibility of individual "discovery."

A typical argument against individual learning (and the one that B&R make) is that the behavior in question, though complex, is acquired rapidly by all members of the species, with relatively few errors. Resolution of this paradox is often sought in sophisticated processes (in the present case, imitation) or in innateness. For example, in language acquisition, some attribute relatively rapid mapping of symbol to referent to innate constraints on the meanings of words. Overlooked in this argument is the "conspiracy" of forces that demands that the noises produced by adults of our species be mapped to the three-dimensional objects that the perceptual system delivers to our young. Mapping opportunities often involve an adult repeatedly uttering the same sound string, with exaggerated intonation, in an excited manner, while pointing to or holding the object of interest: "A kiiittteey. Look at the kiiittteey!" Innate constraints could control mapping of the noise "kitty" to the fluffy 4-legged creature. It is equally plausible, how-

ever, that the mapping is inevitable, given the constraints of the situation.

Inevitability may be the mechanism responsible for at least some of the structured behavioral sequences described by B&R. Consider, for example, the food preparation techniques of the mountain gorillas. The techniques can be described as having a clear goal (i.e., to secure food without being stung or choked) that can be reached via a temporally constrained sequence with readily identifiable intermediate goal states (that there are optional “repeat” loops does not alter the fact that the overall sequence is temporally constrained). During the three years before it is weaned, the infant gorilla spends the majority of its day with its mother. The mother, in turn, spends the majority of her day working her way through food preparation sequences. Assuming a conservative estimate of 10 hours per day spent feeding, the result would be 10,950 hours of exposure to the target behaviors. The circumstance affords a great deal of opportunity for observation and imitation. Critically, there is also ample opportunity to analyze the goal state of the causal sequence, the intermediate steps along the path, and thus, the means of achieving the goal. In fact, the conspiracy of forces imposed by the constraints of the task, the similarity in morphological characteristics, and environmental similarity virtually ensure that the young organism will settle on the same solution as its elders, with or without imitating them. When we see only the final product, it is impossible to tell whether an imitative process or some other one created it.

At issue in the controversy surrounding imitation in nonhuman primates is not whether the behavior to be imitated is simple or complex: “exquisite products can be constructed with humble tools” (Bates et al. 1991, p. 59). Rather, it is whether the target behavior is inevitable, given the organism, its goals, its environment and the constraints imposed thereby. If it is inevitable, then whether it is a structured sequence or an isolated action, it will not serve as a convincing example of imitation. What is convincing is when the organism produces target behaviors even when it does not understand the goal or the means to the goal and is therefore precluded from using causal analysis to plan or problem solve (whether mentally or on the plane of action) as a means to accomplish it. In essence, it is when animals are shown to reproduce arbitrary actions or sequences that the argument for imitation is most convincing. Given that it is highly unlikely that the orangutans in Russon (1996) and Russon and Galdikas (1993) shared the humans’ goals of cleanliness, hygiene, or aesthetics, the behavioral sequences associated with clothes washing and weeding were, from the apes’ perspective, arbitrary. As such, imitation would be the most plausible avenue to the behaviors.

That great apes are not particularly accomplished imitators of arbitrary behaviors or sequences is illustrated by the orangutan Supinah’s less-than-successful reproduction of fire-making and the relatively unsuccessful imitation of an otherwise opaque solution in a problem-solving task by orangutans (Call & Tomasello 1995). On the other hand, that they can engage in such species-inappropriate behaviors as clothes washing and weeding illustrates that the ability is available to them, even if it is not particularly well developed. What is convincing in these examples is not that the behaviors are embedded in a structured sequence, but rather that from the animal’s perspective they are arbitrary. In this light it is interesting to note that by 20 months of age, human children successfully generate means–ends sequences of action based only on knowledge of the goal state they are to attain (Bauer et al. 1997). Although they are able to imitate temporally constrained sequences as early as 9 months of age (Carver & Bauer, in press), it is not until 28 months of age that they reliably reproduce arbitrarily ordered action sequences (Bauer et al. 1998). Thus, for humans, the ability to solve a causal sequence predates the ability to imitate an arbitrary one. It should not be surprising then that for other primates, the pyramid of difficulty would be similarly oriented.

## Priming primates: Human and otherwise

Mark Chen, Tanya L. Chartrand, Annette Y. Lee-Chai, and John A. Bargh

Department of Psychology, New York University, New York, NY 10003-6634.  
 markc@xp.psych.nyu.edu tanyac@xp.psych.nyu.edu  
 annette@xp.psych.nyu.edu bargh@xp.psych.nyu.edu

**Abstract:** The radical nub of Byrne & Russon’s argument is that passive priming effects can produce much of the evidence of higher-order cognition in nonhuman primates. In support of their position we review evidence of similar behavioral priming effects in humans. However, that evidence further suggests that even program-level imitative behavior can be produced through priming.

Byrne & Russon (B&R) argue that a variety of putative instances of imitative behavior in primates can be accounted for in terms of passive priming effects. They accordingly conclude that these instances do not constitute compelling evidence for higher-order, strategic cognition.

The assumption that priming can play such a pervasive and powerful role in producing primate behavior is a key ingredient of the B&R argument about the accurate assessment of higher-order primate cognition. Although B&R’s position may appear radical in the context of traditional priming research in human cognition, in which priming effects are limited to memory and linguistic phenomena, it is in fact consistent with recent priming research in social cognition.

This research is based on the principle of the *perception-behavior link*, the assumption that representations used in the perception of the behavior of others either overlap with, or spread their activation automatically to, representations used to enact the same behavior by oneself. James (1890) championed this principle of *ideo-motor action*, and in one form or another it has been espoused by many other leading theorists, including Köhler (1925/1976), Piaget (1946), and Berkowitz (1984).

There have now been several demonstrations of priming effects on human behavior (see Bargh et al. 1996; Chen & Bargh 1997; Dijksterhuis & van Knippenberg, in press). For example, exposing human participants to verbal stimuli related to a type of social behavior (e.g., assertiveness, patience) dramatically increases the probability that they will behave in line with the primed concept in a subsequent, unrelated context. Activation of social stereotypes in the course of perception also has immediate and nonconscious effects on the perceiver’s own behavior. For example, activating the African-American stereotype through subliminal presentation of black male faces results in greater subsequent hostility in (white) participants, and priming the elderly stereotype results in the participant walking more slowly when leaving the experiment.

These behavioral priming effects also can be induced from the behavior of an interaction partner. Individuals change their facial expressions and physical mannerisms to be more similar to those with whom they interact, in a chameleon-like mimicking of behavior, but show little or no awareness of having done so when later questioned (Chartrand & Bargh 1998). Most notably, if their interaction partner mimics their own bodily posture and mannerisms, participants consider the interaction to have gone more smoothly and show greater liking for the partner. Thus, whereas B&R speculate that the main function of action-level imitation might be social, we propose that response-level facilitation also serves an important social function.

It is not only single behavioral acts that can be primed in humans, however; entire systems of goal-directed behavior and self-regulation can be initiated through priming techniques (Bargh & Gollwitzer 1994; Chartrand & Bargh 1996). Exposing participants to stimuli related to achievement in the context of a language test causes them to attain higher verbal performance scores in a later, seemingly unrelated, experiment. Moreover, qualities of motivational states are manifested in factors such as persistence toward

the task goal in the face of obstacles and resumption of the task following an interruption.

If humans manifest such priming effects with imitative and goal-directed behavior despite having, if anything, greater frontal cortical control capabilities (i.e., the ability to control automatic environmental influences) than nonhuman primates, then, consistent with B&R's contention, this tendency to be affected by priming should be the same or even stronger with nonhuman primates.

These findings suggest that even the program-level imitation observed by B&R (e.g., the orangutan overcoming obstacles to get to the dock and steal soap) could be the result of priming. Motivated behavior is characterized by persistence in the face of opposition, increase in strength over time when the goal is not satisfied, and rules of substitution leading to goal attainment, similar to the description of program-level imitative behavior by B&R.

Goal systems involve the activation and use of program-type actions that function in a hierarchical way. These individual actions in the service of the higher order goal do not require conscious regulation to be completed; they can unfold fluidly and efficiently in response to environmental events. Thus, what looks like program-level imitation might also be produced through passive means.

There are other reasons to be skeptical about B&R's proposed criteria for higher-order, "nonpriming" imitative behavior in terms of hierarchy and novelty. Epstein and his colleague (1984) showed that pigeons trained to perform a series of independent behaviors were able to order them into a novel sequence in such a way as to replicate Köhler's (1925) classic box-stacking studies. It is the inherent nature of hierarchically organized systems that lower levels operate autonomously (Bateson 1972; Koestler 1967); hence in pigeons as well as primates, if the overarching goal is activated (as through priming), novel sequences of skilled, well-learned behaviors can follow, with no need of guidance by higher-order cognition.

## Modelling imitation with sequential games

Andrew M. Colman

Department of Psychology, University of Leicester, Leicester LE1 7RH, England. [amc@leicester.ac.uk](mailto:amc@leicester.ac.uk) [www.le.ac.uk/psychology/amc/amc.html](http://www.le.ac.uk/psychology/amc/amc.html)

**Abstract:** A significant increase in the probability of an action resulting from observing that action performed by another agent cannot, on its own, provide persuasive evidence of imitation. Simple models of social influence based on two-person sequential games suggest that both imitation and pseudo-imitation can be explained by a process more fundamental than priming, namely, subjective utility maximization.

Imitation has been operationally defined as a significant increase in the probability of an action as a result of observing another agent performing that action. Byrne & Russon (B&R) have argued persuasively that this interpretation can lead to behavior being defined as imitative when it can be explained more simply by priming. I shall argue that such behavior can be explained even more simply by subjective utility maximization and that this need not necessarily rule out imitation.

Two-person game theory is applicable to any social interaction involving two agents (players), each choosing between two or more ways of acting (strategies), the outcome depending on the choices of both agents and the agents having well-defined preferences among the possible outcomes. Imitation, impersonation, emulation, and observational learning can all be modelled by two-person games. Potential strategies range from simple behavioral acts such as tongue protrusion by a mother, possibly inducing action-level imitation by an infant, to complex behavioral sequences

such as the removal of strings from nettles by a mountain gorilla, possibly inducing program-level imitation by a conspecific. Preferences are expressed as payoffs representing units of subjective utility associated with maternal pride, satisfaction of hunger, social approval, or, more generally, any form of reinforcement or (in evolutionary games) change in Darwinian fitness. The fundamental game-theoretic assumption is that players are motivated solely to maximize their own individual payoffs. [See also Maynard Smith: "Game Theory Without Rationality" *BBS* 7(1) 1984.]

There is a large class of games in which players end up choosing the same strategy. The strategy sets from which they choose may be large, but for simplicity consider a familiar two-strategy example, the Prisoner's Dilemma game:

	<i>C</i>	<i>D</i>
<i>C</i>	(3, 3)	(1, 4)
<i>D</i>	(4, 1)	(2, 2)

One player chooses column *C* (cooperate) or *D* (defect), the other player row *C* or *D*, and for each possible strategy combination, the pair of numbers in the payoff matrix indicates the (ordinal-level) payoffs to the row-chooser and the column-chooser, respectively. The experimental literature on this game includes numerous studies of human behavior (reviewed by Colman 1995, pp. 134–85) and some of nonhuman behavior (e.g., Flood et al. 1983; Gardner et al. 1984). The evidence confirms that a row-chooser who has reason to expect the column-chooser to defect usually defects, as well, and this makes sense because if the column-chooser opts for *D*, then the row-chooser receives a higher payoff by also opting for *D* (2 units) than by opting for *C* (1 unit). It follows that in a sequential version of the game in which the column-chooser moves first and opts for *D*, the row-chooser, moving second with perfect information of the column-chooser's strategy, is almost certain to follow suit.

Should such behavioral convergence be interpreted as imitation? I believe it should not, for the following reason. The row-chooser selects the same strategy as the column-chooser but does not select it *because* it is the same. The strategic structure of the game encourages the row-player to defect, irrespective of the action of the column-chooser, because the defecting strategy is dominant in the sense that it yields a better payoff to the row-chooser, irrespective of the column-chooser's strategy. Consequently, in the sequential version of the game, a row-chooser who responds to a column-chooser's defecting strategy by following suit cannot validly be described as imitating the column-chooser's action, because defection is mandated by self-interest in any case.

Interestingly, this objection does not apply to all strategic interactions. Consider next the Stag Hunt game (Lewis 1969):

	<i>C</i>	<i>D</i>
<i>C</i>	(3, 3)	(1, 2)
<i>D</i>	(2, 1)	(2, 2)

Here again, a self-interested player will seek to choose the same strategy as the co-player, but in this case the strategy will be chosen precisely because it is the same as the co-player's. The row-chooser will defect if there is reason to expect the column-chooser to defect but will cooperate if there is reason to expect the column-chooser to cooperate. Thus, in a sequential version of this game, the row-chooser, moving second, will respond to *D* with *D* to receive a payoff of 2 rather than 1 and will respond to *C* with *C* to receive a payoff of 3 rather than 2. The players' choices will tend to converge, as in the Prisoner's Dilemma game, but in the sequential version of this game it seems reasonable to interpret such behavioral convergence as imitative, because the row-chooser's strategy is directly induced by the column-chooser's.

Byrne & Russon (B&R) may reject this as a model of imitation because it is explicable by the more fundamental process of utility maximization (and also perhaps by priming). This objection could be dismissed on the ground that all voluntary behavior involves choice and all choice can be interpreted in terms of maxi-

mizing subjective expected utility (Jeffrey 1983; Kahneman & Tversky 1979). B&R would certainly reject it in cases in which the strategies represent non-novel forms of behavior, though the model is neutral on this point. The counterargument to this is that an action directly induced by observing the same action being performed by another agent may be imitative even if it lacks novelty. A teenager who is induced to wear an old pair of jeans by observing an admired role model wearing jeans is evidently imitating the role model, and any interpretation of imitation that excludes such a case seems perverse and at odds with the conventional meaning of the concept.

What is the essential structural difference between games such as the Prisoner's Dilemma and those such as the Stag Hunt, which allow strategic convergence to be interpreted as imitation in the latter class but not the former? The answer relates to Nash equilibria. A Nash equilibrium is a combination of strategies that are the best responses to each other. In the Prisoner's Dilemma game, the best response to *C* is *D* and the best response to *D* is also *D*; hence the only Nash equilibrium in the game is the strategy combination *DD* in the lower-right cell, yielding payoffs of 2 units to each player. Consequently, in the sequential version of this game, the best response of the row-chooser, moving second and pursuing self-interest, is *D*, irrespective of the column-chooser's strategy. However, in the Stag Hunt game, the best response to *C* is *C* and the best response to *D* is *D*, yielding two Nash equilibria in the top-left and bottom-right cells, and these two equilibria correspond to different strategies of the row-chooser. It seems reasonable to define an action as imitative if it results from observing another agent making the same voluntary choice and is directly induced by the other agent's choice, as in games belonging to the Stag Hunt class.

In some sequential games, an action may be directly induced by another agent's voluntary choice but may nevertheless fail to satisfy this definition of imitation. Consider, for example, the Hawk-Dove game (Maynard Smith & Price 1973):

<i>C</i>	<i>D</i>
<i>C</i> (3, 3)	(2, 4)
<i>D</i> (4, 2)	(1, 1)

In this game there are two asymmetric Nash equilibria. The best response to *C* is *D*, and the best response to *D* is *C*, hence the bottom-left and top-right cells represent Nash equilibria. In a sequential version of this game, although the strategy of the row-chooser, moving second, is induced by the action of the column-chooser who moves first, it does not satisfy my definition of imitation, because the behavior that is induced differs from the behavior that induces it. There are many other games of this type in which the players, by acting to maximize their individual self-interests, end up choosing different strategies.

#### ACKNOWLEDGMENT

Preparation of this article was facilitated by Grant No. L122251002 from the Economic and Social Research Council of the U.K. as part of the research program on Economic Beliefs and Behaviour.

## Can humans form hierarchically embedded mental representations?

Denise Dellarosa Cummins

Psychology Department, California State University, Sacramento, CA 95819-6007. [dcummins@saclink.csus.edu](mailto:dcummins@saclink.csus.edu)

**Abstract:** Certain recurring themes have emerged from research on intelligent behavior from literatures as diverse as developmental psychology, artificial intelligence, human reasoning and problem solving, and primatology. These themes include the importance of sensitivity to goal structure rather than action sequences in intelligent learning, the capacity to

construct and manipulate hierarchically embedded mental representations, and a troubling domain specificity in the manifestation of each.

When researchers from different disciplines reach the same conclusions concerning a phenomenon, one feels that one must be on the right track. So it is here. Byrne & Russon (B&R), through careful analysis of the primatological and developmental literatures, have arrived at the same conclusions concerning intelligent behavior as have researchers of human reasoning and problem solving: First, intelligent learning requires operating at the goal level, that is, noticing and reproducing the goal structures that define a solution to a problem. Second, the hallmark of intelligence is the capacity to reflect on one's mental representations to reorganize and manipulate them, rather than having them trigger direct action.

The necessity of copying at the goal level is most apparent in analogical reasoning, where solutions must be defined and executed in terms of similarity in goal structures rather than reenactment of problem-specific action sequences (Cummins 1994). This necessity is also particularly acute when solving problems whose goal structures are characterized by dense hierarchical embedding, such as those based on recursive procedures. The classical example is the Tower of Hanoi. This problem consists of three pegs and five discs of increasing size. The discs are stacked from smallest to largest (with the largest on the bottom) on the left-most peg, and the reasoner's task is to restack them exactly as shown on the right-most peg by moving only one disc at a time and never placing a larger disc on top of a smaller one. The optimal solution requires 31 moves, which vastly exceeds working memory capacity. Tasks such as this are readily learnable, however, once one notices – and can successfully reproduce – the recursive goal structure.

The intriguing question that arises for the target article concerns the extent to which other species are capable of reflecting on their own representations, that is, their capacity to form such hierarchically embedded mental representations. If, as B&R point out, much of what has been catalogued as imitation can be readily explained as priming effects, this question still remains to be addressed. Priming sheds no light on this question because primed records typically lead to direct action. The promise of research on imitation, mirror (self) recognition, and false belief testing was that these tasks would provide the means to measure the depth and complexity of mental representation in other species. However, the analysis offered by B&R on food "preparation" among gorillas and "laundry pilfering" among orangutans betrays a depth of mental representation that is rarely seen in these other tasks. This disparity leads one to suspect that the goal structures of tasks such as imitation and false belief testing are not as transparent to other species as they are to us.

This disparity in performance is also not unique to nonhuman species; indeed, one need not look far to find such disparities in human intellectual performance. The depth of recursive embedding in the five-disc Tower of Hanoi problem described above is trivial compared with the embedding depth one typically finds in the grammatical structure of human language. Yet the Tower of Hanoi problem is notoriously difficult for adult humans to solve, whereas parsing sentences with equal or greater grammatical structures is trivial for most native speakers. Focusing solely on performance in either of these domains would lead one to draw very different conclusions about the human capacity to traffic in hierarchically complex mental representation. Indeed, it is the "now-you-see-it-now-you-don't" nature of human reasoning and problem-solving performance that led to the proliferation of theories in cognitive psychology that explain human intelligence in terms of domain-specific abilities (e.g., Gardner 1983), reasoning strategies (e.g., Cheng & Holyoak 1985), modules (e.g., Cosmides 1989), and biological predispositions (e.g., Cummins 1996).

As B&R point out, developmental psychologists have produced an impressive body of evidence showing that there is a growth in the complexity and flexibility of mental representation during the

first five years of life, with an “explosion” of sorts occurring during the third and fourth years. The strength of the comparative approach is that it allows the general question of the nature of intelligence to be explored without parochial biases toward any particular species. This was the original goal of the rationalist approach adopted by artificial intelligence researchers: to define the nature and components of intelligence independently of their particular instantiations. Intelligence was intelligence whether instantiated in a biological organ with an evolutionary history or in a silicon chip as a product of human design. What the comparative approach brings to this discussion is the stark necessity of defining intelligence with respect to an organism’s goal in a particular environmental niche (whether the environment is defined physically or socially). As in artificial intelligence, problem-solving, and reasoning literatures, this has come to mean viewing intelligence as an uncertain balance between general-purpose capacities and special-purpose, domain-specific, or species-specific capacities. The capacity to form hierarchically embedded mental representations is emerging in a variety of literatures as a crucial cognitive function. It appears to underlie the capacity for theory-of-mind reasoning, language comprehension and production, and certain numerical abilities, to name a few examples. Although this would appear to make it a prime candidate for general-purpose capacity, it nonetheless often displays a “now-you-see-it-now-you-don’t” quality in human reasoning performance. A more fruitful approach to investigating this characteristic of intelligence would be to ask in which domains it appears reliably and in which species, and to compare the depth of hierarchical embeddings between species and between domains. In this target article, Byrne & Russon have made admirable progress toward these goals.

## A neurobiological approach to imitation

Jean Decety<sup>a,b</sup> and Julie Grèzes<sup>a</sup>

<sup>a</sup>*Mental Processes and Brain Activation, Inserm Unit 280, 69424 Lyon Cedex 03, France;* <sup>b</sup>*Cyclotron Biomédical Cermep, Hôpital Neurocardiologique, 69003 Lyon, France. decety@lyon151.inserm.fr*

**Abstract:** To explore the neural mechanisms engaged by the perception of action with the intent to imitate, positron emission tomographic activation studies were performed in healthy human subjects. We discuss the results in light of the framework proposed by Byrne & Russon, especially the distinction between mechanisms subserving action-level and program-level imitation.

Byrne and Russon’s (B&R’s) target article provides an excellent and useful framework to account for the cognitive mechanisms subserving imitation. We found their approach and arguments very stimulating. Their parsimonious interpretation should be applauded. Although most of the evidence in their paper comes from comparative psychology, they do suggest that their interpretation has implications for neuropsychology; one can accordingly examine the neural correlates to imitation.

Neuroimaging techniques such as positron emission tomography (PET) provide a unique opportunity to localize and identify the neural substrate of the perception of actions performed by others when the explicit goal of the observer is to imitate the actions perceived. It is difficult to imagine an experimental paradigm that could address the issue of the cognitive processes involved in imitation as it is conceptualized in the target article. Indeed, PET activation paradigms are by nature such simpler than real ecological observation. Hence the inferences from such data can only be modest ones. Nevertheless, what can be done is to reinterpret previous findings in light of B&R’s general framework.

The experiments we performed were designed to investigate the neural network engaged by the perception of human movements using PET (Decety et al. 1997; Grèzes et al. 1998). Perception of both meaningful and meaningless, purposeless hand ac-

tions was compared with the perception of the same kinds of stimuli with the goal of imitating them later, exactly as the model performed them (i.e., reproducing only the goal was not sufficient). The presentation of stationary hands served as a baseline. In all activation tasks, the video tape input consisted of sequences of five actions that had been executed with the upper limb. Each action lasted for 5 sec, was separated from the next by a 500-msec blank screen, and was repeated 2 times in random order (15 stimuli per condition). Meaningful actions consisted of pantomimes of transitive acts (e.g., opening a bottle, drawing a line, sewing a button, hammering a nail), performed by a right-handed person. Meaningless actions were derived from American Sign Language (ASL) and modified with the constraint that they should be perceptually as close as possible to the actions presented during the meaningful actions (e.g., movements involving mainly the right hand). As the subjects did not know ASL, the actions bore no overt relation to language or to symbolic gestures. Thus, meaningful actions have access to previously stored semantic and procedural knowledge whereas meaningless actions are not stored in the repertoire of the subjects. Observing the former would be categorized by B&R as the priming of brain records, whereas the latter would not and hence would probably come closer to providing evidence of imitation. The subjects’ performances, recorded on videotape, demonstrated that they were equally good at reproducing both types of stimuli. (The scanning was done during the perceptual phase.)

Perception of both meaningful and meaningless, aimless actions was associated with the activation of a common set of cortical regions. In both hemispheres, the occipitotemporal junction (Ba 37/19) and the superior occipital gyrus (Ba 19) were involved. In the left hemisphere, the active areas were the middle temporal gyrus (Ba 21) and the inferior parietal lobe (Ba 40). The precentral gyrus in the area of hand representation (Ba 4) was likewise activated on the left. These regions are interpreted as related to the analysis of hand movements because they were found to be involved in all activation conditions compared with the stationary hand condition. In addition to this common network, meaningful and meaningless movements engaged distinct networks: the perception of meaningful actions involves mainly the ventral pathway in the left hemisphere, which is known to be engaged in the iconic and semantic knowledge of actions (inferior frontal gyrus [Ba 44/45], fusiform gyrus [Ba 20], inferior temporal gyrus [Ba 20/38]). Meaningless actions that are unfamiliar and call for fine visuospatial analysis are subserved by the dorsal pathway (inferior parietal lobe [Ba 40] and superior parietal lobule [Ba 7]) bilaterally as well as the right cerebellum.

In contrast, meaningful and meaningless actions share almost the same network when the aim of the perception is to imitate. Activation sites were found bilaterally in the cerebellum, the dorsal pathway extending into the premotor cortex, the dorsolateral prefrontal cortex, and anterior cingulate. Additional bilateral activations were located in the supplementary motor area (SMA) and the orbitofrontal cortex during observation of meaningful actions. [see also Jeannerod: “The Representing Brain” *BBS* 17(2) 1994.]

Thus, when perception has no goal, the pattern of activation depends on the nature of the movements presented. However, when perception has a goal, namely, to imitate, the subject’s strategy has a top-down effect on the information processing, which seems to give priority to the dorsal pathway extending into the premotor cortex. These results fit well with the known division of labor in the visual cortex, where the ventral stream is thought to play a special role in visual perception and the dorsal stream is involved in vision for action (see Goodale 1997; Milner & Goodale 1995).

Because novelty is “a cardinal requirement of imitation,” the neural correlates of observing meaningless movements should be interpretable in terms of B&R’s framework. Given the structure of the stimuli as well as the task, action-level imitation is likely to be involved. Our results support, in part, B&R’s suggestion that action-level imitation is subserved by kinaesthetic-visual matching (which may correspond to activation in the parietal cortex). How-

ever, other sites of activation were found in the frontal lobe structures, which are closely involved in action planning (i.e., prefrontal cortex, SMA, anterior cingulate, and premotor cortex). Such activations would be more consistent with program-level imitation. This suggests that either action-level imitation likewise requires higher level processes and hence there is a continuum between action and program levels or it may simply be an artifact of the PET activation paradigm. [See BBS multiple book review of Posner & Raichle's "Images of Mind" *BBS* 18(2) 1995.] Indeed, the imitation task was to reproduce a sequence of five actions that had no relations between any of them. Hence it cannot be excluded that frontal activations are (partly) caused by temporarily storing in working memory the sequence of actions to be imitated.

## No imitation without identification

Frans B. M. de Waal

*Living Links Center, Yerkes Regional Primate Research Center and Psychology Department, Emory University, Atlanta, GA 30329.*  
dewaal@rmy.emory.edu

**Abstract:** We cannot solve questions about imitative learning without knowing what motivates animals to copy others. Imitative capacities can be expected to be most pronounced in relation to situations and models of great social significance. Experimental research on nonhuman primates has thus far made little effort to present such situations and models.

In our chimpanzee colony at the Yerkes Primate Center, infants sometimes get a finger stuck in the compound's fence: their finger has been hooked on the wrong way into the mesh and cannot be extracted by force. The adults have learned not to pull at the infant; victims always manage to free themselves eventually. In the meantime, however, the entire colony becomes agitated: a dramatic event analogous to a wild chimpanzee getting caught in a poacher snare.

On several occasions, we have seen other apes mimic the victim's desperate situation. For example, the last time this happened I approached to assist but received threatening barks from both the mother and the alpha male. As a result, I just stood next to the fence and watched. One older juvenile came over to reconstruct the event. Looking me in the eyes, she inserted her finger into the mesh, slowly and deliberately hooking it around, and then pulled as if she, too, had gotten caught. Then two other juveniles did the same at a different location, pushing each other aside to get their fingers in the same tight spot they had selected for this game. Long ago these juveniles themselves may have experienced the situation for real, but here their charade was prompted by what had happened to the infant.

I wonder where this behavior would fall under the usual classifications of imitation: no problem was being solved, no goal was being copied, and no reward was procured. Manifestly fascinated by the infant's predicament, the juveniles' imitation seemed emotionally charged. In discussions of social cognition, I find attention to motivation, emotional or otherwise, sorely missing. Experiments often test responses to different species in peculiar situations, such as a person with a bag over his head (Povinelli et al. 1990) or a person manipulating a puzzle box (Whiten et al. 1996). The animal subjects are asked not only to cross a species barrier, but also to select the relevant stimuli from among many unfamiliar ones.

I applaud the authors of the target article for attempting to steer away from the all-or-nothing classifications that have until recently dominated the imitation debate and for studying imitation in daily life rather than in isolated experimental trials. Their distinction between action-level and program-level imitation seems extremely useful, even though I remain unconvinced by some of the examples in support of the latter capacity. The case for gorillas would be stronger if individual learning could be ruled out. Pro-

gram-level transmission would predict the existence of different populations in which the majority of gorillas process the same plant species by means of different action sequences. Do such populations exist?

Orangutans stringing up hammocks and washing dishes present a more convincing case. It seems unlikely that these apes received training for actions that humans would certainly rather not have them perform, such as siphoning fuel from a drum. The fact that this sort of imitation occurs in orangutans living with humans is significant. These apes probably sympathize with humans, as defined by Humphrey (1976, p. 313): "By sympathy I mean a tendency on the part of one social partner to identify himself with the other and so make the other's goals to some extent his own."

If sympathy varies with emotional closeness to the model, this has serious consequences for claims about imitation, or the absence thereof, in human-animal experiments. For example, instead of ascribing to "enculturation" rare forms of imitation of humans by human-reared apes, as Tomasello et al. (1993) have done, it is entirely possible that all that human-rearing does is affect the range of identification objects. Animals probably identify the easiest with the species they know best. Remember Darwin's (1871) story of dogs cleaning themselves in cat-like fashion after having been reared by cats. Perhaps these dogs "thought" they were cats, in the sense that they had been imprinted on them. In the same way, rehabilitant orangutans and language-trained bonobos may see themselves as partly human. Rather than transforming cognitive capacities – as implied by the concept of "enculturation" – the simpler view is that rearing by another species increases the willingness to imitate this species.

The capacity to identify with others is widespread in the animal kingdom, as are basic forms of sympathy and empathy (de Waal 1996). Hence we should not hesitate to include in the imitation debate species such as octopi (Fiorito & Scotto 1992), hamsters (Previde & Poli 1996), guppies (Dugatkin & Godin 1992), and birds (Akins & Zentall 1996; Lefebvre & Giraldeau 1994). In addition, we should focus on the most salient stimuli for each species: observational learning is probably most fully expressed in relation to this class of stimuli. A group mate in distress, or engaged in a sexual or aggressive encounter, may draw more intense and precise attention than the sight of a human experimenter with a new contraption.

It follows that we should look beyond what animals do in tightly controlled laboratory tests: convergent evidence from natural or naturalistic settings is essential to the study of social cognition (de Waal 1991). Even if Byrne & Russon need to do more research before their conclusions can be accepted, their attention to spontaneous behavior is refreshing and essential for a full picture of animal imitative capacities.

## A Piagetian view of imitation

Harold D. Fishbein

*Department of Psychology, University of Cincinnati, Cincinnati, OH 45221.*  
harold.fishbein@uc.edu

**Abstract:** Byrne & Russon argue that the action and program levels of imitation form two discrete categories, with no intermediate steps. A Piagetian view enlarges our understanding of human and ape imitation by showing the developmental paths that imitation takes in the sensory-motor period of intelligence. It is clear from Piaget's (1945/1962) analysis that the action level of imitation is richly varied and that intermediate steps do occur between the action and program levels.

Piaget (1945/1962) has arguably presented the most profound theory of the development of imitation. It is my contention that Byrne and Russon's (B&R's) analysis can readily be accommodated and expanded by his theory. For example, Fishbein (1984) has summarized results showing that there are striking parallels in

the development of sensory-motor thought among monkeys, gorillas, and humans. All three species achieve the six stages of this development in the same sequence, with monkeys slower than gorillas, who are in turn slower than humans. Despite the fact that Piaget's theory is cited, B&R do not follow a developmental approach to understanding imitation. Given that monkeys and apes mirror the human stages in sensory-motor thought, parallels in imitation, including the timing of its hierarchical nature, should be observed.

One of the essential points of B&R's analysis is that the action and program levels of imitation are not on a continuum, but form "two discrete categories, with little sign of intermediates at present" (sect. 3, para. 4). Earlier in the target article they allude to the distinction between Piaget's (1945/1962) Stages 1 through 5 on the one hand and Stage 6 on the other. These two categories correspond, in a crude way, to the action and program levels of imitation, respectively. However, a detailed reading of Piaget indicates that there is a continuum between the action and program levels of imitation and that this continuum hinges on the underlying processes mediating cognitive growth.

Let us now turn to Piaget's (1945/1962) theory and relate it to B&R's model. Piaget asserts that in Stage 1 the newborn starts life with inborn reflexes as its initial schemas, assimilation and accommodation processes that can modify these schemas, and the capacity to have these reflexes triggered by a variety of external stimuli. True imitation is absent in this stage; for example, crying triggered by the crying of other babies is not imitation.

In Stage 2, an additional capacity emerges: primary circular reactions. These are essentially self-imitative acts in which infants are able to repeat actions they have just performed. In this stage, children can imitate others provided they have previously produced the activity through their own circular reactions. These are action-level imitations and should be observed in apes, despite B&R's caveat that "to be sure of imitation, the act should not already be part of the animal's repertoire" (sect. 1.5, para. 2).

In Stage 3, another new capacity emerges: secondary circular reactions. These allow two sensory systems such as vision and touch to be coordinated. This leads to the infant's ability to repeat actions that produce desired effects in the environment; for example, kicking its feet on the bed, which moves a hanging mobile. Imitation in this stage is restricted to movements the child has previously made and seen, and hence are at the action level. Children cannot defer imitation at this stage because they do not have the capacity for representation.

In Stage 4, yet another new capacity emerges: mobile indices. These are not mental representations or signals, but rather behaviors that children can perform to mediate between perceived movements of others and their own imitative behavior. For example, in imitating its father sticking out his tongue, the infant bites its lips (a mobile index) and then sticks out its tongue. The index is mobile in the sense that it can be used to mediate a variety of actions. Mobile indices allow the child to imitate actions it has already made, but unlike the actions in Stage 3, they are not visible to the infant; for example, sticking out the tongue or opening and closing the mouth. Thus, action-level imitation has moved to a new level of complexity, but is still restricted to behaviors that are already in the child's repertoire.

In Stage 5, the child can now imitate models performing novel actions, including those not visible to it. The new capacity of tertiary circular reactions emerges at this stage. These allow the child to experiment actively in the environment by repeating self-initiated behaviors to see what results. These tertiary circular reactions allow the child to imitate novel actions "through systematic and controlled trial and error." Thus, Stage 5 is a bridge between action and program levels of imitation.

In Stage 6, the child has acquired the capacity to form representations, or mental images. This allows it to form images of the actions of a model, store them, and defer imitation to a later time, well after the model's action has been performed. In a sense, the child can now imitate the model internally and defer external im-

itation to a more suitable time or place. In addition, imitation can now occur for more complex actions than seen in Stage 5. This stage corresponds to the program level of imitation.

The next period of development is "representative intelligence," which occurs from ages 2 to 7 years, and in which images and symbolic functions play the major roles in imitation. Children become less concerned with attempting to match the details of models, but focus more on the overall pattern of the actions. B&R present data that suggest that the great apes can imitate at this level of complexity.

In summary, a Piagetian developmental approach enlarges our view of imitation in apes. It points to research that can be performed to determine whether the same developmental processes are involved with humans and apes. This research should demonstrate with apes that there are intermediate states between the action and program levels of imitation.

## Splitting, lumping, and priming

Mark Gardner and Cecilia Heyes

Department of Psychology, University College London, London WC1E 6BT, England. [m.gardner@ucl.ac.uk](mailto:m.gardner@ucl.ac.uk) [cheyes@ucl.ac.uk](mailto:cheyes@ucl.ac.uk)

**Abstract:** Byrne & Russon's proposal that stimulus enhancement, emulation, and response facilitation should be lumped together as priming effects conceals important questions about nonimitative social learning, fails to forge a useful link between the social learning and cognitive psychological literatures, and leaves unexplained the most interesting feature of phenomena ascribed to "response facilitation."

Byrne & Russon's (B&R's) imaginative target article contains both splitting and lumping proposals. The recommendation that imitative social learning should be split into two varieties (action-level and program-level imitation) has significant weaknesses, not the least of which is its complete lack of empirical support. The data reported by B&R only illustrate the claim that imitation can occur at a hierarchical program level and could be interpreted in various other ways. The mere fact that B&R can describe behaviour in terms of goals and subgoals is not evidence that the behaviour was executed under hierarchical control.

In our commentary, we will concentrate on the suggestion that stimulus enhancement, emulation, and response facilitation should be lumped together as instances of *priming*. There are three problems with this proposal: it conceals important questions about nonimitative social learning, it fails to forge useful links between this kind of learning and the cognitive psychological literature on priming, and it leaves unexplained the most interesting feature of phenomena ascribed to "response facilitation."

The first problem arises from the idiosyncratic way in which B&R characterize stimulus enhancement. They describe stimulus enhancement as if it were an associative phenomenon, in which a conditioned stimulus (CS; e.g., a location) acquires excitatory strength as a result of being observed in conjunction with an unconditioned stimulus (US; e.g., a conspecific eating). This is odd because, ever since Spence (1937) coined the term *stimulus enhancement*, it has been treated as a variety of single stimulus learning in which conspecific behaviour draws the observer's attention to a stimulus, but does not act as a reinforcer. *Observational conditioning* (Mineka et al. 1984) is the term traditionally used for learning that is thought to depend on socially mediated exposure to a CS-US relationship. Of course, B&R may use terms in whatever way they please, but putting the label *stimulus enhancement* on observational conditioning is likely to cause confusion among those familiar with the terms and to conceal important outstanding questions about social learning. The conventional distinction between stimulus enhancement and observational conditioning



amounts to an untested hypothesis that conspecific observation can attract an animal to an object via associative and nonassociative routes. By drawing attention to the role of Pavlovian mechanisms in social learning, the term *observational conditioning* also raises the largely unexplored possibility that animals can learn inhibitory as well as excitatory relationships by observation (Heyes 1994).

The second problem arises from inconsistencies between the mechanism proposed to account for nonimitative social learning and the cognitive psychological literature on priming. According to B&R's priming account, an internal representation will be primed only if activated while a conspecific is seen to receive a reward. In contrast, neither of the main types of priming phenomena manipulated by cognitive psychologists require reward presentation. Under certain conditions, mere preexposure to a priming item can result in either short-term facilitation of responses appropriate to a different probe item (associative priming) or relatively long lasting facilitation of responses to the same probe item (repetition priming). Furthermore, the assumption that only familiar items may be primed is inconsistent with experiments indicating that priming can involve novel items (Squire 1992). This evidence undermines the only original prediction generated by B&R's account of nonimitative effects, implying instead that putative observational priming effects could produce novel behaviours. The observational priming proposal does not harness the explanatory power of cognitive psychology to make useful predictions about nonimitative social learning.

The third problem is that the observational priming proposal does not adequately explain several experimental effects categorised by B&R as "response facilitation." They suggest that behavioural concordance occurred in these experiments because the observation of a conspecific making a response primed an internal representation mediating the execution of a matching response. This proposal, however, has overlooked the most interesting aspect of these effects: the information about a response available to the experimental animals during observation differed in important respects from that available to them during later execution of the same response.

One respect in which observed and executed responses differ is the availability of proprioceptive information. It is unlikely that response representations code only the visual appearance of a response (and not also proprioceptive information), yet the observational priming proposal does not provide a mechanism through which the visual information available through observation of behaviour could prime response representations. A demonstration of cross-modal priming in animals would be striking because such effects do not occur equally across all sensory modalities even in adult humans (Driver & Baylis 1993).

Visual information provided by observed and executed responses also differs because of the disparate viewpoints of performer and onlooker. This is easily illustrated using the example of rats tested with the bidirectional control procedure (e.g., Heyes et al. 1992). These animals encounter a conspecific face-to-face while exposed to demonstrations of lateral responses. Hence a rat reproducing, for example, a left response, is presented with retinal images of its own limb movements (left translation) that are radically different from those of the limb movements of its demonstrator (right translation). Although these experiments have limitations as tests of imitation (Gardner 1997), observational priming clearly does not adequately explain behavioural concordance in our rats. Priming is even unlikely to occur when observer-demonstrator differences in viewpoints are less marked. Visual repetition priming effects are strongly influenced by the specific appearance of the priming stimulus (Squire 1992).

## When actions are carved at the joints

Merideth Gattis, Harold Bekkering,  
and Andreas Wohlschläger

Max Planck Institute for Psychological Research, 80802 Munich, Germany.  
{gattis, bekkering, wohlschlaeger}@mpipf-muenchen.mpg.de  
www.mpipf-muenchen.mpg.de/bcd/people/game\_e.htm  
www.mpipf-muenchen.mpg.de/ca/people/beha\_e.htm  
www.mpipf-muenchen.mpg.de/ca/people/woan\_e.htm

**Abstract:** We focus on Byrne & Russon's argument that program-level imitation is driven by hierarchically organized goals, and the related claim that to establish whether observed behavior is evidence of program-level imitation, empirical studies of imitation must use multi-stage actions as imitative tasks. We agree that goals play an indispensable role in the generation of action and imitative behavior but argue that multi-goal tasks, not only multi-stage tasks, reveal program-level imitation.

Theories of imitation, as Byrne (1995) has argued, need to address two problems of imitative action: the difficulty of copying an act performed from another individual's perspective and the difficulty of building complex behaviors from several parts. Current explanations of imitation often deal with these problems by positing that some kind of representational overlap between events (performed by an observed other) and actions (performed by the perceiver-self) allows observed actions to be mapped directly to motor programs. This account of the mechanisms underlying imitation, called *direct mapping*, *kinaesthetic-visual matching*, or *online coupling* (Decety 1996; Fadiga et al. 1995; Meltzoff & Moore 1977; Vogt 1996b), thus skirts these two central problems of imitation: the difficulty of copying an act performed from another's perspective is eliminated because the other-schema and the self-schema are already aligned via representational correspondences, and the difficulty of assembling a complex action from several parts is simply not considered. Direct mapping theories hold tremendous appeal for computer scientists building robots and other computational implementations because they simplify a complex mapping problem. However for researchers studying human and animal behavior, these theories lack plausibility as an explanation of how humans and other animals imitate because they ignore how complex and flexible imitative behavior can be. For example, direct mapping theories do not adequately explain how a self-schema can be aligned with so many physically different other-schemas (including much larger and more physically mature members of one's own species, as well as members of other species), or why imitative action often involves several attempts, which are increasingly close approximations of the modeled behavior.

In contrast to direct mapping theories, Byrne & Russon (B&R) argue that the most common form of imitative behavior, program-level imitation, is a complex, hierarchically organized process. B&R propose that action-level imitation, or imitation of the motor act, may rely on kinaesthetic-visual matching, but program-level imitation cannot, because it involves imitation of the structure and organization of behavior and must therefore be driven by hierarchically organized goals. This distinction offers two advantages for advancing our understanding of imitation. First, focusing on the centrality of goals begins to address the two central problems of imitation: goals facilitate the conversion from other-schema to self-schema and supervise the construction of complex actions from several parts. Second, focusing on hierarchical organization directs attention to questions about how imitation occurs rather than what is or is not imitation. As B&R state, "the interesting question for imitation becomes the extent to which individuals can and do imitate this organization of behaviour, rather than the old issue of whether they can imitate a particular action" (sect. 2.1, para. 3).

B&R offer multi-stage tasks as the crucial technique for investigating the extent to which individuals imitate the organization of behavior. We are using a different technique, a multi-goal task,

with similar effect. Multi-goal tasks involve multiple goals enacted simultaneously or nearly simultaneously, in contrast to the sequential stages of a multi-stage task. Bekkering et al. (in preparation) used a hand-to-ear-movement paradigm with six possible actions: touching an ear with the same-side hand, touching an ear with the opposite-side hand (crossing over the body), and touching both ears at once, either with parallel arms, so that each hand touches the ear on the same side, or crossing both hands to touch the opposite-side ears. When asked to imitate an adult modeling these six movements, 4-year-old children imitated the unimanual and bimanual ipsilateral movements accurately, as well as the bimanual contralateral movement, but failed to match a unimanual contralateral movement (touching an ear with the opposite-side hand). When an adult modeled a one-handed contralateral movement, children touched the appropriate ear with the inappropriate hand, and thus produced an ipsilateral rather than contralateral movement. This pattern of imitation also occurred when hand movements were directed at dots on a table rather than ears. When similar movements were made always to only one ear, however, or when movements were directed at locations in space rather than physical objects (the dots were removed from the table), this ipsilateral preference was eliminated. This pattern of results indicates that imitation in young children is organized by goals, such as an object (a particular ear), an agent (a particular hand), or a movement path (crossing the body), or salient features (the crossing of the arms across the body in the bimanual contralateral gesture), and that these goals are hierarchically organized. Our results suggest that physical objects, such as ears or dots, occupy the top of this hierarchy: when multiple goals compete for capacity, one goal is selected over the others – in these cases, the object at which movement is directed. In contrast, when the number of goals is reduced, for example by limiting the number of objects (only one ear) or by removing objects altogether (taking the dots off the table), goals lower in the hierarchy can be fulfilled, in this case the hand or agent of movement.

The hand-to-ear paradigm is a multi-goal task rather than a multi-stage task because the component goals, such as object, agent, and path, appear to be selected simultaneously rather than sequentially. Were the goals organized sequentially, we would expect to find children making the least errors in hand selection, because it would be the first goal executed, and the most errors in ear selection, because it would be the last goal executed, but our results reflect the opposite pattern: children make the most errors in hand selection and the least errors in ear selection. From this we conclude that in the hand-to-ear paradigm, multiple goals are enacted simultaneously and nonetheless reveal a hierarchical organizational structure. Because they reveal the hierarchical structure of behavior so well, we consider multi-goal imitative tasks to be an excellent framework for revealing not only the extent of imitation, but also the organization of action.

## Out of the mouths of babes: A hierarchical view of imitation by human infants

Harlene Hayne

Psychology Department, University of Otago, Dunedin, New Zealand.  
hayne@psy.otago.ac.nz

**Abstract:** Byrne & Russon have argued that imitation is not an all-or-none phenomenon but may instead occur at different levels. Although I applaud their theoretical framework, their data provide little empirical support for the theory. Data from studies of human infants, however, are consistent with the view that imitation may occur at different levels. These data may provide better support for Byrne & Russon's hierarchical view of imitation than the nonhuman primate data that their theory was developed to explain.

Territorial arguments over the term *imitation* have historically dominated the comparative literature on social learning, obscuring the more interesting questions of how, when, and what animals are likely to learn from watching each other. In their target article, Byrne & Russon (B&R) propose that imitation may not be an all-or-none phenomenon but may instead occur at various levels. I applaud their attempt to overcome the dichotomous definitions that have plagued prior research with nonhuman animals. I anticipate that their hierarchical framework may force us to reevaluate our current views about the evolution of imitation and other forms of social learning.

Despite the merit of B&R's theoretical approach, I found their data far from convincing. The bulk of the evidence they present comes from anecdotal case reports of human-like behaviors performed by nonhuman primates. There are two fundamental problems with these data. First, B&R assign considerable importance to behavioral novelty as a defining characteristic of imitation. Despite this, they provide no independent measure of the baseline rates for any of the behaviors they reported in animals given access to the same materials without a prior opportunity to watch humans using them. For example, B&R report that orangutans are frequently seen cruising down the river in canoes. I suspect that even in the absence of prior observation, wild orangutans can easily detect the affordance of a canoe floating beside the riverbank. Similar arguments could be generated for many of the other behaviors described in this target article and, in the absence of empirical data, it is impossible to resolve the issue.

Second, B&R have not provided evidence that any of the elaborate and exciting behaviors emitted by these nonhuman primates were actually acquired through observation alone, which, even before behavioral novelty, would appear to be the lynchpin for any definition of imitation. How do we know, for example, that each behavior or series of behaviors did not undergo a prolonged period of trial-and-error acquisition? Within B&R's own framework, many of the behaviors they observed could be the products of stimulus enhancement, emulation, and response facilitation. Again, in the absence of empirical data, we cannot sort the imitative wheat from the nonimitative chaff.

Ironically, recent data collected with human infants may provide better empirical support for B&R's theoretical approach than the unsystematic and highly anecdotal data from nonhuman primates for which the hierarchy was developed in the first place. I suspect that B&R failed to exploit the human infant literature to their full advantage because they mistakenly assume that the experimental procedures used with older infants are similar to the procedures used with neonates. B&R do briefly describe past studies conducted with human neonates. They correctly report that an infant's imitation of an adult's facial expression is defined as a selective increase in the frequency of that expression relative to other expressions. As B&R also note, the spontaneous production of some of these target facial expressions is not low, even in newborns. The lack of a nonzero baseline raises the possibility that the infants' behavior *could* be classified as response facilitation rather than as imitation per se. (According to B&R, "Novelty will prove to be a cardinal requirement of imitation"; Introduction, para. 3.)

The emphasis on behavioral novelty as a defining characteristic of imitation comes as no surprise to most developmental psychologists. Over the past 30 years, imitation of zero-probability behaviors has been the accepted hallmark in studies with older infants (Masur & Ritz 1984; Meltzoff 1988a; Piaget 1962; Uzguris & Hunt 1975). A number of recent empirical studies of imitation by 6- to 24-month-old infants have specifically included target behaviors for which spontaneous production hovers close to zero (Barr et al. 1996; Hayne et al. 1997; Meltzoff 1988a; 1995a). The results of these experiments have clearly shown that infants can and do acquire novel behaviors after watching them performed by an adult even when they are tested for the first time following a delay.

Given that some studies conducted with human infants satisfy

B&R's criterion for behavioral novelty, what are the implications of these studies for B&R's hierarchical approach to imitation? Recent research from my laboratory has shown that 12-, 18-, and 21-month-old infants exhibit similar levels of imitation when tested after a 24-hour delay with the same props that were used by the experimenter during the original demonstration (Hayne et al. 1997). When infants are tested with different props, however, performance varies as a function of age. Changes in the props that disrupt imitation at 12 months have no effect on imitation at 18 months, and changes in the props that disrupt imitation at 18 months, have no effect on imitation at 21 months.

We have argued that the findings described above reflect an age-related increase in the flexibility of the underlying memory representation (Hayne et al. 1997). Our argument is consistent with B&R's notion that imitation may not be an all-or-none phenomenon, varying instead along a continuum. In this theoretical context, human neonates may be restricted to some form of highly constrained mimicry. Over the course of development, however, infants may begin to use information acquired through observation to solve problems at a more flexible and intelligent level (for similar arguments see Meltzoff 1988b; 1995b). We now know that early in life, an infant's imitative behavior reflects a relatively precise copy of the model's actions. Later in infancy, however, infants' imitative response will vary to meet current stimulus or contextual conditions (Barnat et al. 1996; Hayne et al. 1997) or to match their understanding of the goal of the model's behavior (Meltzoff 1995b). In my view, this developmental change in imitation by human infants provides some empirical support for the distinction between action-level and program-level imitation outlined by B&R.

In conclusion, the full story of the evolution of imitation as a social learning process cannot be told in the absence of highly systematic empirical investigation. Developmental psychologists have learned this lesson the hard way. Piaget's theory of cognitive development was based primarily on the observation of his own three children. Empirical research has shown that Piaget grossly underestimated infants' ability to learn by imitation. In view of this, B&R should use their naturalistic observations to guide subsequent research on imitation in nonhuman primates conducted under more controlled conditions. Their hierarchical framework is likely to stimulate new research activity as individuals from a number of disciplines attempt to garner empirical support for and against their approach. The end result will undoubtedly contribute to our current understanding of the evolution of imitation per se as well as to our understanding of other forms of social learning.

## When is imitation imitation and who has the right to imitate?

Mikael Heimann

Departments of Psychology and Special Education, Göteborg University, SE 403 50 Göteborg, Sweden. mikael.heimann@psy.gu.se www.psy.gu.se

**Abstract:** It is suggested (1) that motivation must not be overlooked, (2) that most social imitation does not involve novel behaviors, and (3) that newborn babies do imitate.

The ideas presented by Byrne & Russon (B&R) are of great interest to anyone trying to understand what imitation is and how it might work. B&R suggest (1) that imitation is often an ill-defined concept and (2) that what is seen as imitation could be the result of quite different processes, two of which are outlined in the target article: action-level and program-level imitation. To this, I am basically sympathetic, but I fail to understand why this must imply that some types of imitation should be considered "truer" than others. This issue – how we allow imitation to be defined – is one

of my concerns; in this commentary another concern is how B&R treat imitation in human newborns.

**Definition of imitation.** B&R start in a grand fashion when they state that they would like to "go beyond the question 'Is it imitation, or not?': and "instead ask 'What sort of imitation is it, and why is it used?'" (Introduction, para. 4). Unfortunately, this is not what they achieve. Instead, they more or less conclude that the process that most researchers have studied – that is, action-level imitation – should not be considered imitation because one cannot with 100% certainty rule out other processes (e.g., response facilitation). The only process worthy of being called *imitation* is program-level imitation and perhaps some action-level imitation – provided that novel behaviors are part of the process. Thus, imitation within the social domain is excluded, because such imitation rarely involves novel behaviors.

B&R needlessly narrow the use of the word *imitation*, making it difficult to discuss alternative processes behind imitation. One such alternative might be motivational factors (Trevarthen 1993): imitation can be socially driven, cognitively motivated, or the result of a combination of social, emotional, and cognitive processes (Heimann 1998; Holmlund 1995; Uzgiris 1981). Moreover, some imitation might be caused by direct conscious processes, whereas other instances of imitation are the result of more immediate and direct processes outside the awareness of the individual (as in neonatal imitation).

**Imitation among newborn human babies.** Although neonatal imitation is not the main issue in B&R's target article, they "dispute that any of these experiments . . . provide evidence of imitation" (sect. 1.4, para. 3). The reader is first left to believe that they prefer instead to explain neonatal imitation through the process of response facilitation. This does not turn out to be the case: they state that the criticism "has no weight" because the action performed by the infant "is invisible to its performer" (sect. 1.4, para. 5). B&R instead turn to a different process and suggest that neonatal imitation can be explained as a form of contagion. However, the existing evidence to date (of which most is *not* cited by B&R) does not seem to favor such a conclusion.

Neonatal imitation is not as automatic or reflex-like as contagious yawning. It can take up to 60 seconds for a newborn child to form an imitative response (e.g., Heimann et al. 1989; Holmlund 1995). Thus, in some respects neonatal imitation can be seen as a form of delayed response. At 6 weeks, this delay can be 24 hours without interfering with imitation (Meltzoff & Moore 1994). Moreover, some researchers have noted that newborn children slowly work themselves up toward a complete imitative response (e.g., Kugiumutzakis 1993). In our own studies, we found imitation during the newborn period only if partial responses were included in the analysis.

Finally, observations indicate that a newborn's imitative capacity is related both to the early mother–infant interaction (Heimann 1989) and to the child's temperament (Heimann 1994). Highly imitative infants display less gaze aversion and infants judged to be more active by their mothers also tend to be more imitative.

Newborn babies *do* imitate, but this fact does not imply that neonatal imitation is based on processes similar to the more mature imitation that develops later. In newborns, imitation is probably mediated through subcortical multimodal structures (Stein & Meredith 1993), but it still deserves to be called imitation!

## Movement imitation as faithful copying in the absence of insight

Ludwig Huber

Institute of Zoology, University of Vienna, Biocenter, A-1090 Vienna, Austria.  
ludwig.huber@univie.ac.at  
www.univie.ac.at/zoologie/theo/ludwig.htm

**Abstract:** Byrne & Russon use novelty as the primary requirement for providing evidence of true imitation in animals. There are three reasons to object to this. First, experiential learning cannot always be completely excluded as an alternative explanation of the observed behavior. Second, the imitator's manipulations performed during ontogeny cannot be known in full detail. Finally, there is at present only a weak understanding of how novel forms emerge. Data from our own recent experiments will be used to emphasize the need for a tighter methodology in imitation experiments.

Byrne & Russon claim to have set aside threshold definitions of imitation, but then propose the contrary: that *novelty* will prove to be a cardinal requirement of imitation. Imitation is used to refer to the reproduction of complex, hierarchical behavior rather than simple movements. Does this justify using novelty as a necessary condition for imitation? I discuss three reasons for caution.

The first reason comes from Russon (1996) herself, who acknowledges that the novelty criterion cannot identify all cases of true imitation because of the intrinsic difficulty of excluding experiential learning. Only in combination with other criteria, called *misfits*, which one hopes are present when studying attempts at imitation, is true imitation likely to be witnessed. Thus, identifying cases of imitation under favorable conditions requires luck.

A second reason is that it would be impossible to fully assess the behavioral history of a very explorative animal with an open-ended action repertoire. Fortunately, this objection is not a central one (it only supports the need for experiments that use captive animals whose learning history can be monitored continuously and does not pose as much difficulty for students of less intelligent species).

The third difficulty, and theoretically the most problematic one, is our profound ignorance of how novel forms emerge in nature. New insights are expected from chaos theory and nonlinear mathematics, but in the behavioral sciences such new thinking is rarely adopted. As a starting point, one could take Konrad Lorenz and Jean Piaget as advocates.

Voluntary movements form the basis of motor learning by cutting segments out of an extensive inherited motor sequence, thus introducing a new and independent behavioral pattern that is adapted to external circumstances through a process of refference (Lorenz 1977). The adaptive value of motor learning was originally based on the need for orientation mechanisms that fulfilled the demands of spatial insight. However, it would only require "a slight shift in emphasis, such as would have occurred with the curiosity behavior of higher mammals and some birds, and particularly the self-exploration of our immediate ancestors, to bring the survival value of the acquisition of knowledge to the fore" (p. 143). This faculty, which originally helped produce motor skills, would then become an important means of exploration, play, and social learning.

The phylogenetic programs of explorative animals are extremely open systems, actively acquiring information from the external world through "objective investigation." New information is constantly being integrated into preexisting programs to enable the animal to become adapted to new circumstances. The new information is not used instead of old programs; rather, it is intimately woven into those programs by a mutual process of assimilation and accommodation (Piaget 1937/1954). Assimilation is the process of incorporating an internal operative act through which environmental data are acquired. Accommodation is the outwardly directed process of adapting an overall structure to a specific case. In this sense it always includes an element of novelty, but it is an already present structure that becomes differentiated through observational learning. It is difficult to see how the

threshold definition of novelty could be reconciled with such a dynamic and mutual process of learning.

From this point of view, Thorpe's (1956) definition of true imitation seems quite conservative and intelligible: reproduction of a novel or otherwise *improbable* act. How can we objectively assess the (im)probability of a reproduced act?

We have recently used the "artificial fruit" paradigm (see Whiten's accompanying commentary, this issue) to study the imitation of movement in marmosets (Bugnyar & Huber 1997). Monkeys were exposed to a conspecific demonstrator performing one of two alternative actions on a single manipulandum. First, the proportion of observed to nonobserved versions of the action of each animal was calculated and compared with that of a control group of nonexposed subjects. Then we examined the efficiency and outline of the animals' responses. Not only did most of the five observers, compared with none of the six control animals, have immediate success, but two of the observers also made exact copies.

Because nonobservers demonstrated that the action that the observers were exposed to was not a simple movement of one arm but a compound action, a microanalysis was performed. First, we determined the (im)probability of an exact reproduction of the observed opening sequence (the combined probability of five action elements from the respective upper confidence levels of the control animals' acts). Then we determined the probability that this behavioral copy would occur in the two observers but not in the control animals. Significant p-values were obtained. Thus, evidence for imitation did not rest on plausibilities, human judgments, or vague criteria.

What remains open is why the probability of a learned copy should be great. If we acknowledge that *program-level imitation* is a necessary supplement to our current understanding of imitative phenomena, then the ecological relevance of *movement imitation* remains to be specified. Imitation of arbitrary gestures has been abandoned in favor of the manipulation of objects in problem-solving or foraging situations. In these it is crucial to determine whether insight into the causal structure of a task is involved. An understanding of either the causal relationships or the intention of the conspecific model's behavior is likely to affect learning about the finer details of a behavior. For example, the imitator may only attend to the affordances of an object (emulation), the goal of the behavior (goal emulation), the serial order of the actions involved (sequence learning), or the program structure (program-level imitation). If an understanding of the causal structure of the task is not available, however, or it is beyond the cognitive capacity of an observer, then faithful (slavish) copying of the behavior of a model (e.g., the mother) is a valuable alternative. In great apes, and most obviously in human children, movement imitation has become part of a social game, because of a functional change in evolution. In other species, however, it may be the only solution.

In conclusion, rejecting well-documented movement imitation in animals other than apes as nonimitative priming is by no means justified. In contrast, a tighter methodology needs to be used when investigating the more complex forms of animal imitation. For the moment, however, Occam's razor dictates waiting for unequivocal evidence and, in the meantime, treating program-level imitation as the "contrived alternative."

## A methodological behaviourist model for imitation

Paul J. M. Jorion

Maison des Sciences de l'Homme, Du sujet: Theorie et Praxis (STP), Paris; and Department of Anthropology, University of California, Irvine, Irvine, CA 92697-5100. jorion@2aris.ss.uci.edu aris.ss.uci.edu/~jorion

**Abstract:** Byrne & Russon's target article displays all the difficulties encountered when one fails to take a *methodological behaviourist* approach to imitation. Their conceptual apparatus is grounded in a mixture of introspection and folk psychology. Their distinction between *action-level* and *program-level imitation* falters on goal imputation for sequential acts. In an alternative *gradient descent* model, behaviour can be simulated as a frustration/satisfaction gradient descent in the animal's "potentiality space," as defined by knowledge, inventiveness, and the surrounding environment.

Byrne & Russon's (B&R) target article displays all the difficulties inherent in any approach to imitation other than *methodological behaviourism*. The initial flaw resides in their conceptual apparatus for imitation, which is grounded in a mixture of introspection and folk psychology in a classical three-step process.

Step 1: I rationalise my own behaviour in purposive terms borrowed from the folk psychology inherent in everyday language; that is, I generate for my own autobiographical use a post hoc discourse in which my consciousness assigns itself goals and then accomplishes them.

Step 2: I expand the scope of this schema to rationalise the observed behaviour of my fellow human beings although the supporting evidence remains that of my initial introspection.

Step 3: I further expand the scope of the schema, this time to cover animal behaviour, but with the evidence still introspective.

Once I reach step 3, I am stuck with the encumbrance of what appeared innocuous enough initially: consciousness is in the driver's seat. Accordingly, in the case of animals, I am faced with the impossible task of sorting out *voluntary* acts from *involuntary* ones, *purposive* sequential acts from *accidental* ones; in addition, I am forced for plausibility's sake to jettison the causal role of consciousness in behaviour of some arbitrary point on the evolutionary ladder between apes and insects.

B&R's distinction between *action-level imitation* and *program-level imitation* consequently falters on goal imputation for motor act sequences, which is grounded on what amounts to the "compassionate introspection" of the researcher. For example, in the authors' own words: "In some cases [of orangutan behaviour], their goals were clearly those of the humans" (sect. 2.6, para. 1). "Clearly" to whom, one may ask, if the reason turns out to be obscure? Similarly, "her behaviour made sense only with this goal in mind" (sect. 2.6, para. 6). Is "last attempt at making sense" strong enough support for goal imputation? And so on.

For a number of years I have propounded a *gradient descent* model of behaviour that avoids the pitfalls of imputing goals (Jorion 1990, pp. 94–97; 1994, pp. 94–98; 1997, pp. 3–4). In such a framework, which is consistent with *methodological behaviourism*, any sequence of animal (and human) behaviour can be modelled as frustration/satisfaction gradient descent in the organism's *potentiality space*, as defined by its knowledge, inventiveness, and the current state of its surrounding environment.

I will illustrate this with examples from B&R's paper. A human being reaches satisfaction (relaxation of frustration) upon success in lighting a stick dipped in kerosene. The orangutan in B&R's study achieved satisfaction when human bystanders burst out in laughter, because she failed to light a stick dipped in kerosene despite astute aping (sect. 2.1). Failing to ignite the stick here is a part of the ape's successful strategy (pace B&R: "despite failure to execute the entire program of fire-making effectively" (sect. 2.6, para. 12) as her satisfaction resulted from the laughter, the fire-making being foreign to her monkey business.

This is similar to the other example of orangutan behaviour,

where satisfaction was not obtained from successfully washing clothes (apes wear no clothes) but from having the "staff obligingly shriek" and jump into the water (sect. 2.6, para. 6). B&R's choice of the word "obligingly" betrays their clear awareness that the ape is not seeking satisfaction through washing clothes but through interacting with the humans on the scene. The fact that once the staff was in the water the orangutan diligently went about washing the clothes is not a problem: it is a perfect example of *stimulus enhancement*, defined by B&R as "the tendency to pay attention to, or aim responses toward, a particular place or objects in the environment after observing a conspecific's [here human being's] actions at that place or in conjunction with those objects" (sect. 1.2, para. 1).

Such "relaxation" of frustration that leads to satisfaction can occur with any technique – or any combination of techniques – known to the individual, from on-the-spot invention to the reproduction of recorded sequences of *action-level imitation*. There is but one principle at work here: the frustration/satisfaction gradient. At each stage of gradient descent the individual proceeds downward from the current point in potentiality space so as to maximise the rate of frustration reduction. In visual terms, the choice at every local point attained is the path offering the steepest slope.

This model has very general applicability. In particular, it explains away a number of anomalies that B&R mention.

1. *Action-level imitation* is intrinsically comical to any on-looker; that is, it has high "social interaction satisfaction potential" and is used to this end by great apes in their interaction with humans. This feature of *action-level imitation* does not rule out its serving as a possible component in a problem-solving strategy. It does, however, rule out anything such as "copying the behaviour for its own sake" (sect. 2.6, para. 1): imitation is in every instance a strategy for attaining some satisfaction, either instrumental or social.

2. In discussing Abranavel and Gingold's (1985) bathing a teddy bear task, B&R remind us that "any actions unrelated to the job at hand tended to be missed in the children's imitations" (sect. 2.4, para. 6). These unrelated actions do not contribute to satisfaction (frustration reduction) and are consequently left out of the sequential acts that lead to lower frustration.

3. More important, there is no need to devise a theory that explains how memory must "keep track of where to return . . . as the problem is 'unpacked' into component subgoals" (sect. 2.2, para. 9) as satisfaction is reached through gradient descent. *Sub-goal* imputation is a post hoc reading of the descent path. Alleged subgoals single out singularities in the potentiality space landscape where slopes are at their gentlest.

### Using programs to solve problems: Imitation versus insight

Stan A. Kuczaj II,<sup>a</sup> John D. Gory,<sup>b</sup> and Mark J. Xitco, Jr.<sup>c</sup>

<sup>a</sup>Department of Psychology, University of Southern Mississippi, Hattiesburg, MS 39402; and <sup>b</sup>The Living Seas, EPCOT Center, Lake Buena Vista, FL 32830; <sup>c</sup>Space and Naval Warfare Systems, Code D351, San Diego, CA 92152-6506 skuczaj@ocean.otr.usm.edu Dauphigny@aol.com xitco@nosc.mil

**Abstract:** Dolphins exhibit both action-level imitation (ALI) and program-level imitation (PLI). Dolphins may use ALI primarily for social cohesion, whereas PLI seems more likely to occur in goal-directed, problem-solving contexts. Both PLI and insightful problem solving require a recognition of the functional relations between actions and outcomes. Insightful problem solving, however, involves the creation of a program in the absence of a model, and therefore requires a higher order appreciation and application of the relations between actions and outcomes.

Our work with dolphins supports the distinction between action-level imitation (ALI) and program-level imitation (PLI) advanced

by Byrne & Russon (B&R). Dolphins can be trained to imitate novel behaviors at the action level (Xitco 1988), but we do not know the extent to which they imitate spontaneously at the action level. Observations of captive and wild dolphins suggest that dolphins do engage in spontaneous ALI. If the primary function of ALI is social facilitation, as B&R suggest, then ALI may play an important role in developing and maintaining dolphin social relations.

Dolphins may also be capable of PLI. In our work at the Living Seas in EPCOT Center, dolphins are often presented with problem-solving situations that require the use of tools. One of the tools used by the dolphins consists of a weighted plastic cylinder with an attached carrying ring. This tool can be dropped into otherwise inaccessible mechanisms, which in turn causes the release of visible but otherwise unattainable food. Dolphins are not familiar with manipulating objects, and therefore had to learn to pick up the tool and to drop it into a bucket. After the dolphins had learned to manipulate the tool, they observed a human using the tool to obtain food. The human model picked up the tool with his hand, and then swam with his arm extended (thus clearly holding the tool) to a tool site. The human then dropped the tool into the tool site, releasing the fish. The dolphins soon began to pick up the weight with their rostrums and try to drop it into the tool site, eventually becoming quite proficient at doing so. The bucket with which the dolphins were taught to use the weight tool was quite different in appearance from the tool site. Therefore, the dolphins were not simply repeating a previously learned behavioral routine. Lacking hands, they could not imitate the exact actions of the human; instead they used another behavior to mimic the functional use of the tool. Although this is not as complex as the examples described by B&R, we believe the dolphins identified both the problem to be solved (releasing visible fish from a container) and the solution by observing a model solve the problem. To us, this is the crux of PLI: identifying both the problems to be solved and their possible solutions by watching others. We are presently exploring dolphins' ability to imitate more complex solutions, which will allow us to better test their capacity for PLI. If dolphins are in fact capable of ALI and PLI, perhaps the ability to learn from observing others reflects a continuum, the two endpoints being anchored by action-level and program-level behaviors. In this view, ALI demonstrates a simple capacity for imitation, whereas PLI demonstrates a capacity to comprehend complex relationships.

Assuming that PLI involves the identification of a problem and at least one possible solution via observational learning, it is still unclear exactly how much of the program must be observed for learning to occur. If the primary goal of PLI is to acquire some new technique for dealing with the world, perhaps the most important observation involves the behavioral goal. Witnessing a conspecific achieve some desired outcome, such as using a weight to release otherwise unattainable food or eating nettle without getting stung, may identify a goal that the observer would not otherwise recognize. After the goal has been identified, the problem of how to achieve it remains. One possible way to achieve the goal is to mimic exactly the behaviors of the model who has successfully attained it. As B&R note, such exact imitations are rare.

Another possibility is for the observer to determine a behavioral plan that it then attempts to put into action. The extent to which this plan matches the model probably depends on three things: (1) the extent to which each feature of the model's behavior could be accurately observed, (2) the ability of the observer to faithfully represent and later reproduce the observed behaviors, and (3) the ability of the observer both to vary its behavior and to understand the effects of such variation. It is also possible that members of some species need only witness the attainment of the goal to understand that there is something worth pursuing. In such cases, the observer would not imitate a behavioral plan, but witnessing the goal would be the impetus for the observer's subsequent attempts to attain it.

We are suggesting that the ability to operate at the program

level has implications for forms of problem solving other than imitation. Understanding a program involves understanding the relations that hold among specific types of actions and outcomes. In the case of imitation, the observer must recognize the program in the model's behavior, and then attempt to reproduce the relationships (even if the specific behaviors are not exactly reproduced). In the case of problems that require insightful planning with no model, the individual must apprehend both the causal and the spatiotemporal structure of the problem and then create a problem-solving program. Although PLI ability does not necessarily imply a capacity for insightful planning, animals that engage in PLI may also prove to be capable of insightful problem solving, particularly if they are known not to require witnessing the entire program to achieve the observed goal.

## Imitation without attitudes

Eoghan Mac Aogáin

Linguistics Institute of Ireland, Dublin 2, Ireland. eoghan@ite.ie www.ite.ie

**Abstract:** Byrne & Russon's account of program imitation in primates involves propositional attitudes (expectations and goals), which limits its falsifiability. Yet their account of priming shows exactly how imitation without attitudes would look. The challenge is to upgrade the notion of priming to give an account of low-level program imitation without invoking propositional attitudes.

**Expectations and goals.** The difficulty I have with Byrne & Russon's (B&R's) target article is its intermittent reliance on old-style mentalism, something it shares with Miller et al. (1960), the work of Piaget (1937/1960), and other attempts to use hierarchies to describe intelligent behaviour. The trouble with hierarchies is that they are just lists with brackets. To become models of behaviour they need a backdrop of free-floating intelligence. This is what B&R describe as "the ability to build hierarchical structures" (sect. 1.1, para. 3), or the animal's having "access to the hierarchical structure of their own behaviour, and control over its organisation" (sect. 2.1, para. 3) or "an intelligent ability to operate with task structure and hierarchical organisation of behaviour" (sect. 2.4, para. 5). Thus, B&R immediately set aside "rigid" hierarchies that just run off in response to current stimulation, external and internal (sect. 2.1, para. 3). They are interested only in the variety that is "accessible" to the organism, under "voluntary control," "constructed," "manipulated," and so on. Hierarchies, in other words, that assume the existence of expectations and goals.

Where are the expectations and goals in B&R's account? They are behaviours described as pulling down a bunch of stems, picking out the green ones, or folding in the loose ones (Fig. 1). These are not just actions in B&R's special sense, or mere movements. They are actions in the ordinary sense, things done in the expectation that they will bring about a desired result. I will call these actions intentional in the ordinary sense, and in the technical sense that has come down to us from Brentano (1874/1960).

Expectations are needed to keep behavioural loops going, especially if results are slow in coming; furthermore, goals are needed to ensure that the desired result remains fixed throughout, despite diversions. We must assume the existence of states of affairs that are, in one case, expected, and in the other, desired. These are "propositional attitudes" (Mac Aogáin 1986). Hierarchies come free of charge. The minimum of intelligence that is required to sustain the attribution of attitudes already implies persistence and embedding; that is, B&R's "iterative repetition of a subroutine" and some capacity to "handle optional operations" to ensure they do not interfere with the main one (sect. 2, para. 5). Without them we cannot make attributions such as "pulling down the stems." Conversely, if we do, we join Brentano and adopt what Dennett (1996) calls the "intentional stance."

**Stance switching.** Compare this with priming and action-level

imitation in B&R's sense of "action." Expectations and goals are not implied. Representation and a generalised notion of activation will suffice. The stance here is still intentional, because representation is necessary, but attitudes are not needed, only activation. I will call this the "nonattitudinal stance," contrasting it with the attitudinal or fully intentional one.

How could a primate learn to prepare food by imitating handshapes and arm movements? It is impossible. The stance has been switched in mid-question from attitudinal to nonattitudinal. How could a child learn phonemes by copying "physical sounds," as a tape recorder does (sect. 3, para. 7). Again it is impossible. Phonetic and acoustic stances have been switched, this time well below the intentional level. B&R suggest that the discovery of family handshapes in gorilla food preparation would have invalidated the hierarchical account (sect. 2.4, para. 1). This is surely not the case, any more than local accents invalidate hierarchical models of word acquisition. The hierarchical account is a stance, not a hypothesis. By adopting it we do not falsify the account that is nonattitudinal, linear, associative, and so on – and vice versa.

**The challenge.** The strange thing about all of this is that B&R appear to be aware of it. They wonder whether they may have unwittingly made program-level imitation the only variety that is observable in principle, and they refer jokingly to the imitation of muscle twitches (sect. 2.4, para. 5). They go on to suggest that program-level imitation may not be all that mysterious in the end, presenting it in Figure 5 as a continuous flow of activation through a sequence of required states. Such a stance is always possible. To take it we need only decline to take the intentional one.

More important, B&R have done all the groundwork necessary for the eventual removal of attitudes from imitation. This is in the early part of the target article, when they partial out priming phenomena from imitation in a stronger sense (sect. 1.5). As a result, we get a fine account of intelligent behaviour that is just beyond the reach of the nonattitudinal account. The distinctive limitations of primate intelligence show up elegantly in the form of task hierarchies that are flat and brittle. However, it is clear that intelligence of this modest variety has often been overlooked in primate research because its structure has not been properly understood.

The challenge is now to extend the notion of priming into this domain. The fact that action-level imitation cannot be "easily recruited" into program-level imitation (sect. 2.6, last sentence) is no obstacle. We are still entitled to adopt the nonattitudinal stance, in the same way that we try to model cognition using associative and connectionist paradigms. We can talk about joint and multiple priming of representations. I believe this would account for limited forms of program-level imitation in strongly supportive environments. It would also provide the baseline from which to predict the conditions under which program-level imitation will fail – a topic on which the target article is particularly rich in observation and hypothesis.

## Imitation is not the "Holy Grail" of comparative cognition

M. D. Matheson and D. M. Fragaszy

Psychology Department, University of Georgia, Athens, GA 30602.  
matheson@uga.cc.uga.edu doree@arches.uga.edu

**Abstract:** We commend Byrne & Russon for their effort to expand and clarify the concept of imitation by addressing the various levels of behavior organization at which it could occur. We are concerned, however, first about the ambiguity with which these levels are defined and second about whether there is any particular need for comparative cognition to keep focusing on imitation as an important intellectual faculty. We recommend stricter definitions of hierarchical behavioral levels that will lend them-

selves to operational definitions and continued study of how animal subjects organize their goal-directed behavior as opposed to whether it is or is not imitation.

Byrne & Russon (B&R) (1) set up a heuristic distinction between organization (program-level) and form (action-level) copying and (2) argue that program-level copying depends on the ability to build hierarchical structures of actions. A third, implicit goal seems to be to demonstrate that all great apes (as opposed to just chimpanzees) are capable of imitation. We applaud B&R's attempt to expand the concept of imitation by pointing out that it can go beyond the rote copying of specific actions. We also agree that great ape behavior can be hierarchically organized and is often quite sophisticated. We do have misgivings about B&R's conceptual approach, however, for two reasons. First, program-level imitation, as B&R have defined it, is nearly impossible to define operationally; thus, their theory may be heuristic but it is not testable. Second, B&R have not made it clear how imitation per se reflects anything important about a species' cognitive functioning. That it does indicate special cognitive faculties has been assumed by the research community in recent times; however, B&R's formulation of it is sufficiently different to warrant a re-examination of this idea.

We agree that imitation should be viewed as more than rigid reproduction of specific muscle movement, but some limits must be placed on behavioral categories to allow for a meaningful analysis. In their discussion of the hierarchical structure of gorilla feeding techniques, B&R state that similarity of structure becomes evident at "coarser levels" of analysis. However, they fail to specify how to identify the appropriate unit of behavior for analysis, thus leaving the door open for behavior that is similar on any level to be admitted as an example of program-level imitation. For example, if an individual moves into a tree where another is feeding and begins to eat using the same processing methods (pick, peel, chew, swallow), could this not be called program-level copying, as currently defined? In addition, B&R's admission of copying "relational manipulations" (e.g., an orangutan rocking water out of boat; an orangutan's "pouring program"; sect. 2.6, para. 4) as examples of program-level imitation seems to blur their original distinction, according to which program-level imitation involves "copying the structural organization of a complex process (including the sequence of stages, subroutine structure, and bimanual coordination"; sect. 2.4, para. 3), whereas action-level imitation involves copying the specific details of the actions. Here the problem is distinguishing between the two forms of imitation. To collect evidence for B&R's theory, we need stricter definitions of program-level and action-level copying that can be operationally defined and distinguished.

B&R suggest that action-level copying without program-level copying implies a lack of intelligence (apparently in the sense of adaptive flexibility). Conversely, program-level copying without action-level copying implies intelligence because it demonstrates both hierarchical control of behavior and the ability to modify lower units in the service of goal. Whereas the ability to organize voluntary behavior hierarchically could arguably indicate sophisticated intelligence, it is not clear why the imitation of a hierarchical structure adds anything to this analysis. Moreover, if action-level copying, the form of imitation usually sought by the research community, is less demanding intellectually, it is unclear why any kind of imitation is still a subject worthy of study from a cognitive perspective.

In B&R's impressive example of hierarchically organized behavior (i.e., gorilla feeding programs), it is unclear whether imitation is involved at all. They state that the strategy used by the gorillas is the most efficient one, in an area where feeding inefficiency comes at a high price. Given the strong pressure this would exert, we do not find it surprising that the apes might hit on the same form of behavior through individual learning. No mention of any kind of social process is made, much less imitation specifically.

Conversely, in the examples of orangutan behavior, it is the rote imitation of specific actions that convinces us that imitation is occurring, even if these actions were sometimes less skilled versions of the modelled behavior. Although the orangutans showed evidence of hierarchically structured behavioral sequences, B&R note that these sequences were probably self-generated (e.g., humans generally do not have to scare others away from laundry facilities, so this behavior was probably never modeled for the orangutan). Thus, rather than copying a program and showing modifiability of action units, the orangutans seemed to copy action units and create new, perhaps modifiable sequences. This may be sophisticated behavior, but it does not fit easily into B&R's framework.

B&R argue that some of the orangutans' action units were modified (e.g., the washing sequence), which seems to constitute a state of modifiable action *and* modifiable program. If so, then we need only invoke emulation, in the sense of adopting another's goal (e.g., do laundry, by whatever means). B&R discuss emulation with reference to Tomasello et al.'s (1987) chimpanzee data, which were originally interpreted as goal emulation. B&R reinterpret Tomasello et al.'s data as program-level imitation, apparently based on the chimpanzees' knowing before the demonstration that a stick could be used as a rake. We are confused about this distinction between emulation and program-level imitation that B&R appear to be drawing.

Imitation has in recent times seemed to be a "Holy Grail" of comparative cognition – something highly valued and dearly sought. However, this pursuit exists because of what imitation has been argued to represent: a particular, rare, and evolutionarily important aspect of intelligence. We agree with B&R that this emphasis may have been misplaced: rote imitation may not represent anything particularly important about broad intelligence. We agree that a broader concept of imitation is needed to encompass observed phenomena. On the other hand, we hesitate to accord program-level imitation the status accorded by some to action-level copying. A more fruitful approach may be to focus on the creative aspects of acquiring behavior, which is likely to involve some dynamic mix of problem solving and copying. It is precisely this mixture that makes the rehabilitant orangutans' behavior so intriguing. Rather than trying to categorize and label what seems to be heterogenous behavior, it would be better to study the process of acquiring and executing such sophisticated behavior. Thus, we encourage continued observational studies of the kind highlighted in B&R's target article, guided heuristically by an expanded concept of imitation, but equally attentive to other processes that function to organize behavior in the service of a goal.

## High-level social learning in apes: Imitation or observation-assisted planning?

Peter E. Midford

Zoology Department, University of Wisconsin – Madison, Madison, WI  
53706. [pmidford@mac.wisc.edu](mailto:pmidford@mac.wisc.edu)  
[www.wisc.edu/zoology/grads/petere.htm](http://www.wisc.edu/zoology/grads/petere.htm)

**Abstract:** Byrne & Russon's notion of program-level imitation is based on the ability of apes to plan novel sequences of behavior and on how information gleaned by observation can aid the planning process. Byrne & Russon would have made a stronger case by focusing on social learning and planning and expending less effort interpreting their results as a new category of imitation.

Byrne & Russon's (B&R's) target article represents a long overdue attempt to bring cognitive theory to the question of imitation in animals. The authors provide a constructive alternative to the notion that budgerigars (Dawson & Foss 1965; Galef 1986) and rats (Heyes et al. 1992) can imitate in ways that apes cannot. Despite the reasonable desire to demonstrate that apes can imitate in a

better way than rats, the idea B&R develop may be more appropriately called *observation-driven planning*. Unfortunately, the authors' focus on imitation and on the issue of whether apes can construct novel sequences of actions (i.e., whether they can plan) distracts from the important issue of how observation aids planning. What coverage that B&R do give to the contribution of observation suggests their focus on imitation has clouded their understanding of what kinds of information are required for constructing plans.

B&R provide data from three species of great apes to support their notion of program-level imitation. Although they describe at length the hierarchical structure of food processing by mountain gorillas, the treatment succeeds in showing only that the structure is hierarchical. B&R's argument for the presence of voluntary re-ordering stumbles twice. First, "test-operate-test-exit" loops are not evidence of voluntary control, even in a hierarchical context. Such loops, embedded in a complex hierarchy of actions, are found in invertebrates such as the digger wasp *Sphex ichneumonius* (Brockmann 1980). Second, B&R make the curious claim that hierarchical structures avoid problems with shared structures to which linear orderings of actions are subject. This very confusion of shared structures in hierarchical organizations of actions is the basis for Schank's (1982) theory of reminding in humans. Hence the reported absence of such errors during feeding says nothing about gorillas' representation of actions.

B&R provide no direct evidence that gorillas either learn through imitation or plan a series of actions to process their food. Although the authors report that gorillas use the same ordering of "high level" actions in processing a particular food type, such homogeneity of ordering provides only circumstantial evidence for the operation of any type of social learning, imitation or otherwise. The production system depicted in Figure 4 only weakens their case. Selecting actions on the basis of a set of rules does not constitute planning; such rule sets are, at best, the "compiled" outcome of past planning.

The orangutan and chimpanzee data provide more insight into planning and observational learning capabilities, respectively. Both sets of data also raise directly the question of what information the observing animals might be acquiring from the demonstration. The first and third orangutan examples (from the same animal) demonstrate plan synthesis using both goal decomposition (third example) and the construction of a plan from multiple subplans (first example). To B&R, the chimpanzee results suggest that a "use as tool," or affordance (I assume this term is used in the sense of Gibson 1979), of the rake has been learned. The second orangutan example suggests an incomplete understanding of the goal structure of the weeding task (the animal having missed the "straight edges" subgoal), as well as a misunderstanding of the use of the hoe as a tool.

B&R interpret the results to suggest that the chimpanzees had learned to use a particular object as a tool. According to the authors, learning about an object as a tool means learning a relation between food and the tool, rather than simply being primed to the goal of attaining food. Alternatively, learning a new way to use a tool could be seen as the animal's acquiring a new operator (action) for use in planning. Each of the orangutan examples has elements that suggest the learning of affordances provided by objects: canoes, hoes (imperfectly), and kerosene. Although no gorilla data are presented on learning of such novel operators, those animals may have learned an appropriate decomposition of the overall goal into subgoals and a valid ordering of the subgoals. Finally, the orangutan's attempts at fire-making may be, as B&R suggest, a set of attempted solutions based on different conjunctions of subgoals (heat and wood, wood and kerosene, etc.). Alternatively, the orangutan may simply have been bringing objects together, without any inkling of the preconditions for starting a fire.

By recasting B&R's program-level imitation idea as planning assisted by observational learning, I have suggested three specific types of information that animals capable of planning might ac-



quire by observation. Focusing on planning also weakens the claim that these data should be called imitation. Because B&R take pains to distinguish program-level from action-level imitation, and because the nontechnical meaning of imitation is closer to what B&R call action-level imitation, there is no clear reason to include the former as a type of imitation.

On the basis of what is currently known of the phylogenetic distribution of action-level imitation, such imitation is at best a homoplasy and at worst an artifact of the procedures used to establish it. This assessment holds whether or not apes are definitively shown to exhibit this imitation. As such, action-level imitation should claim no special interest as an indicator of cognitive complexity or evidence of behavioral continuity between animals and humans.

## In the search for the functional homology of human imitation: Take play seriously!

Ádám Miklósi

Department of Ethology, Eötvös University, Göd, H-2131 Hungary.  
miklosa@ludens.elte.hu

**Abstract:** I will argue that we cannot understand imitation unless we know more about its function. By comparing the two examples presented by Byrne & Russon I show how the imitative behaviour of orangutans can be interpreted as a homologue of human imitation during play. In contrast, the lack of data leave the role of imitation in gorillas doubtful.

Byrne & Russon (B&R) present a new approach to imitation at a descriptive level. The hierarchical notion of imitation might be welcomed by ape researchers because describing the behaviour of these animals in terms of simple motor acts is difficult, but by no means impossible, as demonstrated by recent studies on marmosets (Bugnyar & Huber 1997) and chimpanzees (Whiten et al. 1996).

A long line of ethological research, however, shows that it is often very difficult to recognize a pattern of a complex behaviour if one does not think of a biologically significant function for it. There are currently two general directions in the study of animal imitation. (1) The mechanism of imitation is investigated as a particular component of general learning ability. Laboratory studies exchange yesterday's "animate conditioned stimuli" for today's live animal "demonstrator." Various more or less social species are used in these studies (e.g., rats, Heyes 1994; Heyes & Dawson 1990; parrots, Moore 1992; quails, Akins & Zentall 1996; budgerigars, Dawson & Foss 1965). (2) Others are interested in cognitive or mental aspects of imitation, investigating imitation in apes as a behavioural homology of human imitation. The copying ability of nonhuman primates and humans is investigated in the context of tool use (e.g., Call & Tomasello 1995; Hayes & Hayes 1952; Tomasello et al. 1987) or other arbitrary tasks (e.g., Custance et al. 1996).

Both lines of animal imitation research, however, started from a very simplified view of animal learning and human imitation, which led to the "chaos" we are facing today. The traditional view of human imitation was that this skill is advantageous for transferring information from one generation to the next for behaviours that require special skills, for example, food processing or tool use. Recent developments in human imitation, however, suggest that imitation in humans is not a one-way process in which an observer surreptitiously copies the behaviour of the model. Infants as young as 9 months old not only imitate the behaviour of the model but are also able to recognize when they are being imitated (at least at 14 months of age; Meltzoff 1988c; 1990). Moreover, they show a clear preference for the person who is copying them. In human models, mothers do not just perform the behaviour but also encourage the infant and initiate imitation (Moran et al. 1987). Human models perform socially rewarding behaviours if the observer

shows signs of trying to imitate. Human imitation is an interactive social phenomenon that is presumably advantageous for both parties in a functional sense. This kind of imitation is particularly useful in prelinguistic communication and social understanding (Gopnik & Meltzoff 1995; Uzgiris 1981).

B&R's two sets of examples differ in several respects. The imitational interpretation of food processing in the gorilla seems to belong to the traditional view of imitation. Unfortunately, there is not enough data in the literature to judge the role of imitation in this complex task. For example, it is not clear how long infant gorillas have been learning this task, and a large number of processes can interfere with an extended period of learning. Moreover, most observers have denied that imitation plays a role in the nut-cracking behaviour (e.g., Inoue-Nakamura & Matsuzawa 1997) that is in several respects very similar to the food preparation behaviour in gorillas, which seems to "cry out" for imitative learning!

The examples of imitative behaviour in orangutans are very different however. Based on recent data (Russon & Galdikas 1993; 1995), we can estimate the number of demonstrations and enactments and the time interval between the action(s) of the model and the reenactment of the observer that is crucial to understanding imitation. Speculating about the "purpose" of the imitation observed, Russon (1996) found no rational explanation. Interestingly, Köhler (1927) made very similar observations on his chimpanzees some 70 years ago and interpreted them as play. With some exceptions (Brunner 1972), this view of imitation has not received serious attention, yet it seems to be a very powerful way of explaining the behaviour of the orangutans. Play might be interpreted as a form of adaptive transformation or functional repetition of other behaviours (Fagen 1981). [See also Smith: "Does Play Matter?" BBS 5(1) 1982.] In some species, play may serve to develop, practice, or maintain cognitive abilities and social relationships. The behaviour observed during play might be similar to the behaviour observed in a functional context later in life (Fagen 1981). The sequence of acts might be different and repetition might occur more often. Play is itself rewarding, hence there is no need for extrinsic reward. There is now evidence that human infants learn about basic properties of objects during exploratory play (Baldwin et al. 1993) and are able to generalise the imitation of a demonstrated behaviour to similar objects (Barnat et al. 1996).

It is not difficult to see how the behaviour of the orangutans fulfills the criteria for play behaviour. As noted by Russon (1996), no specific learning takes place as a result of this type of imitation; orangutans might "merely" be practicing their skills in dealing with objects. If one takes exploratory play as a functional explanation seriously, it follows that:

(1) Imitation would be rare, both in wild and laboratory animals, because (a) the observed animal needs to be in a playful "mood" and (b) it must observe an action that is neither too easy nor too difficult to copy.

(2) During playful imitation there is no need for a precise reproduction of the model's behaviour; even different objects can be used for imitation.

(3) The tendency to repeat the act should decrease after successful reproduction.

(4) More familiar animals are better models.

(5) Imitation cannot be elicited merely by reintroducing the context of the demonstration.

(6) The presence of direct extrinsic rewards inhibits imitation.

(7) An animal is more likely to imitate a new, complex task if it has already had the experience of copying similar, less complex tasks.

On the basis of this schema one can also design planned observations. As in the case of human infants, it might be useful to incorporate demonstrations in the context of play. Deliberate acts with or without objects by demonstrators with different relationships to the observers should reveal the nature of play in imitation. Imitation will not be understood until we understand its function,

for the homologue of human imitation might best be found in animal play.

#### ACKNOWLEDGMENTS

This research is supported by the OTKA Foundation (Hungary).

## Great apes imitate actions of others and effects of others' actions

Robert W. Mitchell

Department of Psychology, Eastern Kentucky University, Richmond, KY 40475. [psymitch@acs.uky.edu](mailto:psymitch@acs.uky.edu)

**Abstract:** Apes imitate the effects of others' actions, but the evidence for program-level imitation seems contradictory and the evidence against bodily imitation and trial and error in learning the organization of complex activities seems ambiguous. Action-level imitations are more flexible than described and may derive from imitation of the effects of others' actions on objects.

That great apes and humans can plan actions, understand the goals of others (or parts of them), and use them as their own is well known. Byrne & Russon (B&R) provide further evidence of these abilities in apes and label their confluence *program-level imitation*. However, their evidence seems contradictory. As evidence for program-level imitation in gorillas, B&R note that subprocesses of food extraction that have the same aims are *not* identical between mother and offspring, but that the organization of these subprocesses is *consistent* between them and that the development of such organizational similarity between mother and offspring by chance or trial and error is unbelievable (though no developmental evidence is provided). As evidence for program-level imitation in orangutans, B&R note that subprocesses of obtaining a goal, when these have the same subgoals, are usually the *same* between humans and orangutans, but that the organization of these subprocesses is *inconsistent* between them, and that trial and error marks the developmental origin of the organizational similarity between them. Whereas the ordering of behaviors with the same global aim is essential for program-level imitation in gorillas, it is irrelevant to program-level imitation in orangutans. Although trial and error is obviously present in the development of the sequences in object use by orangutans, it is presumed unlikely in the development of the sequence of food extraction by gorillas. Contrary to this last idea, Fossey (1979) noted that during their second year mountain gorillas make "awkward attempts at preparation such as stripping leaves from central stalks or wadding of vines" (p. 150) that are suggestive of trial and error. Oddly, whereas B&R state that other gorillas were intolerant of the infant while feeding, so that the mother or silverback were the only potential models, Fossey (1979) noted that the "methods involved in [food] preparation were learned and imitated from the examples of older peers and/or siblings" (p. 172).

B&R take orangutans' remarkable replications of others' uses of objects (often as tools) to be relational manipulations and hence program-level imitations; they do not take them to be action-level imitations because they do not replicate "specific motor actions" (sect. 2.6, para. 1). Unfortunately, how orangutans performed these actions using different motor actions is not always explicated and one suspects from the descriptions that the orangutans' relational actions were often remarkably similar to the human motor actions. Such similarities could be the result of attempting the same goals, but may in turn depend on recognizing similarities between one's own and another's actions. The fact that when subgoals are identical, motor actions sometimes differ between species (or generations) need not be evidence of program-level imitation: it may arise from the animal's understanding of the other's goal. An orangutan may chop weeds (imitatively) as well as pull them (nonimitatively); the desire to reproduce an important

aspect of the human's goals is present in both cases, but the same means are used only in the first case. To say that this orangutan imitated the overall weeding program because she first removed weeds and then piled them is inadequate, because she could not have done the reverse. Understanding goals, along with the ability to plan one's actions, leads to organizations of action.

B&R claim that *action-level imitation*, described as exact replication of another's motor movements or vocal sounds, is largely unobserved in skill learning in great apes and young humans. However, action-level imitation can clearly be more flexible than B&R's characterization suggests. Having spent much time with a 2.5-year-old who imitates parts of his brother's speech, often with no apparent comprehension but with much delight and numerous phonological errors, I find this child's behavior indicative of imprecise action-level imitation; labeling the child's vocalizations "program-level imitation" is inaccurate, because important words and sounds are dropped. Although B&R note that 16-month-old children tended to imitate only those actions that were causally related to the goal, this need not indicate that they were *imitating* the organization of the actions. Rather, the action sequence made sense because of the understanding of the goal, and thus actual *imitation* of organization was less essential. Children are, after all, smart, just like many apes.

B&R's focus on the imitation of actions with objects (either food or tools) in every instance of program-level imitation is intriguing in that Guillaume (1926/1971) initially posited that the human infant's recognition of the similarity between its own actions and those of others (which would lead to flexible bodily imitation) derives from initially attempting to recreate the objective effects of another's actions on objects, and only later trying to reproduce the movements that led to the effects. Gradually, through imitation of effects, in which the visual (objective) stimuli of the model become a cue for the production of the same act by the child, the subjective kinesthetic feeling of the child's act is associated with the model's act; the ability to imitate others' bodily actions results. Perhaps flexible action-level imitation, which seems so cognitively simple to B&R, is a skill derived from the imitation of object use so prevalent in apes and humans (see Miles et al. 1996; Mitchell 1994).

## The neural basis of Imitative behavior: Parietal actions and frontal programs

Naoyasu Motomura

Department of Health Science, Osaka Kyoiku University, Osaka 582, Japan.  
[motomura@cc.osaka-kyoiku.ac.jp](mailto:motomura@cc.osaka-kyoiku.ac.jp)

**Abstract:** Byrne & Russon suggest that there are two kinds of imitation learning – action level and program level – and that the latter is critical for great apes' learning. I have interpreted this phenomenon from the standpoint of clinical neuropsychology and conjecture that action-level imitation might be related to parietal lobe function and program-level imitation might be related to frontal lobe function.

Byrne & Russon (B&R) report that there are at least two types of learning by imitation: action level (a detailed and linear specification of the sequential act) and program level (a broader description of subroutine structure and the hierarchical layout of a behavioral program). B&R emphasize, on the basis of observations of great apes, that program-level imitation is critical for learning. This inference is highly attractive, but it lacks a neuroanatomical and neuropsychological basis. The authors might reconsider it in the light of the evidence from experimental and clinical neuropsychology.

First, we should distinguish the kinds of movements involved in imitation learning. Disturbances of imitation are well known in patients with brain damage and are called *ideomotor apraxia*, *ideational apraxia*, or *constructional apraxia*. The definition and

the classification of these clinical conditions is still controversial but the imitation and learning of movements may well be likewise disturbed in these conditions. There are at least three types of imitative movements: imitation of real objects, imitation of meaningful movements, and imitation of meaningless movements. Although based on brain damage data, this taxonomy also may be very useful for the analysis of imitation in great apes.

There is evidence that only a few neurons fire when a monkey uses real tools (Taira et al. 1900). In monkeys one might speculate that the miming of tool use is regulated by a separate class of neurons. In humans there is clinical data for dissociating the manipulation of real objects and imitation without real objects (Motomura & Yamadori 1994). This evidence suggests that in the case of the great apes we had better distinguish three types of movements: movements using objects, meaningful movements without using objects, and meaningless movements. The critical brain area for these forms of imitation in both animals and humans is thought to be the parietal lobe. One might expect disturbances in B&R's action level to be related to parietal function, because their corresponding apraxic disturbances tend to occur after parietal lobe damage.

There are data on the neural bases of the more programmed and complex imitative behaviors. After damage to the frontal lobe, the inhibition of programmed imitation is damaged. Di Pellegrino et al. (1992) found a group of neurons in the prefrontal area of monkeys that fires during the imitation of the complex behaviors. Hence program-level imitation might be based on frontal lobe function and action-level imitation on parietal lobe function. Program-level imitation is thought to be closely related to intelligence, particularly Machiavellian intelligence, which concerns social relationships; this, too, deserves further investigation.

## Mechanisms of imitation: The relabeled story

Herbert L. Roitblat

Department of Psychology, University of Hawaii, Honolulu, HI 96822.  
roitblat@hawaii.edu

**Abstract:** Byrne & Russon propose an account of imitation that mirrors levels of behavioral organization, but they perpetuate a tendency to dismiss imitation by members of most species as the result of more primitive processes, even though these alternative phenomena are often poorly understood. They argue that the prerequisites to program-level imitation are present in great apes, but the same prerequisites appear to be present in a broad range of species. The distribution of imitative capacity across species may be more limited by research methodology than by cognitive ability.

Byrne & Russon (B&R) propose a very useful distinction among levels of imitation, one that mirrors levels of behavioral organization, but their proposal does not go far enough toward identifying the mechanisms of putative imitation or their role in behavior. Along with many of the other approaches to imitation, it sets the wrong standards for a behavior to be considered an example of imitation.

Two lizards meet on a sunny rock wall. One of them extends his bright orange dewlap and appears to do push-ups, raising and lowering the front half of his body while facing the other lizard. After a few seconds, the second lizard begins to perform the same action sequence. Although the behavior of the second lizard closely resembles that of the first, it does not seem appropriate to call this an example of imitation, because it is a territorial display and is unlikely to have been learned by the second lizard during this episode. Any definition of imitation must be able to correctly reject this display, but it must not reject other behaviors that are actual examples of imitation. This demarcation criterion is the primary issue in imitation research. I will argue that the criterion has

been set to reject all examples of imitation as well as behaviors that should probably not be considered imitative.

Many counterproposals seek to explain what looks like imitation by appeal to some other capacity. These counterproposals are not unique to B&R, so it is perhaps unfair to make them take responsibility for them. In each case, a putative example of imitation is explained away by some other, presumably more primitive, phenomenon, but the variety of alternative phenomena results in a confusing, incoherent morass of alternative explanations. Moreover, these alternative phenomena are often poorly understood. Their validity relies on implicit mechanisms that have not been adequately demonstrated and that predict other phenomena that are themselves problematic. These alternatives appeal on the one hand to discredited learning mechanisms and on the other to cognitive mechanisms that have not been investigated in animals, let alone established, or established as more parsimonious explanations of behavior.

For example, many of the explanatory alternatives to imitation are derived from so-called *simple associative learning*, but this notion is often a relabeling rather than an alternative explanation. So-called simple associative learning is not actually so simple (Roitblat & von Fersen 1992). Stimulus enhancement is one of these alternative explanations; but so far as I am aware, it has never been studied in its own right. It is a labeled phenomenon, but I know of no reason why it should be accepted as an established counter-explanation. The basic idea (target article sect. 1.2) is that the behavior of one organism draws the attention of a conspecific toward the object on which the organism is performing, especially if the model is obtaining a reward for this behavior. First, attention, although it certainly must exist in animals, is a phenomenon that requires explanation. Second, the notion of directing attention implies the presence of other cognitive skills, such as shared gaze control and pointing. Although these phenomena occur in at least some primates (e.g., Povinelli & Eddy 1996), so far as I know they are unknown in many of the species for which stimulus enhancement has been offered as an explanation. My point is not that phenomena such as stimulus enhancement cannot exist but that they are themselves problematic. Toward the other end of the behavioral spectrum, priming is also proposed as an alternative mechanism to imitation. Apparent cases of imitation might be simply described as priming; but this description is not an explanation. Priming has not been demonstrated in animals, and in the absence of such a demonstration, this alternative explanation is nothing more than a "just-so" story.

Emulation, another proposed alternative to imitation, is also problematic. It is not clear why observational learning about the outcome of a behavior is more parsimonious than learning about the behavior itself. B&R describe goal emulation in the following terms: "the purpose or the goal toward which the demonstrator is striving is made overt as a result of its actions, and so becomes a goal for the observer, too" (sect. 1.3, para. 1). For such emulation to occur, the animal seems to need some theory of instrumentality and some theory of the goals of its conspecific that it can use to formulate plans of actions. The presence of such skills would imply high degrees of intentionality (in the sense of Dennett 1983), which are not widely recognized among nonhuman animals. B&R note that the behavior of great apes (and perhaps other primates) can be described in terms of hierarchical structure and hierarchical learning. Learning can occur at low levels, which they call *action levels*, and at high levels, which they call *program levels*. They correctly recognize that animals may be imitating at high levels even if the imitator's behavior does not reproduce the detailed movement patterns of the model.

This kind of hierarchical behavioral representation appears to be widespread among animals (Roitblat 1988; 1991) rather than limited to the great apes, as the reader might infer from B&R's presentation. Even rats appear to use high-level representations of their actions. In the classic experiments by MacFarlane (1930), Tolman and Honzik (1930), and Tolman et al. (1946), rats were found to learn the place where a reward was to be found rather

than the specific behavioral sequences necessary to get there. They were able to use novel patterns of movement to arrive at the goal in a maze, for example. In fact, it is quite rare that specific patterns of muscular activity are learned and unlikely that such learning would be adaptive. If programmatic learning is sufficient for imitation, then imitation must be quite widespread. Even if it is merely necessary for the appearance of imitation, it still does not preclude the occurrence of imitation in multiple species.

If we interpret B&R as calling for a more enlightened examination of imitation in animals, then they provide a fresh approach. If learning does not occur at the molecular level of specific movements, then it hardly seems sensible to require imitation to occur at that level. This insight is a strong contribution of the target article. The reader may be led to infer, however, that programmatic learning occurs only in great apes. Aside from being incorrect, this reading perpetuates an unsupportable demarcation.

There is danger in defining a phenomenon out of existence by setting the standards at such a level that it cannot be said to occur. Any behavior can be described in simple terms, but there is no *scala naturae* of behavior. The danger is even greater when the alternative explanations are not soundly grounded. The field would benefit from a thorough examination of the phenomena proposed as alternatives to imitation and the distribution of the underlying mechanisms across species.

## Hierarchical learning of song in birds: A case of vocal imitation?

Dietmar Todt

*Institut für Verhaltensbiologie, Freie Universität Berlin, D-12163 Berlin, Germany. toddt@zedat.fu-berlin.de www.animpys.biologie.fu-berlin.de*

**Abstract:** The target article by Byrne & Russon treats imitation as an achievement that originates from observation. In my commentary I propose extending the database to the role of listening. Referring to current studies on song learning in birds, I suggest that at least some features of this accomplishment also may be based on learning by imitation.

The current advances in our understanding of learning and memory are remarkable, and different fields of science are contributing to this progress. The target article by Byrne & Russon (B&R) certainly takes another step forward here. First, it treats a complex topic in a manner that can stimulate fruitful interdisciplinary debates about “learning by imitation.” Second, it provides a number of criteria that can help to concentrate such debates on testable issues. I really appreciate an approach that is not bound to some of the classical definitions (Thorpe 1956) and instead goes beyond the question “is it imitation, or not?” (Introduction, para. 4).

B&R have reviewed a lot of evidence for an impressive “richness of imitative behaviours in humans and some of the great apes” (Introduction, para 4). I especially like the distinction between “action-level” and “program-level” imitation. I feel a bit uncomfortable, however, that the authors restrict imitation to social learning, which originates from observation. In particular, a discussion about the phenomenon of vocal imitation would have been relevant. At least some spectacular cases of such imitation found in parrots (Pepperberg 1993) and song birds (Hultsch 1993) would merit explicit consideration. In the following, I will attempt to validate my opinion by concentrating on the implications of recent studies on song learning, which have changed the traditional classification of this skill (review in Todt & Hultsch 1996).

The aim of my commentary is to evaluate whether and when song learning can be accepted as a kind of imitation. I will compare features of song learning to the three properties of imitation, which B&R consider for the great apes: (1) novelty of acquired patterns, (2) hierarchical organisation of learned behaviours, and

(3) biological function of application rules. We will not deal with song learning of birds in general, focusing instead on accomplishments of nightingales (*Luscinia megarhynchos*). This species is renowned for its outstanding vocal virtuosity and is an appropriate biological model for studies on learning and memory (Hultsch 1992; Hultsch & Todt 1989; Todt & Hultsch 1996). Nightingales develop approximately 200 song-types that are discretely different and so can be distinguished easily. Moreover, these birds are excellent subjects for investigations under laboratory conditions, and thus meet logistic prerequisites for studies on song learning. Their early period of auditory song acquisition begins around day 15 posthatching and continues for the first 3 months of life. In addition, birds learn later in life. This provides an extended time span for learning experiments. Finally, nightingales will accept a human caretaker as their social tutor, thus allowing us to standardise variables (e.g., by presenting master songs through playback loudspeakers). Findings from nightingales’ vocal learning corroborate the three properties of imitation proposed by B&R.

**Novelty.** It has been argued that learning by imitation should add new patterns of behaviour to an animal’s repertoire. This criterion is clearly fulfilled: auditory access to particular types of songs is an essential prerequisite for both their acquisition and their occurrence in a nightingale’s song repertoire. Finally, the criterion of novelty can be stretched further: in addition to their accurate imitation of vocal patterns, nightingales often develop new combinations from the learned vocal material (Hultsch & Todt 1989; 1996).

**Hierarchy.** It has been argued that learning by imitation requires a hierarchically structured behavioural repertoire and that “only species with control over the hierarchical organisation of their behaviour can in principle imitate” (target article, sect. 2, para. 1). With this as a criterion, nightingales should rank as masters of vocal imitation. For example, the study of their learning and singing has unveiled two forms of hierarchy: first, there is a structural hierarchy that, in a top-down direction, is provided by a repertoire composed of a set of subrepertoires that subdivide into a number of packages composed of song-types, and finally song-types composed of different types of song elements. Second, there is a procedural hierarchy that is reflected in a system of rules that describes the sequencing of these various patterns. The permutational freedom of such patterns is related to the structural level they take in behavioural organisation; for example, it is higher between than within songs. At the within-song level, particular types of elements occur only at particular song positions, whereas at a higher level no transitional combination is excluded. However, the procedural hierarchy of song elements can be complex, as well: analyses have unveiled a branching of alternative choices that diverges at the beginning of songs but often converges again toward the end (Hultsch 1980; Todt 1970; 1971 (Fig. 1).

Features of the structural and the procedural hierarchies and especially the impact of individual learning on their development suggest that these hierarchies match what the target article calls the action level and the program level. To give an example: the major part of a nightingale’s vocalization is made up of accurate imitations of master songs, often also mirroring the sequential succession of such models (action level). However, there are other cases, as well. For example, nightingales are not only able to extract and memorise information from the rules of a tutor’s singing style; they can also transfer such information and use it when organising the performance of songs that were not acquired from that particular tutor (program level; Hultsch 1991).

**Functional aspects.** It has been argued that learning by imitation must have an adaptive function. In birdsong, this function has been documented, for example, for vocal interactions among territorial neighbours. To address a particular neighbour individually, it is essential that a nightingale will select and produce an adequate song-type, and to add a particular meaning to the signal, he must begin his vocal response within a specific interval of time (Hultsch & Todt 1982; Todt 1981; Wolffgramm & Todt 1982). Such behaviour is not at all stereotyped or quasi-automatic; it is

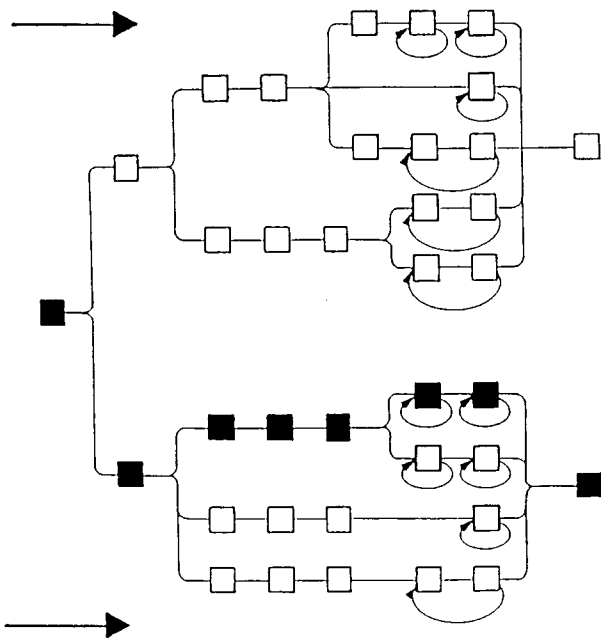
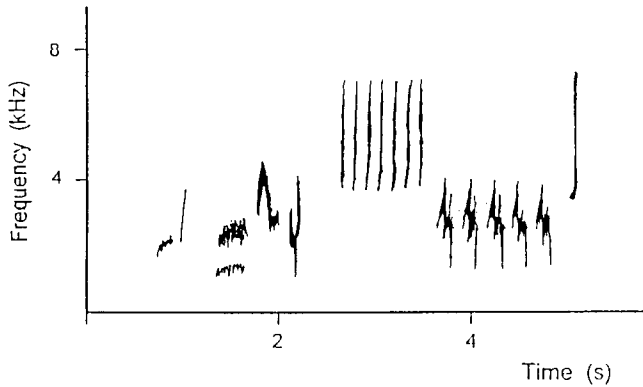

Figure 1 (Todt). Frequency spectrograms of a nightingale song (strophe) and (below) schematic flowchart of elements composing this song (filled cells). Vacant cells refer to alternative types of elements that can follow the same initial element. The flowchart illustrates a procedural hierarchy that is typical for the song structure of many birds (one-to-many schema).

flexibly adjusted to a given context. The interactive use of songs, thus requires highly advanced memory retrieval and well-controlled decision mechanisms concerning what and when to sing next. There is now evidence that the hierarchical organisation of the nightingales' repertoire reflects a hierarchical representation format of memorised information (Todt & Hultsch 1996). This system probably evolved as a strategy to deal successfully with a large repertoire of song signals (Fig. 2).

The majority of studies on song learning have focused on bird species that develop only small vocal repertoires and have concentrated on biologically fundamental issues such as sensitive phases or the role of genetic predisposition (Kroodsma & Miller 1996; Marler 1976; 1991). This explains the great number of publications on the acquisition of the species' typical structure of song patterns. Neurobiological research likewise suggests that basic information on these patterns might be "pre-coded" in a bird's brain (Konishi 1989; Nottebohm 1993) and that adequate auditory stimuli are processed by so-called experience-expectant mechanisms (Greenough & Black 1992). In this context, one can draw the following conclusions: behavioural novelty (i.e., acquired song-types), is perhaps not a reliable predictor of learning in birds. Re-

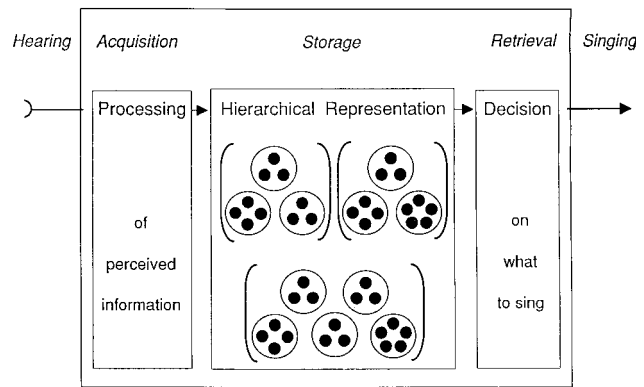

Figure 2 (Todt). Illustration of hierarchical levels found in the singing of trained birds. Songs (black balls) developed from different master strings are performed as members of different context groups (large brackets); the size of these groups depends on the length of the tutored strings. The number of song-type packages (large circles) that develop from a master string depends on this length, too, whereas their sizes do not. Note: Hierarchical levels below the song level (e.g., song sections, elements) are not considered here.

liable indicators of vocal imitation here are the learning of sequential rules or of information that is encoded on hierarchically higher levels of song organisation. Data on this are currently available only for song learning in nightingales but one hopes that they will encourage investigators to study birds that develop and use large song repertoires and to examine which mechanisms allow these nonprimates to show vocal imitation. The target article by Byrne & Russon points to the issues that such inquiries would have to tackle.

ACKNOWLEDGMENTS:

The studies on song learning in nightingales have been supported by grants of the Deutsche Forschungsgemeinschaft (To 13/21; Hu) and by the Berlin-Brandenburgische Akademie der Wissenschaften (AG RULE, project 1).

Emulation learning and cultural learning

Michael Tomasello

Department of Psychology and Yerkes Primate Center, Emory University, Atlanta, GA 30322. psynt@emory.edu

**Abstract:** Byrne & Russon redefine the process of emulation learning as "goal emulation" and thereby distort its most distinctive characteristic: the criterion that the observer focuses on environmental rather than behavioral processes. The two empirical examples recounted – gorilla plant processing and orangutan manipulation of human artifacts – are hierarchically organized behaviors, but there is very little evidence that they involve imitative learning, program-level or otherwise.

Perhaps the problem is that I came to these issues with an explicit interest in cultural transmission, the prototype being human cultural transmission. Human beings observe their conspecifics using artifacts – both material artifacts such as tools and symbolic artifacts such as language – to achieve some goal. On some occasions they try to reproduce these instrumental activities. On other occasions they ignore the behavior of others and use the artifact in some creative new way, which others may then reproduce or improve upon. This dialectic between faithful reproduction and creative extension produces what I have called the *ratchet effect*, in which cultural traditions or artifacts accumulate modifications over time (e.g., human shelters, as individuals modify them to serve additional new functions over time).

It is in this theoretical context that Tomasello et al. (1987) re-

ported the observation that when an adult chimpanzee implemented a creative tool-use strategy, young chimpanzee observers did not seem to pick up on it. Although the young observers did benefit from their observations, as they were more successful with the tool than members of a control group who saw no demonstration at all, they did not adopt the novel strategies they observed, even when those strategies were clearly (to human eyes) much more successful than their own. Subsequently, I reviewed all the data I could find on social learning in chimpanzees – a much smaller amount than I had imagined – and made an explicit comparison to the human case (Tomasello 1990). It turned out that when factors such as environmental shaping in the wild and stimulus enhancement in the laboratory were taken into account, there were no convincing demonstrations that chimpanzees are capable of reproducing the novel instrumental behavior of conspecifics.

Why then was there such marked regional variation in the way chimpanzees used tools in the wild? And why did chimpanzees have such a good reputation as imitators among zookeepers and other seemingly reliable observers? What were the subjects in our experiment learning from their observations? The then-current explanation was a behavioristic version of local or stimulus enhancement in which an organism learned nothing from its observations; it was just blindly drawn to a location or object and then blindly engaged in trial-and-error learning. I thought that something cognitively more interesting was going on, but that it did not involve one animal reproducing the novel strategies of another. Perhaps, I reasoned, the observers are just watching the objects and learning something about them. It so happens that when I observe others manipulate objects I learn a lot about those objects and their affordances for my own actions – much more than when I observe the objects sitting idle. Thus, if we give naive chimpanzees a rock and a nut, they may not discover on their own how to crack the nut open. However, if they see another chimpanzee do it, they might learn from this observation that nuts can be opened, which creates a new possibility for them, and they might even learn something about the rock's role in the process.

This is what I have called *emulation learning*. Although emulation learning is clearly a case of social learning – individuals learn things from others that they would not have learned on their own – it is not imitative learning in the sense that an organism is “learning to do an act from seeing it done.” Emulation learning however, is manifestly not a process of “associative conditioning,” as Byrne & Russon (B&R) characterize “all these simpler mechanisms” in the first paragraph of the target article. From the beginning I thought of emulation learning as a cognitivist's alternative to stimulus enhancement. It also is not “cognitively less complex than imitation” (sect. 2.7), which I have never claimed. In emulation learning the organism learns new things, some of them quite complex; it is just that they are learning about the environment, not about behavior. (See Tomasello et al. [in press] for documentation of ontogenetic ritualization as the major way in which chimpanzees acquire their gestural signals – also a cognitively complex, but not imitative, learning process.)

Nothing obscures these facts more than transforming the term *emulation learning* into the term *goal emulation* – which corresponds to nothing I have ever written or said (although it does correspond to a term used by Whiten & Ham 1992). In emulation learning the observer is *not* attending to the goal of the other, at least not in the sense that the goal is something guiding another's behavior. We can say that the observer is attending to the end result in the environment produced by the other, which is, from the human point of view, the behavior's goal. However, to repeat, the distinguishing characteristic of emulation learning, as opposed to imitative and other forms of cultural learning (Tomasello et al. 1993), is that the observer does not attend at all to the behavior of the other, much less to its goal. This is in marked contrast to human children, who reproduce adult tool-use strategies even when they do not lead to a desirable goal (Nagell et al. 1993); who selectively reproduce intentional over accidental actions even when

they both lead to the same goal (Carpenter et al., in press); who produce a result that an adult intended but did not actually produce (Meltzoff 1995); and who learn linguistic symbols, whose conventional association with their communicative functions requires that they be copied relatively faithfully from the behavior of others (Tomasello, in press). The most complete discussion of emulation and imitative learning is in Tomasello (1996), which is not cited in the target article.

As for B&R's “evidence,” the two cases are weak in the extreme (i.e., for the issue of imitative learning, not for the issue of hierarchical structure, which is clearly a characteristic of all mammalian behavior). For gorillas, what we have is the observation that all of those exposed to certain plants develop some similar, although not identical, ways of dealing with them. My question is, what would happen if different groups of gorillas (perhaps in zoos) were given the same plants? My guess is that they would develop exactly the same plant processing techniques because it is the problems presented by the plants themselves that drive the individual learning process. The rapid learning of youngsters is probably assisted by some form of stimuli enhancement or emulation learning, as they observe adults touch certain parts of the plants in a certain sequence (and they might learn that sequence). The point is that what we have here is an intriguing set of naturalistic observations that have multiple plausible interpretations – just the kind of intellectual quandary that scientific experimentation is designed to address.

In the case of the orangutans, the problem is that we do not have any of the information we need to interpret their behavior. The entirety of the “evidence” is some unusual behaviors that some orangutans perform with human artifacts – which they may have learned in any number of ways, including direct training from humans, because all of these individuals were raised by humans in one way or another before coming to the Tanjung Puting National Park. There are also no control conditions with the artifacts to determine what individuals might learn to do with them in the absence of any demonstrations at all. Many of these competing interpretations could be ruled out with simple experiments in which these individuals are exposed to novel objects in controlled demonstrations (including some kind of stimulus enhancement control condition), which, in at least two cases, have led to negative results in captive orangutans (Call & Tomasello 1994; 1995). Also relevant is the fact that the majority of the most convincing observations of Russon and Galdikas (1993), and two of the three examples cited in the target article, come from one individual, Supinah, an orangutan who had extensive experience of an undetermined nature with humans prior to any scientific observation of her behavior (Russon, personal communication).

This last fact is important because we now know that extensive interactions with humans can potentiate some humanlike social and cognitive skills in great apes that their wild conspecifics do not seem to possess (Call & Tomasello 1996; Tomasello et al. 1993). This demonstrates that great apes can respond in some important ways to human culture – its artifacts and unique forms of social engagement, communication, and instruction – but it is only indirectly relevant to the issue of cultural learning and transmission within naturally occurring great ape populations.

## Hoist by their own petard: The constraints of hierarchical models

B. Vereijken<sup>a</sup> and H. T. A. Whiting<sup>b</sup>

<sup>a</sup>Department of Psychology and <sup>b</sup>Idrettsvitenskapelig Institutt Norwegian University of Science and Technology, 7034 Trondheim, Norway.  
[beatrix.vereijken@sv.ntnu.no](mailto:beatrix.vereijken@sv.ntnu.no) [www.sv.ntnu.no/psy/beatrix.vereijken/john.whiting@sv.ntnu.no](http://www.sv.ntnu.no/psy/beatrix.vereijken/john.whiting@sv.ntnu.no)

**Abstract:** In the context of the motor skill literature on observational learning and hierarchical skill structuring, Byrne & Russon's findings call into question their standpoint that great apes imitate the behaviour of role models at the programme level. The authors impose a hierarchical model on their observations without properly considering alternative explanations. One such possibility, which stems from a constraints perspective that they dismiss, is put forward.

Our major concern with Byrne & Russon's (B&R's) target article is their *a priori* acceptance of a single model – a hierarchical skill model – as a framework for their observations. Their only justification seems to be that the organisation of the behaviour observed is “simply not well described as linear and chain-like” (sect. 2.2, para. 10). They dismiss potential alternatives in a rather cavalier fashion, stating, for example, that “it is highly implausible, however, that the constraints of the environment would be so tight that every animal would end up with the same hierarchical structure, yet so weak that the fine details of the techniques are highly variable between individuals” (sect. 2.4, para. 2). Our critique will focus first on the hierarchical model; then we will argue that B&R's dismissal of explanations based on the concept of *constraints* was rather premature.

**Hierarchical modeling.** The fact that we, as external observers, can describe and deconstruct behaviour into hierarchical units is no guarantee that the actor organised its behaviour hierarchically or that the behaviour was learned in a hierarchical fashion. Given that the motor skill literature has much to say about the hierarchical structuring of behaviour, also in the context of observational learning, it is surprising that B&R do not at least make reference to it. In this literature the origin of such structuring is often viewed in a similar way, that is, it is assumed that the lower levels of the hierarchy are established first and serve as the basis for integration at superordinate levels. This proposed order of establishment of such levels has been called into question, however, in at least two studies (Kohl & Shea 1992; Pew 1966). In a replication of Pew's earlier experimental laboratory work, Kohl and Shea for example, coupled observers to novice subjects required to learn a cursor matching task. Their findings led them to conclude that a “first-person direct perspective on sensory feedback and knowledge of results was not critical for attaining open-loop and hierarchical control” (p. 257). Kohl and Shea claim that their data support the notion that subjects may choose appropriate response/control schemes without actual practical experience, a standpoint that was suggested earlier by Martens et al. (1976). If this is the case, their findings might easily be subsumed under what B&R call “priming” rather than imitation. A similar interpretation might then also account for the feeding behaviour of baby gorillas. After all, the babies, throughout their developmental period, are confronted daily with the same *expert* model demonstrating appropriate response/control schemes. Having been primed in this way, they are free to experiment – at least within the bounds of the prevailing constraints.

**Alternative explanations.** In view of this critique of B&R's interpretation of the data, we will now present an alternative interpretation, arguing that the concept of constraints is much more powerful than B&R admit. A constraint on action is defined as any reduction in the range of possible configurations of the movement system. B&R mention environmental constraints only, but constraints can also originate from the task and from the animal (cf. Newell 1986). Constraints relevant to mountain gorillas, for example, are physiological characteristics of the teeth and gut that

constrain the choice of food; biomechanical characteristics such as uni- and bi-manual dexterity and characteristics of specific food that constrain food manipulation such as spines and stings; information available from models pointing out alternative behavioural possibilities; and ambient conditions such as season, time of day, gravity, and so forth. From this perspective, models serve mainly as social facilitation. They can increase the *likelihood* of certain behaviours, but they do not *prescribe* behaviour. In other words, they act as informational constraints influencing *what* to do, but not *how* to do it. The latter needs to be filled in by individual experience.

The interactions between all extant constraints determine the possible patterns of coordination and control for an organism engaged in an activity. Note, however, that the confluence of constraints does not necessarily limit the actor to a single solution to a task, as B&R seem to suggest. Rather, by making certain behaviours impossible while influencing the efficiency and optimality of others, interactions between constraints determine both the range of possible solutions and the likelihood of each solution. Furthermore, constraints act more severely on behaviour at a global scale of description than on the details at a local scale of description, which are left relatively free. In short, the probability distribution ensures that the behaviour of all animals is channelled toward only a few solutions; within each of these solutions, behaviour across different animals will cohere globally but differ locally.

Both these characteristics are consistent with the data B&R report (i.e., 70–80% of the apes converge to the same global solution of preparing food), although local details vary widely between individual animals. The 20–30% discrepancy is consistent with a constraints perspective, but seems inexplicable from an imitation standpoint.

What is needed to test either explanation is an analysis of the learning process in young apes. Unfortunately, B&R do not report any data on the learning process *per se*. They have analysed the *product* of social learning in terms of a hierarchical structure of goals and subgoals, but it is at the level of the learning *process* where support is to be found for either a hierarchical or a constraints model. However, even with adult data, critical questions arise. If separate, noninteracting groups of mountain gorillas have the same feeding techniques, for example, would this not support the constraints model?

## Toward a microanalysis of imitative actions

Stefan Vogt<sup>a</sup> and David Carey<sup>b</sup>

<sup>a</sup>Department of Psychology, Lancaster University, Lancaster LA1 4YF, England; and <sup>b</sup>Neuropsychology Research Group, Department of Psychology, University of Aberdeen, Old Aberdeen, AB24 2UB, Scotland.  
[s.vogt@lancaster.ac.uk](mailto:s.vogt@lancaster.ac.uk) [www.lancs.ac.uk/users/psych/staff/sv.htm](http://www.lancs.ac.uk/users/psych/staff/sv.htm)  
[d.carey@abdn.ac.uk](mailto:d.carey@abdn.ac.uk) [www.psyc.abdn.ac.uk/homedir/decarey.htm](http://www.psyc.abdn.ac.uk/homedir/decarey.htm)

**Abstract:** We outline a view of imitative behaviour as largely internally driven and discuss, based on experimental research, the distinction between program versus action level imitation, the role of organismic constraints, observational learning as vicarious exploration, and imitation as selection in speeded response paradigms.

If one compares the movement imitated with its imitation, it is the integrated movement-melody of each which stands forth as being the common element; a photographic reproduction of the separate movements involved is never found. (Koffka, 1935, p. 308 f.)

Imitative behaviour has all too often invited the equivalent of a naive realist interpretation of perception, in the sense that an exact copy of the model behaviour is expected. Like perception, however, imitation always points to the cognitive capabilities of the imitator as well as to the model. Thus, Byrne & Russon's (B&R's) anchoring of their analysis of primate imitative behaviour in the

capacity for flexible, hierarchical action planning is a sensible starting point for clarifying the contrasting views in current primate research. In addition to hierarchical organization, the modularity and selectivity of sensory and motor processes have become major themes in neuroscience, and to capture the richness of imitative behaviour, these phenomena, too, require consideration. Also, more microanalytic (e.g., kinematic and chronometric) approaches have come to prevail over pure observational methods, and a major goal of current imitation research is to elucidate the interactions between the multiple sensory, representational, and motor preparatory processes involved in imitating even such simple actions as pointing to or grasping a glass of beer. Examples from our research relate specifically to points made in the target article and illustrate this approach.

**Action level imitation?** A close match in kinematic details between mimic and model may rely as much on structural organization as higher (or “program”) level imitation does. Human subjects were asked to reproduce accurately a sequence of smooth lateral deviations of a cursor on a monitor (Vogt 1991; Whiting et al. 1992) – an apparently prototypical case for “action-level” imitation. Instead of producing stereotyped sequences of increasing length, however, subjects initially reproduced a small number of global characteristics of the cursor movement (such as its centering around a midpoint and an alternation of right- and leftward movements) before any fixed sequence emerged. Thus, even simple pattern learning appears to involve the extraction of complex features rather than the formation of linear associations. Primates are simply too clever to act as videorecorders. Accordingly, rather than contrasting program- and action-level imitation as distinct faculties, we interpret the (limited) capacity of human primates for near-exact copying as a consequence of their increased cognitive abilities, including a specific, quantitatively and temporally enhanced capacity to recognize and respond to the mimic and gestural behaviour of their conspecifics.

**Organismic constraints.** Near-exact copying may in some situations rely on shared organismic constraints between model and imitator rather than on sensory processing. Even after more than 100 reproductions of an artificially composed rhythmic pattern, subjects systematically deviated from its isochronic temporal structure, whereas their reproductions of a more natural, non-isochronic pattern were nearly perfect (Vogt et al. 1988). Thus, the use of artificial models (e.g., video animations) can help uncover apparently imitative behaviour resulting from shared motor control principles.

**Observational learning as vicarious exploration.** Like B&R, we were originally skeptical about observational learning as an aid to motor skill acquisition, particularly when an exploration of the medium of a skill (such as the mechanical properties of a racket) is required, but a recent experiment (Vogt 1996a) has made us more optimistic. The task involved a biphasic movement of the pivot of a pendulum along a linear track, and mastery of this task required precise (procedural) knowledge of the pendulum’s inertia and swing duration. To our surprise, a group that observed a skilled model for 60 trials showed improvements similar to that of a physical practice group. Two principles may explain this exploratory effect of observational learning: *internal pattern* (or *event*) *generation* and *gradual correction*. Observing a model need not be limited to the “imprinting” of a perceptual template, as often assumed; it may well involve processes of internal pattern generation, thus functioning as an externally guided form of motor imagery (Jeannerod 1994; Vogt 1994; 1995; 1996a; 1996b). Unlike in motor imagery, however, observers can detect divergences between their internal plan and the model, which can be used for gradual corrections, either immediately or when preparing the next (overt or covert) performance. Meltzoff and Moore (1994; 1997) stress that infants’ imitations are seldom perfect from the start; moreover, infants gradually correct their imitative attempts in a sequence of ordered steps. Adult imitation may involve an internalization of this process and thus act as a shortcut in exploring task constraints.

**Imitation as selection.** For analysing the processing stages and neural pathways involved in a particular imitative behaviour, it is useful to identify the earliest indication of a specific response to the model behaviour under various display conditions. We are currently investigating the imitation of simple object-oriented hand actions. Data from one pilot study indicate that kinematic responses to shifts in the direction of a model’s hand grasping one of three objects are as fast as responses to shifts of the target object’s location (see Paulignan et al. 1991). Note that in such speeded response tasks the model display is mainly used as a way to select one of a (normally small) set of possible actions. Whereas B&R prefer to exclude such selective, instantly model-guided behaviour from imitative phenomena, we see no reason to do so *a priori*. To conceptualize imitation as selection in such tasks seems to imply a very small number of visually addressable dimensions of control. Accordingly, this view would become increasingly untenable if imitation extended beyond the instructed task dimension (location in our study) and incorporated other task dimensions such as grip aperture or speed and height of transport. Exactly such instant multi-dimensional visual addressing of motor control seems to be largely absent in speeded imitation tasks, and subjects’ copying is reduced to the essential.

In summary, the enormous flexibility of unconstrained primate imitative behaviour appears to emerge from a variety of individually addressable visuomotor channels, or modules, which most likely involve a complex network of parietal, temporal, and frontal cortical areas (Carey et al., 1997). A detailed investigation of this neural substrate requires a suitable “taxonomy” of imitative behaviour based on experimental research, in which the hierarchical level of imitation represents only one of a possibly large number of relevant dimensions.

## Indices of program-level comprehension

Stephen C. Want and Paul L. Harris

Department of Experimental Psychology, University of Oxford OX1 3UD, England. [stephen.want@linacre.ox.ac.uk](mailto:stephen.want@linacre.ox.ac.uk) [paul.harris@psy.ox.ac.uk](mailto:paul.harris@psy.ox.ac.uk)  
[www.psych.ox.ac.uk/](http://www.psych.ox.ac.uk/)

**Abstract:** Byrne & Russon suggest that the production of action by primates is hierarchically organised. We assess the evidence for hierarchical structure in the comprehension of action by primates. Focusing on work with human children we evaluate several possible indices of program-level comprehension.

Byrne & Russon (B&R) argue that apes, like human children, are capable of program-level imitation. This type of imitation involves an appreciation of the way in which the hierarchical organisation of the model’s action realises its goal. We expand on an important implication of their argument.

Following the arguments advanced by Miller et al. (1960), we assume that human beings engage in hierarchically organised, planned action. These arguments are likely to extend to the great apes. The more contentious issue, in our eyes, is whether young primates can perceive and comprehend the hierarchical structure in the planned activities of an adult so as to reproduce it when they themselves act. In this commentary, we assess evidence for such program-level comprehension. We focus primarily on research with human children.

**Weak indices.** One criterion for attributing program-level comprehension is the tendency to omit those details of an observed action that serve no functional purpose. However, the evidence for such a tendency among young children is questionable. Young children have often been found to persist in replicating such details, even when their nonfunctionality has been made clear (Whiten et al. 1996). Furthermore, this criterion may sometimes yield false negatives, in that there may be some utility to copying all the details of demonstrations, either because they are not fully



understood (Call & Tomasello 1995) or for some social purpose (Kuczynski et al. 1987).

A second possible criterion for program-level comprehension is outcome-guided encoding of a given action. When human toddlers watch and imitate the movement of an agent, they encode it in terms of the outcome it is likely to bring about, even in the absence of the actual realisation of that outcome (Meltzoff 1995b). Similarly, Harris and Kavanaugh (1993) showed that when 2-year-olds watch an adult engage in a pretend goal-directed action (e.g., lifting an empty teapot and tilting it in a “pouring” gesture), they encode its pretend outcome. They describe the action as “pouring” (rather than “lifting”) and indicate the outcome (i.e., that tea would “wet” the surface below). Nonetheless, such outcome-guided encoding need not amount to program-level comprehension. In particular, the toddler need not appreciate how an overarching goal (e.g., pouring tea) motivates the attainment of various subgoals (e.g., grasping the teapot). The toddler need simply understand how an action late in the sequence (tilting the teapot) normally leads to a given outcome (pouring the liquid).

A third possible criterion for attributing program-level comprehension is the ability to watch two sequentially coordinated actions and either reproduce them in the correct order or exhibit an understanding of the way that the outcome of the first action causally enables the second (Harris et al. 1996). Such actions, however, may be simply encoded not as a hierarchical program but as a linear sequence of action–outcome pairs. These might then be combined hierarchically only in the subsequent *production* of any imitative action. Hence this criterion for program-level comprehension is also questionable.

**Strong indices.** A more convincing criterion is the ability to overlook and not reproduce temporary interruptions to an ongoing program but *benefits* from witnessing that interruption. Evidence for such a benefit has come from our own research (Want & Harris 1997). Children were given a task in which an object must, through the use of a stick, be pushed out of a horizontal tube that has a trap located along its length. To retrieve the object without trapping it, the stick must be inserted into the correct end of the tube. Three-year-old children saw one of two demonstrations. They saw either (1) a successful retrieval or (2) an initial, incorrect insertion, followed by successful retrieval. Demonstration (2) led to significantly more successful retrievals than demonstration (1). Moreover, the 3-year-olds who saw demonstration (2) succeeded without reproducing the initial, incorrect insertion. A linear encoding would have led them to treat the initial failed action as a precondition for successful retrieval. The implication is that the children understood the observed program in terms of its goal and reproduced only those behaviours that led effectively to its achievement. In future research, it will be informative to compare children and nonhuman primates with respect to this strong criterion.

Finally, we may consider a still stronger criterion: cases in which an observer not only ignores a temporary interruption to an ongoing program but *benefits* from witnessing that interruption. Evidence for such a benefit has come from our own research (Want & Harris 1997). Children were given a task in which an object must, through the use of a stick, be pushed out of a horizontal tube that has a trap located along its length. To retrieve the object without trapping it, the stick must be inserted into the correct end of the tube. Three-year-old children saw one of two demonstrations. They saw either (1) a successful retrieval or (2) an initial, incorrect insertion, followed by successful retrieval. Demonstration (2) led to significantly more successful retrievals than demonstration (1). Moreover, the 3-year-olds who saw demonstration (2) succeeded without reproducing the initial, incorrect insertion. A linear encoding would have led them to treat the initial failed action as a precondition for successful retrieval. The implication is that the children understood the observed program in terms of its goal and reproduced only those behaviours that led effectively to its achievement. In future research, it will be informative to compare children and nonhuman primates with respect to this strong criterion.

## How imitators represent the imitated: The vital experiments

Andrew Whiten

Scottish Primate Research Group, School of Psychology, University of St. Andrews, St. Andrews, Fife KY16 9JU, Scotland.

a.whiten@st-andrews.ac.uk psych.st-and.ac.uk:8080/people/lect/aw2.html

**Abstract:** Byrne & Russon rightly draw attention to complex and neglected aspects of ape imitation. However, program-level imitation as a single, absolute category may mislead us in understanding abstractions involved in imitation. Designing the right experiments will offer clarity. One recent experiment has shown imitation of sequential structure: What is needed to test other components of what the authors propose?

Byrne & Russon (B&R's) thoughtful, ethologically grounded analyses make an important case that some natural but complex aspects of imitation have been thus far neglected by researchers. Some of their propositions have much potential, but I think that the way they have tried to specify program-level imitation (PLI) needs re-thinking, perhaps severe pruning, to make it usefully confirmable or refutable.

B&R define PLI as copying (1) *no details*; (2) *bimanual coordination*; (3) *a sequence of stages*; and (4) *subroutine structure* (sect. 2.4). As they express it, all four are necessary. I will argue that defining PLI as subroutine structure alone would be clearer as the core of what interests B&R. Consider the four criteria in turn.

**1. Lack of detail in copying.** The notion that imitation can occur without copying detail is acceptable, although not new (Whiten & Ham 1992, pp. 250–51). The same is true of the possible assimilation of “emulation” to this schematic conception of imitation: “[E]mulation as described by Tomasello could be re-described as just imitation of the final act in a goal-directed sequence” [e.g.,] “rake in food” (Whiten & Ham 1992, pp. 251, 267). However, as Whiten and Cusance (1996, pp. 304–309) have pointed out, all imitation has this schematic character, so identifying the program level on this basis becomes impossible. When we find only *some* detail copied, do we reject PLI? Or will B&R say that wherever some detail is not copied, we have a case of PLI? This inherently slippery criterion appears unworkable.

Switching *between* criteria makes for further uncertainty about when PLI will be claimed. Sometimes PLI is where just *one* (highish) level of a hierarchical description is supposed to be copied (as in Table 1), appealing to criterion 1, with criterion 4 ignored; at other times, criterion 4 is emphasised – but in that case copying must involve *several* levels of a hierarchy. These two senses of PLI seem contradictory: better to focus on 4, jettisoning the unworkable 1. Whether detail is, or is not, copied can be a separate question.

**2. Copying bimanual coordination.** Surely a one-handed person will not be incapable of the core of PLI as B&R envisage it? Bimanual coordination scarcely figures in the orangutan case studies. I suggest dropping this criterion also.

**3. Copying a sequence of stages.** Unlike criterion 1, this can be framed as a testable hypothesis, which is also interesting because it begins to probe how imitators represent what they copy. So now let us consider practical identification. In the mountain gorilla case, statistical data discriminating social versus individual learning hypotheses for generating optimal feeding *sequences* are not yet available (see Tomasello & Call 1997, Table 9.2). The important question is, how could such data ever be obtained? Turning to the orangutans, however compelling the evidence for imitation of human acts such as fanning, the evidence for *sequencing* them indicates the exact opposite! Figure 7 does not portray an imitated program but an array of unsequenced (playful?) combinations. The textual description likewise bears no resemblance to the putative model sequence of human fire-making. Other cases in which only one order is *possible* do not test whether orangutans copy sequences (Whiten 1998).

Imitation of sequential structure *can* be tested. “Artificial fruits”

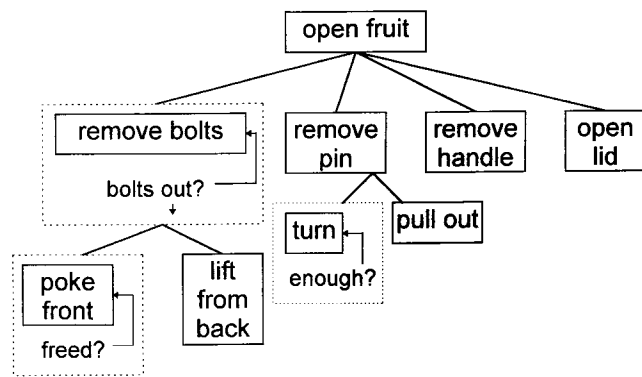

Figure 1 (Whiten). Structure of one method of artificial fruit opening, following format of Figure 2 in target article.

were designed by Whiten and Cusance in 1990 to examine imitation of sequentially patterned actions, although because of the subjects' age and doubts about primate imitation, we simplified the task initially (Whiten et al. 1996). More recently, chimpanzees witnessed several defences used to get an edible core, but they were removed in *different sequences* as well as by different techniques (Whiten 1998). Statistically significant copying of sequences emerged, which meets criterion 3, but not 4, so it is still not PLI. Whiten and Cusance (1996) suggested calling it simply *sequence imitation*. This is not the same as acquiring only an action-string. We have not yet tested this, but it would be surprising if our subjects could not complete a fruit-opening sequence presented half-done (perhaps using rules such as those in B&R's Fig. 4).

The Whiten and Cusance (1996) study cited by B&R distinguished two quite different approaches that one can take to such experiments, using either arbitrarily structured sequences or logically necessary ones (pp. 311–12). There is not the space to rehearse the distinction here, but it may help to clarify PLI's content and identifiability to learn whether B&R's theoretical position regarding PLI as copying "logical sequences" leads them to favour the second approach. It seems to have inherent drawbacks.

**4. Copying hierarchical/subgoal structure.** We are left with what seems to be the core of B&R's idea and the most interesting of the four criteria: How shall we identify this in practice? B&R suggest criteria for recognising hierarchical organisation (although Fig. 4 seems a clutch of S→R rules, with no subgoals mentioned), but they give no criteria for identifying *such hierarchical organisation as is copied*, which should be the crux of their effort. If an experimental paradigm can be envisaged that does this – goes beyond sequence imitation – then the practical criteria B&R need to determine may be clearer. PLI is perhaps an unfortunate label for it, however, because the focus is not on a level (recall discussion of criterion 1): it would really be "hierarchy imitation."

Following conventions in B&R's Figure 2, my Figure 1 shows the hierarchy that chimpanzees in my experiment *might* have acquired. Chimpanzees who witnessed the removal sequence far-bolt/near-bolt/pin/handle tended to adopt this: Were they perhaps acquiring *by observation* the hierarchical scheme of Figure 1, or just that *sequence* of removals? One could present a different model with no hierarchical "nesting" of bolts; for example, far-bolt/pin/handle/near-bolt. However, if the subject "hierarchicizes" and removes the bolts together, it will not be imitating what it saw!

Therefore, I am uncertain how PLI as B&R fully define it (four criteria) is verifiable or refutable. This may become clearer if it is stripped down to criterion 4 and framed experimentally, as I suggest. It is worth resolving this, because I think that in our complementary efforts lies the key to uncovering how imitators represent what they imitate.

## Insufficient support for either response "priming" or "program-level imitation"

Thomas R. Zentall

Department of Psychology, University of Kentucky, Lexington, KY 40506.

zentall@pop.uky.edu

www.uky.edu/artsscience/psychology/faculty/tzentall.html

**Abstract:** Byrne & Russon propose that priming can account for the imitation of simple actions, but they fail to explain how the behavior of another can prime the observer's own behavior. They also propose that imitation of complex skills requires a sequence of acts tied together by a program, but they fail to rule out the role of trial-and-error learning and perceptual/motivational mechanisms in such task acquisition.

Byrne & Russon (B&R) present a novel analysis of the acquisition of complex skills through imitation. Their ideas concerning the relation between "action-level imitation" (which involves learning about the sequencing of otherwise learned basic motor responses) may have heuristic value. However, B&R fail to provide an adequate account of recent findings of true imitative learning, and in their presentation of evidence for program-level imitation, they fail to control for less cognitive alternative accounts that have concerned researchers since Thorpe (1963; see, e.g., Galef 1988; Whiten & Ham 1992; Zentall 1996).

First, B&R assume that most cases of imitation and other social influence by animals (especially nonprimates) are actually examples of "priming." They suggest that what has been referred to as *stimulus enhancement* is an example of *stimulus priming*. What has been called *goal emulation* or *affordance* is an example of *goal (or outcome) priming*. Furthermore, what has been thought to be evidence of true imitation can be explained as *response priming*.

According to B&R, all that is needed for response priming "is the existence of structures in memory corresponding to the facilitated actions" (sect. 1.4, para. 4). If such structures of behavior exist, the observation of a demonstrator performing that behavior is sufficient to activate those structures. The authors do not identify the nature and origins of those hypothesized structures, however; nor do they explain the means by which the structures mediate the relation between the (visually) observed behavior of the demonstrator and the quite differently sensed (primarily proprioceptive) behavior of the observer. For example, we have shown, using the two-action method, that Japanese quail (Akins & Zentall 1996) and pigeons (Zentall et al. 1996) will peck at a treadle rather than step on it when treadle pecking is demonstrated (by a conspecific), and they will step on the treadle rather than peck it when treadle stepping is demonstrated. Are there existing structures for each possible response? How is it that treadle pecking by a conspecific activates the same structure as treadle pecking by oneself? For imitation to occur, a common structure must represent both behaviors. How do quail "understand" the relation between the beak of a conspecific and the observer's own beak (which must look quite different from that of the demonstrator)? What kind of simple memory structure or response prime can provide such correspondence?

B&R then propose that the imitation of (complex) skills is different from simple imitation and is acquired through the ordering of relations among larger, hierarchical units (or subroutines). Although they might be right about this, the authors have not attempted to rule out simpler processes, including trial-and-error learning and other possible nonimitational accounts (e.g., Zentall 1996), that are based on observation-produced changes in the observer's state of motivation and perception/attention (e.g., what B&R refer to as stimulus priming).

B&R do indicate that if an action appears radically different in form when viewed from the perspective of demonstrator versus performer, then priming cannot account for the results (sect. 1.4, para. 5), but they fail to apply this criterion to either two-action

method research of the type reported by Akins and Zentall (1996) or program-level research of the type they report here.

In B&R's description of gorillas preparing the leaves of plants for eating, given that mountain gorillas are motivated to eat the leaves, and given that details of the manual actions are learned through trial and error (as suggested by the authors), why is it not possible that the sequence of actions that lead to the goal are also acquired by trial and error? The authors indicate that "given the very large number of possible sequences in which 6–10 different subprocesses could be combined, this standardization is remarkable." They do admit that "many of the sequences that are theoretically possible do not succeed in processing the food," so these sequences can be rejected; but they also suggest that plenty of them do succeed (sect. 2.4, para. 2). B&R fail to consider, however, that the particular sequence of movements arrived at by the demonstrator may be the one that is most efficient (in the sense of net energy gain) and that any gorilla might arrive at the same sequence of actions or a similar one by *trial and error* (i.e., by systematically rejecting sequences that require more relative energy expenditure). I would not argue that the gorillas (or the orangutans in later examples) *do* learn these complex behaviors by trial and error, but only that such learning is possible and must be controlled if learning by imitation is to be claimed. Furthermore, researchers who examine the acquisition of such complex behavior must also control for the kind of motivational and perceptual (priming) mechanisms that might facilitate (or perhaps modulate) acquisition in the absence of imitation. The distinction between program-level and action-level imitation may yet prove to be useful, but at this point B&R lack the empirical support to claim that these behaviors are truly imitative in nature. Furthermore, they lack the theoretical and methodological justification for classifying as "simple priming" findings of true imitative learning (i.e., resulting from the appropriate use of the two-action method) that do control for alternative accounts.

## Authors' Response

### Common ground on which to approach the origins of higher cognition

Richard W. Byrne<sup>a</sup> and Anne E. Russon<sup>b</sup>

<sup>a</sup>Scottish Primate Research Group, School of Psychology, University of St. Andrews, Fife KY16 9JU, Scotland. [rwb@st-andrews.ac.uk](mailto:rwb@st-andrews.ac.uk)  
[psych.st-and.ac.uk:8080/people/lect/rwb.html](http://psych.st-and.ac.uk:8080/people/lect/rwb.html); <sup>b</sup>Department of Psychology, Glendon College, York University, Toronto M4N 3M6, Canada. [arusson@erda.glendon.yorku.ca](mailto:arusson@erda.glendon.yorku.ca)

**Abstract:** Imitation research has been hindered by (1) overly molecular analyses of behaviour that ignore hierarchical structure, and (2) attempts to disqualify observational evidence. Program-level imitation is one of a range of cognitive skills for scheduling efficient novel behaviour, in particular, enabling an individual to purloin the organization of another's behaviour for its own. To do so, the individual must perceive the underlying hierarchical schedule of the fluid action it observes and must understand the local functions of subroutines within the overall goal-directed process. Action-level imitation, copying strings of actions linearly without any such understanding, is less valuable for acquiring complex behaviour and may often have other, social functions. At present, we lack a mechanistic understanding of the abilities underlying program-level imitation that make it possible for the un-

derlying structure of complex actions to be dissected visually and recreated in behaviour.

### R1. Kinds of imitation

Imitation means many things to many people. Our target article mentions only a few meanings and is focussed on only one of them: the ability to learn a new skill by watching someone. This form of imitation has been singled out repeatedly for its cognitive implications; it offers a powerful means of learning and has been touted as one of those abilities that separates animal from human mentality. Much imitation in our daily lives is not of this kind, and may be subserved by different cognitive apparatus – the pivotal distinction we made. At its broadest, imitation may only imply a congruence by design in behaviour between two individuals, at the same time or one after the other. **Colman** is referring to this sense of imitation. His use of game theory is appropriate for understanding behavioural congruence, but it contributes nothing to our understanding of how an individual learns a new organization of behaviour, which is our aim here. Similarly, **Roitblat** is using imitation in a much broader way than we are, to include all socially aided behaviour matching, so that he finds we "dismiss" imitation in a wide range of species.

Adult humans often choose to copy actions that they themselves can already perform; many motivations other than skill-learning affect the distribution of copying. We are interested in these motivations inasmuch as they reveal function, and thus hint at evolutionary origins; **Jorion**, however, is entirely concerned with why an individual chooses to do one thing rather than another. We cannot quarrel with his answer – to increase satisfaction – but cannot see what this contributes to understanding the cognitive mechanisms of imitation. Similarly concerned with when an individual might imitate, **Miklósi** believes that imitation may occur particularly in play. This may be so, but play does not thereby "explain" the function of imitation nor its cognitive mechanisms, the issue that we set out to discuss. More to the point, we might ask what functions play serves, and suggest (e.g., Russon 1996) that imitative learning of skills is an important one.

As **Vogt & Carey** point out, it is important to distinguish imitative phenomena in terms of the cognitive processes that underlie them. Distinctions are commonly effected by terminology; it is probably unfortunate that "imitation" has been among the terms used to affect these distinctions because it has become a war zone for disputes over who owns the word and what it means. Perhaps because of this naming morass, several commentators appear to have misunderstood the fact that our discussion concerns only phenomena with specific cognitive features. **Fishbein**, **Heimann**, and **Vogt & Carey**, for example, take imitation to include a broad range of phenomena, although they appreciate that varied cognitive mechanisms underpin them, and **Midford** uses imitation in a non-technical sense.

Some classes of copying are legitimate targets of discussion because we raised them peripherally. One of them is neonatal imitation. **Heimann** suggests that it may be mediated subcortically, by different processes than the "mature imitation" that develops later in childhood. We suspect

that this is so, but also accept his arguments for mechanisms more complex than contagion: substantial delay can intervene, and the young infant “builds up” gradually over trials to a more complete copy of the demonstrated facial gesture. One explanation for neonatal imitation that is *certainly* ruled out is response facilitation, priming of brain records of actions matching the demonstrated ones. Because the actions are facial gestures, there is no overlap in features between the visual experience of another’s face and the proprioceptive experience of making a facial gesture oneself. When there *is* some overlap, as in the case of a bird seeing another peck grain and then pecking grain itself, we cannot so readily rule out response facilitation. Both **Zentall** and **Gardner & Heyes** disagree, arguing that the experience of seeing the target action performed would be very different for the birds (quail, pigeons, budgerigars) from that of doing it themselves in those experiments that have claimed imitation. Given the undeniable overlap in perceptual features in the two cases, however, we remain unconvinced that a bird cannot generalize between them.

We reiterate that for imitation that supports learning, especially skilled instrumental behaviour, it is important for the demonstration of imitation in animals that the copy be a *novel* organization of behaviour. For this reason we reject the two-action method as diagnostic of imitation in these cases. (In the special use of this method by Heyes & Dawson [1990], in which the action is either left or right, and an observer watches from in front of the demonstrator, our objection is not – as **Gardner & Heyes** seem to imagine – that priming can account for their rat data, which it cannot, but that the effect is an artifact of another problem; see Byrne & Tomasello 1995.) **Huber** takes us to task for insisting on novelty, arguing that it is a difficult criterion to apply in practice, because it requires extensive knowledge of the individual’s past history and will be helped by luck. These cannot be strong objections, for species that have been studied extensively and *never* seen to perform a particular behaviour; in our view, it argues for insisting on good ethology as a prelude to making cognitive claims, not for a monopoly of laboratory experimentation. We nonetheless admire the meticulous analysis of data from marmosets shown one of two techniques performed on an “artificial fruit” puzzle box (Bugnyar & Huber 1997). We emphasize, however, that in these data it was the copying of *sequences* of action that imply some sort of imitation, not the two-action methodology that the apparatus enshrines. Sequence is an important aspect of program-level imitation, and Bugnyar and Huber show that the spontaneous production of some of these sequences would have been highly improbable. We doubt there is an essential disagreement here, because presumably the researchers would have been even happier if the sequences they recorded had *zero* probability in spontaneous behaviour. **Hayne** notes that behavioural novelty and copying of zero-probability behaviours are now also the “accepted hallmark” in studies of imitation in human infants.

Having again set aside some of the issues about imitation that we are not concerned with here, we can now return to the central issue we raised: Is our conceptualization of imitation in a framework of hierarchical cognition *useful* to researchers whose starting points differ from our own but who are nevertheless struggling to understand complex behaviour? In our view, this is the cardinal test – the “proof of

the pudding” – of whether our target article has contributed significantly to the issue of understanding imitation as a cognitive phenomenon.

## R2. The proof of the pudding

**R2.1. From child development.** Several researchers understand and support our approach, contributing their own useful observations. **Want & Harris**, for example, see straightaway that the crucial point is not that behaviour is hierarchical (**Tomasello** apparently misinterprets us as making this obvious point as a new claim), but “whether young primates can *perceive* and *comprehend* the hierarchical structure in the planned activities of an adult” (our emphasis). Exactly. Program-level imitation implies an ability to notice the organization of another’s behaviour, and is thus closely related to planning and thought. We agree with Want & Harris’s analysis of various diagnostics of program-level imitation. Omission of nonfunctional details is a weak indicator, because there may be reasons for not replicating them (social ones, or because their function is not grasped) even when the logical organization of the central process *is* understood. Imitating the outcome of an action, even an uncompleted attempt, though highly suggestive of understanding, may be triggered by association of an action late in a (familiar) sequence with the usual endpoint, without comprehension of behavioural structure. Finally, copying of the demonstrated sequence of actions may not be based on any understanding of their actual hierarchical organization, as **Bauer’s** and **Whiten’s** comments illustrate. If an individual has understood the structure of behaviour and its organization toward attaining a goal, they should – as **Want & Harris** note – be able to ignore interruptions, and to reproduce only the causally related sequence. This stronger criterion has yet to be met unequivocally in any animal study (but see Russon, *in press*), but they present their own elegant demonstration in children, in which an interruption actually benefits imitative learning. In our work, *interruptability* has also been crucial to distinguishing hierarchy that is accessible and modifiable by an individual from a hierarchy that is crystallized and rigid (the latter is present in all complex behaviour, but is not relevant to program-level imitation). In deriving the minimal hierarchy for gorilla manual skills, interruptions for optional processes and for iterative “test-operate-test-exit” (TOTE) processes were used (Byrne & Byrne 1993). **Midford** challenges the latter, on the basis that iterative loops occur in invertebrate behaviour – as we, and many other commentators, were well aware. But the behavioural organizations of gorilla techniques are *learned*, and we can see no way in which a TOTE loop can be learned unless it can be handled computationally as a discrete organizational structure. In brief, Midford misunderstands us as advocating TOTE loops as evidence of voluntary control in a hierarchical context, whereas we advocated them as evidence of hierarchical control in a voluntary context.

**Hayne** similarly shows quick understanding of our approach, realizing that it allows that imitation “may not be an all-or-none phenomenon, varying instead along a continuum.” **Fishbein** likewise recognizes the continuum possibility, as established by Piaget’s work, although both he and

**Gardner & Heyes** mistake our intention as advocating firm splitting of imitation into “two varieties.” Hayne and Fishbein both interpret the data from human infants as developing from the highly constrained mimicry of neonates to more flexible, context-sensitive imitation that shows understanding of other individual’s goals, with program-level imitation occurring late in this progression. We agree, and are delighted that developmental psychologists who work with infants find that our distinctions jibe with their own. We are only surprised that Hayne thinks we are somehow against an experimental approach *per se*. (She calls it “empirical,” but the carefully recorded observations of spontaneous behaviour made by ethologists are also empirical; see R3.) Not at all. Our gripe is with inappropriate conceptualizations of imitation that have given rise to simplistic experiments, leading to premature and somewhat self-fulfilled claims of failure to imitate in the artificial conditions of some laboratories.

**Gattis et al.** work with 4-year-old children, and likewise find useful our distinction between action-level limitation, which may be driven by kinaesthetic-visual matching, and the complex, hierarchically organized cognitive processes that govern program-level imitation: useful for focusing attention on *how* imitation occurs rather than what is or is not imitation, and in particular for highlighting how an understanding of goal structure facilitates “the conversion from other-schema to self-schema” and “the construction of complex actions from several parts.” These were indeed major aims for us, and we are much intrigued by their multi-goal tasks, which they suggest reveal an understanding of hierarchical structure better than multi-stage tasks; we look forward to seeing more work with this novel technique. (We would point out, however, that they use “hierarchical” in the sense of goals selected before other, subordinate ones, whereas we use it in the sense of a control structure of behaviour, organized toward a single goal.)

**R2.2. From cognitive psychology.** In studying reasoning and problem-solving, **Cummins** reports that researchers have independently converged on conclusions closely similar to ours. Like us, she starts from the position that intelligent imitation requires “noticing and reproducing the goal structures that define a solution to a problem,” and “the capacity to reflect on one’s mental representations to reorganize and manipulate them.” Primed records, as she notes, merely lead to direct action, and hence shed no light on these questions. (As an aside, it was interesting to learn from **Chen et al.** that in social psychology, an idea very similar to response facilitation, the “perception-behaviour link,” is found widely useful in accounting for matching of social behaviour, stereotype activation, and postural congruence to the extent of “chamaeleon-like” mimicry in some social contexts. But their suggestion that priming explanations can extend to program-level imitation misses the derivation of new behavioural structures, which it was our central purpose to explain.) Tellingly, Cummins notes that the oddity of intelligent mechanisms being – so far – more evident in ape food processing and laundry pilfering than in direct tests of false belief and imitation, is matched by similar oddities in human reasoning that continue to perplex researchers, and have led to a proliferation of theories of domain-specific abilities for humans. Like us, she is con-

vinced that “the capacity to form hierarchically embedded mental representations is emerging in a variety of literatures as a crucial cognitive function.”

**R2.3. From human neuropsychology.** It is clear from several commentaries that our ideas resonate with neuropsychological data. **Vogt & Carey** support our emphasis on hierarchical organization, though they point out that there may be other important dimensions of variation. More specifically, **Motomura** interprets action-level limitation as parietally mediated, and program-level imitation, more complex and related to intelligence, as requiring frontal lobe involvement. **Decety & Grèzes** take this analysis further, using data from PET scans recorded during the perception and imitation of various hand actions, which could be familiar and meaningful, or novel and meaningless to the subjects. When no imitation was required, the perception of meaningful actions (allowing response facilitation by priming) activated a series of left ventral sites; for novel actions, bilateral dorsal sites were activated, along with the cerebellum. When the aim was to imitate, a common network of (bilateral) sites was activated whether the hand movements were meaningful or not. These involved cerebellum and a dorsal stream, often identified with “vision for action,” which Decety & Grèzes interpret as supporting our analysis of action-level imitation subserved by kinaesthetic-visual matching. However, at the same time, some frontal sites were activated, raising the possibility of some hierarchical organization (unless the frontal involvement was an artifact of the sequential task instructions). Our suggestion that imitation of familiar movement patterns was separate in evolution and in its underlying mechanism was based on empirical patterns of data, not theoretical necessity; all imitation might, in principle, be hierarchical (i.e., program-level) and only the depth of embedding would then vary. As Decety & Grèzes modestly note, it is not straightforward to relate PET data to cognitive theories, partly because of the inevitable task constraints involved when obtaining brain scans; the method does offer a fascinating sidelight on the organization of cognitive processes, however, and we await with interest further developments in technique that may increase integration between the two fields.

**R2.4. From cetacean biology.** Perhaps the most extraordinary convergence in findings to emerge from the peer commentary comes from the study of dolphins. Experimental psychology has traditionally tended to dismiss apparent differences in cognitive ability among animals as differences in motivation, sensory mechanism, or motor capacity and effector organs. Dolphins have always been a thorn in the side for advocates of this tidy position, because according to them, they ought to be among the least likely mammals to show any cognitive skills! In this vein, **Kuczaj et al.** contribute their own compelling data on dolphin imitation. Not only do they find cases of action-level imitation (like that recorded by Taylor & Saayman 1973), but also what they consider simple program-level imitation. After observing a human use a simple tool to release food, dolphins copied the principle – but having no hands, they used different motor actions. Kuczaj et al. fully realize that program-level imitation implies an ability to understand the relations between specific actions and outcomes, and they share our own suspicions that, although program-level imitation does

not itself imply an ability for insightful forward planning, the two skills are reliant on many of the same cognitive structures and may in practice go together.

**R2.5. From birdsong learning.** We restricted our focus to the imitation of motor actions, as it is commonly believed that vocal imitation is unlikely to be mediated by similar processes (e.g., Galef 1988). **Todt** partly supports this, noting that the processes of acquisition of small repertoires of species-typical songs may well have little to do with the sort of imitation we discuss. Indeed, the ability of parrots and mynah birds to copy the formant structure of human speech, despite their total lack of a supralaryngeal tract to modify the carrier sound-wave by resonance, appears to fit the definition of *emulation* better than any mammalian example (Byrne 1995): copying the end result with precision by the use of different and idiosyncratic methods. But not all birdsong is alike, evidently. **Todt's** fascinating account of the structural organization in element sequencing in nightingale songs, and the nightingale's ability to learn an organization from a song tutor but then apply this organization to a new song, suggests that program-level imitation may be an important dimension of birdsong learning, after all. [See also Baker & Cunningham: "The Biology of Bird-Song Dialects" *BBS* 8(1) 1985; Johnston: "Developmental Explanation and the Ontogeny of Birdsong" *BBS* 11(4) 1988.]

### R3. Is imitation observable?

It is with a feeling of some bathos that we return to the question that, in the target article, we firmly attempted to get away from: Is what we see in gorillas/orangutans imitation, or not? The target article was *not* about whether we had seen imitation; we said this explicitly, did not invite further discussion of this already much argued issue, and directed interested readers to our original articles for the cases we made for these incidents as imitation (few apparently did so). That so many comparative psychologists chose to base their comments mainly on the is/is not question is an indication of its domination of this field, a domination that we have already argued is unfortunate. (We could not disagree more with **Roitblat's** assertion that this is the "primary issue in imitation research.")

It must seem odd to those who agree with our view of imitation and note that we came to it by observing the spontaneous behaviour of great apes, that so many people seriously doubt the value of our observations (among others: **Bauer, Gardner & Heyes, Hayne, Jorion, Matheson & Fragaszy, Tomasello, Vereijken & Whiting, Zentall**). Most of the doubting Thomases try to subsume program-level imitation into some other category – the "nothing but" approach. These alternatives are the products of speculation, with hardly a shred of honest evidence to lend them credibility, and, as **Roitblat** points out, the processes promoted as better alternatives are not themselves well established.

The point, we believe, is that many of these people doubt the value of *any* non-experimental observations to furnish anything beyond ideas for "scientific testing" (which to them means controlled experimentation, preferably in the laboratory). Among those who hold this view, the suggestion that systematic ethological observation of behaviour is

science, and can refute hypotheses as readily as experiments can, is not understood, and dismissed. To them, "experimental" means science, and "observational" means old-fashioned natural history, which may be valuable in exploring a problem but is to be replaced as soon as possible by science (experiments). Coming into psychology with backgrounds in the physical sciences, we have both always found this strange if not actively pernicious, and suppose it is a legacy of psychology's early striving to establish itself as a real science by copying, ineptly, established sciences. In physics, astronomy, and geology, to name a few, observations play roles that are equal to if not greater than experiments in testing theories. Perhaps most famously this century, the observation of the perihelion of mercury in a solar eclipse tested Einstein's General Theory of Relativity. The foundations of classical physics are also built on observation: Newton did not use billiard balls to test his laws of motion, as we might do in a school classroom; he used careful observations of planetary orbitals – a far more stringent test than any experiment he could do in a laboratory.

Once this peculiar ban is in place, observational data are dismissed as "anecdotal," making *any* experiment better! This, despite psychologists's own definition of anecdote as referring to isolated incidents, observed only because their unusual nature attracted attention, and reported to researchers second-hand (Washburn 1926); in psychology, the term is so pejorative that it is used to relegate evidence to the trashbin. (Anecdote in its dictionary definition denotes only a narrative.) Some laboratory psychologists go so far as to dismiss hundreds of hours of systematically sampled, focal animal observations as "anecdotal." This is bad scholarship. Even *ad lib* data, as unplanned observations are called in ethology, go beyond anecdotes; although weaker than any other sort for theory testing, they remain crucial for the study of rare events such as infanticide. As **de Waal** points out, the consequence in animal cognition research is that great store has been placed in experiments far divorced from situations of real social and motivational significance, in which animal species are expected to comprehend people mysteriously manipulating puzzle boxes or wearing paper bags over their heads. Not surprisingly, the experimental results have been disappointing. We join his plea for converging evidence from naturalistic settings. Whether this evidence is observational or experimental should depend on appropriateness, not on *a priori* contempt for some kinds of evidence.

Some criticisms of our data are worth considering in more detail, even though the question of whether our data "proved" imitation was not germane to the target article. (We do believe it is an important empirical issue, but not one that can be decided by pronouncements of long-experienced workers. **Miklósi, Mitchell, and Huber** invoke such opinions as to whether great apes imitate actions, and as it happens the opinions are opposite.)

**Vereijken & Whiting** and **de Waal** suggest that imitation in mountain gorillas would be more convincing if different subpopulations were found to use techniques for a single plant species with different program organizations. This is true, but we suspect it is unreasonable to hope for in mountain gorillas. Consider an imaginary species that can imitate the program-level of manual skills, and that as a direct result has social traditions of the technique – different in each subpopulation – for eating a certain plant. Over time, any subpopulation that uses a less efficient technique

is liable to be *invaded* by the tradition for a more efficient one when an individual transfers from another subpopulation, or when individual variation from within the subpopulation allows discovery of an improvement. Inefficient techniques make unstable social traditions. (The analogy with Evolutionarily Stable Strategy in evolutionary theory will be obvious.) Observing long-established traditions, it would be surprising to find anything other than all subpopulations with the same traditions. Thus, *finding* similar techniques across subpopulations does not argue *against* tradition mediated by imitation in favour of individual discovery mediated by trial-and-error learning. (The only cases of population-specific variants of a technique we know of occur in chimpanzees, but in these cases, there is virtually no possibility of knowledge transfer by immigration.)

**Fishbein** suggests that we should take more heed of Piaget's developmental work on imitation (e.g., as a broad continuum spanning action-level, program-level, and beyond). Indeed, the conceptual framework for imitation developed by Piaget and revised by his successors is one of the two main lines of thought that lead to our ideas, as we pointed out in section 2.5. The other evolved from a melting pot of thinking in the 1950s about computation, thought as a mechanical process, and simulation of behaviour. We of course suggest that the harmonious convergence of these two lines of thought is a sign of an underlying truth! Expanding the developmental framework made little sense in this target article because we were not in a position to make a solid developmental case for great ape imitation. Fishbein's comments are nonetheless useful in underscoring the critical differences in cognitive processing that probably underlie phenomena that other commentators have advocated lumping under one rubric – imitation – and lend support to our attempt to split, rather than lump, these phenomena. We do agree with Fishbein and several others (**Mitchell, Vereijken & Whiting**), that developmental evidence and perspectives would strengthen our case. Unfortunately, factors beyond our control (including the genocide in Rwanda) make it impossible to obtain in these cases.

The obvious criticism of mountain gorilla imitation of plant-eating techniques is that individual discovery by trial and error is a possible alternative. Environmental constraints mean that there *is* a “most efficient” method, potentially discoverable by trial and error. We have often pointed this out ourselves and several commentators have joined in (**Bauer,<sup>1</sup> Matheson & Fragaszy, Vereijken & Whiting, Zentall**). We will not rehash the problems with this hypothesis, which are discussed in the target article, and suggest instead that any sceptic take a few nonpsychologist friends to a nettle patch next summer. Once there, ask them how they could most quickly accumulate bundles of leaves, small enough to be ingested without touching the lips, with minimal stinging of hands or mouth. We predict that they will not discover the method used by gorillas, though they – like our critics – will *with hindsight* be able to see that this is a more efficient method, when it is described to them. This is not an unfair comparison: infant gorillas handle nettles warily and infrequently, with evident dislike and visible signs of pain, yet by weaning at 3.5 years of age all have learnt the technique and show adult levels of efficiency. Unlike the pigeons that impress **Chen et al.**, conducting thousands of trials of exploration learning is simply not a realistic option for them.

With respect to the question of explaining skill acquisition without invoking complex mechanisms, we note that **Roitblat** is highly sceptical of some of the theoretical underpinnings of associative learning, which – from our less informed viewpoint – we had considered merely limited in power. He considers that there is no reason to accept stimulus enhancement as an explanation, because it is not an established phenomenon that has ever been studied in its own right. In complete contrast, **Gardner & Heyes** believe the labels so important that we should not have elided stimulus enhancement with observational conditioning. Our point was that a priming explanation can easily encompass *both* alleged phenomena, depending on only a minor change of rule (see Byrne 1994). Gardner & Heyes's observation that human subjects are not “rewarded” when they show priming effects in verbally based experiments is neither here nor there: subjects do not need their attention explicitly drawn to the computer screen in front of them and the words on it; they are asked and often paid to watch it. By contrast, an animal in the wild may well be more likely to notice a conspecific if it is gaining reward or suffering pain.

Criticisms of the orangutan imitations are different. It is true that their behaviour is not simply a result of program-level imitation, as **Midford** and **Matheson & Fragaszy** note – it also involves creative planning, modification of existing programs, and action-level imitation. This is one reason that sequential order of subgoals varies at times between the orangutan's attempt and the human original, making analysis more difficult, as noted by **Mitchell**. It is also one of the reasons that imitation *is* important in the study of cognition: just as blatant plagiarism can reveal the organizational structure of a written product, so the mixture of mechanisms underlying orangutan behaviour can suggest how imitative and problem-solving processes are combined in acquisition. (Mitchell states that all these things are already “well known” in humans and great apes, but this must be a personal sense of knowledge, or the controversy would not still be raging.) Matheson & Fragaszy, however, conclude that this mixing means that only emulation need be invoked, in the sense of “adopting another's goal” and understanding “that a stick could be used as a rake.” We reiterate: *using* an object in a certain way to achieve a certain result, is not merely “a goal,” it is also the distinct behaviour program, often one of several, that is used to achieve that goal. In **Tomasello's** experiments, for example, observers not only achieved the outcome demonstrated – food within reach – they also adopted the novel behavioural strategy demonstrated – they *raked* it. Raking is not the inevitable product of the affordances of the object provided: it is of course one of them (otherwise, this object could not function as a rake), but it is only one of several. As we noted, when great apes have tackled this task independently, they have tended to respond to other affordances (*poke, tap, throw*) rather than to *rake*. Tomasello's apes did not know how to rake on baseline tests but did *rake* following demonstration: they did imitate the particular program they observed, *raking* food with the tool provided. All they missed were details of style.

The question of emulation ties in with general issues of goals in behaviour. **Jorion** was one of the few to contest our imputing goals to great ape behaviour; most joined us in accepting the massive body of evidence showing that great apes have goals and design their behaviour to achieve them. Goals are also inherent to organizing behaviour hierarchi-

cally, which entails subordinating some processes to the service of others, thus turning superordinate processes into goals the actor intends to achieve via the subordinated ones (Connolly & Dalgleish 1989; Connolly & Manoel 1991). Simple hierarchies with their attendant simple goals are evident in the behaviour of human infants as young as 4 months of age (e.g., Bruner 1970; Case 1985). Complex hierarchies are often constructed by decomposing a final goal into a set of subgoals that are more directly attainable via the behavioural programs the actor has at its disposal; our examples of orangutan and gorilla program-level imitation conform to this pattern. Relevant to emulation is the operational aspect of hierarchical behaviour: the means of attaining the goal, the behavioural strategies for solving the intervening problems encountered. In problem solving, intentional (goal/outcome) and operational (behavioural strategy) aspects are like two sides of a coin, different but tied together.

Because outcomes and the operations that achieve them are so fundamentally intertwined in problem solving, we are doubtful of the slick ascription of emulation/imitation labels when skilled instrumental behaviour is concerned. The confounding factor is evident in **Tomasello's** comment that chimpanzees might learn from observing that "nuts can be opened." Opening is a behavioural strategy, one of many that nuts "afford" (others include squashing, throwing, or cooking), albeit one whose enactment can vary in its details. To take behaviour *out* of that observation, to strictly isolate features of the environment from the operations that create them, would require saying something like "nuts have stuff inside them; there's a rock nearby." Compare this to "nuts can be opened with a rock," which provides observers with very different information. Tomasello does argue that observation extracts information about dynamic properties of objects; but to our minds, dynamic affordances are tied to behaviour – without behaviour, objects are likely to be idle. It is a moot point whether watching a rock fall on and crack open a nut that is fortuitously positioned on an anvil-like rock would inspire nut-cracking, not to mention whether it could even happen.

**Tomasello** is wrong in thinking that we lack histories for the orangutan subjects or specific controls for imitation. Camp Leakey was unusual in the extensive background information available. A number of the staff had worked with the rehabilitants on a regular basis for 5–7 years, one for 15 years, and Galdikas for more than 20 years. Obviously, neither field staff nor field researchers tracked the orangutans 100% of the time – but it should be recalled that neither do experimenters. Like field researchers, experimenters leave for conferences, take vacations, and go home overnight; like field staff, animal technicians take breaks, lower their vigilance, covertly indulge in prohibited activities with their apes, and overlook, misinterpret, or forget to note important behaviours. The prevailing notion that captive conditions always provide thorough, detailed histories and field conditions never do is a stereotype best abandoned in favour of balanced appraisals of what research conditions afford. Neither is it true that we used no specific controls for imitation; our controls were observational (knowledge-based) rather than experimental (procedural), but procedural controls merely manufacture knowledge that can be available from other sources – through the literature, knowledgeable staff, and concurrent events. We controlled for the same factors as experimenters when assessing the

processes underlying copying behaviour X: that X had never been acquired independently by other orangutans, that X was not known but was rapidly acquired post demonstration by the orangutan observer, and that opportunities were not available to acquire X experientially or via simpler social learning processes (Russon 1996). We note that **de Waal** accepts our arguments: that the actions these orangutans engaged in were firmly prohibited at the time, and unlikely ever to have been encouraged (and were certainly not "rewarded" by human laughter, as imagined by **Jorion**).

If **de Waal** is right that the human "enculturation" sometimes thought to enhance cognition in great apes is actually a matter of inducing the animals to identify or sympathize with humans, in the sense of believing they *are* humans, or simply allowing them to establish the sorts of interpersonal relationships that foster imitation (Mitchell 1993; Russon & Galdikas 1995), these rare individuals are indeed the very best subjects for investigating imitation. Only they would be very likely to *want* to copy human actions.

#### R4. Rewriting history

Among those who dispute that the great ape behaviour was imitation at all, opinions vary as to whether this means our approach is invalid or unnecessary, or whether it is nevertheless worthwhile, despite its shaky foundations. A few of those who recognize some truth in our approach attempt to imply that they had gotten there already, quite independently. This is strongly at variance with our experiences over the last few years, so we devote a little time to examining the claims.

**Tomasello** disputes our treatment of emulation, objecting that we consider a cognitively simple mechanism, priming, able to account for "emulation," a phenomenon he promoted as a distinct pseudo-imitative process (Tomasello 1990) – renamed "goal emulation" by Whiten and Ham (1992). In fact, he also objects to their renaming, complaining that their term "corresponds to nothing I have ever written or said," and that "from the beginning" he considered emulation to be a cognitive phenomenon, *not* less complex than imitation, just different: one in which the observer will "learn a lot about objects and their affordances." Whiten and Ham are guilty of "transforming" the term into goal emulation, implying that the observer animal is "attending to the goal of the other"; we are guilty of following their false trail.

Before we consider whether these attributions are correct, let us be clear that we do agree that learning the affordances of an object – what it can be used for, what manipulations it allows, what can be done with it, and so on – by merely watching another individual interact with the object, would be a cognitively complex process, one that could not possibly be accounted for by any simple mechanism like priming. Indeed, it is not obvious to us what mechanisms *could* account for it, short of mentally simulating the effects of actions on objects and thus deriving novel consequences without actual experimentation. This would be very exciting, if it were within the capability of non-human great apes, and we would expect it to relate to other exciting abilities, such as program-level imitation and planning. Observational affordance learning, however, has not been clearly demonstrated in any experiment because imitation, poorly executed, remains a possible alternative explanation



in all cases – as we showed in the target article. We should *not* of course treat observational affordance learning as a “null hypothesis” in this case, because it is no less complex or inherently improbable than imitation as an explanation.

Is this what **Tomasello** originally described as emulation? Not in our reading of the literature. Introducing the term, he stated that “a focus on the demonstrator’s goal may lead the observer to be attracted to and seek to attain the goal. The observer may then attempt to ‘emulate’ the demonstrator’s behaviour, that is, to reproduce the completed goal by whatever means it may devise” (Tomasello 1990). Whiten and Ham did not need to *transform* his term to goal emulation, for that was what it already was. Of course, we did not interpret them or Tomasello as meaning that the observer could “attend to the goal of the other,” in the sense of seeing their mental state. Observers can attend to results, and may consequently *set* goals for themselves that resemble those results. We argue that this process of “goal emulation” can be explained as a priming effect. This also allows the sort of unification of several superficially disparate mechanisms that **Roitblat** laments as lacking. We deliberately used Whiten and Ham’s term to avoid the ambiguities that have crept into the term emulation.

**Tomasello** suggests also that emulation can account for learning a sequence of actions as part of a complex task (here he presumably means *sensu* goal emulation, because an action sequence is certainly not an affordance of any object). This is stretching the meaning unreasonably and is not helpful. Visible intermediate results may help in learning a sequence of actions, but when the sequence is acquired by observation, this cannot be dismissed as a matter of learning a goal or an affordance: It is a kind of imitation, and specifically, an important component of program-level imitation.

For this reason, we are interested in **Whiten**’s new evidence of observational learning of a sequence of actions in chimpanzees, and we agree with him that this work is complementary to our observational fieldwork. However, the “artificial fruit” that Custance and Whiten first designed in 1990 (Custance 1994) possesses only two independent stages, and so is *not* particularly well adapted to the study of sequence learning; rather, it enshrines a version of the well-known two-action procedure (Dawson & Foss 1965). Over the next six years, their puzzle box was set to numerous nonhuman primates. Only in 1997 was sequence learning finally tested with it – with immediate dividends (see our comments on Bugnyar & Huber’s 1997 work in sect. R1, as well). During this time, we put in some effort to convince scientists of the importance of sequence learning in complex imitation (Byrne 1993; 1994; 1995; 1996; 1997; Byrne & Byrne 1991; 1993; Russon 1996; Russon & Galdikas 1993; 1994; 1995) and find it hard to believe that this had no effect, though none has been acknowledged. (It may even be that Custance & Whiten’s interest in “imitation of sequentially patterned actions” in 1990 was piqued by the first enthusiastic accounts of sequential complexity in Rwandan gorilla food processing one of us brought back to their department in January of that year.) Our belief is that if this paradigm – design of tasks *explicitly* to model aspects of adaptive complexity documented in field studies – were followed deliberately and openly, the field would move forward with more dispatch.

Some commentators appear to disagree with our approach, yet on closer examination their alternatives differ

mainly in semantics. Thus **Bauer** suggests, apparently as an alternative to program-level imitation, that a young gorilla can observe and imitate “the goal state of the causal sequence, the intermediate steps along the path, and thus the means of achieving the goal.” Just so, and this is very much what we are suggesting, and have called program-level imitation: the ability to notice, and thus to copy, the structure underlying another individual’s behaviour. **Midford** prefers to call it “observation-assisted planning,” presumably to emphasize that the effect of observation is to create efficient new plans. But remember, the *way* in which observations drove planning was by providing a display of behaviour achieving desired results, one that was quarried for useful organizations that were then copied in new plans. The point is how the process works, not how it is labelled, and we seem to be talking about the same thing, because Midford acknowledges that gorillas “may have learned an appropriate decomposition of the overall goal into subgoals and a valid ordering of the subgoals” by observation: a fine summary of program-level imitation. We agree fully with his wish to concentrate on the important types of information that can be learnt by observation: subgoals, orderings of goals, and (rather beyond the scope of our target article) affordances.

## R5. Distinguishing program-level from action-level imitation

We believe it will remain important to keep the distinctions we have made clear. **Whiten** makes heavy weather of our definition of program-level imitation. The reason we focussed on cases of imitation that lack detail is a pragmatic one: if the copy is perfect in every detail, it is difficult to rule out action-level copying. Of course, a “failure to copy detail” is not a positive feature of program-level imitation, which is about the ability to *see* organizational structure in other individuals’ behaviour, and hence to copy it, not about selective blindness to details.

As we stressed in the target article, it is only our *working hypothesis* that human imitation is in fact a chimera of abilities with two evolutionary functions: relatively low-level copying with a social function, and relatively high-level copying with a skill-acquisition function. **Vogt & Carey** interpret the lack of evidence for action-level imitation in nonhuman primates as resulting from their increased cognitive abilities: “primates are simply too clever to act as video recorders.” In contrast, **Huber** suggests that the sort of slavish copying associated with action-level imitation may, in cases where an observer lacks the necessary information or cognitive capacity to form an understanding of causal structure of a task, be a *useful* thing to do (he invokes the idea of movement imitation in animals, although we are puzzled that he considers it “well proven”). **Mitchell** also suggests an important role for action-level imitation in skill learning, as a way of finding out what actions are *for*. We agree with these points (Russon 1996). It is not always clear, however, that copying of detail *is* action-level imitation. Vogt and Carey’s human subjects showed sensitivity to program-level aspects even when attempting to copy apparently simple motor movements, and merely watching such actions produced learning.

In fact we found considerable confusion about what constitutes an “action,” and this led to confusion about action-level imitation. **Mitchell** attributes a child’s copying of new

words to action-level imitation. This cannot be right, because as we argued in section 3 of the target article, the articulatory gestures that produce the sound are invisible to an observer, the pitch register is shifted in the child's imitation, and words are organized combinations of phonemes, all showing a (program-level) understanding of the internal structure of words. Similarly, **Matheson & Fragaszy** use "action" in ways counter to our distinctions, referring to orangutans' "action units," a term we never used, and to the washing sequence as an "action unit." In our sense, the washing sequence is absolutely *not* an action – as a sequence, it obviously constitutes a multitude of actions (e.g., simple motor acts like grasp, hold, or squeeze an object), as well as subprograms for manipulating object-object relationships (e.g., rub soap *on* cloth, wring water *out of* cloth). And in Matheson & Fragaszy's example, an animal showing similar use to another of "pick," "peel," "chew," and "swallow," we can see no grounds for claiming program-level imitation when – apart from anything else – the actions are apparently normal ones in any primate's repertoire. To reiterate, we reserved the term action to mean a more basic level unit of behaviour; programs are organized combinations of actions.

Action-level imitation may not be altogether useless for skill-learning, but we remain convinced that program-level is the normal and most effective mode for using imitation in learning manual skills, and that this is its evolutionary function. In contrast, the child's powerful tendency to copy adults, apparently for the sheer pleasure of copying, stands in need of different explanation and currently appears to be weaker in nonhumans.

**Matheson & Fragaszy** feel that we blur the heuristic value of the distinction by categorizing relational manipulations as program-level. In introducing relational manipulations, we were addressing their major concern: how to operationalize the distinction between action-level and program-level imitation. We looked to the literature on human cognitive development for clues, and found that programs for manipulating physical relations are prominent among the simplest hierarchical programs young children build (e.g., Case 1985). For this reason, we offered relational manipulations as appropriate candidates for detecting program-level imitation in mature great apes. However, if new cognitive structures are generated by shuffling and repackaging whatever old ones there are in hand, and if an individual is capable of operating at several hierarchical levels, then *new* cognitive structures that advance a skill could occur at any of the levels at which the individual functions, depending on where novel challenges occur. Which programs and subprograms are "novel" and which are "old" will also change with time and individual experience. For these reasons, we believe that there is no fixed or general level of analysis appropriate for identifying program-level imitation: it is probably species-dependent and in some species, it can be highly individualized. This puts the onus on researchers to assess thoroughly each species and, in great apes, each subject prior to imitative testing; for great apes, they may well need to customize imitation tasks to individual competencies.

The relation of sequence to program-level imitation, a frequently raised issue (**Todt, Tomasello, Whiten**), is subtle and worth careful attention. Scheduling is a central issue in hierarchically organized behaviour, program-level imitation included, but scheduling is not synonymous with

sequencing and *strict* sequence is *not* a defining feature of hierarchical organization. A strict sequence is, after all, arguably the product of simple associative chaining mechanisms. Scheduling does include sequencing because, although hierarchical cognitive structures are nonlinear, turning them into action requires translating them into the more linear patterns dictated by time, and they may involve logical or causal operations that entail a particular sequence of enactment. These constraints may not, however, strictly determine one order in which behaviour components must occur. Anyone who has struggled with computer programming will recognize that establishing the order of operations includes sorting out which operations must be tightly sequenced and which can be more flexibly placed. This sort of semiflexible, or partly open, sequential structure is probably a cardinal feature of skilled instrumental action (Connolly & Manoel 1991): without the flexibility to adjust to local constraints, the behaviour risks being ineffective.

This has implications for those who suggest using sequence as a test for program-level imitation. That sequencing differences occur between demonstration and copy does not *per se* nullify the occurrence of program-level imitation. Some "sequence errors" can occur as a consequence of the observer's imprecise encoding of a relational operation demonstrated (*and/with* vs. *before/after*) rather than a failure to encode it. Other "sequence errors" can reflect the fact that in the context of skilled instrumental behaviour, a demonstrated program may not require some subsets of operations to be strictly sequenced. Our observational data do not afford all the analysis necessary to sort out these various possibilities. Experimenters can obviously devise "clean" tasks with respect to scheduling and the basis for sequencing; but they will have to become mindful of the diversity of bases for sequence in their demonstrations, what deviations from that sequence maintain the structure of the demonstrated solution, and what deviations may reflect imprecise rather than failed encoding of the demonstrated program schedule.

## R6. Imitation without intentionality?

**Mac Aogáin** takes us to task for relying on a "backdrop of free-floating intelligence" to interpret the mental structures we propose, apparently because the actions that most concern us are not mere movements, but done to bring about particular, desired results (e.g., picking out a green stem). We are indeed concerned with mental processes that set goals, embed them in other goals, work for their achievement, and recognize when they have been achieved. (Whether this is sensibly called "free-floating intelligence" we are less sure: ever since Newell et al. [1958] demonstrated that a machine algorithm can solve problems by handling organizations of goals and subgoals like a human, goal structures have surely been a proper topic of psychology.) Mac Aogáin suggests, however, that in our analysis of some great ape behaviours as hierarchical, program-level imitation means we have taken an "intentional stance," when we could – and should – have taken a stance that allowed no intentions, no "attitudes." He is then puzzled that we are ready to consider that program-level imitation may not be "mysterious"; but in fact our aims are already much closer to those he recommends to us. Unlike Tomasello (1990), for example, we do not accept that imitation is nec-

essarily deeply intentional, and we do not consider the fact that in program-level imitation hierarchical structures of behaviour need to be decoded means that the decoder has insight into “goals in the head.”

This may seem slightly paradoxical, so let us spell out more explicitly what we mean by the “understanding” of behaviour that takes place in program-level imitation. A fluid stream of behaviour must first be parsed into a string of discrete elements, and groupings of these elements. The parsing must “carve at the joints,” and the acid test of success here is whether the parsed elements and grouping recur and correlate with outcomes. Behaviour parsed inappropriately results in garble, in the sense that elements and groupings of elements remain unrelated or inconsistently related to outcomes, and descriptions of reality are immensely complicated. If the “right” parsing is made, patterns will recur and reality will seem simpler. Once this result is achieved, the system doing the parsing is in a position to ascribe “consequences” (based on the outcomes that usually follow them), and “preconditions” (based on the states that always precede them). If the parsing system is equipped by evolution to strive toward certain recognisable outcomes, it will be able to recruit elements and groupings of elements that it has decoded from others’ behaviour in those cases where their consequences and preconditions match the outcomes it “desires” and the reality it currently perceives. If it also has the capacity to handle some degree of recursion in achieving the preconditions, then hierarchical structures will be constructed, some matching those observed in the behaviour of models, as well as others “planned” on the basis of experience. In other words, it will be able to build novel hierarchical structures of behaviour by observation, showing program-level imitation. At no point has this account ascribed to our “parsing system” any ability to understand another individual’s desires or beliefs. We suspect that we are in essential agreement with **Mac Aogáin** in wanting to do away with unnecessary mentalism, and in particular with seeing less need for it in the case of imitation than has often been asserted.

## R7. Removing obstacles to interdisciplinary progress

Our goal at the outset was one of unification, and by this light we believe there is much room for optimism. The convergence in theoretical perspective and data – with developmental psychology, the psychology of reasoning and thinking, neuroscience and brain imaging, and the differing perspectives of researchers studying birdsong and dolphins – suggest to us that the description we offered in the target article is fundamentally right. But then, we would say that, wouldn’t we? And problems remain.

What we have discussed as a distinction between action-level and program-level imitation is at the very heart of one problem we see as blocking advances in the study of non-human behaviour: failure to see the forest for the trees, failure to consider the organizational structure of behaviour rather than its surface form. Tradition has directed researchers to focus on molecular patterns of behaviour to the extent that they fail to recognize behavioural structures, try to reduce them to simple phenomena, or try to dismiss them as nonbehavioural. Signs of this tendency permeate the comments we received here. Some failed to recognize

behavioural programs, like raking or opening, as behaviour. Some treated behavioural programs as simple actions even though they are demonstrably organized programs of several more atomic behavioural components (the probable reason here is that these programs operate, at skilled levels, as integrated units and have been named with single “words” e.g., cooking, opening). Others passed over the behavioural programs to focus on local behavioural detail (e.g., individual failures to light a fire versus the overall fire-making program of combining four key elements) or on sequential but not other organizational features (e.g., mismatching the sequence of operations demonstrated versus matching combinatorial patterns and allowing for scheduling flexibilities), as if accounting for some detail sufficed to account for the larger picture. If our distinction has any impact on shifting attention to the organizational features of behaviour, we will consider our job well done.

A second obstacle in the way of progress is experimental psychology’s prejudice against observational data, which we have suggested may reflect its insecurity as a science, because it is a prejudice not shared by the physical sciences. Ethology, meanwhile, has developed a tough-minded methodology for obtaining reliable data in ecologically valid circumstances (Altmann 1974; Martin & Bateson 1986). It is high time psychology took a little more notice of these developments, and paid less homage to paradigms that have “evolved” only in laboratories and now share few features with the real world.

## NOTE

**I. Bauer** find arbitrariness convincing of imitation in the actions orangutans copy, and notes the lack of it in gorilla actions; however, any such imitation is action-level.

## References

**Letters “a” and “r” before authors’ initials stand for target and response article references, respectively.**

- Abrahamson, E. (1991) Does immediate imitation influence long-term memory for observed actions? *Journal of Experimental Child Psychology* 51:235–44. [aRWB]
- Abrahamson, E. & Givold, H. (1985) Learning via observation during the second year of life. *Developmental Psychology* 21:614–23. [aRWB]
- Altmann, J. (1974) Observational study of behaviour: Sampling methods. *Behaviour* 49:227–65. [rRWB]
- Akins, C. K. & Zentall, T. R. (1995) Imitative learning in male Japanese quail (*Coturnix japonica*) using the two-action method. *Journal of Comparative Psychology* 110:316–20. [FBMdW, AM, TRZ]
- Anisfeld, M. (1991) Neonatal imitation. *Developmental Review* 11(1):60–97. [aRWB]
- Baddeley, A. (1990) *Human memory: Theory and practice*. Erlbaum. [aRWB]
- Baldwin, D. A., Markman, E. M. & Melartin, R. L. (1993) Infants’ ability to draw inferences about non-obvious object properties-evidence from exploratory play. *Child Development* 64:711–28. [AM]
- Bandura, A. (1986) *Social foundations of thought and action: A social cognitive theory*. Prentice Hall. [aRWB]
- Bargh, J. A., Chen, M. & Burrows, L. (1996) The automaticity of social behavior: Direct effects of trait concept and stereotype activation on action. *Journal of Personality and Social Psychology* 71:230–44. [MC]
- Bargh, J. A. & Gollwitzer, P. M. (1994) Environmental control of goal-directed action. *Nebraska Symposium on Motivation* 41:71–124. [MC]
- Barnat, S., Klein, P. & Meltzoff, A. N. (1996) Deferred imitation across changes in context and object: Memory and generalization. *Infant Behavior and Development* 19:241–52. [HH, AM]
- Barr, R., Dowden, A. & Hayne, H. (1996) Developmental changes in deferred imitation by 6- to 24-month-old infants. *Infant Behavior and Development* 19:159–70. [HH]

- Bates, E. (1979) *The emergence of symbols: Cognition and communication in infancy*. Academic Press. [PJB]
- Bates, E., Thal, D. & Marchman, V. (1991) Symbols and syntax: A Darwinian approach to language development. In: *Biological and behavioral determinants of language development*, ed. N. Krasnegor, D. Rumbaugh, R. Schiefelbusch & M. Studdert-Kennedy. Erlbaum. [PJB]
- Bateson, G. (1972) Steps to an ecology of mind. *Ballantine*. [MC]
- Bauer, P. J., Hertzsgaard, L. A., Dropik, P. & Daly, B. P. (1998) When even arbitrary order becomes important: Developments in reliable temporal sequencing of arbitrarily ordered events. *Memory* 6:165–98. [PJB]
- Bauer, P. J. & Mandler, J. (1989) One thing follows another: Effects of temporal structure on 1- and 2-year olds' recall of events. *Developmental Psychology* 25:197–206. [arRWB]
- Bauer, P. J., Schwade, A. A., Wewerka, S. S. & Delaney, K. (1997) *Planning ahead: Goal-directed problem solving by two-year-olds*. Manuscript in review. [PJB]
- Beck, B. (1980) *Animal tool behavior*. Garland STPM Press. [arRWB]
- Bekkering, H., Wohlschläger, A. & Gattis, M. (1997) *Imitation of gestures in children is goal directed*. (submitted). [MeG]
- Berkowitz, L. (1984) Some effects of thoughts on anti- and prosocial influences of media events: A cognitive-neoassociation analysis. *Psychological Bulletin* 95:410–27. [MC]
- Boyd, R. & Richerson, P. J. (1988) An evolutionary model of social learning: The effects of spatial and temporal variation. In: *Social learning: Psychological and biological approaches*, ed. T. R. Zentall & B. G. Galef. Erlbaum. [arRWB]
- Boysen, S. T. (1993) Counting in chimpanzees: Nonhuman principles and emergent properties of number. In: *The development of numerical competence: Animal and human models*, ed. S. T. Boysen & E. J. Capaldi. Erlbaum. [arRWB]
- (1996) "More is less": The elicitation of rule-governed resource distribution in chimpanzees. In: *Reaching into thought: The minds of great apes*, ed. A. E. Russon, K. A. Bard & S. T. Parker. Cambridge University Press. [arRWB]
- Brentano, F. (1874/1960) The distinction between mental and physical phenomena. In: *Realism and the background of phenomenology*, ed. R. Chisholm. Free Press of Glencoe. [EMA]
- Brockmann, H. J. (1980) The control of next depth in a digger wasp (*Sphex ichneumoneus* L.). *Animal Behaviour* 28:426–45. [PEM]
- Bruner, J. S. (1970) The growth and structure of skill. In: *Mechanisms of motor skill development*, ed. K. J. Connolly. Academic Press. [rRWB]
- (1972) Nature and use of immaturity. *American Psychologist* 27:687–708. [AM]
- Bugnyar, T. & Huber, L. (1997) Push or pull: An experimental study of imitation in marmosets. *Animal Behaviour* 54:817–31. [rRWB, LH, AM]
- Byrne, R. W. (1977) Planning meals: Problem-solving on a real data-base. *Cognition* 5:289–332. [arRWB]
- (1993) Hierarchical levels of imitation. Commentary on "Cultural learning," by M. Tomasello, A. C. Kruger & H. H. Ratner. *Behavioral and Brain Sciences* 16:516–17. [arRWB]
- (1994) The evolution of intelligence. In: *Behaviour and evolution*, ed. P. J. B. Slater & T. R. Halliday. Cambridge University Press. [arRWB]
- (1995a) *The thinking ape: Evolutionary origins of intelligence*. Oxford University Press. [arRWB, MeG]
- (1995b) Primate cognition: Comparing problems and skills. *American Journal of Primatology* 37:127–41. [arRWB]
- (1996) The misunderstood ape: Cognitive skills of the gorilla. In: *Reaching into thought: The minds of the great apes*, ed. A. E. Russon, K. A. Bard & S. T. Parker. Cambridge University Press. [rRWB]
- (1997) The technical intelligence hypothesis: An additional evolutionary stimulus to intelligence? In: *Machiavellian intelligence II: Extensions and evaluations*, ed. A. Whiten & R. W. Byrne. Cambridge University Press. [rRWB]
- Byrne, R. W. & Byrne, J. M. E. (1991) Hand preferences in the skilled gathering tasks of mountain gorillas (*Gorilla g. beringei*). *Cortex* 27:5221–46. [arRWB]
- (1993) Variability and standardization in the complex leaf-gathering tasks of mountain gorillas (*Gorilla g. beringei*). *American Journal of Primatology* 31:241–61. [arRWB]
- Byrne, R. W. & Tomasello, M. (1995) Do rats ape? *Animal Behaviour* 50:1417–20. [arRWB]
- Call, J. & Tomasello, M. (1994) The social learning of tool use by orangutans (*Pongo pygmaeus*). *Human Evolution* 9:297–313. [arRWB, MT]
- (1995) The use of social information in the problem-solving of orangutans (*Pongo pygmaeus*) and human children (*Homo sapiens*). *Journal of Comparative Psychology* 109:308–20. [PJB, arRWB, AM, MT, SCW]
- (1996) The effect of humans on the cognitive development of apes. In: *Reaching into thought: The minds of the great apes*, ed. A. E. Russon, K. A. Bard & S. T. Parker. Cambridge University Press. [MT]
- Carey, D. P., Perrett, D. I. & Oram, M. W. (1997) Recognizing, understanding and reproducing action. In: *Handbook of neuropsychology, vol. 11*, ed. F. Boller & J. Grafman. Elsevier. [SV]
- Carpenter, M., Akhtar, N. & Tomasello, M. (in press) Sixteen-month-old infants differentially imitate intentional and accidental actions. *Infant Behavior and Development*. [MT]
- Carver, L. J. & Bauer, P. J. (in press) When the event is more than the sum of its parts: Nine-month-olds' long-term ordered recall. *Memory*. [PJB]
- Case, R. (1985) *Intellectual development: Birth to adulthood*. Academic Press. [arRWB]
- Chartrand, T. L. & Bargh, J. A. (1996) Automatic activation of impression formation and memorization goals: Nonconscious goal priming reproduces effects of explicit task instructions. *Journal of Personality and Social Psychology* 71:464–78. [MC]
- (1998) *The chameleon effect: The perception-behavior link as "social glue."* New York University Press (submitted). [MC]
- Chen, M. & Bargh, J. A. (1997) Nonconscious behavioral confirmation processes: The self-fulfilling nature of automatically-activated stereotypes. *Journal of Experimental Social Psychology* 33:541–60. [MC]
- Cheng, P. W. & Holyoak, K. J. (1985) Pragmatic reasoning schemas. *Cognitive Psychology* 17:391–416. [DDC]
- Chomsky, N. (1957) *Syntactic structures*. Mouton. [arRWB]
- Colman, A. M. (1995) *Gene theory and its application in the social and biological sciences*, 2nd edition. Routledge. [AMC]
- Connolly, K. J. & Dalgleish, M. (1989) The emergence of a tool-using skill in infancy. *Developmental Psychology* 25(6):894–912. [rRWB]
- Connolly, K. J. & Manoel, E. de J. (1991) Hierarchies and tool-using strategies. *Behavioral and Brain Sciences* 14(4):554–55. [rRWB]
- Cosmides, L. (1989) The logic of social exchange: Has natural selection shaped how humans reason? Studies with the Wason selection task. *Cognition* 31:187–276. [DDC]
- Cummins, D. D. (1994) Analogical reasoning. In: *The encyclopedia of human behavior*. Academic Press. [DDC]
- (1996) Dominance hierarchies and the evolution of human reasoning. *Minds and Machines* 6:463–80. [DDC]
- Custance, D. M. (1994) Social learning and imitation in human and nonhuman primates. PhD thesis, University of St. Andrews.
- Custance, D. M. & Bard, K. A. (1994) The comparative and developmental study of self-recognition and imitation. In: *Self-awareness in animals and humans. Developmental perspectives*, ed. S. T. Parker, R. W. Mitchell & M. L. Boccia. Cambridge University Press. [arRWB]
- Custance, D. M., Whiten, A. & Bard, K. A. (1995) Can young chimpanzees (*Pan troglodytes*) imitate arbitrary actions? Hayes & Hayes (1952) revisited. *Behaviour* 132:11–12. [arRWB, AM]
- Darwin, C. (1871/1981) *The descent of man and selection in relation to sex*. Princeton University Press. [FBMdw]
- Dawkins, R. (1976) Hierarchical organization: A candidate principle for ethology. In: *Growing points in ethology*, ed. P. P. G. Bateson & R. A. Hinde. Cambridge University Press. [arRWB]
- Dawson, B. V. & Foss, B. M. (1965) Observational learning in budgerigars. *Animal Behaviour* 13:470–74. [arRWB, AM]
- Decety, J. (1996) Do imagined and executed actions share the same neural substrate? *Cognitive Brain Research* 3:87–93. [MeG]
- Decety, J., Grèzes, J., Costes, N., Perani, D., Jeannerod, M., Procyk, E., Grassi, F. & Fazio, F. (1997) Brain activity during observation of actions. Influence of action content and subject's strategy. *Brain* 120:1763–77. [JD]
- Dennett, D. (1983) Intentional systems in cognitive ethology: The Panglossian paradigm defended. *Behavioral and Brain Sciences* 6:343–90. [HLR]
- (1996) *Kinds of minds: Towards an understanding of consciousness*. Weidenfeld & Nicholson. [EMA]
- de Waal, F. B. M. (1991) Complementary methods and convergent evidence in the study of primate social cognition. *Behaviour* 118:297–320. [FBMdw]
- (1996) *Good natured: The origins of right and wrong in humans and other animals*. Harvard University Press. [FBMdw]
- Dijksterhuis, A. & van Knippenberg, A. (in press) Behavioral effects of stereotype activation, or how to win a game of Trivial Pursuit. *Journal of Personality and Social Psychology*. [MC]
- Di Pellegrino, G., Faddiga, L., Fogassi, L., Vallesse, V. & Rizzolatti, G. (1992) Understanding motor events: A neurophysiological study. *Experimental Brain Research* 91:176–80. [NM]
- Driver, J. & Baylis, G. C. (1993) Cross-modal negative priming and interference in selective attention. *Bulletin of the Psychonomic Society* 31:45–48. [MG]
- Dugatkin, L. A. & Godin, J. J. (1992) Reversal of female mate choice by copying in the guppy (*Poecilia reticulata*). *Proceedings of the Royal Society of London* 249:179–84. [FBMdw]
- Epstein, R., Kirshnit, C. E., Lanza, R. P. & Rubin, L. C. (1984) Insight in the pigeon: Antecedents and determinants of an intelligent performance. *Nature* 308:61–62. [MC]
- Fadiga, L., Fogassi, L., Pavesi, G. & Rizzolatti, G. (1995) Motor facilitation during action observation: A magnetic study. *Journal of Neurophysiology* 73:2608–11. [MeG]

- Fagen, R. (1981) *Animal play behaviour*. Oxford University Press. [AM]
- Fishbein, H. D. (1984) *The psychology of infancy and childhood*. Erlbaum. [HDF]
- Flood, M. M., Lendenmann, K. & Rapoport, A. (1983) 2 x 2 games played by rats: Different delays of reinforcement as payoffs. *Behavioral Science* 28:65–78. [AMC]
- Florito, G. & Scotto, P. (1992) Observational learning in *Octopus vulgaris*. *Science* 256:545–47. [FBMdw]
- Fossey, D. (1979) Development of the mountain gorilla (*Gorilla gorilla beringei*): The first thirty-six months. In: *The great apes*, ed. D. A. Hamburg & D. R. McCowan. Benjamin/Cummings. [RWM]
- Galef, B. G., Jr. (1988) Imitation in animals: History, definitions, and interpretation of data from the psychological laboratory. In: *Social learning: Psychological and biological perspectives*, ed. T. Zentall & B. G. Galef, Jr. Erlbaum. [arRWB]
- (1992) The question of animal culture. *Human Nature* 3:157–78. [arRWB]
- Galef, B. G., Manzig, L. A. & Field, R. M. (1986) Imitation learning in budgerigars: Dawson and Foss (1965) revisited. *Behavioural Processes* 13:191–202. [arRWB]
- Gardner, H. (1983) *Frames of mind: The theory of multiple intelligences*. Basic Books. [DDC]
- Gardner, M. R. (1997) Imitation: The methodological adequacy of directional control tests. Unpublished Ph. D. dissertation. University of London. [MG]
- Gardner, R. M., Corbin, T. L., Beltramo, J. S. & Nickell, G. G. (1984) The Prisoner's Dilemma Game and cooperation in the rat. *Psychological Reports* 55:687–96. [AMC]
- Gibson, J. J. (1979) *The ecological approach to visual perception*. Houghton Mifflin. [PEM]
- Gibson, K. R. (1990) New perspectives on instincts and intelligence: Brain size and the emergence of hierarchical mental construction skills. In: *"Language" and intelligence in monkeys and apes*, ed. S. T. Parker & K. R. Gibson. Cambridge University Press. [arRWB]
- (1993) Animal minds, human minds. In: *Tools, language, and cognition*, ed. K. R. Gibson & T. Ingold. Cambridge University Press. [arRWB]
- Goodale, M. A. (1997) Visual routes to perception and action in the cerebral cortex. In: *Handbook of neuropsychology, vol. 11*, ed. F. Boller & J. Grafman. Elsevier. [JD]
- Gopnik, A. & Meltzoff, A. N. (1995) Minds, bodies, and persons: Young children's understanding of the self and others as reflected in imitation and theory of mind research. In: *Self-awareness in animals and humans. Developmental perspectives*, ed. S. T. Parker, R. W. Mitchell & M. L. Boccia. Cambridge University Press. [AM]
- Greenfield, P. (1991) Language, tools and the brain: The ontogeny and phylogeny of hierarchically organized sequential behavior. *Behavioral and Brain Sciences* 14:531–95. [arRWB]
- Greenough, W. T. & Black, J. E. (1992) Induction of brain structure by experience: Substrates for cognitive development. *Child Psychology* 24:155–200. [DT]
- Grèzes, J., Costes, N. & Decety, J. (in press) Top-down effect of the strategy on the perception of biological motion: a PET investigation. *Cognitive Neuropsychology*. [JD]
- Guillaume, P. (1926) *Imitation in children*. University of Chicago Press. [arRWB]
- Harris, P. L. & Kavanaugh, R. D. (1993) Young children's understanding of pretense. *Society for Research in Child Development Monographs* 58:Serial No. 231. [SCW]
- Harris, P. L., Kavanaugh, R. D. & Meredith, M. (1996) Young children's comprehension of pretend episodes: The integration of successive actions. *Child Development* 65:16–30. [SCW]
- Hayes, K. J. & Hayes, C. (1952) Imitation in a home-raised chimpanzee. *Journal of Comparative Physiological Psychology* 45:450–59. [arRWB, AM]
- Hayne, H., MacDonald, S. & Barr, R. (1997) Developmental changes in the specificity of memory over the second year of life. *Infant Behavior and Development* 20:233–45. [HH]
- Heimann, M. (1989) Neonatal imitation, gaze aversion, and mother-infant interaction. *Infant Behavior and Development* 12:493–503. [MH]
- (1994) *Do temperamental factors influence young infants' tendency to imitate?* Poster presented at the 13th Biennial Meeting of ISSBD, Amsterdam, The Netherlands. [MH]
- (1998) Imitation in neonates, in older infants, and in children with autism: Feedback to theory. In: *Intersubjective communication and emotion in ontogeny. A source book*, ed. S. Bråten. Cambridge University Press. [MH]
- Heimann, M., Nelson, K. E. & Schaller, J. (1989) Neonatal imitation of tongue protrusion and mouth opening: Methodological aspects and evidence of early individual differences. *Scandinavian Journal of Psychology* 30:90–101. [MH]
- Heyes, C. M. (1993) Imitation, culture, and cognition. *Animal Behaviour* 46:999–1010. [arRWB]
- (1994) Social learning in animals: Categories and mechanisms. *Biological Reviews* 69:207–31. [MG, AM]
- Heyes, C. M. & Dawson, G. R. (1990) A demonstration of observational learning in rats using a bidirectional control. *Quarterly Journal of Experimental Psychology* 42B:59–71. [arRWB, AM]
- Heyes, C. M., Dawson, G. R. & Nokes, T. (1992) Imitation in rats: Initial responding and transfer evidence from a bidirectional control procedure. *Quarterly Journal of Experimental Psychology, Section B: Comparative and Physiological Psychology* 45B:229–40. [arRWB, PEM]
- Holmlund, C. (1995) Development of turntakings as a sensorimotor process in the first 3 months: A sequential analysis. In: *Children's language, vol. 8*, ed. K. E. Nelson & Z. Réger. Erlbaum. [MH]
- Hultsch, H. (1980) Beziehungen zwischen Struktur, zeitlicher Variabilität und sozialem Einsatz im Gesang der Nachtigall (*Luscinia megarhynchos*). Ph. D. dissertation, FU Berlin. [DT]
- (1991) Early experience can modify singing styles - evidence from experiments with nightingales (*Luscinia megarhynchos*). *Animal Behaviour* 42:883–89. [DT]
- (1992) Time window and unit capacity: Dual constraints on the acquisition of serial information in songbirds. *Journal of Comparative Physiology A* 170:275–80. [DT]
- (1993) Tracing the memory mechanisms in the song acquisition of birds. *Netherlands Journal of Zoology* 43:155–71. [DT]
- Hultsch, H. & Todt, D. (1982) Temporal performance roles during vocal interactions in nightingales. *Behavioral Ecology and Sociobiology* 11:253–60. [DT]
- (1989) Memorization and reproduction of songs in nightingales (*Luscinia megarhynchos*): Evidence for package formation. *Journal of Comparative Physiology A* 165:197–203. [DT]
- (1996) Discontinuous and incremental processes in the song learning of birds: Evidence for a primer effect. *Journal of Comparative Physiology A* 179:291–99. [DT]
- Humphrey, N. K. (1976) The social function of intellect. In: *Growing points in ethology*, ed. P. P. G. Bateson & R. A. Hinde. Cambridge University Press. [FBMdw]
- Inoue-Nakamura, N. & Matsuzawa, T. (1997) Development of stone tool use by wild chimpanzees (*Pan troglodytes*). *Journal of Comparative Psychology* 111:159–73. [AM]
- James, W. (1890) *Principles of psychology*. Holt. [MC]
- Jeannerod, M. (1994) The representing brain: Neural correlates of motor intention and imagery. *Behavioral and Brain Sciences* 17:187–245. [SV]
- Jeffrey, R. C. (1983) *The logic of decision*, 2nd edition. University of Chicago Press. [AMC]
- Jorion, P. (1990) *Principes des systèmes intelligents*. Collection Sciences Cognitives. Masson. [PJM]
- (1994) L'intelligence artificielle: Au confluent des neurosciences et de l'informatique. *Lektion* 4(2):85–114. [PJM]
- (1997) Ce qui fait encore cruellement défaut à l'intelligence. *Informations In Cognito* 7:1–4. [PJM]
- Kahneman, D. & Tversky, A. (1979) Prospect theory: An analysis of decision under risk. *Econometrica* 47:263–91. [AMC]
- Koestler, A. (1967) *The ghost in the machine*. Hutchinson. [MC]
- Koffka, K. (1935/1980) *Growth of the mind*. Transaction Books. [SV]
- Kohl, R. M. & Shea, C. H. (1992) Pew (1966) revisited: Acquisition of hierarchical control as a function of observational practice. *Journal of Motor Behavior* 24:247–60. [BV]
- Köhler, W. (1925/1976) *The mentality of apes*. Routledge & Kegan Paul/Liveright. [arRWB, AM]
- Konishi, M. (1989) Bird song for neurobiologists. *Neuron* 3:541–49. [DT]
- Kroodsma, D. E. & Miller, E. H. (1996) *Ecology and evolution of acoustic communication in birds*. Cornell University Press. [DT]
- Kuczynski, L., Zahn-Waxler, C. & Radke-Yarrow, M. (1987) Development and content of imitation in the second and third years of life: A socialization perspective. *Developmental Psychology* 23:276–82. [SCW]
- Kugiumtzakis, J. (1993) Intersubjective vocal imitation in early mother-infant interaction. In: *New perspectives in early communication development*, ed. J. Nadel & L. Camioni. Routledge. [MH]
- Langer, J. (1993) Comparative cognitive development. In: *Tools, language, and cognition*, ed. K. R. Gibson & T. Ingold. Cambridge University Press. [arRWB]
- Langer, J. (1996) Heterochrony and the evolution of primate cognitive development. In: *Reaching into thought: The minds of great apes*, ed. A. E. Russon, K. A. Bard & S. T. Parker. Cambridge University Press. [arRWB]
- Lashley, K. S. (1951) The problem of serial order in behavior. In: *Cerebral mechanisms in behavior: The Hixon symposium*, ed. L. A. Jeffress. Wiley. [arRWB]
- Lefebvre, A. & Giraldeau, L. (1994) Cultural transmission in pigeons is affected by the number of tutors and bystanders present. *Animal Behaviour* 47:331–37. [FBMdw]

- Lewis, D. K. (1969) *Convention: A philosophical study*. Harvard University Press. [AMC]
- Lorenz, K. Z. (1977) *Behind the mirror: A search for a natural history of human knowledge*. Methuen. [LH]
- Mac Aogáin, E. (1986) The concept of belief in cognitive theory. *Annals of Theoretical Psychology* 4:315–50. [EMA]
- MacFarlane, D. A. (1930) The role of kinesthesia in maze learning. *University of California Publications in Psychology* 4:277–305. [HLR]
- Mackintosh, N. J. (1994) Classical and operant conditioning. In: *Learning and skills*, ed. N. J. Mackintosh & A. M. Colman. Longman Essential Psychology. [aRWB]
- Marler, P. (1976) Sensory templates in species-specific behavior. In: *Simpler networks and behavior*, ed. J. C. Fentress. Sinauer Associates. [DT]
- (1991) Differences in behavioural development in closely related species: Bird song. In: *The development and integration of behaviour*, ed. P. Bateson. Cambridge University Press. [DT]
- Martens, R., Burwitz, L. & Zuckerman, J. (1976) Modeling effects on motor performance. *Research Quarterly* 47:277–91. [BV]
- Martin, P. & Bateson, P. (1986) *Measuring behaviour: An introductory guide*. Cambridge University Press. [rRWB]
- Masur, E. & Ritz, E. G. (1984) Patterns of gestural, vocal, and verbal imitation in infancy. *Merrill-Palmer Quarterly* 29:69–82. [HH]
- Matsuzawa, T. (1994) Field experiments on use of stone tools by chimpanzees in the wild. In: *Chimpanzee cultures*, ed. R. W. Wrangham, W. C. McGrew, F. B. M. de Waal & P. C. Heltne. Harvard University Press. [aRWB]
- Maynard Smith, J. & Price, G. R. (1973) The logic of animal conflict. *Nature* 246:15–80. [AMC]
- Meltzoff, A. N. (1988a) Infant imitation after a 1-week delay: Long-term memory for novel acts and multiple stimuli. *Developmental Psychology* 24:470–76. [HH]
- (1988b) Infant imitation and memory: Nine-month-olds in immediate and deferred tasks. *Child Development* 59:217–25. [HH]
- (1988c) Imitation, objects, tools and the rudiments of language in human ontogeny. *Human Evolution* 1(2):45–64. [AM]
- (1990) Foundations of developing a concept of self: The role of imitation in relating self to other and the value of social mirroring and self practice in infancy. In: *The self in transition: Infancy to childhood*, ed. D. Cicchetti & M. Beeghly. University of Chicago Press. [AM]
- (1995a) What infant memory tells us about infantile amnesia: Long-term recall and deferred imitation. *Journal of Experimental Psychology* 59:497–515. [HH]
- (1995b) Understanding the intentions of others: Re-enactment of intended acts by 18-month-old children. *Developmental Psychology* 31:838–50. [HH, MT, SCW]
- Meltzoff, A. N. & Gopnik, A. (1993) The role of imitation in understanding persons and developing a theory of mind. In: *Understanding other minds. Perspectives from autism*, ed. S. Baron-Cohen, H. Tager-Flusberg & D. J. Cohen. Oxford University Press. [aRWB]
- Meltzoff, A. N. & Moore, M. K. (1977) Imitation of facial and manual gestures by human neonates. *Science* 198:75–78. [aRWB, MeG]
- (1983) Newborn infants imitate adult facial gestures. *Child Development* 54:702–09. [aRWB]
- (1994) Imitation, memory, and the representation of persons. *Infant Behavior and Development* 17:83–99. [MH, SV]
- (1997) Explaining facial imitation: A theoretical model. *Early Development and Parenting* 6:179–92. [SV]
- Miles, H. L., Mitchell, R. W. & Harper, S. (1996) Simon says: The development of imitation in an enculturated orangutan. In: *Reaching into thought: The minds of the great apes*, ed. A. E. Russon, K. A. Bard & S. T. Parker. Cambridge University Press. [aRWB, RWM]
- Miller, G. A., Galanter, E. & Pribram, K. (1960) *Plans and the structure of behaviour*. Holt, Rinehart & Winston. [aRWB, EMA, SCW]
- Milner, A. D. & Goodale, M. A. (1995) *The visual brain in action*. Oxford University Press. [JD]
- Mineka, S., Davidson, M., Cook, M. & Keir, R. (1984) Observational conditioning of snake fear in rhesus monkeys. *Journal of Abnormal Psychology* 93:355–72. [MG]
- Mitchell, R. W. (1987) A comparative developmental approach to understanding imitation. *Perspectives in Ethology* 7:183–215. [aRWB]
- (1993) Mental models of mirror-self-recognition: Two theories. *New Ideas in Psychology* 11:295–325. [aRWB]
- (1994) The evolution of primate cognition: Simulation, self-knowledge, and knowledge of other minds. In: *Hominid culture in primate perspective*, ed. D. Quiatt & J. Itani. University Press of Colorado. [RWM]
- Moerk, E. L. (1989) The fuzzy set called “imitations.” In: *The many faces of imitation in language learning*, ed. G. E. Speidel & K. E. Nelson. Springer-Verlag. [aRWB]
- Moore, B. R. (1992) Avian movement imitation and a new form of mimicry: Tracing the evolution of a complex form of learning. *Behaviour* 122:231–63. [aRWB, AM]
- Moran, G., Krupka, A., Tutton, A. & Symons, D. (1987) Patterns of maternal and infant imitation during play. *Infant Behavior Development* 10:477–91. [AM]
- Morgan, C. L. (1900) *Animal behaviour*. Edward Arnold. [aRWB]
- Motomura, N. & Yamadori, A. (1994) A case of ideational apraxia with impairment of object use and preservation of object pantomime. *Cortex* 30:167–70. [NM]
- Nadel, J. (1986) *Imitation et communication entre jeunes enfants*. PUF. [aRWB]
- Nagell, K., Olguin, R. S. & Tomasello, M. (1993) Processes of social learning in the tool use of chimpanzees (*Pan troglodytes*) and human children (*Homo sapiens*). *Journal of Comparative Psychology* 107:174–86. [aRWB, MT]
- Newell, A., Shaw, J. C. & Simon, H. A. (1958) Elements of a theory of human problem solving. *Psychological Review* 65:151–66. [aRWB]
- Newell, A. & Simon, H. A. (1972) *Human problem solving*. Prentice-Hall. [aRWB]
- Newell, K. M. (1986) Constraints on the development of coordination. In: *Motor development in children: Aspects of coordination and control*, ed. M. G. Wade & H. T. A. Whiting. Nijhoff. [BV]
- Nottebohm, F. (1993) The search for neural mechanisms that define the sensitive period for song learning in birds. *Netherlands Journal of Zoology* 43:193–234. [DT]
- Parker, C. (1969) Responsiveness, manipulation, and implementation behavior in chimpanzees, gorillas, and orangutans. *Proceedings of the Second International Congress of Primatology* 1:160–66. S. Karger. [aRWB]
- Parker, S. T. (1996) Apprenticeship in tool-mediated extractive foraging: The origins of imitation, teaching, and self-awareness in great apes. In: *Reaching into thought: The minds of great apes*, ed. A. E. Russon, K. A. Bard & S. T. Parker. Cambridge University Press. [aRWB]
- Parker, S. T. & Gibson, K. R. (1977) Object manipulation, tool use, and sensorimotor intelligence as feeding adaptations in cebus monkeys and great apes. *Journal of Human Evolution* 6:623–41. [aRWB]
- (1990) “Language” and intelligence in monkeys and apes. Cambridge University Press. [aRWB]
- Paulignan, Y., MacKenzie, C., Marteniuk, R. & Jeannerod, M. (1991) Selective perturbation of visual input during prehension movements. I. The effects of changing object position. *Experimental Brain Research* 83:502–12. [SV]
- Pepperberg, I. M. (1993) A review of the effects of social interaction on vocal learning in African grey parrots (*Psittacus erithacus*). *Netherlands Journal of Zoology* 43:104–24. [DT]
- Pew, R. W. (1966) Acquisition of hierarchical control over the temporal organization of a skill. *Journal of Experimental Psychology* 71:764–71. [BV]
- Piaget, J. (1937/1954) *The construction of reality in the child*. Basic Books. [aRWB, EMA]
- (1945/1962) *Play, dreams, and imitation in childhood*. Norton. [aRWB, HDE, HH]
- (1946) *La formation du symbole chez l'enfant* [Symbol-formation of the child]. Delachaux & Niestlé. [MC]
- Povinelli, D. J., Boysen, S. T. & Nelson, K. E. (1990) Inferences about guessing and knowing by chimpanzees (*Pan troglodytes*). *Journal of Comparative Psychology* 104:203–10. [FBMdW]
- Povinelli, D. J. & Eddy, T. J. (1996) Factors affecting young chimpanzees’ (*Pan troglodytes*) recognition of attention. *Journal of Comparative Psychology* 110:336–45. [HLR]
- Premack, D. & Dasser, V. (1991) Perceptual origins and conceptual evidence of theory of mind in apes and children. In: *Natural theories of mind*, ed. A. Whiten. Blackwell. [SCW]
- Previde, E. P. & Poli, M. D. (1996) Social learning in the golden hamster (*Mesocricetus auratus*). *Journal of Comparative Psychology* 110:203–08. [FBMdW]
- Rescorla, R. A. (1991) Associative relations in instrumental learning. *Quarterly Journal of Experimental Psychology* 43B:1–24. [aRWB]
- Reynolds, P. C. (1982) The primate constructional system: The theory and description of instrumental tool use in humans and chimpanzees. In: *The analysis of action*, ed. M. Van Cranach & R. Hass. Cambridge University Press. [aRWB]
- Roitblat, H. L. (1988) A cognitive action theory of learning. In: *Systems with learning and memory abilities*, ed. J. Delacour & J. C. S. Levy. North Holland. [HLR]
- (1991) Cognitive action theory as a control architecture. In: *Simulation of adaptive behavior*, ed. A. Meyer & S. Wilson. MIT Press. [HLR]
- Roitblat, H. L. & von Fersen, L. (1992) Comparative cognition: Representations and processes in learning and memory. *Annual Review of Psychology* 43:671–710. [HLR]
- Romanes, G. J. (1884) *Mental evolution in animals*. AMS Press. [aRWB]
- (1889) *Mental evolution in man*. Appleton. [aRWB]
- Russon, A. E. (1996) Imitation in everyday use: Matching and rehearsal in the spontaneous imitation of rehabilitant orangutans (*Pongo pygmaeus*). In

- Reaching into thought*, ed. A. Russon, K. Bard & S. T. Parker. Cambridge University Press. [PJB, arRWB, AM]
- (in press) Imitation of tool use in orangutans: A cognitive interpretation. In: *The mentalities of gorillas and orangutans*, ed. S. T. Parker, H. L. Miles & R. W. Mitchell. Cambridge University Press. [rRWB]
- Russon, A. E. & Galdikas, B. M. F. (1993) Imitation in free-ranging rehabilitant orangutans. *Journal of Comparative Psychology* 107:147–61. [PJB, aRWB, AM, MT]
- (1994) The hierarchical organisation of complex orangutan object manipulation and tool using routines. Paper presented at the XVth Congress of the International Primatological Society. Kuta, Bali. [rRWB]
- (1995) Constraints on great apes' imitation: Model and action selectivity in rehabilitant orangutan (*Pongo pygmaeus*) imitation. *Journal of Comparative Psychology* 109:5–17. [arRWB, AM]
- Russon, A. E., Michell, R. W., Lefebvre, B. & Abravanel, E. (1998) The comparative evolution of imitation. In: *Piaget, evolution, and development*, ed. J. Langer & M. Killen. Erlbaum. [aRWB]
- Schank, R. C. (1982) *Dynamic memory*. Cambridge University Press. [PEM]
- Spence, K. W. (1937) Experimental studies of learning and higher mental processes in infra-human primates. *Psychological Bulletin* 34:806–50. [aRWB]
- Spinazzi, G. (1993) The development of spontaneous classificatory behavior in chimpanzees (*Pan troglodytes*). *Journal of Comparative Psychology* 107:193–200. [aRWB]
- Squire, L. R. (1992) Memory and the hippocampus: A synthesis from findings with rats, monkeys, and humans. *Psychological Review* 99:195–231. [MC]
- Stein, B. E. & Meredith, M. A. (1993) *The merging of the senses*. MIT Press. [MH]
- Taira, M., Mine, S., Georgopoulos, A. P. et al. (1990) Parietal cortex neurons of the monkey related to the visual guidance of hand movement. *Experimental Brain Research* 83:29–36. [NM]
- Taylor, C. K. & Saayman, G. S. (1973) Imitative behaviour by Indian ocean bottlenose dolphins (*Tursiops aduncus*) in captivity. *Behaviour* 44:286–98. [rRWB]
- Thorndike, E. L. (1898) Animal intelligence: An experimental study of the associative process in animals. *Psychological Review Monograph* 2(8):551–53. [aRWB]
- Thorpe, W. H. (1956/1963) *Learning and instinct in animals*. Methuen, 2nd edition, Harvard University Press. [aRWB, TRZ]
- Todt, D. (1970) Zur Ordnung im Gesang der Nachtigall (*Luscinia megarhynchos*). *Verhandlungen der Deutschen Zoologischen Gesellschaft* 64:249–52. [DT]
- (1971) Äquivalente und konvalente gesangliche Reaktionen einer extrem regelmässig singenden Nachtigall (*Luscinia megarhynchos* B.). *Zeitschrift für vergleichende Physiologie* 71:262–85. [DT]
- (1981) On functions of vocal matching: Effect of counter-replies on song-post choice and singing. *Zeitschrift für Tierpsychologie* 57:73–93. [DT]
- Todt, D. & Hultsch, H. (1996) Acquisition and performance of repertoires: Ways of coping with diversity and versatility. In: *Ecology and evolution of communication*, ed. D. E. Kroodsma & E. H. Miller. Cornell University Press. [DT]
- Tolman, E. C. & Honzik, C. H. (1930b) Introduction and removal of reward and maze performance in rats. *University of California Publications in Psychology* 4:257–75. [HLR]
- Tolman, E. C., Ritchie, B. F. & Kalish, D. (1946) Studies in spatial learning I. Orientation and the short-cut. *Journal of Experimental Psychology* 36:13–24. [HLR]
- Tomasello, M. (1990) Cultural transmission in the tool use and communicatory signaling of chimpanzees? In: *“Language” and intelligence in monkeys and apes*, ed. S. T. Parker & K. R. Gibson. Cambridge University Press. [arRWB, MT]
- (1996) Do apes ape? In: *Social learning in animals: The roots of culture*, ed. B. C. Galef, Jr. & C. M. Heyes. Academic Press. [MT]
- (in press) Perceiving intentions and learning words in the second year of life. In: *Language acquisition and conceptual development*, ed. M. Bowerman & S. Levinson. Cambridge University Press. [MT]
- Tomasello, M. & Call, J. (1997) *Primate cognition*. Oxford University Press. [AW]
- Tomasello, M., Call, J., Warren, J., Frost, T., Carpenter, M. & Nagell, K. (in press) The ontogeny of chimpanzee gestural signals: A comparison across groups and generations. *Evolution of Communication*. [MT]
- Tomasello, M., Davis-Dasilva, M., Camak, L. & Bard, K. (1987) Observational learning of tool use by young chimpanzees. *Human Evolution* 2:175–85. [aRWB, MDM, AM, MT]
- Tomasello, M., Kruger, A. C. & Ratner, H. H. (1993) Cultural learning. *Behavioral and Brain Sciences* 16:495–552. [MT]
- Tomasello, M., Savage-Rumbaugh, E. S. & Kruger, A. C. (1993) Imitative learning of actions on objects by children, chimpanzees, and enculturated chimpanzees. *Child Development* 64:1688–1705. [aRWB, FBMDW, MT]
- Trevarthen, C. (1993) The function of emotions in early infant communication and development. In: *New perspectives in early communication development*, ed. J. Nadel & L. Camioni. Routledge. [MH]
- Uzgiris, I. C. (1981) Two functions of imitation during infancy. *International Journal of Behavioral Development* 4:1–12. [aRWB, MH, AM]
- Uzgiris, I. C. & Hunt, J. McV. (1975) *Assessment in infancy*. University of Chicago Press. [HH]
- Visalberghi, E. & Fragaszy, D. (1990) Do monkeys ape? In: *“Language” and intelligence in monkeys and apes*, ed. S. T. Parker & K. R. Gibson. Cambridge University Press. [aRWB]
- Visalberghi, E. & Limongelli, L. (1996) Acting and understanding: Tool use revisited through the minds of capuchin monkeys. In: *Reaching into thought: The minds of great apes*, ed. A. E. Russon, K. A. Bard & S. T. Parker. Cambridge University Press. [aRWB]
- Vogt, S. (1991) Invariantenbildung im Reproduktionsversuch - ein empirischer Ansatz zu Genese und Struktur bewegungsleitender Repräsentationen. In: *Sportmotorisches Lernen und Techniktraining, vol. 2*, ed. R. Daus, H. Mechling, K. Blischke & N. Olivier. Hofmann. [SV]
- (1994) Imagery needs preparation too (Commentary on Jeannerod, 1994). *Behavioral and Brain Sciences* 17:226–27. [SV]
- (1995) On relations between perceiving, imagining and performing in the learning of cyclical movement sequences. *British Journal of Psychology* 86:191–216. [SV]
- (1996a) The concept of event generation in movement imitation - neural and behavioural aspects. *Corpus, Psyche et Societas* 3:119–32. [SV]
- (1996b) Imagery and perception-action mediation in imitative actions. *Cognitive Brain Research* 3:79–86. [MeG]
- Vogt, S., Stadler, M. & Kruse, P. (1988) Self-organization aspects in the temporal formation of movement gestalts. *Human Movement Science* 7:365–406. [SV]
- Vygotsky, L. (1962) *Thought and language*. MIT Press. [aRWB]
- Want, S. C. & Harris, P. L. (1997) Learning from other people's mistakes: Selective imitation by young children. Unpublished paper. Department of Experimental Psychology: Oxford. [SCW]
- Washburn, M. F. (1926) *The animal mind*, 3rd edition. Macmillan. [rRWB]
- Waterman, P. G., Choo, G. M., Vedder, A. L. & Watts, D. (1983) Digestibility, digestion-inhibitors and nutrients of herbaceous foliage and green stems from an African montane flora and comparison with other tropical flora. *Oecologia* 60:244–49. [aRWB]
- Watts, D. P. (1984) Composition and variability of mountain gorilla diets in the central Virungas. *American Journal of Primatology* 7:323–56. [aRWB]
- Whiten, A. (1998) Imitation of the hierarchical structure of actions by chimpanzees (*Pan troglodytes*). *Journal of Comparative Psychology* (in press). [AW]
- Whiten, A. & Custance, D. (1996) Studies of imitation in chimpanzees and children. In: *Social learning in animals: The roots of culture*, ed. C. M. Heyes & B. G. Galef. Academic Press. [aRWB]
- Whiten, A., Custance, D., Gomez, J.-C., Texeidor, P. & Bard, K. A. (1996) Imitative learning of artificial fruit processing in children (*Homo sapiens*) and chimpanzees (*Pan troglodytes*). *Journal of Comparative Psychology* 110:3–14. [aRWB, FBMDW, AM, SCW]
- Whiten, A. & Ham, R. (1992) On the nature and evolution of imitation in the animal kingdom: Reappraisal of a century of research. In: *Advances in the study of behavior, vol. 21*, ed. P. J. B. Slater, J. S. Rosenblatt, C. Beer & M. Milinski. Academic Press. [arRWB, MT, TRZ]
- Whiting, H. T. A., Vogt, S. & Vereijken, B. (1992) Human skill and motor control: Some aspects of the motor control - motor learning relation. In: *Approaches to the study of motor control and learning*, ed. J. J. Summers. North-Holland. [SV]
- Wolfgramm, I. & Todt, D. (1982) Pattern and time specificity in vocal responses of blackbirds (*Turdus merula*). *Behaviour* 81:264–86. [DT]
- Wood, D. (1989) Social interaction as tutoring. In: *Interaction in human development*, ed. M. H. Bornstein & J. S. Bruner. Erlbaum. [aRWB]
- Xitco, M. J., Jr. (1988) Mimicry of modeled behaviors by bottlenose dolphins. Unpublished Master's thesis. University of Hawaii. [SAK]
- Yando, R., Seitz, V. & Zigler, E. (1978) *Imitation: A developmental perspective*. Erlbaum. [aRWB]
- Zentall, T. R. (1996) An analysis of imitative learning in animals. In: *Social learning and tradition in animals: The roots of culture*, ed. C. M. Heyes & B. G. Galef. Erlbaum. [aRWB, TRZ]
- Zentall, T. R. & Galef, B. G., Jr., eds. (1988) *Comparative social learning*. Erlbaum. [aRWB]
- Zentall, T. R., Sutton, J. E. & Sherburne, L. M. (1996) True imitative learning in pigeons. *Psychological Science* 7:343–46. [TRZ]