

**UNIVERSITY OF CARDIFF**  
**SCHOOL OF ENGINEERING**

**Decision Support System for Brownfield Site  
Sustainable Regeneration**

Cristina Pellegrino  
MPhil  
2007

UMI Number: U584989

All rights reserved

INFORMATION TO ALL USERS

The quality of this reproduction is dependent upon the quality of the copy submitted.

In the unlikely event that the author did not send a complete manuscript and there are missing pages, these will be noted. Also, if material had to be removed, a note will indicate the deletion.



UMI U584989

Published by ProQuest LLC 2013. Copyright in the Dissertation held by the Author.  
Microform Edition © ProQuest LLC.

All rights reserved. This work is protected against  
unauthorized copying under Title 17, United States Code.



ProQuest LLC  
789 East Eisenhower Parkway  
P.O. Box 1346  
Ann Arbor, MI 48106-1346

**UNIVERSITY OF CARDIFF**  
**SCHOOL OF ENGINEERING**

**Decision Support System for Brownfield Site  
Sustainable Regeneration**

Cristina Pellegrino  
MPhil  
2007

Supervisor  
Pr H R Thomas

**NOTICE OF SUBMISSION OF THESIS: POSTGRADUATE RESEARCH DEGREES**

Please return the completed form to:  
**Relevant School Office**

*Please TYPE or write in BLACK ink and use BLOCK capitals*

**SECTION A: TO BE COMPLETED BY THE CANDIDATE AND SUBMITTED WITH THE THESIS**

<b>STUDENT ID NUMBER</b>	
<b>CANDIDATE'S LAST NAME</b>	PELLEGRINO
<b>CANDIDATE'S FIRST NAME(S)</b>	CRISTINA
<b>SCHOOL</b>	SCHOOL OF ENGINEERING
<b>TITLE OF DEGREE</b>	Please circle appropriate value MPHIL
<b>FULL TITLE OF THESIS</b>	DECISION SUPPORT SYSTEM FOR BROWNFIELD SITE SUSTAINABLE REGENERATION
<b>IS THIS A RESUBMISSION?</b>	Yes <input type="checkbox"/> No <input type="checkbox"/>
<b>THESIS SUBMITTED FOR EXAMINATION IN:</b>	Permanent Binding <input type="checkbox"/> Temporary binding <input type="checkbox"/>

## **Acknowledgements**

The author would like to express extreme gratitude to the following people, without whose knowledge, advice and assistance, the work of this project could not have been completed.

To Pr Thomas for his guidance and patience in the development and finalisation of this research.

To Pr Yong for his highly appreciated help and suggestions that helped me to develop an innovative idea for the project.

To the RESCUE team for allowing me to contribute to their research and the use of the results in the development of this project.

To Parsons Brinckerhoff Ltd and in particular to Adrian Dolecki for providing support and relevant expertise at different times.

Particular thanks to Derek and John for their support and encouragement throughout this work.

*Dedicate to my family to whom I owe everything*

## **ABSTRACT**

The work described in this thesis concerns the development of a Brownfield Site Sustainable Regeneration - Decision Support System (BSSR-DSS). The project aims to develop a pilot system that can provide information and alternatives for sustainable brownfield regeneration as a platform to make decisions in this context.

One of the main characteristics of the BSSR-DSS is its ability to process the input data (related to site characteristics), run simulations and assess/evaluate different scenarios in order to obtain the most sustainable solution.

The process input data for the BSSR-DSS relates to a wide range of sustainability indicators that have been developed in the European Project “RESCUE – Regeneration of European Sites in Cities and Urban Environments”.

The system involves the elaboration of methods and approaches using innovative mathematical techniques such as Artificial Neural Networks and Fuzzy Logic to analyze and evaluate the input data (site characteristics and sustainability indicators) to produce a significant output.

The literature review undertaken confirmed that no current system integrating the two above mathematical techniques has been implemented to date.

The system is also linked to a Geographic Information System (GIS) called MAPINFO. This allows extensive information searches to be undertaken that can be site specific, and the information displayed on a map.

## **List of Contents**

### **Chapter 1 Introduction**

1.1	The Brownfield Problem	1
1.1.2	Progress	2
1.2	The background to the development of the Decision Support System for Brownfield Site Sustainable Regeneration	4
1.3	The Decision Support System	6
1.3.1	The scientific problem	8
1.3.2	The tasks	9
1.4	The thesis	10

### **Chapter 2 Sustainability, Planning and the Legislative Framework for Brownfield Site Redevelopment**

2.1	Sustainability	12
2.1.1	The sustainability concept	12
2.1.2	Sustainability definition in the context of Brownfield Regeneration	14
2.1.3	Sustainability Indicators	19
2.2	UK Planning and Legislation Framework	21

### **Chapter 3 Literature Review**

3.1	Introduction	29
3.2	Artificial Neural Networks	29
3.2.1	Examples of use of ANN	30
3.3	Use of a Belief Function and Artificial Neural Networks in Brownfield Redevelopment Decision Making	31



3.4	Integrated Simulation System of GIS and ANN for Land Appraisal	33
3.5	Fuzzy Logic and Brownfield Regeneration	34
3.5.1	Examples of Fuzzy Logic integrated to Brownfield Regeneration	34
3.6	Software and decision support system	37
3.6.1	GIS for brownfield TOOLKIT	38
3.6.2	London's Brownfield Resource Pilot Project: the Wandle Valley	40
3.6.3	A GIS-based decision support system for brownfield redevelopment	42
3.6.4	DESYRE – Decision support system for rehabilitation of contaminated sites	45
3.6.5	Conceptual framework for understanding brownfield redevelopment issues	47
3.6.6	Multicriteria analysis and GIS for territory – MAGISTER	49
3.6.7	Sustainable City – GIS software for urban management	52
3.6.8	Sustainable development indicators – the Dashboard	54
3.6.9	Global system for sustainable development	57
3.7	Research projects for brownfield regeneration	59
3.7.1	RESCUE regeneration of European Sites in Cities and Urban Environments	59
3.7.2	CABERNET Concerted Action on Brownfield and Economic Regeneration Network	61
3.7.3	SUBR:IM Sustainable Urban Brownfield Regeneration: Integrated Management	63
3.7.4	REVIT Revitalising Industrial Sites	63
Chapter 4	Methodology	
4.1	Methodology	70

4.2	Fuzzy Logic	70
4.2.1	Rule evaluation and the fuzzy associative memory	71
4.2.2	Fuzzification and membership functions	74
4.2.3	Defuzzification	76
4.3	Artificial Neural Networks	78
4.3.1.	Architecture of an Artificial Neural Network	83
4.3.2	Training an Artificial Neural Network	84
4.3.3	Transfer function of Artificial Neural Networks	85
4.4	Integration of fuzzy logic and artificial neural networks to GIS	87

## Chapter 5 The Decision Support System for Brownfield Sites Sustainable Regeneration

5.1	The Decision Support System – generalities	90
5.2	Mapbasic programming language	91
5.3	Input variables	95
5.4	Architecture of DSS	98
5.5	Implementation	100
5.5.1	Phase 1	101
5.5.2	Phase 2	109
5.6	Testing	114
5.7	Interface	115

## Chapter 6 Case Studies

6.1	Case Studies	118
6.1.1	French Case Studies	120
6.1.2	German Case Studies	123

6.1.3	Polish Case Studies	130
6.1.4	UK Case Studies	135
6.2	Test Case Study – Newport	142
Chapter 7	Interpretation of results	
7.1	Results	150
7.1.1	Interpretation of the results from case studies	151
7.1.2	Interpretation of the results from the test case – Newport	154
7.2	Considerations	155
Chapter 8	Conclusions	
8.1	Critique of the work	158
8.2	Final considerations	160
8.3	Issues	161
8.4	Potential Future Developments	163
Appendix A	Sustainability Indicators	
Appendix B	Case Studies Tables	
Appendix C	Data	

## List of Figures

2.1	Dimensions of sustainability	14
2.2	Pyramid of human needs	16
3.1	System Interface	41
3.2	Simple Influence Diagram	48
4.1	A simple block diagram of the control system	72
4.2	The rule structure and the rule matrix	74
4.3	The features of a membership function	75
4.4	The horizontal coordinate of the centroid	78
4.5	A basic artificial neuron	79
4.6	A model of a processing element	80
4.7	A simple neural network diagram	82
4.8	Example of feedforward network	83
4.9	Example of feedback network	84
4.10	Sample Transfer Functions	85
5.1	DSS Scheme	91
5.2	The DSS Algorithm	99
5.3	Newport Docks GIS Map	100
5.4	The developed ANN	112
6.1	Loisinord Site	121
6.2	The Loisinord ski piste opened in November 2006	121
6.3	Les Tertiales site	122
6.4	Map of the Ruhr area	123
6.5	Northward aerial view of the site	124

6.6	Listed shaft towers	126
6.7	Detail of the 3D model of the planned future use	127
6.8	Map location of Espenhain	128
6.9	Eastward aerial view of the site	129
6.10	Concept for the site and its surroundings	130
6.11	Ski slope at Sport Valley	131
6.12	Sosnowiec Coal Mine	133
6.13	Markham Employment Growth Zone	136
6.14	Markham Willows	138
6.15	The Gateshead Quay	140
6.16	The Baltic	141
6.17	The Old Town Dock area	143
6.18	Aerial view of the area	144

## **List of Tables**

5.1	Decoding Tables	102
5.2	SWG analysis for the case studies and the test case	106
5.3	Fuzzy Associative Matrix	108
5.4	Grade of sustainability	113
7.1	Results	150
7.2	Table comparing results for measure of sustainability	152
7.3	Comparison of results for type of redevelopment	153

# Chapter 1

## Introduction

### 1.1 The Brownfield Problem

Brownfields are abandoned or under-utilised areas normally within the urban core of a city. These sites are generally areas that have previously been built-on, yet have become derelict or have fallen into disrepair. Some sites may be contaminated. Brownfield sites are an important component of the government's strategy to develop sustainable urban communities.

Across the U.K., in general brownfield sites result from a wide range of former industrial activities, including mineral extraction, coal and steel production, gasworks, electrical generation, traditional engineering-based activities, transport infrastructure and chemical production, as well as a wide range of more minor industrial activities. In 1996, the Department of Environment (DOE) (now part of the Department for Environment, Food and Rural Affairs-DEFRA) published a series of nearly 47 "industry profiles," which provide information on the history of different industrial activities in the U.K. and identify the likely contamination problems to be found on the sites involved.

A National Land-Use Database was started in 1998 to assist in the identification of previously developed sites that might be, or might become, available for new development uses. Work continues on populating the database, but interim statistics released in May 1999 reveal there are some 33,000 hectares of land in England that

are previously developed and either vacant or derelict, and that might be suitable for redevelopment.

The UK Government has set the target, through the key national land use policy, to promote a sustainable pattern of physical development and land and property use in cities, towns and the countryside. This includes the following goals for promoting brownfield redevelopment:

- economic and social regeneration of the surrounding areas
- environmental improvement of the sites themselves
- reduction in "development pressure" on greenfield sites.

This objective is backed up by specific Public Service Agreement (PSA) targets for 60 percent of new housing to be provided on previously developed land or through conversion of existing buildings, and for brownfield land to be reclaimed at a rate of over 1,100 hectares per annum by 2004, reclaiming 5 percent of current brownfield land by 2004 (target over achieved) and 17 percent by 2010.

However, currently there is a lack of integrated and comprehensive knowledge on the condition, location and management of brownfield sites throughout the UK and little attention has been given to the contribution that brownfield sites make to biodiversity, nature conservation and amenity.

### **1.1.2 Progress**

In many urban areas of the U.K., the redevelopment of brownfield sites is led largely by the private sector. A significant proportion of projects take place with very little direct involvement from public bodies and government agencies, except in their roles

## Chapter 1 – Introduction

as regulators, issuing and enforcing necessary approvals and legal permissions (such as town and country planning). This private sector focus may be the result of a combination of the following four factors:

- the fact that most of the current brownfield land stock is already privately owned
- the particular "economic history" of the sites and the industries that were formerly on the land
- the current state of the national and regional economies and, in particular, the demand for land in urban areas
- conscious political choice by successive national governments.

However, there are also significant government programmes to promote and support brownfield redevelopment. These programmes can be split into four types:

- spatial planning – with the “Town and Country Planning Act”<sup>2</sup> which promotes brownfield redevelopment largely by inhibiting or preventing development projects on Greenfield sites, and by making brownfield land available for development;
- technical support – that takes proactive and reactive forms. Proactive, national government and other private sector-led groups fund research and development and the development of "best practice" advice to assist the development and construction industries in working on brownfield sites. On the reactive side, the focus is on removing factors that might inhibit brownfield redevelopment.



- financial support – brownfield redevelopment is eligible for direct public sector financial support where this is necessary to achieve social and economic policy objectives, whilst financial support for the private sector can take a number of forms such as grant aid, loans, guarantees
- direct development by public bodies and agencies such as preparation for development platforms for subsequent development by the private sector, simple site clearance projects.

## **1.2 The background to the development of the Decision Support System for Brownfield Site Sustainable Regeneration**

The decision making process for any problem usually encompasses:

- An identification phase in which the problem is identified;
- A development phase in which possible solutions are identified and developed;
- A selection phase in which the solution to be implemented is chosen;
- A monitoring phase to prove/disprove that the chosen option or set of options has been implemented.

Several "layers" of decision support can be distinguished: the input information, the tools to assist particular decision making issues, and the overall system in which decision making is applied. Decision support codifies specialist expertise in a way that allows its reproducible use by many. It integrates specific information about an area or more and general information such as legislation, guidelines and know-how,

## Chapter 1 – Introduction

to produce decision-making knowledge in a way that is transparent, consistent and reproducible.

The Decision Support System (DSS) has been developed to support decision makers to meet some of the challenges of the UK Government in brownfield redevelopment.

Gaps and obstacles in brownfield redevelopment have been reviewed extensively in the U.K. by a number of organizations, including the Parliamentary Office of Science and Technology and the Urban Task Force. Key challenges have been identified and these include:

- improving understanding of the social, economic and environmental factors related to brownfield redevelopment
- quantifying and assessing the contribution made by brownfield redevelopment to sustainable development
- integrating brownfield considerations into other aspects of regeneration, such as architecture and social development
- building confidence in brownfield regeneration (e.g. risk communication methods)
- developing tools to promote good practice in brownfield redevelopment (e.g. by demonstration of technologies, better integration of technical approaches with management needs)
- ensuring holistic approaches to managing large areas of brownfield, in particular in dealing with regional groundwater issues

## Chapter 1 – Introduction

- maximizing the benefits from brownfield regeneration (e.g. in terms of recycling and reuse of resources on the sites)
- developing cost-effective methods for assessing sites for contamination problems
- strengthening the evaluation of contamination management technologies (e.g. in terms of practicability, long-term effectiveness and their wider environmental and resource-use impact)
- improving approaches for communicating with and involving stakeholder groups.

The “Decision Support System” represents a tool to promote best practice in brownfield redevelopment through a heuristic approach.

### **1.3 The Decision Support System**

The work described in this thesis concerns the development of a Decision Support System for Brownfield Site Sustainable Regeneration. The project aims to develop a pilot system that can provide information and alternatives for sustainable brownfield regeneration as a platform to make decisions in this context.

One of the main characteristics of the Brownfield Site Sustainable Regeneration Decision Support System (BSSR-DSS) is its ability to process the input data (related to site characteristics), run simulations and assess/evaluate different scenarios in order to obtain the most sustainable solution.

## Chapter 1 – Introduction

The BSSR-DSS process input data relates to a wide range of sustainability indicators that have been developed in the European Project “RESCUE – Regeneration of European Sites in Cities and Urban Environments”<sup>1</sup>.

The system uses a Geographic Information System (GIS) called MAPINFO. This allows extensive information searches to be undertaken that can be site specific, and allows to create an user friendly interface.

In addition, GIS serves to facilitate brownfields redevelopment in three important ways:

- Continuity across the project and integration with other efforts—GIS for brownfields redevelopment can integrate historic, social, economic, and environmental data and can be managed across the life span of a project as it moves from assessment to cleanup to redevelopment and, finally, into full use where brownfields information will be integrated with other land use records, property management, and data.
- Project management tool—GIS can be used to join, display, and use a range of spatial and attribute data, both historic and current, to manage a multiphased, multistakeholder redevelopment project.
- Stakeholder relationships—Successful brownfields redevelopment depends on multistakeholder engagement to redevelop a site that meets the needs of community members and is economically feasible and environmentally responsible. A GIS system can be easily learned and used by all stakeholder groups to collect and compare a wide range of data and redevelopment options, reducing feelings of bias or unfair representation.

## Chapter 1 – Introduction

The aim of the BSSR-DSS is to provide the decision-makers with an easy and user-friendly tool able to formulate a basis for the decisions that would lead to improvement in the quality of derelict land recycling – in the context of sustainability of the built environment and the quality of urban life.

The system is designed for practical application by stake-holders such as public authorities, planners, architects, engineers and real estate owners that are involved in the complex processes of brownfield regeneration projects.

It is argued that the decisions made can contribute substantially to reducing the costs of land rehabilitation, and thus not only help to overcome the current obstacles in such projects, but also contribute to reducing the demand for greenfield development and conservation of natural resources.

Typically, when developers and other organisations have an interest in a brownfield site, they must perform an extensive information search to determine its planning and environmental status and identify a sustainable approach. An information search of this type could take days, weeks, or even months to compile.

The BSSR-DSS allows this search to take a matter of minutes once the input data are available. The results are also displayed in an easy to understand form.

### **1.3.1 *The scientific problem***

The scientific problem related to the development of the BSSR-DSS is the derivation of criteria for the sustainability of brownfield redevelopment related to economical, social and environmental aspects of a project.

But in particular, the problem involves the elaboration of methods and approaches using innovative mathematical techniques such as artificial neural networks and fuzzy logic to analyze and evaluate the input data (site characteristics and sustainability indicators) to produce a significant output.

The literature review undertaken, as shown later in the thesis, confirmed that no current system integrating the two above mathematical techniques has been implemented to date.

Artificial Neural Networks have been mainly utilised in concomitance with GIS for studies related to land use, whilst Fuzzy Logic has been integrated to other mathematical techniques to assist decisions related to site remediation.

### **1.3.2 The tasks**

During the development of the DSS the following tasks have been undertaken:

- Design of methods for comparing the indicators
- Adaptation of the criteria for sustainability developed by RESCUE to the system developed
- Elaboration of a mathematical model that measures the regeneration process
- Application, use and development of the code for fuzzy logic and artificial neural networks
- Development of a simulation process based on the developed mathematical model to compare different scenarios for the regeneration projects suitable for that area.

## **1.4 The thesis**

This thesis submitted for the degree of MPhil provides first an overview of the brownfield regeneration problem analysing the legislation framework for the U.K and the relation to the sustainability issue.

A review of the systems and software developed in this sector to provide assistance and support to those involved in brownfield regeneration is then presented. This is followed by an overview of current and past research programmes and projects undertaken at European Level to promote sustainability and best practice within the brownfield regeneration field.

The core of the thesis is the development of the BSSR-DSS and the methodology used. This includes an overview of the mathematical techniques utilised to implement the system.

To allow a successful and practical approach to the development of the system, real case studies have been utilised to test the software. A local site situated in Newport (Wales – UK) has then been utilised to test the system and compare results with a real situation. Details of all the case studies are also presented in the following chapters.

To conclude the thesis an interpretation of the results is presented, together with some suggestions for future developments and enhancements of the system.

## Chapter 1 – Introduction

### REFERENCES:

1. RESCUE (2005) - *Analytical Sustainability Framework*. Available from:  
<http://www.rescue-europe.com/html/results.html>
2. CLARINET Contaminated Land Rehabilitation Network for Environmental Technologies (2002) – *Brownfield and Redevelopment of Urban Areas*. Available from: <http://www.clarinet.at/library/brownfields.pdf>



# **Chapter 2**

## **Sustainability, Planning and the Legislative Framework for Brownfield Site Redevelopment**

### **2.1 Sustainability**

#### **2.1.1 *The sustainability concept***

In 1987 the concept of sustainability was made known and popular by the report 'Our Common Future' of the World Commission on Environment and Development (WCED)<sup>1</sup>. The Brundtland Report defines sustainable development as "a development that satisfies today's needs without the risk, that future generations will not be able to satisfy their needs." This definition was generally agreed upon world-wide.

This report was a major impulse for the United Nations Conference on Environment and Development (UNCED) in Rio de Janeiro in 1992. The main result of the Rio-conference was an action plan for sustainable development: the Agenda 21. 170 countries committed to start supporting sustainable development in their countries.

In May 1994 the European Commission and the city of Aalborg, Denmark, realised the first European Conference for Sustainable Cities and Municipalities to promote the realisation of chapter 28 in Agenda 21 and the development of local sustainability objectives. All cities that signed the Aalborg Charter in 1995 committed to start

Chapter 2 –Sustainability, Planning and the Legislative Framework for Brownfield Site  
Redevelopment

"Local Agenda 21"-processes. They also bound themselves to develop local action plans for long-term environmental and social urban planning by the end of 1996.

“Sustainability” is a frequently used word that is subject to a wide range of interpretations. Taken by itself, it conveys little more than a vague declaration of intent to ensure that present needs are not met in ways that will compromise future generations.

Without some relation to a particular frame of reference, however, the concept of sustainability has virtually no meaning at the level of practical problem solving. It is necessary to establish such a frame of reference in order to clarify the concept of sustainability.

In the relevant literature four dimensions of sustainability are distinguished:

- **environmental dimension:** resource use does not exceed the regeneration rate, decreasing consumption of non-renewable resources, no negative ecological impacts;
- **economic dimension:** direct and attractive benefits for stakeholders, fully internalised costs and benefits (including inter-generational and inter-national costs), and improvement of living standard of community
- **social dimension:** meet actual needs of community, equal access to benefits, resources and information, reduce social disparities;
- **institutional dimension:** compatible with local culture, share responsibilities, visible impacts on involved organisations and institutions; involvement into decision-making, legislative and fiscal framework.

These four dimensions are related to each other as illustrated in Figure 2.1.

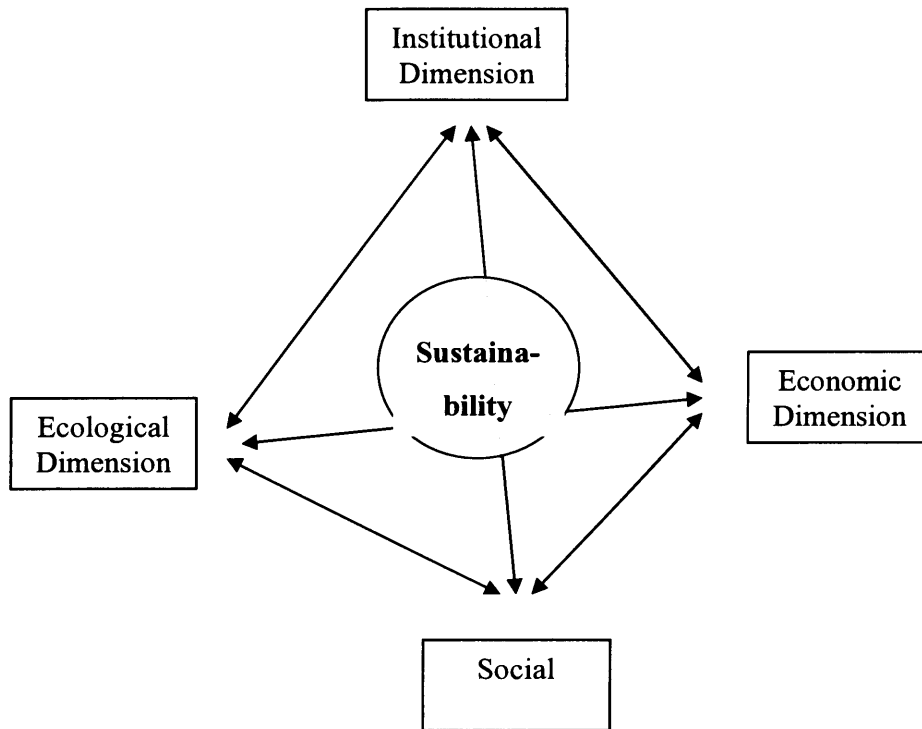

**Fig. 2.1 - Dimensions of Sustainability**

(Source: RESCUE (2005) – Development of an Analytical Sustainability Framework for the context of Brownfield Regeneration in France, Germany, Poland and UK)

### **2.1.2 Sustainability Definition in the context of Brownfield Regeneration**

The European Project “RESCUE – Regeneration of European Sites in Cities and Urban Environments”<sup>2</sup> has developed a sustainability definition, in the context of brownfield regeneration:

“Sustainable Brownfield Regeneration is the management, rehabilitation and return to beneficial use of brownfields in such a manner as to ensure the attainment and continued satisfaction of human needs for present and future generations in

Chapter 2 –Sustainability, Planning and the Legislative Framework for Brownfield Site  
Redevelopment

environmentally sensitive, economically viable, institutionally robust and socially acceptable ways within the particular regional context.”

Due to the fact that some of the terms used in the definition are broad they need some further explanation. The following explanations shall serve to provide a basis for the common understanding of sustainability in the brownfield context.

In 2000 the Organisation for Economic Co-operation and Development (OECD) provided the following definition of brownfield:

“Brownfield land is that (land) which is, or is likely to be contaminated as a result of former industrial, commercial or governmental operations.”<sup>3</sup>

The Contaminated Land Rehabilitation Network for Environmental Technologies in Europe (CLARINET)<sup>4</sup>, that is a Concerted Action within the Environment & Climate Programme of the European Commission DG Research, has developed a different definition for brownfield site. These are defined as:

- have been affected by the former uses of the site and surrounding land
- are derelict or underused
- may have real or perceived contamination problems
- are mainly in developed urban areas
- require intervention to bring them back to beneficial use

The expression “beneficial use” of brownfield land is linked to economic and social sustainability. The term demands direct and attractive benefits for all stakeholders

Redevelopment

within the affected region, including owners, planners/developers, future users, neighbouring communities. With respect to social sustainability the benefits should be distributed relatively equally among the stakeholders.

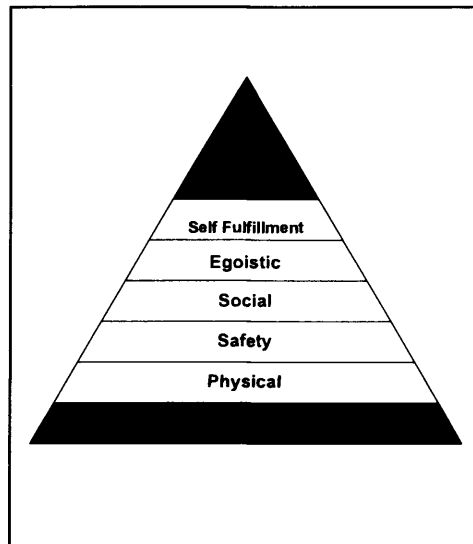

**Fig. 2.2 - Pyramid of human needs**

(Source: RESCUE (2005) – Development of an Analytical Sustainability Framework for the context of Brownfield Regeneration in France, Germany, Poland and UK and MASLOW 1970)

With regard to the four sustainability dimensions “beneficial use” of the resources would be broken down into: beneficial for the environment (e.g. improved ecosystem stability), beneficial for the stakeholders (e.g. in monetary terms); beneficial for the community (e.g. better living standard, development, increased social cohesion); beneficial for the development of sustainable institutions (e.g. fostering more efficient structures in administration, offering new opportunities of citizen participation). Brownfield regeneration and urban planning have also to satisfy human needs. In the late 1960's, Abraham Maslow<sup>2</sup> developed a theory of human needs and suggested an arrangement of them in a hierarchy of strength or potency. His theory is that the

Redevelopment

appearance of one need usually occurs after the prior satisfaction of another more important or more powerful need. That is, man strives to satisfy higher needs after the lower needs have been satisfied.

The hierarchic theory is often represented as a pyramid (see Figure 2.2), with the larger, lower levels representing the lower biological needs, and the upper point representing the need for self-actualisation. The five types of needs, in order of power that MASLOW identified are: physical needs, safety needs, social needs, egoistic needs and self-fulfilment needs.

According to Maslow's theory, different people or stakeholders will have different needs within brownfield regeneration and so will express different expectations.

Those people with unsatisfied security needs might look for immediate benefits (e.g. jobs, health situation) while those with unsatisfied social and esteem needs might look for social integration or prestigious roles in the redevelopment process.

Sustainable brownfield regeneration should satisfy at least the three bottom levels of needs for all stakeholders.

The rationale behind the phrase "present and future generations" is to undertake a form of site development that increases the flexibility of present and future generations to make decisions about their development. Present development should not compromise the needs of present and future generations in any of the sustainability dimensions; on the contrary, the options to choose should increase.

With regard to the environment, the expectation is that brownfield regeneration happens in an environmentally sensitive manner. A wide-reaching aim is that the

Redevelopment

overall environmental state is improving in the region of the project site in the long term by using renewable resources (air, water, plants, animals and biodiversity) in the process of brownfield regeneration. In addition, the negative environmental impacts emitting from the site should be reduced stepwise (noise, radiation, infiltration of dangerous substances).

In addition future infrastructure and buildings should be designed in a manner that facilitates simple deconstruction or easy adaptation to different uses.

From the economic point of view, sustainable brownfield regeneration should achieve a positive benefit-cost-balance for stakeholders in the short to medium term perspective. Economic sustainability needs a supportive environment, in particular with respect to institutions and markets. The economic environment should provide stability for the brownfield economy, for the political system, and for the affected society. The companies engaged in brownfield regeneration need clear and reliable rules, e.g. about taxes, environmental and social standards. At the same time companies need to maintain their flexibility to make new decisions and to adapt to changing framing conditions.

Institutions involved in brownfield regeneration should enable the stakeholders to improve and to develop their ability to manage these processes in a sustainable way even when framing conditions change over time. Therefore, the institutional structure between and within the stakeholders' organisations has to reflect the aspect of sustainability.

A brownfield regeneration process is socially acceptable when it meets the actual (as well as the known and expected future) needs of the communities in the region. It also

has to consider the aspect of maintenance or increase of development chances for future generations.

### **2.1.3 Sustainability Indicators**

In the current literature a wide range of sustainability indicators, related to different issues, have been developed from different organisations and research programmes. Some examples are provided below. In the particular context of brownfield regeneration, the European Programme “RESCUE – Regeneration of European Sites in Cities and Urban Environments” represents the first effort to develop a set of sustainability indicators for this field<sup>2</sup>.

The OECD has developed a set of indicators to evaluate environmentally relevant services and political action on an international level and to standardise complex information on the environment<sup>3</sup>. The set has limited its focus on environmental problems, their triggers and human reaction to simple cause-effect relations excluding further social and economic impacts. The focus of the national and international research level makes the OECD indicator set unsuitable for issues of brownfield regeneration and decontamination. More specific information on how (e.g. state of the site, decontamination methods), why (e.g. type of previous use) or on the consequences (e.g. reuse of brownfields) cannot be obtained with this indicator set.

The United Nations Commission on Sustainable Development (UNCSD) established to control the implementation of Agenda 21, released a set of 134 indicators for testing on the national level<sup>5</sup>. The commission’s objective is to develop a global wide applicable set of indicators in order to harmonise international activities aiming at



Chapter 2 –Sustainability, Planning and the Legislative Framework for Brownfield Site  
Redevelopment

sustainable development. This set includes social, environmental, economic and institutional aspects of sustainability<sup>6</sup>.

Since 2000 the European Environmental Agency (EEA) publishes annually an environmental indicator report on selected political issues<sup>7</sup>. The objectives are the continuous reporting of the state and development of the environment and the promotion of sustainable development in Europe.

As mentioned above, RESCUE has developed a set of sustainability indicators for brownfield regeneration. The process was undertaken on the basis of the following criteria:

- indicators must be measurable in qualitative or quantitative terms and can be surveyed in a suitable frequency;
- indicators are horizontally comparable (between regions or nations) and vertically compatible (nation – region – municipality) over a certain period;
- indicators cover the four sustainability dimensions;
- indicators are relevant for planning and political decisions;
- indicators describe trends and changes, they assess trends with regard to sustainability;
- indicators are generally comprehensible, logical, scientifically meaningful, specific, reliable, communicable, simple, valid;
- indicators aggregate data to volumes that can be processed, neither too abstract nor too detailed;

- development, deduction, selection and weighting of indicators are transparent;
- indicators are precautionary, and not reactive.

## **2.2 UK Planning and Legislation Framework**

The processes of brownfield redevelopment are governed by complex regulatory frameworks that can act as drivers and barriers to sustainable urban regeneration. These barriers and drivers are both legal and financial in nature. In order to tackle the financial barriers to brownfield redevelopment, a range of fiscal incentives have been made available, by the government to private developers, to encourage them to view brownfields as potentially profitable opportunities. These fiscal incentives have been backed-up by changes to the principles and practices underpinning the institutions of the British spatial planning system with a greater emphasis on increasing brownfield development at the expense of greenfield sites.

The system of *Town and Country Planning Act 1990* promotes brownfield redevelopment largely by inhibiting or preventing development projects on greenfield sites, and by making brownfield land available for development. This is brought about by a hierarchy of:

- national planning policy (set out by national government in Planning Policy Guidance notes);
- regional planning policy (set collectively by local government bodies in the region and the Regional Development Agency), which also includes overall “structure” planning for the region;

Redevelopment

- local structure and development plans (set by the county and district councils) which make zoning decisions for the future use of particular areas of land in the area, and
- individual decisions on applications for planning permission (made by local planning authorities) which normally should conform with the relevant development plan.

In 1991 the Government introduced the concept of the *plan led planning system*. Local Authorities are required to produce development plans for how they see their area being developed. This means that in making planning decisions it is necessary to decide whether the proposal is in accordance with the ‘Development Plan’ for the area and then to take into account other material considerations.

The objectives of the plan-led system are to ensure rational and consistent decisions, to achieve greater certainty, to secure public involvement in shaping local planning policies, to facilitate quicker planning decisions, to reduce the number of inappropriate planning applications and unnecessary appeals.

Local Planning Authorities decide whether applications are approved. Refusals can result in public inquiries where evidence is heard by a Planning Inspector. The Secretary of State can “call in” applications in certain circumstances for direct determination.

At the top of the plan led-system is national guidance from the former DETR and DTLR (now the Office of the Deputy Prime Minister – ODPM), which consists of Planning Policy Guidance Notes (PPGs), Minerals Policy Guidance Notes (MPGs),

Chapter 2 –Sustainability, Planning and the Legislative Framework for Brownfield Site  
Redevelopment

and Ministerial Circulars. The PPGs give ‘guidance’, the Secretary of State has a range of sanctions to ensure that Local Planning Authorities follow the advice, and of course Planning Inspectors will decide appeals in the light of PPGs. It should be noted that the said PPGs are continuously being updated and revised and there are a number of consultation drafts and recent decisions at any one moment in time.

Below national policy comes Regional Policy. This was issued by the former DETR in July 1994 (RPG10). The current guidance covers the period up to 2011. RPG was in the past criticised for being a reiteration of national policy, so a new system has been introduced. This involves a wider range of policies and more specific ‘spatial’ policies on the physical distribution of development. RPG will also form the framework for Local Transport Plans and Regional Development Agencies Strategies. In consequence it will need to more directly address regional issues than was previously the case.

The government, through the *Planning and Policy Guidance 3: Housing (PPG3)* has increased the targets for regional/local planning authorities to reach in respect to redeveloping brownfield land from 50% to 60%<sup>8</sup>. This means that before allocating any greenfield land for new housing projects, a local planning authority has first to satisfy itself that there are no suitable and available sites in the area which have been previously developed.

In November 2006 this guidance was replaced by *Planning and Policy Statement 3: Housing (PPS3)*. PPS3 puts in place a new national policy framework for planning for housing at the local and regional levels<sup>9</sup>. It provides an enabling framework for local planning authorities, working with their stakeholders, including developers, to deliver

Redevelopment

both the right quantity of housing to address need and demand in their areas, and the right quality and mix of housing for their communities. In the context of brownfield sites, PPS3 restate that the national annual target is that at least 60 per cent of new housing should be provided on previously developed land. This includes land and buildings that are vacant or derelict as well as land that is currently in use but which has potential for re-development.

The UK Government has identified areas of growth in areas such as the Thames Gateway and Milton Keynes where considerable brownfield and contaminated land exists alongside economic deprivation and housing shortages. In order to address this, it has given its main regeneration body, English Partnerships, a lead role in identifying and supporting development activities that will bring these sites back into productive use.

In September 2003, English Partnerships published *Towards a National Brownfield Strategy*. This report assessed the state of England's brownfield land supply and highlighted that there is a huge potential to recycle brownfield land to meet government housing growth targets, while reducing the pressure to develop on our countryside<sup>10</sup>.

One of the most important findings of the report is that as much as a third of the 66,000 ha of brownfield land identified in the National Land Use Database (NLUD) could be readily available for development – contributing significantly to government targets of developing 60 per cent of housing on brownfield land<sup>11</sup>.

Other key findings of the report are:

Chapter 2 – Sustainability, Planning and the Legislative Framework for Brownfield Site  
Redevelopment

- Nearly one-third of the brownfield or previously developed land (PDL) identified is contained within the key "growth area" regions (i.e. Greater London, South East and East of England).
- Only one-sixth of the total hardcore PDL (i.e. land that has been vacant or derelict for nine years or more) is to be found in these growth regions, suggesting fewer barriers to the long-term regeneration of brownfield land.
- The target of achieving 60 per cent, or more, of new homes on brownfield land should continue to be achievable in the foreseeable future.

The findings, along with a series of recommendations, were the basis for the National Brownfield Strategy for England, which was outlined in the Sustainable Communities Plan<sup>12</sup>.

In February 2003, the government produced *Sustainable Communities: Building for the Future* which set out the government's plans for tackling housing shortages in the South East and low demand in Northern areas of London<sup>12</sup>. This plan reaffirmed the government's commitment to using the planning system as a key instrument in delivering on brownfield regeneration.

Another driver - and at the same time a possible barrier - to brownfield regeneration, is the development in recent years within the UK of legislation with the aim of providing clearer regulation of contaminated, the *Part IIA policy*<sup>13</sup>. The current policy regime for dealing with contaminated land in the UK is geared towards operating along the grain of the development cycle by which British planning system operates. It provides a clearer definition of the distinction between 'brownfield land' and

Redevelopment

‘contaminated land’ and sets out a system regulating their remediation. In practice, the system offers considerable scope for discretion and flexibility to local actors to ensure that brownfield regeneration proceeds at a steady rate. However, the system, if operated rigidly, can impose significant costs upon developers, and the exchequer, posing a threat to the successful regeneration of economically unproductive areas as private developers push for more greenfield land on which to develop.

Chapter 2 –Sustainability, Planning and the Legislative Framework for Brownfield Site  
Redevelopment

REFERENCES:

1. World Commission on Environment and Development (WCED 1987) – The Report of Brundtland Commission, Our Common Future – published by Oxford University Press
2. RESCUE (2005) – *Development of an Analytical Sustainability Framework for the context of Brownfield Regeneration in France, Germany, Poland and UK.* Available from: [http://www.rescue-europe.com/download/reports/1\\_Analytical%20sustainability%20framework.pdf](http://www.rescue-europe.com/download/reports/1_Analytical%20sustainability%20framework.pdf)
3. Organisation for Economic Co-operation and Development (OECD 2005) – *Key Environmental Indicators* – Environment Directorate
4. CLARINET Contaminated Land Rehabilitation Network for Environmental Technologies (2002) – *Brownfield and Redevelopment of Urban Areas.* Available from: <http://www.clarinet.at/library/brownfields.pdf>
5. United Nations Commission on Sustainable Development (UNCSD 2001) – *Indicators of Sustainable Development.* Available from: <http://www.un.org/esa/sustdev/natlinfo/indicators/isdms2001/table4.htm>
6. United Nations Commission on Sustainable Development (UNCSD 2006) – *Global Trends and Status of the Indicators for Sustainable Development.* Available from: [http://www.ec.gc.ca/soer-ree/English/resource\\_network/bg\\_paper1\\_e.cfm?StrPrint=true&](http://www.ec.gc.ca/soer-ree/English/resource_network/bg_paper1_e.cfm?StrPrint=true&)



Chapter 2 –Sustainability, Planning and the Legislative Framework for Brownfield Site  
Redevelopment

7. Smeets E. and Weterings R. (TNO Centre for Strategy, Technology and Policy, The Netherlands 1999) - *Technical report No 25 - Environmental Indicators: Typology and Overview* – European Environmental Agency (EEA)
8. Communities and Local Government (2000) - *Planning and Policy Guidance 3: Housing (PPG3)* - DETR (London: The Stationery Office)
9. Communities and Local Government (2006) – *Planning Policy Statement 3: Housing (PPS3)* – London: The Stationery Office
10. English Partnerships, The National Regeneration Agency (2003) – *Towards a National Brownfield Strategy*. Available from:  
<http://www.englishpartnerships.co.uk/brownfieldstrategy.htm>
11. National Land Use Database (2002) - *NLUD Previously Developed Land (PDL): Data Specification v2.2*. Available from:  
[http://www.nlud.org.uk/draft\\_one/key\\_docs/nlud\\_pdl\\_pubs.htm](http://www.nlud.org.uk/draft_one/key_docs/nlud_pdl_pubs.htm)
12. Office of the Deputy Prime Minister (2003) – *Sustainable Communities: building for the future* – ODPM (London: The Stationery Office)
13. Department of Environment, Food and Rural Affairs (DEFRA 1994) – *Environmental Protection Act 1990: Part IIA* – Available from:  
[http://www.opsi.gov.uk/acts/acts1990/Ukpga\\_19900043\\_en\\_1.htm](http://www.opsi.gov.uk/acts/acts1990/Ukpga_19900043_en_1.htm)

# Chapter 3

## Literature Review

### 3.1 Introduction

The existing literature focuses on specific areas related to brownfield regeneration for example urban land management.

Below a general overview is given of the use of fuzzy logic and artificial neural networks, this also includes their application to issues related to the brownfield regeneration problem.

In addition an overview is provided of existing software and decision support systems. Finally the literature review has identified a range of research projects and programmes that have been funded in order to tackle the problem at national and international level. See references for general review<sup>1</sup>.

### 3.2 Artificial Neural Networks

The current literature highlights that Artificial Neural Networks have been mainly used in the brownfield regeneration problem for issues related to land cover and land use.

Some examples are presented below.

### **3.2.1 Examples of use of Artificial Neural Networks**

One of the areas where Artificial Neural Networks are frequently used is mapping land cover. Accurate and frequently updated land cover maps of environmentally protected areas are necessary for the management of legislation programs governed by the EU, national authorities and local environmental schemes.

A study undertaken by the University of Newcastle Upon Tyne<sup>3</sup> has analysed the suitability of ANN for mapping and monitoring land cover over regional areas, such as National Parks, using both hard and soft classification approaches together with the high spatial resolution of multispectral Carterra™ Geo IKONOS imagery. The study aimed to examine the transferability of remote sensing mapping algorithms over Northumberland National Park (NNP) located in Northern England.

The ANNs were trained using ground data of eight different upland vegetation classes and applied to a multispectral IKONOS image of NNP. The ANNs applied consisted of a Multiple Layer Perceptron (MLP), using a conjugate gradient descent, and one hidden layer with a varying number of hidden nodes and combinations of weights. The transferability of ANNs was found to depend on the ability to generalise, which could be improved by applying early stopping in the training process, improving the accuracy of the validation data by an average of 15%. Limitations and issues regarding the transferability of MLP ANNs were observed to be significant. Advanced ANN algorithms such as Support Vector Machines were required to enable the use of ANNs for mapping and monitoring land cover.

Another example is the use of Artificial Neural Networks for Multi-objective land use optimization that has been developed at the Department of Geography, Friedrich-

Schiller-University Jena, Germany<sup>4</sup>. Managing a catchment for drinking water supply with a high proportion of agricultural land use typically requires the maintenance of a reasonable balance between water quality demands and the costs for the resulting restrictions for the farming industry. A core part of this task therefore is multi-criterion decision making. Approaches to multi-criterion decision analysis often assume either a small number of alternative solutions to the decision problem or a simply structured solution space. For catchment management problems none of these properties can be assumed: the consideration of lateral flows of substances affecting the water quality in the catchment results in highly complex solution spaces that have to be explored. Searching for an optimal solution of the problem in addition requires the consideration of a large number of solution candidates for the problem. This makes finding an optimal decision a practically intractable task. The method developed is based on artificial neural networks (ANN) that are able to find good approximations to the optimal decision. For this purpose an ANN was computed to represent the hydrological topology of the catchment. A modified ANN learning procedure was then used to find farming restrictions for the single fields of the catchment area that guarantee the desired water quality at near minimal costs. These restrictions can be used to produce justifiable land use management decisions.

### **3.3 Use of a Belief Function and Artificial Neural Network in Brownfield Redevelopment Decision Making**

Decision making in brownfield infrastructure regeneration necessitates the consideration of a multiplicity of complex, interrelated issues. The use of belief function integrated with ANN can help to combine independent evidence from various issues to determine the overall uncertainty in redevelopment decision making.

### Chapter 3 – Literature Review

The belief function is the representation of uncertain knowledge in the form of basic probability assignments in which probabilities can be assigned to directly form subsets of states of nature.

The system takes into consideration the main issues related to brownfield redevelopment: technical, liability, financial, community concerns, and redevelopment prospects.

Then an artificial neural network is constructed on the basis of the final output requested. For example it is assumed that the overall payoff (economic benefit from redevelopment) of the final decision with regard to brownfield infrastructure depends on site remediation and site redevelopment. The system builds the artificial neural network with the arrows showing the dependencies and nodes representing the relationships and items representing the objectives.

Using the Dempster's rule of combination<sup>5</sup> the system is processed adding the judgments made by the decision maker about the level of support obtained from the procedures for the respective nodes.

The output is represented by tables with a measure of the uncertainty and it is achieved by using the Dempster-Shafer theory<sup>5</sup>. The values can change when more information and data are added. This makes the methodology more dynamic and a form of sensitivity analysis tool in brownfield infrastructure redevelopment processes.

### 3.4 Integrated Simulation System of GIS and ANN for Land Price Appraisal

This paper describes an automatic simulation system implemented to forecast the change of parcel-based land price caused by urban planning alteration. The system integrates forecasting knowledge-based urban model, artificial neural network (ANN), and visual geo-referencing tool, GIS, within Visual Basic framework.

A land price simulation system (LPSS)<sup>6</sup> is developed combining two sub-systems, ANN and GIS. After training the ANN model with the data taken from Chinju City in Korea, the impacts of ‘new road plan’, ‘park’, ‘height control district’ and ‘beauty district’ on land price are simulated. The simulation results are visualized with Esri’s Map Objects.

Most of the input variables regarding to land attributes, public land regulation, land use and topology were selected from the Land Price Calculation Table. All the variables are categorized and preprocessed through equation (1) to fasten the training speed and raise model’s accuracy.

$$p_n = 2 \cdot (P - \min P) / (\max P - \min P) - 1 \quad \text{-----}(1)$$

where  $P$  is primary input vector,  $\min$ ,  $\max$  is minimum and maximum value of whole primary input data and  $P_n$  is adjusted value of input vector.

If the output is correct within acceptable error range, the ANN stops training and becomes able to forecast the land price of that area. The knowledge gained during the training is stored in the link weight ( $W$ ) of ANN.

The network was trained firstly with whole study area of about 12,000 parcels. However, in this case, training did not converge even after running over 24 hours on Pentium II-400. For the substantial application to real world, the sample size was reduced to the ‘Dong’ that is basic administrative unit in Korea. Among nine ‘Dongs’, where all four type of simulation items are applied to, Namsung was selected for demonstration. Namsung has 348 parcels including 42 parcels of new road construction plan and 171 parcels of park, 147 parcels of maximum height control district and 30 parcels of beauty district. The network was trained as changing the learning iteration time or learning rate.

Results and performance of the system are considered over expectancy therefore the system has been utilised by other municipalities.

### **3.5 Fuzzy Logic and Brownfield Regeneration**

The current literature highlights that Fuzzy Logic has been mainly used in the brownfield regeneration problem for issues related to mapping, in particular urban land use mapping, multiscale representation of brownfield sites and the detection of urban brownfields by means of high resolution satellite imagery.

Some examples are presented below.

#### ***3.5.1. Examples of Fuzzy Logic integrated to Brownfield Regeneration***

In 2002 the Ministry of Environment and Energy, Denmark undertook a research to develop a fuzzy logic approach to urban land use mapping<sup>7</sup>. Traditionally, urban land-use mapping is based on orthophotos and satellite images, but deriving land-use from remote-sensing alone is not satisfactory.

### Chapter 3 – Literature Review

The use of fuzzy logic to monitor, analyse and model the urban environment was developed on the basis of data available from the Danish Building & Dwelling Register, which is a database containing detailed information like year of construction, use, area etc. This database provides a useful foundation for urban land-use mapping. Generally, land cover and land-use mapping are based on crisp classification, but the innovation was to apply a fuzzy modelling approach to land-use mapping. The approach consisted in the calculation of fuzzy membership values for each urban land-use class and to group individuals into fuzzy sets or classes. This was based on the so-called Semantic Import model where a membership function is pre-defined without any reference to the data. The class limits were specified based on experiences or definitions before individuals were allocated on the basis of how close they matched the requirements of the classes.

Fuzzy classification offers a better choice in urban land-use mapping, because it can indicate the primary, secondary etc. land-use simultaneously. This offers more meaningful information for planners and a more detailed understanding of the land-use patterns. As result of this research and based on these principles, a nation wide urban land-use database for the year 1997 was established.

Another application of fuzzy logic to brownfield sites was developed by the Environmental Protection Agency in US<sup>8</sup> under the Brownfield Land Recycling Program that aimed to create a Brownfield Sites Inventory database listing environmentally impaired vacant and abandoned or under used land. The emphasis of the project was to launch the detection of potential brownfield sites and to provide the specific spatial data for communities.



### Chapter 3 – Literature Review

On this basis a multispectral Ikonos imagery was used (Space Imaging, LLC). Three overlapping flight paths were taken on the very same day to cover the entire City of Baltimore. In order to orthorectify the images the cubic convolution algorithm was applied. The innovation was the use of object oriented classification method as any multispectral classification scheme would fail to detect such a highly heterogenic object class. Image segmentation, fuzzy classification, and structure type assignment was performed by means of eCognition software. This software follows a new, object oriented approach towards image analysis.

The concept behind this software program was that important semantic information necessary to interpret an image was not represented in single pixels, but in meaningful image objects and their mutual relationships. So first the image was structured into user-defined homogeneous segments in any desired resolution, then the classification procedure could follow.

The segmentation algorithm entailed the simultaneous representation of image information on different scales. This procedure detected local contrasts and was especially designed to work with highly textured data, such as Ikonos, Quickbird, or digital orthophotos. The classification process was based on fuzzy logic, to allow the integration of a broad spectrum of different object features such as spectral values, shape, or texture.

This fuzzy logic approach led to the characterisation and description of distinct urban land use categories. The resulting information was integrated in a rule based system on a higher level of image analysis on which classified land use objects were combined to semantic structure groups, in this case potential brownfield sites.

The assumption underlying this approach was that potential brownfields sites are a land use type that follows a certain pattern (i.e. consisting of buildings, roads or road access, impervious surface and neglected green spaces) so that each object can first be classified and then be composed to a variation of structure groups).

The system developed presented some advantages such as the possibility of assigning potential brownfield sites for entire city, the possibility of modifying the approach for specific characteristics and the possibility of comparing information with GIS data.

However disadvantages were identified too, such as the fact that remote sensing only offers a bird's eye perspective and that very high resolution data sets need to be available.

### **3.6 Software and decision support systems**

The sustainable brownfield regeneration problem is a complex, multi-parameter field where it is unlikely that any single person will have the knowledge to perform all the analysis required in supporting the overall decisions.

For this reason, decision support systems and software have been developed at National and International level from a wide range of sources (Universities, Corporation, Governments and so on).

In general these systems provide user friendly toolkits for the decision makers. Some of the ones identified in the literature review are only focused on a certain area of the brownfield regeneration problem (e.g. contamination, public participation, land use). Others provide useful databases of information for defined sites that can be use by the players in making decisions.

### Chapter 3 – Literature Review

Geographical Information Systems (GIS) and mathematical models have been used to enhance the performance of the software or decision support system in order to include various elements of the regeneration process and provide a sustainable system able to support and advise final decision makers.

Corporations and companies have developed software that uses GIS to solve a particular issue related to brownfield regeneration. For example Kleinfelder has developed a GIS-based brownfield analysis for the environmental issue where all the site characteristics are stored and then an analysis is performed for the site selection based on certain criteria (such as zoning, location, environmental issues, acreage and so on).

In the following paragraphs an overview of the systems developed to date is provided.

#### **3.6.1 GIS for brownfield TOOLKIT**

Environmental Systems Research Institute, Inc (ESRI), the world leader in geographic information system (GIS) technology, and International City/County Management Association (ICMA), a US premier local government leadership and management organization, have teamed together to produce a new virtual library with resources for using geographic information systems (GIS) for brownfield redevelopment. GIS can assist brownfield redevelopment professionals in many facets of their work, from conducting brownfield site inventories to collecting data for environmental remediation to marketing properties for redevelopment. The ESRI-ICMA GIS for Brownfields Toolkit contains conference presentations, reports and articles, and an extensive list of Web resources for communities wanting to use GIS in their brownfields redevelopment.

### Chapter 3 – Literature Review

Original case studies produced specifically for the toolkit share the experiences of three communities— Hillsborough County, Florida; Spokane, Washington; and Worcester, Massachusetts—in using GIS for brownfields redevelopment. Hillsborough County uses GIS maps to help citizens understand the potential impacts of brownfields efforts and involve them in future planning discussions<sup>1</sup>.

Spokane found GIS helpful in planning and setting priorities for its brownfields program, and Worcester developed a special GIS application— the brownfields redevelopment inventory query—to help manage its brownfields redevelopment efforts.

BRIQ (the brownfields redevelopment inventory query) is a database that catalogues all potential sites along with other factors such as major roads, sewer and water infrastructure, environmental zones, Massachusetts DEP (Department of Environmental Protection) records, and tax records.

BRIQ has mainly two applications:

- Cross reference between DEP, City Assessing zoning and other records in one database
- Ability to produce reports on completed brownfield projects in City

In particular BRIQ organizes disparate information using location, provides quick information look-up, and allows custom searching to fit the needs.

Through the system, city planners have access to local, state, and federal information regarding the characteristics of land parcels in Worcester.

### **3.6.2 London's Brownfield Resource Pilot Project: the Wandle Valley**

The Centre for Advanced Spatial Analysis, University College London developed a short term pilot study to evaluate the contribution of a GIS for decision support and for “discussion support”<sup>9</sup>.

The project developed a system for the Wandle Valley, covering the London boroughs of Wandsworth, Merton, Sutton and Croydon. The ArcView GIS was used to assemble, store, manipulate and display geographically referenced information relating to brownfield sites and their locality such as shopping areas, public transport routes.

This project does not appear as a decision support system able to provide suggestions but only as a survey of the current state of the brownfield sites in that area.

The system has been created to encourage more sustainable and environmentally friendly development of brownfield sites. This was done using an iterative development approach supported by a series of four seminars and a public participation workshop.

The Brownfield system allows the integration of diverse environmental, social and economic datasets relating to brownfield sites such as urban areas, areas of nature conservation, and archaeology and transport networks as shown in Figure 3.1. These different layers of information were integrated with an Ordnance Survey Meridian backdrop.

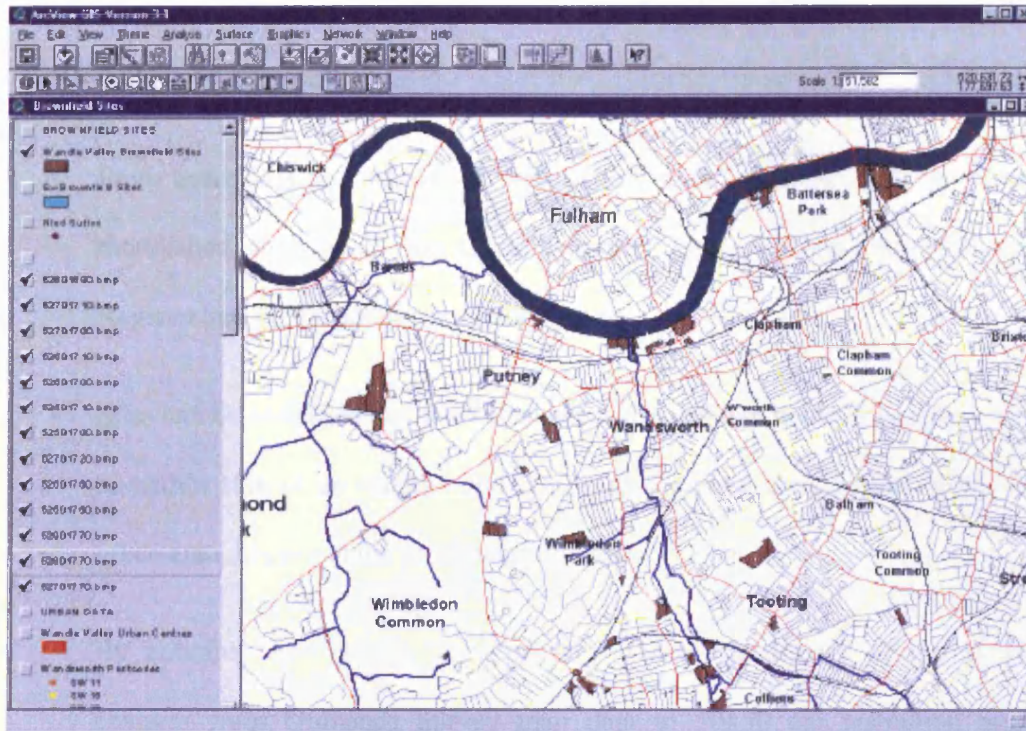

Fig. 3.1 – System Interface

(Source: Boot H.R., (2000) – *London's Brownfield Resource Pilot Project: the Wandle Valley* – Centre for Advanced Spatial Analysis – Working Paper 14.

Available from:

<http://www.casa.ucl.ac.uk/publications/workingPaperDetail.asp?ID=14>)

The system has a diverse range of capabilities including:

- Quick and easy to use location tool dependant on the first three digits of the postcode
- Brownfield sites proximity to floodplains and environmentally sensitive areas can be quickly and easily identified
- Site-specific information and photographs of certain sites can be accessed using a web-interface by 'clicking' on the individual brownfield site

### Chapter 3 – Literature Review

- Easy to understand graphics as they are based on familiar, well-labelled Ordnance survey data
- From individual brownfield site web pages, other hypertext links have been established such as to the Local authority pages, Wandsworth Planning Register and independent community groups
- Sites can be identified that meet certain criteria through network analysis, such as within 1km of an underground station or shopping area, within 400m of a green area, but not in the predicted flood one
- By zooming into certain ‘high priority’ areas, the display of the system changes from Ordnance Survey map data to 50x50 cm resolution aerial photography<sup>10</sup>

In my opinion the completed system provides a useful tool that demonstrates the advantages that GIS has over more traditional mapping methods; its ease of integrating diverse datasets, updating and Internet links to name a few.

#### ***3.6.3 A GIS-based decision support system for brownfield redevelopment***

The Department of Resource Development, Michigan State University developed in 1999 a GIS-based decision support system for brownfield redevelopment.

The DSS provides access to state, regional and local geospatial databases, several informational and visualisation tools, and assumptions useful in providing a better understanding of issues, options, and alternatives in redeveloping brownfields.

### Chapter 3 – Literature Review

The purpose of the project was to build a prototype brownfield decision support system that could be applied statewide in making siting decisions. Such a system took advantage of existing state, regional, and local geospatial databases; web-based tool that creates an inventory of brownfield sites; GIS-based visualisation models and decision criteria; and extensive public interaction.

The information system uses an innovative resource-modelling application called Smart Places that provides different scenarios. These are used to compile the data, integrate siting objectives and constraints, and assess impacts of various land-use options.

The study area used was Jackson County Brownfield Redevelopment Zone, which included 19 townships in Jackson County, Michigan. Although the site is geographically isolated from other major population centres in Michigan, it is being influenced by expansion from Washtenaw County to the east, Ingham County to the north and Kalamazoo-Battle Creek to the west.

To develop the system, site selection criteria were developed by a series of facilitated workshops attended by the representatives of local units of government in Jackson County. Participants identified a systematic approach and agreed that the site screening criteria needed to reflect several factors:

- Factors that are generally used in the art and science of locating commercial real estate
- Incorporation of local conditions such as infrastructure, site characteristics, and financial incentives



### Chapter 3 – Literature Review

- Local restrictions including zoning ordinances, master plans, and community acceptance.

These criteria were added to the decision support system. The toolset also included site attributes for the inventoried brownfields site study areas and selected brownfield site characterization and environmental, social, and economic development indicators.

The process by which site information was compiled in this decision support system and alternative site development options evaluated includes input in the GIS (ArcView) and Smart Places of the data layers, indicators, and measurements assumptions. In particular several factors like legal restrictions, environmental regulatory requirements, physical restrictions, community desires, brownfield site selection and weighting factors were taken into consideration.

These factors are then reviewed based on an evaluation of similar proposals and an assessment of environmental effects. A preliminary analysis is provided to the developer and to municipal decision-makers. Over 90 individual brownfields in Jackson County were identified, characterized and ranked for redevelopment (industrial or commercial one).

This project represented a testbed for decision makers<sup>11</sup> and policy analysts at all levels of government to establish urban land use policy and development guidelines that may be applicable to related land use issues in a variety of urban and urbanising settings.

### **3.6.4 DESYRE – Decision support system for rehabilitation of contaminated sites**

A DEcision Support sYstem for the REqualification of contaminated sites (DESYRE) has been developed for the identification of the most effective rehabilitation interventions. The DSS is based on a Geographic Information System (GIS) framework and integrates environmental and technological databases, risk assessment models, and multi criteria procedures.

DESYRE tries to solve the problems related to contaminated macro-sites rehabilitation in three main fields: site characterization and data processing, evaluation of the risk, choice of proper remediation technologies<sup>12</sup>. The aim is to support the expert to gain a comprehensive view of the rehabilitation process and to choose the best solution.

The system is composed of five modules: characterisation, risk, socio-economical and technological analysis, and decision. The characterisation module provides all the available information on the site (e.g. chemical and hydrogeological data). It can be explored by means of GIS tools and its database is available as input to statistical and geo-statistical software, as well as to hydrogeological and contaminant fate and transport models. Moreover, it provides the definition of efficient sampling strategies, definition of contaminant distribution, prediction of transport processes and input parameters for the risk assessment module.

The risk assessment module includes exposure and risk assessment models and provides outputs such as risk maps. The main goal of this module is to integrate the environmental evaluations into the decisional process or the rehabilitation of

### Chapter 3 – Literature Review

contaminated sites. The risk analysis applied to contaminated sites is a technical procedure carried out to define risks posed by the site contamination to the human health and the land remediation interventions on the basis of the site characterisation, the qualification of human receptors exposure to the contaminants, and the contaminants toxicity assessment. The socio-economical assessment module addresses socio-economical constraints and benefits.

The technological assessment module allows feasibility, advantages, limits and costs of different techniques to be assessed. This is developed to a stepwise structure: the first step selects suitable technologies, the second one finds out where it is necessary to remediate and how.

The information from the three assessment modules, mainly in the form of indicators, are integrated in the final decisional module by means of the multi-criteria analysis (MCDA), which can play a key-role to simplify effectively this process.

In the DESYRE framework, the MCDA tools appear twice. At the beginning, when a pool of suitable technologies is to be defined, a MCDA module assigns a score to each technology on the basis of key-criteria like cost, development time, efficiency, reliability and so on. This method is applied to each set of technologies chosen by the expert. In a second level, each remediation scenario proposed by the Expert is evaluated by the Decision Makers in a Group Decision Making context.

DESYRE requires an active role of the Expert in order to avoid any simplifications triggered by a non user oriented application to the DSS<sup>13</sup>.

### **3.6.5 Conceptual Framework for Understanding Brownfields Redevelopment Issues (Bayesian Influence Diagrams)**

The Department of Civil and Environmental Engineering at Florida International University demonstrates the use of Bayesian influence diagrams, a formal decision analytic tool, as a qualitative tool for modelling the complex relationships that exist among fundamental brownfield redevelopment issues.

These models are powerful tools for clarifying and communicating the significant relationships that exist between important issues and variables in brownfield redevelopment<sup>14</sup>.

Brownfield redevelopment decision making must deal with the following fundamental issues: technical (relating to the availability of feasible remediation technologies), legal liability (relating to uncertainties over the types and extents of legal liability associated with a site), financial (relating to the availability of viable options for financing site assessment, remediation, and redevelopment), community concerns (relating to public health and environmental resource protection), and site redevelopment prospects.

The Bayesian influence diagrams are graphical tools for representing decision problems as shown in Figure 3.2 and they contain all the components of a decision problem, that is, the decision objectives, decision options, values, uncertainties, and the relationship among them.

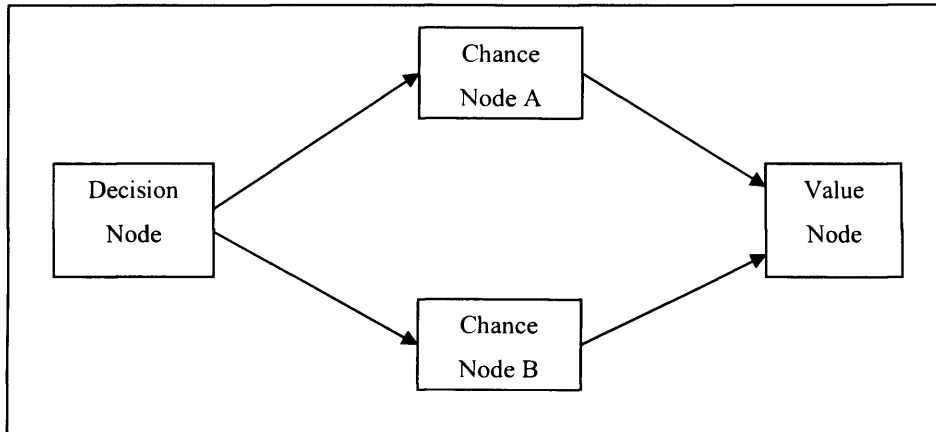

**Fig. 3.2 - Simple influence Diagram**

(Source: Attoh-Okine N. O., Gibbons J., (2001) – *Use of belief function in brownfield infrastructure redevelopment decision making* – Journal of Urban Planning and development Vol. 127, No.3)

Through the use of influence diagram software packages such as InDia (influence diagram processor) the system builds a separate single-attribute influence diagram model to capture the redevelopment potential of brownfields from the perspective of the five major issues: technical, legal, financial, community concerns and site redevelopment prospect.

Then the system combines all the single-issue influence diagrams in a comprehensive multiple-issue brownfield decision model that is undoubtedly complex and depicts the important relationships among competing objectives, values and uncertainties in brownfield redevelopment.

In my opinion this model demonstrates the strengths of influence diagram modelling as the problem becomes larger. Despite the size of the problem, the model remains

compact and clearly highlight the existing qualitative interrelationships among variables through probabilistic and value dependencies.

### **3.6.6 *Multicriteria Analysis and GIS for Territory – MAGISTER***

MAGISTER is a decision support model suited for land planning. Its main objective is to help land planners translate general policy statements into concrete localisation decisions.

MAGISTER is similar to a decision support system and it includes three main components: a database management system, a set of models, and a module for the evaluation and selection of the alternative solutions. The database management system is a GIS, which manages the geographical database describing the study area. The tool allows simulations with hydrologic models, air quality models or demographic models depending on the decision-making domain.

Multicriteria Decision Analysis (MCDA) is used to sort and select the alternatives provided by spatial analysis.

The system is a conceptual combination of tools to assist land-planners and facilitate social acceptance of the decision support process. The involved actors are not faced with a predefined system, but can control choices related to the models and the software. In this way the decision support procedure is specifically adapted to the context (geographical region and scale) and to the given problem (e.g. water management and highway planning).

Another important feature of MAGISTER is that it enables and promotes the participation of all actors and experts in the decision process.

### Chapter 3 – Literature Review

A procedure that uses MAGISTER in land suitability assessment has been developed and this procedure could be applied by a land planning department to produce land suitability maps for the most important land-uses (e.g. housing, manufacturing, agriculture). Once the maps are available, land planners could analyse any new project by using a simple operation like map overlay or statistical analysis.

In developing this application eight selecting criteria were identified:

- impacts on a nature reserve, landscape;
- air pollution;
- noise due to traffic;
- accessibility;
- local climate;
- risk of landslide
- distance to public facilities

Each criteria is evaluated using a different set of data, at an appropriate scale, and with a specific model. For most of the criteria, spatial analysis procedures using a raster GIS are elaborated. The criteria modelling produces a set of maps, one for each criterion, on which the score for each elementary surface is indicated.

The next step is the aggregation of the partial suitability indexes into a holistic suitability index. This aggregation is realized with a multicriteria decision analysis method using a partial aggregation (called outranking methods). Outranking methods

are well suited for land planning purposes since they can handle simultaneously qualitative and quantitative criteria.

The method compares possible alternatives on a criterion by criterion basis and computes an index (called the degree of credibility) for each pair of alternatives that qualifies or ranks one alternative relative to another. If a comparison is made between alternative A and B the index is calculated twice. The outranking degree of credibility (which has a value between 0 and 1) of A over B is first calculated and then of B over A. The degree of credibility is estimated and used to assess whether the hypothesis: A is at least as good as B, is true. It is the product of two factors: the concordance – computed with the criteria where the score of A is at least as good as the score of B, the discordance – is based only on the criterion with the most important difference in favour of B. On the basis of these results, the procedure classifies the alternatives (the zones) in favourable, doubtful and unfavourable.

All data are then stored in GIS (Mapinfo) tables. The alternatives and reference zones are in tables linked with spatial objects. The weights and the thresholds associated with each criterion are stored in a non-spatial table. The reference zones can also be directly selected from the maps describing the study area.

Land suitability study can imply a large number of alternatives to compare and unfortunately the outranking methods are not able to compare a lot of alternatives. So the system is mainly utilised where the study area is divided into zones that are fewer than elementary surfaces or pixels<sup>15</sup>.



### **3.6.7 Sustainable City – GIS software for urban management**

Global Vision Corporation, a Non Governmental Organisation accredited to the United Nations Commission on Sustainable Development (CSD) is developing a project about the sustainable city.

This is part of the international follow-up to Habitat II – the Second United Nations Conference on Human Settlements (June 1996), where it was nominated as a Corporate Best Practice at the World Business Forum on Enterprise, the City, and Sustainable Development.

Sustainable City is an international collaborative research endeavour to develop the world's first GIS (Geographical Information Systems) computer simulation programme for any town or city to see itself – and its surrounding environment – as a whole system.

Sustainable City is designed as a practical tool for sustainable development planning. Its 48 applications will help urban stakeholders to understand and balance their community, economic, and ecosystem development needs, and will enable them to:

- identify problems, visualise solutions, and increase management effectiveness;
- carry out scenario planning to measure and compare the environmental, social, and economic risks and benefits of various development and management alternatives;
- formulate the community vision needed to implement Local Agenda 21;
- save money by greater efficiency in energy, water and other resource consumption

### Chapter 3 – Literature Review

- create jobs and identify new markets for environmentally-sound products and services;
- perform annual environmental audits, measure the load which a city's metabolism places on the carrying capacity of the surrounding local/regional/global ecosystem, quantify its sustainability index, and evaluate its progress towards sustainability.

The whole system model is a user friendly 2D or 3D generic computer simulation program capable of modelling any town or city - and its surrounding environment - as a whole system. The system has the capacity to simulate problems, measure costs, create scenarios, visualise solutions, and calculate untapped benefits.

The system includes:

- object-oriented 2 or 3D Geographic Information Systems (GIS) mapping of the urban centre and surrounding environment with parameters such as infrastructure, buildings, energy, water, materials, thermodynamics, population, transportation, industry, markets, real-estate, economics, employment, health, crime, homelessness, pollution, recycling, and opportunities for synergetic solutions;
- mapping of the city's ecological footprint (sources and sinks) on the surrounding eco-social environment, both locally and globally;
- the use of remote sensing satellite imaging to model infrastructure, buildings, individual cars, landfills, individual trees, and other environmental data. Better than maps, and updatable every day;

### Chapter 3 – Literature Review

- data input such as topographical, geological, hydrological, ecological and meteorological maps; aerial photography; urban heat island analysis; census data; population densities; urban planning info; zoning; building codes; building HVACS (heating, ventilation and air-conditioning systems) information; tax maps; vehicular and pedestrian transportation; building age and ownership; land use; electricity and fuel consumption;
- a particular focus on the city's local bioregion (watershed, ocean basin, biogeographical zone, etc);
- sustainability indicators of a city's progress towards sustainability, including social, economic, and environmental parameters. The system uses the core set of 46 indicators developed by the United Nations Center for Human Settlements (UNCHS) / World Bank Indicators Programme. In addition, it will provide some 1,500 built-in indicators which users can choose to meet the specific needs of their local city.

The software is still under construction and Global Vision hopes to beta test the software on the city of Geneva, Switzerland, which is currently launching a major Local Agenda 21 initiative<sup>16</sup>.

#### **3.6.8 Sustainable Development Indicators – The Dashboard**

The Consultative Group on Sustainable Development Indicators at the International Institute for Sustainable Development (Canada) has developed a Dashboard of Sustainability.

### Chapter 3 – Literature Review

The Dashboard is an instrument panel designed to inform decision-makers, the media and the general public on the status of a nation's progress toward, or away from, sustainability.

The Dashboard presents sets of indicators in a simple pie chart format based on three principles:

- the size of a segment reflects the relative importance of the issue described by the indicator;
- a colour code signals performance relative to others: green means “good”, red means “bad”;
- the central circle (PPI, Policy Performance Index) summarizes the information of the component indicators.

The Dashboard was made functional by using forty-six indicators to compose the three main clusters for over one hundred countries. Aggregation algorithms and graphic presentation software have been developed. An animated version of the Dashboard presents data on each component indicator, as well as on the three cluster indices and the overall sustainability index.

In this system the data of any one country and any one indicator and index can be compared to that of any other country. The specification has a built in flexibility and the clusters can be modified according to the end-users' specific needs, without changing the functioning of the Dashboard.

The systems also allows presentation of complex relationships in a format that is digestible for decision-makers and other persons who might specialise in one field

### Chapter 3 – Literature Review

(e.g. environment or social issues or economics), but need to integrate policy fields in which they are not experts, into their work.

The Dashboard presents, through its colour code, the weak and strong points by country and for each indicator relative to the other 100+ countries contained in the database. For each indicator, the performance colour can be displayed relative to the value one would expect for the given level of income (this gives Developing Countries a chance to compete)<sup>17</sup>.

Two or three countries can be displayed side by side for a given policy field, thus allowing a quick look at their relative performance. For example, the social indicators for France, Belgium and Germany can be displayed next to each other. For each indicator, the distribution can be displayed, allowing the user to assess the meaningfulness of the indicator and to identify outliers, etc.

For each pair of indicators, a scatter plot presents the correlation. A list of indicators, sorted by "best fit," allows identification of the most relevant linkages. In particular, these functions allow identification of synergies (indicators whose "desirable" values are positively correlated) and potential conflicts (e.g. environment vs. many economic and social variables).

The Dashboard is currently under enhancement and will include the following features:

1. Support the work of participating NGOs and organisations in the developing countries and provide co-ordination throughout the work

2. Disseminate the first tested version of the detailed Dashboard and reach out to the media to help influence key decision-makers and the public discourse in a variety of audiences, including regional and municipal level decision-makers
3. Test the Dashboard in selected local communities and municipalities, linking it to sustainable development and Local Agenda 21 strategies and action plans.

### **3.6.9 Global System for Sustainable Development**

The Consortium of Global Accords for Sustainable Development, Massachusetts Institute of Technology developed a Global System for Sustainable Development.

The Global System for Sustainable Development (GSSD) is a multi-dimensional knowledge networking system of public and private networks, based on an integrated framework and an evolving quality controlled cross-referenced knowledge base.

The system explores innovative responses to sustainability challenges at all levels of development, in all parts of the world. The GSSD provides networking facilities across stakeholder communities to help identify innovative approaches, enabling technologies, as well as new institutional, financial and regulatory mechanisms for meeting sustainability challenges that confront us all, in both rich and poor countries<sup>18</sup>.

The system provides evolving, dynamic, interactive, contextual, and distributed meta-networking facilities focused on one issue of major importance for decision makers across the world: dilemmas of sustainability.

### Chapter 3 – Literature Review

The GSSD is designed to:

- Make evolving knowledge about sustainability more accessible to agents of change for public policy, business strategy and creative ventures by facilitating access to cutting-edge analysis, innovative technologies, and multidisciplinary knowledge
- Facilitate knowledge-sharing through customised search engines, quality-controlled knowledge-mining tools, multilingual capacities, and decision-tools to identify options available in technologies, policies and strategies
- Provide leadership and vision in the use of advanced information and communication technologies by strengthening capacities for knowledge access and informed decision-making and providing tools.

The GSSD is a computer implemented method for facilitation identification and storage of data and the communication of information among a plurality of geographically separated entities working to solve problems related to global sustainability.

The sustainability issue areas considered in this system are: energy use and resources, trade and finance, industry and manufacturing, mobility, agriculture, forest and land use, water use, conflicts, urbanisation, consumption, unmet basic needs, population, migration and governance and institutions.

The system organizes knowledge and data related to global sustainability problems into several hierarchies of interrelated sub-concepts stored on a several computer systems interconnected by a number of communication links. Each sub-concept of

hierarchies belongs to a category and has at least one attribute and one sub-attribute. At this level the system provides access of plurality of entities, to data within any of sub-concepts stored in pluralities of remote locations in response to mapping specifications.

### **3.7 Research Projects for Brownfield Regeneration**

At European, International and Local level there are different research projects and programme that have been undertaken to provide guidelines, advice, and support in sustainable brownfield regeneration.

Most of these projects utilise case studies to highlight best practice in regeneration that can be easily transferred to different social, economic and institutional contexts.

In the following paragraphs an overview of National and International research projects is provided.

#### ***3.7.1 RESCUE Regeneration of European Sites in Cities and Urban Environments***

RESCUE was a research project in the framework of key action IV "Cities of tomorrow and cultural heritage" of the specific programme "Energy, environment and sustainable development" within the 5th Framework Programme of the European Community in the field of research, technological development and demonstration.

The project started in March 2002 as a 36-month research project integrating the concept of sustainability into brownfield regeneration. Based on an analysis and evaluation of current practice in industrial core regions in France (Nord-Pas de Calais), United Kingdom (Derbyshire, North-East of England), Poland (Silesia) and



### Chapter 3 – Literature Review

Germany (Ruhr Area, Southern District of Leipzig), RESCUE attempted to distil best practice approaches at reduced costs and integrate its results into a holistic system approach containing new methodologies, procedures and instruments for the sustainable regeneration of European industrial brownfield sites.

RESCUE developed tools for the practical work of real estate owners, planners, architects, engineers and public authorities involved in the complex processes of brownfield regeneration projects. By reducing the costs of land rehabilitation, RESCUE addressed current obstacles in regeneration projects, contributed to reduce the demand for greenfield development and therefore saved natural resources<sup>19</sup>.

The regeneration process was broken down into the main steps of decision making and analysed along transnational work packages such as:

- management of contamination and reuse of soil and debris
- management of existing buildings and infrastructures
- sustainable land use and urban design on brownfield sites
- sustainable planning processes and methods for citizen participation
- tools for management of brownfield projects
- virtual training centre

The main result is a “Best Practice Guidance for Sustainable Brownfield Regeneration”. This Manual provides both scientifically and practically tested guidance and substantial decision making tools for stakeholders, public administration

and financial funding bodies. The Manual gives a flavour of all the substantial tools that RESCUE has produced:

- the RESCUE Sustainability Assessment Tool (SAT) which provides a methodology for a site specific ex ante evaluation of intended brownfield projects in terms of sustainability which should be used as a precondition for planning permissions and public funding;
- Administrative Tools and Incentives for sustainable brownfield regeneration which suggest a framework to support sustainable brownfield regeneration
- End-user tools for sustainable brownfield regeneration which enlarge the practical toolbox to support sustainable outcomes
- VTC Virtual Training Centre which provides web based training resources for sustainable brownfield regeneration.

### ***3.7.2 CABERNET Concerted Action on Brownfield and Economic Regeneration Network***

CABERNET, is a multidisciplinary network funded by the EU (in 2002) comprising 6 expert Working Groups that aim to facilitate new practical solutions for urban brownfields and examine ways to encourage sustainable management of brownfield or previously-developed land<sup>20</sup>. Its vision is to enhance rehabilitation of brownfield sites, within the context of sustainable development of European cities, by the provision of an intellectual framework for coordinated research and development of tools.

### Chapter 3 – Literature Review

The Network applies an innovative multi-stakeholder approach to achieve its key objectives, listed below:

- Better awareness and shared understanding of brownfield issues across stakeholder groups
- A conceptual model for brownfield issues
- Coordinated research activities across different sectors and countries
- Identification of best practice approaches and other tools

The work programme moves through three key stages of interaction, with the Members starting in their respective stakeholder groups:

- During the first stage of the programme of work (stage 1) the groups define their roles and characterise their influence on the redevelopment process, as well as collating baseline information and developing the conceptual model.
- The second stage (stage 2) focusses on specific integrated issues. The Stakeholder Groups will 'mix' to form Working Groups. These groups examine the complexity of the issues from a multi-stakeholder perspective in order to enhance shared understanding and ensure integrated solutions.
- In the final stage (stage 3), members draw together the findings of stages 1 and 2 to produce overviews and targeted outputs to meet the key objectives of the network.

### **3.7.3 SUBR:IM Sustainable Urban Brownfield Regeneration: Integrated Management**

SUBR:IM is a consortium funded by EPSRC under its Sustainable Urban Environments initiative and the Environment Agency<sup>21</sup>. It is a four-year programme which draws together ten major academic and research institutions in a programme designed to improve the quality of urban environments. It comprises 18 projects linking science and social science to tackle brownfield research problems.

The Consortium aims to develop technical solutions and tools for restoring brownfield land in urban areas, whilst at the same time increasing the knowledge base of all stakeholders involved in such development. This includes investors, developers, planning bodies and local authorities, but also the general public and engineers who work with such problems.

The projects undertaken by SUBR:IM includes a wide range of aspects such as: project and portfolio management, the role of the development industry, multi-level decision making processes, metrics, robust technical solutions, integrated remediation and greening, quality in land remediation, brownfields flooding and climate change, designing and managing wetland habitat systems on brownfield land.

### **3.7.4 REVIT Revitalising Industrial Sites**

REVIT receives 10 million Euro from European Regional Development Funding (ERDF), allocated under the European Community Initiative INTERREG III B (2000 – 2006) which supports transnational co-operation in the field of spatial development between national, regional and local authorities and a wide range of non-governmental organisations. Six partners (Landeshauptstadt Stuttgart – Germany,

### Chapter 3 – Literature Review

Conurbation of Nantes – France, City of Tilburg – The Netherlands, City of Hengelo – The Netherlands, Torfaen County Borough Council – UK, Medway Council – UK,) are involved in the REVIT project and they confront problems in the context of brownfield regeneration that are in essence very similar and need to be tackled more effectively by improved co-operation within the North West European region<sup>22</sup>.

The overall goal of REVIT is to significantly increase the efficiency and wider sustainability of applied brownfield regeneration policy through transnational co-operation among the 6 North-West Europe partners. This cooperation increases the “efficiency” and “wider sustainability” of applied brownfield regeneration policies.

“Efficiency” of brownfield regeneration policies is improved through promoting a stronger integration / co-ordination of policy instruments and a greater participatory dimension of regeneration processes. “Wider sustainability” of brownfield regeneration policies is improved through better linking multi-functional development / re-use designs for currently existing brownfield sites (including a preservation of industrial heritage potentials) with an elimination of site-specific environmental damages and a protection of other natural assets on or around revitalised brownfields.

In order to realise the overall project goal the six partners focus on three “Common Cooperation Issues” (CCIs):

- Formal and informal brownfield regeneration instruments and methods that stimulate participation and community involvement.
- New financing techniques, public private partnership models and re-use marketing concepts in the context of brownfield regeneration.

### Chapter 3 – Literature Review

- Multi-functional development, preservation/intelligent re-use of industrial heritage potentials and elimination of environmental damages/protection of natural assets.

Until August 2007, the transnational working teams will develop new approaches for different aspects of brownfield regeneration. To ensure the practical realisability of the new approaches the teams will be testing the new tools in each partner area before publishing final guidelines and recommendations.

### Chapter 3 – Literature Review

#### REFERENCES:

1. a) Schrenk V., Schlicher T., Barczewski B. – *Interdisciplinary Research Activities in Brownfield Redevelopment in the Federal State of Baden-Wurttemberg, Germany*  
  
b) Johnson K.L., Dixson C.E., Tochtermann S.C., (2002) – *Brownfield redevelopment and transportation planning in the Philadelphia region* – Institute of Transportation Engineers ITE Journal Vol. 72, Issue 7, pp 26-31  
  
c) Nijkamp P., Rodenburg C.A., Wagtendonk A.J., (2002) – *Success factors for sustainable urban brownfield development: a comparative case study approach to polluted sites* – Ecological Economics Vol.40, pp 235-252
2. Christos Stergiou and Dimitrios Siganos, (1996) – *Neural Networks – Surveys and Presentations in Information System Engineering (SURPRISE)*, Department of Computing, Department of Electrical and Electronic Engineering, Imperial College of Science Technology and Medicine, London, Vol.4
3. Mehner, H. Fairbairn, D. Csaplovics, E. Cutler, M.E. (2004) - *Transferability of Artificial Neural Networks for Mapping Land Cover of Regional Areas With High Spatial Resolution Imagery* - International Archives of the Photogrammetry, Remote Sensing and Spatial Information Sciences 35(7): 910-915
4. S. Kralisch, M. Fink and C. Beckstein (2003) – *Multi-Objective land use optimization with artificial neural networks* - Geophysical Research Abstracts, Vol. 5, 10067, 2003

### Chapter 3 – Literature Review

5. Attoh-Okine N. O., Gibbons J., (2001) – *Use of belief function in brownfield infrastructure redevelopment decision making* – Journal of Urban Planning and development Vol. 127, No.3
6. Moon Tae Heon (2000) - *GIS Integrated Simulation System of Land Price for Appraisal and ANN* - United States Geographical Information Society, Issue 2000, pp.31-41
7. Henning Sten Hansen (2002) - *A fuzzy logic approach to urban land-use mapping* - National Environmental Research Institute, Ministry of Environment & Energy. Available from:  
[www.scangis.org/scangis2003/papers/25.pdf](http://www.scangis.org/scangis2003/papers/25.pdf)
8. E. Banzhaf and M. Netzband (2003) – *Detecting urban brownfields by means of high resolution satellite imagery* - Commission VII, WG VII/4. Available from: [www.ufz.de/data/Banzhaf-Netzband-20043376.pdf](http://www.ufz.de/data/Banzhaf-Netzband-20043376.pdf)
9. Boot H.R., (2000) – *London's Brownfield Resource Pilot Project: the Wandle Valley* – Centre for Advanced Spatial Analysis – Working Paper 14. Available from: <http://www.casa.ucl.ac.uk/publications/workingPaperDetail.asp?ID=14>
10. Boot H.R., Heppell K., Haklay M., Morley J., (2001) – *The use of GIS in brownfield redevelopment* – Centre for Advanced Spatial Analysis, University College of London
11. Thomas M.R., (2002) – *A GIS-based decision support system for brownfield redevelopment* – Landscape and Urban Planning 58, pp 7-23
12. Critto A., Nadal N., Samiolo M., Carlon C., Silvoni S., Foramti, S., and Marcomini A., Petruzzelli, (2002) - “*DESYRE- Decision Support sYstem for REHabilitatIon of contaminated sites: objectives and structure*” - Proceedings of the Integrated Assessment and Decision Support - Conference, Lugano, Switzerland



### Chapter 3 – Literature Review

13. Carlon C., Giove S., Agostini P., Critto A., Marcomini A., (2004) – *The role of Multicriteria Decision Analysis in a Decision Support System for Rehabilitation of contaminated sites (the DESYRE software)* - International Environmental Modelling and Software Society (iEMSs) – Complexity and Integrated Resources management transactions on the 2<sup>nd</sup> Biennial meeting of the iEMSs, Vol. 2, pp 629-634
14. Amekudzi A.A, Attoh-Okine N.O., (1997) – *Conceptual Frameworks for Understanding Brownfields Redevelopment Issues* – Infrastructure, Vol.2, No.2, pp 45-59
15. Joerin F., Theriault M., Musy A., (2001) – *Using GIS and outranking multicriteria analysis for land-use suitability assessment* – International Journal Geographical Information Science, Vol. 15, No.2, pp 153-174
16. Sustainable City, GIS Software for urban Management – Available from: <http://www.global-vision.org/city/index.html>
17. Sustainable Development Indicators – The Dashboard – Available from: <http://esl.jrc.it/dc/>
18. Global System for Sustainable Development – Available from: <http://web.mit.edu/gssd/consortium/index.html>
19. RESCUE, The Project – Available from: <http://www.rescue-europe.com/html/project.html>
20. Contaminated Rehabilitation Network for Environmental Technologies (CLARINET) 2002 – *Review of Decision Support Tools for Contaminated Land Management and their use in Europe* – Available from: [http://www.clarinet.at/library/final\\_report\\_1102.pdf](http://www.clarinet.at/library/final_report_1102.pdf)

Chapter 3 – Literature Review

21. SUBR:IM Sustainable Urban Brownfield Regeneration: Integrated Management – Available from: <http://www.subrim.org.uk/contact/contact.php>
22. Revitalising Industrial Sites – Available from: <http://www.revitalise.org/about.php>

# Chapter 4

## Methodology

### 4.1 Methodology

The methodology used to develop the Decision Support System includes the integration of fuzzy logic and artificial neural networks within a Geographical Information System.

### 4.2 Fuzzy Logic

Fuzzy Logic (FL) is a problem-solving control system methodology that provides a simple way to arrive at a definite conclusion based upon vague, ambiguous, imprecise, noisy, or missing input information. Fuzzy Logic's approach to control problems mimics how a person would make decisions, only much faster<sup>1</sup>.

FL incorporates a simple, rule-based IF X AND Y THEN Z approach to solving a control problem rather than attempting to model a system mathematically. The FL model is empirically-based, relying on an operator's experience rather than their technical understanding of the system. For example, rather than dealing with temperature control in terms such as "SP =500F", "T <1000F", or "210C <TEMP <220C", terms like "IF (process is too cool) AND (process is getting colder) THEN (add heat to the process)" or "IF (process is too hot) AND (process is heating rapidly) THEN (cool the process quickly)" are used. These terms are imprecise and yet very descriptive of what must actually happen.

FL requires some numerical parameters in order to operate, such as what is considered significant error and significant rate-of-change-of-error, but exact values of these numbers are usually not critical unless very responsive performance is required in which case empirical tuning would determine them.

Fuzzy Logic offers several unique features that make it a particularly good choice for many control problems:

- It is inherently robust since it does not require precise, noise-free inputs. The output control is a smooth control function despite a wide range of input variations.
- Since the system processes user-defined rules, it can be modified easily to improve and drastically alter the performance.

To create a fuzzy controlled machine there are three main steps that needs to be undertaken: rule evaluation (application of fuzzy rules), fuzzification (using membership functions to graphically describe a situation), defuzzification (obtaining the crisp or actual results)<sup>2</sup>.

#### ***4.2.1 Rule evaluation and the fuzzy associative memory***

The rules to represent all the combinations of inputs are set up in the fuzzy associative memory matrix (rule matrix). The matrix can have a different number of rows than columns. This occurs when numerous degrees of inputs are needed. The maximum number of possible rules is simply the product of the number of rows and columns, but definition of all of these rules may not be necessary since some input conditions may never occur in practical operation. The primary objective of this construct is to

map out the universe of possible inputs while keeping the system sufficiently under control.

The first step in implementing FL is to decide exactly what is to be controlled and how (See Figure 4.1). For example, consider the design of a simple proportional temperature controller with an electric heating element and a variable-speed cooling fan<sup>3</sup>. A positive signal output calls for 0-100 percent heat while a negative signal output calls for 0-100 percent cooling. Control is achieved through proper balance and control of these two active devices.

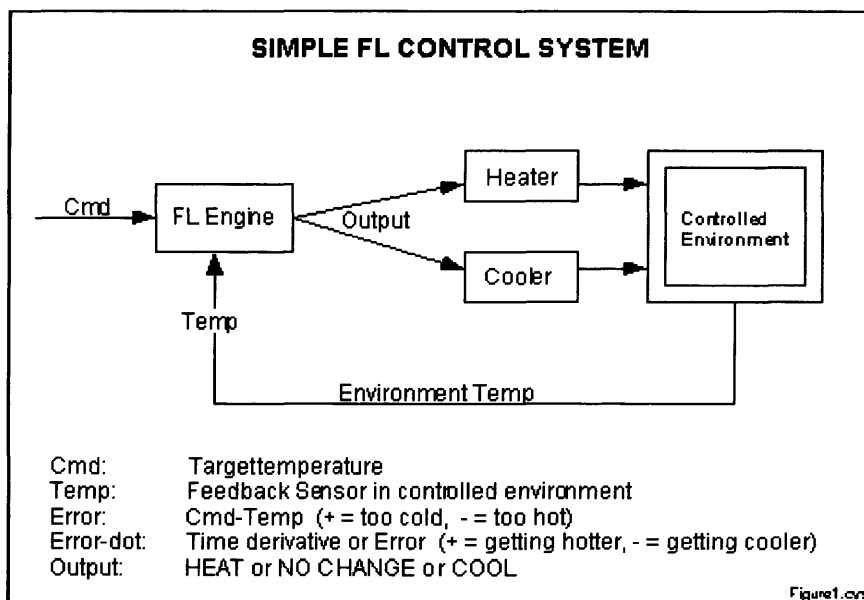

**Fig. 4.1 - A simple block diagram of the control system.**

(SOURCE: Zadeh, L.A, (1965) - *Fuzzy Sets* - Information and Control)

It is necessary to establish a meaningful system for representing the linguistic variables in the matrix. For this example, the following will be used:

"N" = "negative" error or error-dot input level

"Z" = "zero" error or error-dot input level

#### Chapter 4 – Methodology

"P" = "positive" error or error-dot input level

"H" = "Heat" output response

"NC" = "No Change" to current output

"C" = "Cool" output response

Define the minimum number of possible input product combinations and corresponding output response conclusions using these terms. For a three-by-three matrix with heating and cooling output responses, all nine rules will need to be defined. The conclusions to the rules with the linguistic variables associated with the output response for each rule are transferred to the matrix.

The linguistic rules describing the control system consist of two parts; an antecedent block (between the IF and THEN) and a consequent block (following THEN). Depending on the system, it may not be necessary to evaluate every possible input combination since some may rarely or never occur.

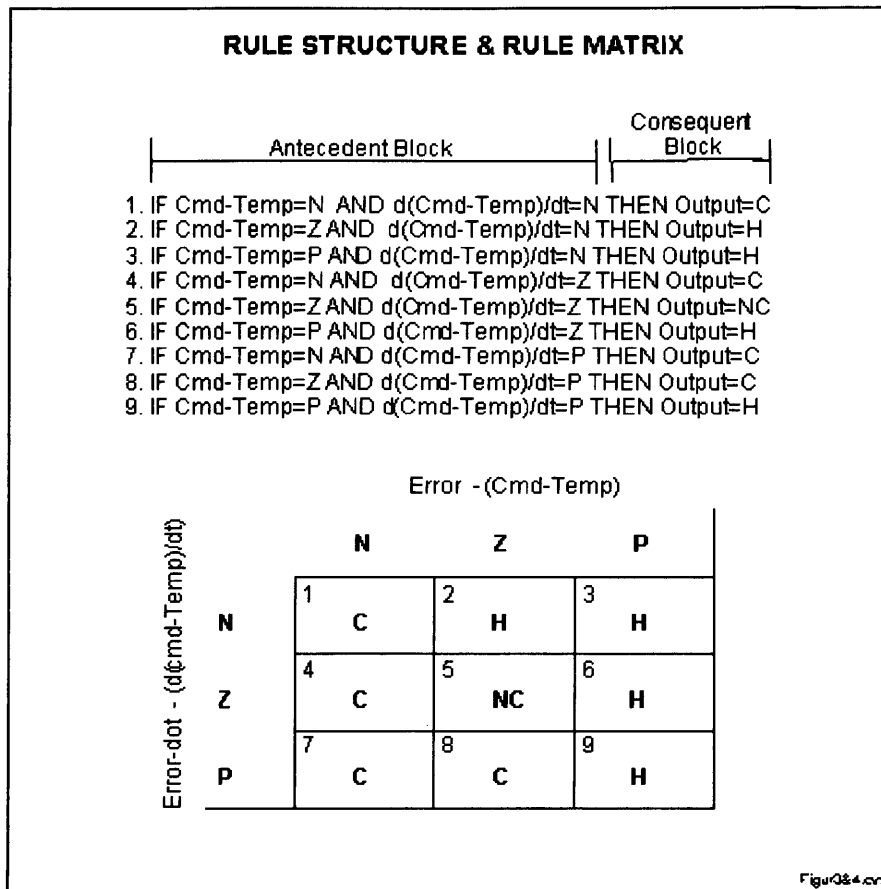

**Fig. 4.2 - The rule structure and the rule matrix**

(SOURCE: Zadeh, L.A, (1965) - *Fuzzy Sets* - Information and Control)

After transferring the conclusions from the rules to the matrix there is a noticeable symmetry to the matrix. This suggests a reasonably well-behaved (linear) system. This implementation may prove to be too simplistic for some control problems, however it does illustrate the process.

#### **4.2.2 Fuzzification and membership functions**

To apply the rules the system uses the membership function that is a graphical representation of the magnitude of participation of each input. It associates a weighting with each of the inputs that are processed, defines functional overlap between inputs, and ultimately determines an output response.

## Chapter 4 – Methodology

There is a unique membership function associated with each input parameter. The membership functions associate a weighting factor with values of each input and the effective rules. These weighting factors determine the degree of influence or degree of membership (DOM) each active rule has. By computing the logical product of the membership weights for each active rule, a set of fuzzy output response magnitudes are produced.

The shape of membership functions can be different. In general, the triangular is common (see Figure 4.3), but bell, trapezoidal, haversine and, exponential have been used. More complex functions are possible but require greater computing overhead to implement<sup>4</sup>.

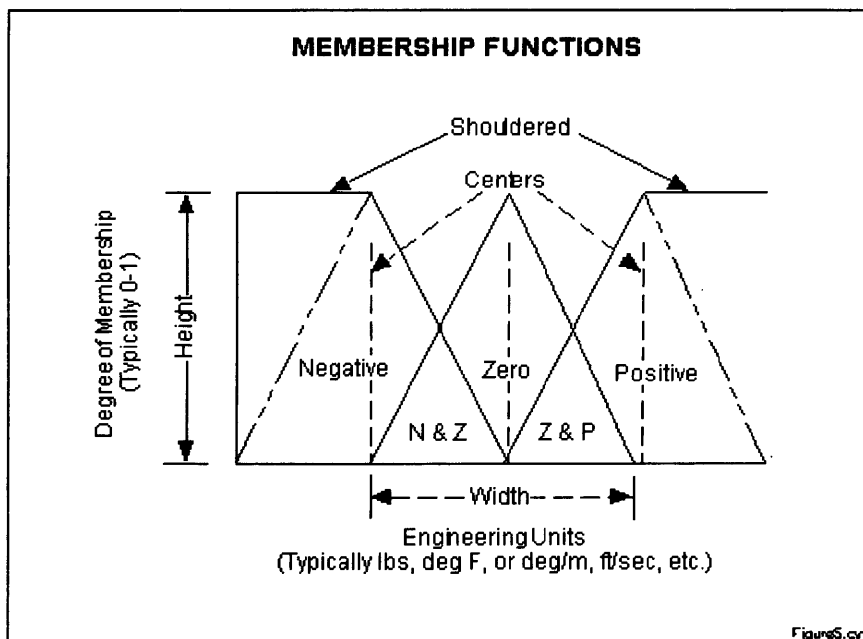

**Fig. 4.3 - The features of a membership function**

(SOURCE: Mitsubishi T., Endou T., Shidama Y., (2003) – *The concept of fuzzy set and membership function and basic properties of fuzzy set operation* – Journal of formalized mathematics, Vol.12)



The degree of membership (DOM) is determined by plugging the selected input parameter into the horizontal axis and projecting vertically to the upper boundary of the membership function(s).

### **4.2.3 Defuzzification**

Once the functions are inferred, scaled, and combined, they are defuzzified into a crisp output which drives the system.

Before undertaking the defuzzification process for crisp output generation, the logical products for each rule must be combined or inferred. There are several inference methods:

- The MAX-MIN method tests the magnitudes of each rule and selects the highest one. The horizontal coordinate of the "fuzzy centroid" of the area under that function is taken as the output. This method does not combine the effects of all applicable rules but does produce a continuous output function and is easy to implement.
- The MAX-DOT or MAX-PRODUCT method scales each member function to fit under its respective peak value and takes the horizontal coordinate of the "fuzzy" centroid of the composite area under the function(s) as the output. Essentially, the member function(s) are shrunk so that their peak equals the magnitude of their respective function ("negative", "zero", and "positive"). This method combines the influence of all active rules and produces a smooth, continuous output.
- The AVERAGING method is another approach that works but fails to give increased weighting to more rule votes per output member function. For

#### Chapter 4 – Methodology

example, if three "negative" rules fire, but only one "zero" rule does, averaging will not reflect this difference since both averages will equal 0.5. Each function is clipped at the average and the "fuzzy" centroid of the composite area is computed.

- The ROOT-SUM-SQUARE (RSS) method combines the effects of all applicable rules, scales the functions at their respective magnitudes, and computes the "fuzzy" centroid of the composite area. This method is more complicated mathematically than other methods, but was selected for this example since it seemed to give the best weighted influence to all firing rules.

The defuzzification of the data into a crisp output is accomplished by combining the results of the inference process and then computing the "fuzzy centroid" of the area. The weighted strengths of each output member function are multiplied by their respective output membership function center points and summed.

Finally, this area is divided by the sum of the weighted member function strengths and the result is taken as the crisp output as shown in Figure 4.4.

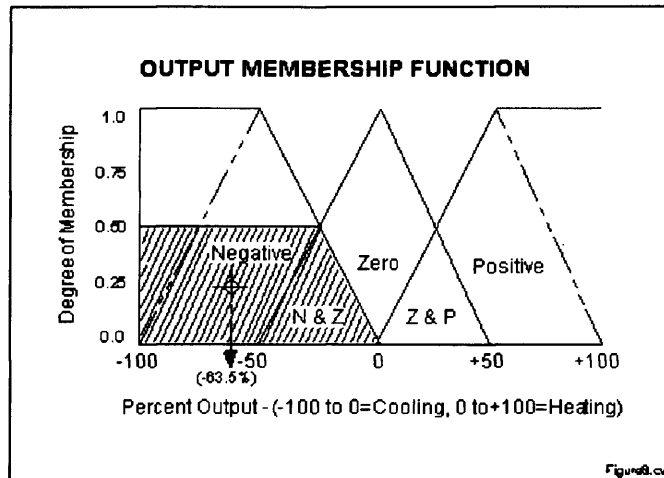

**Fig. 4.4 - The horizontal coordinate of the centroid is taken as the crisp output**

(SOURCE: Mitsubishi T., Endou T., Shidama Y., (2003) – *The concept of fuzzy set and membership function and basic properties of fuzzy set operation* – Journal of formalized mathematics, Vol.12)

The logical product of each rule is inferred to arrive at a combined magnitude for each output membership function. Once inferred, the magnitudes are mapped into their respective output membership functions, delineating all or part of them.

### 4.3 Artificial Neural Networks

Artificial Neural Networks (ANNs) are relatively crude electronic models based on the neural structure of the brain<sup>5</sup>. The brain basically learns from experience.

Neural networks attempt to produce the human way of processing data and learning. They exhibit certain analogies to the way in which arrays of neurons function in biological learning and memory. The fundamental blocks are processing units, called nodes, which can be likened to neurons, and weighted connections, which can be likened to synapses in the human brain.

## Chapter 4 – Methodology

The basic unit of neural networks, the artificial neurons, simulate the four basic functions of natural neurons as shown in Figure 4.5.

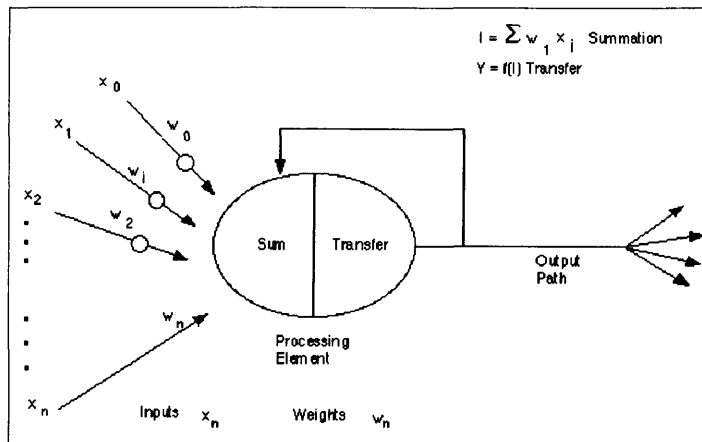
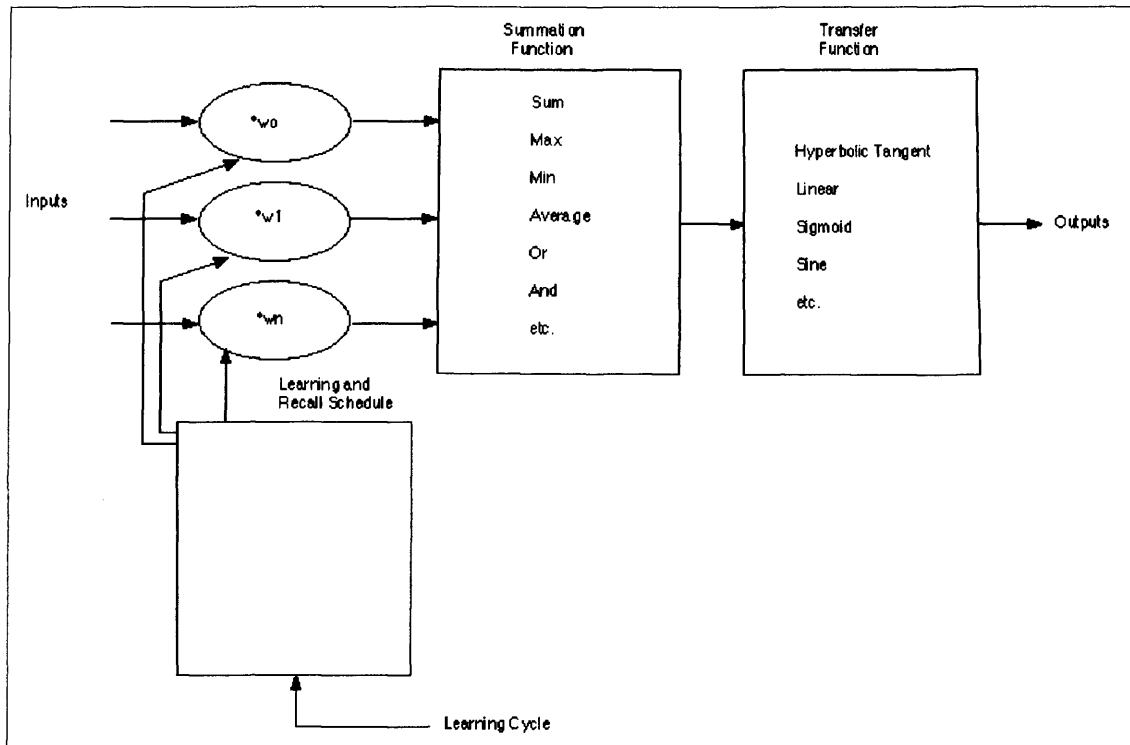

**Fig. 4.5 - A basic Artificial Neuron**

(SOURCE: Mehrotra K., Mohan C.K., and Ranka S., (1996) - *Elements of Artificial Neural Networks – Cloth*)

The various inputs to the network are represented by the mathematical symbol,  $x(n)$ . Each of these inputs are multiplied by a connection weight. These weights are represented by  $w(n)$ . In the simplest case, these products are simply summed, fed through a transfer function to generate a result, and then output. This process lends itself to physical implementation on a large scale in a small package.

In currently available software packages these artificial neurons are called "processing elements" and have many more capabilities than the simple artificial neuron described above.



**Fig. 4.6 - A model of a “Processing Element”**

(SOURCE: Mehrotra K., Mohan C.K., and Ranka S., (1996) - *Elements of Artificial Neural Networks – Cloth*)

In Figure 4.6, inputs enter into the processing element from the upper left. The first step is for each of these inputs to be multiplied by their respective weighting factor ( $w(n)$ ). Then these modified inputs are fed into the summing function, which usually just sums these products. Yet, many different types of operations can be selected. These operations could produce a number of different values which are then propagated forward; values such as the average, the largest, the smallest, etc.

Sometimes the summing function is further complicated by the addition of an activation function which enables the summing function to operate in a time sensitive way. The output of the summing function is then sent into a transfer function. This function then turns this number into a real output via some algorithm. It is this

#### Chapter 4 – Methodology

algorithm that takes the input and turns it into a zero or a one, a minus one or a one, or some other number. The transfer functions that are commonly supported are sigmoid, sine, hyperbolic tangent, etc. This transfer function also can scale the output or control its value via thresholds. The result of the transfer function is usually the direct output of the processing element.

Finally, the processing element is ready to output the result of its transfer function. This output is then input into other processing elements, or to an outside connection, as dictated by the structure of the network.

A typical neural network consists of many inter -connected nodes that are organized into a sequence of layers. The first layer is called the input layer, and it is responsible for converting the input data in order to be processed it in the next layer. The next layer, may be more than one layer, is called hidden layer in which nodes perform the operations on the data received from the first layer. The output layer produces the estimation by performing a differently defined mathematical function. Evidently, the calculated output will not be similar or close to the existing output data in one cycle. Therefore, by repeating and memorizing with unique weight and performing error calculation of each cycle, the best estimation result is gained.

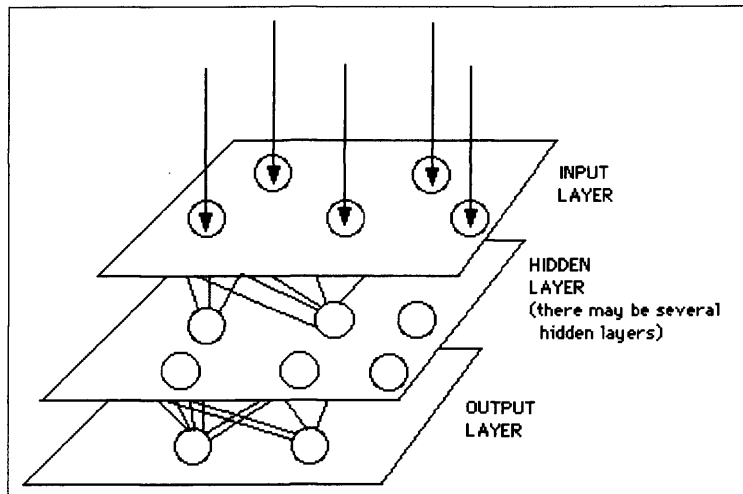

**Fig. 4.7 - A Simple Neural Network Diagram**

(SOURCE: Hassoun M.H., (1995) - *Fundamentals of Artificial Neural Networks*

(Hardcover) - The MIT Press)

Once a network has been structured for a particular application, that network is ready to be trained.

The Operation of a Neural Network is controlled by three properties<sup>7</sup>:

1. The pattern of its interconnections, *architecture*.
2. Method of determining and updating the weights on the interconnections, *training*.
3. The function that determines the output of each individual neuron, activation or *transfer function*.

### 4.3.1 Architecture of an Artificial Neural Network

The architecture of an Artificial Neural Network can be feedforward (see Figure 4.8) or feedback (see Figure 4.9).

The feed-forward ANNs allow signals to travel one way only; from input to output. There is no feedback (loops) i.e. the output of any layer does not affect that same layer. Feed-forward ANNs tend to be straight forward networks that associate inputs with outputs. This type of organisation is also referred to as bottom-up or top-down.

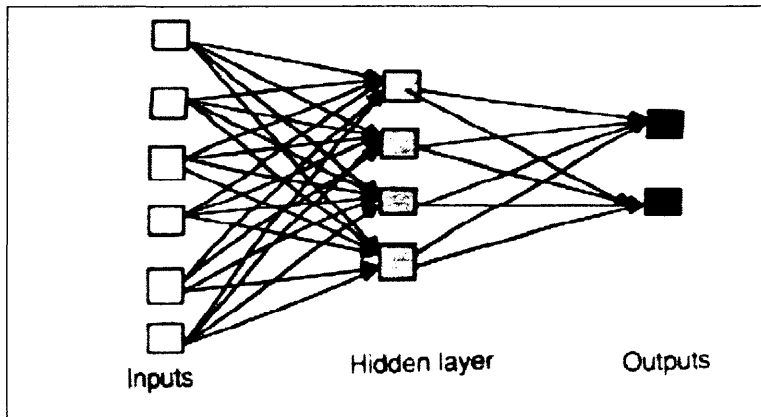

Fig. 4.8 - Example of feedforward network

(SOURCE: Hassoun M.H., (1995) - *Fundamentals of Artificial Neural Networks*  
(Hardcover) - The MIT Press)

Feedback networks can have signals travelling in both directions by introducing loops in the network. Feedback networks are very powerful and can get extremely complicated. They are dynamic; their 'state' is changing continuously until they reach an equilibrium point. Then they remain at the equilibrium point until the input changes and a new equilibrium needs to be found.

Feedback architectures are also referred to as interactive or recurrent, although the latter term is often used to denote feedback connections in single-layer organisations.



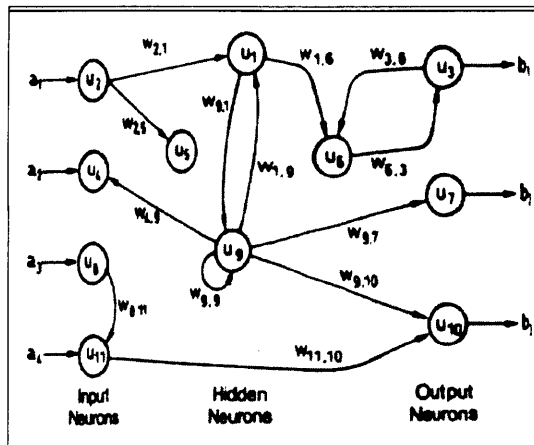

**Fig. 4.9 - Example of feedback network**

(SOURCE: Hassoun M.H., (1995) - *Fundamentals of Artificial Neural Networks* - The MIT Press)

### 4.3.2 Training an Artificial Neural Network

There are two approaches to training - supervised and unsupervised. The vast bulk of networks utilize supervised training. Unsupervised training is used to perform some initial characterization on inputs.

Supervised training involves a mechanism of providing the network with the desired output either by manually "grading" the network's performance or by providing the desired outputs with the inputs. In supervised training, both the inputs and the outputs are provided. The network then processes the inputs and compares its resulting outputs against the desired outputs. Errors are then propagated back through the system, causing the system to adjust the weights which control the network. This process occurs over and over as the weights are continually tweaked. The set of data which enables the training is called the "training set." During the training of a network the same set of data is processed many times as the connection weights are ever refined.

Unsupervised training is where the network has to make sense of the inputs without outside help. The network is provided with inputs but not with desired outputs. The system itself must then decide what features it will use to group the input data. This is often referred to as self-organization or adaption<sup>8</sup>. At the present time, unsupervised learning is not well understood.

### 4.3.3 Transfer function of Artificial Neural Networks

The result of the summation function, almost always the weighted sum, is transformed to a working output through an algorithmic process known as the transfer function. This function typically falls into one of three categories: linear (or ramp), threshold and sigmoid.

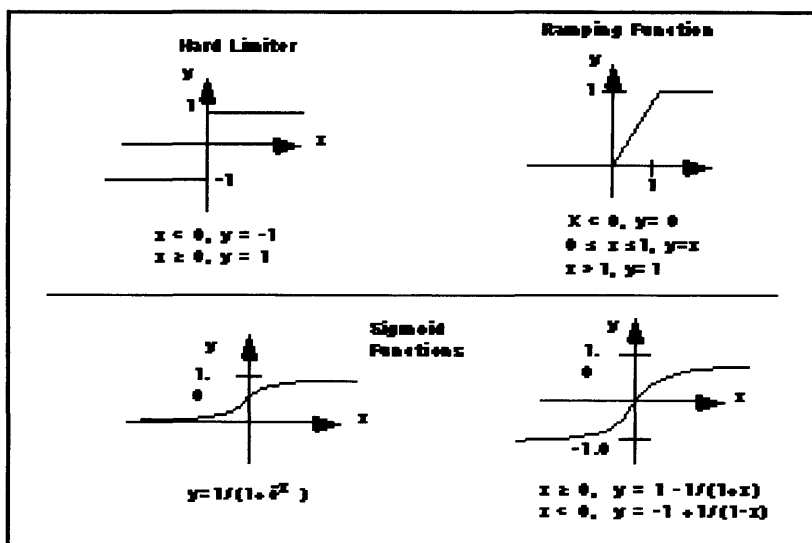

Fig. 4.10 - Sample Transfer Functions

(SOURCE: Antognetti P., and Milutinovic, (1991) - *Neural Networks: Concepts, Applications, and Implementations* - (Eds.) Volumes I-IV, Prentice Hall, Englewood Cliffs, NJ.)

#### Chapter 4 – Methodology

The transfer function is generally non-linear. Linear (straight-line) functions are limited because the output activity is simply proportional to the total weighted input. Linear functions are not very useful. The transfer function could be something as simple as depending upon whether the result of the summation function is positive or negative.

For threshold units the output is set at one of two levels, depending on whether the total input is greater than or less than some threshold value. The threshold or ramping function could mirror the input within a given range and still act as a hard limiter outside that range. It is a linear function that has been clipped to minimum and maximum values, making it non-linear.

For sigmoid units, the output varies continuously but not linearly as the input changes. Sigmoid units bear a greater resemblance to real neurones than do linear or threshold units, but all three must be considered rough approximations.

The curve approaches a minimum and maximum value at the asymptotes. It is common for this curve to be called a sigmoid when it ranges between 0 and 1, and a hyperbolic tangent when it ranges between -1 and 1. Mathematically, the exciting feature of these curves is that both the function and its derivatives are continuous. This option works fairly well and is often the transfer function of choice<sup>9</sup>.

## **4.4 Integration of Fuzzy Logic and Artificial Neural Networks to GIS**

GIS information can be increasingly more valuable for decision making when matched to Artificial Neural Networks (ANN) and other mathematical model such as fuzzy logic (FL)<sup>10</sup>.

When linked to GIS, neural networks and fuzzy logic can be useful for evaluating, monitoring and decision-making since these two models are directed towards decision-making functionality.

It is anticipated that many future spatial applications will incorporate elements of ANN since these networks have many applications in GIS including: land use, oceanography, forestry, pattern analysis, transportation, environmental analysis.

The integration of GIS with ANN and FL allows another dimension to be added to the spatial capabilities of the system itself.

See general review<sup>11</sup> for more information on the mathematical integration between ANN, Fuzzy Logic and GIS.

#### Chapter 4 – Methodology

#### REFERENCES:

1. Kaehler S.D.(1998) - *Fuzzy Logic Tutorial* - Seattle Robotics Society
2. Zadeh L.A., (1987) - *Fuzzy Sets and Applications: Selected Papers by L.A. Zadeh* - ed. R.R. Yager (John Wiley, New York)
3. Zadeh, L.A, (1965) - *Fuzzy Sets* - Information and Control
4. Mitsuishi T., Endou T., Shidama Y., (2001) – *The concept of fuzzy set and membership function and basic properties of fuzzy set operation* – Journal of formalized mathematics, Vol. 9(2), pp 351-356,
5. Mehrotra K., Mohan C.K., and Ranka S., (1996) - *Elements of Artificial Neural Networks* – Cloth
6. Bosque M., (2002) - *Understanding 99% of Artificial Neural Networks: Introduction & Tricks* - Writers Club Pr (2002/3/31)
7. Hassoun M.H., (1995) - *Fundamentals of Artificial Neural Networks* - The MIT Press
8. Antognetti P., and Milutinovic, (1991) - *Neural Networks: Concepts, Applications, and Implementations* - (Eds.) Volumes I-IV, Prentice Hall, Englewood Cliffs, NJ.
9. Nelson M., McCord and Illingworth, W. T., (1991) - *A Practical Guide to Neural Nets* - Addison-Wesley, Reading, MA
10. Thurston J., (2002) - *GIS & Artificial Neural Networks: Does Your GIS Think?* – Available from:

[http://www10.giscafe.com/link/display\\_links.php?category\\_id=4114&order=title&sd=a](http://www10.giscafe.com/link/display_links.php?category_id=4114&order=title&sd=a)

11. a) Aarts E., and Korst J., (1989) - *Simulated Annealing and Boltzmann Machines, A Stochastic Approach to Combinatorial Optimization and Neural Computing* - Wiley, Tiptree Essex GB
- b) Baba N., (1989) - *A New Approach for Finding the Global Minimum of Error Function of Neural Networks* - Neural Networks, Vol. 2
- c) Eberhart, Russell C., and Dobbins, Roy W., (1990) - *Neural Network PC Tools: A Practical Guide* - Academic Press, ISBN 0-12-228640-5
- d) Bart K., (1992) - *Neural Networks and Fuzzy Systems* - Prentice Hall, Englewood Cliffs, NJ
- e) D'Aquila R.O., Crespo C., Mate J.L, Pazos J., (2002) – *An inference engine based on fuzzy logic for uncertain and imprecise expert reasoning* – Fuzzy Sets and Systems 129 pp 187-202
- f) German G. and Gahegan M., (1996) – *Neural networks architectures for the classification of temporal image sequences* – Computer and Geosciences Vol. 22, No.9, pp 969-979
- g) Bouille F., (1994) – *Principles of automated learning in a GIS, using an illimited set of object-oriented persistent neurons* – ISPRS-III-SSIDPCVN, Munchen, Proceed – Ebner-Heipke-Eder Editors Vol.30, Part 3/1, pp 69-76

# **Chapter 5**

## **The Decision Support System for Brownfield Sites Sustainable Regeneration**

### **5.1 The Decision Support System - generalities**

The Decision Support System (DSS) developed provides the decision maker with a tool that selects the “optimal” redevelopment process on the basis of a set of sustainability indicators that have been developed within the European Programme “RESCUE – Regeneration of European Sites in Cities and Urban Environments”.

The system is based on the application and integration of the mathematical techniques of artificial neural networks and fuzzy logic. The programming language Mapbasic has been used to develop the relevant procedures, writing the codes and integrate them.

Fuzzy Logic is used to evaluate the indicators, compare them and assess their sustainability. The Artificial Neural Network is the core of the DSS that performs a process to identify and compare the alternative scenarios (type of regeneration) on the basis of the input information. The use of the GIS allows an easy and friendly interface and also enables the output information to be easily visualised.

The DSS enables the decision maker to obtain results about the sustainability and the regeneration process of an identified brownfield site, all of this within a short time. The output will then be used by the appropriate decision makers to make the final decision in relation to the local knowledge and experience.

The system is composed of two main procedures (FL,ANN) which use a different methodology or code. These are connected in series since the output of the fuzzy logic part represents the input of the artificial neural network. The integration of these procedures represents the DSS.

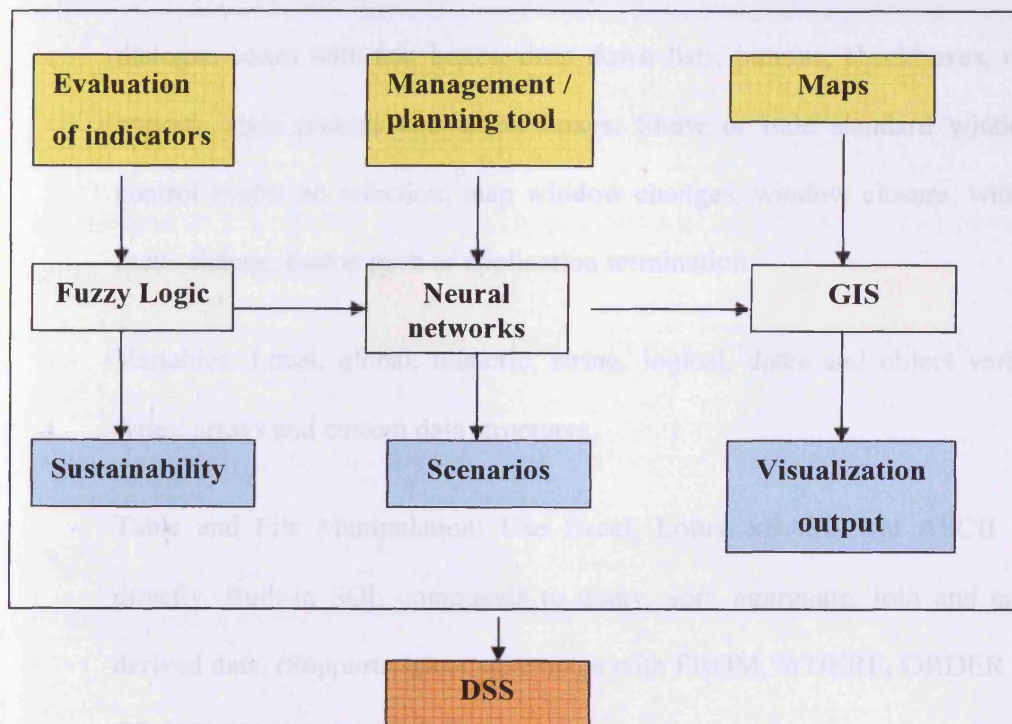

Fig. 5.1 – DSS Scheme

## 5.2 MAPBASIC Programming Language

MapBasic is an ideal programming language to create custom MapInfo applications, extend the functionality of MapInfo Professional, automate repetitive operations, or



## Chapter 5 – The DSS

integrate MapInfo Professional with other applications. MapBasic programs are easy to integrate with applications written in other programming languages such as Visual Basic, C++, PowerBuilder and Delphi.

The MapBasic language contains over 300 statements and functions including:

- Flow Control: Looping, branching sub-procedures, user-defined functions, event handlers and error handling.
- User Interface: Create new menu bars, menus or menu items, remove items from existing menus. Create or modify buttons on tool bars. Create custom dialogue boxes with text boxes, drop down lists, buttons, checkboxes, radio buttons, style pickers and select boxes. Show or hide standard windows, control events on selection, map window changes, window closure, window focus change, button push or application termination.
- Variables: Local, global, numeric, string, logical, dates and object variable types: arrays and custom data structures.
- Table and File Manipulation: Use Excel, Lotus, xBASE and ASCII files directly. Built-in SQL commands to query, sort, aggregate, join and create derived data. (Supports select statements with FROM, WHERE, ORDER BY, GROUP BY clauses with subselects).
- Functions: String, data conversion, math, date, time and geographic functions.
- Geographic Object Manipulation: Create points, lines, polylines, text, polygons, buffers, etc. Edit and manipulate objects including reshape, object conversions, split, combine, erase. Calculate area, perimeter, length, centroid

## Chapter 5 – The DSS

and area overlap. Modify object styles. Display maps from multiple layers, control display settings, create thematic maps. Find and geocode objects.

Supports multiple coordinate systems.

The advantage of using Mapbasic to develop the DSS is the possibility to write the code in separate procedures for each mathematical model and then integrate them through an easy exchange of input-output parameters.

In particular the output produced by the Fuzzy Logic procedure represents the input of the Artificial Neural Network one.

To simplify the development of the DSS a main procedure for fuzzy logic and a main one for artificial neural network have been created and then linked together to a GIS.

An example of a part of the Fuzzy Logic procedure to construct the input variables information is shown below.

```
*****  
** PROCEDURE **  
Include "mapbasic.def"  
Declare Sub Site_info()  
Declare Sub Site_ind_results()  
Declare Sub Land_indicators(ByVal site As Integer)  
Declare Sub Water_indicators(ByVal site As Integer)  
Declare Sub Energy_indicators(ByVal site As Integer)  
Declare Sub Waste_indicators(ByVal site As Integer)  
Declare Sub Acceptance_indicators(ByVal site As Integer)  
Declare Sub Jobs_indicators(ByVal site As Integer)  
Declare Sub Information_indicators(ByVal site As Integer)  
Declare Sub Comparison_waste()  
Declare Sub Comparison_information()  
Declare Sub Comparison_water()  
Declare Sub Comparison_land()  
Declare Sub Comparison_energery()  
Declare Sub Comparison_acceptance()  
Declare Sub Comparison_jobs()  
Declare Sub FAM(ByVal inp1, inp2 As String)  
Declare Sub Site_choice()  
Declare Sub Main ()  
Global          s_code(8)           As Integer  
Global          s_name(8)           As String  
Global          s_dims(8)           As Integer  
Global          s_loc(8)            As String  
Global          s_loc_code(8)       As Integer  
Global          s_puse(8)           As String  
Global          s_puse_code(8)      As Integer  
Global          s_fuse(8)           As String  
Global          s_fuse_code(8)      As Integer  
Global          s_cont(8)           As String  
Global          s_cont_code(8)     As Integer  
Global          s_build(8)         As String
```

## Chapter 5 – The DSS

Global	s_build_code(8)	As Integer
Global	s_real_code(8)	As Integer
Global	s_wp(59)	As Integer
Global	s_obj_cod(59)	As String
Global	s_obj_des(59)	As String
Global	s_dim_sat(59)	As String
Global	s_ind_cod(59)	As String
Global	s_ind_des(59)	As String
Global	s_ind_nam(59)	As String
Global	s_unit(59)	As String
Global	s_swg_1(59)	As String
Global	s_swg_2(59)	As String
Global	s_swg_3(59)	As String
Global	s_swg_4(59)	As String
Global	s_swg_5(59)	As String
Global	s_swg_6(59)	As String
Global	s_swg_7(59)	As String
Global	s_swg_8(59)	As String
Global	s_swg_des1(59)	As String
Global	s_swg_des2(59)	As String
Global	s_swg_des3(59)	As String
Global	s_swg_des4(59)	As String
Global	s_swg_des5(59)	As String
Global	s_swg_des6(59)	As String
Global	s_swg_des7(59)	As String
Global	s_swg_des8(59)	As String
Global	site	As Integer
Global	sl(7)	As String
Global	sws(4)	As String
Global	si(10)	As String
Global	sw(4)	As String
Global	se(4)	As String
Global	sa(4)	As String
Global	sj(3)	As String
Global	result	As String
Global	input1, input2	As String
Global	b	As Integer
Global	sus,nosus	As Integer

\*\*\*\*\*

\*\*\* PROCEDURE THAT CREATES THE ARRAY FOR THE TABLE SITE\_INFORMATION\*\*\*

```

SUB Site_info()
Dim c, nrows2           As Integer
Open Table "D:\PhD\Database\Site_information.TAB"
Interactive
c=1
nrows2 = TableInfo(Site_information, TAB_INFO_NROWS)
  FOR c =1 TO nrows2
    Fetch Rec c from Site_information
      s_code(c)= Site_information.Site_code
      s_name(c)= Site_information.Site_name
      s_dims(c)= Site_information.Dimension_ha
      s_loc(c)= Site_information.Location
      s_loc_code(c)= Site_information.Location_code
      s_puse(c)= Site_information.Past_use
      s_puse_code(c)= Site_information.Past_use_code
      s_fuse(c)= Site_information.Future_use
      s_fuse_code(c)= Site_information.Future_use_code
      s_cont(c)= Site_information.Contamination
      s_cont_code(c)= Site_information.Contamination_code
      s_build(c)= Site_information.Building
      s_build_code(c)= Site_information.Building_code
      s_real_code(c)= Site_information.Realisation_code

```

```

NEXT
END SUB

```

### **5.3 Input variables**

The input to the system is the set of variables related to the sustainability indicators developed in the European Programme RESCUE (Regeneration of European sites in Cities and Urban Environments). These indicators are represented by a qualitative or quantitative measure of the site considered. Data for the sites are presented in Appendix C.

These data have been taken according to the sectors defined below by the RESCUE project as main work packages:

- contamination and the reuse of soil and debris, that may include immediate reuse on site, reuse after treatment or final cost effective disposal. The indicators belonging to this sector are related to air, noise, pollutant, contamination. Example: number of solid waste, soil and debris recycled per time unit/volumes of solid waste, soil and debris produced per time unit
- existing building and infrastructures - in many cases brownfield sites are particularly characterised by the existence of old buildings and infrastructures that are often dismantled rather than retained in a more sustainable way. Indicators cover information related to use of renewable sources, reuse of existing infrastructure. Example: percentage of solid buildings reused compared to all buildings on the regenerated site
- land use and urban design - the sustainable regeneration of urban brownfield sites requires both the identification of suitable use options and their implementation in an environmentally, economically and socially sound way. Indicators cover aspects such as promotion of land use that match demands

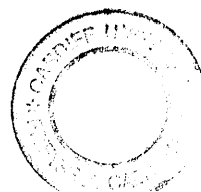

## Chapter 5 – The DSS

and needs, job creation, resources saving. Example: does the site development accord to the integrated urban development strategy?

- planning processes and methods for citizen participation - brownfield redevelopment is a complex matter with many actors and stakeholders who often pursue contrasting aims in the development process. To meet the demands of sustainability, a socially balanced planning process which offers participation opportunities for all interested parties should not aim at systematic consensus but is a prerequisite for each brownfield project. Indicators cover aspects such as information flow, complaints, transparency. Example: satisfaction/contestation of results

- management of brownfield projects - the achievement of a smooth, cost-efficient and low-risk realisation of brownfield redevelopment projects is the main responsibility of project managers . The project management function must integrate different philosophies and disciplines from both social and engineering sciences who take part in the regeneration process. Indicators cover aspects such as adoption of an interdisciplinary approach, existence of documents. Example: number and content of public progress reports made during the project.

Then these packages have been redistributed in 7 main sectors such as water, waste, land, contamination, building and infrastructure, energy and public participation to enable an easier allocation within the system.

In addition to these set of indicators, there are some other input variables for the area considered such as:

## Chapter 5 – The DSS

- location, the site could be located in the inner city, on the border or out of town;
- , size of the area considered;
- past use, that could be a harbour, coal mine, coke plant, etc.

A particular focus is given to the variable future/current use that represents the type of redevelopment undertaken or to be considered in the study area, such as industrial, commercial, mixed etc.

This variable is an important input to the system since it can be an input and also an output depending on the type of simulation performed by the system.

Detailed description of each indicator can be found in Appendix A. The indicators have been developed within the RESCUE project<sup>1</sup> and also the data collected have been provided under the same programme and are available in Appendix C.

## **5.4 Architecture of DSS**

The mathematical model developed elaborates the input data by using first the fuzzy logic procedure, and then artificial neural networks procedure in order to obtain the output of the DSS as shown in Figure 5.2.

The DSS architecture contains two different procedures:

- 1) **PROACTIVE:** the user does not know the type of redevelopment (commercial, residential, mixed, industrial etc) for the site and the output is in fact the sustainable regeneration scheme. The system also enables the user to run more than one simulation by modifying the input variables (in particular the importance of these) and therefore obtaining different scenarios with a measure of their sustainability. The interface requires the user to insert only the indicators related to the site and the site characteristics.
  
- 2) **REACTIVE:** the type of redevelopment has already been decided and the user can check the sustainability of the regeneration scheme chosen. The interface requires the user to insert the indicators related to the site and the expected output (that is the type of redevelopment is known).

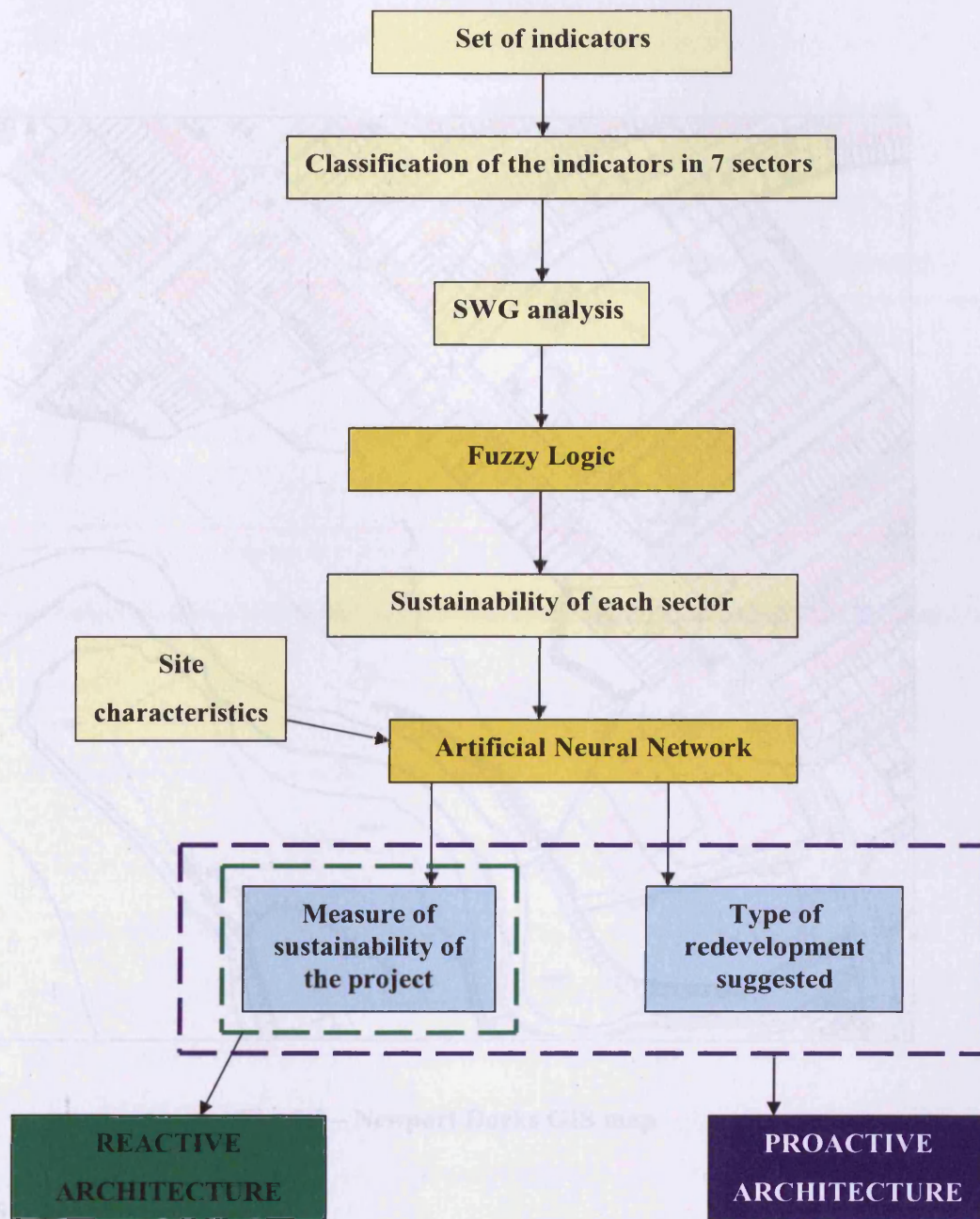

Figure 5.2 – The DSS algorithm

The integration of the results with the GIS allows the visualisation of the results and can also provide a map together with qualitative and quantitative information, when geo-referenced data are available for the considered site as shown in Figure 5.3 below.



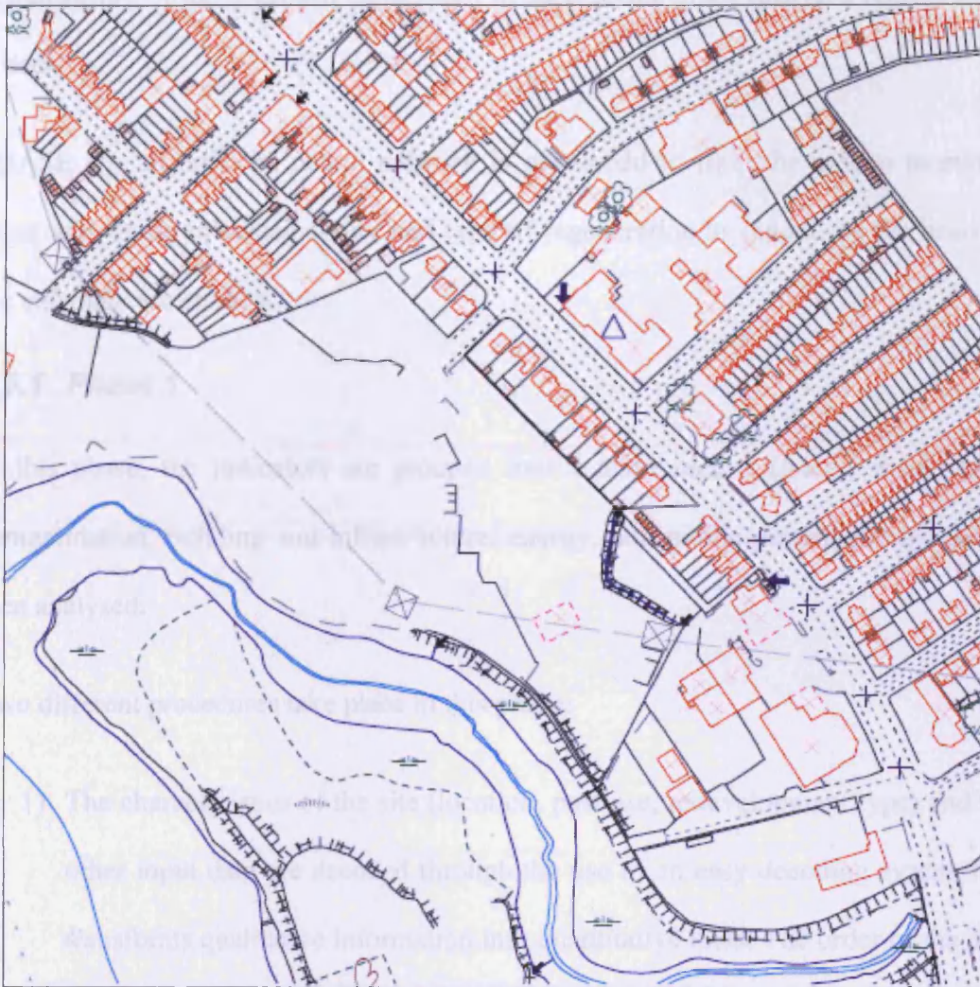

Fig. 5.3 – Newport Docks GIS map

## 5.5 Implementation

The system is developed by using the data collected from eight sites throughout Europe (made available through the European Project RESCUE), in particular two sites have been analysed for each of the following countries: France, Germany, Poland and UK.

The DSS is developed as result of the integration of two phases:

PHASE 1 – fuzzy logic is used to compare the indicators and evaluate the sustainability of the approach undertaken in each sector in the analysed regeneration process.

PHASE 2 – an artificial neural network is developed to train the system to match input with grade of sustainability and type of regeneration as output, on the basis of the existing case studies.

### **5.5.1 Phase 1**

In this phase, the indicators are grouped into 7 main sectors (water, waste, land, contamination, building and infrastructure, energy, and public participation) and are then analysed.

Two different procedures take place in this phase:

- 1) The characteristics of the site (location, past use, redevelopment type) and the other input data are decoded through the use of an easy decoding system that transforms qualitative information into quantitative ones. The order of the data is not relevant. This process enables to easily use and compare these particular site characteristics with the other indicators. Some examples are shown below.

Chapter 5 – The DSS

FUTURE COD	
1	industrial
2	commercial
3	leisure
4	residential
5	cultural
6	mixed development

LOCATION COD	LOCATION
1	inner city
2	out from town
3	border

PAST USE COD	PAST USE
1	harbour
2	coal mine
3	chemical plant
4	open cast mine
5	coke plant
6	vacant
7	abandoned
8	mixed industry
9	other

Table 5.1 – Decoding tables

## Chapter 5 – The DSS

2) The indicators are grouped in the 7 main sectors listed above and within these sectors, each indicator is then subject to Strength/Weakness/Gap analysis (SWG) on the basis of the available information for each site. The SWG follows the rule of “satisfaction of the indicator” as described below:

- **STRENGTH (S).** This refers to when the indicator is satisfied. This means that the information available is satisfactory, valuable and the issue related to the indicator has been taken into consideration;
- **WEAKNESS (W).** This refers to when the indicator is not considered and it means that the regeneration process does not take into consideration the issue related to the indicator. This can happen when the issue has been forgotten or when it is not relevant for the considered site;
- **GAP (G).** This refers to when no information is available.

The SWG for the 8 sites considered is presented in the table below and this has been developed on the basis of the available information for each site.

Indicator_name	Loisinord	Les Tertiales	Radbod	Espenhain	Bytom	Sosnowiec	Markham Willows	Gateshead	Newport
Different expert opinions for urban design	G	G	G	S	G	S	S	G	S
Secondary uses of buildings	G	W	G	S	W	W	G	G	S
Equal access to information	W	S	S	S	S	S	S	S	S
Alternative information	W	W	S	S	S	S	S	S	G
Budget allocated for participation	W	W	S	W	W	W	W	W	W
Symmetry of information flow	W	S	S	S	S	S	S	W	S
Publicity and documentation	S	S	G	G	W	W	S	S	S
Transparency of the process management	G	S	G	G	G	G	G	G	G
Involvement of stakeholders	W	S	W	W	S	S	S	W	S
Practical methods in the process management	W	G	S	S	S	S	S	S	W
Representativeness	W	S	S	S	S	S	S	S	G
Satisfaction	G	G	G	G	G	G	G	G	G
Existence of community information	G	G	S	G	G	G	G	G	S
Lowest budget control level	W	W	W	W	S	S	S	W	W
Quality management	W	W	S	S	G	S	S	S	S
Project management plan	W	W	G	G	G	G	S	S	G
Cost development	G	G	G	G	G	G	S	S	G
Marketing structure	W	W	G	G	G	G	S	S	S
Economic viability	G	G	G	G	G	G	S	S	G
Records of decisions	W	W	S	S	G	W	S	S	S
Health and safety plan	W	W	S	G	G	G	S	S	S
Costs benefits analysis	W	W	G	G	S	S	S	S	G
Pressure on neighbourhood	G	G	S	G	G	G	G	G	W
Ambient noise level	W	G	S	G	W	W	G	G	W
Air and dust quality impact	W	W	S	G	G	G	G	G	W
Surface and groundwater quality control	G	G	W	S	W	G	W	G	G
Risk management framework	W	S	W	S	S	S	S	S	G
Waste, soils and debris management	S	G	S	S	S	S	S	S	W

Post remediation validation	W	G	G	G	W	W	G	S	G
Documented strategy	G	G	G	G	G	G	G	G	S
Decision support tools	G	G	S	S	G	G	G	S	G
energy consuption standard	G	W	G	G	S	G	G	S	G
Energy efficiency optimisation possibilities	W	W	G	G	S	G	G	S	G
Renewable energy production	W	G	W	S	S	G	S	S	W
Potable water reduction facilities	S	W	W	G	S	G	G	S	W
Unpurified waste water runoff	S	G	W	S	S	G	G	S	G
Rainwater separation	W	W	S	S	W	S	S	S	G
building material recycling and reuse	S	S	S	G	W	S	S	S	S
Building material recycling and reuse on site	S	S	S	G	S	S	S	S	S
Conservation of industrial monuments	W	S	S	S	W	W	S	S	S
Effectiveness of health and safety	G	G	G	G	W	G	G	S	S
Guideline use	G	G	G	G	W	G	S	S	G
Studies realised	G	G	G	G	W	G	S	S	S
Financing and taxation approaches	G	G	G	G	W	G	S	S	G
Integration of the intended land use into the objectives of the regional economic development	S	W	G	S	S	W	S	G	S
Proof of sufficient demand	S	W	G	S	S	W	S	G	W
Integration of site development	S	S	S	G	G	G	G	G	S
Accordance of the site development to the integrated urban development strategy	G	G	G	G	G	G	S	G	S
Acceptance of the project	G	G	S	S	S	G	G	G	G
Number of jobs	G	G	G	G	G	G	G	G	W
Job structure on the site	G	G	G	G	G	G	G	G	W
Generation of employment and development off site	G	G	G	G	G	G	G	G	S
Compatibility of the intended land use functions with the natural and anthropogenic environment	G	G	S	G	S	G	S	S	G

Ratio of surface sealing	G	G	S	G	S	G	G	S	G
Destroying/developing valuable biotopes	G	G	S	G	S	G	G	S	S
Saving water, energy, building material by urban design	G	G	S	G	S	G	G	S	S
Connections across the brownfield site	G	G	S	S	G	G	S	S	S
Public transport stop, modal split	G	G	G	S	G	S	S	S	S
Adoption of an integrated traffic concept	W	W	G	S	W	S	S	S	G

**Table 5.2 – SWG analysis for the case studies and the test case.**

## Chapter 5 – The DSS

Quantitative values are then assigned to transform the qualitative information into quantitative ones by using the following values

$$S=1, W=-1, G=0$$

If the indicator is satisfied (Strength) this represents a positive influence on the sustainability of the project therefore the value assigned is 1. If the indicator has not been considered this has a negative influence on the overall sustainability of the project, therefore value assigned needs to be negative (-1) to measure the negative impact created. If information are not available the value assigned is 0 that represents a balance between negative and positive impact.

At this point the system performs the weighting of each indicator, which is a measure of the importance of the sector they belong to in the studied site. For example: a site located in a remote area will have the indicator relative to public participation as “low importance”.

The program is developed on the basis of 8 sites. The variables of the system at this stage are shown below:

$A_{k_i}$  = indicator of site k sector i

where  $k=1..n$ ,  $n$ =number of sites (8) and  $i=1..m$ ,  $m$ =number of sectors (7)

$A_{k_{ij}}$  = score of partial indicator j belonging to sector i and site k

$W_{k_{ij}}$  = weight of partial indicator j belonging to sector i and site k

This weight represents the importance of each indicator against the sector in the specific site. The weighting system is processed through the membership function



since the weight assigned is a measure of the “belonging/importance” of each indicator to the sector.

Each partial indicator is weighted as follows:

$$Ak_{ij} = Wk_{ij} \sum Ak_{ij} / Ak_{max}$$

The system then calculates the weighted indicator and assigns the value to the variable  $Ak_i$ .

At this stage the Fuzzy Associative Matrix is used. The matrix is represented by a set of rules that are generated to govern the system’s behaviour for each combination of inputs. (e.g. IF condition THEN output....).

Another weight ( $PAk_i$ ) that represents the importance of the sector is here introduced to determine the sustainability of the sector against the project.

$PAk_i$  = weight of sector against the site itself (assumes values such as low, medium, high). This represents the importance of the sector in the area considered.

This matrix allows determining the sustainability of each sector by comparing the variable  $Ak_i$  with the importance  $PAk_i$ .

	(0,0.3)	(0.4,0.7)	(0.8,1)
$\geq 5$	<b>Good Practice</b>	<b>Best Practice</b>	<b>Best Practice</b>
(0,5)	<b>Minimum acceptance</b>	<b>Minimum acceptance</b>	<b>Good Practice</b>
$< 0$	<b>Bad Practice</b>	<b>Bad Practice</b>	<b>Bad Practice</b>

Table 5.3 – Fuzzy Associative Matrix

The output of this phase is the sustainability of each sector in terms of bad practice, minimum practice, good practice, best practice (e.g sector waste= good practice; sector water=minimum acceptance and etc). These variables are the input of Phase 2 where the artificial neural network analyses the characteristics of the site and the sustainability in order to determine the type of regeneration that results sustainable.

### **5.5.2 Phase 2**

In this phase the artificial neural network is developed. The ANN is used to learn and understand the relationship between the sustainability of the eight sectors (output of the fuzzy logic part), the site characteristics and the type of sustainable redevelopment (commercial, industrial, residential, mixed use..etc).

On the basis of the variables involved in the procedure, the ANN chosen for the DSS has the following characteristics:

- *architecture*: feedforward, allow signals to travel one way only from input to output. This architecture has been chosen since the system only requires to analyse the input variables and not change them automatically.
- *Training algorithm*: supervised, training examples comprise input vectors  $x$  and output  $y$  desired. The algorithm has been chosen on the basis that the input data and the output data are known for all the case studies and are entered to the system to support and facilitate the learning process.
- *Hidden layers*: one in relation to the number of operations required since the system requires to perform only one operation between input and output.

## Chapter 5 – The DSS

- *Input neurons:* 12 neurons have been selected. Neurons 1 to 4 represent the general characteristics of the site and neurons 5 to 12 represent the different sectors as output of Phase 1;

neuron 1: Past use (coal mine, colliery, harbour...)

neuron 2: Size (hectares or sqm)

neuron 3: Location (inner city, out from town, boarder)

neuron 4: Future use or current (industrial, residential, commercial, mixed, leisure, cultural)

neuron 5: Waste

neuron 6: Water

neuron 7: Land

neuron 8: Buildings

neuron 9: Contamination

neuron 10: Energy

neuron 11: Public participation

neuron 12: Type of redevelopment

- *Output neurons:* the output neurons are different depending on which architecture has been chosen.

## Chapter 5 – The DSS

For the proactive architecture the output neurons are:

neuron 1: Type of redevelopment

neuron 2: Sustainability of the project

For the reactive architecture the output neuron is only:

neuron 2: Sustainability of the project

The network is trained with the eight case studies. For each case study the values related to each neuron, as obtained in phase 1 are entered directly through a procedure.

To avoid issues and duplications with the name of the variables used within the programming language features, the output of Phase I are re-named in the following way:

$x_i = Ak_i = \text{value of the sector (sustainability)}$

$w_i = PAk_i = \text{weight of } x_i$

where  $i=(1..n)$   $n=12$

Each of these inputs is multiplied by its respective weighting factor (1 to 10) as a first step in the process. The weights specify the strength of the influence and importance of the sector in the regeneration process.

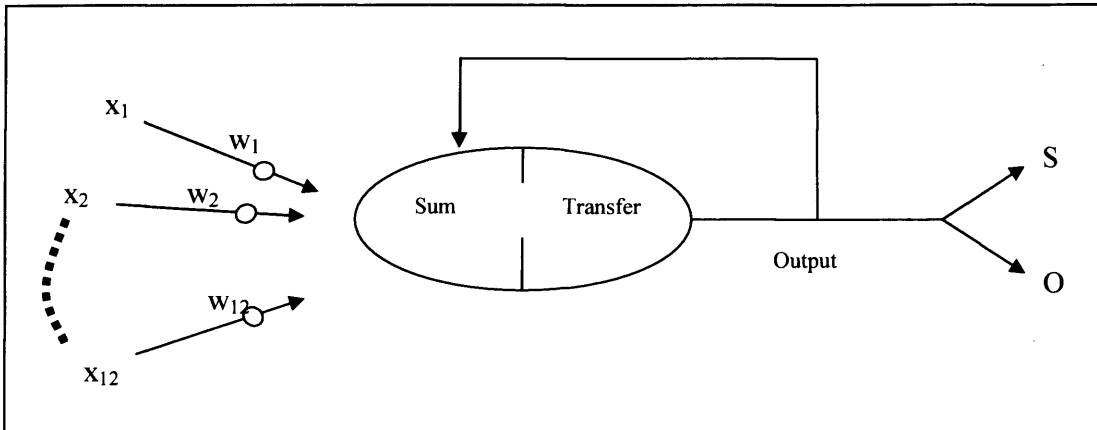

**Fig. 5.4 - The developed Artificial Neural Network**

These values are then fed into the summing function below:

$$I = \sum x_i w_i \text{ for } i=1 \text{ to } 12$$

The output of the function is then sent into the transfer function as shown in Figure 5.2. This function turns this number into a real output represented by two variables in the proactive architecture and one variable in the reactive architecture.

The output, depending on the architecture, includes:

PROACTIVE

S= measure of sustainability

O= type of redevelopment

REACTIVE

S= measure of sustainability

There are two transfer functions in reality: one for the measure of sustainability and one for the type of redevelopment.

The measure of sustainability is then converted into qualitative information by using the following table:

S	Grade of sustainability
<25	Not sustainable
<=60	Sustainable
>60	Best Practice

**Table 5.3 – Grade of Sustainability**

At this stage the system uses the supervised learning process which is a process of approximating a set of data by undertaking the following sequence of operations:

- 1) set n=number of neurons and m=number of output and set the initial values of the connection weights of the network;
- 2) the input vector  $\mathbf{x}$  (where  $\mathbf{x}=\mathbf{x}_1,\mathbf{x}_2\dots\mathbf{x}_i$ ) is supplied to the network
- 3) the output vector  $\mathbf{o}$  (where  $\mathbf{o}=\mathbf{o}_1,\mathbf{o}_2$ ) is calculated as produced by the network
- 4) the output vector  $\mathbf{o}$  is compared with the desired output vector  $\mathbf{y}$  (where  $\mathbf{y}=\mathbf{y}_1,\mathbf{y}_2$ )
- 5) the connection weights are corrected in such a way that the next time that  $\mathbf{x}$  is presented to the network, the produced output  $\mathbf{o}$  becomes closer to the desired output  $\mathbf{y}$
- 6) if necessary, step 2 and 5 are repeated until the network reaches a convergence state.

The network stops learning when the error calculated as follows is minimised<sup>2</sup>:

$$\text{Err} = \frac{\left( \sum_{k=1}^p \sum_{j=1}^m (o_j^{(k)} - y_j^{(k)})^2 \right)}{p * m}$$

where:

$o_j^{(k)}$  = output value of the  $j^{\text{th}}$  output of the network when the  $k^{\text{th}}$  training examples is presented;

$y_j^{(k)}$  = desired result for the  $j^{\text{th}}$  output for the  $k^{\text{th}}$  training examples

$p$  = number of training examples (in this case 8 as the case studies submitted)

$m$  = dimension of the output space (in this case 2 as the two desired output)

The training process is repeated until the combination input neurons-type of redevelopment presents the minimum error.

The entire process is repeated for each of the eight case studies. This allows the network to be trained. During the learning process and for each of the case studies the ANN keeps memory of the following information: input variables, O, I.

The variable O at this stage is still a number that will be converted to the correspondent type of redevelopment at the end of the process.

To summarise the procedure followed by the DSS is different depending on the chosen options: the reactive architecture proceeds with undertaking the above described operations (sum function, transfer function, error minimisation); the proactive system analyses the input neurons following the same procedure as the reactive one but assigning a different value to the type of redevelopment for each cycle.

## **5.6 Testing**

The DSS and in particular the artificial neural network have been tested to check the performance in terms of time to provide results and to verify the results.

The testing of the interface includes the introduction of wrong characters or nil information to check that the system does not crash but provides an intelligent message to the user indicating which type of variables are accepted.

The testing of the artificial neural network is the most important because it enlightens the validity and consistency of the results. This procedure has been undertaken in two ways:

- 1) The information related to each of the eight case studies is re-introduced in the system without providing the current regeneration scheme undertaken in each site. This verifies that the system has learnt the existing interrelationships between the characteristics of the site, the sectors, the grade of sustainability and the type of redevelopment provided as output;
- 2) The information related to a new case study Newport Docks (Wales – UK) is used to test the functionality and performance of the system.

## **5.7 Interface**

The interface allows the user to easily enter the information and visualise the results.

The first step is the request to the user about the following:

- Number of sites to be evaluated
- Type of architecture required (proactive or reactive)

Once the architecture has been chosen the user is asked to enter the information about the indicators for each sector, their weights plus the general characteristics of the site.

A table is provided to the user to be easily filled and entered into the system. For



## Chapter 5 – The DSS

reactive architecture there is also the request to introduce the type of redevelopment scheme already chosen.

The ideal situation to maximise the potential of the DSS is for the user to provide an electronic map of the site considered. By introducing this to the GIS, the system will be able to provide graphical information together with qualitative and quantitative ones.

Chapter 5 – The DSS

REFERENCES:

1. RESCUE (2004) - *Sustainable Assessment Tool*. Available from:  
[http://www.rescue-europe.com/download/reports/2\\_5\\_2\\_Administrative%20tools%20and%20incentives%20-%20SAT.pdf](http://www.rescue-europe.com/download/reports/2_5_2_Administrative%20tools%20and%20incentives%20-%20SAT.pdf)
2. Hassoun M.H., (1995) - *Fundamentals of Artificial Neural Networks* - The MIT Press

# Chapter 6

## Case Studies

### 6.1 Case Studies

The DSS analyses 8 case studies in four European countries (France, Germany, Poland and UK). The sites considered are at different redevelopment phases and they present different social, economic, environmental and geographical characteristics.

The case studies have been used in two different ways:

- 1) To train the neural network. From the cases the system learnt how to treat the information in input and transform these into an appropriate output
- 2) To check the performance of the DSS. After training the networks, the cases have been submitted to the DSS as a test to check that the results obtained were compatible with the real ones.

The case studies have been chosen on the basis of considering a wide and differentiated range of sustainable regeneration processes in European Countries<sup>1</sup>. The breadth of this approach is desired to ensure an almost complete representation of the different approaches to brownfield redevelopment. It is also desired to provide a wide range of relevant decision factors that may lead to the success and / or to the failure of the projects.

## Chapter 6 – Case Studies

In France, the sites are:

1. Loisinord – located in the outside of the city on the border of four municipalities. The previous use was as a coal extraction site and coke plant. The regeneration process provides a new use as leisure facilities.
2. Les Tertiales – located near the city centre. There is presence of contamination. The regeneration process provides a new use as mixed redevelopment.

In Germany, the sites are:

1. Radbod – located in the city. The previous use was as a coalmine and cokery. There is presence of contamination, and also few listed buildings. The regeneration process provides a new use such as industrial.
2. Espenhain – located outside the city. The area included a few former chemical plants and two power stations. There is presence of contamination, and one industrial monument. The regeneration process provides a new use as industrial and Science Park.

In Poland, the sites are:

1. The Dolomites sports valley – located peripheral to the city. The previous use was as a dolomite open cast mine. There is no presence of contamination, and no listed buildings. The regeneration process provides a new use as a leisure and recreational centre.

## Chapter 6 – Case Studies

2. Sosnowiec coalmine – located in the inner city. There is presence of contamination, and presence of some infrastructures. The regeneration process provides a new use as mixed redevelopment.

In the UK, the sites are:

1. Markham – located outside the city. The previous use was coal mine and tip. There is presence of contamination, and no listed buildings. The regeneration process provides a new use as commercial redevelopment.
2. Gateshead Quay – located in the inner city. There is presence of contamination, and some major structures are retained. The regeneration process provides a new use as mixed redevelopment.

### **6.1.1 French Case Studies**

#### **Loisinord**

Loisinord is situated in the Nord-Pas de Calais Coalfield that is the largest in France (206,372 hectares), 100 kilometres long and only 15 to 5 kilometres wide. The coalmining industry started in 1720. 1960 is the symbolic starting point of the planned decline of coal production in the Nord/Pas de Calais. Two famous National Programs - "Plan Jeanneney 1960 - 1965" and "Plan Bettencourt 1968"<sup>2</sup> - drastically reduced coal production and led to the closing of the least competitive sites. Despite desperate attempts to strengthen coal production in the early eighties, the coal decline was inexorable in the Nord-Pas de Calais, and in Europe. It stopped in December 1990 in Oignies.



**Fig. 6.1 - Loisinord Site**

(SOURCE: Loisinord Site Information. Available from:

<http://www.missionbassinminier.org/html/chantiers/urbanisme.php?position=4>)



**Fig. 6.2 - The Loisinord Sky pist opened in November 2006**

(SOURCE: Loisinord Site Information. Available from:

<http://www.missionbassinminier.org/html/chantiers/urbanisme.php?position=4>)

Loisinord site consisted of the coal mine and coking unit, and farm lands. Coal extraction activities closed down in 1961. In 1986 the land was sold by Houillères du

Bassin du Nord and du Pas de Calais to the Noeux les Mines municipality. The main fieldworks were carried out between 1988 and 1996, resulting in the demolition of the coke plant and the realisation of a skiing piste on Tip 42.

The site is located on the board of a coal basin and the regeneration of the western urban area includes a leisure park (see Figures 6.1 and 6.2), whilst the eastern area has been developed as a skiing pist.

### **Les Tertiales - Forgeval**

The site is located near the city centre. The regeneration process involves the realisation of a mixed development including universities, commercial and residential areas as shown in Figure 6.3. The redevelopment of the site Les Tertiales, including the construction phase, has been completed. The adjacent site, known as Forgeval, has been closed down in 2000 and the respective site characterisation is still on going.



**Fig. 6.3 - Les Tertiales site**

(SOURCE: RESCUE (2004) – *Regions and Case Studies*. Available from:

<http://www.rescue-europe.com/html/regions.html> )

### 6.1.2 German Case Studies

#### Radbod, City of Hamm

Radbod is situated within the Ruhr area which represents the largest conurbation in Germany and one of the biggest in Europe with 5.4 million people. The population density is about 1.213 persons per km. Framed by the rivers Ruhr to the south and Rhine to the west, the region stretches over 116 km from east to west and 67 km from north to south. Being one of the world's oldest industrial zones, the Ruhr comprises 11 cities and four counties with 42 more municipalities. Several important highways cross the Ruhr, turning it into the heart of the European traffic network as shown in Figure 6.4.

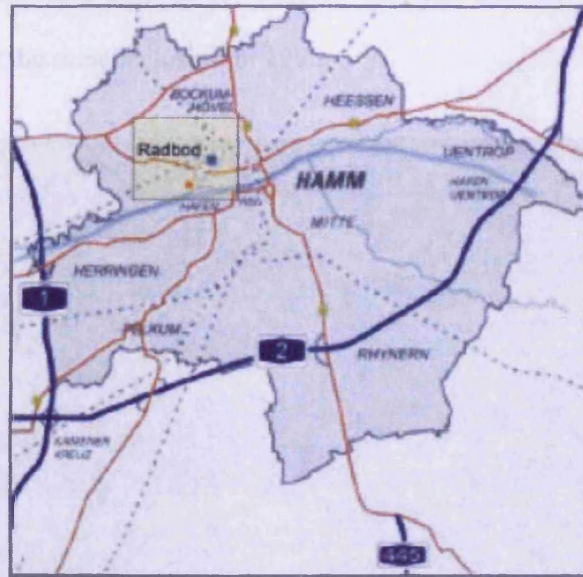

Fig. 6.4 - Map of Ruhr Area

(SOURCE: RESCUE (2004) – *Regions and Case Studies*. Available from:

<http://www.rescue-europe.com/html/regions.html> )

The City of Hamm, with about 190.000 inhabitants, is located on the north-eastern fringe of the densely built up Ruhr region, bordering on the more rural parts of



## Chapter 6 – Case Studies

Westphalia. The location is well integrated into the regional and national traffic network.

The history of Radbod began in 1904 when preparations for coalmining at Radbod 1/2/5 began. The actual extraction started in 1906. Six years later, in 1912 the coking plant was commissioned and its demand for coal contributed to the mine's growth. In 1914, the mine had 3.500 employees and extracted more than 700.000 t of coal. During the two world wars the mine continued to increase production until it was seriously damaged by air strikes in 1945. In the following years the damage was repaired and extraction was further improved so that in the most productive years, from 1955 to 1960, more than 4.200 employees mined 1.2 million tons of hard coal each year. In the following three decades the number of employees reduced continuously until the mine's closure in 1990.



**Fig. 6.5 - Northward aerial view of the site**

(SOURCE: RESCUE (2004) – *Regions and Case Studies*. Available from:

<http://www.rescue-europe.com/html/regions.html> )

## Chapter 6 – Case Studies

From 1992 to 1995, the sanitation process of the Radbod site commenced with an exploration and investigation phase. An active soil management approach was adopted during the recovery of the site, commencing with a restoration of site levels to reinstate settlement due to mining subsidence. Soil containing light concentrations of hydrocarbon and other contamination was securely accumulated in the southern part of the project area. Foundations and other construction obstacles were removed during this phase, along with more heavily contaminated materials which were disposed offsite. Also the marketing of the plots of land started in 2000 after this site restoration was accomplished.

Today, six original buildings at Radbod stand as evidence of its industrial history and play an important role in the conservation of the site's industrial heritage: The two shaft towers (see Figure 6.6) and the steam engine house are listed buildings and are preserved from demolition. The old porter-house and the vehicle hall are integrated into the regeneration scheme and will be reused. The "Winkhaus" shaft is still in operation for ventilation purposes, helping to preserve the traditional outward appearance of the site.



Fig. 6.7 - D Fig. 6.6 - Listed shaft towers (view to the north-east)

(SOURCE: RESCUE (2004) – *Regions and Case Studies*. Available from:

(SOURCE: <http://www.rescue-europe.com/html/regions.html> )

Although Radbod is surrounded by green spaces on three sides, it is located directly south of the Hamm Bockum-Hövel urban area. The location is well linked to the regional and national traffic network. The railway station of Hamm offers high speed train connections; the site itself is serviced by bus. The size of Radbod is approximately 21 ha of which 15 ha will be re-used, 8.5 ha for commercial users and 6.5 ha for industrial purposes.

The regeneration concept is based on a diverse and flexible design. Important aspects are the integration of the historical buildings, existing greens, and the diverse design of streets, including soft and hard landscaped squares (see Figure 6.7).

#### Espehain

Espehain lies in the former lignite basin of the "Saarland Leipzig" (see Figure 6.8). After political change in 1989/90, the economic monostructure of Saarland Leipzig proved to be no longer economically or environmentally viable. What followed was a structural change, unmatched in its speed and impact in the history of the central European region.

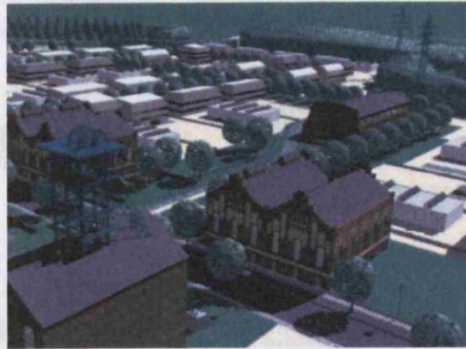

**Fig. 6.7 - Detail of the 3D-model of the planned future use (view to the south-east)**

(SOURCE: RESCUE (2004) – *Regions and Case Studies*. Available from:

<http://www.rescue-europe.com/html/regions.html> )

To achieve this objective a legally binding land use and building plan was created. The regeneration scheme implements a public-private partnership mode. The “Radbod” development agency, which was set up for the regeneration of the site, consists of the two site owners (STEAG AG (Steinkohlen-Elektrizitäts AG) and MGG (Montan-Grundstücksgesellschaft mbH), both corporations being subsidiaries of the RAG AG corporation), and the City of Hamm which holds majority control. The regeneration scheme prioritises employment and training opportunities for local citizens. In this context, a special qualification scheme for landscape gardeners was integrated into the design of the open space on the site.

### **Espenhain**

Espenhain lies in the former lignite basin of the “Südraum Leipzig”(see Figure6.8). After political change in 1989/90, the economic monostructure of Südraum Leipzig proved to be no longer economically or environmentally viable. What followed was a structural change, unmatched in its speed and impact in the history of the central European region.

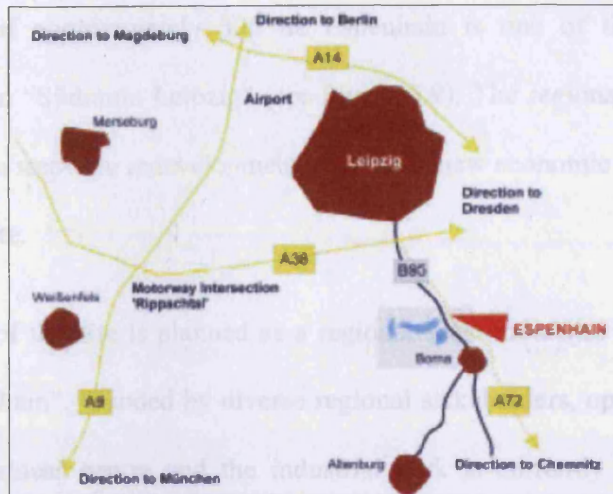

Fig. 6.8 - Map location of Espenhain

(SOURCE: RESCUE (2004) – *Regions and Case Studies*. Available from:

<http://www.rescue-europe.com/html/regions.html> )

Espenhain's lignite chemical plant, briquette factory and power station were built and commissioned between 1937 and 1942. As Germany had no access to major oil resources, carbon chemistry was developed very strongly in this location in order to produce fuel and lubricant during World War II.

After hostilities ended, lignite remained the main energy base of the economy of the German Democratic Republic (GDR).

Due to the enormous level of pollution caused by the plant, Espenhain became the catalyst for the GDR's environmental movement. This was especially evident in the village of Mölbis, located downwind of Espenhain, which suffered the highest level of pollution in the GDR. In 1983 the environmental movement held a religious service for the environment which began a campaign, in which money was collected for environmental improvement in Espenhain ("eine Mark für Espenhain").

The industrial activities ended in 1990, with power station closure following in 1999.

With an area of approximately 300 ha Espenhain is one of the largest former industrial sites in “Südraum Leipzig” (see Figure 6.9). The regional stakeholders are co-operating in a stepwise redevelopment to create a new economic and technological profile for the site.

The future use of the site is planned as a regional-scale industrial and science park. “Campus Espenhain”, founded by diverse regional stakeholders, opened in 1998 as a science and business centre and the industrial park is currently being developed. Within “Campus Espenhain”, research is carried out to create concepts for regional structural change and to implement the results in development projects.

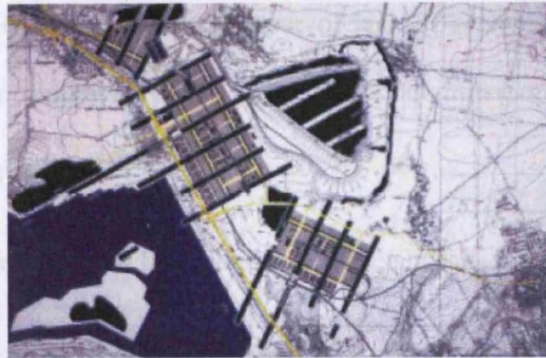

**Fig. 6.9 - Eastward aerial view of the site**

(SOURCE: RESCUE (2004) – *Regions and Case Studies*. Available from:

<http://www.rescue-europe.com/html/regions.html> )

Major demolition and decontamination works have been undertaken in recent years. The local plan (Bebauungsplan) , as shown in Figure 6.10, for the central part of the site was realised in 2004. Closely linked to the project is the restoration of the former lignite mine and the waste tip of Espenhain (Trages-heep). In addition leisure centres are planned in the neighbourhood of the site.



**Fig. 6.10 - Concept for the site and its surroundings**

(SOURCE: RESCUE (2004) – *Regions and Case Studies*. Available from:

<http://www.rescue-europe.com/html/regions.html> )

### **6.1.3 Polish Case Studies**

#### **The Dolomites Sport Valley**

The Dolomites site is located in the Silesia Region (voivodship) that is situated in south part of Poland and consists of 19 cities, 17 districts and 166 communities.

The Silesia Region takes 12,294 square kilometres of area (that is about 3.9 % of the total Poland area), where live 4,882,400 inhabitants (that is 12.6 % of the total Poland inhabitants). The density of population in this region is equal to 397 persons per square kilometres and it is 3.2 times greater than the average in Poland.

Silesia region is the most degraded environmentally area in Poland as can be noted by the following basic indicators (1998):

- 21,5 % of dust emission from mines to air in Poland
- 21,7 % of emission of gasses in Poland

The low quality of surface water because of lack of sewerage, low efficiency of waste water treatment plants, industrial contamination - particularly salt waters from mines

- a large area endangered by ground subsidence because of mining
- 55,600,000 ton per year of solid waste (i.e. 42 % waste in Poland)

The regeneration and redevelopment of sites in cities and urban environment in Silesia region is the biggest environmental, economic and social problem particularly in consequence of negative impact on environment of mining industry.

The Dolomite Sport Valley is situated within the city of Bytom and was previously used as an area for heavy industry. The site, of the size of 37.64 hectares, in fact was formerly occupied by the Bytom Dolomite Mining Works. The soil contained heavy metal contamination, but due to the low concentrations this was not considered to represent a significant constraint to the redevelopment of the site (see Figure 6.11).

All the original buildings and infrastructure were dismantled and no longer exist.



**Fig. 6.11 - Ski slope at Sport Valley**

(SOURCE: RESCUE (2004) – *Regions and Case Studies*. Available from:

<http://www.rescue-europe.com/html/regions.html> )



## Chapter 6 – Case Studies

The Dolomite Sport Valley project has transformed the previously derelict dolomite mine into an all year round leisure and recreation centre, situated between the adjacent Segiet Nature Reserve, and neighbouring housing estates. A range of disciplines participated in the project – site owner, planners, engineers and local authorities. This integrated approach was aimed at satisfying:

- the social needs: by improving the quality of life;
- the companies interests: by providing profits for the owner/developer and for small and medium cooperating;
- the enterprises;
- the local authority's interests: by providing income for the local budget and improvement of the urban environment.

During the planning and the decision making process, a participatory approach has been used, consistent with the Polish law. Different stakeholders' interests have been accommodated in the development of this site to ensure that the project was a response to local and regional community needs.

In addition, the project has improved the ecological state of the area through the adoption of protection measures to preserve the neighbouring natural environment.

### **Sosnowiec Coal Mine**

The Sosnowiec Coal Mine is located in the Silesia region. The mine is comprised of two separate areas, both of which play key roles for the development of the city:

- one is located in central part of the city, directly adjacent to the intersection of a main communication arteries of the city;

- the other is located 5 km from the city centre but in a strategic location due to its convenient road network and railway proximity.

The Local Authority was keen to regenerate, redevelop and integrate these areas into the functional and spatial structure of their surroundings with the aim of contributing to the local economy and sustainable development of the city. The main goal was to create conditions whereby public services, economic activities, residential facilities and recreational amenities can coexist.

The former “SOSNOWIEC” Coal Mine in figure 6.12, that is the one used as case study, has a total surface of 31.5 hectares and it is located in the central part of the city. This location, directly adjacent to one of the main communication artery intersection of the city is very advantageous in terms of accessibility. The site is close and well connected with the commercial centre and also the railway station, which serves the Warsaw-Katowice railroad. It is also accessible by car or by public transport.



**Fig. 6.12 - Sosnowiec Coal Mine**

(SOURCE: RESCUE (2004) – *Regions and Case Studies*. Available from:

<http://www.rescue-europe.com/html/regions.html> )

On the Northern side of the site, a new multifunctional commercial and service centre was opened in 2001. The Eastern side is delineated by an area featuring small gardens and single family housing units. Garment factories ZPO “BYTOM”, still in operation, and ZPD “WANDA”, already closed, are located in the South-East corner. The Western boundary features apartment houses completed in the 1970’s, near a park area along the Czarna Przemsza river banks. At the North-East corner, the \_RODULA Park is located, where construction of an artificial ski slope has started.

Almost all industrial facilities located on the mine area have been demolished with the exception of one 3-floor administration and social building and two workshop and storage facilities. In the South-East part of the area, a new manufacturing plant is under construction.

According to the Local Spatial Management Plan approved by the City Council in February 2001, the former SOSNOWIEC Coal Mine area shall be divided in three areas and used for the location of service centres and back-up facilities for the automotive industry, for single family housing, and for manufacturing and service provider units.

In addition, the North-West part of the area is to be transformed into park facilities with the possible inclusion of supplementary service centres. To the South, multilevel parking facilities shall be provided for the use of citizens living in the neighbouring housing district.

The plan assumes local access roads shall be completed to provide easy links from this area to the main two streets. Also walking & cycling paths shall be provided, free

from traffic, linking this area with the Commercial & Service Centre and the residential district.

The Spatial Management Plan of the former coal mine area also assumes one existing pit shaft hoist tower should be kept as an example of mining excavation history. Moreover, an historic building originating from the early years of the last century, located at Narutowicz Street, within which electrical equipment of the coal mine has been installed, should be included in the national monument preservation policy.

On the Eastern side of the mine area, along Kombajnistów Street, a spoil bank has been reclaimed in order to reinstate the environmental conditions as they were before mining excavation started.

All industrial facilities of the mine, including the rail tracks, have been dismantled, and the reclaimed area has been levelled. The office buildings and the storage yard have remained and may be reused.

#### **6.1.4 UK Case Studies**

##### **Markham Willows (part of Markham Colliery)**

The former Markham colliery is situated to the north-eastern corner of the county of Derbyshire, England, within the District of Bolsover<sup>3</sup>. Mining work began at this site about 1882 and continued until its closure in 1993.

Markham was one of the last three collieries closed within the county ending more than 150 years of deep mining in Derbyshire – an industry which, fifty years ago, had employed more than 60,000 at 100 collieries across the County. It was estimated at the time that two jobs in coal industry related jobs would be lost for every one lost in the mining industry.

Markham colliery forms the heart of the Markham Employment Growth Zone (MEGZ), shown in Figure 6.13.



**Fig. 6.13 - Markham Employment Growth Zone**

(SOURCE: RESCUE (2004) – *Regions and Case Studies*. Available from:

<http://www.rescue-europe.com/html/regions.html> )

The construction of the new junction 29a will give direct access onto the M1 Motorway from the former Markham colliery. 50 hectares of Markham's North Tip will be used to produce biomass as a renewable energy resource to fuel heating boilers for buildings within MEGZ. Markham's South Tip and part of the North Tip totalling 45.6 hectares will be planted as sustainable deciduous woodland.

## Chapter 6 – Case Studies

The concept of the Markham Employment Growth Zone (MEGZ) originated as a response to the Coalfields Task Force Report "Making the Difference - A New Start for England's Coalfield Communities" June 1998. At the heart of this proposal is the need to reverse the decline in the North Derbyshire/North Nottinghamshire Coalfield resulting from the legacy of pit closures and more recent job losses. In order to provide the social, economic and environmental improvements needed the Task Force Report recognised the fundamental need for improved access to such areas and identified this project as a key coalfield regeneration scheme. In December 2001 the Government also recognised the importance of the project when they gave financial approval, subject to the necessary statutory procedures, to the highway infrastructure through the Local Transport Plan.

One of the objectives of MEGZ is to create a sustainable development. This will be achieved by the following methods:

- using renewable energy to heat buildings
- recycling waste produced within the site
- planting woodland as a carbon sink and sustainable resource.
- provide community transport to service the site and local workforce.
- provide a direct link with the rail network

Markham Willows (see Figure 6.14) is a project within MEGZ designed to utilise the spoil heap known as the North Tip of the former Markham colliery to grow primarily willow as short rotation coppice (SRC) to be used as a renewable energy resource.

## Chapter 6 – Case Studies

The SRC will be used to generate biomass to fuel boilers providing heat to industrial units within MEGZ.

The North Tip has approximately 300mm of cover which can be described as top soil.

The soil pH ranges from 1 through to 9 due to situations of localised oxidisation and the tipping of extracted limestone bedrock spoil respectively. The North Tip falls away steeply on all sides consequently water availability for the willow crop is a key issue. Sewage cake is being applied as a soil conditioner to improve soil moisture and nutrient content, to the benefit of both the crop and beneficial soil micro-organisms.

To visually integrate the North Tip into the surrounding landscape hedgerows will be planted emulating the surrounding field patterns. 3D visualisations have shown that using hedgerows to section the tip longitudinally will reduce the perceived height of the tip to the viewer.



**Fig. 6.14 - Markham Willows**

(SOURCE: RESCUE (2004) – *Regions and Case Studies*. Available from:

<http://www.rescue-europe.com/html/regions.html> )

The Markham Willows project is being undertaken by a consortium consisting of - AEA Technology (Environmental), R3 Environmental Technology, exSite and Groundwork UK.

### **Gateshead Quay**

Gateshead Quays lies at the heart of Tyneside next to the world famous Tyne Bridge. This site was a derelict land. In fact, it had been in decline since the Second World War and much of it was occupied by a scrapyards or used as a site for travellers.

However, the site wasn't always an area of industrial decay; indeed the site of The Sage Gateshead was originally called Rector's Field, an open area of land associated with the nearby parish church of St Mary's. The character of the neighbourhood changed dramatically in 1835 when the industrialist John Abbot relocated the bulk of his metalworking interests to its eastern side. This remained a major general & maritime engineering works until its closure in 1909 and was closely involved in the construction of both the High Level Bridge and Newcastle Central Station.

More than £250 million is being invested to create a cutting edge, world-class arts, leisure and residential destination<sup>4</sup>. Gateshead Council and its partners are overseeing five major projects - three funded by the National Lottery.

Developments include an international contemporary art space, a pioneering music centre and a stunning bridge. They are at the heart of the new cultural quarter and will be complemented by a lifestyle and leisure quarter, and a luxury residential development. The area was a major contribution to the joint bid by Newcastle and Gateshead to be the European Capital of Culture in 2008.



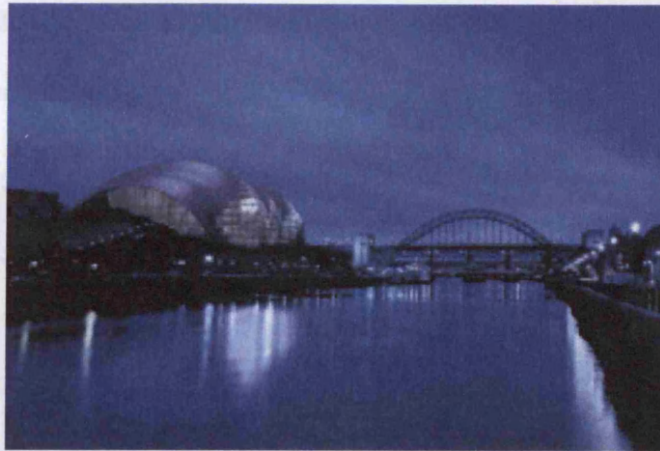

**Fig. 6.15 - The Gateshead Quay**

(SOURCE: RESCUE (2004) – *Regions and Case Studies*. Available from:

<http://www.rescue-europe.com/html/regions.html> )

The first part of Gateshead Quays (see Figure 6.15) opened for business in summer 1999. Tyneside's most offbeat nightclub – the Baja Beach Club – opened along with a new restaurant in the Pipewellgate area.

The Gateshead Millennium Bridge was the first opening bridge to be built across the River Tyne for more than 100 years and has attracted worldwide attention because of its unique design. The world-first design is the latest addition to the Tyne's famous collection of bridges - which have given the area one of the most instantly recognisable skylines in Europe. The £22 million Gateshead Millennium Bridge provides a footpath and cycle-way linking ambitious new arts and cultural developments at Gateshead Quays on the south bank with Newcastle Quayside.

The Baltic Centre for Contemporary Art, shown in Figure 6.16, is the major new centre for international contemporary art, which opened in July 2002. Baltic has a premier site on the south bank of the river Tyne and lies right at the heart of the regeneration area of Gateshead Quays. This £46m project has transformed the former

Baltic Flour Mill, a disused 1950's grain warehouse into one of the biggest temporary art spaces in Europe.



**Fig. 6.16 - The Baltic**

(SOURCE: RESCUE (2004) – *Regions and Case Studies*. Available from:

<http://www.rescue-europe.com/html/regions.html> )

Baltic is a new breed of public art space. With its simplicity and flexibility reflected in the building design, Baltic shows new international art, offering exciting, distinct and unparalleled experiences. More like an 'arts factory' Baltic houses over 3,000 square metre of art space (five galleries), plus artists' studios and cutting edge media facilities allowing artists to work and exhibit across a wide range of media from painting and sculpture to performance, installation and media/digital art. Baltic does not house a permanent collection but invites artists for residencies and places a heavy emphasis on commissions.

The Music Centre Gateshead is at the heart of the public and private sector redevelopment of Gateshead Quays. The building will contribute to the regeneration of Gateshead, providing a new platform for promoting the north of England and acting as a catalyst for further investment into the region.

## Chapter 6 – Case Studies

Music Centre Gateshead occupies one of the most dramatic urban sites in Europe, looking across the Tyne gorge to the vibrant and exciting cityscape on the River Tyne's north bank. It is an outstanding facility for all kinds of live music and for the work of its resident musicians, and a pioneering centre for music education and discovery.

The Centre makes a substantial, sustainable input to Gateshead's and the region's economic growth, bringing a wide range of local jobs in tourism, music, teaching, construction and administration, as well as contributing decisively to raising the region's national and international profile.

Baltic Quay is an impressive £100 million residential and commercial development. The first phase comprises 241 contemporary quayside apartments housed in seven towers situated adjacent to Baltic The Centre for Contemporary Art. The second phase, the commercial aspect of the scheme, is to be built adjacent to Music Centre Gateshead, and will frame Baltic Square with a host of exclusive bars, restaurants, cafes and leisure facilities.

### **6.2 Test Case Study – Newport**

To test the performance of the system a further site has been chosen. The site is located in Newport (Wales).

The area used as the test case is the Old Town Docks in Newport highlighted in red in Figure 6.17. The study area comprises of 16 hectares on the southern edge of Newport town centre and it is located 5 minutes walk from the commercial core of the city centre<sup>5</sup>.



**Fig. 6.17 - The Old Town Dock area**

The land has the potential to create a new gateway into Newport from the Newport Southern Distributor Road and more specifically the Usk River Crossing, to provide a mixture of uses including business, retail, residential and leisure activities with associated public open space.

The development includes land in the ownership of the Development Board (DB) but certain areas are in third party ownership, including Black Clawson<sup>6</sup>.

### **Significance of the site**

In the context of Newport as a whole, the Old Town Dock is strategically important for the following reasons:

1. it is located at a key gateway, adjacent to the new Usk River Crossing, building on the significant potential of the Southern Distributor Road<sup>7</sup>.
2. development will act as an important orientator within the Town and should convey a positive message for the size and potential of this whole area to

## Chapter 6 – Case Studies

create a series of flagship developments between the river frontage and Usk Way.

3. it offers the potential to establish critical linkages between the Town Centre and the Southern Distributor Road
4. it is critical that the study area establishes an image, identity and a platform for new investments in and the marketing of Newport.



**Fig. 6.18 - Aerial view of the area**

(SOURCE: LDA Design (2005) - *Newport Old Town Dock: Development Brief – Supplementary Planning Guidance*)

### **Key issues affecting the area**

The study area displays the following:

- CHARACTERISTICS AND STRENGTHS
  - i. It is a brownfield site
  - ii. Over 50% of the study area is in single ownership

## Chapter 6 – Case Studies

- iii. It has Newport County Borough / National Assembly for Wales support
- iv. It has the flexibility to be developed in phases
- v. Its proximity to the Town Centre, the southern distributor road and the M4 is important
- vi. It is recognised as a priority location by Newport County Borough

### - WEAKNESSES

- i. There are various key ownerships which could affect progress
- ii. It is not the only brownfield opportunity in Newport
- iii. The image of the location is weak and the surrounding area is depressed
- iv. The site might be affected by various degrees of contamination
- v. The site suffers from weak gateways

### - OPPORTUNITIES

- i. Waterfront location with key listed building
- ii. Links to the Town Centre need to be developed and enhanced
- iii. The DB (Development Board) are keen to progress development opportunities along the riverfront corridor

## Chapter 6 – Case Studies

- iv. The DB's economic strategy for Newport views the Usk River frontage as a focus for business
- v. There is an opportunity for linking promotion with the town retail core

### - THREATS

- i. There will be competition from Greenfield and other brownfield sites
- ii. Land releases need to be limited to maintain values
- iii. Confused interpretation of the opportunities for this whole site
- iv. Any delays in bringing forward the site for development could prejudice the programme and progress
- v. Image

### **General Characteristics**

An archaeological assessment of the Old Town Dock<sup>8</sup> was carried out in 2003 and the study reported no medieval or earlier archaeological sites within or the immediate vicinity of the study area. Also, any archaeological sites of 18<sup>th</sup> century or earlier are likely to have been damaged or destroyed by 19<sup>th</sup> and 20<sup>th</sup> century activity. Any surviving archaeological resource is likely to have been buried under 19<sup>th</sup> century overburden associated with the raising of the ground level in the area with spoil from the excavation of the Old Town Dock. The same cannot be said about the margins of the river where the remains of the medieval ocean going ship were discovered in Town Pill to the north.

## Chapter 6 – Case Studies

For this reason the Old Town Dock is itself an object of historical interest. There are two listed buildings in the area: The Old Lock (listed Grade II) and the Maltings (listed Grade II)<sup>9</sup>.

The Maltings was built c. 1898 on the site of the former Penner and Tilley wharves. It is a 3 storeys, plus 3 loft storeys for growing and storing barley. This building is listed as a very good example of a substantial late 19<sup>th</sup> century maltings of a rare type in Wales, retaining much of its original form and character.

The area has also a very poor townscape character at present<sup>10</sup>. The site itself is largely derelict and the major road along its edge, Usk Way, is lined by low-grade industrial uses. It comprises areas of hard standings and derelict land. The site investigations carried out indicate that the varied site history has left a legacy of physical and chemical development constraints<sup>11</sup>.

In addition to hardstandings, below ground structures and foundations are likely to exist. The investigations have also demonstrated that elevated concentrations of heavy metals, sulphates and organics are present, although the extent of gross contamination is limited.

Community engagement represents a focus in the redevelopment of the area<sup>12</sup>. Workshops, exhibitions and public consultations have taken place and four options were established for the redevelopment of the area. All the options have a river side park and all propose the development of the site for a mix of uses including small retail, food and drink offices leisure hotel and community use as well as residential.



## Chapter 6 – Case Studies

### REFERENCES:

1. RESCUE (2004) – Regions and Case Studies. Available from:  
<http://www.rescue-europe.com/html/regions.html>
2. Loisinord Site Information. Available from:  
<http://www.missionbassinminier.org/html/chantiers/urbanisme.php?position=4>
3. Markham Growth Zone. Available from:  
<http://www.derbyshire.gov.uk/business/economic/markham/>
4. Gateshead Quay Development. Available from:  
<http://www.gateshead.gov.uk/Building%20and%20Development/Regeneration/GQII/Home.aspx>
5. LDA Design (2005) - *Newport Old Town Dock: Development Brief – Supplementary Planning Guidance*
6. Newport Urban Regeneration Company (2002) – *Designation Report - Submitted by Shared Intelligence*
7. a) Quadrant Consulting Limited (2001) - *Old Town Dock/ South Pillgwenlly Newport, Supplementary Review of infrastructure – Volume 1/2 201110*  
  
b) Quadrant Consulting Limited (2001) - *Old Town Dock/South Pillgwenlly Newport, Review of Engineering Issues – Volume 2/2 – Appendices 201110*
8. WSP Environmental (2003) - *Archaeological Assessment Report, Old Town Dock Newport*

Chapter 6 – Case Studies

9. Newport City Council (2002/2003) - *Lower Dock Street, Townscape Heritage Initiative – Annual Report*
10. Knight Frank, RPS, David Langdon & Everest (2002) - *Land Use Old Town Dock Newport – Report Draft*
11. Integral Geotechnique (Wales) Limited (2002) - *Site Investigation Factual Report, Proposed Redevelopment Old Town Dock Newport – Report N. 8418/LD/02*
12. MacGregor Smith (2001) – *Design Brief for Proposed Retail Development, Newport Old Dock –Revision A*

# Chapter 7

## Interpretation of Results

### 7.1 Results

The DSS provides two different sets of results depending on the architecture used. For the proactive one the output is represented by a measure of the sustainability and the type of redevelopment to be undertaken on the specific brownfield site. For the reactive one the output is represented by the measure of the sustainability of the type of regeneration scheme introduced by the user.

The DSS allows:

- entering the data by using an easy interface
- choosing between the proactive architecture and the reactive one
- running the simulation/s
- visualizing the results. For example:

<b>Type of redevelopment</b>	INDUSTRIAL
<b>Grade of sustainability</b>	SUSTAINABLE

**Table 7.1 - Results**

The interpretation of the results obtained is assessed at two levels. The first interpretation is related to the case studies used to train the artificial neural network, the second interpretation is related to the test case study and the output obtained by the DSS as potential sustainable type of redevelopment type for the site considered.

### **7.1.1 Interpretation of results from case Studies**

The artificial neural network developed within the DSS has been trained by using existing case studies in four European countries (France, Germany, Poland, and U.K)<sup>1</sup>.

The available information on each site included the results of each indicator and the final use chosen as potential regeneration scheme for the site considered.

This information has been introduced in the DSS to allow the system to learn from the real examples. Once this operation was concluded, the artificial neural network was submitted to an evaluation of the performance through the following procedure:

- the set of information for each case study is re-input in the system without entering the type of redevelopment (expected output)
- the system runs the simulations again
- the result obtained is compared with the initial value of the redevelopment type for each case study.

The information entered and obtained after the training are shown in the tables below.

<b>SITE</b>	<b>Real measure of Sustainability</b>	<b>Measure of sustainability provided as output by the DSS</b>
Radbod	Sustainable	Not Sustainable
Espenhain	Sustainable	Sustainable
Markham	Best Practice	Best Practice
Gateshead Quay	Sustainable	Sustainable
The Dolomites	Best Practice	Best Practice
Sosnowiec	Sustainable	Sustainable
Loisinord	Sustainable	Sustainable
Les Tertiales	Sustainable	Sustainable

**Table 7.2 – Table comparing results for measure of sustainability**

The first interpretation regards the measure of the sustainability of each case study. The first simulation has highlighted a discrepancy in the results obtained for the case study relative to Radbod. In particular the measure of the sustainability resulted “not sustainable” when this is requested as output of the DSS.

An analysis of this discrepancy has been undertaken by reviewing all the input information and the value of each indicator without evidencing any particular reason why the system would produce a different result. The interpretation given to this is more related to the weights assigned to the system at the beginning.

As shown in the table below the discrepancy in the measure of sustainability is also reproduced in a discrepancy with the results obtained for the type of redevelopment. The Radbod brownfield site has been redeveloped into an industrial area. The DSS has evaluated this type of redevelopment as non sustainable for the considered site, and it suggests a mixed redevelopment.

<b>SITE</b>	<b>Current Type of redevelopment</b>	<b>Type of redevelopment provided as output by the DSS</b>
Radbod	Industrial	Mixed
Espenhain	Industrial	Industrial
Markham	Commercial	Commercial
Gateshead Quay	Mixed	Mixed
The Dolomites	Leisure	Leisure
Sosnowiec	Mixed	Mixed
Loisinord	Leisure	Leisure
Les Tertiales	Mixed	Mixed

**Table 7.3 – Comparison of results for type of redevelopment**

Some reviews regarding the indicators, the weighting system, the minimisation of the error have been undertaken to check the reasons why such discrepancy have been shown within the system. Even changing the weighting system, considered to be the main reason of such discrepancy, the results do not change for the Radbod case study.

At this stage the results obtained have been interpreted in two ways:

- the first is that the artificial neural networks has not learnt well enough the interrelationships within input data and output. That means that the system has not been trained enough to produce an appropriate and consistent result. To avoid this the system can be trained with more realistic examples so to allow the network to learn in more detail;
- the second is that the system has learnt properly and it is actually providing a better measure of the sustainability and the type of redevelopment than the ones applied within the considered case study (Radbod) at local level.

## Chapter 7 – Interpretation of results

The discrepancy shown between results is represented only by one case on eight. This means that the system has a performance of around 87% that is acceptable for the scope of this work. The performance of the system increases when the information entered is more detailed, therefore fewer gaps enable the system to run simulations in a more consistent way.

### ***7.1.2 Interpretation of the results from the test case – Newport***

The DSS completed and trained with the case studies has then been tested with a new case study - Newport. The architecture chosen is the proactive one to obtain a measure of the sustainability and also a type of redevelopment suggested.

The DSS performed the simulation without knowing the final type of redevelopment. The result obtained on the basis of the inserted information is represented by the type of redevelopment commercial.

The Planning Guidance provided to the Newport City Council in 2005 suggested a mixed use as type of redevelopment on the basis of a detailed analysis undertaken by different consultants<sup>2</sup>.

The discrepancy between the results of the DSS and the actual type of redevelopment chosen by the Newport City Council does not mean that the system is not performing or providing a consistent result. It is important to consider that this concept is the result of a long and onerous process that the Newport City Council authority has undertaken for few years. This has involved the participation of different stakeholders at various levels. In addition the site is located in a strategic position at political level. Unfortunately, often sustainability is not considered as main goal when approaching a brownfield site with the intention of regenerating the area.

Institutional control aspects, economic constraints can play a key role in the decision made by the stakeholders with regard to a regeneration process. Unfortunately, at this stage this type of information is not considered within the DSS.

The type of redevelopment chosen by Newport City Council (mixed use) has been entered into the DSS under the reactive architecture to obtain a measure of the sustainability. The output highlighted that the proposed redevelopment, is actually sustainable.

## **7.2 Considerations**

It is important to take into consideration that by definition the decision support system helps the user to make the appropriate decision by providing a platform of information on which the user can further assess and evaluate the issues involved in the complex brownfield regeneration problem.

The DSS does not provide an optimal solution to be applied as it is, but it performs simulations to allow the user to understand the different scenarios and compare them. The comparison and analysis of the different potential solutions provide a great support to the actors involved in the process since it gives a real time view of the potential issues related to the different type of regeneration schemes.

The optimal type of redevelopment for a certain brownfield site is also related to common sense and the local knowledge of the key players involved in the process. This knowledge comes from years of experience and common sense that are difficult to quantify and therefore cannot be entered into a tool such as the DSS.



## Chapter 7 – Interpretation of results

Some brownfield site regeneration processes might represent best practice but due to their particular characteristics and local context might not be replicable at other sites.

The main aim of a decision support system is to provide results to be used as a platform for decision makers. The final solution shall be a mix between the one produced by the DSS and the knowledge and experience of the decision maker.

Chapter 7 – Interpretation of results

REFERENCES:

1. Sustainable Assessment Tool (2004). Available from: [http://www.rescue-europe.com/download/reports/2\\_5\\_2\\_Administrative%20tools%20and%20incentives%20-%20SAT.pdf](http://www.rescue-europe.com/download/reports/2_5_2_Administrative%20tools%20and%20incentives%20-%20SAT.pdf)
2. Shared Intelligence (King Sturge, David Lock Associates, Oscar Faber, Newidiam, 2002) – *Five Counties Regeneration Framework: Final Report*  
– Revised Draft

# Chapter 8

## Conclusions

### 8.1 Critique of the work

The BSSR-DSS developed for this project represents a useful tool for decision-makers to assess a brownfield site regeneration scheme and identify the sustainability of the project. The system also allows the decision maker to evaluate potential regeneration schemes for an identified brownfield site and obtain a sustainable type of redevelopment for the area studied.

During the development of the DSS the following tasks have been undertaken:

- *Design of methods for comparing the indicators:* the indicators have been divided in 7 sectors (water, waste, land, contamination, building and infrastructure, energy and public participation) to facilitate the management of the large amount of information and to ensure that data are realistic.
- *Adaptation of the criteria for sustainability, developed by RESCUE, in the developed system:* existing criteria have been analysed and restructured in an appropriate way allowing conversion of the indicators into the required code for the utilised programming language - Mapbasic. No alterations to the meaning, value or unit of measurement of the indicators has been undertaken, therefore the integrity of the system has been retained.

## Chapter 8 – Conclusions

- *Elaboration of a mathematical model that measures the regeneration process:* further to reviewing relevant existing literature, it was determined that the integration of fuzzy logic and artificial neural networks for brownfield regeneration process was an innovative approach.
- *Application, use and development of the code for fuzzy logic and artificial neural networks:* the sustainability of the 7 sectors (water, waste, land, contamination, building and infrastructure, energy and public participation) has been measured through input of the indicators into the fuzzy logic. The output of this represent the input of the artificial neural network. The code for both the mathematical models has been developed using the programming language – Mapbasic.
- *Development of a simulation process based on the developed mathematical model to compare different scenarios for the regeneration projects suitable for that area:* the artificial neural network processes the input data and provides a measure of the sustainability and the suitable redevelopment type for the area studied. Comparisons of different available scenarios have been made by assessing the sustainability of each scenario.

The visualization in the GIS of the results has encountered some problems in terms of data and information available therefore this has not been included in the current thesis.

Some final general considerations are shown below.

## **8.2 Final Considerations**

The Decision Support System for brownfield site sustainable regeneration has been developed to support the key players and decision makers involved in the complex and multidimensional problem of brownfield regeneration.

The legislation in UK has encouraged a sustainable approach in different sectors and in particular within the regeneration of brownfield sites, sustainability represents one of the key aspects to be considered whilst redeveloping a derelict area.

There is a lack of integrated and comprehensive knowledge on the condition, location and management of brownfield sites throughout the UK and little attention has been given to the contribution that brownfield sites make to biodiversity, nature conservation and amenity.

Typically, when developers, stakeholders, and decision makers have an interest in a brownfield site, they must perform an extensive information search to determine its planning and environmental status. In addition to this, UK legislation now enforces the application of sustainability criteria to the regeneration of brownfield sites.

An information search of this type could take days, weeks, or even months to compile. With the DSS developed here, this search could take a matter of minutes, and be displayed in an easy to understand graphical or map form. The sustainability can be easily assessed and then utilise to make appropriate decisions at the different phase of the regeneration process.

The DSS can be used for any type of brownfield site and in the different phases of the regeneration process, independently of the location and the size. The results provided

represent an ideal basis for the decision maker to assess potential alternatives and make the appropriate relevant decisions.

The innovative step taken by developing this DSS is that a large number of variables (land, water, waste etc) involved in the complex problem of brownfield site regeneration have been analysed, evaluated and elaborated in order to produce a result that takes into consideration the various important aspects of sustainability within a regeneration process. Some issues have been identified during the development of the DSS and these are explained in the following paragraph.

### **8.3 Issues**

During the development and testing of the decision support system some issues have been identified.

The issues are related to the data, the test case, the mathematical model and the visualization, the results.

DATA – the artificial neural network has been trained on the basis on eight real case studies. In general this type of networks does not present a rule with regard to the number of cases that need to be utilised to train the network itself. The main concern is that eight case studies might be not enough to represent all the possible combinations in such a complex problem as brownfield regeneration.

To avoid giving inconsistency to the system developed, ideal cases have been created by randomly associating values to the indicators in input to the system. This helped to allow the network to perform more trainings cycles. The results obtained by creating these ideal cases have been analysed and assess against the real case studies.

## Chapter 8 – Conclusions

TEST CASE – the case study used to test the system is Newport (Wales – UK) and at current time not all the information regarding the different sustainability indicators are available. The available information have been collected from Newport County Council and the lack of information in certain sectors is due to the current phase of the project.

To overtake this issue the missing information have been introduced as “gaps” in the list of indicators but these can be updated once further detailed information about the site are released by the relevant bodies.

MATHEMATICAL MODEL – artificial neural networks present the limitation of not being able to consider constraints. In reality the redevelopment of a brownfield site might be subject to constraints related to planning issues, legislation, etc. At this stage it has been assumed that the constraints are actually taken into consideration by the decision maker whilst introducing the parameters for each sustainability indicator or at the end of process as additional information to the output given by the decision support system in order to make the final decision.

VISUALISATION – during the development of the system an attempt to input the electronic maps of each case study to enhance the visualisation part has been undertaken, unfortunately there was no potential to obtain the electronic maps for the eight case studies. Consequently the visualisation of the results is not possible in these cases.

For the test case there is an electronic format. The visualization part is still under construction to assure that the best result is obtained. Due to lack of information the visualization will not be detailed to size and location.

### **8.3 Potential Future Developments**

At this stage the developed DSS has some limitations in the input variables and the information provided as output. The features of this system can be improved in different ways: by enhancing some internal procedures or some features.

The visualization of the variables in input and the way this is requested to the decision maker could be enhanced if internally linked with an existing map in electronic format including specific characteristics of the site. For example: the presence on site of contamination could be highlight in the GIS with different colors or symbols depending on the type of contamination. If detailed maps are available the sustainable regeneration process provided as an output by the system could be graphically represented on the map. For example: exact and convenient location of residential houses within the considered area of study.

In addition the issues (waste, water, participation etc) related to the brownfield regeneration problem could be analyzed in more detail by developing a sub-system to evaluate the sector and provide more output information. This could help the decision maker to assess a particular important issue related to the specific brownfield site.

From the point of view of the mathematical techniques used to develop the system, the artificial neural networks utilized could be enhanced by developing a parallel process for the integration of constraints such as legislation, timescale and so on. The integration of constraints will require the development of functions that stop the artificial neural network when a desired variable reaches a certain value. This enhancement would provide a more realistic output, in terms of sustainability, for the



## Chapter 8 – Conclusions

decision maker since the brownfield site regeneration process is a complex process related to current legislation and set targets.

The DSS developed in this context does not include any economic information in terms of “cost of the regeneration process”. This is a really complex and case specific evaluation that can be integrated into the current system by developing a cost function. The cost function required will have to take into consideration information such as cost of the remediation process, cost of dismantling infrastructure or buildings and so on. Due to the fact that in a local context there might be some issues related to the available budget for the regeneration of a brownfield site, the cost function will have to be integrated with a set of constraints. A procedure to minimize the cost function on the basis of the existing constraints must be developed.

Another potential development of the DSS is the manipulation of the output data and their integration with 3D visualization software. The 3D visualization software would allow the running of simulations and visualizing the regeneration project in each phase. For each phase also the relevant indicators and sectors could be assessed and evaluated to estimate the sustainability of the project. Cost function and specific evaluation of sector could be integrated with 3D software.

The DSS is developed as an integration of mathematical techniques and a geographical information system by using the programming language MAPBASIC. This language is easily integrated with other programming language such as C++. For this reason enhancement and further integration of the DSS with other techniques or software does not represent a difficult task to be undertaken.

# **Appendix A**

## **Sustainability Indicators**

## **SUSTAINABILITY INDICATORS**

### **MANAGEMENT OF CONTAMINATION AND REUSE OF SOIL AND DEBRIS**

**Objective 1: To reduce negative environmental impacts on the site and on the neighbourhood including human health risks**

1.	ID	2.1
2.	Indicator	Number of complaints (and incidents) per year before / after site redevelopment (or opinion poll before and after redevelopment)
3.	Name	Pressure on Neighbourhood
4.	Objective	To describe the impact(s) of the site on the neighbourhood.
5.	Definition	The indicator is the comparison of the amount of public <i>complaints</i> to local authorities before and after site redevelopment (or comparison of opinion polls before and after redevelopment)
6.	Justification	This indicator will allow evaluating the sustainability of the management of the contamination and wastes from a global point of view.
7.	Unit of measurement	Ratio

1.	ID	2.2
2.	Indicator	Number of measures exceeding the legal level on a 24 hour duration measurement
3.	Name	Ambient Noise level
4.	Objective	To evaluate the impact of noise of the new project on the population
5.	Definition	The level of ambient noise will be measured at the closest housing façade.
6.	Justification	This indicator is one of the indicators allowing to evaluate the effective reduction of impacts on the neighbourhood.
7.	Unit of measurement	Number in decibels

1.	ID	2.3
2.	Indicator	Number of days air pollutants and dust exceed healthful levels
3.	Name	Air emission control
4.	Objective	To measure changes in air quality.
5.	Definition	Air emission control consists in the analysis of air quality and dust
6.	Justification	This indicator is one of the environmental indicators allowing to measure progress in the redevelopment.
7.	Unit of measurement	days

1.	ID	2.4
2.	Indicator	Area of land treated / Area of land affected by contamination
3.	Name	Land treated
4.	Objective	To assess the effectiveness of site clean up.
5.	Definition	This is a measure of the amount of land affected by contamination and its proportion to the total area
6.	Justification	This indicator is one of the environmental indicators allowing to measure the progress in the clean up process
7.	Unit of measurement	%

1.	ID	2.5
2.	Indicator	Existence of hydrological drainage and treatment
3.	Name	Surface water
4.	Objective	To assess surface water quality running off from the site.
5.	Definition	The hydrological drainage pattern can be defined as the collection of surface water and its conveyance to a location where it receives treatment (if needed) to permit its discharge to the environment without negative impact
6.	Justification	This indicator is one of the environmental indicators allowing to assess the quality of the water system available on the site
7.	Unit of measurement	Yes/No and check list

1.	ID	2.6
2.	Indicator	Number of chemical parameters above health limits according to quality standards
3.	Name	Groundwater quality control
4.	Objective	To control the quality of the groundwater
5.	Definition	This indicator will take into account the chemical elements and compounds analysed in the water with a comparison with a healthful limit or/and standard
6.	Justification	This indicator provides a measure of the health risk present in the site
7.	Unit of measurement	Number of parameters

1.	ID	2.7
2.	Indicator	Existence and quality of a risk management framework.
3.	Name	Existence and quality of a risk management framework
4.	Objective	Checking that risk is kept within tolerable limits and that decision was taken using this tool.
5.	Definition	This indicator takes into account the tools already developed for assessing the potential risk
6.	Justification	The definition of risk is a key step in the redevelopment process
7.	Unit of measurement	Yes / No and check list

**Objective 2: To minimise waste and maximise recycling and reuse of soil and debris**

1.	ID	2.8
2.	Indicator	Amount of wastes treated / Total amount of wastes
3.	Name	Waste generation
4.	Objective	To provide a measure of the extent of hazardous and non hazardous wastes which could have a direct impact on health and the environment
5.	Definition	The total amount of hazardous and non hazardous wastes generated and treated per year
6.	Justification	This indicator provides a measure of the effectiveness of the waste strategy
7.	Unit of measurement	%

1.	ID	2.9
2.	Indicator	Volumes of solid waste, soil and debris recycled per time unit / Volumes of solid waste, soil and debris produced per time unit
3.	Name	Proportion of solid waste, soil and debris recycling and reuse on site and off site
4.	Objective	To measure the proportion of solid waste, soil and debris which is reused or recycled
5.	Definition	Volume of solid waste, soil and debris which is reused or recycled based on the volume actually generated at the source
6.	Justification	This indicator provides a measure of the effectiveness of the recycling strategy
7.	Unit of measurement	%

**Objective 3: To ensure cost effectiveness and technical feasibility**

1.	ID	2.10
2.	Indicator	Land value/ cost of remediation
3.	Name	Land value
4.	Objective	To give an indication of the value of the site.
5.	Definition	This indicator relates to the new value of site and its cost effectiveness .
6.	Justification	This indicator provides a measure of the need to remediate the area
7.	Unit of measurement	%

1.	ID	2.11
2.	Indicator	Existence of a “Post-Remediation validation reporting”
3.	Name	Remediation Post validation
4.	Objective	To evaluates if contaminated site has been successfully remediated (for its intended or current use) and that the objectives of the site management plan have been achieved
5.	Definition	The post validation study is capital in the evaluation of the technical feasibility and effectiveness
6.	Justification	This indicator represents the success or failure in the regeneration process
7.	Unit of measurement	Yes/no and Check list

**Objective 4: To improve social acceptance through identification of all stakeholders and risk communication**

1.	ID	2.12
2.	Indicator	Existence of a documented strategy
3.	Name	Existence of a public approach strategy including education
4.	Objective	To verify that the public is informed about the process that is taking place
5.	Definition	The involvement of the public during the regeneration process by means of educational approach
6.	Justification	During the field works it is important to explain the meaning of the activity and to educate about risks
7.	Unit of measurement	Yes/no check list

**Objective 5: To provide decision support tools for risk based land management**

1.	ID	2.13
2.	Indicator	Existence of decision support tools
3.	Name	Existence of decision support tools
4.	Objective	To check if the techniques of for example risk assessment, GIS, etc. have been applied. To evaluate the validity of this use.
5.	Definition	Presence of a set of tools to be used in the process in order to facilitate and enrich it.
6.	Justification	To understand and evaluate the decision making process.
7.	Unit of measurement	Yes/no, and check list , cf. CABERNET



**Objective 6: To reduce natural mineral resource consumption**

1.	ID	2.14
2.	Indicator	Volume of previously unused natural minerals consumed by the project expressed as a proportion of total volumetric project mineral resource demand.
3.	Name	Conservation of natural mineral resources
4.	Objective	To describe the relative impact of the project on reserves of non-renewable natural mineral resources.
5.	Definition	The indicator links mineral resource use with mineral resource consumption
6.	Justification	This indicator will allow the evaluation of the sustainability of mineral resource use from a local, regional, national and European perspective
7.	Unit of measurement	ratio

## **MANAGEMENT OF EXISTING BUILDINGS AND INFRASTRUCTURE**

**Objective 1: To minimise energy demand and produce renewable energy on the site**

1.	ID	3.1
2.	Indicator	kWh/m <sup>3</sup> /a
3.	Name	Specific Energy Demand
4.	Objective	To minimise energy demand and to replace non-renewable energy sources by renewable ones on the retrofitted buildings or on the site
5.	Definition	<p>This parameter indicates the usage of natural resources, as well as indirect impact on environment.</p> <p>Energy demand is related to:</p> <ul style="list-style-type: none"><li>- type of building usage</li><li>- type of construction of the building, namely basic parts of the building</li><li>- roof</li><li>- outside walls</li><li>- windows</li><li>- doors</li></ul> <p>etc.</p> <ul style="list-style-type: none"><li>- total volume of the building</li><li>- basic data of the building ventilation</li></ul> <p>type of lighting of the building</p>
6.	Justification	The energy demand by the existing building is the one of the most important indicators for the influence on air and land surface contamination during the period of building exploitation resulting from energy demand.
7.	Unit	

1.	ID	3.2
2.	Indicator	Renewable Energy Ratio $\frac{kW_{ren}}{kW_{total}}$
3.	Name	Percentage of Renewable Energy produced on the site
4.	Objective	To minimise energy demand and to replace non-renewable energy sources by renewable ones for reused buildings
5.	Definition	Substitution of the non-renewable energy resources by renewable ones is an indicator, which indicates the pressure on the air and natural resources resulting from building exploitation.
6.	Justification	Reducing demand for non-renewable sources of energy improve sustainability of the energy resources.
7.	Unit	- Ratio (energy unit to energy unit)

**Objective 2: To minimise water demand and reduce waste water production**

1.	ID	3.3
2.	Indicator	Fresh drinking water consumption
3.	Name	Consumption of drinking water that comes from outside
4.	Objective	To minimise water demand
5.	Definition	Basic measures for the indicator: <ul style="list-style-type: none"> <li>- Type of building usage</li> <li>- Amount of rain water that can be collected from</li> <li>- the roof area</li> <li>- the area of parking lots and roads belonging to the site</li> </ul>
6.	Justification	To save drinking water is very important in many regions of Europe. This parameter indicates desirable waste water management practice.
7.	Unit	- m <sup>3</sup>

1.	ID	3.4
2.	Indicator	Waste-water management
3.	Name	Unpurified waste water runoff
4.	Objective	Amount of waste water that leaves the site without proper purification
5.	Definition	<p>Waste water generated on site.</p> <p>Basic measures for the indicator:</p> <ul style="list-style-type: none"> <li>- Type of building usage</li> <li>- Sewage</li> <li>- the quantity of persons using the building</li> <li>- industrial liquid wastes</li> <li>- quantity of the water used for the production</li> </ul>
6.	Justification	<p>Sewage production and industrial liquid waste production by existing building is the one of the most important indicator for the influence on the water and land surface contamination.</p> <p>This parameter also gives an idea about the waste water usage.</p>
7.	Unit	- m <sup>3</sup>

**Objective 3: To minimise waste generation from buildings and civil infrastructure (optimising recycling and reuse)**

1.	ID	3.5
2.	Indicator	Waste management
3.	Name	Ratio of waste leaving the site
4.	Objective	To minimise waste generation from buildings and civil infrastructure (optimising recycling and reuse)
5.	Definition	<p>Ratio of waste to the total waste stream generated from both processes:</p> <ul style="list-style-type: none"> <li>- the total or partial demolition of existing<sup>1</sup> buildings and civil infrastructure and from the total or partial construction of buildings and civil infrastructure.</li> </ul> <p>Basic measures for the indicator:</p> <ul style="list-style-type: none"> <li>- Condition and type of building, its future usage.</li> <li>- Applied technology for demolition and/or building improvement.</li> </ul>
6.	Justification	<p>"Waste" is all of this material which is not re-used on the site and which has to be treated or carried to a waste deposit elsewhere.</p> <p>Waste arising from buildings and infrastructure s the one of the most important indicator for its influence on the water and the land surface contamination.</p>
7.	Unit	Ratio expressed as Weight-%

1.	ID	3.6
2.	Indicator	Waste management
3.	Name	Ratio of waste recycling and reuse
4.	Objective	To minimise mineral resources use mineral resources use
5.	Definition /	To describe the relative impact of the project on reserves of non-renewable natural mineral resources  Basic measures for the indicator is type technique applied for site an building remodelling
6.	Justification	Waste generated on site or by other site development might be acceptable as substitute of construction materials or other application while complying by standards. It results in saving of global resources. It might be recognised as redundant to next indicator (conservation of natural resources) but refers to wider context because also count the reuse of waste outside of the site.
7.	Unit	- Weight-%

**Objective 4: To reduce natural mineral resource consumption**

1.	ID	3.7
2.	Indicator	Volume of previously unused natural minerals consumed by the project expressed as a proportion of total volumetric project mineral resource demand.
3.	Name	Conservation of natural mineral resources
4.	Objective	To describe the relative impact of the project on reserves of non-renewable natural mineral resources.
5.	Definition	The indicator links mineral resource use with mineral resource consumption
6.	Justification	This indicator will allow the evaluation of the sustainability of mineral resource use from a local, regional, national and European perspective
7.	Unit of measurement	ratio

**Objective 5: To convert deteriorated surfaces to natural soil**

1.	ID	3.8
2.	Indicator	Surface management
3.	Name	Regeneration of natural surface
4.	Objective	To improve deteriorated surfaces by breaking up sealed surfaces and restore a natural soil and vegetation as far as possible.
5.	Definition	Surface improved to total surface of the site  Basic measures for the indicator: <ul style="list-style-type: none"><li>- Type and area size of surface covers on the site</li><li>- Quality and area size of (natural) soil below (if known)</li><li>- Possibilities and area size of surfaces to be improved</li></ul>
6.	Justification	To restore natural soil and space is a rising political issue in many countries. It is strongly encouraged to substitute sealed surfaces by permeable ones and to allow natural vegetation within used areas as much as possible.
7.	Unit	- Ratio - Area-%

**Objective 6: To decide for proceedings based on defining the cultural and regional identity by the quality of its industrial heritage**

1.	ID	3.9
2.	Indicator	Percentage of solid buildings "qualified as historical monuments" reused compared to all buildings on the regenerated site
3.	Name	Conservation of industrial monuments
4.	Objective	To define cultural and regional identity by the quality of industrial heritage
5.	Definition/	The "technical/ industrial culture" is a part of historical heritage. The measure: National/ regional historical monuments catalogue-conservation indications.
6.	Justification	Specific architectural forms of industrial building (like a coal mine shafts), defines the local/regional identity and become the typical landscape The space and forms of industrial buildings allows to allocate new economic activities and functions within " historical framework".
7.	Unit	Ratio %

**Objective 7: To create social acceptance for the conservation of cultural heritage**

1.	ID	3.10
2.	Indicator	Public participation and acceptance
3.	Name	Stakeholders participation in the process of former industrial buildings management
4.	Objective	To create social acceptance for the conservation of cultural heritage
5.	Definition/	Number of the stakeholders multiplied buy number of stakeholder groups participating in the redevelopment process multiplied by the number of consultations.  Social acceptance could be measure by the stakeholders involvement- how many groups take a part in the process, how regular is that contribution, how substantive is stakeholder' s contribution.
6.	Justification	Economic features of redevelopment process create social acceptance for reusing and conservation of post-industrial buildings.
7.	Unit	Number



**Objective 8: To improve the image of the site and its neighbourhood**

1.	ID	3.11
2.	Indicator	Improvement of site attractiveness
3.	Name	Image change of the site and neighbourhood
4.	Objective	To improve the image of the site and its neighbourhood in order to attract investors, tourists, skilled employees etc.
5.	Definition	There are number of aspects of image of site witch are important for attraction of site developers – environmental, social and economical.
6.	Justification	Improvement of site image in environmental, social and economical dimensions contributes to regional development
7.	Unit	% of positive statements (taken from WP 5 data opinion polls, newspaper articles, public participation)

**Objective 9: To make economically viable the reuse or dismantling of buildings and infrastructure respecting regional public demands**

1.	ID	3.12
2.	Indicator	Social effectiveness of development
3.	Name	Cost of reuse or dismantling
4.	Objective	To make economically viably the reuse or dismantling of buildings and infrastructure
5.	Definition	Cost – benefit ratio determines rate of return of investment to authorities; investors; promoters/developers and gives the base for making decision.
6.	Justification	Social benefits might overcome reluctance to invest while only financial aspects are considered.
7.	Unit	Ratio, Cost( in EURO) /Benefit( in EURO)

**Objective 10: To find better ways to comply with health and safety regulation for reused buildings and infrastructure**

1.	ID	3.13
2.	Indicator	Effectiveness of health and safety regulation complying
3.	Name	Comply with health and safety regulation for reused buildings and infrastructure
4.	Objective	To find better ways to comply with health and safety regulation for reused buildings and infrastructure
5.	Definition	Cost – benefit ratio of different option determines acceptance for decision.
6.	Justification	Complying with health and safety regulation is prerequisite for site development. Effectiveness of such process is crucial point for decision making.
7.	Unit	Ratio, Cost( in EURO) /Benefit( in EURO)

## **SUSTAINABLE LAND USE AND URBAN DESIGN ON BROWNFIELD SITES**

**Objective 1: To promote land use functions that match regional socio-economic demands and needs**

1.	ID	4.1
2.	Indicator	Has the intended land use been integrated into the objectives of the regional development strategy?
3.	Name	Integration of the intended land use into the objectives of the regional development strategy
4.	Objective	To promote land use functions that match regional socio-economic demands and needs
5.	Definition	The indicator intends to show if the planned land use fits into the regional development
6.	Justification	The strategy can guarantee a concerted resource saving regional development and avoid not used or under used land uses.  A standard for regional development strategies will be included in the best-practice guide as a checklist.
7.	Unit	Yes / No-indicator

1.	ID	4.2
2.	Indicator	Has an analysis of the demand (e.g. market analysis, feasibility study, etc.) been carried out to justify a sufficient socio-economic / commercial demand and have the results been taken into account in drawing up the land use concept?
3.	Name	The fact if an analysis of the demand has carried out
4.	Objective	To promote land use functions that match regional socio-economic demands and needs
5.	Definition	The indicator intends to show if the future land use meets the demands and needs
6.	Justification	A not used or under used development can be avoided if there is sufficient demand for the intended land use. Analysing the demand is an important precondition for a good management of the project.
7.	Unit	Yes / No-indicator

**Objective 2: To integrate the reuse of brownfield sites into a regional land management**

1.	ID	4.3
2.	Indicator	Percentage of the development sites taken from the regional land management pool of the entirety of development sites in the region.
3.	Name	Portion of the development sites in the regional land management pool, compared to the entirety of development sites in the region
4.	Objective	To integrate the reuse of brownfield sites into a regional land management
5.	Definition	The indicator intends to show how many development sites in the region are part of a regional land management pool
6.	Justification	<p>In order to realize a coherent, balanced and resource saving regional development, the regional land management pool should content as many sites in the region as possible.</p> <p>A standard for regional land management will be included in the best-practice guide as a checklist.</p>
7.	Unit	%

**Objective 3: To integrate the reuse of brownfield sites into the urban development**

1.	ID	4.4
2.	Indicator	Does the site development accord to the integrated urban development strategy?
3.	Name	Accordance of the site development to the integrated urban development strategy
4.	Objective	To integrate the reuse of brownfield sites into the urban development
5.	Definition	The indicator intends to show if the future land use accords to the integrated development strategy on the local level.
6.	Justification	The intended land use should not only fit into the regional but particularly into the urban development in order to reach balanced and stable urban structures
7.	Unit	Yes / No-indicator

**Objective 4: To make projects tolerable for the local neighbourhood**

1.	ID	4.5
2.	Indicator	Number of initiatives for or against the project; Number of critical suggestions within the formal planning process
3.	Name	Acceptance of the project: Initiatives for or against the project / Critical suggestions within the formal planning process
4.	Objective	To make projects tolerable for the local neighbourhood
5.	Definition	The indicator intends to show the acceptance of the project on the neighbourhood level
6.	Justification	The intended land use must fit into the spatial, social, economic and ecological conditions of the neighbourhood in order to develop a good coexistence. Therefore the acceptance of the population should be as high as possible.
7.	Unit	Absolute number

**Objective 5: To generate and safeguard employment and economic development**

1.	ID	4.6
2.	Indicator	Total number of long-term jobs created on the site Total number of long-term jobs per ha
3.	Name	Number of created long-term jobs resp. job intensity on the site
4.	Objective	To generate and safeguard employment and economic development
5.	Definition	The indicator intends to show the amount of created long-term jobs on the site by establishing new companies
6.	Justification	As the closedown of the industry on the brownfield site was mostly connected with an immense job loss for the region, the future land use should create as many new and long-term jobs as possible.
7.	Unit	Absolute number and absolute number per ha

1.	ID	4.7
2.	Indicator	Ratio of jobs that require training of the entirety of all created jobs resp. ratio of unqualified jobs of the entirety of all created jobs
3.	Name	Job structure on the site
4.	Objective	To generate and safeguard employment and economic development
5.	Definition	The indicator intends to show the amount of created jobs on the site for which an training is necessary
6.	Justification	The intended land use should create as many as qualified jobs as possible. Jobs that require training are regarded as potentially longer-term and thus more sustainable than unqualified and unskilled jobs.
7.	Unit	%

1.	ID	4.8
2.	Indicator	Economic multiplier effects of the site development on regional scale
3.	Name	Economic multiplier effects of the site development on regional scale relating to the intended land use function (multiplier effects in the region)
4.	Objective	To generate and safeguard employment and economic development
5.	Definition	The indicator intends to show the positive economic effect of the site-development on a regional scale.
6.	Justification	Not only the users of the site itself but also the region should economically benefit from the site development, e.g. by follow-up investments
7.	Unit	€

1.	ID	4.9
2.	Indicator	Does the site development accords to the regional economic strategy?
3.	Name	Accordance of the site development to the regional economic strategy
4.	Objective	To generate and safeguard employment and economic development
5.	Definition	The indicator intends to show if the land use will fit into the regional economical development
6.	Justification	The intended land use should meet the objectives of the regional economic strategy in order to realize a balanced regional development, orientated on the economical and social needs. A standard for regional economic strategies (can be part of a regional development strategy) will be included in the best-practice guide as a checklist.
7.	Unit	Yes / No-Indicator

**Objective 6: To promote land use functions that suit the natural and man-made environment of the site**

1.	ID	4.10
2.	Indicator	Has an integrated potential- and restriction-analysis (like a site diagnosis dealing with natural and landscape features, e.g. topography, protected species, vegetation according to type, quantity and quality, (ground-) water, contamination and soil conditions) of the site been carried out?
3.	Name	The fact if an integrated potential- and restriction-analysis of the site has been carried out.
4.	Objective	To promote land use functions that suit the natural and man-made environment of the site
5.	Definition	The indicator intends to show if the land use will consider the local natural and man-made conditions on the site and the surroundings
6.	Justification	The intended land use should consider the existing conditions of the site and the surroundings in order to avoid a development in the opposite direction
7.	Unit	Yes / No-Indicator

1.	ID	4.11
2.	Indicator	Have the results of the integrated potential- and restriction-analysis been taken into account in drawing up the planned use?
3.	Name	The fact if the results of the integrated potential- and restriction-analysis were taken into account in drawing up the planned use.
4.	Objective	To promote land use functions that suit the natural and man-made environment of the site
5.	Definition	The indicator intends to show if the land use will consider the local natural and man-made conditions on the site and the surroundings
6.	Justification	The intended land use should consider the existing conditions of the site and the surroundings in order to avoid a development in the opposite direction
7.	Unit	Yes / No-Indicator

**Objective 7: To save resources**

1.	ID	4.12
2.	Indicator	Ratio surface sealing
3.	Name	Ratio of the surface being sealed compared to the whole site
4.	Objective	To save resources
5.	Definition	The indicator intends to show how much of the site surface will be sealed for the planned land use
6.	Justification	The planned land use and urban concept should follow the sustainability objective of saving space and protecting the climate. It is necessary to develop a balanced concept in order to achieve the optimal results for both environment media.
7.	Unit	%



1.	ID	4.13
2.	Indicator	Expected water consumption on the site
3.	Name	Expected water consumption on the site
4.	Objective	To save resources
5.	Definition	The indicator intends to show the expected amount of the water consumption on the site.
6.	Justification	The planned land use and urban concept should follow the sustainability objective of saving the exhaustible resource water. The less the water will be consumed the more sustainable will be the future land use.
7.	Unit	Litre / m <sup>3</sup> per day (depending on the land use)

1.	ID	4.14
2.	Indicator	Expected energy consumption on the site (per site user)
3.	Name	Expected energy consumption on the site (per site user)
4.	Objective	To save resources
5.	Definition	The indicator intends to show the expected amount of the energy consumption on the site.
6.	Justification	The planned land use and urban concept should follow the sustainability objective of saving the resource energy. The less the energy will be consumed the more sustainable will be the future land use.
7.	Unit	kWh per site user (depending on the land use, e.g. inhabitant, employee, visitor)

1.	ID	4.15
2.	Indicator	Expected ratio of renewable energy sources to the total energy consumption on the site
3.	Name	Expected ratio of renewable energy sources to the total energy consumption on the site
4.	Objective	To save resources
5.	Definition	The indicator intends to show the expected ratio of those energy resources that are renewable, compared to the total energy consumption on the site.
6.	Justification	The planned land use and urban concept should follow the sustainability objective of saving the resource energy. The higher the ratio of the consumption of renewable energy resources will be, in comparison to the total energy consumption, the more sustainable will be the future land use.
7.	Unit	% of renewable energy resources in kWh to total energy consumption on kWh

1.	ID	4.16
2.	Indicator	Expected ratio of recycled waste to total waste generation on the site
3.	Name	Expected ratio of recycled waste to total waste generation on the site
4.	Objective	To save resources
5.	Definition	The indicator intends to show the expected part of the waste that can be recycled, compared to the total waste generation on the site.
6.	Justification	The planned land use and urban concept should follow the sustainability objective of avoiding waste and of saving material flows. The higher the ratio of the recycled waste will be, in comparison to the total waste generation, the more sustainable will be the future land use.
7.	Unit	% of the recycled waste in t to the total waste generation in t

**Objective 8: To connect different city districts**

1.	ID	4.17
2.	Indicator	Have connections across the brownfield site, according to the demand, been created in the urban design concept?
3.	Name	The fact if the urban design concept has included connections across the brownfield site, according to the demand.
4.	Objective	To connect different city districts
5.	Definition	The indicator intends to show if the urban design concept has included connections across the brownfield site.
6.	Justification	This indicator assumes that connections (like foot- or bicycle paths, streets, etc.) can improve the relation between formerly separated city districts
7.	Unit	Yes / No-Indicator

**Objective 9: To provide access for all means of transport**

1.	ID	4.18
2.	Indicator	Ratio of users of the site who will be connected to public transport within the catchment area of a public transport stop that is standard practice in the analysed region
3.	Name	Ratio of site users within the in the analysed region typically used catchment area of a public transport stop
4.	Objective	To provide access for all means of transport
5.	Definition	The indicator intends to show the amount of site users connected to the public transport. Users of the site that should be defined site specifically, can be e.g. inhabitants living, employees working, customers shopping or visitors amusing themselves on the site.
6.	Justification	The more users will be connected to the public transport the more the site is accessible for many population groups by an environment-friendly means of transport and the more sustainable will be the planned land use.
7.	Unit	%

1.	ID	4.19
2.	Indicator	Has an integrated traffic concept for the site development been adopted?
3.	Name	The fact if an integrated traffic concept for the site development has been adopted.
4.	Objective	To provide access for all means of transport
5.	Definition	The indicator intends to show if there has been an integrated traffic concept for the site development has been carried out and if its results were included into the urban design concept. This integrated traffic concept should make the site accessible for all means of transport in a well-balanced manner.
6.	Justification	The accessibility of the site should be made possible for all population groups in an adequate measure. In this regard, the integrated traffic concept is a possibility to co-ordinate all demands of the different means of transport in a sustainable manner.
7.	Unit	Yes / No-Indicator

**Objective 10: To achieve high design quality**

1.	ID	4.20
2.	Indicator	Has an open competition procedure taken place to develop the urban design concept, calling in different expert opinions?
3.	Name	The fact if an open competition procedure has taken place to develop the urban design concept.
4.	Objective	To achieve high design quality
5.	Definition	The indicator intends to show if there has been taken place an open competition procedure to develop the urban design concept in order to call in as many different expert opinions as possible. The competition should take place in an early project phase. Experts can be architects, planners, designers, technical engineers, social, economic and environmental consultants, etc.
6.	Justification	An open competition to elaborate the urban design concept by as many different experts as possible can enhance and improve the quality and the longevity of the concept and its content.
7.	Unit	Yes / No-Indicator

1.	ID	4.21
2.	Indicator	Has this urban design concept, elaborated by an open competition procedure, been adopted for the site development?
3.	Name	The fact if the urban design concept, elaborated by an open competition procedure, has been adopted for the site development.
4.	Objective	To achieve high design quality
5.	Definition	The indicator intends to show if the results of the open competition (see above) are effectively considered in the planned urban design concept.
6.	Justification	An open competition to elaborate the urban design concept by as many different experts as possible can enhance and improve the quality and the longevity of the concept and its content.
7.	Unit	Yes / No-Indicator

**Objective 11: To create and maintain flexibility, flexible construction forms / design**

1.	ID	4.22
2.	Indicator	Does the urban design concept allow secondary or even third uses of buildings and building plots?
3.	Name	The fact if the urban design concept allows secondary or even third uses of buildings and building plots.
4.	Objective	To create and maintain flexibility, flexible construction forms / design
5.	Definition	The indicator intends to show if urban design concept makes possible not only the directly planned use of buildings and plots but also second or more subsequent uses that are not known yet. This can be realized by using e.g. flexible forms of design and construction for buildings.
6.	Justification	The possibility to use buildings or plots several times is more sustainable as high planning and rebuilding expenses can be avoided resp. exhaustible natural resources can be saved.
7.	Unit	Yes / No-Indicator

1.	ID	4.23
2.	Indicator	Is a step by step-realization of the project possible?
3.	Name	The fact if a step by step-realization of the project is possible.
4.	Objective	To create and maintain flexibility, flexible construction forms / design
5.	Definition	The indicator intends to show if the realization of the land use and urban design concept can be made in several phases, according to the demand.
6.	Justification	If the concept can be realized in a step-by-step procedure, according to the demand, investment ruins can be avoided and the economic efficiency of the whole project can be improved.
7.	Unit	Yes / No-Indicator

**SUSTAINABLE PLANNING PROCESSES AND METHODS FOR CITIZEN PARTICIPATION**

1.	ID	5.1	
2.	Indicator	Equal access to information	
3.	Name	Equal access to information	
4.	Objective	<p>1. To obtain a better quality of the information</p> <p>2. To obtain a better quality of the information flow</p> <p>3. To have a more efficient use of information</p>	<p>7. To empower citizens, especially those representing non-organised interests</p>
5.	Definition Justification	/ An equal access to information is a key-condition for empowering citizens and improving democratic practices. All Citizens should have access to relevant, available and understandable information to become actors in every step of the process management.	
6.	Unit	<p>- time necessary for obtaining information (real time ?)</p> <p>- regularity and continuity of information given to citizens (number of newsletters per year)</p>	
7.	Data Base / Source	<p>- available documents used for public meetings: diagnosis, progress reports, communication tools: newsletter etc.</p> <p>- National/Regional/local press</p> <p>- existence of a website</p>	

1.	ID	5.2	
2.	Indicator	Symmetry of information flow	
3.	Name	Symmetry of information flow	
4.	Objective	<p>1. To obtain a better quality of the information</p> <p>2. To obtain a better quality of the information flow</p> <p>3. To have a more efficient use of information</p>	7. To empower citizens, especially those representing non-organised interests
5.	Definition / Justification	The symmetry of the information flow among all involved stakeholders is necessary to the global legitimacy of the process : a choice is socially acceptable if it is explained, well-argued, and understood, and if stakeholders who will be impacted on have the power to question and improve it. Stakeholders should be on equal terms.	
6.	Unit	<ul style="list-style-type: none"> <li>- time necessary for obtaining information (real time ?)</li> <li>- free access to sources of information</li> <li>- regularity and continuity of information given to citizens (number of newsletters per year ...)</li> <li>- interactivity stakeholders/decision-makers</li> </ul>	- access to internet/e-mail : forums
7.	Data Base / Source	<ul style="list-style-type: none"> <li>- available documents used for public meetings : diagnosis, progress reports, communication tools : newsletter etc.</li> <li>- National/Regional/local press</li> <li>- existence of a website</li> </ul>	



1.	ID	5.3	
2.	Indicator	Good preparation and organization of the whole process	
3.	Name	Good preparation and organization of the whole process	
4.	Objective	5. To increase the legitimacy of the decision-making process	6. To improve the efficiency of the process in terms of duration and costs
5.	Definition Justification	/ The process has to be well-managed from the beginning to the end : indeed, the person(s) in charge of the management should set clear rules and respect them, especially in the case of public meetings : respect of schedules, clear and understandable diagnosis, regulation of positions and opinions. All these conditions are necessary to avoid frustrations and stimulate a collective acceptance of mediation and search for solutions.	
6.	Unit	<ul style="list-style-type: none"> <li>- time schedule (respect of the general schedule and deadlines)</li> <li>- feasibility (formulation of achievable targets : duration, milestones)</li> <li>- regularity and continuity (communication of advantages for the different stakeholders)</li> </ul>	
7.	Data Base / Source	<ul style="list-style-type: none"> <li>- Analysis of documentation used for public debates (diagnosis, progress reports etc)</li> <li>- Authorities' information and communication Program</li> </ul>	

1.	ID	5.4	
2.	Indicator	Number and profile of persons accountable for process and results	
3.	Name	Number and profile of persons accountable for process and results	
4.	Objective	6. To improve the efficiency of the process in terms of duration and costs	8. To delegate responsibility to lower decision level and to stimulate a sense of ownership
5.	Definition / Justification		
6.	Unit		- number of persons involved actively on lowest level and in the different steps of process management (planning, decision-making, executing, controlling, monitoring and evaluating)
7.	Data Base / Source	- mailing list (for invitation): wide or limited  - attendance sheets (public meetings)	

1.	ID	5.5		
2.	Indicator	Transparency about the selection and circulation of information and about process management		
3.	Name	Transparency about the selection and circulation of information and about process management		
4.	Objective	<p>1. To obtain a better quality of the information</p> <p>2. To obtain a better quality of the information flow</p> <p>3. To have a more efficient use of information</p>	<p>5. To increase the legitimacy of the decision-making process</p>	<p>7. To empower citizens, especially those representing non-organised interests</p>
5.	Definition Justification	/ Transparency about information and the process management is a key-condition for the global legitimacy of the process. The person(s) in charge of managing the process should inform stakeholders about the different sources of information (subjective/objective/contradictory expertise) used for decision-making ; they should present the rules of process management clearly (schedules, costs etc) and discuss them with stakeholders. Stakeholders should be informed regularly and continuously and have the possibility to react and express themselves.		
6.	Unit	<p>- time necessary for obtaining information (real time ?)</p> <p>- alternative expertise</p>		
7.	Data Base / Source			

1.	ID	5.6		
2.	Indicator	Representativeness of the range of participants/citizens		
3.	Name	Representativeness of the range of participants/citizens		
4.	Objective	4. To have a fairer discussion process and a better resolution of conflicts	5. To increase the legitimacy of the decision-making process	7. To empower citizens, especially those representing non-organised interests
5.	Definition / Justification			
6.	Unit	<ul style="list-style-type: none"> <li>- quantitative analysis (number, categories)</li> <li>- qualitative analysis (profile, social and professional background : long-term jobs ?, age, educational level etc)</li> </ul>		<ul style="list-style-type: none"> <li>- existence of means and use of techniques to detect and involve non-organized people</li> </ul>
7.	Data Base / Source	<ul style="list-style-type: none"> <li>- mailing list (for invitation) : wide or limited</li> <li>- attendance sheets (public meetings)</li> </ul>		

1.	ID	5.7		
2.	Indicator	Publicity and documentation of debates and (intermediate) results		
3.	Name	Publicity and documentation of debates and (intermediate) results		
4.	Objective	4. To have a fairer discussion process and a better resolution of conflicts	5. To increase the legitimacy of the decision-making process	6. To improve the efficiency of the process in terms of duration and costs
5.	Definition Justification	/ Citizens should have an equal and symmetric access to information since the beginning of the process to the end. They will find the process legitimate if they have a regular, continuous and interactive information on the intermediate and final results of the process. This indicator which is strongly linked to the transparency of the process management is a key-condition for a progressive and collective acceptance of solutions.		
6.	Unit	- time necessary for obtaining information (real time ?)		
7.	Data Base / Source	- available documents used for public meetings : diagnosis, progress reports (downloaded on internet ?), communication tools : newsletter etc.  - National/Regional/local press		

1.	ID	5.8		
2.	Indicator	Satisfaction / contestation of results		
3.	Name	Satisfaction / contestation of results		
4.	Objective	5. To increase the legitimacy of the decision-making process	6. To improve the efficiency of the process in terms of duration and costs.	8. To delegate responsibility to lower decision level and to stimulate a sense of ownership
5.	Definition / Justification	explanation of indicator and expected results, sustainability context of the indicator		
6.	Unit	<ul style="list-style-type: none"> <li>- number of cases brought to court (complaints)</li> <li>- continuity of the process after an election period ;</li> <li>- use of techniques to measure the degree of involvement and satisfaction of stakeholders (polls, enquiries etc.)</li> </ul>		<ul style="list-style-type: none"> <li>- use of techniques to measure and satisfaction of stakeholders (polls, enquiries etc.) with results and process</li> </ul>
7.	Data Base / Source	<ul style="list-style-type: none"> <li>- National/Regional/local press articles</li> <li>- Analysis of polls results (if used)</li> </ul>		

1.	ID	5.9			
2.	Indicator	Resources (time and money) allocated by authorities			
3.	Name	Resources (time and money) allocated by authorities			
4.	Objective	1. To obtain a better quality of information	4. To have a fairer discussion process and a better resolution of conflicts	7. To empower citizens, especially those representing non-organised interests	8. To delegate responsibility to lower decision level and to stimulate a sense of ownership
5.	Definition / Justification	Participation needs time and money to be effective. Empowering citizens means gathering a certain number of conditions : information, education, communication, mediation etc., which need to pervade each step of the process.			
6.	Unit	- alternative expertise (sometimes contradictory)		- time and resources necessary to found initiatives, pressure groups, NGOs//alternative expertise, animation of debates, mediation, communication  - existence of means to detect and involve non-organized people	- resources allocated by authorities to lowest level
7.	Data Base / Source	Authorities'budget			

1.	ID	5.10
2.	Indicator	Early Involvement of stakeholders and power of influence in the different steps of the process management
3.	Name	Early Involvement of stakeholders and power of influence in the different steps of the process management
4.	Objective	4. To have a fairer discussion process and a better resolution of conflicts
5.	Definition / Justification	The legitimacy of the whole process cannot stem from the final step of a process but should pervade each step of it. Involving citizens since the beginning of the process and at every step of it is necessary to create a collective sense of ownership and responsibility and reinforce active democratic practices.
6.	Unit	<ul style="list-style-type: none"> <li>- before the process is launched, nature of the mailing lists, elaboration of an information and communication program ; time schedules (milestones, duration)</li> <li>- during the process, regularity of information (number of press articles)</li> </ul>
7.	Data Base / Source	National/Regional/Local press



1.	ID	5.11
2.	Indicator	Collective willingness to participate and to search for solutions
3.	Name	Collective willingness to participate and to search for solutions
4.	Objective	4. To have a fairer discussion process and a better resolution of conflicts
5.	Definition / Justification	Citizens should accept to respect a certain number of common rules concerning process management. Indeed, general interest should be respected, which can be represented by a neutral mediator who regulates positions and opinions. This mediator helps also to have the schedule respected, which avoids frustrations and conflicts and prolongation of duration (and costs).
6.	Unit	<ul style="list-style-type: none"> <li>- consensus on the existence of a problem</li> <li>- collective acceptance of common mediator and use of neutral mediator (trust)</li> </ul> <p>documentation : a clear and understandable diagnosis (avoiding technical terms)//</p>
7.	Data Base / Source	Analysis of documentation used for public debates (diagnosis, progress reports etc)

1.	ID	5.12
2.	Indicator	Transparency and perception of costs of process for all stakeholders
3.	Name	Transparency and perception of costs of process for all stakeholders
4.	Objective	6. To improve the efficiency of the process in terms of duration and costs
5.	Definition / Justification	explanation of indicator and expected results, sustainability context of the indicator
6.	Unit	used unit to measure the indicator
7.	Data Base / Source	source of information, rules for exploration, time frame, considered area and groups

1.	ID	5.13
2.	Indicator	Education level with regard to process management
3.	Name	Education level with regard to process management
4.	Objective	7. To empower citizens, especially those representing non-organised interests
5.	Definition / Justification	explanation of indicator and expected results, sustainability context of the indicator
6.	Unit	used unit to measure the indicator
7.	Data Base / Source	source of information, rules for exploration, time frame, considered area and groups

1.	ID	5.14
2.	Indicator	Lowest level, where control over budgets and process (binding decisions) exists
3.	Name	Lowest level, where control over budgets and process (binding decisions) exists
4.	Objective	8. To delegate responsibility to lower decision level and to stimulate a sense of ownership
5.	Definition / Justification	explanation of indicator and expected results, sustainability context of the indicator
6.	Unit	used unit to measure the indicator
7.	Data Base / Source	source of information, rules for exploration, time frame, considered area and groups

## **TOOLS FOR MANAGEMENT OF BROWNFIELDS PROJECTS**

### **Objective 1: To adopt an interdisciplinary approach**

1.	ID	6.1
2.	Indicator	Does a Quality Assurance and Quality Control Procedures Plan exist?
3.	Name	Existence of a Quality Assurance and Quality Control Procedures Plan
4.	Objective	To check and evaluate the existence and quality of a team approach and planning
5.	Definition	The quality assurance is an integrated system of management activities involving planning, assessment, reporting, etc.
6.	Justification	Such document is a key document for an optimal management and quality control of the project
7.	Unit of measurement	Yes / No, check list

### **Objective 2: To facilitate efficient project delivery and to develop a management plan for the whole site, and start to monitor, control and revise the schedule and the budget on a regular basis**

1.	ID	6.2
2.	Indicator	Does a Project Management Plan exist?
3.	Name	Existence of a Project Management Plan updated on a regularly basis
4.	Objective	To evaluate and check the existence of a Project Management Plan
5.	Definition	The elements of a management plan will document the design of all the operations and that results meet specified objectives
6.	Justification	The existence of a project management plan well structured is a good tool to reach the above mentioned objective.
7.	Unit of measurement	Yes / No, check list

1.	ID	6.3
2.	Indicator	Market price before development/ market price after development
3.	Name	Economic viability
4.	Objective	To evaluate the efficiency of the economical approach taken for the project
5.	Definition	Appraisal of the financial processes
6.	Justification	The potential for long-term private sector investment is directly related to this indicator
7.	Unit of measurement	%

**Objective 3: To promote and manage stakeholders participation**

1.	ID	6.4
2.	Indicator	Does a Community Information and Participation Plan exist?
3.	Name	Existence of a Community Information and Participation Plan
4.	Objective	To evaluate and check the existence of a Community Information and Participation Plan
5.	Definition	Appropriate information is communicated to the appropriate people at the right time
6.	Justification	Social acceptance and smooth development of the project
7.	Unit of measurement	Yes / No, checklist

1.	ID	6.5
2.	Indicator	Number and content of public progress reports made during the project
3.	Name	Public information progress reports
4.	Objective	To check the continuity and efficiency of the public information
5.	Definition	Public progress reports are the presentations of the status of the public communication and information at a given time of the project
6.	Justification	Social acceptance is directly related to the quality and frequency of the public information
7.	Unit of measurement	Number of reports and checklist

**Objective 4: To provide a frame-work for transparency in decisions, flow of information and improved communication structures**

1.	ID	6.6
2.	Indicator	Existence of documents
3.	Name	Record of decisions
4.	Objective	To check the availability and quality of documents recording the flow of decisions
5.	Definition	Documentary evidence of the decisions and the reasons behind those decisions for the reuse options, the need for risk management action and the satisfactory performance of that action.
6.	Justification	Much redevelopment effort leaves no visible result – eg remediation or demolition. Stakeholders require written evidence that they can assess and evaluate before deciding whether or not to occupy land, give necessary permissions etc.
7.	Unit of measurement	Yes / No

1.	ID	6.7
2.	Indicator	Existence of a communication strategy and related documents
3.	Name	Communication structure
4.	Objective	To check the existence of an effective communication strategy with a balance between the frequency and the appropriate level of communication.
5.	Definition	The strategy will document about communication procedures, frequency, controls, etc. Evidence of this strategy should be shown.
6.	Justification	Many projects suffer from poor communication and being poorly received by their neighbourhoods.
7.	Unit of measurement	Yes / No, check list

**Objective 5: To develop tools for the protection of human health and for safety during field work**

1.	ID	6.8
2.	Indicator	Existence of an Health and Safety Plan and records
3.	Name	Existence of a Health and Safety Plan and number of accidents and incidents
4.	Objective	To evaluate the existence of a Health and Safety Plan and the safety record of the site
5.	Definition	The health and safety plan will consider the workers and public as these issues might affect the project completion and the necessity to protect the public.
6.	Justification	The existence of an health and safety plan is a prerequisite but the number of accidents will allow to check the application of the rules and guidelines of the plan.
7.	Unit of measurement	Yes / No, number of accidents/nr. working days

**Objective 6: To adopt an integrated approach**

1.	ID	6.9
2.	Indicator	Does a “Cost Benefit Analysis” exist?
3.	Name	Costs Benefits analysis
4.	Objective	To assess the existence and quality of a “Cost Benefit Analysis”
5.	Definition	A “Cost Benefit Analysis” indicator allow a metric evaluation of a complex decision (incl. Market research studies)
6.	Justification	Decisions concerning environment always involve costs and benefits some with monetary values and some without. Ideally decisions are made where the benefits outweigh the costs.
7.	Unit of measurement	Yes/no and Check list

# **Appendix B**

## **Case Studies Tables**



## Sites in France

LOISINORD	
1. Location	Nord Pais de Calais
2. Site: size / previous use / urban context	Size: 200ha Location outside the city on the board of 4 municipalities Previous use: <ul style="list-style-type: none"> <li>• Coal extraction and coke plant</li> </ul>
3. Contamination and Debris	<ul style="list-style-type: none"> <li>• Presence of contamination</li> </ul>
4. Buildings and Infrastructure	No Buildings
5. Concept / Future use	<ul style="list-style-type: none"> <li>• Development of new leisure facilities</li> </ul>
6. Realization	1998-2004

LES TERTIALES – FORGEVAL	
1. Location	Nord Pais du Calais
2. Site: size / previous use / urban context	Size: 25ha Location in the inner city Previous use: <ul style="list-style-type: none"> <li>• Industrial</li> </ul>
3. Contamination and Debris	No presence
4. Buildings and Infrastructure	No building retain
5. Concept / Future use	Mixed redevelopment including universities, commercial and housing
6. Realization	1997-2002

## Sites in Germany

RADBOD	
1. Location	Hamm-Bockum-Hövel, in the north-east of the Ruhr Area
2. Site: size / previous use / urban context	<p>Size: 21 ha</p> <p>Location in the city and surrounding land uses</p> <ul style="list-style-type: none"> <li>• Directly south of the urban area of Hamm-Bockum-Hövel</li> <li>• Green spaces to the west, south and east</li> </ul> <p>Traffic access/connection</p> <ul style="list-style-type: none"> <li>• Motorway A1 (to Bremen / Cologne) approx 8km</li> <li>• Motorway A2 (to Berlin/ Oberhausen) approx 11km</li> <li>• High speed train stop at the railway station of Hamm</li> </ul> <p>Previous use:</p> <ul style="list-style-type: none"> <li>• Coal mine named Radbod 1/2/5, including the cookery Radbod</li> <li>• Started 1904</li> <li>• Extraction since 1906</li> <li>• 1976 closure of the cookery</li> <li>• 1990 closure of the coal mine</li> </ul>
3. Contamination and Debris	<ul style="list-style-type: none"> <li>• 1992 to 1995 exploration/ investigation phase with an historical inquiry</li> <li>• 1997 to 1998 development of the sanitation and preparation concept</li> <li>• 1999 start of preparation and coverage of the project area</li> </ul> <p>Remediation/soil management</p> <ul style="list-style-type: none"> <li>• necessity to partly fill up the area</li> <li>• soil with light concentrations of hydrocarbon and others were safely accumulated in the southern part of the project area</li> <li>• removal of constructional barriers/ obstacles, also in the underground</li> <li>• disposal of heavy contaminated materials</li> </ul>
4. Buildings and Infrastructure	<p>Buildings</p> <ul style="list-style-type: none"> <li>• the old porter house</li> <li>• the vehicle hall</li> <li>• shaft towers (2x): listed buildings</li> <li>• steam engine house: listed building</li> <li>• shaft Winkhaus (shaft n° 5), this one is still in operation</li> </ul>

5. Concept / Future use	<ul style="list-style-type: none"> <li>• Industry</li> <li>• The concept bases on a divers and flexible design. Important facts are the integration of historical buildings, existing greens, the divers design of streets, including green and different squares. The concept should be flexible to react on and integrate the ideas and desires of the investors. The so called "module plan" with its special raster offers a very flexible partitioning of the lots. The objective is to create a harmonically urban overall picture.</li> <li>• Legally binding land use and building plan ("Bebauungsplan") has been elaborated</li> </ul>
6. Realization	1995-2002

ESPENHAIN	
1. Location	Central location in the former lignite basin "Südraum Leipzig" between the city of Leipzig and Borna
2. Site	Former chemical plant, briquette factory and 2 power stations
3. Contamination and Debris	<ul style="list-style-type: none"> <li>• Organic pollutants, metals</li> <li>• Waste tip from lignite mining</li> </ul>
4. Buildings and Infrastructure	Demolition works since 1990, remaining industrial monument, power station, and administrative buildings
5. Concept / Future use	Industrial- and Science park, cultural uses in the former briquette factory
6. Realization	Industrial Park 2002 -2004

## Sites in Poland

THE DOLOMITES SPORTS VALLEY	
1. Location	Bytom, Silesia
2. Site	Size 38 ha Dolomite open cast mine
3. Contamination and Debris	<ul style="list-style-type: none"> <li>• Low concentrations of heavy metals</li> <li>• No significant constraint for redevelopment</li> </ul>
4. Buildings and Infrastructure	Original buildings and infrastructure have been dismantled
5. Concept / Future use	All year leisure and recreation centre including an artificial ski slope, equestrian centre, mountain biking tracks, climbing wall, minigolf
6. Realization	Opened in December 2002

SOSNOWIEC COAL MINE	
1. Location	Sosnowiec, Silesia
2. Site	Size 31ha Coal mine
3. Contamination and Debris	<ul style="list-style-type: none"> <li>• Spoil bank (high max 8,0 m over the adjacent area)</li> <li>• Coal mining wastes</li> </ul>
4. Buildings and Infrastructure	Office building (3-floor administration and social building) Two workshops and storage facilities New manufacturing plant Pit shaft hoist tower
5. Concept / Future use	<ul style="list-style-type: none"> <li>• Industry</li> <li>• Services</li> <li>• Housing</li> </ul>
6. Realization	Beginning in the year 2001

## Sites in UK

MARKHAM	
1. Location	Bolsover, Derbyshire, East Midlands Region of England
2. Site	Coal Mine Tip
3. Contamination and Debris	Dioxins Metals
4. Buildings and Infrastructure	Most of the structures were demolished in 1990s. This was normal practice at the time
5. Concept / Future use	<ul style="list-style-type: none"> <li>Commercial use of the colliery site; the tip will be used to produce biomass (willow trees) to provide heat and energy for the new uses on the colliery site;</li> <li>Project design includes job creation, training, education, waste management, renewable energy, risk management, public amenity, wildlife habitat</li> </ul>
6. Realization	2002 - 2004

GATESHEAD QUAYS	
1. Location	Gateshead, Tyne and Wear, North East Region of England
2. Site	Harbour
3. Contamination and Debris	Oil Metal
4. Buildings and Infrastructure	Major structures retains
5. Concept / Future use	Social, cultural and economic regeneration
6. Realization	1999 - 2005

# **Appendix C**

## **Data**

**SITE GENERAL INFORMATION**  
(for the 8 case studies)

Site_code	Site_name	Dimension_ha	Dimension_sqm	Location	Location_code	Past_use	Past_use_code	Future_use	Future_use_code	Contamination	Contamination_code	Building	Building_code	MAPINFO_ID
1	Loisnord	200	2000000	boarder of town		2 coke/plant		5 leisure park		3 n/a		0 n/a		0
2	Les Tertiales	25	250000	close to city centre		1 coal		2 complex of services		6 n/a		0 n/a		0
3	Radbod	21	210000	northwest of city		2 coal/mine		2 industrial		1 hydrocarbon/heavy contaminated materials		6 6 buildings maintained		1
4	Esperhan	300	3000000	outside city		3 chemical plant/power st		3 industrial, science park		1 organic pollutants/metals		5 buildings retained		1
5	The Dolomites	38	380000	centre of the agglomeration		1 dolomite mine		9 sports valley, leisure and recreation		3 heavy metals		7 buildings retained		1
6	Sosnowiec	31	310000	board of town		3 coal mine		2 mixed development		6 spoil bank/coal mining waste		3 all dismantled		3
7	Geleshead	200	2000000	inner city		1 mixed industry		8 leisure, culture, residential		6 all metals		1 3 buildings maintained		2
8	Marlham Willows	320	3200000	out from town		2 coal mine		2 commercial		2 dioxide/metals		4 major structure retained		1

**INDICATORS DATA**

	Markham Willows	Radbod	Espenhaim	Bytom	Sosnoviec	Loisinord	Tertiales	Gateshead	
<b>Ind5.1. Equal access to information</b> <b>Ind5.2. Symmetry of information flow</b> <b>Ind5.3. Alternative sources of information/contradictory expertises</b> <b>Ind5.4. Publicity and documentation of debates and (Intermediate) results</b> <b>Ind5.12 (added by ZEFIR in D.1.4) existence of a community information and participation plan</b>									
B7	Which information were available for the public?	all	YES draft of the binding plan, newspaper, local radio, documents	YES plans (urban land use planning procedure)	YES	YES (direct and general access to information)	YES (legal access to urban land use planning documents)	YES (legal access to urban land use planning documents)	ALL
B8	How long did it take citizens to get information?	no data		Direct contact with the city office	Immediately	City information centre	No data available	A special form ("B2") any citizen can fill in	
	Is the information public?	YES, by means of regular exhibitions +newsletters	YES as far as the law allows	YES as far as the law allows	Info needing special preparation=14 days	YES : access to the sources of the local plan management (coalmine, expertise ...)	YES	YES	No answer : YES but „on request“
B9	Was the information free?	YES	YES	YES	YES	YES*	YES	YES	YES
B10	What kinds of information tools are existent?	Newsletter	Press articles, local radio, information, plate	Press articles, leaflets	Newsletters, press announcements, internet, advisements	Local press (reports from the City council sessions), + Silesian Voivodship office Monitor ; press announcements, information board and posts in the City	The municipal newsletter (originally every 2 months now 6), Noeux-les-Mines website	The municipal newsletter (VIE VAL) + a free phone number (accueil quartiers) + an internet forum on Valenciennes Town Council website	Newsletters, Visitor centre, web site
B11	Who took the responsibility to organize this access to information?	Council	The project development company	Developer and the City	The Municipal Office	The Department of Economic policy and City promotion of the Municipal office	Noeux-les-Mines municipality	Valenciennes Municipality	Gateshead Council



**INDICATORS DATA**

		<b>Markham Willows</b>	<b>Radbod</b>	<b>Espenhalm</b>	<b>Bytom</b>	<b>Sosnoviec</b>	<b>Loisnord</b>	<b>Tertiales</b>	<b>Gateshead</b>
B12	How often and with how much lag is information given to the citizens?	No data	Regularity but information about new investors only given when the contract of sale was signed	In regular intervals	No data: Frequency is not indicated by law	Direct and general access to information. City information Centre open without limitation (data on the plan)	The municipal newsletter (originally every 2 months now 6).	The municipal newsletter published every 3 months	For residential and businesses in E.G., newsletters issued quaterly
B13	Transparency: Has the public access to all information on issues critical to their interests?	YES	YES, as far as critical interests are known	YES, as far as critical interests are known	YES	No data	Not relevant	Not relevant	+ for all residents, biannual newsletters
B14	Have the intermediate results been published?	no data	YES (press articles, web site, public events)	No data	YES	No, only verbal	NO	NO	YES, unless specific confidential issues
B15	Have the public debates been documented?	NO	YES, in protocols, official docts, press kits	YES, in protocols, official docts, press kits	YES	YES, public debates are documented thanks to City Council session reports in the local press	There were no public debates	YES and NO : problems of regularity of intermediate reports of public meetings	YES
B16	Were / are there any contacts with National/Regional /local press?	YES	YES, mostly local, only 1 article in national press	YES, mostly local	YES, specially regional and local press	YES, mostly local press, more rarely national ; citizens can send letters, and phone newspapers'office	YES, national, regional and local mediatic global excitement in the beginning of the nineties. Now end of the "surprise effect"	Direct and regular contacts with local press of the President of the city-quarter council	YES, national and local press very early in the process
B19	Was there a scientific popularization ?	no data	Press articles	Press articles	No	Planned ( a popular and scientific conference and a collective publication in the Territorial Self-gouvernement review)	A promotional leaflet	No specific communication tool	No

INDICATORS DATA

		Markham Willows	Radbod	Espenhaim	Bytom	Sosnoviec	Loisnord	Tertiales	Gateshead
B17	Was / is the information flow symmetric (between stakeholders and local community) or one-way (local community informing stakeholders)?	Symmetric	Symmetric stakeholders developers	Symmetric	Symmetric	Symmetric	One-way	One-way	Symmetric
B18	Was / is the information flow continuous/punctual/limited in time?	As soon as something new happens, the local community is informed. Information will increase during the life of the project (which is in the planning stage) : at the moment, it is logically quite low	YES regular	YES continuous	YES continuous	No data	Punctual	YES regular	YES continuous
<b>Ind5.5. Transparency of the process management</b>									
<b>Ind5.6. Practical methods in the process management</b>									
B3	Which time management tools have been used?	Not applicable until now	Not applicable until now	No information	Time framework defined by law	No data	NO	NO	Not applicable until now
	How long did the global process of participation, communication and alternative expertise last?	Not applicable until now	Not applicable until now	Formal participation along official previous acts by law	The global process lasted 6 years (includes marketing researches)	No data	Not applicable	Not applicable	A continuous process

**INDICATORS DATA**

		<b>Markham Willows</b>	<b>Radbod</b>	<b>Espenhalm</b>	<b>Bytom</b>	<b>Sosnoviec</b>	<b>Loisinord</b>	<b>Tertiales</b>	<b>Gateshead</b>
B21	Was there the need for a neutral mediator?	no data	Not necessary	No	No need for a neutral mediator	No need for a neutral mediator so far	no data	no data	No 3rd party mediation was required (thanks to EDAW)
	How was he/she chosen?	no data	not applicable	No data	not applicable	not applicable	No data	no data	Not applicable
	Were / are common rules (regulation of debates) existent?	no data	not specially developed ones	not specially developed ones	No data	No data	No data	no data	No common rules
	Was / is the time schedule respected?	no data	YES	YES	No data	No data	No data	No data	not applicable
	Were contradictions expressed clearly?	no data	YES	YES	No data	No data	No data	no data	YES
	How were / are conflicts solved?	no data	YES personal discussions between persons who raised objections and the development company. In certain cases, a common field survey was necessary	discussions	No significant conflicts	No significant conflicts	No data	No data	Negotiations have solved conflicts in the majority of cases
<b>Ind5.7. Representativeness of the range of participants/citizens</b>									
B20	In which part of the project the involvement of citizens started?	At the beginning of the project if we consider information and consultation as a form of involvement	No data	Before starting the project	At the moment the Municipality accepted the preconditions and directions of the city development	Citizens' involvement is moderate	There was no involvement of citizens	Citizens' involvement is very recent. The City-quarter council became in charge of this utterly new quarter only in March 2001	At a very early stage (1st plan prepared by EDAW)

**INDICATORS DATA**

		<b>Markham Willows</b>	<b>Radbod</b>	<b>Espenhaim</b>	<b>Bytom</b>	<b>Sosnoviec</b>	<b>Loisinord</b>	<b>Tertiales</b>	<b>Gateshead</b>
B22	What was / is the number and profile of citizens accountable for the process?	Not applicable	Not counted, the average people took part	Not counted, the average people took part	The group of owners and inhabitants of adjoining plots (housing cooperatives and ecological organizations, representatives of professional groups, associations and NGOs)	No, but the interested citizens are identified as the community dwelling in suburbs surrounding the post-mining area and owners of allotment gardens.	This dimension was not taken into account	No professional tools to observe and define the participants' profile. No powerful non-organized associations have been detected in the Tertiales site.	In the East Gateshead partnership, 4 individuals/8 are from the residential and business community
	Was there a representation of non-organized citizens? If yes, how were they detected?	Not applicable	The non-organized citizens represent themselves	The non-organized citizens represent themselves	No special representative of non-organized citizens	Most of the citizens are not gathered in any organizations nor groups representing their interest in an organized way	Not relevant	The President of the city-quarter council has a very good knowledge (however empirical) of his public which involves the category of "professional citizens" who got used to technical debates and qualified in debating)	At the beginning the public had a very low educational ability. After, some local residents were able to participate

INDICATORS DATA

		Markham Willows	Radbod	Espenhaim	Bytom	Sosnoviec	Loisnord	Tertiales	Gateshead
B1	Have the population's needs and priorities been investigated before the conception of the project?	YES	YES : a public meeting organized by the adult education centre + decentralized workshops	YES : public discussions with a consensus on (re)using the site as commercial/industrial area : new jobs		YES, in several stages corresponding to the legal procedure of creating a local plan of land management (rule of "nothing without us")	NO, for the project manager, the scope of the project goes beyond local citizens'interests. Local elections (every 6 years) are the best way to size up citizens'acceptance and ownership of the project. (citizens are taxpayers and local consumers of leisure)	NO, for a simple reason: before the conception of the project, there was no population at all in this town area	YES, via the EDAW study and Unitary Development Plan
	Have the population's needs and priorities been investigated at each step of the project?	YES	NO	Not investigated in the form of surveys	No data	1) a process of participation and communication, elaboration of expertises lasted 20 months (connected to the elaboration of the area land management plan	Several but limited investigations were done concerning 2 kinds of stakeholders : shopkeepers and industrials.	NO	YES, via regular consultation, through the East G. partnership
	Have the population's needs and priorities been investigated at one step of the project? At which step?	N/A	No data	In the beginning and at every step of the formal planning process	No data	No data	NO	Mr HOT, President of the "Saint-Michel-le Rôleur-les Tertiales" City-quarter will organize a specific public meeting	Not applicable
	Have the population's needs and priorities been investigated at the end of the project?	N/A	No, yet not planned	Monitoring of the project with results in 2007	No data	No data	No data	NO	The position hasn't yet been reached. However, it is unlikely that a "satisfaction" survey will be initiated

**INDICATORS DATA**

	<b>Markham Willows</b>	<b>Radbod</b>	<b>Espenhalm</b>	<b>Bytom</b>	<b>Sosnoviec</b>	<b>Loisinord</b>	<b>Tertiales</b>	<b>Gateshead</b>	
<b>Ind5.8. Early involvement of stakeholders and power of influence in the different steps of the process management</b>									
<b>Ind5.9.Satisfaction/contestation of results</b>									
<b>Ind5.10. Lowest level where control over budget and process exists</b>									
B2	Which technique to investigate the population's needs and priorities was used? (polls, public enquiries, referendums ...)	Questionnaires	See A2/A3 (forms of participation and degrees of participation)	Discussions	No data	No questionnaires, no referendum	NO	City-quarter council : one regular meeting every 2 months +yearly assembly	Press, local newspapers, polls, public meetings
	Have new techniques been developed to match the needs?	Not applicable until now	No (regarded as not necessary)	No	No data	Yes, a periodically updated web page of the City office (all information connected with land management plan)	No	Valenciennes has developed an ambitious program of "e-citizenhip" : a intranet system ("Anneau Citoyen Valenciennois") and an interactive web TV	YES : a Visitor information centre, located within Gateshead Quays
B23	Was the participatory technique adapted to the project?	Not applicable until now	NO	NO	YES	YES seminars	Not relevant	Not relevant	YES
	Did it help to solve conflicts?	No data	YES	No data	YES	No data	Not relevant	Not relevant	YES
	How were conflicts managed?	No data	B21	discussions	No significant conflicts	No data	Not relevant	Not relevant	
	Was it a failure to adapt a participatory approach?	No data	NO	?	NO	No data	Not relevant	Not relevant	no
	Has a new participatory process been applied during the project?	No data	YES and NO	NO	No a rather standard participatory process was applied	No data	Not relevant	Not relevant	NO

INDICATORS DATA

		Markham Willows	Radbod	Espenhaim	Bytom	Sosnoviec	Loisinord	Tertiales	Gateshead
	Did it increase the duration and cost of the project?	No data	duration YES	NO	No, it has minimized the risks of additional costs and delays	No data	No data	no data	Not significant
	Contestation of the project: How many complaints have been handed in?	none	2 formal complaints	1 formal complaint	2 formal complaints	A single case of objection, rejected by the City council. This decision was not appealed. In the final stage of the project, potential conflicts in the area located in the city centre, directly bordering large multi-family building concentration units.	Formal complaints	No formal complaints	NONE
	How many cases were brought to court?	NONE	NONE	NONE	NONE	No data	LOISINORD was sued twice (tribunal dealing with internal disputes in the French civil service)	NONE	NONE
	Which lessons have been learnt?	NONE	To identify local interest groups in the beginning of the project	Direct correlation between information and citizen contentment	No data	No data	A public enquiry should have been organized	NONE	To involve the public at the earliest stage
<b>Ind5.11. budget allocated by authorities</b>									
B4	Was there a decision to allow a special budget to information, participation, communication, alternative expertise?	NO	No special budget for participation  But the project company has a special budget for public relationships, information and marketing	YES	No special budget	No data	No specific budget	NO	No

INDICATORS DATA

		Markham Willows	Radbod	Espenhalm	Bytom	Sosnoviec	Loisinord	Tertiales	Gateshead
B5	How much was / is the special budget to information, participation, communication, alternative expertise?	Not applicable until now	Not applicable until now	No information	No data	No data	Recently, Noeux-les-Mines hired a project manager in charge of public relations but not focussed on LOISINORD specifically	Not applicable	Not applicable until now
B6	Was the budget for participation, communication and alternative expertise adequate for the needs?	Not applicable until now	YES but not for participation	YES	The expenditures for public participation = necessary and adequate	No data	Not applicable	Not applicable	Not applicable until now



**INDICATORS DATA**

	<b>Markham Willows</b>	<b>Radbod</b>	<b>Espenhaim</b>	<b>Bytom</b>	<b>Sosnowiec</b>	<b>Loisinord</b>	<b>Tertiales</b>	<b>Gateshead</b>	
<b>Objective 1: To reduce negative environmental impacts on the site and on the neighbourhood including human health risks</b>									
Number of complaints and incidents per year	Not addressed	No complaints	No complaints (some complaints about air during remediation)	No complaint reported, but no data concerning before site redevelopment	No complaint reported, but no data concerning before site redevelopment	No mention of such an approach	Not addressed / Not relevant	Complaint record is not mentioned	
Number of measures Time percentage of excessive noise	Not addressed	Not relevant	Remediation measures against noise, air pollution	Not addressed during characterisation / no data	Not addressed during characterisation / no data	Not addressed / no data	Not addressed during characterisation	Maximum noise level has been set / limitation of working time	
Number of complaints during characterisation and remediation of the site	No air survey / no complaints reported	As much as necessary	Some complaints before and during remediation. Air monitoring during works	Regional monitoring of air quality.	Air tests performed (regional monitoring), no records on public complaints available	Not addressed / No data	No data	No air survey / no complaints reported	
Surface and groundwater management plan	Surface water (river) not addressed	Surface water (river) not considered	No information found about surface water or drainage system.	Not documented so far ; Municipal sewage, no data on water quality control before discharge into the environment	Not documented so far ; Municipal sewage, no data on water quality control before discharge into the environment	Not documented	Ground water addressed / Surface water not addressed	No surface water	
Existence and scope of a risk management framework.	Yes	Yes	yes	Yes, through the procedure applied (mainly regarding soil)	Yes, through the "Local framework plan of area management for the lands located within the Gabriela Naturowicza and 3 Maja streets"	No	Yes (Human Health Detailed Risk Evaluation (HH-DRA) following the national methodology	Yes	

**INDICATORS DATA**

	<b>Markham Willows</b>	<b>Radbod</b>	<b>Espenhaim</b>	<b>Bytom</b>	<b>Sosnowiec</b>	<b>Loisinord</b>	<b>Tertiales</b>	<b>Gateshead</b>	
<b>Objective 2 :To minimise waste and maximise recycling and reuse of soil and debris</b>									
		Green wastes reused / Grey water to irrigate / Wood burning for energy	Green wastes reused / Grey water to irrigate / Wood burning for energy	Green wastes reused / Grey water to irrigate / Wood burning for energy	Waste used for levelling. Other wastes dumped according to regulation	Few data available. Some waste used for levelling. Other wastes dumped according to regulation	Not assessed	No data available	Waste used for levelling, waste minimisation to reduce costs. Other wastes dumped according to regulation
<b>Objective 3: To ensure cost effectiveness and technical feasibility</b>									
	Existence of a "Post-Remediation validation reporting"	Not documented. Remediation at its beginning ;carried out regarding criteria for soil / Water. No residual risk assessment needed	Not documented	Not all documented in such detail. Post rehabilitation evaluation has been made	No data	Not documented	Not documented	No technical or economical data regarding post remediation are available.	Not documented. Remediation carried out regarding criteria for soil / Water. No residual risk assessment needed
<b>Objective 4: To improve social acceptance through identification of all stakeholders and risk communication</b>									
	Existence of an informative public approach strategy including education	No data	No data	No data	No data. All documents are public access	No data. All documents are public access	No data. All documents are reputed public access	No data. All documents are public access	No data
<b>Objective 5: To provide decision support tools for risk based land management</b>									
	Use of decision support tools	No data	No data	Yes	No data	No data	No	No data	No data

**INDICATORS DATA**

	<b>Markham Willows</b>	<b>Radbod</b>	<b>Espenhain</b>	<b>Bytom</b>	<b>Sosnowiec</b>	<b>Loisinord</b>	<b>Tertiales</b>	<b>Gateshead</b>	
<b>Objective 3.1: To minimise energy demand and produce renewable energy on the site</b>									
Energy Consumption Standard	No information	Minimum achieved	No information	Not applicable	Considered in the design	Not applicable	Above average	No Information	
Possibilities for energy efficiency optimisation	No information	Considered in the design	Not considered	Not applicable	Planned in the design	Not applicable	Included in the design	No Information	
Percentage of Renewable Energy produced at reused buildings and infrastructure	No data	No data	None	No data	No data	No data	Not applicable	None	
<b>Objective 3.2: To minimise water demand and reduce wastewater production</b>									
Potable water reduction facilities	Need to connect new system up to existing local supply	Yes	Yes	No	Yes	Not available	Not available	None	
Unpurified waste water runoff	No sewerage mains – possibility that the waste can be used to fertilise the Willows development	Yes	Yes	Yes	Yes	Yes	Not considered	None	
Rainwater separation	Planned	Yes	Yes	Yes	Yes	Yes	Planned	No data	

**INDICATORS DATA**

	<b>Markham Willows</b>	<b>Radbod</b>	<b>Espenhain</b>	<b>Bytom</b>	<b>Sosnowiec</b>	<b>Loisinord</b>	<b>Tertiales</b>	<b>Gateshead</b>	
<b>Objective 3.3: To minimise waste generation from buildings and civil infrastructure (optimising recycling and reuse)</b>									
Building material recycling and reuse	Not applicable	Not known	No data	Plan in place	Not considered	Incomplete data	Data unknown	Information not available (as volume)	
Building material recycling and reuse on site	Information not available	Not known	No data	Plan in place	Not considered	Incomplete data	Data unknown	Information not available	
<b>Objective 3.4: To decide for proceedings based on defining the cultural and regional identity by the quality of its industrial heritage</b>									
Conservation of industrial monuments	100%	Shaft towers conserved	Not applicable	Not applicable		Not applicable	None on site	100%	
<b>Objective 3.5: To find better ways to comply with health and safety regulations for reused buildings and infrastructure</b>									
Innovative Solutions to comply with health and safety regulations	No information	Complying with regulations	Complying with local regulations	No information	Yes	Complying with regulations	Not available	100% complying with regulations for health and safety. Separate check carried out by Gateshead Fire Brigade.	
Guideline use	No information	Yes	Yes	Yes	Yes	Yes	No information	No Information	
Studies realised	Yes	Yes	Yes	Yes	Yes	Yes	Yes	Yes	
Financing and taxation approaches	Not available	Public and Private	Public and Private	Not known	No data	Government	No information	Lottery Funding	

