

MULTIMODAL FEEDBACK CUES ON MANUAL LIFTING IN VIRTUAL ENVIRONMENTS

A thesis submitted to
Cardiff University,
for the degree of

Doctor of Philosophy

by

Faieza Abdul Aziz, B.Eng.(Hons), MSc

Manufacturing Engineering Centre
Cardiff University
United Kingdom

2006

UMI Number: U584863

All rights reserved

INFORMATION TO ALL USERS

The quality of this reproduction is dependent upon the quality of the copy submitted.

In the unlikely event that the author did not send a complete manuscript and there are missing pages, these will be noted. Also, if material had to be removed, a note will indicate the deletion.



UMI U584863

Published by ProQuest LLC 2013. Copyright in the Dissertation held by the Author.
Microform Edition © ProQuest LLC.

All rights reserved. This work is protected against
unauthorized copying under Title 17, United States Code.



ProQuest LLC
789 East Eisenhower Parkway
P.O. Box 1346
Ann Arbor, MI 48106-1346

In the Name of Allah, the Most Gracious, the Most Merciful

“...Allah will raise up, to (suitable) ranks (and degrees), those of you who believe and have been granted Knowledge. And Allah is well-acquainted with all you do.”

The Holy Quran 58: 11

ABSTRACT

Improper manipulation of real-world objects increases the risk of developing work-related back injuries. In an effort to reduce such a risk and encourage appropriate lifting and moving methods, a Virtual Environment (VE) was employed. Virtual simulations can be used for ergonomic analysis. In this work, the VEs made use of multiple feedback techniques to allow a person to estimate the forces acting on their lower back. A person's head and hand movements were tracked in real-time whilst manipulating an object. A NIOSH lifting equation was used to calculate and determine the Lifting Index whereby the results were conveyed in real time.

Visual display feedback techniques were designed and the effect of cues to enhance user performance was experimentally evaluated. The feedback cues provide the user with information about the forces acting on their lower back as they perform manual lifting tasks in VEs. Four different methods were compared and contrasted: No Feedback, Text, Colour and Combined Colour and Text.

This work also investigated various types of auditory feedback technique to support object manipulation in VEs. Auditory feedback has been demonstrated to convey information in computer applications effectively, but little work has been reported on the efficacy of such techniques, particularly for ergonomic design. Four different methods were compared and contrasted: No Feedback, White-noise, Pitch and Tempo. A combined Audio-Visual (AV) technique was also examined by mixing both senses.

The effect of Tactile Augmentation was also examined. Three different weights (real) were used and the results obtained by experiment were compared with the experiment using virtual weights in order to evaluate whether or not the presence of a real weighted object enhanced people's sense of realism.

The goals of this study were to explore various senses of feedback technique (visual, auditory and tactile), compare the performance characteristics of each technique and understand their relative advantages and drawbacks.

DEDICATION

THIS WORK IS ENTIRELY DEDICATED TO MY BELOVED

FAMILY

TO MY HUSBAND: FADZRI MD JAAFAR
who has greatly encouraged and supported me during my studies

TO MY SON: EMIRUL ADZFAR (MIMO) FADZRI
who always brings joy to my life

TO MY PARENTS: HJ. ABDUL AZIZ & HJH. FARTIMAH
who always wonderfully supported and encouraged me throughout my education

ACKNOWLEDGEMENT

I would like to thank the supervisor of my studies, Professor D. T. Pham for his invaluable guidance, constructive remarks and great support throughout my research. I am also deeply indebted to Professor S.S. Dimov for his suggestion and encouragement throughout this work.

I am very grateful to Dr. Ieuan A. Nicholas for his invaluable contribution and support throughout this research. I am thankful to Dr. Roger Philp and Dr Medhat Awadalla, for their advice in programming language. I am greatly indebted to Christopher Matthews, for his constructive criticism and suggestions to improve the final manuscript of the thesis. Thanks also go to my friend, Dr. Yusniza Kamarulzaman who was always there to help and discuss any problem regarding word processing during my writing stage.

I wish to express my special thanks to all my colleagues in the Manufacturing Engineering Centre (MEC) and Welsh e-Science Centre who have participated in my experiments. I also want to thank all my colleagues in the MEC who were very good to me and very helpful whenever I needed them.

I would also like to thank all the members of the Malaysian community in Cardiff for their support and friendship. I am very grateful and acknowledge the substantial financial support from Universiti Putra Malaysia and Ministry of Science, Technology and Innovation (MOSTI), Malaysia.

I wish to express my heartfelt gratitude to my parents, Hj. Abdul Aziz Idris and Hjh. Fartimah Harun for all the love and unconditional support they have given me. I also want to express my warmest thanks to my parents-in-law, Hj. Md. Jaafar and Hjh. Sakimah for their love and support in my endeavours. I also want to thank my brother, sister-in-law and brother-in-law. Last but not least, I wish to sincerely thank my husband, Fadzri Md Jaafar and my son, Emirul Adzfar (Mimo) for their love, patience, support and understanding.

CONTENTS

ABSTRACT	iii
DEDICATION	v
ACKNOWLEDGEMENT	vi
DECLARATION	viii
CONTENTS	ix
LIST OF FIGURES	xiii
LIST OF TABLES	xvi
ABBREVIATIONS	xvii
Chapter 1. Introduction	1
1.1 Preliminaries	1
1.2 Background	1
1.3 Research Statement and Objectives	3
1.4 Research Hypotheses	4
1.5 Outline of the Thesis	6
Chapter 2. Virtual Environment Considerations for Manual Material Handling	8
2.1 Virtual Environment Technology	9
2.1.1 VR Requirement	12
2.1.1.1 Computers	13
2.1.1.2 Tracking	13
2.1.1.3 Input Devices	14
2.1.1.4 Output Devices	14
2.1.1.5 Visual Displays	17
2.1.1.6 Stereo Vision	23
2.1.1.7 VR Software	24
2.1.1.8 Critical VR terms	25
2.1.2 Types of VR system	26
2.1.2.1 Non-Immersive (Desktop) Systems	26

2.1.2.2	Semi-Immersive Projection Systems	28
2.1.2.3	Fully Immersive Head Mounted Display Systems	29
2.2	Types of Virtual Feedback	29
2.2.1	Visual Feedback	30
2.2.2	Auditory Feedback	37
2.2.3	Haptic Feedback	38
2.3	Manual Lifting Review	40
2.4	Review of previous studies	45
2.4.1	Application of Virtual Environments (VEs) in Ergonomics	45
2.4.2	Lower Back Pain (LBP) and Safe Lifting Techniques	48
2.4.3	Simulation of Manual Lifting Tasks	52
2.5	Summary	54
 Chapter 3. Visual Display Feedback for Virtual Lifting		 55
3.1	Previous Work	55
3.2	Visual Display Feedback Simulations for Manual Lifting	66
3.2.1	Method	67
3.2.1.1	Participants	67
3.2.1.2	Experimental set-up	67
3.2.1.3	Experimental procedure	71
3.2.2	Results	77
3.2.2.1	Task Completion Time (TCT)	77
3.2.2.2	Percentage of Harmful Lifts (PHL)	78
3.2.2.3	Response Time to Feedback (RTF)	78
3.2.2.4	Qualitative Visual Feedback Preferences	79
3.2.2.5	Users' comment	83
3.2.3	Discussion	83
3.3	Weight Perception Test	84
3.3.1	Method	84
3.3.1.1	Participants	84
3.3.1.2	Experimental set-up	85
3.3.1.3	Experimental procedure	85
3.3.2	Results	86
3.3.3	Discussion	88

3.4	General Discussion	88
3.5	Summary	89

Chapter 4. Effect of Auditory and Visual Display Feedback on

	Lifting Tasks	90
4.1	Previous Work	91
4.2	Auditory Feedback Simulations	97
4.2.1	Method	99
4.2.1.1	Participants	99
4.2.1.2	Experimental set-up	99
4.2.1.3	Experimental procedure	107
4.2.2	Results	108
4.2.2.1	Task Completion Time (TCT)	108
4.2.2.2	Percentage of Harmful Lifts (PHL)	109
4.2.2.3	Response Time to Feedback (RTF)	109
4.2.3	Discussion	113
4.3	Audio and Visual (AV) Feedback Simulations	113
4.3.1	Method	115
4.3.1.1	Participants	115
4.3.1.2	Experimental set-up	115
4.3.1.3	Experimental procedure	116
4.3.2	Results	116
4.3.2.1	AV Feedback –Pitch and COMBI	116
4.3.2.2	AV Feedback –Pitch and Colour	121
4.3.2.3	AV Feedback –White-noise and Combi	125
4.3.3	Discussion	129
4.4	General Discussion	130
4.5	Summary	131

Chapter 5. Tactile Augmentation and Training Effect

5.1	Previous Work	133
5.1.1	Haptic Feedback	133
5.1.2	Virtual Training Effect	138

5.2	Trials Using Real Weighted Objects	139
5.2.1	Method	140
5.2.1.1	Participants	140
5.2.1.2	Experimental set-up	140
5.2.1.3	Experimental procedure	142
5.2.2	Results	144
5.2.3	Discussion	147
5.3	Effect of Training on Learning Curve	148
5.3.1	Method	148
5.3.1.1	Participants	149
5.3.1.2	Experimental set-up	149
5.3.1.3	Experimental Procedure	149
5.3.2	Results	151
5.3.3	Discussion	160
5.4	General Discussion	161
5.5	Summary	163
Chapter 6. Conclusions and Future Work		165
6.1	Contributions	165
6.2	Conclusions	168
6.3	Future Work	171
Appendix A		173
Appendix B		175
Appendix C		180
Appendix D		182
Appendix E		185
Appendix F		187
Appendix G		190
Appendix H		192
Appendix I		194
References		197

LIST OF FIGURES

Chapter 2

Figure 2.1	: User wearing VR peripherals	12
Figure 2.2	: The inputs, processes and outputs in a generic VR system	16
Figure 2.3	: An example of auditory application in VR environment	16
Figure 2.4(a)	: User wearing HMD	19
Figure 2.4(b)	: Key optical factors in HMD design.	19
Figure 2.5	: Pictures of various types of projection-based display in VR	22
Figure 2.6	: A diagram of a CAVE environment	22
Figure 2.7	: Diagrammatic description of stereopsis	24
Figure 2.8	: Examples of visualization techniques	36
Figure 2.9	: Simplified representation of a "virtuality continuum"	40
Figure 2.10	: Graphic Representation of Hand Location	44
Figure 2.11	: Figure (a) and (b) depicted the spinal column of human	50
Figure 2.12	: Demonstration of a stooped posture	50
Figure 2.13	: Preferred area for handling materials	50

Chapter 3

Figure 3.1	: An illustration of the high- and low-fidelity virtual hands	62
Figure 3.2	: Two separate viewing regions for left and right images	62
Figure 3.3	: Image creation and delivery	64
Figure 3.4	: Geometric perceived depth for positive (1), and negative, (2), screen disparity	65
Figure 3.5	: System Architecture	70
Figure 3.6	: Schematic representation of shelving position	73
Figure 3.7	: Flow diagram for Visual Display Feedback techniques	74
Figure 3.8	: User conducting an experiment for Colour Feedback	75
Figure 3.9	: An experiment for Text Feedback	75
Figure 3.10	: Example snapshot for Combined Colour and Text feedback technique resulting in a Safe lift	76

Figure 3.11	: Task Completion Time for Visual Display Feedback Techniques	80
Figure 3.12	: Percentage of Harmful Lifts for Visual Feedback Techniques	80
Figure 3.13	: Response Time to Feedback for Visual Feedback Techniques	81
Figure 3.14	: Qualitative results of Feedback Preferences	82
Figure 3.15	: Percentage of Weight Perception Test	87

Chapter 4

Figure 4.1	: System Architecture	102
Figure 4.2	: Snapshots of Sound Files for White-noise Feedback	104
Figure 4.3	: Snapshots of Sound Files for Pitch Feedback	105
Figure 4.4	: Snapshots of Sound Files for Tempo Feedback	106
Figure 4.5	: Task Completion Time for Auditory Feedback Techniques	111
Figure 4.6	: Percentage of Harmful Lifts for Auditory Feedback Techniques	111
Figure 4.7	: Response Time to Feedback for Auditory Feedback Techniques	112
Figure 4.8	: Task Completion Time (TCT) for Sole and Mixed Feedback Techniques	119
Figure 4.9	: Percentage of Harmful Lifts (PHL) for Sole and Mixed Feedback Techniques	119
Figure 4.10	: Response Time to Feedback (RTF) for Sole and Mixed Feedback Techniques	120
Figure 4.11	: Task Completion Time (TCT) for Sole and Mixed Feedback Techniques	123
Figure 4.12	: Percentage of Harmful Lifts (PHL) for Sole and Mixed Feedback Techniques	123
Figure 4.13	: Response Time to Feedback (RTF) for Sole and Mixed Feedback Techniques	124
Figure 4.14	: Task Completion Time (TCT) for Sole and Mixed Feedback Techniques	127
Figure 4.15	: Percentage of Harmful Lifts (PHL) for Sole and Mixed Feedback Techniques	127
Figure 4.16	: Response Time to Feedback (RTF) for Sole and Mixed Feedback Techniques	128

Chapter 5

Figure 5.1	: Task Completion Time between Virtual Weight and Real Weight	146
Figure 5.2	: LI value between Virtual Weight and Real Weight experiment	146
Figure 5.3	: LI values between Training and Test phases	154
Figure 5.4	: Mean of LI values between Training and Test phases	154
Figure 5.5	: Frequency of Lifting Index – Training Phase	155
Figure 5.6	: Frequency of Lifting Index – Test Phase	155
Figure 5.7	: Task Completion Time According to Trial Number - Training and Test Phase	156
Figure 5.8	: Average of Task Completion Time - Training and Test Phase	156
Figure 5.9	: An example of Training Phase	157
Figure 5.10	: An example of Test Phase	157
Figure 5.11	: An example of a learning curve for Training Phase (2 kg)	158
Figure 5.12	: An example of a learning curve for Test Phase (2 kg)	158
Figure 5.13	: Details of learning curve for various lifting zones	159

LIST OF TABLES

Chapter 2

Table 2.1	: Qualitative performance of different VR systems	27
Table 2.2	: Criteria levels for low, medium risk and high risk lifting condition	49

Chapter 3

Table 3.1	: Virtual Feedback Preferences (in percentage)	81
-----------	--	----

Chapter 4

Table 4.1	: Auditory Feedback: Speech and Non-speech comparison	96
Table 4.2	: Specification of Auditory Feedback Techniques	103
Table 4.3	: Detail of sound files for each category of auditory feedback	103
Table 4.4	: Combined Audio-Visual (AV) Feedback Techniques	114

Chapter 5

Table 5.1	: Definitions of Terminology	134
Table 5.2	: Feedback Classification	136
Table 5.3	: Details of Colour and Text Feedback	142

ABBREVIATIONS

2D	:	Two Dimensional
3D	:	Three Dimensional
A	:	Asymmetry Angle
A/P	:	Anterior/Posterior
AM	:	Asymmetry Multiplier
ANOVA	:	Analysis of Variance
API	:	Application Programming Interface
AV	:	Audio-Visual
BOOM	:	Binocular Omni-Orientation Monitor
CAD	:	Computer Aided Design
CAVE	:	Cave Automatic Virtual Environments
CM	:	Coupling Multiplier
CRT	:	Cathode Ray Tube
D	:	Vertical Travel Distance
DM	:	Distance Multiplier
F	:	Lifting Frequency
FM	:	Frequency Multiplier
FOB	:	Flock Of Birds
FOV	:	Field Of View
GPD	:	Geometric Perceived Depth
GUI	:	Graphical User Interface
H	:	Horizontal Location
HCI	:	Human Computer Interaction
HM	:	Horizontal Multiplier
HMD	:	Head Mounted Display
HRTF	:	Head Related Transfer Function
Hz	:	Hertz

IG	:	Image Generator
IOD	:	Inter-Optical Distance
IPD	:	Inter-Pupillary Distance
ISD	:	Inter-Screen Distance
LBP	:	Lower Back Pain
LCD	:	Liquid Crystal Display
LC	:	Load Constant
L	:	Load Weight
LI	:	Lifting Index
MMH	:	Manual Material Handling
MR	:	Mixed Reality
NIOSH	:	National Institute for Occupational Safety and Health
<u>P</u>	:	Probability value
PHANTOM	:	Personal Haptic Interface Mechanism
PC	:	Personal Computer
PHL	:	Percentage of Harmful Lifts
PMU	:	Physical Mock-up
RTF	:	Response Time to Feedback
RWL	:	Recommended Weight Limit
SGI	:	Silicon Graphics Inc.
SSC	:	Short Symptoms Checklist
TCT	:	Task Completion Time
V	:	Vertical Location
VDU	:	Visual Display Unit
VE	:	Virtual Environments
VM	:	Vertical Multiplier
VMU	:	Virtual Mock-up
VR	:	Virtual Reality

Chapter 1

Introduction

1.1 Preliminaries

This chapter provides a brief overview of the research presented in this thesis. The background work of this research area is first reviewed. The research statement, objectives and hypotheses are then outlined. Finally, the layout of the remaining structure of the thesis is presented.

1.2 Background

Virtual Reality (VR) is an emerging technology that can teach people how to perform new procedures or techniques. It can help to increase their level of competence in real-time before performing the actual real-world tasks. VR offers substantial benefits in many different application areas. This is one of the main reasons why it has attracted so much interest. It is widely used to manipulate and explore data in ways that were not possible before.

A Virtual Environment (VE) is a computer generated 3D world, where people can interact intuitively in real-time with the environment or objects within it and with a sense of “being there”. Various configurations of VR technology make matching the user to the technology an extremely complex task. The growth of virtual VR

interfaces has led to the need for a new Human Computer Interaction (HCI) medium with the ability to present the ideal interfaces between the user and a synthetic computer generated environment in terms of design, evaluation and implementation. The level of difficulty of user performance can be measured to provide stimuli that are achievable, while the re-training opportunity can be repeated in learning trials which gradually increase the complexity of the tasks while decreasing the support and feedback provided by the experimenter.

VEs also benefit ergonomic activity, which involves workplace layout, interface design, procedures of testing, education and the training of people in a virtual world before the real work takes place. One of the ergonomic areas where VEs can be adopted is Manual Material Handling (MMH), which includes activities like lifting, pushing, pulling and carrying. Manual lifting activities usually cause lower back injury if the lifter does not lift the object in a proper way. The importance of training is crucial to prevent lower back injury. Lower back pain (LBP) and injuries attributed to manual lifting activity continue to be one of the major occupational health and safety issues. About 2.5 million people in Britain experience chronic back pain at some point in their lives. This results in more than 80 million days off work and costs more than £1.6 billion every year, with more than a million GP referrals [Times, 2004].

Even though some research has been carried out on lifting techniques, very little is known about providing multimodal feedback to the lifter on the performance of the lifter in real-time. Providing training alone has only a limited potential for the prevention of back injury. Various possible feedback cues need to be considered

when choosing the best method of feedback techniques to train users in VEs. This research is therefore aimed at providing a training session with multimodal feedback techniques that informs the user of their lower back condition whilst performing a lifting task in a VE.

1.3 Research Statement and Objectives

This study addresses the problem of minimising the potential for lower back injury for users performing manual lifting in VEs and providing multimodal virtual feedback techniques. The training requirements are studied to quantify the trials needed for the user.

Several types of feedback technique were considered for integration with lifting simulation in VEs to inform the user of their performance in real-time. The objectives of this research work are to:

- Investigate the best method of visual display feedback in VEs. Those selected were Colour, Text and Combined Colour and Text (Combi) techniques as a cue to the user.
- Investigate the understanding of visual cues. This was undertaken by determining the understanding of visual cues for various virtual weights provided by conducting a weight perception test. This study varies the virtual weights without the knowledge of the user and evaluates whether or not the

user can differentiate the virtual weight applied according to the feedback given.

- Investigate the effect of auditory feedback techniques in VEs. The most effective multiple sound feedback which could be used in combination with visual and auditory feedback was investigated. Three auditory feedback techniques were tested, Pitch, White-noise (WN) and Tempo.
- Investigate the combination of audio-visual (AV) feedback in VEs. The most effective combination of AV feedback was explored by comparing three AV couples, Pitch-Combi, Pitch-Colour and WN-Combi.
- Investigate the effect of tactile augmentation in VEs. Tactile cues were offered to the user by introducing real-weighted objects. The comparison was made with a technique without tactile augmentation.
- Examine the lifting trajectory. The learning curve of users' lifting performance was observed in training sessions dealing with virtual feedback. The study also investigated the guideline of training requirements and the impact it has on the user during the learning process.

1.4 Research Hypotheses

There were several hypotheses related to the above mentioned objectives:

1. Lifting performance in VEs would be better achieved with the aid of a visual display feedback rather than without a visual display feedback.
2. Multiple display feedback would give the user better cues as they can see the changes in colour as well as monitor their Lifting Index (LI) value in more detail.
3. Users will be able to determine the weight by evaluating the visual display feedback provided to them in real-time. The three various weights used would look different in a visual display to the users.
4. Auditory feedback will enhance lifting performance when compared to lifting without sound feedback. Users will be able to follow the sound feedback easily as less attention can be given to a visual display.
5. Users will find AV feedback more useful as it combines both visual and auditory feedback, so that they have option to choose which feedback to follow depending on their preference when compared to a singular feedback, i.e. auditory or visual only.
6. The introduction of tactile augmentation will enhance user performance as it will feel more natural and increase the feeling of realism. However, the user may take longer to finish the tasks when compared to lifting only the virtual weight.

7. A user will find a self-training session is not too demanding since the feedback provided is clear and easy to understand even though no verbal explanation is given beforehand.
8. According to study conducted by previous researchers, ten trials will be sufficient to train users to perform a manual lift in order to minimise the forces acting on their lower back.

1.5 Outline of the Thesis

This thesis consists of six chapters. Chapter 2 describes existing research relevant to the work reported in this thesis. It includes details about VEs technology, software and hardware requirements. Various types of VR system and the feedback cues provided are also discussed. Revision on MMH, specifically lifting activity and ergonomic simulation, is then presented.

Chapter 3 evaluates visual feedback techniques in manual lifting tasks. Various types of visual cue have been assessed including a combination of them. The evaluation is made based on the experiments conducted with a sample of participants to determine which were the best visual feedback cues in helping people to perform manual lifting tasks safely. The participants are also tested to determine whether or not the visual display cues are understandable by lifting an object with various weights.

Chapter 4 studies the effectiveness of multimodal feedback cues to aid manual lifting training simulations. This chapter consists of two experiments. The first is applying

purely sound feedback to the participants in real-time while performing the tasks. Three types of sound category were evaluated. The second experiment is the combination of visual and auditory feedback cues. Techniques have been experimentally evaluated by combining these two cues according to the results obtained from earlier experiments. This experiment also investigates three types of combination of visual and auditory feedback.

Chapter 5 introduces a tactile augmentation/real haptic by having real weighted objects in VEs to create tactile cues for the participants. The effectiveness of real haptic feedback is determined by comparing the performance of the participants lifting with and without tactile augmentation. The performance is measured in terms of time to perform the lifting tasks as well as the LI values which provide the information about the forces on the user's lower back in real-time. This chapter also describes in detail the lifting trajectory during training simulations. The participants conducted a Self-Training Phase, followed by a Test Phase. The graphical results of the evaluation are reported and suggestions on training requirements are also presented.

Chapter 6 outlines the conclusion of the research and highlights the contribution made by this study. Recommendations for future research are also given.

Chapter 2

Virtual Environment Considerations for Manual Material Handling

Lower back pain (LBP) and injuries attributed to manual lifting activities continue as one of the leading occupational health and safety issues. Even though much effort has been invested in control, including programs directed both at workers and jobs, work-related back injuries still account for a significant proportion of human suffering and economic cost to this nation [Waters et al., 1994].

The potential of Virtual Reality for disseminating knowledge about the ergonomic design of work systems has been investigated [Jayaram et al., 1999; Wilson, 1999; Shaikh et al., 2004; Whitman et al., 2004; Hartvigsen et al., 2005]. Studies included user side and after effects in VEs and the appropriateness of the VR hardware and software as well as factors that affect user performance.

This chapter gives an overview of the technologies required to simulate ergonomic virtual lifting and identifies background literature relevant to the work presented in this thesis. First, the technologies of Virtual Environments (VEs), which include the hardware and software, are reviewed. This is followed by an elaboration of the types of possible feedback that can be received by the user in VEs. Then the question of Manual Material Handling (MMH) will be covered in general and details of one of the MMH task, which is “Lifting”, will be explained with the aid of a few figures. Finally, the chapter gives a review of previous work done on VE Applications, Safe

Lifting Techniques and Simulation of Manual Lifting Tasks which guided this research.

2.1 Virtual Environment Technology

Virtual Reality (VR) has rapidly emerged as one of the most exciting developments in Computer Science and Engineering. There are many different definitions of Virtual Reality. The term “Virtual Reality” was first coined by Jaron Lanier back in 1989, referring to a computer-generated, interactive, 3D environment [Machover and Tice, 1994].

Warwick et al. [Warwick et al., 1993] described VR as “the science of integrating man with information. It consists of three-dimensional, interactive, computer generated environments. These environments can be models of real or imaginary worlds. Their purpose is to represent information through synthetic experiences. Conceptualisation of complex or abstract systems is made possible by representing their components as symbols that give powerful sensory cues, related in some way to their meaning”.

In general, Virtual Reality or Virtual Environment (VE) is an artificial environment created with computer hardware and software, and presented to the user in such a way that it appears and feels like a real environment. Users need to wear special devices through which they receive their input from the computer system. In this way, at least three of the five senses are controlled by the computer. In addition to feeding sensory

input to the user, the devices also monitor the user's actions [Kalawsky, 1993; Wexelblat, 1993; Dai, 1997; Vince, 1998].

VR has attracted much interest since it offers huge benefits to many different applications areas, such as [Kalawsky, 1993]:

- *Medical applications*

Computerized 3D human models provide a new approach to research and education in medicine whereby the trainee can practise medical research with realistic looking virtual patients.

- *Teleoperations in hazardous environments*

Workers in hazardous environments such as radioactive, space, or toxic environments can be relocated to the safety of a VR environment where they can handle any hazardous materials without any real danger using teleoperation or telepresence.

- *Virtual cockpits*

A modular workstation which can communicate spherical and spatial awareness of the outside environment and tactical scene to a pilot.

- *Scientific visualization*

A researcher can be provided with immediate graphical feedback during the course of the computations and they have the ability to guide the solution process by closely coupling the computation and visualization processes.

- *Psychiatry*

VR can also be used by therapists, to treat people who are afraid of heights for example.

- *Architectural visualization*

VR can allow the future customer to “live” in his/her new house before it is built and experiment with different lighting schemes, furnishings, or even the layout of the house itself.

- *Design*

Many areas of design are typically 3D as, for example, the design of a car shape, where the designer looks from every possible view.

- *Education and training*

VR promises many applications in simulation and training. Flight simulation is the most common example which requires lower operating costs and is safer to use than a real aircraft.

- *Computer supported cooperative work*

A shared VR environment can also provide additional support for cooperative work.

- *Simulation and ergonomic*

VR is a very powerful tool to simulate new situations, especially to test the efficiency and the ergonomics, i.e. immersive simulation of airports, train stations, metro stations, hospitals, work places, assembly lines, pilot cabins, cockpits, access to the

control panel in vehicles and machines. VR also helps the ergonomist to view a specific work site as a virtual environment from a variety of angles and approaches, thus providing a greater understanding of how the tasks are performed. The following section will discuss the hardware and software used in various VR systems before describing the selection made for ergonomic virtual lifting tasks.

2.1.1 VR Requirement

VR applications have required the development and use of many types of hardware devices. The requirements for creating a VR with equipment such as tracking and input devices, glasses, displays and audio is discussed below, supported with tables and figures and with an explanation of some terminology. Figure 2.1 shows a common setup of Virtual Reality. The subject wears a Head Mounted Display (HMD) and a glove. Above the subject hangs a transmitter. Receivers are placed on both the HMD and the glove.

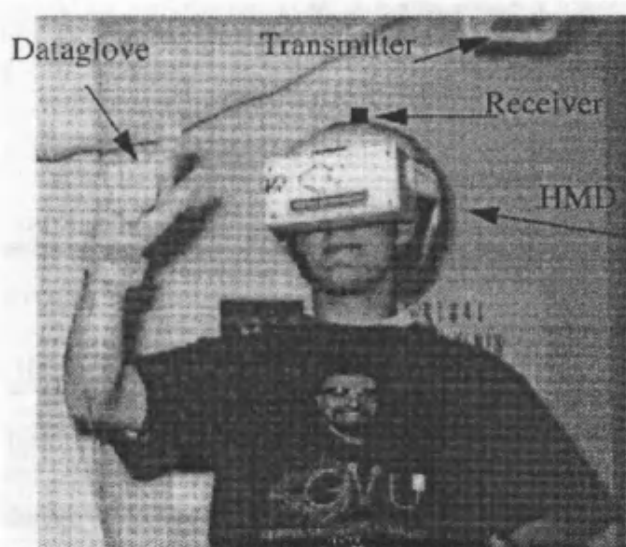

Figure 2.1: User wearing VR peripherals [Hopkins, 2004]

2.1.1.1 Computers

Many types of computers are available today, but every computer has a processing limitation, which ultimately dictates the intricacy of 3D images that they can manipulate. The following are types of computer which are currently used:

- PC – most PCs are fitted with a graphics facility and are able to display simple VEs.
- Graphics workstation – the internal data channels and architecture of a computer graphics workstation provide extra performance when compared to PCs.
- Supercomputer – supercomputers are often used for high-end VR applications and the most common type is manufactured by Silicon Graphics, Inc. (SGI).
- Image Generator – Image Generators (IGs) are specifically designed to produce real-time images and are widely used for civilian and military flight simulators.

2.1.1.2 Tracking

Tracking devices are crucial in VEs as they affect the sense of virtual immersion which can be achieved by some system of position and orientation tracking. Tracking devices determine the x, y and z position and the orientation (yaw, pitch and roll) of some part of the user's body or any other devices in VEs. Six degree of freedom tracking devices make use of various technologies: mechanical, electromagnetic, ultrasonic, infra-red and inertial [Vince, 1998]. Tracking components include

transmitters and receivers, which are used to get information about the place the user occupies in the real world.

2.1.1.3 Input Devices

Interaction devices or input devices serve as portals into virtual reality. Users can interact with the images displayed by using the input devices such as picking up objects or navigating a plane. These input devices include data gloves, 3D mice, joysticks and voice recognition.

2.1.1.4 Output Devices

There are several different types of output devices which allow users to feel certain aspects of the virtual environment. Auditory display, visual display, force and tactile display are among the output feedbacks which users can receive from the VR devices (refer to Figure 2.2).

For auditory displays, traditional VR systems provide them by means of headphones, either integrated into HMD or standard stereo loudspeaker systems. However, audio stimuli are not that common in today's VR applications since modern VR displays do not use HMDs that frequently, as such devices are cumbersome and heavy to wear [Assenmacher et al., 2005]. Instead, CAVE¹-like environments with light-weight glasses are used. These are more comfortable and allow free movement. The use of

¹ CAVE is a registered trademark of the University of Illinois Board of Trustees.

cumbersome audio devices resulted in a lack of user acceptance in audio stimuli due to the need for specialized or costly hardware. Additional libraries are sometimes required to generate sound if the VR software/API do not already contain any audio routines. Figure 2.3 shows an example of auditory application in VR environment.

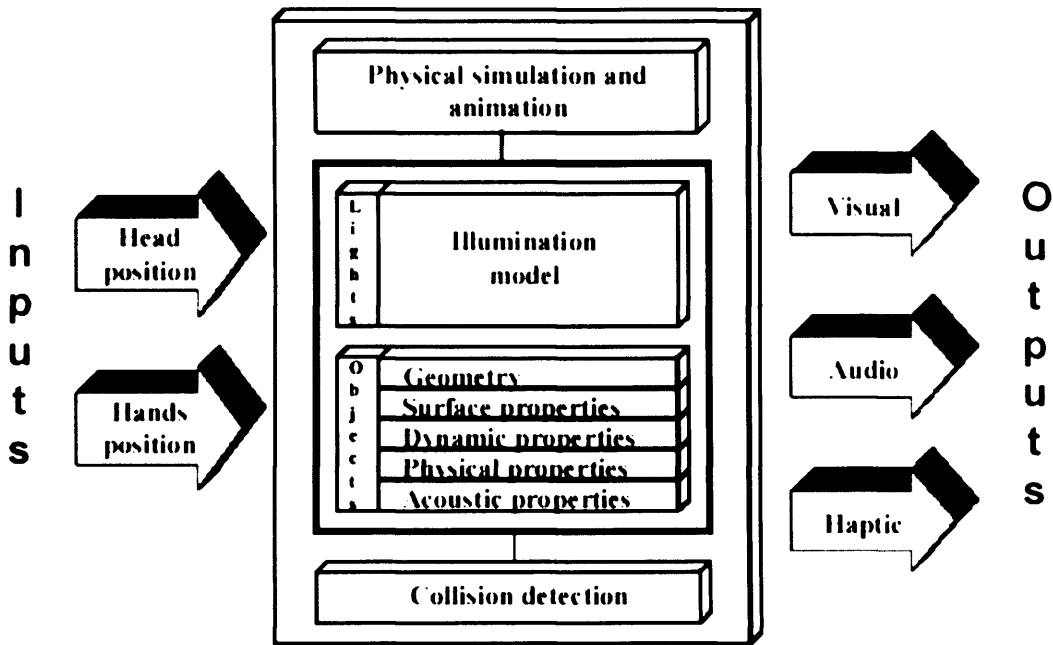

Figure 2.2: The inputs, processes and outputs in a generic VR system [Hopkins, 2004]

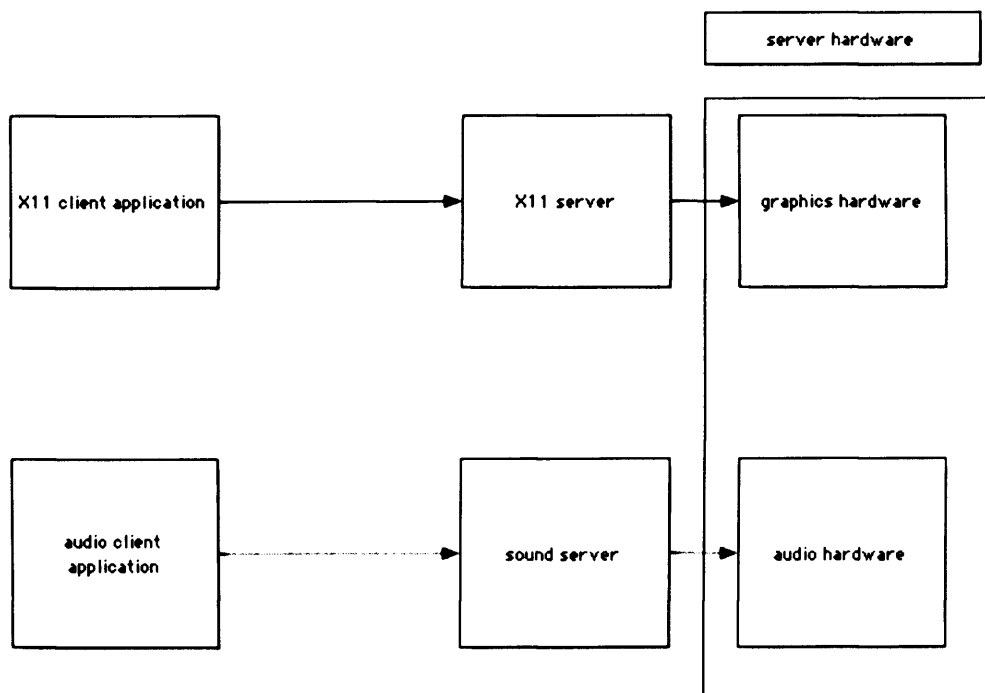

Figure 2.3: An example of auditory application in VR environment [Hmeljak, 2004]

2.1.1.5 Visual Displays

Visual displays are the devices that present the computer generated world to the user. There are several kinds of visual displays available: desktop monitors, Head Mounted Displays (HMDs), Immersedesk, BOOM, CAVE, Monitor ZScreen and projection systems. Each visual interface has a different degree of immersion, field of view (FOV), resolution and update rate. The decision to select the type of visual display used depends much upon the field of application and the side effects of each. The following section describes the display devices commonly used in VR and their system structure.

2.1.1.5.1 Head Mounted Display (HMD)

In 1965 Ivan Sutherland presented a paper “The ultimate display” and three years later demonstrated the first ever working head mounted display [Warwick et al., 1993]. Typical HMD designs consist of a pair of screens with a combination of lenses or mirrors placed in front. The optical system achieves two objectives; it allows the eyes to focus on the screens, which are physically only 50-70 mm away, and increases the field of view of the displayed image. The purpose of using two screens is to allow each eye to see a slightly different view of the displayed scene, thus giving the impression of apparent depth due to the stereoscopic fusion of the images [Howarth and Costello, 1996].

Figure 2.4(a) shows an optical system mounted within a helmet or headset which can be worn by the user. The display screens most commonly used are liquid crystal

displays (LCD), however more expensive systems may use cathode ray tube (CRT) technology as this provides greater resolution. Figure 2.4(b) shows the detailed configuration of HMD. An HMD requires a position tracker in addition to the helmet.



Figure 2.4(a): User wearing HMD [Assenmacher et al., 2005]

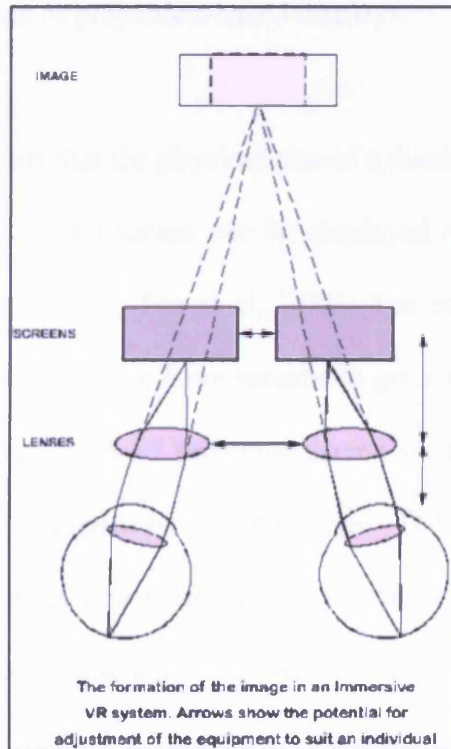

Figure 2.4(b): Key optical factors in HMD design [Assenmacher et al., 2005]

In the configuration shown, part of the image (shaded) is seen binocularly (and hence stereopsis is possible) and part of it is seen monocularly (unshaded). The distance between the eyes is referred to as the Inter-Pupillary distance (IPD), between the lenses is the Inter-Optical Distance (IOD) and between the same point on the two screens is the Inter-Screen distance (ISD) [Howarth and Costello, 1996].

2.1.1.5.2 Projection-based Display

This type of display can be divided into two groups: large screen and ImmersaDesk. There are several types of large screen used for virtual environment display such as flat screen, curved screen, wrap around, CAVE and dome. The ImmersaDesk is a one-screen, drafting-table style device. The user is able to look down as well as forward since the size, position and ability of tilting make adjustment possible. Figure 2.5 shows examples of projection-based displays.

Many research works report that the physical size of a display affects the performance and determines how much information can be displayed on a screen [Swaminathan and Sato, 1997; Wei et al., 2000; Tan et al., 2003; Tan et al., 2004; Tyndiuk et al., 2004]. Therefore, they prefer to use large screens to get a greater sense of immersion in VEs. There are several types of projector screen on the market, including rear projector, front projector and multi projector screens. The author used a large screen (back projected) for this study which enabled the creation of real-world environments by projecting images on a wide screen to provide immersion as well as feedback cues to the user.

2.1.1.5.3 CAVE

The CAVE (Cave Automated Virtual Environment), developed during the early 90's, is a projection based VR system. The CAVE is a stationary, fully immersed room-size VR system [Green, 1997; Massura, 2002; Mortensen et al., 2002]. The user stands in a box with a width and height of about ten feet and images are projected to some walls from the back. CAVE equipment includes projectors and mirrors, stereo glasses, stereo emitters, a wand, tracking systems, audio systems and a workstation. A diagram of the CAVE environment is shown in Figure 2.6.

Much research has been done on visualization in VEs [Howarth and Costello, 1996; Ruddle et al., 1999; Wei et al., 2000; Tan et al., 2004; Tyndiuk et al., 2004; Tyndiuk et al., 2005; Tory et al., 2006]. Tory et al. [Tory et al., 2006] compare 2D displays, 3D displays, and combined 2D/3D displays for relative position estimation, orientation and volume of interest tasks. The findings indicate that 3D displays can be very effective for approximate navigation and relative positioning when appropriate cues, such as shadows, are present. However, they claim that 3D displays are not effective for precise navigation and positioning except possibly in specific circumstances, for example when good viewing angles or measurement tools are available. The results also found that combined displays had a good or better performance, inspired higher confidence and allowed natural integrated navigation.

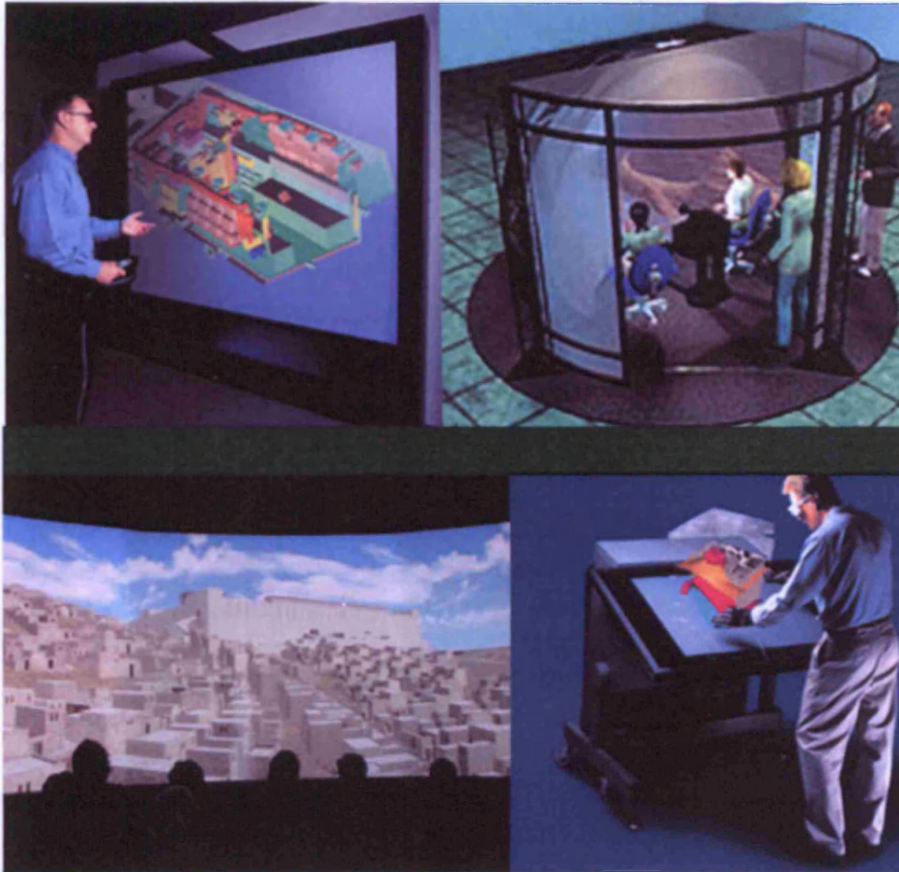

Figure 2.5: Pictures of various types of projection-based display in VR [Tyndiuk et al., 2004]

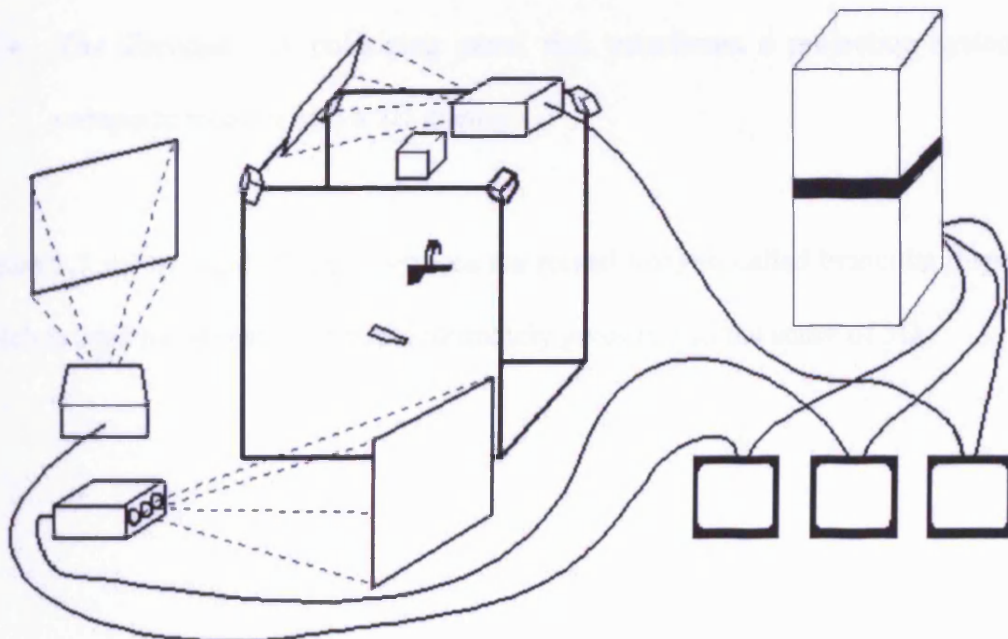

Figure 2.6: A diagram of a CAVE environment [Pape et al., 1997]

2.1.1.6 Stereo Vision

Stereo vision can be accomplished by creating two different images of the computer generated world, one for each eye. The images can be placed side-by-side and projected through differently polarized filters, with corresponding filters placed in front of the eyes [Vince, 1998], in detail:

- **Anaglyph images** - The simplest method to create 3D images which used red/blue glasses to provide a crude (no colour) stereovision.
- **LCD shutter glasses** - Liquid Crystal shutter glasses shut off alternate eyes in synchronization with the two images displayed. The glasses make the left or right-hand lens opaque or transparent using liquid crystal technology. They receive a synchronizing signal from an infrared unit placed on top of the monitor/screen. This switching between images occurs so rapidly that it is undetectable by the user, who fuses the two images in the brain to see one constant 3D image.
- **The Zscreen** - A polarizing panel that transforms a projection system or computer monitor into a 3D display.

Figure 2.7 shows the difference between the retinal images, called binocular disparity, which is used to estimate depth and ultimately gives rise to the sense of 3D.

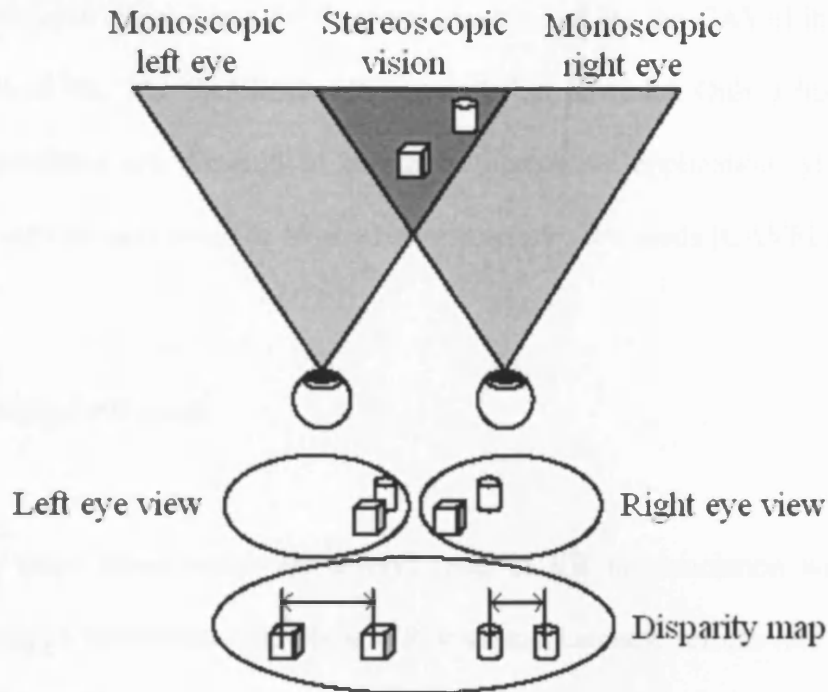

Figure 2.7: Diagrammatic description of stereopsis [Vince, 1998]

2.1.1.7 VR Software

VR software is the key to any successful VR system. The software is very complex as it integrates the areas of 3D geometric databases, rendering, interaction, navigation, 3D tracking, graphics peripherals, sound, human factors, and interface design, all running in real time [Vince, 1998]. Nowadays, users can find a variety of VR software packages in the market place, whether in the form of programs and/or APIs, which are related to VR, graphics, and/or interactive simulation toolkits, for example CAVELib, VEGA, dVISE, MR Toolkit, and SiLVIA.

CAVELib is the most widely used Application Programmer's Interface (API) for developing applications for immersive displays. The philosophy of the CAVELib is to

let the developer concentrate on their application and let the CAVELib handle the difficulties of VR. The CAVELib API is simple but powerful. Only a fraction of the API's capabilities are required to create an immersive application, yet it has an extensive API to meet even the most advanced developer's needs [CAVELib, 2000].

2.1.1.8 Critical VR terms

There are three terms which are always used in VR in association with tracking systems, image generators and whole VR systems: Latency, refresh rate and update rate [Vince, 1998].

- **Latency** - The end-to-end delay between the user's physical movement, and the system's ultimate feedback to the user. Latency of more than 75-100 milliseconds significantly impairs user performance for many interactive tasks.
- **Refresh rate** - The rate at which a computer monitor is redrawn. Sometimes different from the update rate (> 60Hz to avoid flicker [Gupta et al., 1997]).
- **Update rate** – or sometimes called **frame rate**, is the rate at which the image on a computer monitor is changed. Adams et al. [Adams et al., 2001] investigated the effect of display update rates between 14 and 28 frames per second on the manipulation of virtual objects.

2.1.2 Types of VR system

With time, the meaning of VR has broadened and today VR can be classified into three main categories [Costello, 1997]. Each category can be ranked by the sense of immersion, or the degrees of presence it provides [Beier, 2000]. Table 2.1 shows the qualitative performance of different VR systems.

However, Lu et al. [Lu et al., 2002] stated that immersion in VR can be categorised in three groups which were “fully immersive”, “semi-immersive” and “augmented reality”. They specified augmented reality as an extension of a semi-immersion system where important information is available both from the physical and virtual world simultaneously. For example, an aircraft display system which overlays wind speed information on top of the terrain.

2.1.2.1 Non-Immersive (Desktop) Systems

Non-immersive systems are by definition the least immersive implementation of VR techniques. This category is the lowest cost VR solution and can be used for many applications since they do not require the highest level of graphics performance, do not need special hardware and can be implemented on high specification PC clones. However, these systems will always be outperformed by more sophisticated implementations and provide almost no sense of immersion. Interaction with the virtual environment can occur by conventional means such as keyboards, mice and

trackballs or may be enhanced by using 3D interaction devices such as a SpaceBall™, or DataGlove™.

Qualitative Performance			
Main Features	Non- Immersive VR	Semi-Immersive VR	Full Immersive VR
	(Desktop)	(Projection)	(Head-coupled)
Resolution	High	High	Low - Medium
Scale (perception)	Low	Medium - High	High
Sense of situational awareness (navigation skills)	Low	Medium	High
Field of regard	Low	Medium	High
Lag	Low	Low	Medium - High
Sense of immersion	None - low	Medium - High	Medium - High

Table 2.1: Qualitative performance of different VR systems [Kalawsky, 1996]

2.1.2.2 Semi-Immersive Projection Systems

Semi-immersive systems are a relatively new implementation of VR technology, comprising a very high performance graphics computing system which can be coupled with either one of the following:

- A large screen monitor
- A large screen projector system or CAVE (Cave Automatic Virtual Environment)
- Multiple television projection systems

The large screen system has a wide field of view, thereby increasing the feeling of immersion or presence experienced by the user. The images are of far higher resolution when compared to HMDs and could also provide simultaneous experience of VEs.

Separate images are generated for the left and right eye and users wear lightweight glasses to see imagery stereoscopically. In active stereo, the image-generation computer alternates between left and right eye views. Users wear liquid crystal shutter glasses that are synchronized with the display through a signal sent from an emitter attached to the host computer. Generally, only one user's head position is tracked and the view is drawn for that position [Baker and Stein, 1997].

2.1.2.3 Fully Immersive Head Mounted Display Systems

This type of VR system is the most widely known VR implementation, where the user either wears an HMD or uses some form of head-coupled display such as a Binocular Omni-Orientation Monitor - BOOM [Bolas, 1994]. Details of HMDs were discussed in section 2.1.1.5.1. A fully immersive system increases the sense of presence, but this would depend on several parameters including the field of view, the update rate and resolution.

2.2 Types of Virtual Feedback

VR can be considered multi-modal as it can simulate sight, sound and touch, resulting in the feeling of “being there” to the users. This feeling comes from a changing visual display as the users move their head. VEs can be experienced when a user’s senses are cleverly fooled by artificial stimuli. A user will have a perfect feeling of immersion in a virtual world if all senses can be stimulated.

Visual and auditory feedbacks in VEs are well developed and have attracted a great deal of research. Feedback techniques are effective in improving the way the user interfaces with the system, such as using operational related sounds or changing the object’s colour [Takemura and Kishino, 1992]. However, the use of touch feedback is still somewhat behind [Burdea, 1996] and remains in a trial-and-error phase. He added that even though force feedback is not as well established as visual or audio feedback, a number of research centres have developed innovative computer-simulated force feedback techniques.

The discussion for each type of feedback will be presented with an explanation of how the systems processes sensory information, but focuses more on the sound and vision aspect because these two are currently the best researched fields. Some examples of work done by researchers in specific areas of VR applications will also be highlighted.

2.2.1 Visual Feedback

Vision is the most important sense for people. In VR, vision is used to experience the visual environment. Visual feedback can be most easily used to highlight a specific area of the displayed screen. The user's attention can be drawn to a particular object by colouring it differently to the surroundings [Crossan et al., 2000].

Visual feedback can be provided when the user sees a 3D view of the computer generated world by means of a stereoscopic pair of images. The 3D image formed by the two separate views enables the user to estimate depth of objects. Such cues are called stereopsis cues [Vince, 1998]. The visual feedback from the computer generated environment is produced by very complicated tradeoffs between the resolution of the system and the frame rate at which the images are displayed.

Researchers found that in order to achieve optimum performance in VEs, a few characteristics are crucial in visual display: latency (lags), resolution, flicker, refresh rate, frame rate, luminance, resolution, field of view [Boff and Lincoln, 1988; Held and Durlach, 1991; Pausch et al., 1992; Regan and Price, 1993; Edgar and Bex, 1995;

Kolasinski, 1995; Wioka, 1995]. Below are the minimum requirements that have been suggested by those studies:

- Lags - less than 300 ms [Regan and Price, 1993; Wioka, 1995]
- Frame rate - 20 frames per second or higher [Gupta et al., 1997]
(update rate)
- Refresh rate - at least 72 Hz [Vince, 1998]

The user can feel “presence” if the screen update rate is fast and there is minimal lag in the position sensing and display system [Sheridan, 1992; Massimino and Sheridan, 1994; Ware and Balakrishnan, 1994]. Flicker is caused by a too low refresh rate. Flicker in the display has been cited as a contributor to simulator sickness and also contributes to eye fatigue [Pausch et al., 1992; Kolasinski, 1995]. Far fewer people notice flicker at refresh rates above 72 Hz. Wioka has suggested that lags of less than 300 ms are necessary to maintain the illusion of immersion in a virtual reality environment, since with longer lags subjects start to dissociate their movements from the associated image motions [Wioka, 1995].

HMDs for virtual environments facilitate an immersive experience that seems more real than the experience provided by a desktop monitor [Ruddle et al., 1999]; however, the cost of head-mounted displays can prohibit their use. This study also found that there was no significant difference between two types of display (HMD and desktop monitor) in terms of the distance that participants travelled or the mean accuracy of their direction estimates. Witmer and Kline [Witmer and Kline, 1998] found that users tend to underestimate distances in VEs when using HMDs, while a

study done by Ruddle et al. [Ruddle et al., 1999] showed no consistent tendency to either under or overestimate distances.

Despite the fact that HMDs provide users with a full solid angle view of virtual space, its optical system limits the field of view [Iwata, 2004]. Field of view is a measure of the horizontal and vertical visual range of the optical system, and ideally should approach that of the human visual system [Vince, 1998]. The field of view of the human eye is approximately 200 degrees (lateral) and 125 degrees (vertical).

Patrick et al. [Patrick et al., 2000] investigated the differences in spatial knowledge learned for a VE presented in three viewing conditions: HMD, large projection screen and desktop monitor. Their findings showed that users' performance was better achieved in the Screen condition compared to the HMD condition. The results also indicated that the Screen condition is a more consistent and more reliable display method. HMD users also found that this device can be uninviting and the users feel a high level of immersion sickness after using this device. More curiously, all HMD users suffer from a time lag between turning their heads and seeing updated graphics for the new line-of-sight in the HMD. The resulting mismatch between the user's visual perception and sense of physical motion can cause simulator sickness symptoms such as nausea, disorientation, and fatigue.

Many researchers have studied the advantages of large scale projection screens [Péruch et al., 1997; Johnson and Stewart, 1999; Patrick et al., 2000; Tan et al., 2003; Tan et al., 2004; Polys et al., 2005]. Findings from Patrick et al. [Patrick et al., 2000] were consistent with the results from Johnson and Stewart [Johnson and Stewart,

1999] which found no significant difference between an HMD and a projection screen used to train soldiers to navigate an unfamiliar environment. Furthermore, they found that users performed significantly better at remembering maps using a large projection display when compared to a standard desktop monitor. Patrick et al. [Patrick et al., 2000] suggested that the possible reason why the projection screen results outperformed the HMD condition was because the larger image engenders more presence by tricking a person's perceptual systems into thinking they are really there. This phenomenon is normally associated with HMD but not with a flat display. Large projection screen environments have replaced HMDs for most high quality VR installations.

In another study carried out by Péruch et al. [Péruch et al., 1997], users navigated equally well in various field of view conditions which used a large video projector screen. This research suggested that task performance was independent of field of view. However, the influence that the physically large display had in their study was not discussed.

Tan et al. [Tan et al., 2004] compared user performance in 3D navigation on two types of visual display, computer monitor (small display) and LCD projector (large display). Their findings showed that there was a significant main effect on display size with the large display resulting in users having shorter error distance even when the same environments were viewed at equivalent visual angles. They also agreed that large displays provide users with a greater sense of presence within the virtual environment.

Because of the difficulties of developing head-mounted optical systems which cover the whole field of view, and with recent technological advances, large screens are becoming widespread and many HMD designers are now moving away from fully-immersive designs. The above analysis suggests that it is better to use a large screen as a visual display rather than HMD for this research.

As well as choosing the most suitable visual display device, another important factor which needs attention is the type of visual display feedback to be provided for the user in VEs. Previous studies have been conducted to investigate the effectiveness of visual display feedback in order to provide users with cues for certain conditions of the experiment carried out [Infed et al., 1999; Brederson et al., 2000; Lawrence et al., 2000; Lécuyer et al., 2002; Lécuyer et al., 2004]. All their results showed that 3D visualization improved user performance. Other studies conducted by Gerovichev et al. [Gerovichev et al., 2002] compared various types of feedback techniques including combined feedback techniques. The findings suggested that real-time image overlay provides greater improvement in performance than force feedback. By contrast, Swan and Allan [Swan and Allan, 1998] found no advantage in using 3D visualization in their study regarding information retrieval systems. This may be due to the small sample used (i.e., group of 4).

Several types of visual display feedback are prevalent such as text, colour changes, colour flashes, arrows, symbols or colour-coding, which can guide the VR user while manipulating objects in VEs. Research has been conducted on the best combination of text and image for conveying a message, as images make the message easier to remember compared to words alone. However, words are easy and straightforward to

follow. Fischer [Fischer, 1996] suggests that an image is the ideal support for textual information and also noted that it is best to maintain a close proximity of text and graphics. Chandler and Sweller [Chandler and Sweller, 1991] claimed that co-references between text and images can improve the comprehension of complex instructional material, that users found it easier to recall information which integrated text and images. This suggestion was supported by Faraday and Sutcliffe [Faraday and Sutcliffe, 1997] who conducted a study on how the attention and viewing process can be controlled for effective information delivery. They also made suggestions to guide complex presentation by other elements such as labels, symbols or speech.

Bade et al. [Bade et al., 2004] conducted research on different interactive visualization techniques which enable users to reveal the data at several levels of detail. Figure 2.8 shows examples of the visualization techniques that they introduced.

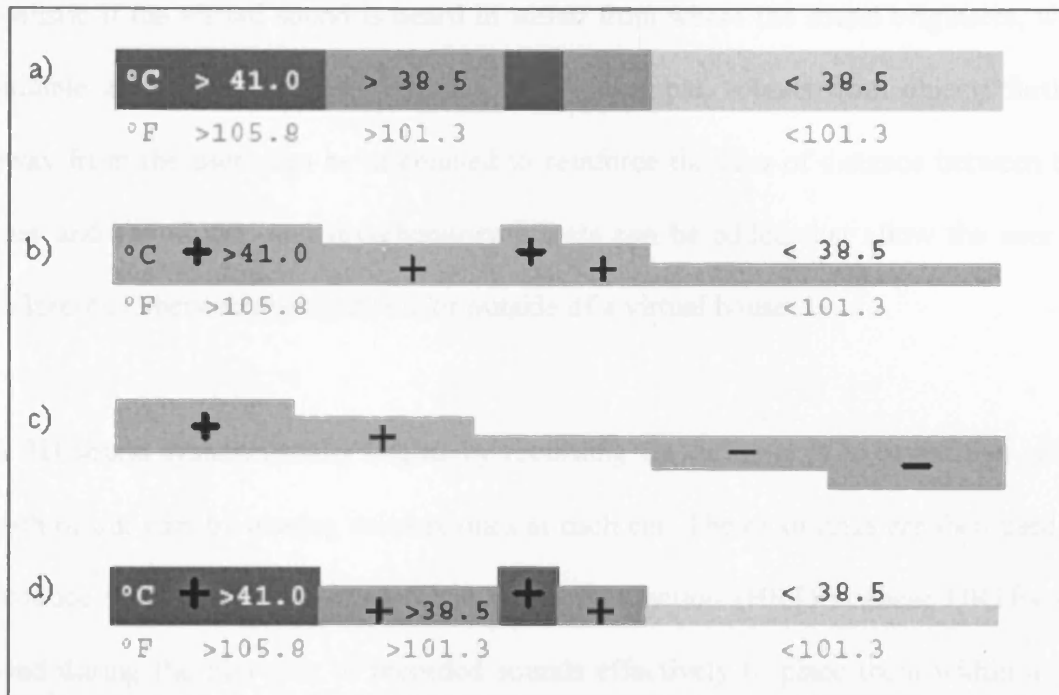

Figure 2.8: Examples of visualization techniques. a) *Colour-coded timeline* representation of a fever curve, b) *Height-coded timeline* representation of the same fever curve as in (a), c) *Height-coded timeline* of critically elevated, normal, reduced and critically reduced qualitative levels, d) Coloured version of the *Height-coded timeline* as in (b) [Bade et al., 2004]

2.2.2 Auditory Feedback

Sound is another human sense that can be generated in VEs to add to the realism experienced by the user. Sound can be produced through suitable speakers. It is more realistic if the virtual sound is heard in stereo from where the sound originates, with suitable amplitude and correct timing. For example, sounds from objects further away from the users can be attenuated to reinforce the idea of distance between the user and the object, and reverberatory effects can be added that allow the user to differentiate between being inside or outside of a virtual house.

A 3D sound system usually begins by recording the differences in sound that reach both of our ears by placing microphones at each ear. The recordings are then used to produce what is called a head related transfer function (HRTF). These HRTFs are used during the playback of recorded sounds effectively to place them within a 3D environment. A virtual sound system requires not only the same sound localization cues but also change and reaction in real time to simulate the movement of those sounds within the 3D environment [Lingard, 1995].

As shown in research conducted by Zhang et al. [Zhang and Sotudeh, 2004; Zhang et al., 2005], the addition of auditory feedback does introduce an improvement in the performance of a virtual assembly task. In Doel et al.'s study [Doel et al., 2001], they describe and simulate the real time interaction of a virtual pebble with a real wok, where the user can experience a realistic responsive auditory feedback such as is expected in real life when touching, sliding, or rolling objects. This increases the

feeling of realism. Other research undertaken in sound for VEs includes Calhoun et al., Blauert and Lehnert, Hahn et al. and Naef et al. [Calhoun et al., 1987; Blauert and Lehnert, 1991; Hahn et al., 1998; Naef et al., 2002].

Barreto et al. [Barreto et al., 2005] investigated the addition of spatial auditory feedback as a tool to assist people with visual impairment in the use of computers, specifically in tasks involving iconic visual search. Unique sounds were mapped to visual icons on the screen. As the cursor traversed the screen, the user would hear the sounds of nearby icons, spatially, according to the relative position of each icon with respect to the screen cursor. The results demonstrated that spatialization of icon sounds provides additional remote navigational information to the users, enabling new strategies for task completion.

2.2.3 Haptic Feedback

Haptic/touch feedback could be used in any aspect of virtual reality where more information can be conveyed by touch than by merely sight and sound alone. Haptic feedback will allow users to feel virtual objects with their finger tips.

Previous technologies which provided a passive touch interface with computers included keyboard, mice and cyberhand. The cyberhand of a VR user would go into or through the virtual object that the user wants to pick up or grab. This may be due to the fact that the created virtual objects have no solidity, no mass and often do not obey the rules of gravity so they float in the air when dropped.

More advanced cyberhands, such as the CyberTouch Glove from Virtex, provide tactile feedback when objects are touched [Brook, 1997]. It accomplishes this by having buzzers that vibrate under the fingertips and palm. This provides the sensation of touching something but it lacks the resistance to motion that is observed when real objects are touched.

The most popular haptic device is PHANTOM (Personal Haptic Interface Mechanism) which has a fingertip thimble that provides force feedback between virtual object and the user. The Phantom interface allows the user to feel the forces of interaction that they would experience when touching a real version of the object with a pencil or the end of their finger.

A major application of haptic feedback will be in training surgeons and in remote surgery. A virtual scalpel can be controlled through a haptic interface, allowing the user to operate on a virtual patient. The operation could be a completely artificial simulation that can be rerun many times until the trainee surgeon has learnt the technique, possibly even with the benefit of feeling how an expert surgeon had carried out the procedure in a previous run of the simulation.

There are two main categories of touch feedback: tactile, for example skin contact, and force, for example the 'solidity' felt when an object resists pressure from our fingers or body. Force feedback in particular could make a significant difference in making the grasping of virtual objects seem real [Aldridge et al., 1996]. Furthermore, most commercially available VR systems do not include tactile or force feedback [Hoffman, 1998].

Hoffman et al. [Hoffman et al., 1996] in their study suggest that tactile augmentation, where the user touches real objects while in virtual reality, is an effective alternative mixed reality technique for introducing tactile cues. Milgram and Kishino [Milgram and Kishino, 1994] defined a Mixed Reality environment as an environment where both real world and virtual world objects are represented together within a single display, that is anywhere between the extremes of the virtuality continuum (Figure 2.9). Many researchers have applied the use of haptic feedback in their work [Sourin et al., 2000; Stone, 2000; Mendoza and Laugier, 2003; Pagarkar, 2004; Shen et al., 2005].

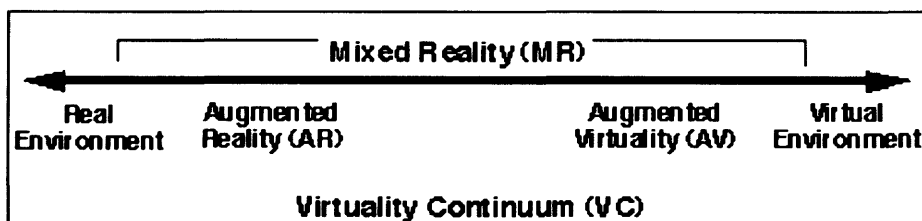

Figure 2.9: Simplified representation of a "virtuality continuum" [Milgram and Kishino, 1994]

2.3 *Manual Lifting Review*

Manual Material Handling (MMH) involves lifting, lowering, pushing, pulling and carrying objects by hand. In the UK, 27% of all reported accidents involved manual handling [Temple and Adams, 2000]. All these tasks have the potential to result in some adverse health effects, from simple cuts, bruises, and sore muscles to more serious conditions related to lower back pain (LBP). Based on available statistics, almost half of all lower back injuries are related to lifting, about another 10 percent are associated with pushing and pulling activities and another 6 percent occur while holding, wielding, throwing, or carrying materials [Randall, 1997].

Lower back pain and injuries attributed to manual lifting activities are among the leading occupational health and safety issues facing preventative medicine [Klein et al., 1984; Waters et al., 1994; Kuiper et al., 1999]. Ergonomic lifting is crucial to avoid LBP and other injuries. The Board of Certification for Professional Ergonomists defined ergonomics in 1993 as: "... a body of knowledge about human abilities, human limitations, and human characteristics that are relevant to design. Ergonomic design is the application of this body of knowledge to the design of tools, machines, systems, tasks, jobs, and environments for safe, comfortable, and effective human use" [Marmorstein, 2002]. Much research has been conducted on lifting techniques [Marley and Duggasani, 1996; Hsiang et al., 1997; Burgess-Limerick and Abernethy, 1998; Rabinowitz et al., 1998; Bobick et al., 2001; Lariviere et al., 2002]

In 1981, the National Institute for Occupational Safety and Health (NIOSH) recognized the need for increased attention in work-related back injuries and published the "Work Practices Guide for Manual Lifting". A revision was published in 1991 entitled "Scientific Support Documentation for the Revised 1991 NIOSH Lifting Equation". A final lifting equation was published as the "Revised NIOSH Equation for the Design and Evaluation of Manual Lifting Tasks" in 1993. The revised NIOSH equation is primarily concerned with the application of ergonomic measurements and equations for the protection of workers employed in a wide range of lifting tasks [Temple and Adams, 2000].

The Recommended Weight Limit (RWL) is the principal product of the revised NIOSH lifting equation. The RWL is defined for a specific set of task conditions as the weight of the load that nearly all healthy workers could perform over a substantial

period of time (typically up to 8 hours) without an increased risk of developing lifting-related LBP. The Lifting Index (LI) is a term that provides a relative estimate of the level of physical stress associated with a particular manual lifting task. The estimate of the level of physical stress is defined by the relationship of the weight of the load lifted and the RWL [Waters et al., 1994].

The RWL is defined by the following equation:

$$RWL = LC \times HM \times VM \times DM \times AM \times FM \times CM \quad (\text{Eqn. 2.1})$$

Where:

LC = load constant (23 kg)

HM = horizontal multiplier (25/H)

VM = vertical multiplier (1-(0.003*|V-75|))

DM = distance multiplier (0.82 + (4.5/D))

AM = asymmetric multiplier (1-(0.0032*A))

FM = frequency multiplier

CM = coupling multiplier (good (1); fair (0.95); poor (0.9))

See Figure 2.10 for details of graphic representation of hand location, and Appendix A to find suitable values for H, V, D and A [Waters et al., 1994]. An example of the calculation of RWL and LI were also included in Appendix A.

The LI is defined by the following equation:

$$LI = \frac{\text{LoadWeight}}{RWL} = \frac{L}{RWL} \quad (\text{Eqn. 2.2})$$

It is commonly accepted that it is better to lift with the legs (squat lifting) than with the back (stoop lifting), as this will reduce the compression loading and ligament

strain within the spine [Garg and Herrin, 1979; Leskinen et al., 1983; Anderson and Chaffin, 1986; Chow et al., 2005].

Squat lifting involves a higher metabolic energy expenditure and lower effectiveness than stoop lifting [Kumar, 1984; Zhu and Zhang, 1990]. Details of the types of manual lifting and safe lifting techniques will be discussed in section 2.4.2 on page 48. The lifting task has been studied and simulated dynamically [Marras et al., 2004] and analysed in 3D using a kinetic model [Nalgirkar and Mital, 1999]. Several researchers [Hathiyari et al., 2003; Whitman et al., 2004] made an effort to compare the results of an experiment performed in a virtual environment with those from a real environment. The task was moving the boxes from one table to another, having the same height, and again to a table with a different height. Their results showed that VR can be compared to a similar experimental task in the real environment if it involves measuring only a range of movements and not velocities or accelerations. This is evidently because the participant moves more slowly in VR as compared to the real environment. Possible factors that affected their performance were that lag occurred when observing motion with HMD, and that the HMD used was monographic. This meant that the user viewed just two dimensional graphics and would not have been able to perceive depth and would not therefore have been sure of the destination position.

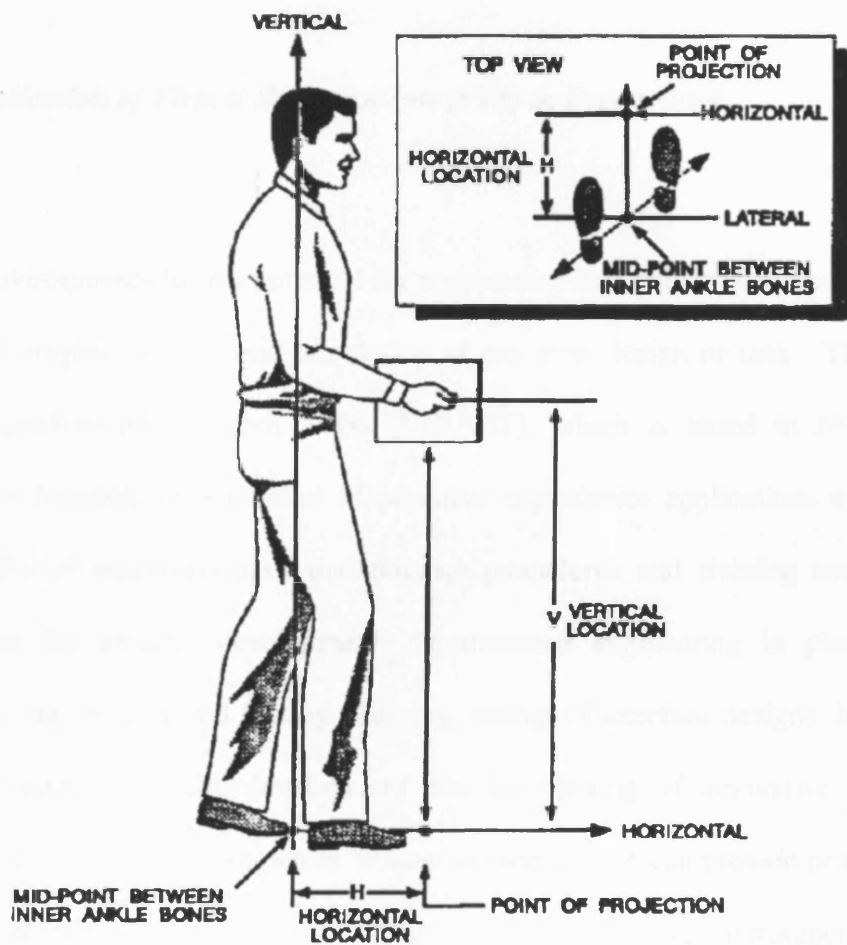

Figure 2.10: Graphic Representation of Hand Location [Waters et al., 1994]

2.4 *Review of previous studies*

The following section reviews previous studies which relate to this research area: VE applications in ergonomics, lifting techniques and LBP, and simulations for manual lifting.

2.4.1 *Application of Virtual Environments (VEs) in Ergonomics*

Virtual Environments have a potential for ergonomics as it enhances job performance, training, workplace design and simulation of any new design or task. The Virtual Reality Applications Research Team (VIRART), which is based in Nottingham, carried out research on a number of potential ergonomics applications of VR/VE. These included examination of maintenance procedures and training needs, rapid prototyping for product development, simultaneous engineering in planning for manufacturing, process and factory planning, testing of interface designs, housing or building layout, procedure development and the piloting of innovative education media [Wilson, 1999]. As shown in Wilson's research, VR can provide practical and widely accepted re-design solutions, a healthy and safe working environment, yet one that enables all users to understand the proposed solutions and to contribute to their refinement. The users also feel a sense of "being present in" the new layouts and were judged more able and motivated to contribute to a greater degree than if faced by architects' drawings.

A benefit of VEs is that the user does not need to be totally involved to complete the tasks. VEs can also be used for ergonomic analysis purposes to compare user performance in VEs and in the real world. [Whitman et al., 2004]. Shackel [Shackel, 2000] claim that VR is a proven tool to assist the ergonomist in design, where this could be cost-effective.

Virtual Reality technology is very important in the design process of an advanced human machine interface, such as aircraft cockpits. It is a complex communication tool between a user and a machine. Its efficiency is linked to its quality, ergonomics and suitability. Traditionally, these mock-ups are physical: they need time to be developed and are expensive. The use of virtual mock-ups (VMU), with the help of Virtual Reality tools, instead of physical mock-ups (PMU) is greatly advantageous, in terms of communications between different disciplines, time savings and lower costs [Mérienne et al., 2005]. The interface of the cockpit can be tested very early during the design and development process.

Another field in the aircraft industry which needs VR application to enhance task performance is for the training of those involved in aircraft inspection. The aircraft maintenance industry is a complex system consisting of several interrelated human and machine components. The research performed by Vora et al. [Vora et al., 2002] on human factors in the maintenance arena has focused on aircraft inspection with appropriate training tools and environments. Their findings indicate that VR systems have the potential for use as off-line training tools for aircraft visual inspection tasks. They have also claimed that the use of VR-based inspection environments will

facilitate controlled studies off-line and the understanding of human performance in aircraft inspection, thus improving aviation safety.

Dezelic et al. [Dezelic et al., 2005] study how the users (in this case, the miners) would be able to handle bolting equipment in rock bolting (one of the most dangerous mining jobs) practices by using a training program based on virtual reality before actually heading into the mine. Shaikh et al. [Shaikh et al., 2004] studied the integrated use of simulation tools in real time for participatory occupational ergonomic studies which used a commercial human modeling simulation called Jack_{TM}. The user performs the task naturally in an immersive environment, while the body posture information is continuously and automatically passed to the human modeling system for a continuous analysis of the participatory ergonomic issues under consideration.

Virtual humans can provide economic benefit by helping designers early on in the product design phase to produce more human-centered equipment, assembly lines, manufacturing plants, vehicles, interactive systems, surgical planning, remote telemedicine, training aids, virtual experiences and even teaching and mentoring [Badler et al., 1993]. Amos [Amos, 2001] made a comparison of techniques providing feedback in Post-Event (giving feedback after the completion of the task) and real-time (giving feedback during the task) to the user carrying out manual lifting tasks. Simulations in virtual reality will be able to provide users with a pool of data when used appropriately and to its fullest potential. One advantage of virtual reality is that users do not have to be totally involved to complete the tasks [Kaber et al., 2005].

2.4.2 Low Back Pain (LBP) and Safe Lifting Techniques

Low Back Pain (LBP) is often described as a sudden, acute, persistent, or dull pain felt below the waist. LBP is very common and affects the majority (80%) of people at some point during their life. Understanding the basics of LBP requires knowledge of the forces of compression strength of the L5/S1 disc. [Hsiang et al., 1997].

The basis of the NIOSH lifting equation is that the predicted maximum compressive forces on the L5/S1 disc should not exceed, in general 3400 N for nominal risk to most workers, while 6400 N of compressive force is defined as the maximum permissible limit during lifts. These recommendations were based on results from compressive tolerance and force predictions made by means of a static biomechanical model [Lindbeck and Arborelius, 1991]. Figure 2.11(a) shows the spinal column in which five lumbar can be seen at the bottom part of the vertebrae. Figure 2.11(b) focuses on the detailed view of vertebrae affected by LBP.

Lifting technique has been categorized into three groups according to the posture adopted just before the load is lifted. The first technique is a stooped posture, where the knee joints are almost fully extended and the hip joints and vertebral column are flexed to reach the load (see Figure 2.12(a)). The second lifting technique is a full squat, in which the knee joints are fully flexed and the trunk is held as vertical as possible (see Figure 2.12(c)). The other technique is a semi squat which is in between the two techniques mentioned earlier. Figure 2.12(b) shows a user performing a semi-squat lifting technique [Burgess-Limerick, 2003; Straker, 2003]. Squat lifting is

widely regarded as the ‘correct’ technique for lifting low-lying objects [Straker, 2003].

Pheasant [Pheasant, 1996] illustrates in Figure 2.13 the preferred area for handling materials and categorizes zones which are not preferred. Note that the worst scenario is above shoulders, below knees and anything more than a forearm’s length distance from the body.

Swinkels-Meewisse et al. [Swinkels-Meewisse et al., 2006] stated that an episode of acute LBP was defined as LBP with a duration of at most four weeks with a pain free period of at least three months preceding the current episode. Three lifting guidelines have been summarized by Ferguson et al. [Ferguson et al., 2005] indicating safe, medium risk and high risk for lower back pain patients in a study comparing the spine loads. Two types of dependent measure were observed: spine loading, consisting of spine compression, lateral shear, anterior/posterior (A/P) shear, and capacity, which indicated the percentage of each group able to perform each task. Details of the guidelines are tabulated in Table 2.2.

	Compression	A/P shear	% Completing task
Low Risk	< 3400N	< 750N	> 75%
Medium Risk	3400N < x < 6400N	750N < x < 1000N	25% < x < 75%
High Risk	> 6400N	> 1000N	< 25%

Table 2.2: Criteria levels for low, medium risk and high risk lifting condition [Ferguson et al., 2005]

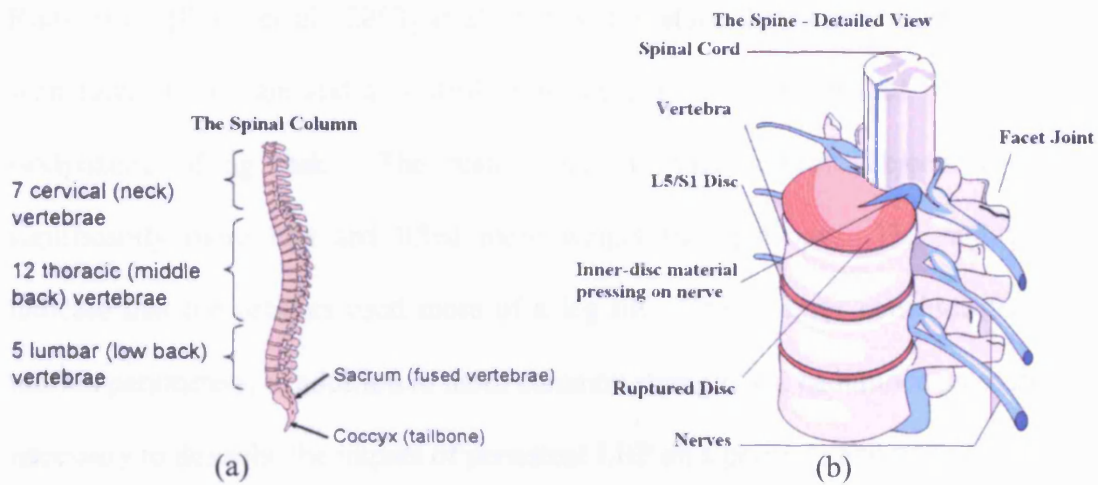

Figure 2.11: Figure (a) and (b) depicted the spinal column of human [Lindbeck and Arborelius, 1991]

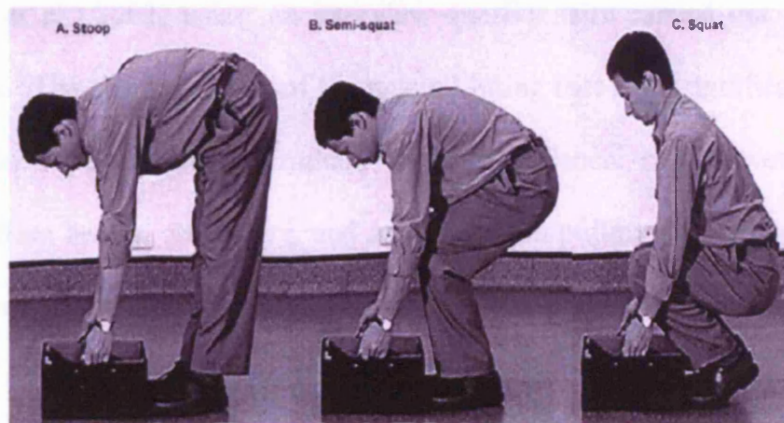

Figure 2.12: Demonstration of a stooped posture (A), a semi-squat posture (B), and a full squat posture (C) [Burgess-Limerick, 2003]

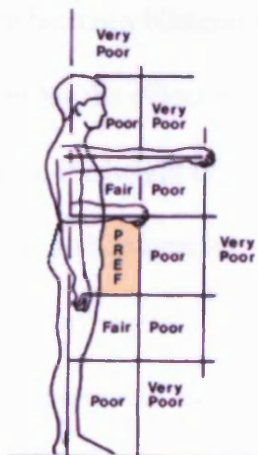

Figure 2.13: Preferred area for handling materials [Pheasant, 1996]

Rudy et al. [Rudy et al., 2003] evaluated performance differences between patients with lower back pain and a control group during their performance of a repetitive isodynamic lifting task. The results indicate that control subjects completed significantly more lifts and lifted more weight than patients. The findings also indicate that the patients used more of a leg lift. The findings conclude that body motion parameters, in addition to more common strength and endurance measures, are necessary to describe the impact of persistent LBP on a person's abilities.

An investigation of LBP with regard to the task variables of a lifting job done by Lin et al. [Lin et al., 2002] using an interview questionnaire carried out on outpatient participants. The characteristics of the manual lifting that were significant in patients with low-back pain were determined to be experience, object weight, carrying distance, lifting height, frequency, and activities with pulling or pushing. According to their results, the characteristics of the patients with lower back pain were as follows:

- more than 10 years of manual lifting
- weight of objects lifted over 30 kg
- object size over the width between bilateral shoulders
- distance shorter than 50 m for the object carried
- vertical location of object at the height of waist
- direction involving rotation and downward
- the accumulated frequency for manual lifting over 30 times per day
- pushing or pulling as a component of manual lifting
- forward bending without bending the knee as the main posture

Wang et al. [Wang et al., 1996] developed an automated system of evaluating the risk of lower back injury in a manual material handling task. The system applies computer vision techniques to identify the working posture, then incorporating biomechanical models and anthropometric data to calculate the lower back compression force. The complete cycle of the task would be video-taped, then the tape is played on a video cassette player to have the image captured by a frame grabber and stored in the personal computer. The systems would indicate the risk level of the task by comparing it with the specified standard limits, and some recommendations could then be provided.

2.4.3 Simulation of Manual Lifting Tasks

Studies have been carried out to perform simulation of lifting tasks. Marras et al. [Marras et al., 2003] evaluated the differences in spine loading between genders in realistic lifting situations. They conducted a test of biomechanical response during realistic free-dynamic lifting tasks. The equipment used were the lumbar motion to measure the trunk motion, bipolar electrodes for muscle activity data collection, a forceplate to measure kinetic variables and a set of electrogoniometers to accurately measure the position of the L5-S1 relative to the centre of the forceplate as well as user's pelvic/hip orientation.

Another study used a force plate, EMG (electromyography) electrodes and a simulated bin with a fold-down side to evaluate lifting styles (one hand vs. two hands) and two different bin designs [Ferguson et al., 2002]. McKean and Potvin [McKean

and Potvin, 2001] evaluate the effects of a simulated industrial bin on lifting having a constraining barrier. The use of EMG also attracted Zhang and Buhr [Zhang and Buhr, 2002] when they conducted a series of lifting tasks to elucidate whether back and leg muscle strengths are the intrinsic determinants of lifting motion strategy.

Chang et al. [Chang et al., 2003] provide a timely estimation of kinematics and kinetic data for biomechanical analysis of sagittal lifting task evaluation and design. They used a computerized postural coding system using information from field survey videotapes and limited input such as load, weight and height.

Kingma et al. [Kingma et al., 2003] carried out 3-D simulation of manual material handling on a moving platform, such as a ship. The 3-D accelerations were applied to the kinematics of both symmetrical and asymmetrical lifting tasks to find out to what extent low back loading is increased when the task execution is not adapted to the ship's acceleration. Lin et al. [Lin et al., 1999] worked on a dynamic simulation model developed for biomechanical analysis of lifting tasks in the sagittal plane, where the outputs would predict the angular trajectories of the five body joints: the elbow, shoulder, hip, knee and ankle.

Zee et al. [Zee et al., 2003] using only 2D musculo-skeletal models of leg and upper-body built into certain software, use an inverse dynamic analysis to calculate a starting point for dynamic lifting simulation. Santos is a human-like figure, that looks, moves, and reacts like we do. Santos is a life-like digital human that was created by VSR researchers.

The introduction of VEs would reduce the requirement for expensive physical properties as the highly accurate representation of the body hierarchy and anthropometry data can confidently undertake human-centered analysis. The environment can be simulated and can demonstrate a specific task to be performed in real life. Tecnomatix Jack, Santos and dV/SAFEWORK are examples of digital human software available which consider ergonomics and human factors. The human-like figure looks, moves and reacts like a real human. For example, Jack helps enterprises in various industries to improve the ergonomics of product design and workplace tasks. This software enables users to position biomechanically accurate digital humans of various sizes in virtual environments, assign them tasks and analyze their performance [Tecnomatix, 2004]. This information helps organizations design safer and more effective products faster and for less cost. Ultimately, Jack helps companies bring factories on-line faster and optimize productivity while improving worker safety.

2.5 Summary

This chapter has reviewed various issues relating to virtual environment applications concerning manual material handling and its technique from an ergonomics point of view. An overview of VR and its basic requirements, including hardware and software requirement, VR categories as well as feedback categories provided to the users has been highlighted with some examples. It has been widely accepted that applying VEs can improve quality, performance and productivity, and lower development costs and design time as well as enhance safety for people.

Chapter 3

Visual Display Feedback for Virtual Lifting

This chapter investigates visual display feedback techniques for virtual lifting tasks that provide feedback about the stresses placed on a user's lower back during a manual lifting task. Three different visual display feedback techniques were evaluated. This chapter also examined and evaluated a "weight perception test" to observe whether the users can identify the weight of a box using different types of feedback.

The chapter is structured as follows. The background to this research is presented with definitions of terminology. The experiment and trials for visual feedback are then described, followed by the results and a discussion. The same structure is used for the "weight perception test" experiment. A general discussion and summary of the presented research concludes the chapter.

3.1 Previous Work

Sensory feedback enhances the ability of a user to sense the environment and perform a task much quicker. VR is a powerful tool to simulate new situations, especially to test the efficiency and the ergonomics. For example, VR may produce immersive simulations of airports, train stations, metro stations, hospitals, work places, assembly lines, cockpits, machine and vehicle control panels. VR may help the user to

understand the job procedure prior to actually executing the task. VR would also help the user in training to perform the task correctly. This study will utilize visual display feedback in VR to provide information about the stresses on the users lower back whilst performing manual lifting tasks. In this section, previous research carried out on visual displays will be discussed. Several topics which relate to the experiment and trials conducted will also be highlighted.

Disability from back pain in people of working age is one of the most dramatic failures of health care [Waddell and Burton, 2000]. It also has a major effect on industry through absenteeism and avoidable costs (estimates suggest that back pain costs £208 for every employee each year) and at any one time 430,000 people in the UK are receiving various social security benefits primarily for back pain. In the UK some 2.5 million people suffer from regular back pain and between 50 and 90 percent of people will have a bout during their lifetime.

There is strong evidence that the physical demands of work (manual materials handling, lifting, bending, twisting, and whole body vibration) can be associated with increased reports of back symptoms, aggravation of symptoms and injuries [Bernard, 1997; Burdorf and Sorock, 1997; Ferguson and Marras, 1997; Bovenzi and Hulshof, 1999].

The introduction to the Applications Manual for the 1991 Revised NIOSH Lifting Equation [Waters et al., 1994] says that lower back pain and injuries attributed to manual lifting activities are among the leading occupational health and safety issues facing preventative medicine. Based on available statistics, almost half of all lower

back injuries are related to lifting, about another 10 percent are associated with pushing and pulling activities and another 6 percent occur while holding, wielding, throwing, or carrying materials [Randall and Jeter, 2002].

In order to maintain a healthy back and to prevent work-related back pain and back injury, ergonomic principles have to be adopted. Ergonomics is a science concerned with the 'fit' between people and their work, and is typically known for solving physical problems at work [Shaikh et al., 2004]. It also evaluates the capabilities of the body in relation to work demands. Ergonomic analysis should allow the user to employ 3D and virtual reality simulations to determine the comfort and safety of factory and office workstations by designing better workplaces and developing optimized product development cycles.

Many research studies have shown the positive effects of applying ergonomic principles in workplace design [Gill and Ruddle, 1998; Das and Shikdar, 1999; Eynard et al., 2000; Riley and Dhuyvetter, 2000]. Wilson [Wilson, 1999] studied the potential value of ergonomics to virtual environments. The study claimed that there was a close relationship between ergonomics and virtual environments due to the potential contribution and needs of each individual. They concluded that ergonomics knowledge and methods can be applied to the development of virtual environment systems, and to a more systematic development of useful virtual environments. Virtual environments also have the potential to assist ergonomists in systems analysis and development.

In this work, an analysis of the underlying ergonomic aspects has been taken into account while modelling the simulation lifting task in a semi-immersive environment. This provides an effective means of evaluation by having a monitoring system that can analyse the lifting process continuously in real-time as the task is being performed in the simulated environment. The ergonomic element that has been focussed upon in this study was Lower Back Pain (LBP). In the next section, a visual display feedback is employed to give the user information about their working condition in terms of reducing back injuries. This allows the user to train, practising the required tasks in a virtual environment before performing the actual tasks in the workplace. This will help in proactive ergonomics by allowing the designer to consider more workplace configurations and design changes while the workplace is still at the design stage. This will reduce the risk of ergonomic problems occurring later on, for example, in designing the position and orientation of shelving for a user in the packaging industry.

Studies have been conducted with the use of visual display feedback in virtual environments [Richard and Coiffet, 1995; Lathan et al., 2000; Le'cuyer et al., 2002; McCall et al., 2004; Rod et al., 2004; Durlach et al., 2005; Raymond and Brian, 2005; Reynolds and Day, 2005]. Many researchers [Lathan et al., 2000; Durlach et al., 2005; Raymond and Brian, 2005; Reynolds and Day, 2005] agreed that visual display feedback enhanced user performance.

Poupyrev et al. [Poupyrev et al., 1998] undertook a study which was designed to compare user performance with basic interaction techniques in virtual object selection and repositioning tasks. By contrast to the conclusions above, they found that visual feedback does not always improve user performance. They also claimed that adding

more visual feedback does not necessarily result in significant performance improvements. Moreover, Bakker et al. [Bakker et al., 1999] also agreed when they concluded that visual feedback provides very poor information to the user, Their findings showed that the purely visual feedback condition resulted in very poor performance compared to other conditions. Hollands and Marple-Horvat [Hollands and Marple-Horvat, 1996] found that without visual cues, the ability for the user was not affected.

An interesting result was found by Petzold et al. [Petzold et al., 2004] as they observed that both visual feedback and auditory feedback would be more confusing than helpful when displayed alone. They also claimed that in cases in which haptic feedback cannot be provided, it is best to apply auditory and visual feedback information together, although the effect of this substitution is only a little better than limiting the presentation to pure visualization.

Other studies undertaken by Durlach et al. [Durlach et al., 2005] argue the effect of the fidelity condition. This is hand fidelity, which means the similarity in the appearance of the virtual hand to the participant's own hand. The study compared and contrasted two cases. First, the virtual hand resembled a hand, but in the Low-Fidelity condition: it was angular and black (without shading). The second is in High-Fidelity condition: it was coloured like the glove worn, with shadowing, tapered fingers, and joints clearly visible (see Figure 3.1). They concluded that high hand fidelity produced faster movement times than low hand fidelity; but hand fidelity did not affect accuracy. Several researchers [Pavani et al., 2000; Maravita et al., 2002]

also studied visual feedback and claimed that visual capture is most potent when viewed hands are interpreted by participants as their own.

Xiao and Milgram [Xiao and Milgram, 1992] explored several issues of visualisation in 3D. They claimed depth cues can be divided in two categories: “Static Depth Cues” and “Dynamic Depth Cues”. Dynamic cues are usually very strong but require rapid updating.

Several researchers [Mazur and Reising, 1990; Wickens, 1990; Merwin and Wickens, 1991; Randy and Paul, 1991; Sollenberger and Milgram, 1991] claimed that the following five cues (out of ten cues from “Static Depth Cues” and “Dynamic Depth Cues”) are potentially the most useful cues for network visualisation: (1) binocular disparity, (2) relative motion and motion parallax, (3) linear perspective, (4) proximity-luminance and proximity saturation covariance, and (5) shadows. They concluded that the greater the number of cues provided, the better the depth perception. This was a consistent finding in 3D perception. However, there is usually a cost associated with the display of each cue.

The provision of a depth cue on computer displays will be discussed in detail with the aid of a few figures. Stereopsis, binocular vision and 3D vision all mean the same thing: that remarkable power of the visual sense to give an immediate perception of depth on the basis of the difference in points of view of the two eyes. Stereopsis can be generated by providing each eye with a slightly (horizontally) shifted image of an object [Holliman, 2005]. According to Hodges and McAllister [Hodges and McAllister, 1987], two methods of providing stereopsis are by time parallel and time

multiplexed methods, which mean whether or not images are viewed by two eyes simultaneously (implemented by HMD) or alternately (implemented by LCD shutter glasses).

Shutter glasses have a major advantage in that they are cheap, light weight and easy to use. Using one display monitor, but switching between each of the two eyes alternately, is by far the easiest way to achieve stereopsis. This method requires display of the two images (left and right) alternately to each eye. Users view these through a liquid crystal shutter system that synchronises with the display. To eliminate flickering due to the alternation, a frequency of higher than 60 Hz for each eye (total of 120 Hz) should be used [Hodges, 1992]. As a result, each eye sees a unique image and the brain integrates these two views into a stereo picture.

Two view displays generate the two views for the left and right eyes in two viewing windows in space (refer Figure 3.2). These are primarily visible from a central viewing position and the user may have up to 20 or 30 mm of movement around the central viewing position before they lose the 3D effect. Typically this type of display has high resolution per view and low cost. Some systems permit switching between 3D and 2D, allowing the display to function as a standard monitor when the 3D effect is not required.

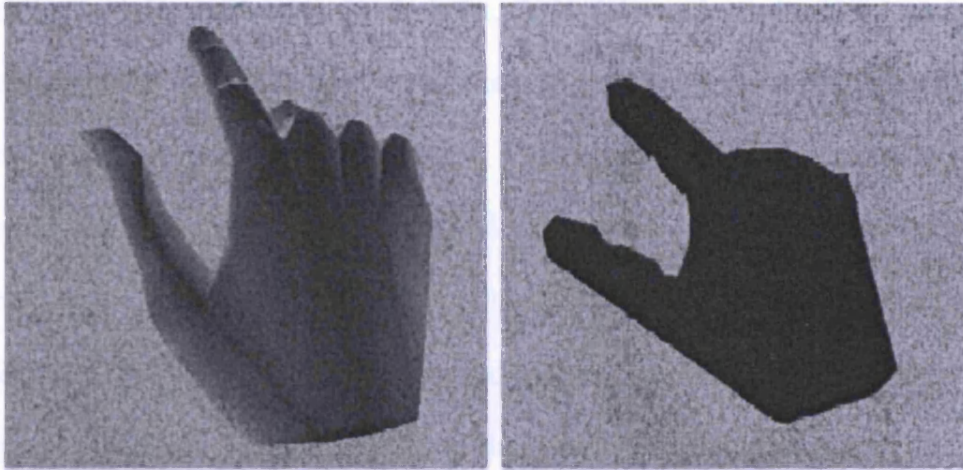

Figure 3.1: An illustration of the high-fidelity (left) and low-fidelity (right) virtual hands [Durlach et al., 2005]

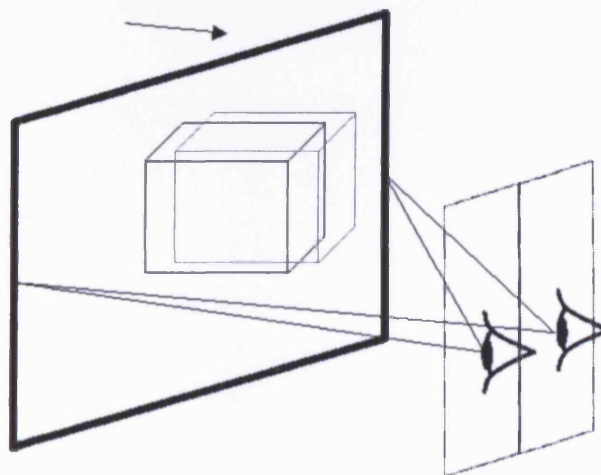

Figure 3.2 : Two separate viewing regions for left and right images [Hodges, 1992]

Helmholtz and Howard et al. [Helmholtz, 2000; Howard et al., 2002] undertook studies on depth perception in planar stereoscopic images and the geometry of stereoscopic depth perception. Figure 3.3 shows how the image was captured and displayed. The image disparity captured as a stereo image pair is created and becomes a physical screen disparity when the stereo pair is displayed on an electronic 3D display. The screen disparity is detected by the retina and interpreted by the brain as a perceived depth in front or behind the screen plane, as shown in Figure 3.4. While a viewer's actual perception of depth resulting from a given screen disparity is important, the common approximation of considering geometric perceived depth, *gpd* is adopted. This is calculated, as shown in Figure 3.4, from the value of screen disparity the viewer perceives.



a) Two cameras capture the images



b) Images captured and display on the screen

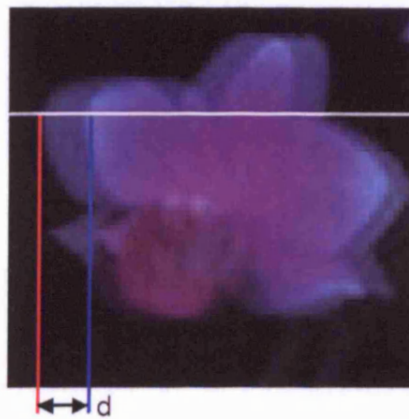

c) Horizontal difference = d is called screen disparity

Figure 3.3 : Image creation and delivery [Holliman, 2005]

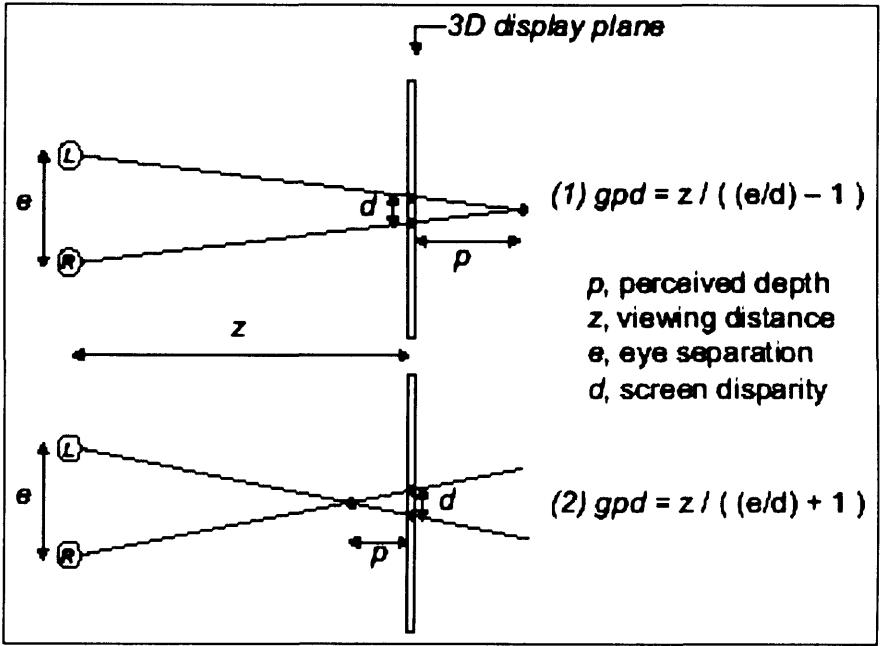

Figure 3.4: Geometric perceived depth for positive (1), and negative (2), screen disparity [Froner and Holliman, 2005]

3.2 *Visual Display Feedback Simulations for Manual Lifting*

Several factors need to be considered if visual feedback is to be employed in a virtual lifting task. The first factor involved is the degree to which feedback is integrated within the environment. Full integration occurs when the feedback takes the form of a 3D object that is embedded within the environment, and one example is an object that shows the prescribed position during a virtual lifting task. Feedback may also be classified as external to the environment. An example would be when the feedback is displayed on a graph or presented as text messages. Another alternative is for text messages or graphical information to be superimposed on objects that are contained within the environment (e.g., feedback is superimposed on the object to which it refers) and this is partial integration.

The colour of the displayed feedback is another factor to be considered. Selection of the colour to be used as a feedback must be associated with the feedback being given (for e.g., red represents dangerous or green represents safe). Furthermore, the chosen colour must be easy to remember by the users and yet it must not merge with the background of the environment. The other factor is location of the feedback within the environment. The feedback must be easily seen by the user. Visual feedback should also be symmetrically displayed to avoid any visual bias, visible in a user's field of view (FOV) and visible from a number of different viewing angles.

3.2.1 Method

It can be assumed for all experiments in this study that the virtual box is intentionally made large enough for the user to see the visual display feedback irrespective of lifting location.

3.2.1.1 Participants

Seventeen males and three females between the ages of 28 and 37, with a mean age of 32.4 years and a standard deviation of 3.0 years, participated in this study. All users for the experiment were in good health, had no history of any back problems, no vision (after correction) or hearing impairments. None of the subjects had any previous experience of VR.

3.2.1.2 Experimental set-up

The VE software was a C-based application that was designed and programmed by the author using CAVELib API. An Onyx 300 visualization server was used to generate the images on a Portico Workwall (a large-scale display device). Stereoscopic 3D images were created through the use of LCD shutter glasses with a refresh rate of 120Hz (60Hz update for each eye). Tracking for head and box position and orientation was performed using six degrees of freedom sensors together with Trackd software. Detail of the system architecture is presented in Figure 3.5.

Participants were told to perform the task to the best of their ability. Ergonomic functions were crucial as an indicator of a virtual lift condition. The functions utilised a modified NIOSH equation to provide real-time Lifting Index (LI) information. This was done by continually setting the current height to the starting lifting position in equation 2.1 [Waters et al., 1993]. A function in the programme was also used to calculate NIOSH Lifting Index values which indicate the safety of the movement (as equation 2.2). The LI value varied between 0.00 and 0.99 for safe lifts, with values equal to or greater than 1.00 indicating harm to the user. In this experiment, two thresholds have been set which were lower LI threshold and upper LI threshold.

Those two thresholds divide the LI values to three regions, where:

$$0 \leq \text{Safe} \leq 0.32$$

$$0.32 < \text{Risky} \leq 0.37$$

$$\text{Danger} > 0.37$$

LI values below the lower LI threshold represent **Safe**, LI values between the lower LI threshold and upper LI threshold were categorised as **Risky** and LI values above the upper LI threshold were categorised as **Danger**.

The experimental design has four experimental conditions; one experiment was conducted with no feedback and the remaining three conditions were provided with “Visual Display” feedback techniques in real-time. Three types of visual display feedback have been used in this study, which were Text, Colour and COMBI (Combined Colour and Text).

Throughout this section, the acronym below has been used to represent each condition.

NF	=	No Feedback
T	=	Text
Col	=	Colour
COMBI	=	Combined Colour and Text

For the experiment with No Feedback, the user does not see any feedback related to their LI. In the experiment with Text feedback, users received feedback in Text for their LI results. The virtual box was the same grey colour throughout the experiment. For experiments with Colour Feedback, the box would change in colour according to the LI values. Three colours were chosen: Green represents a Safe Lift, Yellow represents a Risky Lift and Red represents a Dangerous Lift. In COMBI Feedback, users received both Colour and Text Feedback simultaneously.

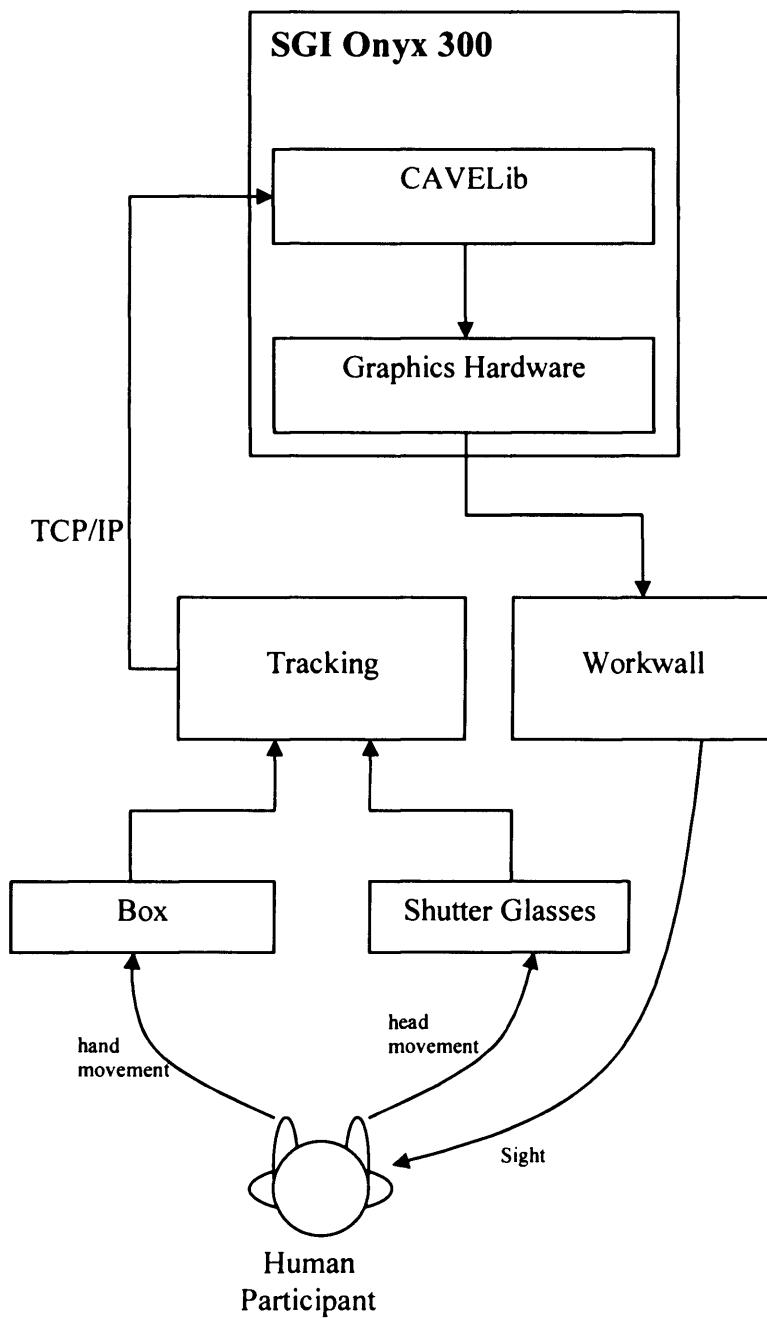

Figure 3.5: System Architecture

3.2.1.3 Experimental procedure

Each experiment was performed separately for the user and lasted approximately one hour. Upon arrival, participants were provided with a verbal overview of the experiment and signed the health consent forms before the experiment commenced (see Appendix B). The experimenter (the author) explained and described the task to each user (see appendix C). Participants practised and performed five trials for each condition of the experiment. Each user was measured and the information was recorded in a data file.

Users were invited to perform the lifting task as if this were their daily task working on an eight hour shift. Users were required to conduct four experimental conditions: No Feedback, Text, Colour, COMBI. The presentation order of the four conditions was controlled by using the Latin Square Design for minimising learning effect [Winer et al., 1991].

Users were required to carry out 10 trials for each condition. Users were asked to lift the box from shelf 1 and place the box on shelf 2 in a proper location, guided by the feedback. Users were then asked to pause and hold the box static for 2 seconds at the end of every trial, before proceeding on to the next trial. This delay allowed the experimenter to identify that the lifting task was complete, while monitoring the action of the user during data analysis. Detail of the schematic representation is shown in Figure 3.6. V_O and H_O show the vertical and horizontal positions of the box at the start of the trial, denoted as “**original**”. V_D and H_D illustrate the vertical and horizontal positions of the box at the end of the trial, denoted as “**destination**”. Two

sensors were used for this experiment, one attached to the box for tracking hand movement, and the other attached to the shutter glasses for tracking head movement in real-time. The time taken to complete each task and the corresponding Lifting Index values were also recorded by the application. The user's objective was to carry out the task in the safe working zone to the best of their ability. Figure 3.7 shows the flow diagram for this experiment. The data from the sensors (for hand movement and head movement) were processed to calculate the forces applied on the user's lower back. These forces were calculated using the NIOSH equation which resulted in a value for Recommended Weight Limit (RWL) and Lifting Index (LI) (refer Eqn. 2.1 and 2.2 in section 2.3). The LI provides a single value that indicates the level of safety or acceptability for a particular lifting task. The LI working range was partitioned into three distinct categories designated "Safe", "Risky" and "Danger".

Figure 3.8 shows pictures of users conducting the experiment of Colour Feedback and Figure 3.9 shows an experiment of Text Feedback technique. As can be seen from both figures, the box was ready to be placed on the shelf when the shelf changed in colour from grey to purple. This colour change indicated that the box has reached the final destination. Figure 3.10 shows an example of a Combined Colour and Text Feedback technique.

Upon completion of the experiments, the participants were monitored for 45 minutes as a precautionary measure for symptoms of VE sickness using a short symptom checklist (SSC) [Cobb et al., 1999] (see Appendix B).

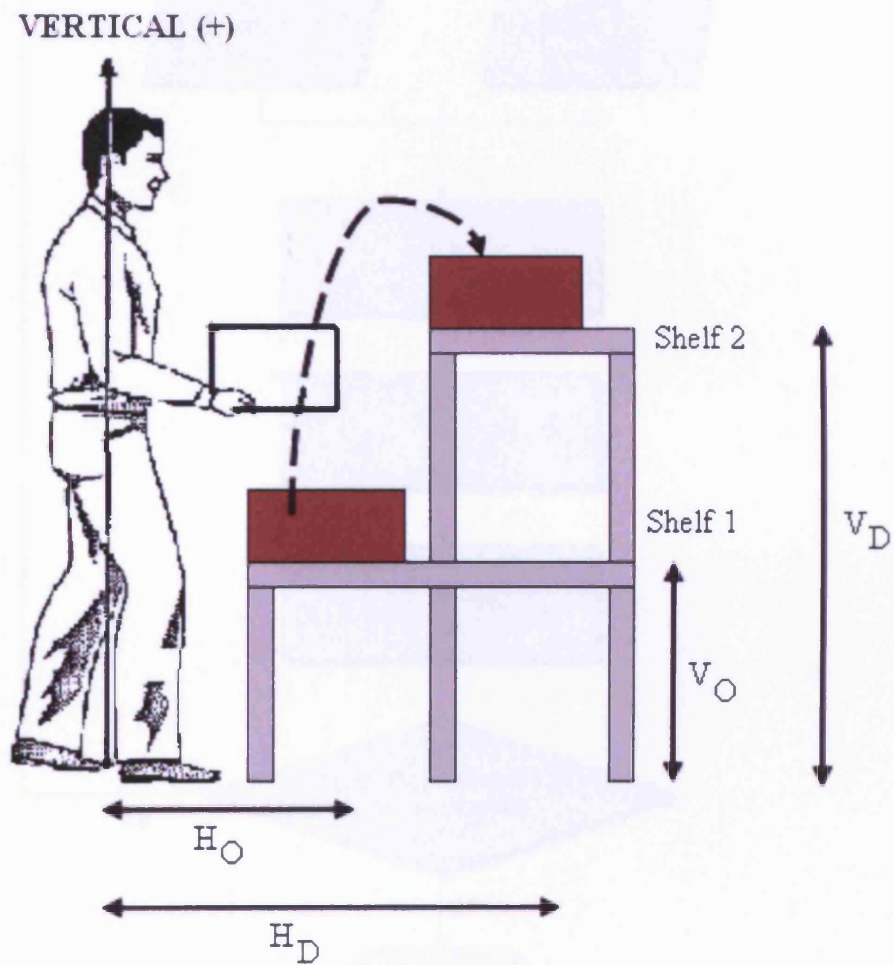

Figure 3.6 : Schematic representation of shelving position

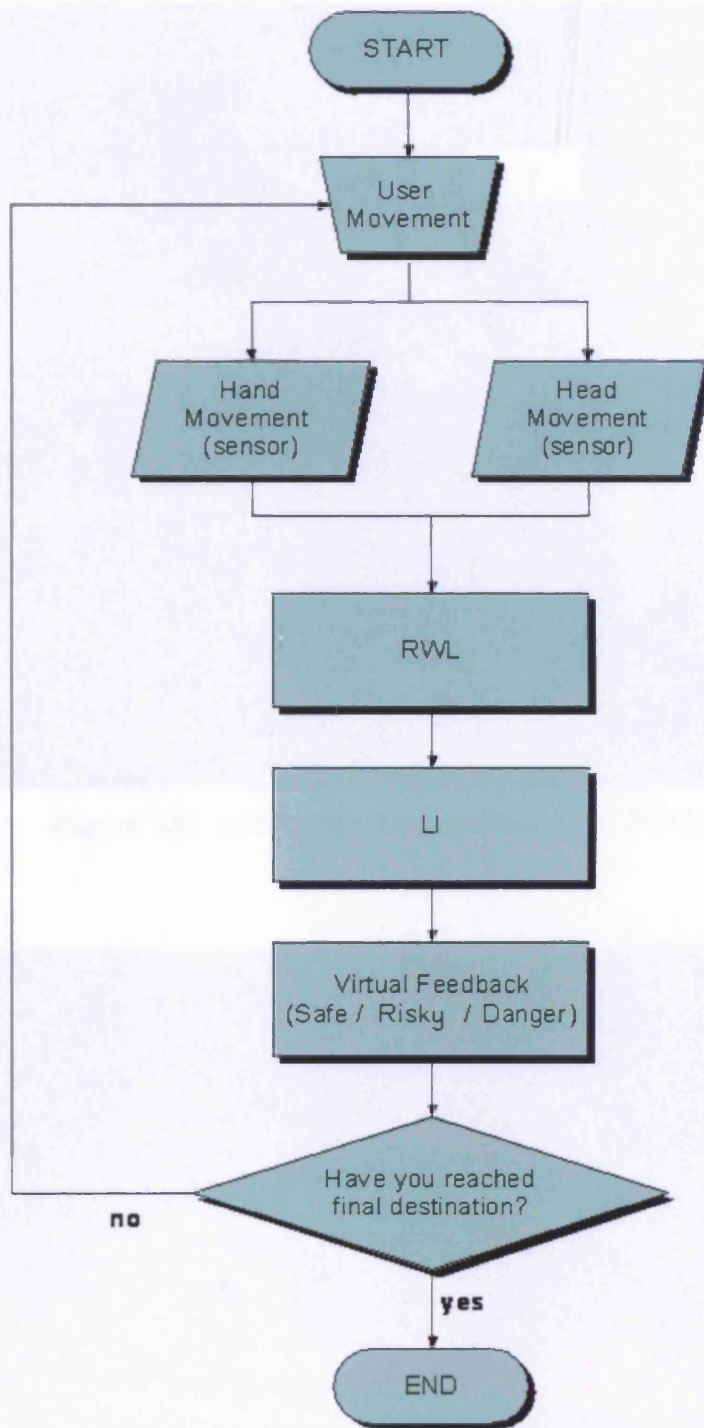

Figure 3.7: Flow diagram for Visual Display Feedback techniques

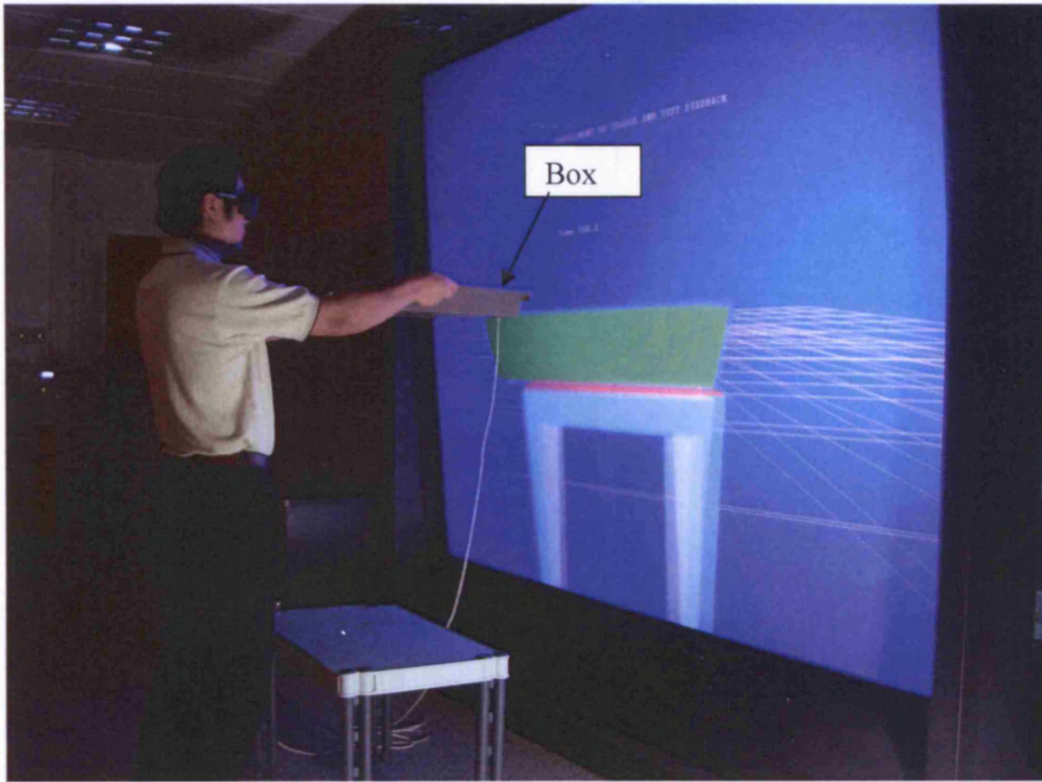

Figure 3.8: User conducting an experiment for Colour Feedback

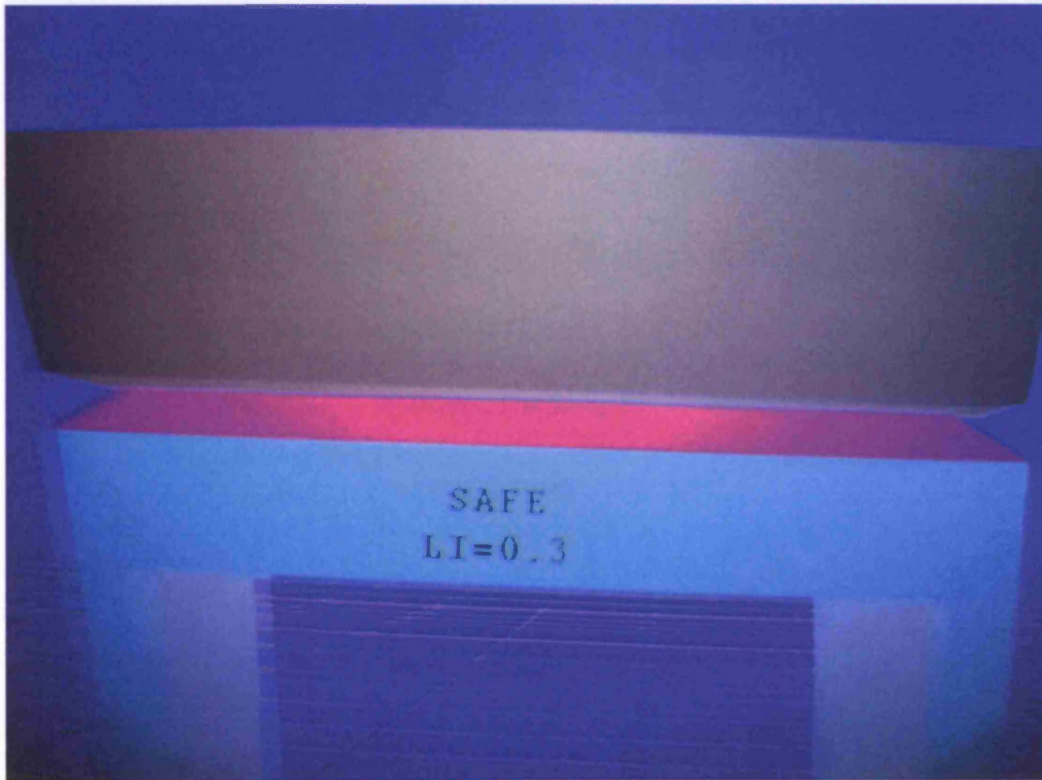

Figure 3.9: An experiment for Text Feedback

3.5.3 Results

The results from the snapshot and the time recorded by the software to display a feedback LI value were extracted and presented from the written software. The next step had to be produced in order to be able to obtain only one LI value for every 10% of LI made throughout the lifting task. A one-way (dependent) ANOVA was used for

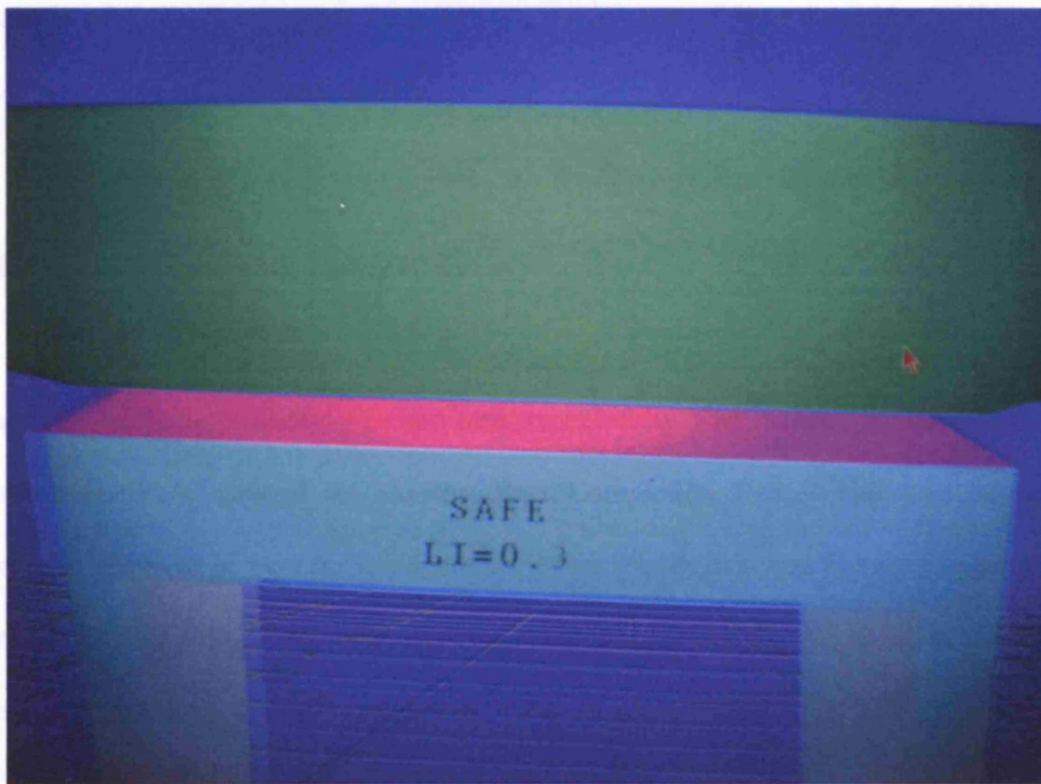

Figure 3.10: Example snapshot for Combined Colour and Text feedback technique resulting in a Safe lift

3.2.2 Results

The results from the sensors and the time recorded by the software together with the LI values were extracted and processed from the written software. The raw data had to be processed in order to be able to obtain only one LI value for every change of LI made throughout the lifting task. A one-factor (technique) ANOVA was used for analysis of Task Completion Time (TCT), Percentage of Harmful Lifts (PHL) and Response Time to Feedback (RTF).

3.2.2.1 Task Completion Time (TCT)

The time taken to accomplish each task successfully was measured. Experiments without feedback showed the shortest Task Completion Time. This was because users did not have to monitor any feedback of their back pain and this may result in a harmful lift if a wrong lifting technique is used. The results showed no main effect of feedback technique on task completion time, $F(3,76) = 2.35$, $p > 0.05$. However, COMBI feedback gave superior results compared to colour and text feedback only (mean = 8.7. s.d. = 6.6). From Figure 3.11, it can be seen that Colour feedback (with mean = 10.3 and s.d.= 6.2) outperformed Text feedback (mean = 13.7 and s.d.= 8.8), while NF condition resulted with mean = 8.50 and s.d.= 7.1. Error bars in the graph indicate standard error. These apply to all the bar graphs throughout this thesis.

3.2.2.2 Percentage of Harmful Lifts (PHL)

Figure 3.12 shows Percentage of Harmful Lifts (PHL). The results from ANOVA analysis showed that there was a main effect of feedback technique on PHL, $F(3,76) = 87.91, p < 0.05$.

Additional analysis is necessary to determine where the differences occurred. A widely accepted approach for conducting pair-wise comparisons of treatment effects is the Tukey Honest Significant Different (HSD) test. Tukey HSD tests the hypothesis that two treatments are equivalent while controlling for the overall Type I error rate (the probability of incorrectly rejecting the null hypothesis) [Cobb, 2002].

A post-hoc Tukey test [Winer et al., 1991] reveals that the percentage differed significantly between “T and COMBI ($p < 0.05$)”, and between NF and all of the techniques. The plotted graph also shows that COMBI gave the lowest PHL with mean = 17.25 and s.d. = 0.83. Colour feedback outperformed Text feedback with mean = 21.75 and s.d. = 1.09 and mean = 27.75 and s.d. = 1.2 respectively, while NF condition resulted with mean = 51.25 and s.d. = 2.1.

3.2.2.3 Response Time to Feedback (RTF)

Figure 3.13 shows Response Time to Feedback (RTF) for conditions of Text, Colour and COMBI. Condition with No Feedback was not included since this analysis examines the difference of time to bring the LI value within the safe working range. Even though the ANOVA results for Response Time to Feedback (RTF) did not

reveal any significant difference between the experimental conditions $F(2,57) = 1.47$, $p < 0.05$ (refer Figure 3.13), the average for COMBI was the best in performance (mean = 0.46, s.d.= 0.38), when compared to Colour Feedback (mean = 0.5, s.d.= 0.45) and Text Feedback (mean = 0.66, s.d.= 0.38).

3.2.2.4 Qualitative Visual Feedback Preferences

In addition to TCT, PHL and RTF, percentage differences between visual feedback preferences were also calculated. Results from a questionnaire (see Appendix D) were analysed and it was found that 70% of the users chose COMBI as their first preference while 15% chose Colour feedback and 15% chose Text feedback as a first preference. Details of the results are given in Table 3.1.

It was shown that COMBI feedback was the most preferred virtual display feedback because 70% chose it as their first preference, followed by 25% as second preference while 5% chose it as their third preference.

In Figure 3.14, it is clearly shown that the overall user first preference is COMBI with the highest percentage (70%). Users' second preference would be Colour Feedback, since 40% of the users chose this as their second favourite. The third preference would be Text Feedback, with 50%.

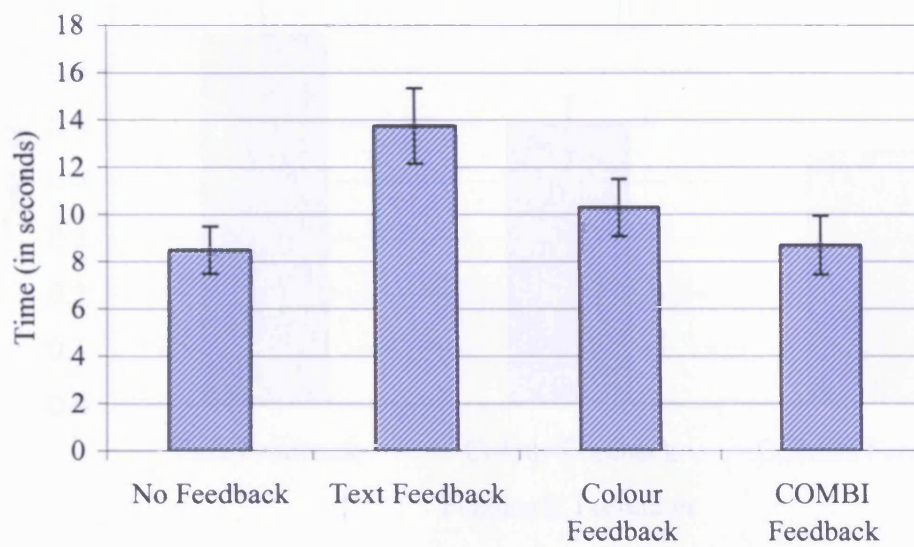

Figure 3.11: Task Completion Time for Visual Display Feedback Techniques

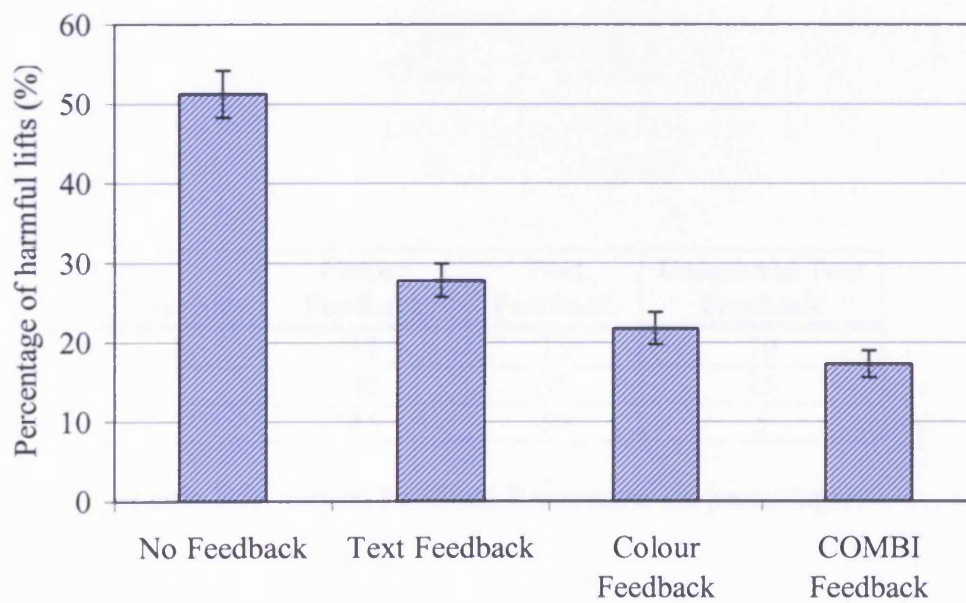

Figure 3.12 : Percentage of Harmful Lifts (PHL) for Visual Display Feedback Techniques

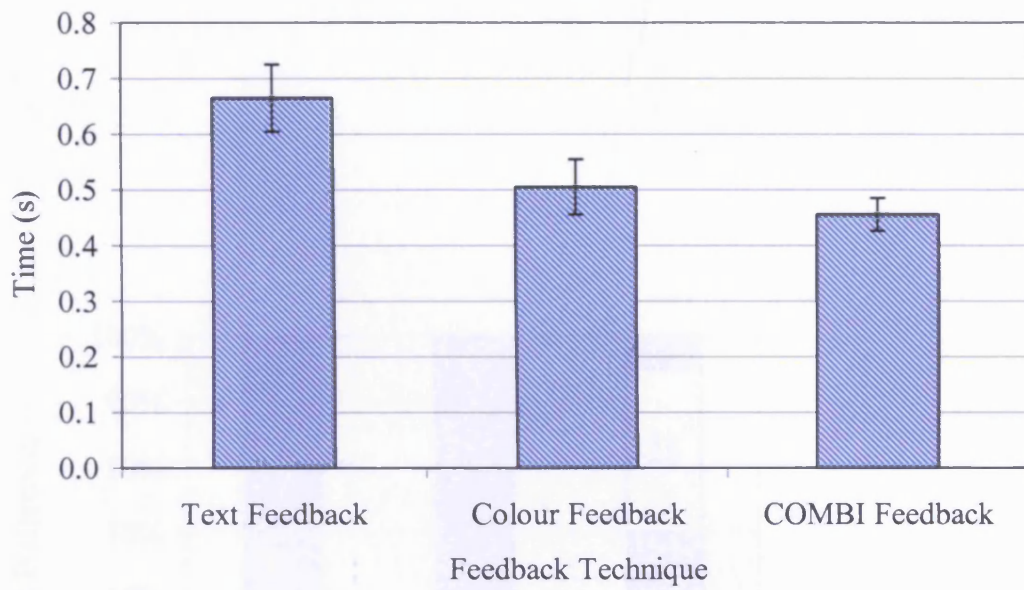

Figure 3.13 : Response Time to Feedback (RTF) for Visual Display Feedback Techniques

Preference	Colour Feedback	Text Feedback	Colour and Text Feedback
1	15	15	70
2	40	35	25
3	45	50	5

Table 3.1: Virtual Feedback Preferences (in percentage)

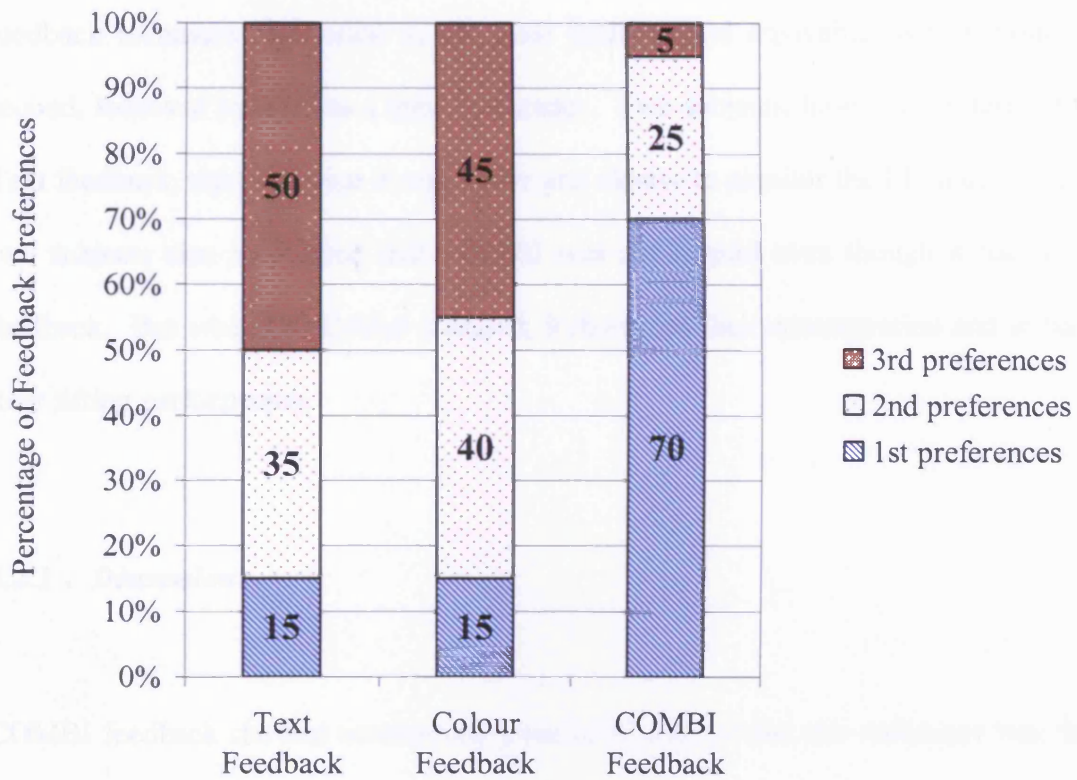

Figure 3.14 : Qualitative results of Feedback Preferences

3.2.2.5 Users' comment

All subjects were able to place the box at the correct location (marked by changing the shelf colour from grey to purple). While none of the subjects had difficulties in using either Colour, Text or COMBI feedback techniques, in general the COMBI feedback technique was rated as the most intuitive and enjoyable, with Colour as second, followed by Text as a third preference. Two subjects, however, preferred the Text feedback, reporting that it was easier and clearer to monitor the LI value. These two subjects also mentioned that COMBI was not helpful even though it had Text feedback. But when the Colour changed, it disrupted their concentration and in turn their lifting performance.

3.2.3 Discussion

COMBI feedback showed consistently good results given that this technique was the best for all aspects that have been analysed. These were TCT, PHL and RTF. The ranking for the results also followed the same path, where Colour Feedback was better than Text Feedback. Despite the fact that no significant difference was found in TCT and RTF, COMBI seems good for alerting the user of their lower back condition while carrying out a manual lifting task.

Even though the NF condition showed the shortest time to complete the task in TCT analysis, it will result in a high percentage of harmful lifts. This is dangerous to humans as the symptoms of lower back pain are not normally discovered during the

task, but sometime in the future. So trying to avoid poor lifting technique in the first place is crucial.

3.3 Weight Perception Test

This experiment measured the understanding of the virtual display feedback for the users who participated in this experiment. The experimenter prepared five trials where the virtual weights of the box were varied and the users were not told of the weight used for that particular trial. There were three different virtual weights allocated for this experiment, 5 kg, 8 kg and 12 kg and designated “light”, “moderate” and “heavy” respectively. These weights were determined by trial-and-error. The order for the weight to be used was randomised.

3.3.1 Method

3.3.1.1 Participants

This experiment used the same participants as in experiment in 3.2, with a mean age of 32.4 years and a standard deviation of 3.0 years. All of the participants complied with the same health regulations as Experiment 3.2.

3.3.1.2 Experimental set-up

The experimental hardware was similar to those employed in experiment 3.2. The software was another CAVELib application which was programmed by the author. The same sensors were used together with the same box. Only the virtual weight applied to the virtual box was varied. Five trials were conducted with three different virtual weights. Only one type of visual display feedback was employed for this experiment. This was COMBI feedback. This type of feedback was chosen as it was found to be the best method of visual display feedback in warning users of their ergonomic lifting condition.

3.3.1.3 Experimental procedure

Users carried out the task individually. The user was asked to lift the box from the lower shelf and place it on to the upper shelf. They were informed that they would have to guess the weight of the box according to the virtual feedback received. They were required to give the answer verbally as soon as they noticed the feedback difference and at the latest within 30 seconds of completion of the lifting task.

The experimenter first demonstrated how the experiment worked and users were shown the feedback with three different weights. Once the users completed the experiment, they were required to fill in a questionnaire (see Appendix D). Users rated the extent to which they perceived each feedback using a 7-point scale ranging from 1 (not at all) to 7 (completely). Higher scores indicate greater perception of weight differentiation

3.3.2 *Results*

The primary objective of this experiment was to evaluate the understanding of visual feedback given during a lifting task according to the different weight attached to it. The percentage of correct-incorrect selection was calculated and analysed.

From the results collected, it was found that 96% of the answers given by the users were correct while only 4% were incorrect. The incorrect answers came from two different users, where the first user made 3 incorrect answers and the other only made one. It has been explained by the user who made three incorrect answers that he did not pay full attention during the demonstration. Therefore this might be considered as an anomalous case.

Results from the questionnaire were analysed and it showed that 90% of users chose between score 5 to 7, where 7 represents the highest (the most noticeable difference of feedback between light, moderate and heavy weight). Only two users chose score 3 and 4 respectively. None of the users choose score 1 or 2. All of the users reported the results to the experimenter before completion of the lifting task. Details of the percentage are shown in Figure 3.15

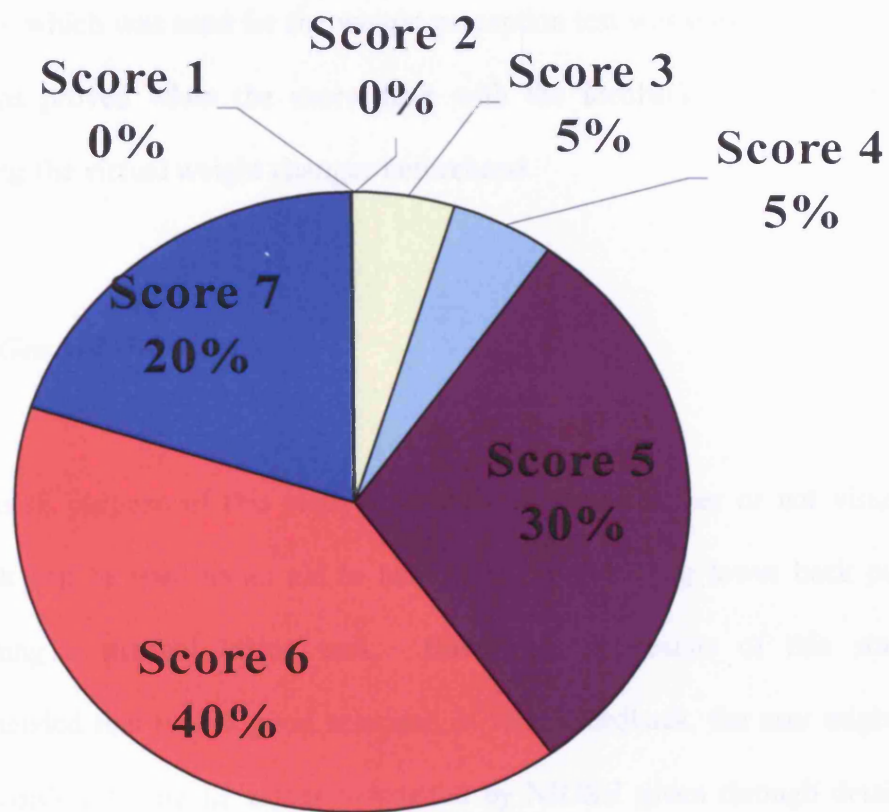

Figure 3.15 : Percentage of Weight Perception Test

3.3.3 Discussion

Users were able to perceive feedback differently when the experimenter changed the virtual weight and the users managed to react to the given feedback faster. It was interesting to note that all the results were given during the lifting task. The COMBI feedback which was used for the weight perception test was good and easy to follow. This was proved when the users dealt with the feedback changes even without practising the virtual weight changes beforehand.

3.4 General Discussion

The overall purpose of this study was to investigate whether or not visual display feedback can be used as an aid to help users monitor their lower back pain whilst performing a manual lifting task. Based on the results of this study, it is recommended that with a good selection of visual feedback, the user might perform well according to the LI values calculated by NIOSH given through details in text messages. COMBI was the best in performance compared to Colour and Text feedback. Users found that COMBI was easy and helpful because they could control for coarse and fine LI. For example, if the user needed to bring the LI value much lower (coarse control), he/she might rely on Colour changes. However, if only small changes (fine control) were required, the user would prefer to use Text as this was much more accurate.

The study also verified that users' perception of feedback difference in the weight perception test was very high. This suggests that users feel it easy to understand the feedback, even when various weights were applied which changed LI as well as visual display feedback. The majority would prefer COMBI as the best visual feedback followed by Colour and Text. Nonetheless, Text Feedback may still be a useful and necessary feedback cue in a VE design or visualization application where details of numeric numbers are the main goals (and Task Completion Time is not the main objective).

3.5 Summary

Visual display feedback has been proved to aid users in carrying out manual lifting tasks safely. In order to monitor the forces acting on a users' lower back while performing a manual lifting task the NIOSH equation, which calculates RWL and LI, was applied as a guideline to categorise the lifting regions. The visual feedback displays the changes according to LI values calculated in real-time from sensor data. Three types of visual display feedback have been tested which were Colour, Text and COMBI. All of the feedback conditions were suitable for application in a manual lifting task, but COMBI was found to be the best according to the results of TCT, PHL and RTF. COMBI feedback was also tested on users' weight perception where the majority (96%) gave correct results. Further research is required to determine whether other mixed visual feedbacks actually improve user performance in visualization VEs.

Chapter 4

Effect of Auditory and Visual Display Feedback on Lifting Tasks

This chapter investigates the effect of auditory feedback techniques in virtual lifting to enhance user performance and reduce the stresses on a user's lower back during manual lifting tasks. The combination of both Auditory and Visual feedback techniques was also examined to evaluate whether a combination of feedback is better to convey information to users rather than single feedback only.

This chapter is structured as follows. The previous work for this research area is presented with an explanation of some terminology. The experimental set-up and procedure used when conducting the first experiment is then described followed by results and discussion. The next experiment follows, which is used to evaluate the effectiveness of a combination of audio and visual feedback techniques in virtual lifting. This experiment is described and followed by results and discussion. A summary of the presented research concludes this chapter.

The experimental hypothesis is that an extra feedback is provided by audio sounds which should make it easier for participants to understand feedback more quickly. They will respond quicker than if they were using only visual feedback. This should result in faster TCT, RTF and better PHL.

4.1 Previous Work

Auditory feedback has been used extensively to convey information in computer applications. Sounds can be utilised to improve the users' understanding of visual predecessors or can stand alone as independent sources of information. Zahariev and MacKenzie [Zahariev and MacKenzie, 2003] conducted research to investigate how performance of the reach, grasp and place task was influenced by adding auditory and graphical feedback. They found that providing auditory feedback clearly facilitated performance.

The combination of visual and auditory information at the human-computer interface is a powerful tool for interaction [Brewster, 2002]. In everyday life both senses combine to give complementary information about the world. Our visual system gives us detailed information about a small area of focus, whereas our auditory system provides general information from all around, alerting us to things outside our peripheral vision. The combination of these two senses gives much of the information we need about our everyday environment.

Zhang et al. [Zhang et al., 2005] report on the findings of integrated feedback (visual plus auditory) in virtual assembly task performance. The Peg-in-a-hole assembly task showed an improvement of performance under the combined auditory and visual feedback compared to another three conditions which were no feedback, visual only and auditory only. The study also found that subjective preference of the four different conditions was statistically larger for combined auditory and visual feedback. According to Zhang and Sotudeh [Zhang and Sotudeh, 2004], the increase of useful

feedback information may enhance the user's efficiency. Providing users with multimodal feedback (visual and auditory) has the potential both to guide them and present them with performance feedback during the simulation [Crossan et al., 2000].

In contrast, Tzelgov et al. [Tzelgov et al., 1987] emphasized that even though the combination of visual and auditory information can prove effective, it may also prove to be less useful in some circumstances than information presented in only one sensory modality. Lécuyer et al. [Lécuyer et al., 2002] claimed that Task Completion Time can rely solely on efficient visual feedback. They agreed that adding an inappropriate feedback may impair performance level.

Petzold et al. [Petzold et al., 2004] conducted research on a pick-and-place task of virtual gear wheel and virtual gear shaft and they claimed that combined auditory and visual feedback techniques may be a suitable substitution if haptic feedback is not possible. However, their results indicate that the effect of this substitution was not large and only a little better than visual feedback solely.

Durlach et al. [Durlach et al., 2005] also agreed that auditory feedback did not enhance user's sense of presence. In the opinion of Miner et al. [Miner et al., 1996], auditory feedback alone did not significantly influence the haptic perception, however visual feedback and combination of visual and auditory stimuli influenced a subject's haptic perception. Gaver et al. [Gaver et al., 1991] also studied and used sounds as diagnostic support applied to the direction of a process simulation. However, they did not prove the hypothesis that an interface with auditory feedback is superior to an

interface without sound feedback. They describe only some global impressions of different operator reactions to sound feedback.

Research conducted by Liu and Jensen [Liu and Jensen, 2004] pointed out that visual feedback alone is more beneficial than auditory alone or AV (Audio-visual). Moreover, a study conducted by Rauterberg [Rauterberg, 1999] showed that auditory feedback can be helpful only if the user chooses a sound pattern that he or she really likes.

Audio feedback has also been applied to present state information to augment a surgical procedure [Wegner, 1998]. Surgical instrument position and optimal path information are passed to the surgeon through audio, allowing the surgeons to use the information while keeping their visual focus on the patient. Similar concepts of supplying users with auditory position and path information can also be applied to medical simulators. Incorporating audio warnings into a simulation can provide immediate feedback to users that the current action they are performing is incorrect, or dangerous. Therefore, they can build confidence as they progress through the procedure that their actions are not harmful.

Despite recent efforts in auditory applications in VEs conducted by several researchers, no research has been performed to investigate and evaluate the effect of multimodal feedback techniques to aid the user in assessing the effects of the stresses on their lower back. Moreover, various findings on the effectiveness of auditory feedback motivate the author to evaluate the effectiveness of the combination of

visual and auditory feedback to aid people to perform manual lifting without causing harm to their lower back.

This research therefore focuses on evaluating the best auditory feedback to provide the user with information about their back stress condition, and also in assessing whether adding auditory feedback to visual feedback may improve user performance while conducting the lifting tasks.

There are two types of sound in general, speech and non-speech [Hancock et al., 2005]. Auditory display is the use of non-speech sound to present information. Auditory display is currently used in many complex work environments, including computers, medical workstations, aircraft cockpits, and control centres in nuclear reactors.

It is important to obtain a better understanding of how the ears receive sound in order to synthesize a realistic auditory environment. The human ear can locate a sound source even in the presence of strong conflicting echoes by rejecting the unwanted sounds [Stanney et al., 1998]. In order effectively to develop aural displays, this ability of listeners to track and focus on a particular auditory source needs to be better understood.

There have been many research studies conducted on auditory displays [Van and Kinkade, 1972; Patterson, 1982; Kantowitz and Sorokin, 1983; Sanders and McCormick, 1987; Cook et al., 1998; Kramer et al., 1999; Neuhoff et al., 2002; Isdale, 2003; Jerry, 2003; Georgios and Stephen, 2005; Marentakis and Brewster, 2005].

Buxton et al. [Buxton et al., 1991] conducted research on the usage of non-speech audio to communicate information from the computer to the user. They found that non-speech audio messages can be thought of as providing one of three general types of information: alarms and warnings, status and monitoring indicators, and encoded messages.

Brewster [Brewster, 2002] also carried out research on non-speech auditory feedback. He highlighted the usage of non-speech sound in the human computer interface (HCI), listed the advantages offered by sound and made a comparison between speech and non-speech sounds. Many of the advantages identified apply to speech as well as to non-speech sounds. There are, however, some advantages to non-speech sounds. If we think of a visual analogy, speech output is like the text on a visual display and non-speech sounds are like the icons [Stfelman, 1995; Brewster, 2002]. Presenting information in speech is slow because of its serial nature; to assimilate information the user must typically hear it from beginning to end and many words may have to be comprehended before a message can be understood. With non-speech sounds the messages are shorter and therefore more rapidly heard. However, the user might have to learn the meaning of the non-speech sound whereas the meaning is contained within speech sounds and therefore requires no learning – just like the visual case. Some of the pros and cons of speech and non-speech sounds are shown in Table 4.1 [Aldrich et al., 1989; Barker and Manji, 1989; Brewster, 2002].



AUDITORY FEEDBACK		
<i>Criteria</i>	<i>Speech</i>	<i>Non-speech</i>
Eg. output on visual display	Text	Icon
Presenting information	Slow	Fast
To assimilate information	<ul style="list-style-type: none"> • hear from beginning to end 	<ul style="list-style-type: none"> • message are shorter
	<ul style="list-style-type: none"> • need many words to be understood 	<ul style="list-style-type: none"> • none
	<ul style="list-style-type: none"> • messages are straight forward 	<ul style="list-style-type: none"> • need to think
	<ul style="list-style-type: none"> • no learning necessary 	<ul style="list-style-type: none"> • require learning to understand
	<ul style="list-style-type: none"> • not universal (different languages) 	<ul style="list-style-type: none"> • more universal
Presenting continuous information	Good	Better
Rapid feedback	Good	Better
Convey instruction	Better	Good

Table 4.1: Auditory Feedback: Speech and Non-speech comparison

In the last ten years, several researchers from a variety of disciplines have started using non-speech sounds as part of their user interfaces. In applications, existing work has appeared in two modes: sounds as dimensions for multiversity data presentation [Lunney and Morrison, 1981; Bly, 1982; Mezrich et al., 1984] and sounds to provide feedback and other information to support interaction [Edwards, 1989; Gaver, 1989]. For the former application, data variables were mapped onto sounds and the resulting notes were then played to the user for analysis. Both use sounds as cues to events in their computing environments, although in very different ways; however, in each, actions such as selecting files, locating windows, or searching for text strings are accompanied by sounds that provide feedback to the user.

In VEs, sound can be used not only to immerse the user, making him/her present in the VE, but also to carry information, enhance visual representation and add information beyond our field of view [Begault, 1994]. The interactive nature of VEs also allows sound to be used as feedback to the user's actions [Larsson et al., 2001].

4.2 Auditory Feedback Simulations

This experiment examines whether auditory stimuli can be used as a feedback technique to alert users on their manual lifting condition, specifically to avoid lower back pain. A total of four conditions comprised the experiment: No Feedback, White-noise, Pitch and Tempo. White noise is noise whose amplitude is constant throughout the audible frequency range [Nave, 2000]. It is straightforward to produce white noise - it is often produced by a random noise generator in which all frequencies are equally probable. The sound of white noise is similar to the sound of

steam escaping from an overheated radiator. The ear is aware of many high frequency sounds in white noise since the ear is more sensitive to high frequencies.

Pitch is the highness or lowness of a tone, as determined by the frequency of vibrations per second. A high pitch sound corresponds to a high frequency and a low pitch sound corresponds to a low frequency. The human ear is capable of detecting sound waves within a wide range of frequencies, between approximately 20Hz to 20,000Hz. Any sound with a frequency below the audible range of hearing (i.e., less than 20Hz) is known as an infrasound and any sound with a frequency above the audible range of hearing (i.e., more than 20,000Hz) is known as an ultrasound. [Henderson, 1994].

Tempo is the rate of speed of a repetition of a sound or the speed at which a piece of music is played. Tempo is normally measured in beats per second [Henderson, 1994].

For all three auditory conditions, White-noise, Pitch and Tempo, users received three different real time auditory feedbacks according to the lifting condition being carried out. This feedback is calculated by a NIOSH equation in Eqn. 2.1 and Eqn. 2.2. The users were asked to perform a manual lifting task in safe working conditions throughout the experiment. Unlike the experiments described in the previous chapter, there was no visual display feedback which measured LI values as the only feedback that users had to follow in order to keep their LI results was the auditory feedback.

4.2.1 Methods

4.2.1.1 Participants

Twenty new participants were used, four were female and the remaining sixteen were male, with a mean age of 30.5 years and a standard deviation of 2.83 years. All participants for the experiment were in good health, had no history of any back problems, no vision (after correction) or hearing impairments. None of the subjects had any previous experience of VR.

4.2.1.2 Experimental set-up

The VE software was designed and programmed by the author using CAVELib API. CAVELib API does not contain any audio routines and additional sound libraries are therefore required, such as Bergen. Bergen is an audio server and client library. It was created by Dave Pape at the University of Illinois, Chicago, for use in CAVELib applications. There are two basic parts in Bergen: the client library (libbergen) and the server (snerd). Snerd is the server program which the Bergen client library communicates with in order to play sounds. Communication between clients and snerd is by UDP/IP. Bergen software used an SGI machine that has audio capability as sound server. This experiment used an SGI Octane as a sound server. Snerd uses the SGI audiofile library to read sample files; this means it can play samples in any format supported by that library (AIFF, AIFC, WAVE).

An Onyx 300 visualization server was used to generate the images. A Portico Workwall was used as a large scale display device. Stereoscopic 3D images were created through the use of LCD shutter glasses. The glasses refresh rate was 120Hz (60Hz update for each eye). Six-degrees-of-freedom sensors together with Trackd software was used to track the head and box position and orientation. A 120dB auditorium amplifier was used to produce audio sound for the users. The system architecture is presented in Figure 4.1.

The auditory feedback experiment used Pitch and Tempo which were from the `bergenTone` subclass and White-noise from the `bergenWhiteNoise` subclass. Sound files were created using an SGI Octane machine. Details of the specification of each Auditory feedback technique used are tabulated in Table 4.2. Different intensity, frequency and amplitude used in this table were determined by trial-and-error. Sound files that have been used in this experiment are tabulated in Table 4.3. Figures 4.2, 4.3 and 4.4 show a snapshot of each sound file when played for White-noise, Pitch and Tempo respectively. The intensity was measured in decibels (dB) and frequency was in Hertz (Hz). The experimental design had four experimental conditions; one was an experiment with no feedback and the remaining three conditions were provided with “Auditory” feedback techniques in real-time. Throughout this section, the acronyms below were used to represent each condition:

NF = No Feedback

WN = White-noise

P = Pitch

T = Tempo

The feedbacks provide real-time information of LI value utilising a modified NIOSH equation. The acceptable LI value varied between 0.00 and 0.99 for safe lifts, with values equal to or greater than 1.00 indicating harm to the user. For auditory feedback experiments, three different sound files were used in each category for the user to monitor their back pain according to the calculated LI value.

Once the experiment began, the command “start snerd” had to be performed from the directory where the sound files were located - in an SGI Octane - before running any client program. Users were invited to perform the task to the best of their ability. They were asked to remain within a safe lifting range.

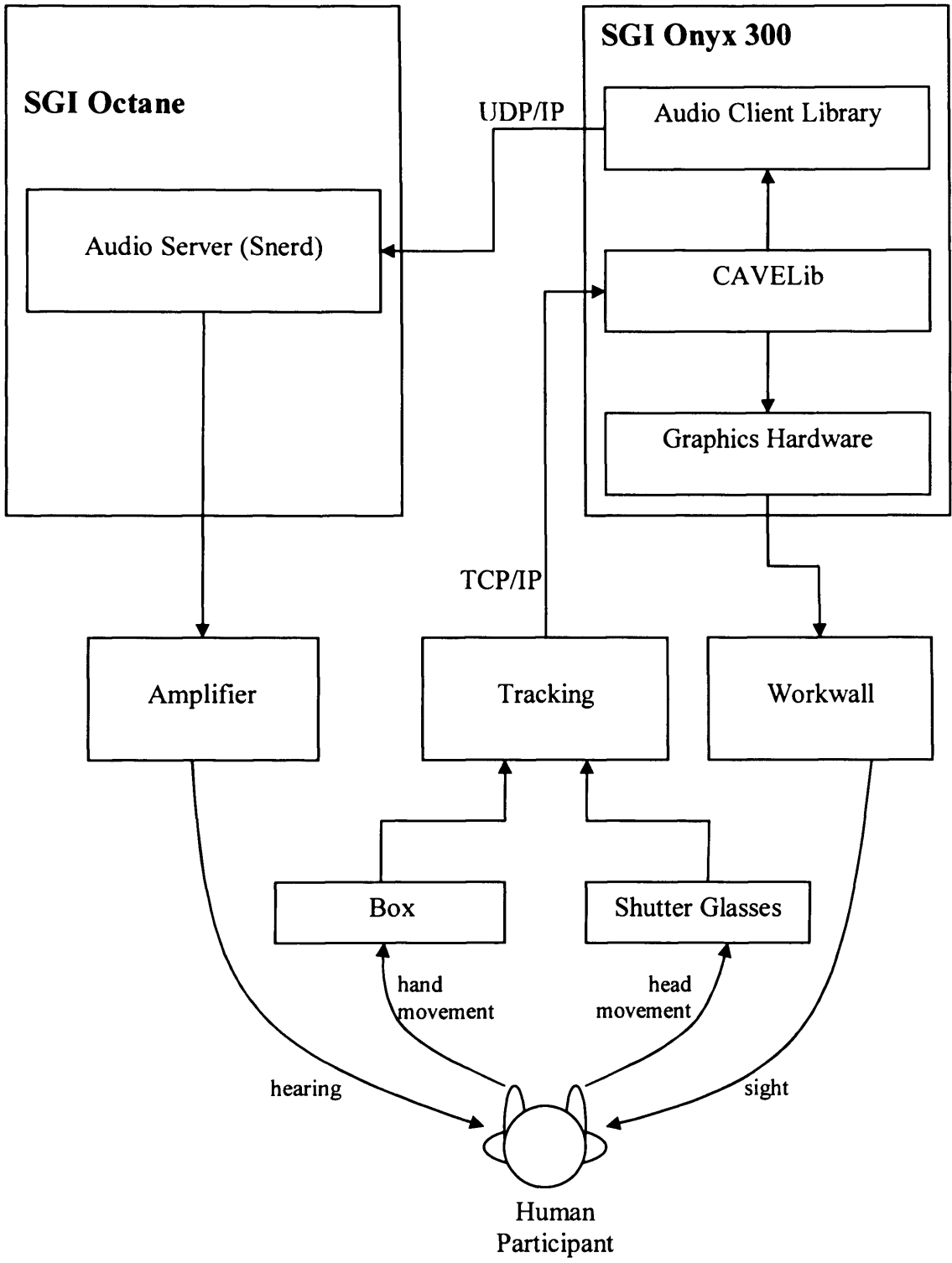

Figure 4.1: System Architecture

Auditory Feedback	White-noise	Pitch	Tempo
Detail Specification	<ol style="list-style-type: none"> 1. Same frequency (4 kHz) 2. Different intensity (20, 50, 70 dB) 3. Same amplitude (10 dB) 	<ol style="list-style-type: none"> 1. Same frequency (360 Hz) 2. Same intensity (50 dB) 3. Different amplitude (5, 15, 35 dB) 	<ol style="list-style-type: none"> 1. Different frequency (1, 1.7, 5 Hz) 2. Same intensity (50 dB) 3. Same amplitude (30 dB)

Table 4.2: Specification of Auditory Feedback Techniques

White-noise	Pitch	Tempo	Notes
Wn_safe.aiff	Pitch_safe.aiff	Tempo_safe.aiff	Safe lifting zone
Wn_risky.aiff	Pitch_risky.aiff	Tempo_risky.aiff	Risky lifting zone
Wn_danger.aiff	Pitch_danger.aiff	Tempo_danger.aiff	Dangerous lifting zone

Table 4.3: Detail of sound files for each category of auditory feedback

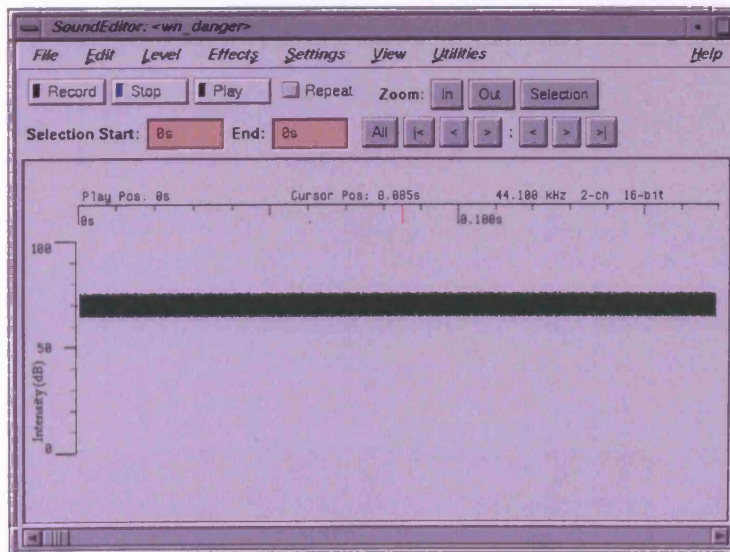
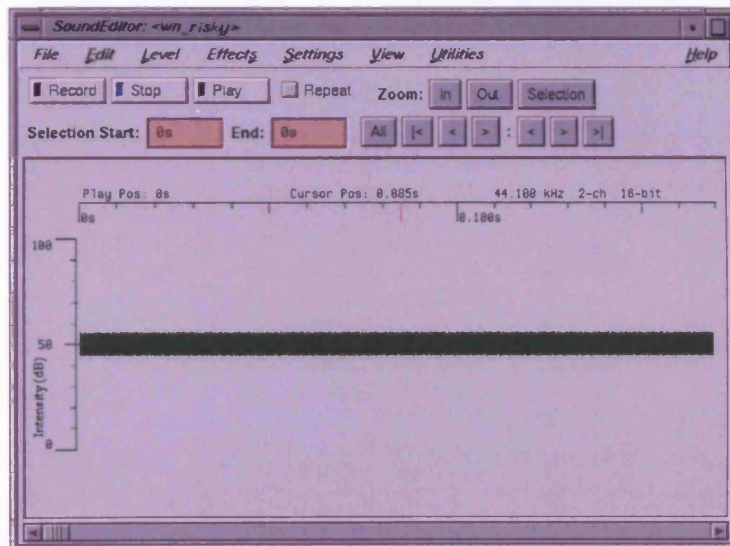
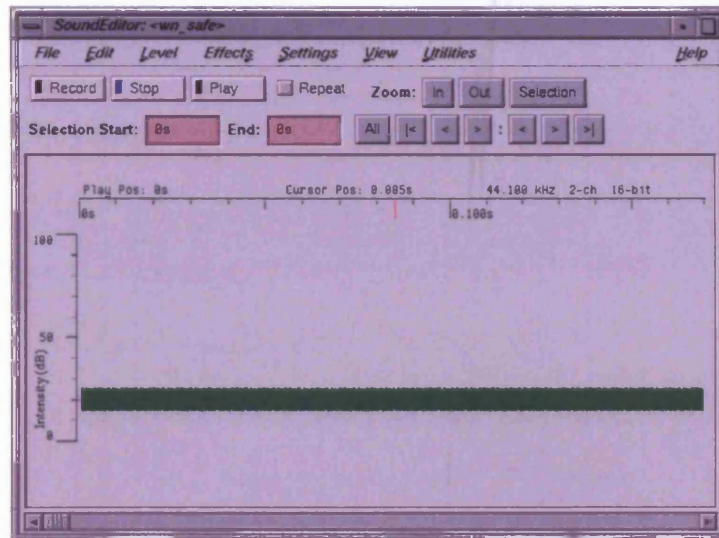

Figure 4.2: Snapshots of Sound Files for White-noise Feedback (From top to bottom: Safe, Risky, Danger)

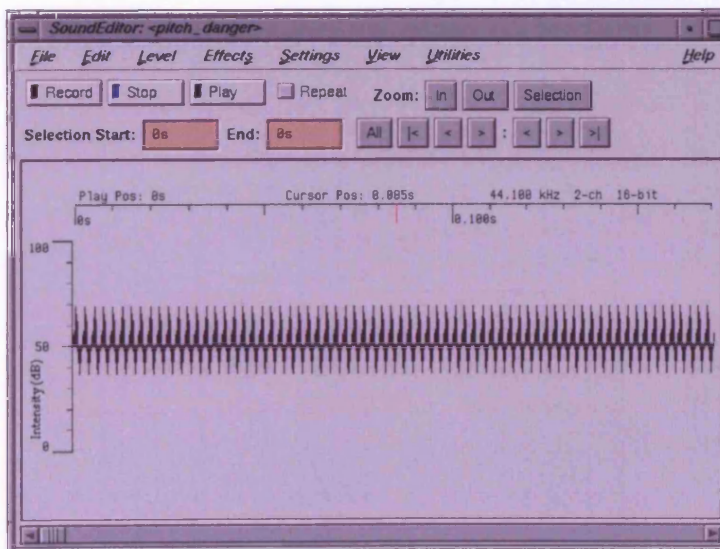
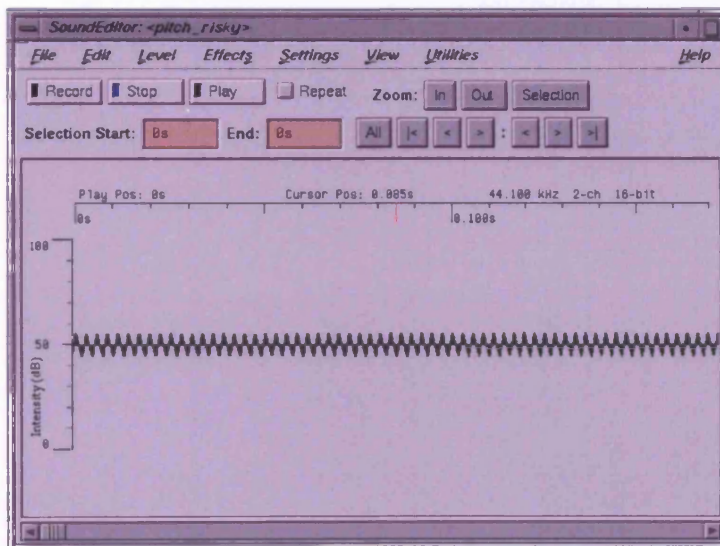
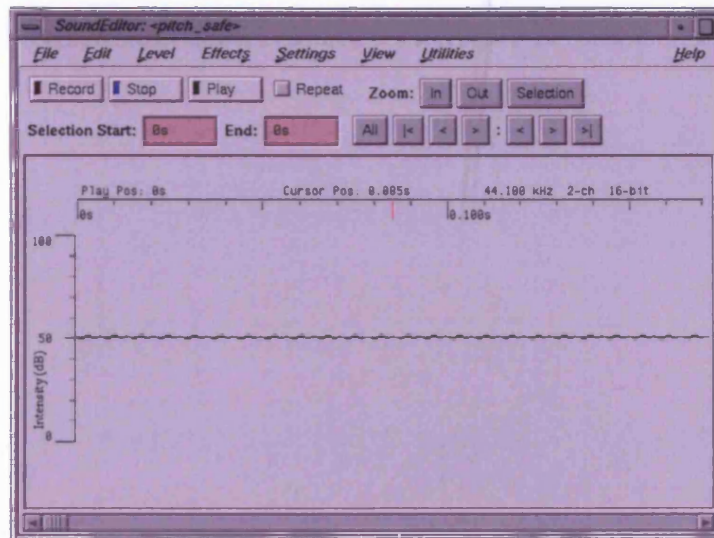

Figure 4.3: Snapshots of Sound Files for Pitch Feedback (From top to bottom: Safe, Risky, Danger)

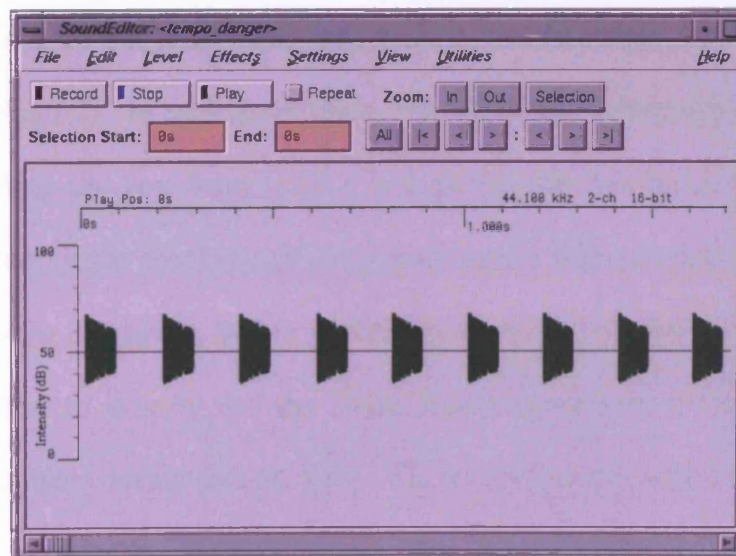
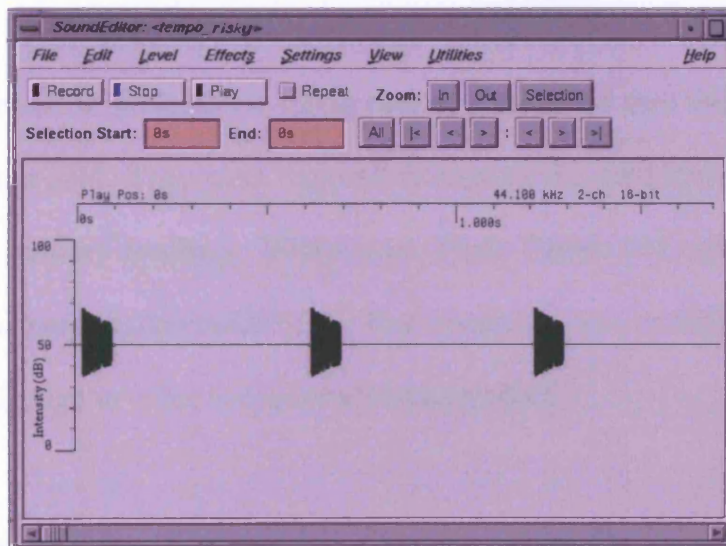
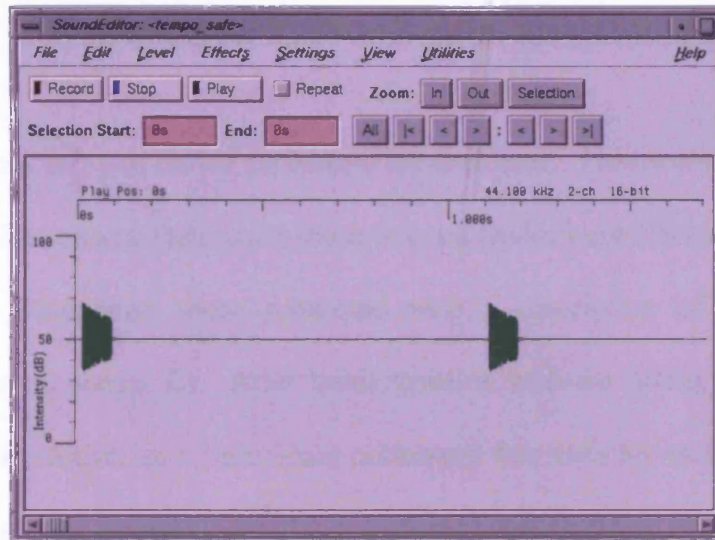

Figure 4.4: Snapshots of Sound Files for Tempo Feedback (From top to bottom: Safe, Risky, Danger)

4.2.1.3 *Experimental procedure*

Each experiment was performed separately for each user. They were required to read and sign a health consent form; only those in good health were allowed to conduct the experiment. Participants were presented with a description of the task to be performed (see Appendix E). After familiarisation with the lifting procedure and a few minutes of practise, each participant performed five trials for each audio category. Each participant was measured and this information was recorded in a data file.

Users were invited to perform the lifting task as if this were their daily task working on an eight hour shift. They were required to conduct the experiment using all three conditions in auditory feedback: White-noise, Pitch, Tempo and experiment with no feedback. The presentation order of the four conditions was controlled by using the Latin Square Design in order to minimise learning effect.

To begin each condition, the user would lift a box, having dimensions of 30 cm wide, 15 cm deep and 40 cm long fitted with handle, from a lower shelf (Shelf 1) to an upper shelf (Shelf 2). In each experiment, ten trials were to be completed. For every trial, after lifting the box from shelf 1 and placing the box to shelf 2 in a proper location guided by the feedback (if any), participants were required to pause (hold) the box static for 2 seconds, before continuing on to the next trial. This delay is for the experimenter to identify that the lifting task is completed, while monitoring the action of the subject during data analysis. The position and orientation of the user and the box were recorded by attached sensors. The time taken to complete each task and the corresponding Lifting Index values were also recorded.

4.2.2 Results

The raw data had to be processed in order to obtain only one LI value for every change of LI made throughout the lifting task. The data from the sensors and the time recorded by the application were analysed according to three categories: Task Completion Time (TCT), Percentage of Harmful Lifts (PHL) and Response Time to Feedback (RTF).

4.2.2.1 Task Completion Time (TCT)

Figure 4.5 shows the average TCT for all conditions. For the condition without feedback, NF was the lowest in terms of TCT since participants did not control their LI value as feedback was not presented in this condition. A one-factor technique ANOVA was used for Task Completion Time analysis. The analysis of this data showed that there was an important effect of technique $F(3,76) = 21.99, p < 0.05$.

A post-hoc Tukey test [Winer et al., 1991] (at $p < 0.05$) was carried out and the results showed significant differences between all pairs except WN and P. Even though all comparisons with NF were significant, these can be ignored since no feedback was present in the NF condition. Participants therefore managed to complete the task faster since they did not need to monitor their lower back condition. This may result in a dangerous lifting technique if no experience in safe ergonomic lifting is acquired. As can be seen, pitch was found to be the best in TCT for auditory feedback technique (mean = 10.78, s.d.= 3.22), followed by white-noise (mean = 11.49, s.d.= 2.27) and Tempo (mean = 15.47, s.d.= 4.17).

4.2.2.2 Percentage of Harmful Lifts (PHL)

The percentage of harmful lifts (PHL) was analysed and the ANOVA revealed a significant effect of technique $F(3,76) = 86.21, p < 0.05$ (refer Figure 4.6). A post-hoc Tukey test was applied to determine which result is significantly different. The results revealed that the percentage differed significantly between WN and T ($P < 0.05$), and between P and T ($P < 0.05$). NF was also shown to be significantly greater than all other techniques.

Pitch was shown to be the best auditory feedback technique (mean = 19.25, s.d.= 4.7). White-noise was found to be only slightly worse than Pitch (mean = 22, s.d.= 6.13). The Tempo feedback technique was the worst auditory technique (mean = 38.25, s.d.= 7.12) significantly larger than Pitch and White-noise. The condition without feedback, NF (mean = 53.5, s.d.= 11.13) could be used as a comparison with other auditory feedback techniques. The results suggest that auditory feedback can be used effectively to aid users in the performance of manual lifting tasks in a safe manner.

4.2.2.3 Response Time to Feedback (RTF)

Figure 4.7 shows Response Time to Feedback (RTF) for conditions of White-noise, Pitch and Tempo. Condition with No Feedback was not included since this analysis examines the difference of time to bring the LI value within the safe working range. A one-factor technique, ANOVA, was used for RTF analysis. The analysis of this data showed that there was no important effect of technique $F(2,57) = 1.76, p < 0.05$.

The analysis shows that Pitch feedback was the best technique to employ as the user can respond to the feedback quickly (mean = 0.51, s.d.= 0.42), followed by White-noise (mean = 0.64, s.d.= 0.32). Tempo feedback was the least effective audio feedback technique (mean = 0.715, s.d.= 0.29).

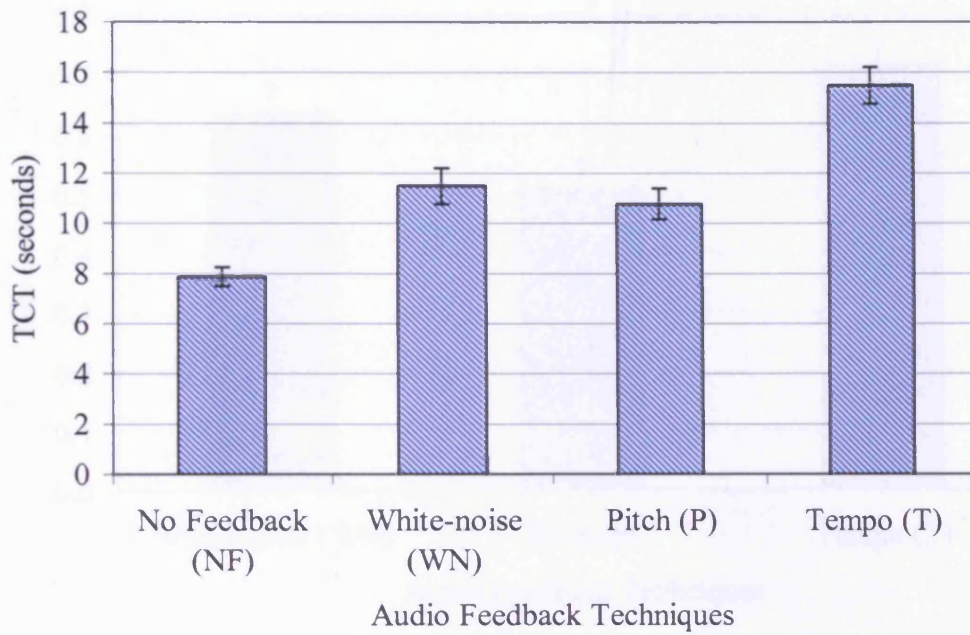

Figure 4.5: Task Completion Time (TCT) for Auditory Feedback Techniques

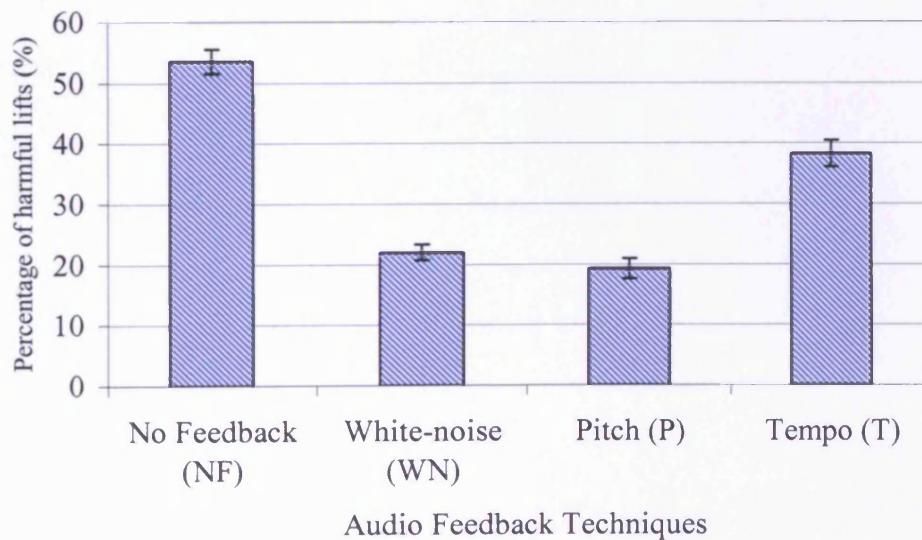

Figure 4.6: Percentage of Harmful Lifts (PHL) for Auditory Feedback Techniques

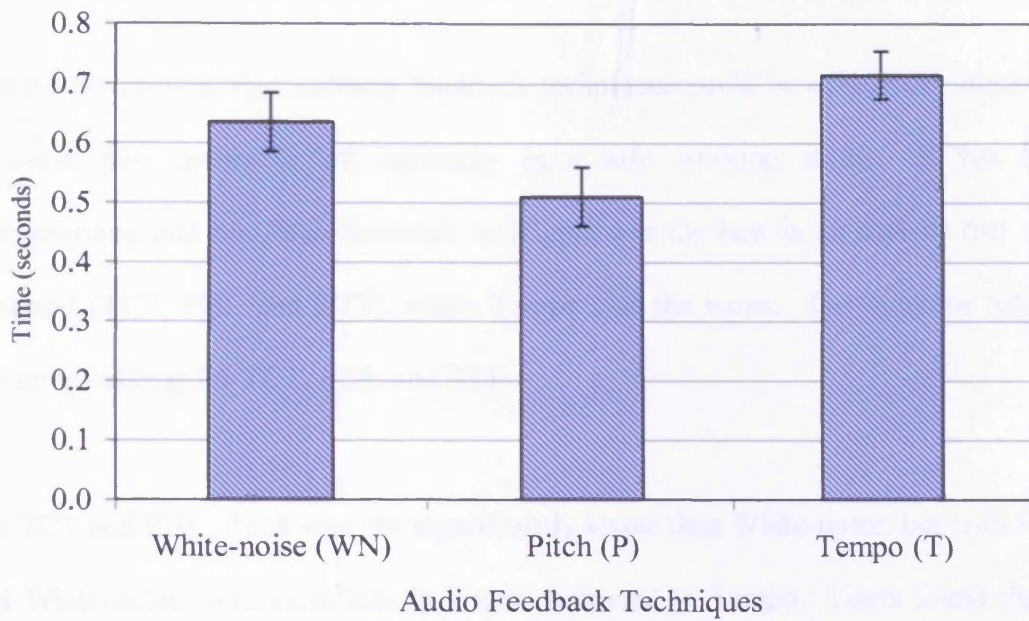

Figure 4.7: Response Time to Feedback (RTF) for Auditory Feedback Techniques

4.2.3 Discussion

The results showed that auditory feedback techniques could be effectively employed to assist participants to lift manually in a safe working mode. It has been demonstrated that the Pitch feedback technique was the best in all aspects that were analysed (TCT, PHL and RTF), while Tempo was the worst. The outcome follows the same ranking for TCT, PHL and RTF.

For TCT and PHL, Pitch was not significantly lower than White-noise, but both Pitch and White-noise were significantly lower compared to Tempo. Users found that in the Tempo technique, it was difficult to follow the change of feedback received. This was found from the questionnaire given after the experiment, as shown in Appendix F. Findings from the questionnaire also found that, even though users say it was difficult to differentiate the three levels of White-noise, the results for White-noise were still far better than for Tempo.

4.3 Audio and Visual (AV) Feedback Simulations

This experiment evaluated the effect of combining Auditory and Visual (AV) feedback to enhance user performance in ergonomic lifting. Only three combination AV experiments were carried out in this study. Three types of auditory feedback (White-noise, Pitch and Tempo) were combined with three types of Visual Display feedback (COMBI, Colour and Text). Fractional factorial design had to be considered to reduce the total number of runs required. Barnes [Barnes, 1994] established that if

order is not important, then the quantity of interest is the number of combinations of n things taken r at a time. This may be presented:

$${}^n C_r = \frac{n!}{(n-r)!r!} \quad (\text{Eqn. 4.1})$$

The number of combinations of n things taken r at a time

Since the total number of feedback types is six (three from audio feedback and three from visual display feedback) and the combinations of types of feedback required to be combined are two at a time (audio and visual),

$${}^6 C_2 = \frac{6!}{(6-2)!2!}$$

$$= \frac{6.5.4.3.2.1}{(4.3.2.1)2.1} = 15$$

According to above calculation, combinations of 15 feedbacks have to be performed. However, the combination of feedback types cannot be done within the same feedback types. For example, combination of Pitch and Tempo cannot be possible for combined Audio-Visual since they are in the same group. Therefore, after considering the feedback types as well as ranking from previous results, only three combination need to be conducted which are tabulated in Table 4.4 below:

<i>Audio</i>	<i>Visual</i>	<i>Combined AV</i>
Pitch	COMBI	Pitch + COMBI
Pitch	Colour	Pitch + Colour
White-noise	COMBI	White-noise + COMBI

Table 4.4: Combined Audio-Visual(AV) Feedback Techniques

4.3.1 Method

4.3.1.1 Participants

This experiment used sixteen men and four women adult participants (the same participants as in Experiment 4.2), with a mean age of 30.5 years and a standard deviation of 2.83 years. All of the participants complied with the same health regulations as Experiment 4.2.

4.3.1.2 Experimental set-up

As this experiment combined both Auditory and Visual feedback, the experimental set-up was similar to Experiment 3.2 and Experiment 4.2. The application was an additional CAVELib program developed by the author, combined with the sound files from the sound server. All run time values were recorded, i.e., sensor readings, time and LI value. The non-run time values include feedback technique, trial number and user details. Six degrees of freedom sensors together with Trackd software were used to track the head (attached with the LCD shutter glasses) and box position and orientation (box dimensions of 30cm wide, 15cm deep and 40cm long and fitted with a handle). A 120dB auditorium amplifier was used to produce sound for the users.

The VE used was similar to that in Experiment 3.2 and 4.2. This experiment consists of three different combinations of AV (Audio Visual), i.e.

1. Pitch and COMBI
2. Pitch and Colour
3. White-noise and COMBI

4.3.1.3 Experimental procedure

Participants were asked to perform similar tasks as in Experiment 4.2, but they received both Auditory and Visual feedback simultaneously. They had to respond to the given feedback to the best of their ability, and they were required to carry out 10 lifts for each combination. The presentation order was again controlled using the Latin Square Design. Each user performed ten trials for each combination category after familiarisation with the lifting procedure and a few minutes of practice.

4.3.2 Results

4.3.2.1 AV Feedback –Pitch and COMBI

According to Table 4.4, the combination between Pitch and COMBI would be expected to get a good result since it was a combination of the best Auditory feedback with the best Visual Display feedback.

4.3.2.1.1 Task Completion Time (TCT)

Figure 4.8 shows the average TCT for all conditions. An ANOVA was used for the Task Completion Time analysis and the results showed that there was an important effect of technique $F(2,57) = 5.71, p < 0.05$.

A post-hoc Tukey test (at $p < 0.05$) was carried out and the results showed significant differences between “Purely Visual and Purely Audio” and “Purely Audio and Combined AV”. From the plotted graph, it can be seen that Purely Visual feedback was the shortest in TCT (mean = 8.51, s.d.= 0.86), followed by Combined AV (mean = 8.97, s.d.= 1.6) and Purely Audio (mean = 10.59, s.d.= 3.04).

4.3.2.1.2 Percentage of Harmful Lifts (PHL)

An ANOVA was used for PHL analysis and this data showed that there was an important effect of technique $F(2,57) = 3.89, p < 0.05$. A post-hoc Tukey test (at $p < 0.05$) was then carried out and showed that Combined AV significantly reduced the Percentage of Harmful lifts (PHL) compared to the Pitch condition. Comparison of Combined AV and COMBI showed no significant reduction in PHL. However, Combined AV has a better result in PHL compared to COMBI. The details are shown in Figure 4.9

4.3.2.1.3 Response Time to Feedback (RTF)

A repeated measures ANOVA test indicated a significant difference among the types of feedback $F(2,57) = 3.20, p < 0.05$. A post-hoc Tukey test (at $p < 0.05$) showed that the Combined AV technique was significantly better than the Pitch feedback technique. The test also showed that RTF was marginally better (although not significantly) for the Combined AV compared to the COMBI. Figure 4.10 shows the detail.

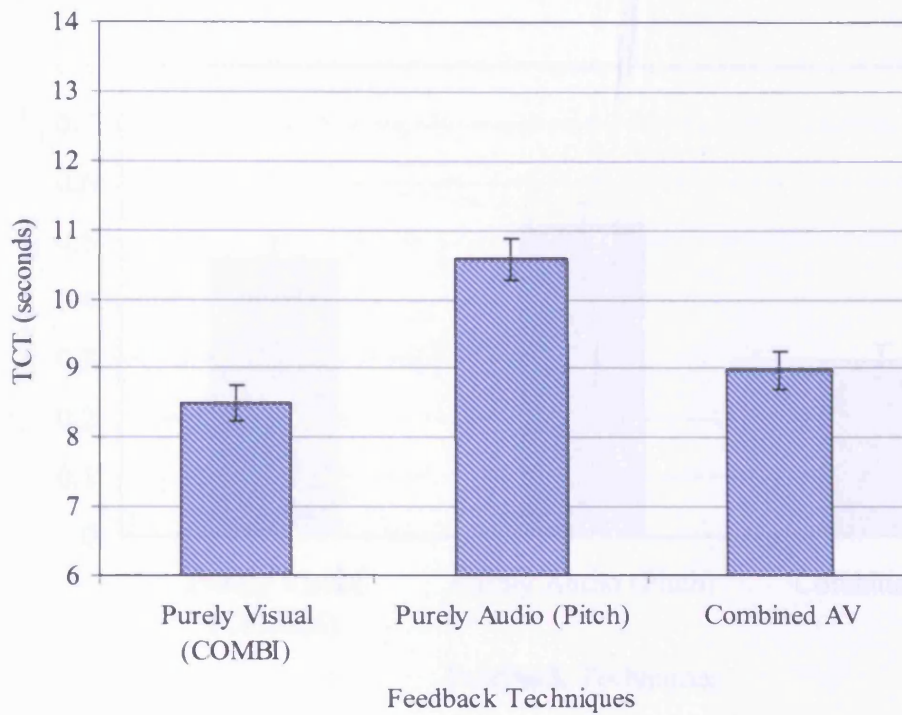

Figure 4.8 : Task Completion Time (TCT) for Sole and Mixed Feedback Techniques

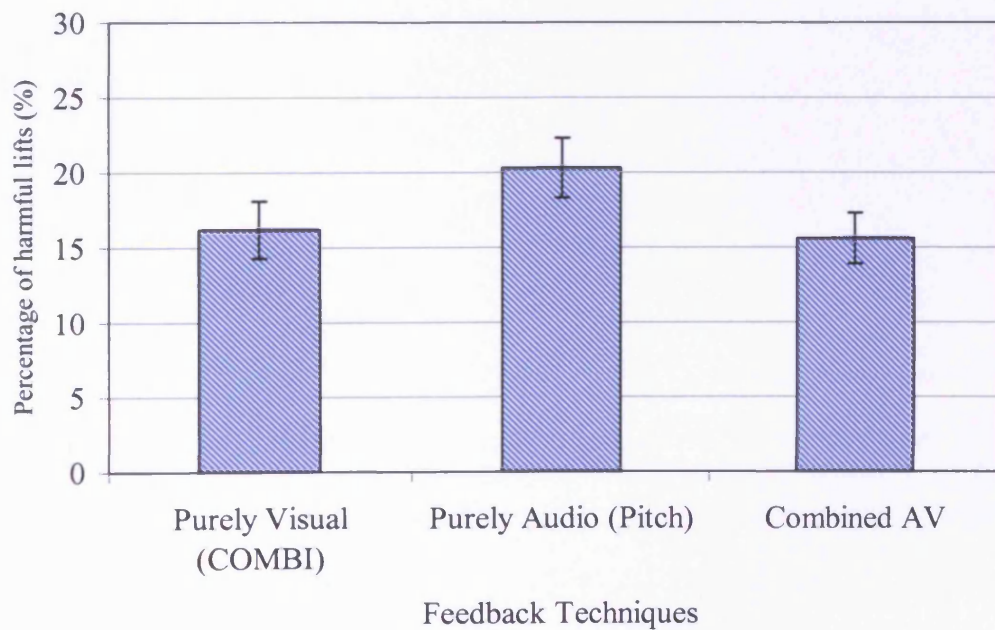

Figure 4.9 : Percentage of Harmful Lifts (PHL) for Sole and Mixed Feedback Techniques

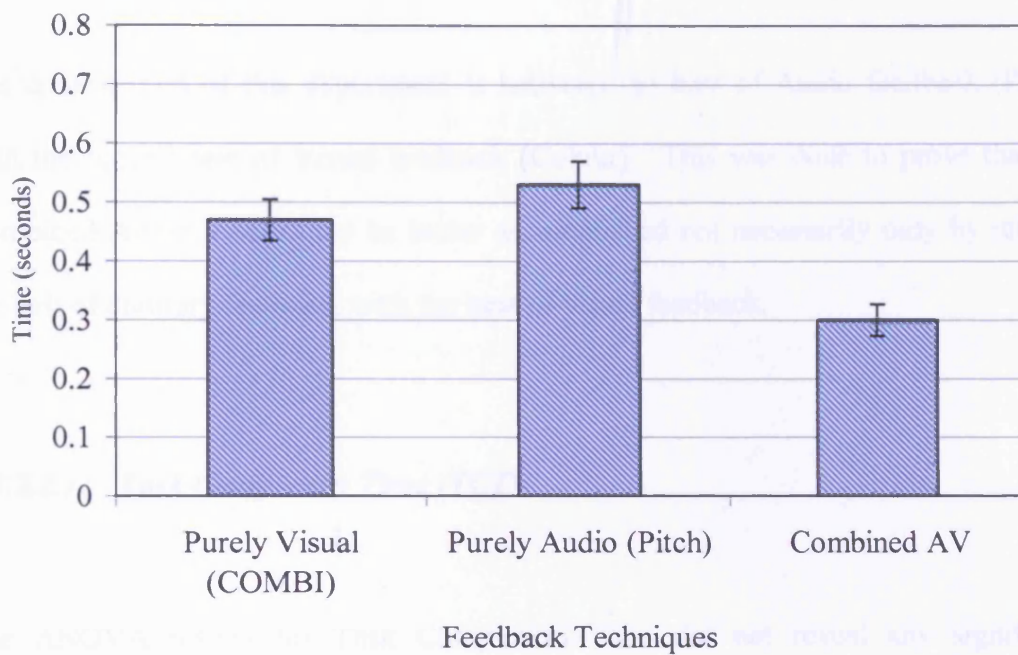

Figure 4.10 : Response Time to Feedback (RTF) for Sole and Mixed Feedback Techniques

4.3.2.2 AV Feedback –Pitch and Colour

The combination of this experiment is between the best of Audio feedback (Pitch) with the second best of Visual feedback (Colour). This was done to prove that the Combined Audio-Visual may be better accomplished not necessarily only by mixing the best of auditory feedback with the best of visual feedback.

4.3.2.2.1 Task Completion Time (TCT)

The ANOVA results for Task Completion Time did not reveal any significant difference between the experimental conditions $F(2,57) = 0.25$, $p < 0.05$ (refer Figure 4.11). In fact, the average for Combined AV was the longest (mean = 10.68, s.d.= 1.92), compared to Purely Audio (mean = 10.59, s.d.= 1.69) and Purely Visual (mean = 10.17, s.d.= 1.71).

4.3.2.2.2 Percentage of Harmful Lifts (PHL)

Once again, ANOVA results did not show any significant difference between feedback techniques $F(2,57) = 0.8$, $p < 0.05$. However, the average was better than Purely Visual but worse than Purely Audio (refer Figure 4.12). Detailed results were Purely Visual (mean = 22.5, s.d.= 4.7), Purely Audio (mean = 20.25, s.d.= 5.9) and Combined AV (mean = 21.8, s.d.= 6.13).

4.3.2.2.3 Response Time to Feedback (RTF)

The ANOVA results for RTF did not reveal any significant difference between the experimental conditions $F(2,57) = 0.16, p < 0.05$. RTF for Combined AV was slightly better (though not significant) than both Purely Visual and Purely Audio feedback techniques. Detailed results were Purely Visual (mean = 0.51, s.d.= 0.31), Purely Audio (mean = 0.53, s.d.= 0.35), and Combined AV (mean = 0.47, s.d.= 0.35). Figure 4.13 shows this detail.

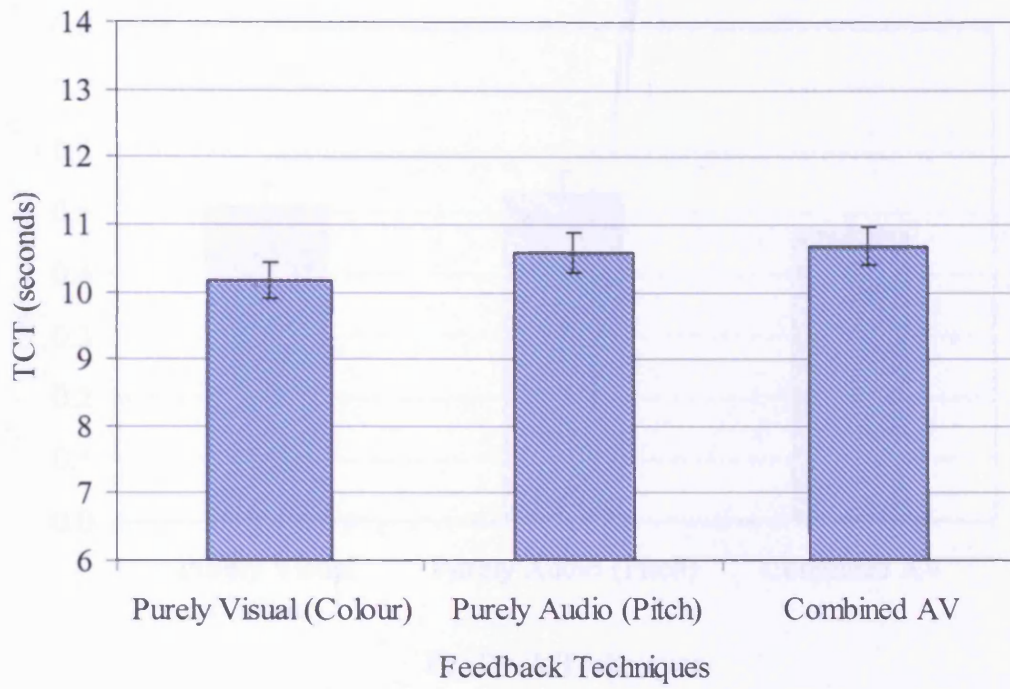

Figure 4.11 : Task Completion Time (TCT) for Sole and Mixed Feedback Techniques

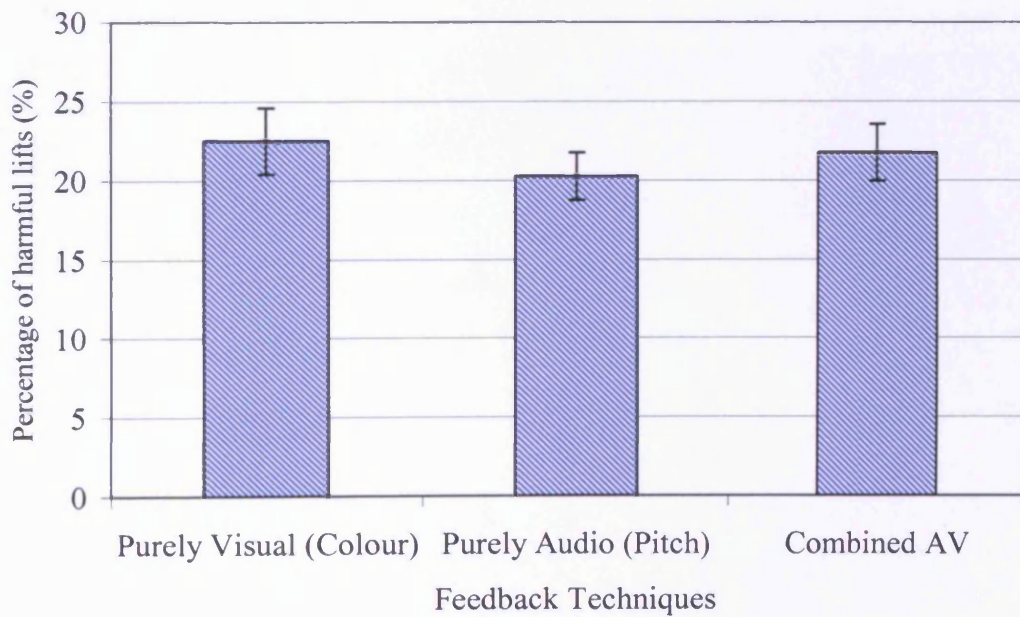

Figure 4.12 : Percentage of Harmful Lifts (PHL) for Sole and Mixed Feedback Techniques

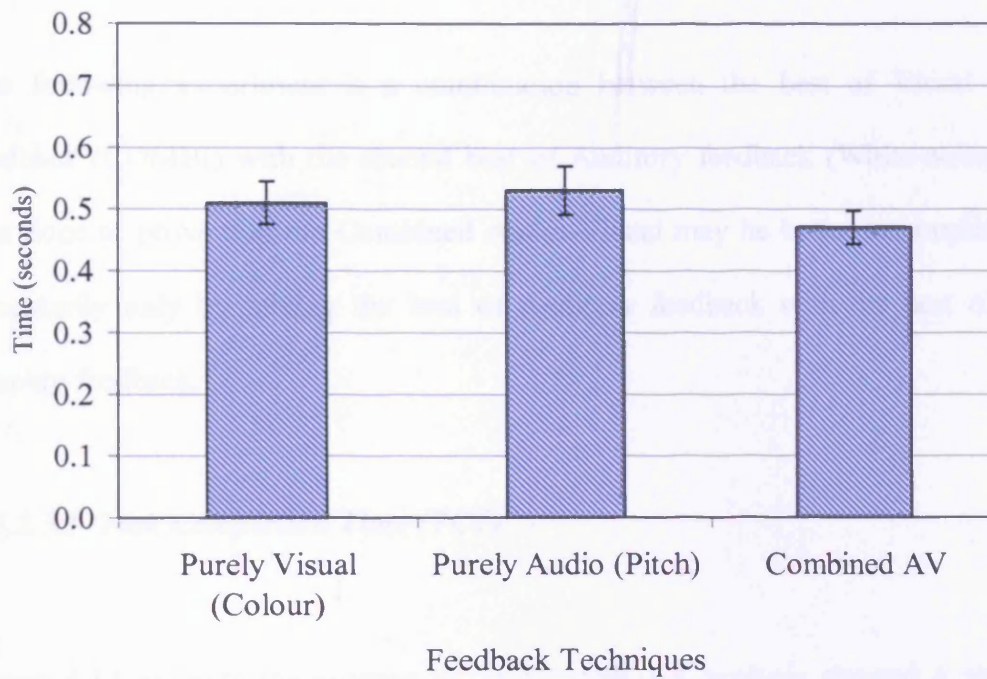

Figure 4.13 : Response Time to Feedback (RTF) for Sole and Mixed Feedback Techniques

4.3.2.3 AV Feedback –White-noise and COMBI

The following experiment is a combination between the best of Visual Display feedback (COMBI) with the second best of Auditory feedback (White-noise). This was done to prove that the Combined Audio-Visual may be better accomplished not necessarily only by mixing the best of Auditory feedback with the best of Visual Display feedback.

4.3.2.3.1 Task Completion Time (TCT)

Figure 4.14 presents the average of TCT. ANOVA analysis showed a significant effect of feedback technique in Task Completion Time $F(2,57) = 29.47, p < 0.05$. A post-hoc Tukey test (at $p < 0.05$) showed that Combined AV was significantly longest in TCT among other types of feedback technique (mean = 13.06, s.d.= 0.41) compared to White-noise (mean = 11.37, s.d.= 0.25) and COMBI (mean = 8.5, s.d.= 0.19).

4.3.2.3.2 Percentage of Harmful Lifts (PHL)

The ANOVA analysis reveals that there was a statistically significant effect of feedback techniques $F(2,57) = 10.12, p < 0.05$. A post-hoc Tukey test (at $p < 0.05$) showed that Combined AV was significantly higher in PHL than COMBI (refer to Figure 4.15). Combined AV was also found to be slightly higher than White-noise but the difference was not significant (COMBI: mean = 16.25, s.d.= 5.6; White-noise : mean = 23.5, s.d.= 6.3 and Combined AV: mean = 23.75, s.d.= 6.04).

4.3.2.3.3 *Response Time to Feedback (RTF)*

Results from an ANOVA analysis did not show any significant effect of feedback techniques in RTF $F(2,57) = 2.06, p < 0.05$ (refer Figure 4.16). In comparison of Combined AV with COMBI and White-noise, Combined AV was the longest in overall mean, which were (mean = 0.62, s.d.= 0.28), COMBI (mean = 0.47, s.d.= 0.36) and White-noise (mean = 0.45, s.d.= 0.17).

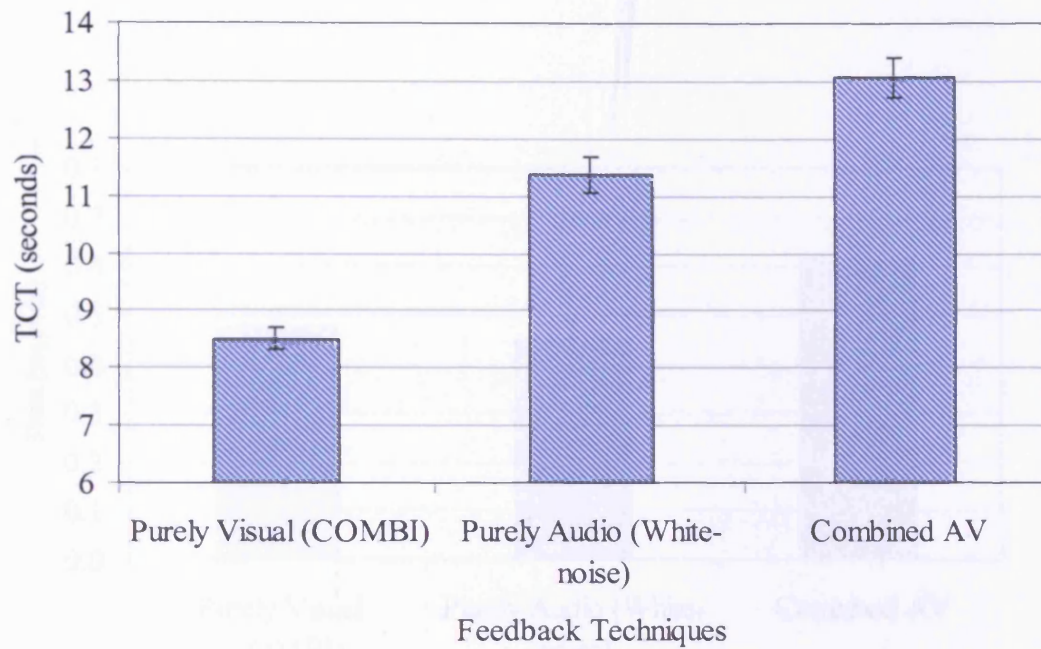

Figure 4.14 : Task Completion Time (TCT) for Sole and Mixed Feedback Techniques

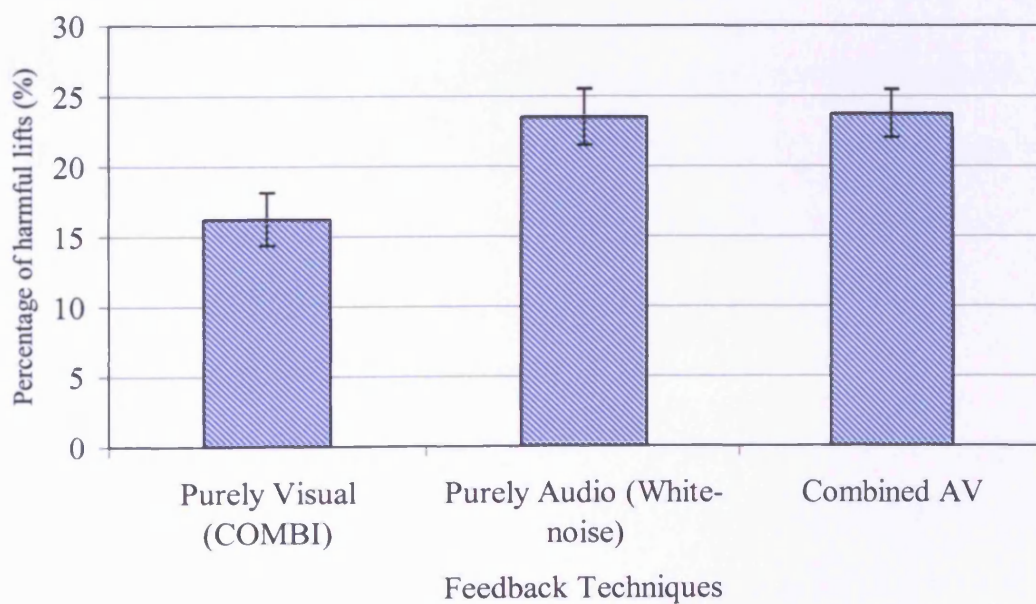

Figure 4.15 : Percentage of Harmful Lifts (PHL) for Sole and Mixed Feedback Techniques

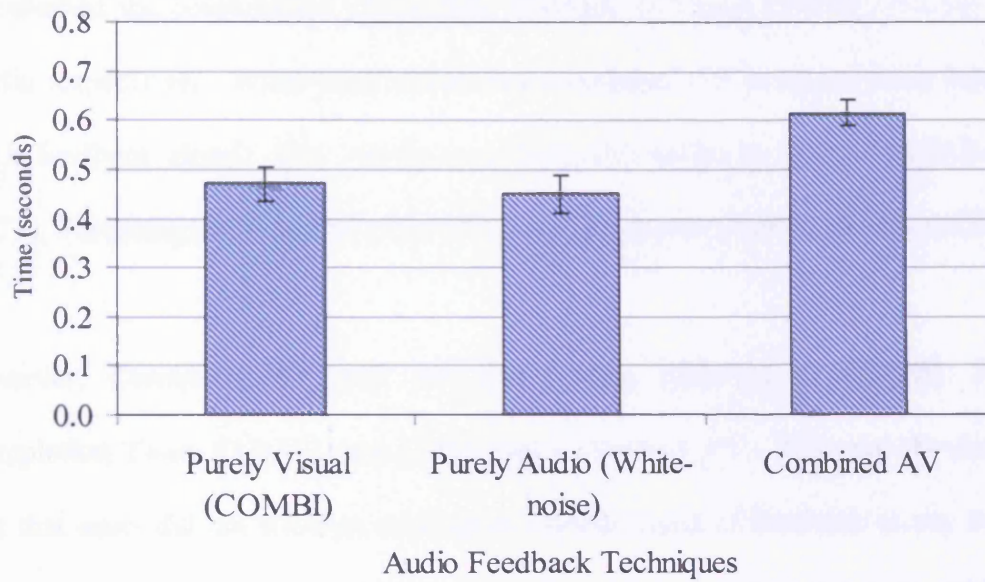

Figure 4.16 : Response Time to Feedback (RTF) for Sole and Mixed Feedback Techniques

4.3.3 Discussion

The first combination of AV carried out was between COMBI and Pitch, which represented the combination of the best feedback in Visual Display with the best in Audio respectively. It has been shown that Combined AV is significantly better than Pitch feedback alone. This can be seen from the results in Task Completion Time (TCT), Percentage of Harmful Lifts (PHL) and Response Time to Feedback (RTF).

However, Combined AV was not significantly different to COMBI. In Task Completion Time, COMBI was better than Combined AV. This may be due to the fact that users did not manage to adapt to various types of feedback at any one time, hence delaying their work tasks. With Percentage of Harmful Lifts (PHL) and Response Time to Feedback (RTF), Combined AV was not significantly different to COMBI, but they achieved better results in mean and s.d. when compared to COMBI.

The combination between Pitch and Colour did not reveal any significant differences in all aspects (TCT, PHL and RTF). In fact Combined AV was the longest in TCT compared to Purely Visual and Purely Audio. Mean PHL for Combined AV was between the mean of Purely Visual and Purely Audio, while for RTF Combined AV was the best among Purely Visual and Purely Audio.

Combined AV between White-noise and COMBI gave significantly higher results in TCT compared to both Purely Visual and Purely Audio. For PHL, again the Combined AV resulted in a significantly higher percentage than Purely Visual. Just like TCT, PHL also showed Combined AV as the highest in percentage value. RTF

did not show any significant difference and Combined AV gave poor results when compared to other feedback techniques..

4.4 General Discussion

The experimental investigation of using auditory feedback techniques to aid ergonomic lifting found that sound can be used to give real-time feedback to the lifter, either solely or combined with visual feedback. Pitch outperformed White-noise and Tempo in TCT, PHL and RTF. If a comparison is made between Purely Visual and Purely Audio, the best of Purely Visual (COMBI) was better than Purely Audio (Pitch).

The study also demonstrated that a combination of Auditory feedback and Visual Display Feedback could give better results if an appropriate combination was chosen. Combined AV for COMBI and Pitch was the best in RTF and PHL. If, however, this was compared with Purely Visual (COMBI) in TCT, COMBI was better. Users found it was easier to respond to Combined AV feedback when their LI values reached a certain limit. The RTF results for Combined AV were 36% and 43% lower in time compared to Purely Visual and Purely Audio respectively. Therefore, participants could react faster to bring the LI values to the safe working zone.

Unlike a Combined AV of COMBI and Pitch, Combined AV for Pitch and Colour gave uncertain results. It showed the best results in RTF (with only very small differences, i.e. 7% lower than Colour and 11% lower than Pitch). In PHL, the Combined Pitch and Colour only showed 3% better than Colour, and 7% worse than

Pitch. While in TCT, Combined Colour and Pitch was the longest, but only small differences occurred compared to other types of feedback technique (4.3% and 4.7% longer than Pitch and Colour respectively).

A combination of White-noise and COMBI feedback was not practical since this combination performed very poorly in TCT and PHL as well as RTF. Combined WN and COMBI showed the longest TCT (35% longer than COMBI and 13% longer than WN). Harmful lifts for “Combined WN and COMBI” resulted in greater percentages (poor results), 1% and 31.6%, compared to WN and COMBI respectively. The same applied to RTF as Combined AV was 23.5% and 27% longer than COMBI and WN respectively.

4.5 Summary

The purpose of this research was to investigate the effectiveness of using auditory feedback techniques to enable the user to perform a manual lifting task safely without causing harm to their lower back. Three types of auditory feedback experiment were performed and all results were analysed to determine which were the best types of auditory feedback to be chosen to combine with visual feedback.

A selection process for combined Auditory and Visual (AV) feedbacks was carried out and only three Combined AVs were evaluated. Overall results showed that only a Combined AV between Pitch and COMBI gave better results in RTF and PHL. However, its TCT was not the best since Purely Visual still outperformed Combined AV in TCT.

Chapter 5

Tactile Augmentation and Training Effect

This chapter seeks to investigate and develop a better understanding of whether or not tactile augmentation improves manipulation performance in VE applications in the training of humans to perform manual lifting safely. Recent trends in VEs are to move the interaction away from the computer's domain to the user's domain by the use of devices or objects which allow the user to work more naturally with the feedback received from both real and virtual environments. For this reason, real weights (which vary between 2 kg, 4 kg and 6 kg) were placed inside the box for the experiment. These weights were determined by trial-and-error which is different from the set of weights (5 kg, 8 kg and 12 kg) used in Weight Perception Test, described in section 3.3.

The effects of training with virtual lifting, that utilise visual display feedback to encourage users to adopt appropriate lifting methods, were also investigated. The study explores the learning pattern with a thorough examination on a lifting trajectory for lifting tasks. Participants conducted a Self-Training Phase before performing a Test Phase. Subjects' performance was compared between these two phases, where Task Completion Time and Lifting Index values were monitored.

This chapter's structure is as follows: first, the background work for this research area is presented with an explanation of some terminology. The method of conducting the first experiment is then described, followed by the results and discussion. The second experiment is then described, which was used to assess the effect of training on the learning curve. The second experiment consists of method, results and discussion. A general discussion and summary of the presented research concludes this chapter.

5.1 Previous Work

In this section there is a discussion of two particular issues; haptic feedback and the effect of virtual training.

5.1.1 Haptic Feedback

Methods of providing visual and auditory feedback in virtual environments are relatively well developed and attract a great deal of research [Aldridge et al., 1996]. In contrast, the feedback associated with touch (or haptic) remains a challenging research problem.

Several researchers agree that the principal reasons why no device has been fully capable of supporting the haptic system are the complicated structure of the underlying physiology of these processes [Boud et al., 2000], that they are complicated to use [Lécuyer et al., 2004], limitations of workspace [Ye et al., 2003] and expense [Johansson and Linde, 1998; Lecuyer et al., 2000; MacLean, 2000; Lécuyer et al., 2004].

Haptic interaction consists of providing the user of a Virtual Reality system with the sensations involved in touch, that is tactile, proprioceptive and force feedback. [Crison et al., 2004]. The word 'haptic' is derived from the Greek *haptesthai* meaning "to touch" [Birmanns and Wriggers, 2003]. Ellis et al. [Ellis et al., 1996] describe the human haptic system as “the sensory system which includes proprioceptive sensing of muscle/tendon states as well as tactile sensing of skin deformation”. Burdea [Burdea, 1996] explained that force feedback integrated in a VR simulation provides data on a virtual object such as hardness, weight and inertia. Tactile feedback is used to give the user a feel of the virtual object surface contact geometry, smoothness, slippage, and temperature. Finally, proprioceptive feedback is the sensing of the user's body position or posture. Details of the definition of each term related to haptic sensation is tabulated in Table 5.1 [Oakley et al., 2000].

Term	Definition
Haptic	Relating to the sense of touch.
Proprioceptive	Relating to sensory information about the state of the body (including cutaneous, kinesthetic, and vestibular sensations).
Vestibular	Pertaining to the perception of head position, acceleration, and deceleration.
Kinesthetic	Meaning the feeling of motion. Relating to sensations originating in muscles, tendons and joints.
Cutaneous	Pertaining to the skin itself or the skin as a sense organ. Includes sensation of pressure, temperature and pain.
Tactile	Pertaining to the cutaneous sense but more specifically the sensation of pressure rather than temperature or pain.
Force Feedback	Relating to the mechanical production of information sensed by the human kinaesthetic system.

Table 5.1: Definitions of Terminology [Oakley et al., 2000]

Even though many assume that haptic feedback may enhance the realism of a virtual environment, several researchers found that haptic feedback did not statistically improve subjects performance in task completion time [Lécuyer et al., 2002; Wall et al., 2002; Lathan & Tracey, 2002; Feintuch et al., 2004; Poupyrev et al., 2004].

Numerous researchers have suggested replacement solutions [Lécuyer et al., 2000; Lécuyer et al., 2004] such as pseudo-haptic feedback, which combines visual feedback with the use of a passive input device. This kind of haptic feedback has interested many researchers, which concentrates on the use of passive haptic devices together with visual feedback. These can produce a sense of touch with minimal cost and without complex mechanical devices. Static haptics, tactile augmentation, and instrumented objects are among the alternative terms used to refer to approaches using rigid objects in the real world to provide a sense of touch to users interacting with virtual environments [Hoffman, 1998; Lindeman et al., 1999; Boud et al., 2000; Insko, 2001]. Boud [Boud et al., 2000] presented a method of providing haptic feedback using real instrumented objects, where the user can grasp, pick and manipulate objects, thus providing the user with tactile, force and kinaesthetic feedback.

Table 5.2 [Boud et al., 2000] represents a simple classification of visual and haptic feedback on the basis of whether the domain of the feedback is real or virtual. Cell A represents real-task performance; cell B represents telemanipulation (often performed with visual display); cell C represents conventional VR; and cell D represents real

haptic augmentation of a visually displayed VE. This research will examine D in more detail for a manual lifting simulation.

Haptic Feedback	Visual feedback	
	Real	Virtual
Real	A	D
Virtual	B	C

Table 5.2: Feedback Classification [Boud et al., 2000]

A study by Hoffman [Hoffman, 1998] explored the impact of physically touching a virtual object on how realistic the VE seems to the user. His research was the first empirically to demonstrate the effectiveness of mixed reality as a simple, safe, and inexpensive technique for adding physical texture and force feedback cues to virtual objects with large freedom of motion. A comparison was made for two groups. The task set was to pick up a 3D virtual image of a kitchen plate using a cyberhand in VE. The two groups were: a “No touch” group and a “See and touch” group. A user in the “No touch” group picked up the plate using a traditional 3D wand, while a user in the “See and touch” group physically picked up a virtual plate possessing solidity and weight, using a mixed-reality force feedback technique. In the latter group, the user actually grabbed the real plate with his/her real hand. The VR system tracked the position and orientation of the real plate, so that any changes of the location of the real plate was mimicked by the virtual plate seen in VR. Hoffman claimed that “as a result of the brain’s propensity to unify disparities in the two modalities of input and for vision to dominate, the visual virtual object captured the tactile properties of the real object”. His study demonstrated the effectiveness of tactile augmentation as a technique for adding texture and force feedback cues to virtual objects.

Similar issues were also raised by other researchers. Hand [Hand, 1997] described kinaesthetic feedback and tactile feedback as a “Natural Feedback”. He observed that kinaesthetic feedback allows users to know the position of their limbs and manipulators relative to the rest of the body, whereas the touch sensors in the manipulators and throughout the skin allow tactile feedback on the texture, shape and temperature of a surface. He claimed that “providing feedback by manipulating physical input devices which closely correspond to virtual objects is an important step towards bridging the gap between knowing what we want to do and knowing how to do it”.

Other research carried out using physical input devices include studies by Murakami & Nakajima [Murakami and Nakajima, 1994], who used deformable shapes to interact with virtual space and Hinckley et al. [Hinckley et al., 1994], who used an instrumented cutting plane to inspect brain scans.

To the best of the author’s knowledge, no study has been done in virtual lifting which uses both real (natural feedback) and virtual feedback to control user’s back pain in a manual lifting task. This study is consistent with the trend of recent VR technology, which is moving closer to the user’s domain by adding physical qualities to virtual objects as a technique for adding texture and force feedback cues to virtual object. The experiment of using real weight for manual lifting has therefore been conducted to compare it with user performance when lifting a virtual weight only. Before presenting the experiment in further detail, another topic which covers virtual training effect in VEs will be discussed.

5.1.2 Virtual Training Effect

Virtual reality technology is a powerful tool for training humans to perform dangerous, inconvenient or expensive tasks in a proper way [Kalawsky, 1993]. For example, flight simulators have been used to train pilots [Platt et al., 1991] and surgeons practise new procedures before they operate on patients [Moody et al., 2001; Gerovichev et al., 2002]. Adams et al. [Adams et al., 2001] have undertaken work in this field. They concluded that task completion times to perform manual assembly tasks were reduced when subjects trained with force feedback rather than those who received no training.

D'huart [D'huart, 2002] stated that “a virtual environment for training cannot be developed independently of the education problem we want to solve”. He suggested that hypotheses need first to be developed, as the best way to learn any particular task. The most effective way to learn is to rehearse and practise. This fact has been supported by several researchers [Genaidy, 1991; Lavendar, 2000; Lintern, 1980]. A study conducted by Agruss [Agruss et al., 2004], demonstrates that the feedback given during training on manual material handling can reduce the risk of lumbosacral compression.

The experimental hypothesis for this research was therefore that differences would occur in task completion time and performance on the LI value, before and after a training session.

The learning curve/lifting trajectory will be studied in detail in this research. A learning curve can be divided to three phases, “initiation phase” (before start of the lift), “lifting phase” and “placement phase” [Amos, 2001].

5.2 Trials Using Real Weighted Objects

This experiment explored the impact of physically lifting a real weighted box on how realistic the VE seems to the user. Tactile augmentation which comes from touching real objects while in VEs is an effective alternative mixed reality technique for introducing tactile feedback [Hoffman, 1998]. The recent trend in Human Computer Interaction (HCI) is to move the interaction even closer to the user’s domain by using instrumented “props” specific to the task and gradually moving the emphasis away from performing the 3D tasks in the computer’s domain [Hand, 1997]. Even though the aim of a virtual environment is to avoid using a real object to eliminate harm to the user, it was necessary to get the virtual environments to mimic the real world task.

In this experiment, the user lifted a real weighted box in a virtual lifting simulation in a natural manner, as they can feel the real weight. The lifting simulation was guided with the feedback from the real world (tactile augmentation from the real weight) as well as from the virtual environment (visual display feedback monitoring LI values). The main idea of this experiment was to evaluate user performance when performing lifting tasks using a real weighted box, thus mimicking a real situation when workers in an industrial environment perform lifting operations as their work tasks. Users will also have real haptic feedback (in particular tactile, force and kinaesthetic feedback), provided by the real weighted object used [Boud et al., 2000].

Two experiments need to be conducted: lifting with a virtual weight and lifting with a real weight. For the virtual weight experiment, a subject would lift an empty box, having dimensions of 30cm wide, 15cm deep and 40cm long fitted with a handle. Three different weights were used for these experiments, 2 kg, 4 kg and 6 kg. For the experiment with virtual weight, similar weights of 2 kg, 4 kg and 6 kg were applied to the virtual box. For the real weight experiment, real weights (real loads of 2 kg, 4 kg and 6 kg) were lifted in the box of the same dimension. Each participant performed lifting for COMBI feedback technique only, as discussed in Chapter 3.2, since it is the most effective in advising the user of their LBP condition.

5.2.1 Method

5.2.1.1 Participants

Eighteen subjects took part in this experiment. There were fifteen men and three women, with a mean age of 31.2 years and a standard deviation of 2.6 years. All participants for the experiment were in good health, had no history of any back problems and had no vision (after correction) or hearing impairments.

5.2.1.2 Experimental set-up

The VE software was developed by the author using CAVELib API. The software recorded the following results to a data file; the time, the position and orientation of the box and user's head movements, and user details. An Onyx 300 visualization server was used to generate the images. A Portico Workwall was used as a large-

scale display device. Stereoscopic 3D images were created through the use of LCD shutter glasses. The glasses refresh rate was 120Hz (60Hz update for each eye). Six-degrees-of-freedom sensors together with Trackd software were used to track the head and box position and orientation. Real loads weighing 2 kg, 4 kg and 6 kg were used in this experiment of “real weight”. Both experiments, “real weight” and “virtual weight” used the same box with dimensions of 30cm wide, 15cm deep and 40cm long and fitted with a handle.

Subjects were invited to perform the task to the best of their ability. All lifts had to be conducted in a safe lifting range. Participants were provided with COMBI feedback techniques in real-time. The feedback was used to provide real-time information about the forces on the participant’s lower back utilising a modified NIOSH equation. From this equation, the Lifting Index (LI) value could be calculated. This was achieved by continually setting the current height to the starting lifting position as in equation 2.1 and equation 2.2 [Waters et al., 1993].

The acceptable LI value varied between 0.00 and 0.99 for safe lifts, with values equal to or greater than 1.00 indicating harm to the user. For this experiment, three levels of feedback, which monitor user’s back pain, were provided according to the calculated LI value.

Three sets of LI values, each for a different weight, were used as shown in table 5.3 below:

Weight	LI values		
	Safe	Risky	Danger
2kg	< 0.3282	0.3282 < LI < 0.3704	> 0.3704
4kg	< 0.6507	0.6507 < LI < 0.7536	> 0.7536
6kg	< 0.900	0.900 < LI < 0.9999	> 0.9999

Table 5.3: Details of Colour and Text Feedback

Subjects were asked to conduct all lifts in a safe manner, which is in the safe lifting zone throughout all lifts. If they found that they were outside this range, they should react by changing the location of the box to keep it in the safe lifting zone. They would, therefore, always perform the safe lift according to the supplied feedback.

5.2.1.3 Experimental procedure

The experiment was run separately for each participant taking approximately one hour to complete (see Appendix G for details of time allocation). Participants were required to read and sign a health consent form; only those in good health were allowed to participate in the experiment. They were presented with a description of the task to be performed (see Appendix H). The experimenter also explained and demonstrated the lifting procedure to be carried out by the subjects. Participants' detailed information was recorded in a data file. At the end of the experiments, the

participants were given a subjective questionnaire including rating scales (see Appendix I). The participants were advised that they could ask to have a rest before commencing the next experiment.

The participants were asked to lift the box from a starting position (shelf 1) and place the box in a designated area on an upper shelf (shelf 2), guided by the feedback (see Figure 3.6). They were then required to pause and hold the box static for 2 seconds for every trial, before proceeding on to the next. This delay is for the experimenter to ensure that the lifting task has been completed and as a help in monitoring the action of the participant during data analysis.

Subjects were required to conduct two experiments; to perform lifting tasks with virtual weights which varied from 2 kg, 4 kg and 6 kg, and lifting with real weights, with the same set of weights (2 kg, 4 kg and 6 kg). Participants practised and perform five trials for each condition of experiment, starting with virtual weight followed by real weight. The presentation order was randomized in a Latin Square Design. Position and orientation of the participants and the box were recorded by attached sensors. The time taken to complete the task and the Lifting Index values were also recorded. Upon completion of the experiment, the participants were required to fill in a simple questionnaire regarding their feeling of realism in having tactile augmentation.

5.2.2 Results

Figure 5.1 shows the time taken to complete the lifting task. As can be seen, times to complete the lifting task between real weight and virtual weight were not significantly different. Mean comparison using the two-tailed paired t-test reveals no significant main effect on the weight condition of users' task completion time for 2 kg ($t = -1.61$, $df = 179$, $p = 0.116$), 4 kg ($t = -1.95$, $df = 179$, $p = 0.052$) and 6 kg ($t = -1.91$, $df = 179$, $p = 0.057$). This suggests that users' lifting performance in virtual weight and real weight with regard to speed was almost identical because only small differences can be seen on the graph. Ergonomists may therefore use virtual lifting techniques to train humans how to lift safely in order to minimise their lower back pain. However, users took slightly longer to complete the lifting task in real weight, and this can be observed in all weights.

Another parameter studied in this experiment was the Lifting Index value. Figure 5.2 shows the differences between LI in Virtual Weight and Real Weight. Lifting Index values for Virtual Weight were compared with Lifting Index values for Real Weight and the differences were found to be not significant: 2 kg ($t = -1.72$, $df = 179$, $p = 0.095$), 4 kg ($t = -1.85$, $df = 179$, $p = 0.067$) and 6 kg ($t = -1.89$, $df = 179$, $p = 0.084$). This also supports the assumption that lifting a virtual weight can mimic a lift with a real weight. The reason might be due to the fact that the virtual feedback given was easy to follow no matter whether the user performed the lift using real or virtual weight. A similar pattern was found in users' performance, which was better achieved in virtual weight. However, since the differences were small which only

3.0, 3.1 and 5.6 percent for 2 kg, 4 kg and 6 kg respectively, training humans to lift in VEs would be a valuable alternative.

Responses from the questionnaire given to the users reveal that 33 percent of the users who answered preferred lifting with real weights as a training tool, as they feel more realistic, while 67 percent of them suggested virtual weights should be used to train humans to perform manual lifting. The majority of the users suggested that virtual feedback alone is sufficient for them to monitor their lower back condition as it provides specific results according to the NIOSH algorithm in real-time.

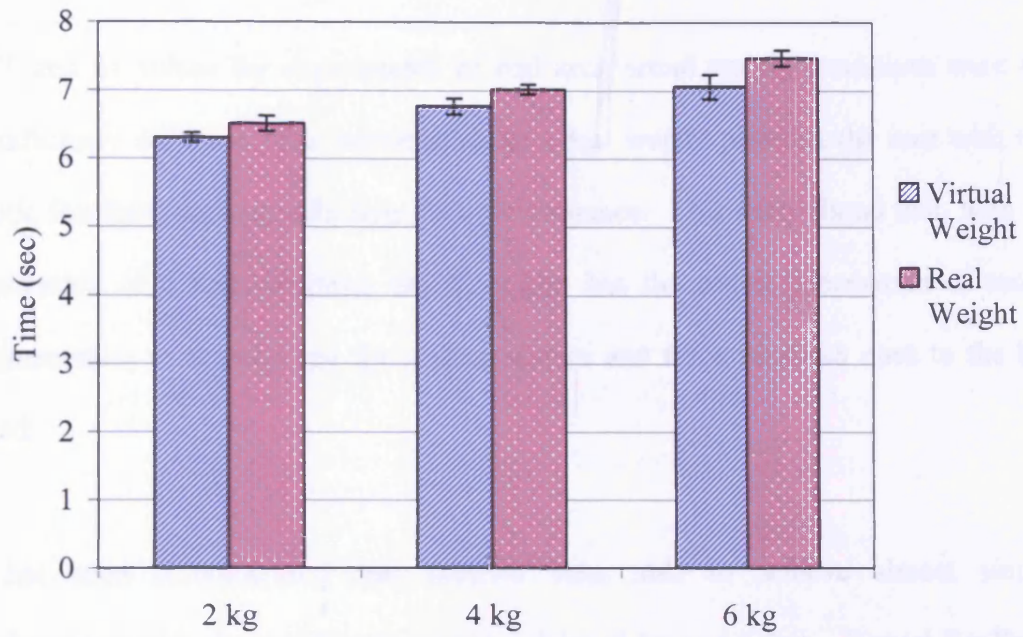

Figure 5.1: Task Completion Time (TCT) between Virtual Weight and Real Weight

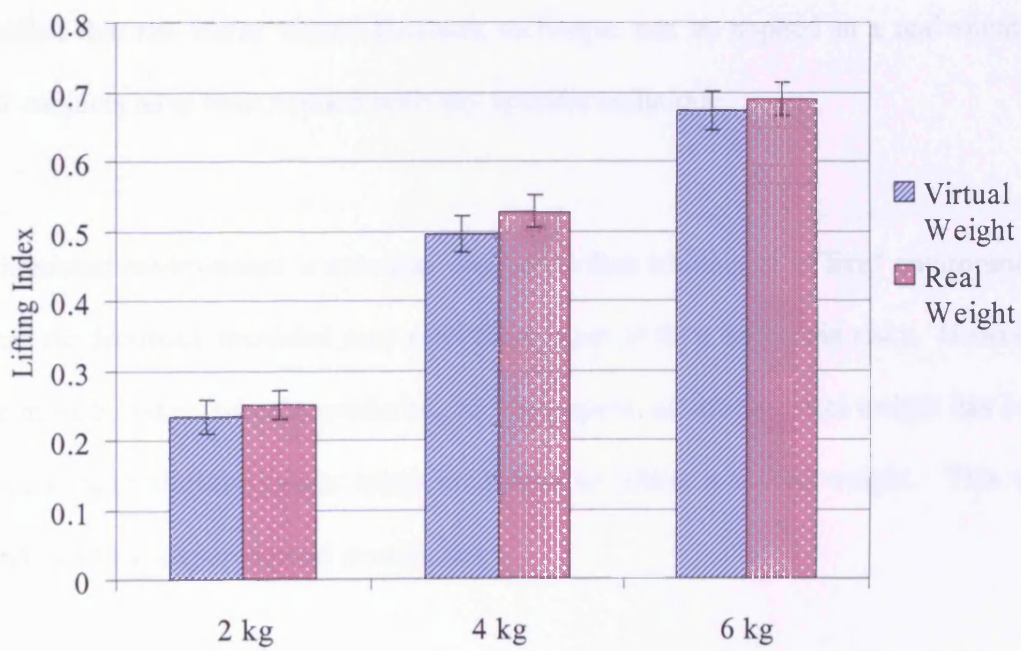

Figure 5.2: Lifting Index value between Virtual Weight and Real Weight experiment

5.2.3 Discussion

TCT and LI values for experiments of real and virtual weight conditions were not significantly different. The introduction of a real weight provides the user with real haptic feedback without affecting their performance. This study found that, with the application of a real weighted object, a user has the added information of tactile augmentation as a technique for adding texture and force feedback cues to the box lifted.

It has been demonstrated that subjects were able to achieve almost similar performance with three different weights (2 kg, 4 kg and 6 kg). Virtual Reality is intended to avoid handling difficult and dangerous tasks. This experiment was carried out to differentiate between users' performance in lifting with virtual weight and lifting with real weight, augmented with information of tactile feedback. The results establish that the learnt virtual feedback technique can be applied in a real situation after subjects have been trained with any specific technique.

A simulated environment is also less dangerous than training in a "live" environment, where the feedback provided may alert the subject of their back pain risks. However, care must be taken when considering the time spent, as lifting a real weight has been found to take slightly longer when compared to lifting a virtual weight. This was found in all the experimental conditions.

5.3 Effect of Training on Learning Curve

In this experiment, subjects were required to perform two lifting phases. The first was a Self-Training Phase, where the subject learnt to execute safe lifts while monitoring their own lifting performance in real-time. The second was a Test Phase, where a subject was examined on the effectiveness of the learnt technique without any feedback. The objective was to evaluate the learning effect on lifting with feedback in terms of the time taken to complete the tasks and the Lifting Index (LI) scores and to determine how quickly subjects learnt an appropriate lifting method. The learning curve/lifting trajectory during training and test was monitored throughout the trials.

A virtual weight of 2 kg was used for this experiment. Each user performed lifting for COMBI feedback. Every user was required to carry out two phases of experiment.

5.3.1 Method

This experiment used another eighteen subjects. Anyone who took part in any previous experiment was not allowed to participate again as this may have affected the findings. The experimental set-up was the same as for the previous one, but only used virtual weights. Experimental procedures were divided into two phases, a Self-Training Phase and a Test Phase.

5.3.1.1 Participants

This experiment used seventeen male and one female adult participant with a mean age of 29.2 years and a standard deviation of 5.6 years. The participants were in good health with no history of back injuries.

5.3.1.2 Experimental set-up

The systems used were similar to those employed in the previous experiment. The software was developed using CAVELib and present the same virtual feedback, but for this experiment, no tactile augmentation was applied. However, for the second condition (Test phase) of the experiment, no virtual feedback was supplied to the users. Again, two electromagnetic sensors were used: one for tracking hand movement and the other to track head movement. A box having the same dimensions as before was used for this experiment.

5.3.1.3 Experimental Procedure

The experiment was carried out by each participant individually. The participants were first required to read and sign health consent forms. Each participant conducted ten trials for both Training and Test phases. At the end of the experiments, the participants were given a subjective questionnaire including rating scales. The participants were advised that they may ask to have a rest before commencing the

next experiment. Participants undertook two phases of experiment as described in the following sections.

5.3.1.3.1 Self-Training Phase

Each subject learnt the feedback techniques on their own while performing the lifting task, as no instruction on lifting technique was given before conducting the experiment in the Self-Training Phase. However, the experimenter did mention that they needed to perform the lifting task in the Safe Lifting Zone throughout the experiment. Participants had, therefore, to react to the real time feedback by changing the position and orientation of the box. In this experiment, subjects were provided with COMBI feedback techniques on their LI results. The experimenter also described the purpose of the experiment verbally. The subjects were also asked to keep the LI value as low as possible. The experimenter reminded the subjects to remember their lifting technique according to the feedback provided during the training phase, as they were to be tested on completion of training phase.

5.3.1.3.2 Test Phase

Participants were asked to conduct a Test Phase upon completion of the Self-Training Phase. In the Test Phase, subjects were examined on the effectiveness of the learnt feedback. They were not provided with the feedback of their back pain risk. The experimenter, however, asked the participants to perform the test to the best of their ability and to apply the techniques learnt beforehand.

5.3.2 Results

The raw data had to be processed in order to be able to obtain only one LI value for every change of LI made throughout the lifting task. Comparison of the mean LI values between the Self-Training Phase and the Test Phase conducted by every subject is shown in Figure 5.3. During the trials, the LI values reduced by 30.7% for Training Phase, while for Test Phase the value remained almost steady throughout the trials. It can be seen clearly that the value for LI in the Training Phase decreases dramatically for the first few lifts, because the subjects were actively learning and trying to respond to the feedback provided. After a few trials, the LI values for the Training Phase were almost steady, only varying in a smaller range.

Figure 5.4 shows the total of mean comparison of LI values for the Training Phase and LI values for Test Phase. The differences were found to be statistically significant ($t = 8.23$, $df = 179$, $p < 0.05$).

The frequencies of Lifting Index for both Training and Test Phases are shown in Figure 5.5 and 5.6. In the Training Phase, it shows that the LI is scattered from 0.25 to 0.55, with the majority being in 0.3, whereas the Test Phase shows a reduction in LI range (from 0.15 until 0.35) only. This indicates that participants had a better understanding during Test Phase since their results were distributed in smaller range.

Task Completion Time (TCT) was also monitored and the average time taken is shown in Figure 5.7. During the Training Phase, subjects took as much as 51.6 seconds to complete a lift, with a mean of 9.18 and standard deviation of 6.07. In the

Test Phase, the longest time taken to complete a lift was only 9.16 seconds (82.2% less than the Training Phase). The mean TCT was 5.89 seconds and the standard deviation was 1.5 seconds.

Figure 5.8 shows the total of mean comparison of TCT for the Training Phase and TCT for the Test Phase. The two groups differed significantly from each other ($t = 7.47$, $df = 179$, $p < 0.05$).

Examples of lifts carried out by one of the subjects are depicted in Figure 5.9 and 5.10. Subjects lift the box 10 times from shelf 1 to shelf 2. From this it can be seen clearly that the subjects were trying to learn lifting techniques during the first few trials because the LI values then reduced noticeably. In the first trial the LI index values exceeded both the lower LI threshold and the upper LI threshold, which means they reached the Dangerous Lifting Zone. However, in the second trial the subject only exceeded the lower LI threshold as he started to reduce the LI according to the feedback he was receiving. It became noticeable that the LI values reduced with the number of trials. Trials number 3 onwards were conducted successfully in the Safe Lifting Zone and it was noticeable that after trial 5, user performance varied within a smaller LI range. During the Test Phase, all the lifts were conducted in the low LI region with variations over a small range.

A subject took a longer time to perform a lifting task at the beginning of the Training Phase. Thereafter, the lifts were good as the subject could lift faster. In the Test Phase, all the lifts were conducted in similar times for the different trials.

Figures 5.11 and 5.12 show in detail the lifting curves for every trial performed by one subject. In the Training Phase, the subject took 26 seconds to perform the lift for the first time (refer Figure 5.11 – Trial 1). This was due to unfamiliarity with the feedback provided as no training had been given beforehand. The graph of the first trial clearly shows that much time was spent on the placement of the box (24 seconds) rather than on the initial (starting) lifting phase which only took 2 seconds. At that point, TCT reduced to 21 seconds and the lowest TCT was 4 seconds. Figure 5.12 shows that all the trials were completed between 3.3 and 5.4 seconds in the Test Phase, which meant the subject learnt quickly from the feedback, and managed to lift in a progressively shorter time.

Figure 5.13 shows details of various Lifting Zones with reference to vertical distance and LI values. Only one lift has been shown for the purpose of explanation. It can be seen that the subject entered the Risky Lifting Zone between 23 and 24 seconds. Then he reached the Dangerous Lifting Zone from 24 to 26 seconds. From the top graph, a learning curve can be seen, where the subject was trying to manoeuvre his hands and at the same time learn to assimilate the feedback provided by the virtual simulation technique. After 31 seconds the subject was back in the Safe Lifting Zone, but only arrived at the final destination in 37 seconds. It can be seen that the subject stayed still for a few seconds to indicate that he had finished the lifting task.

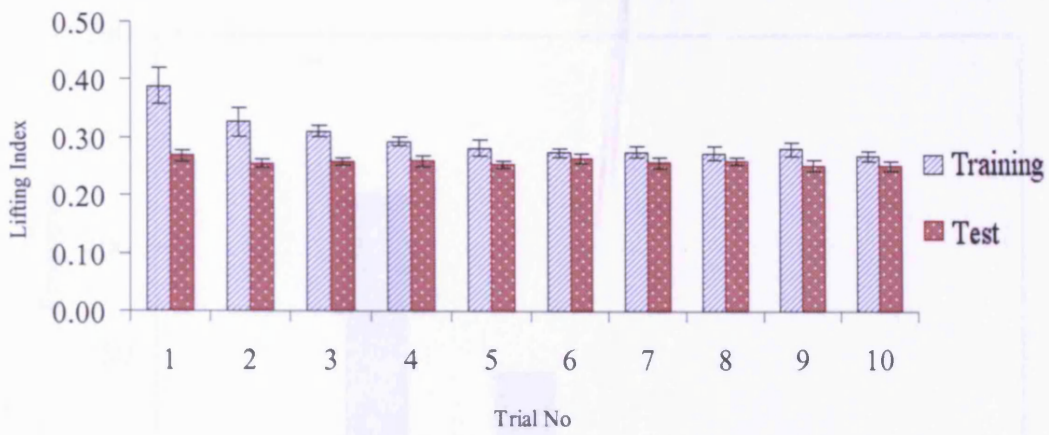

Figure 5.3: LI values between Training and Test phases

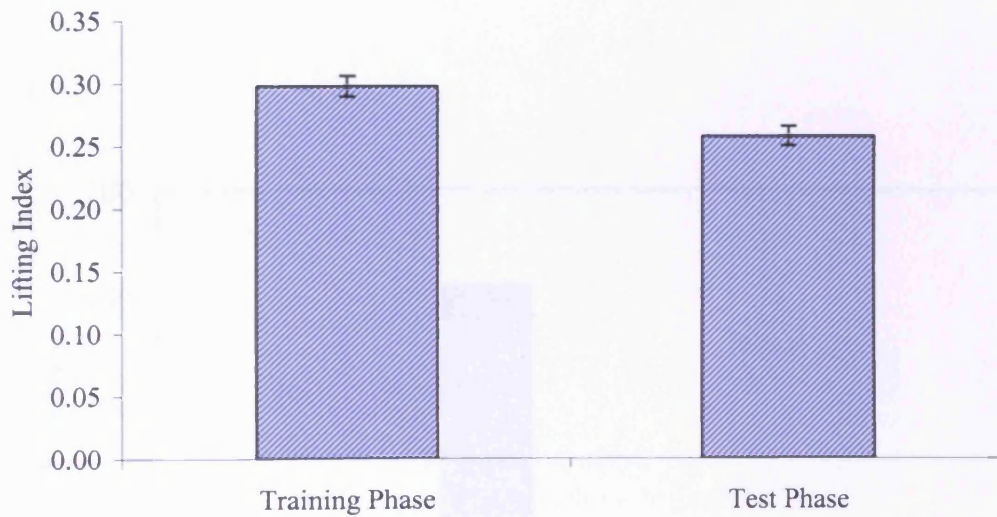

Figure 5.4: Mean of LI values between Training and Test phases

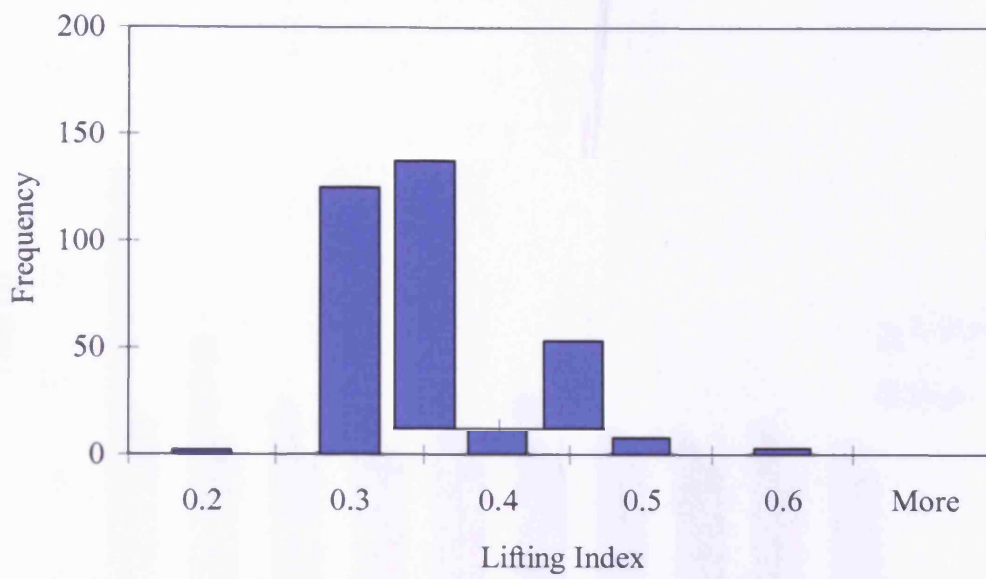

Figure 5.5: Frequency of Lifting Index – Training Phase

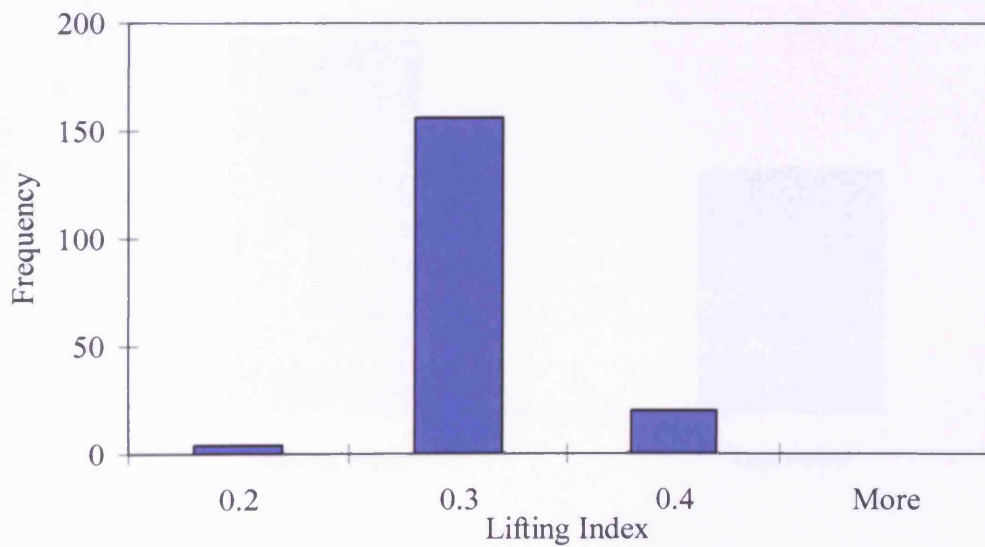

Figure 5.6: Frequency of Lifting Index – Test Phase

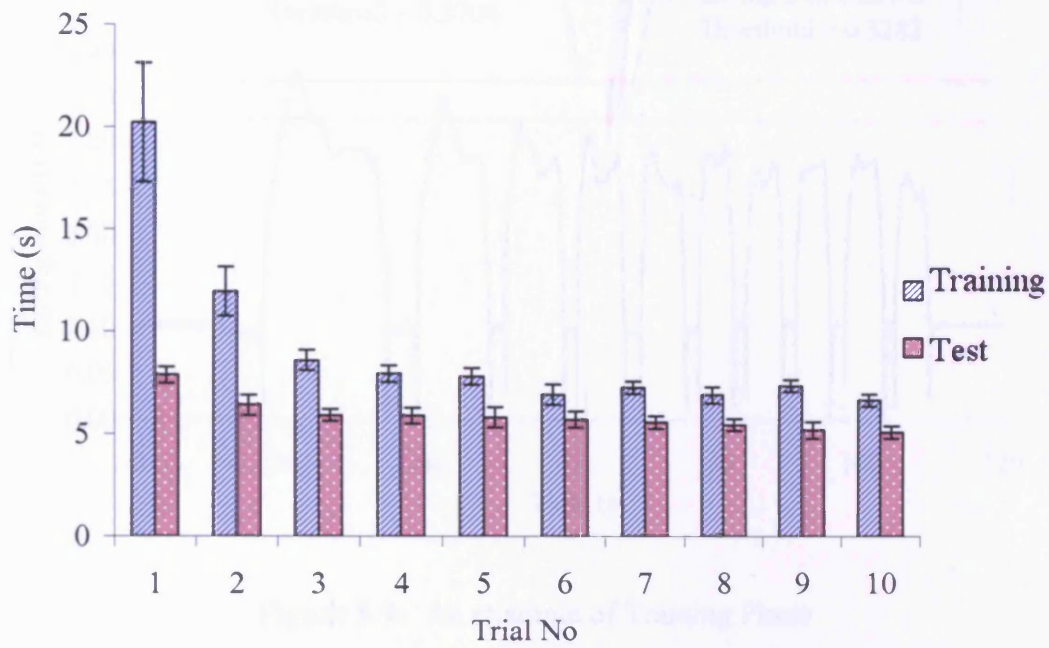

Figure 5.7: Task Completion Time According to Trial Number - Training and Test Phase

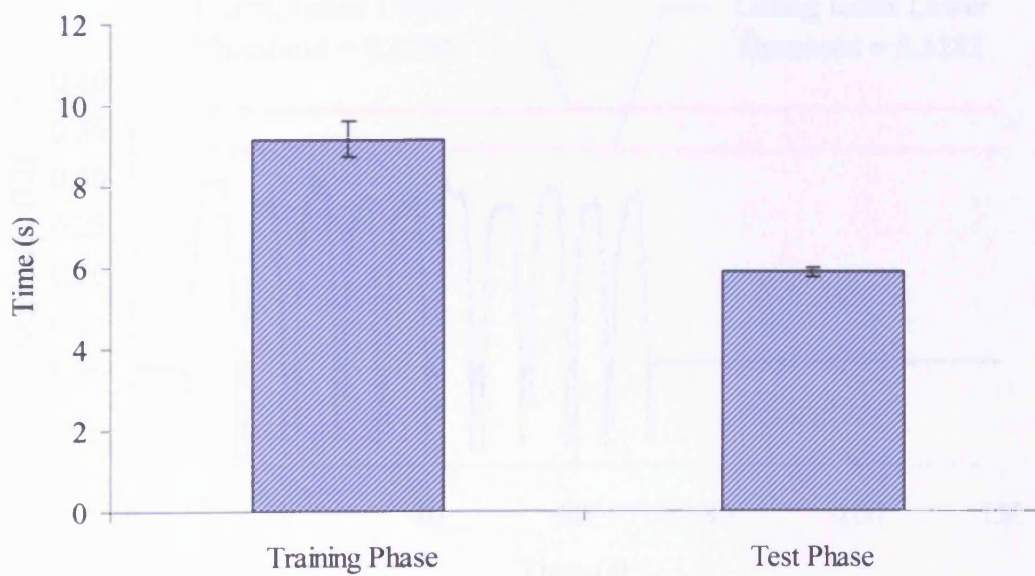

Figure 5.8: Average of Task Completion Time - Training and Test Phase

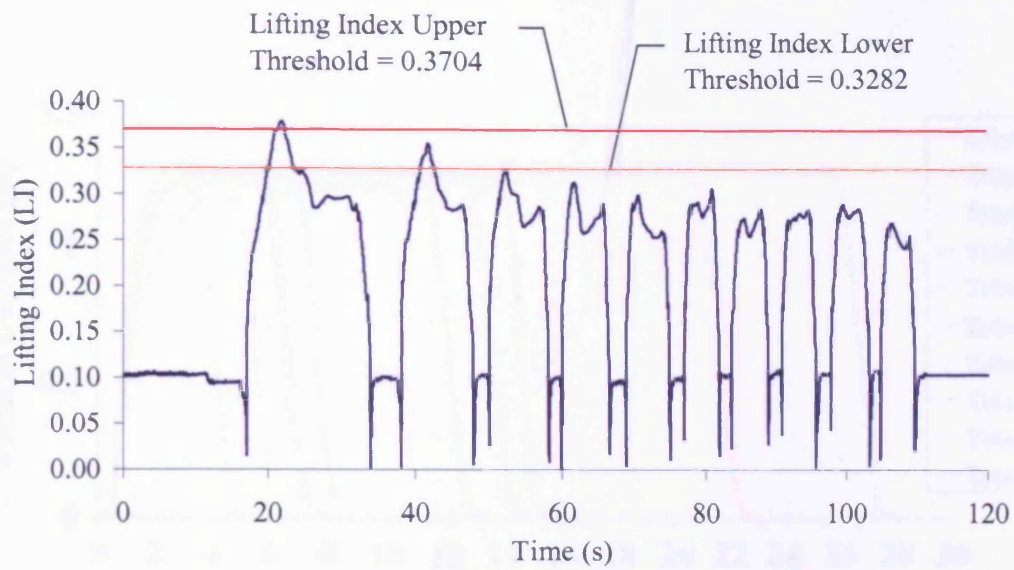

Figure 5.9: An example of Training Phase

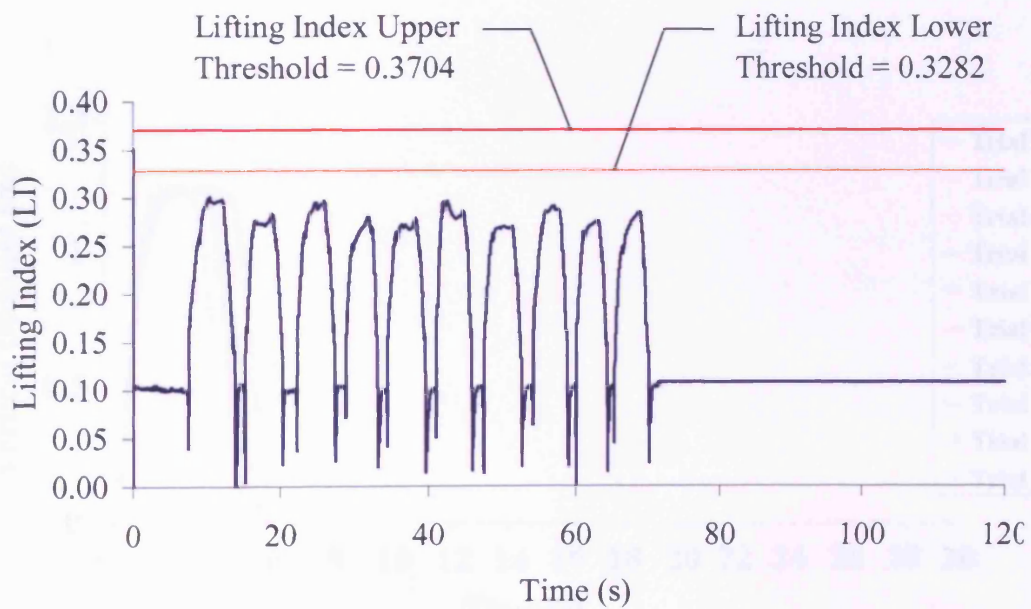

Figure 5.10: An example of Test Phase

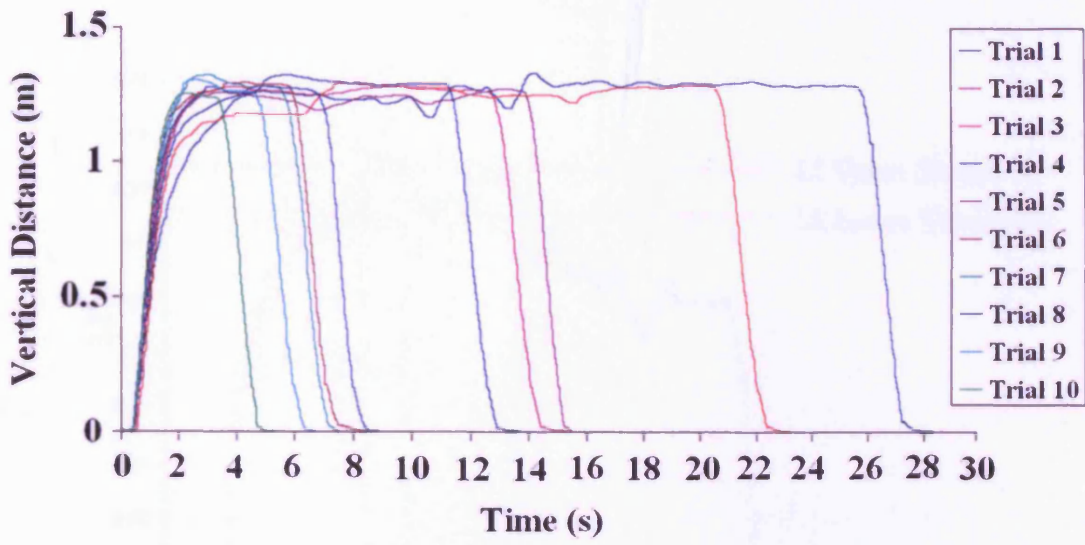

Figure 5.11: An example of a learning curve for Training Phase

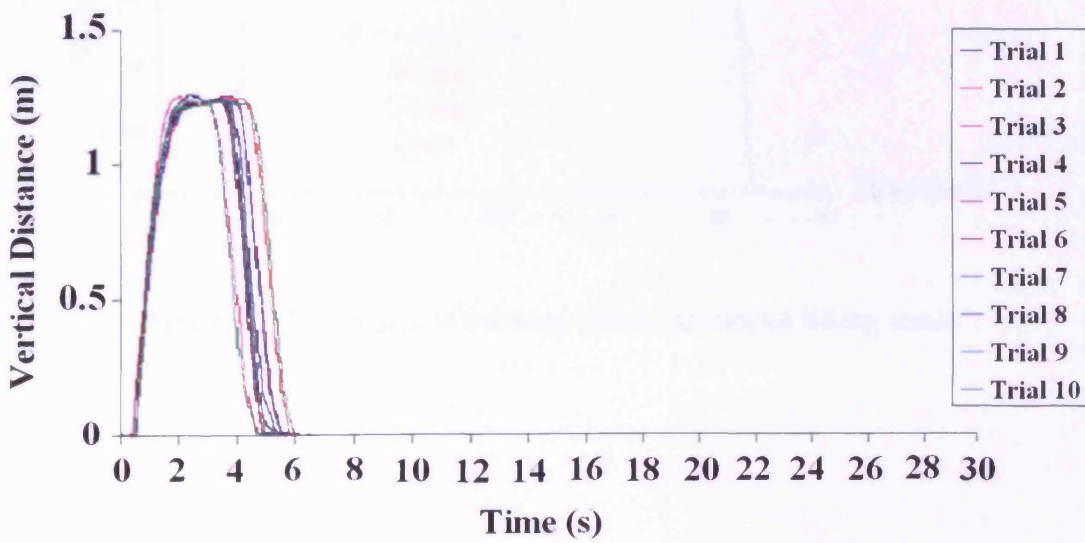

Figure 5.12: An example of a learning curve for Test Phase

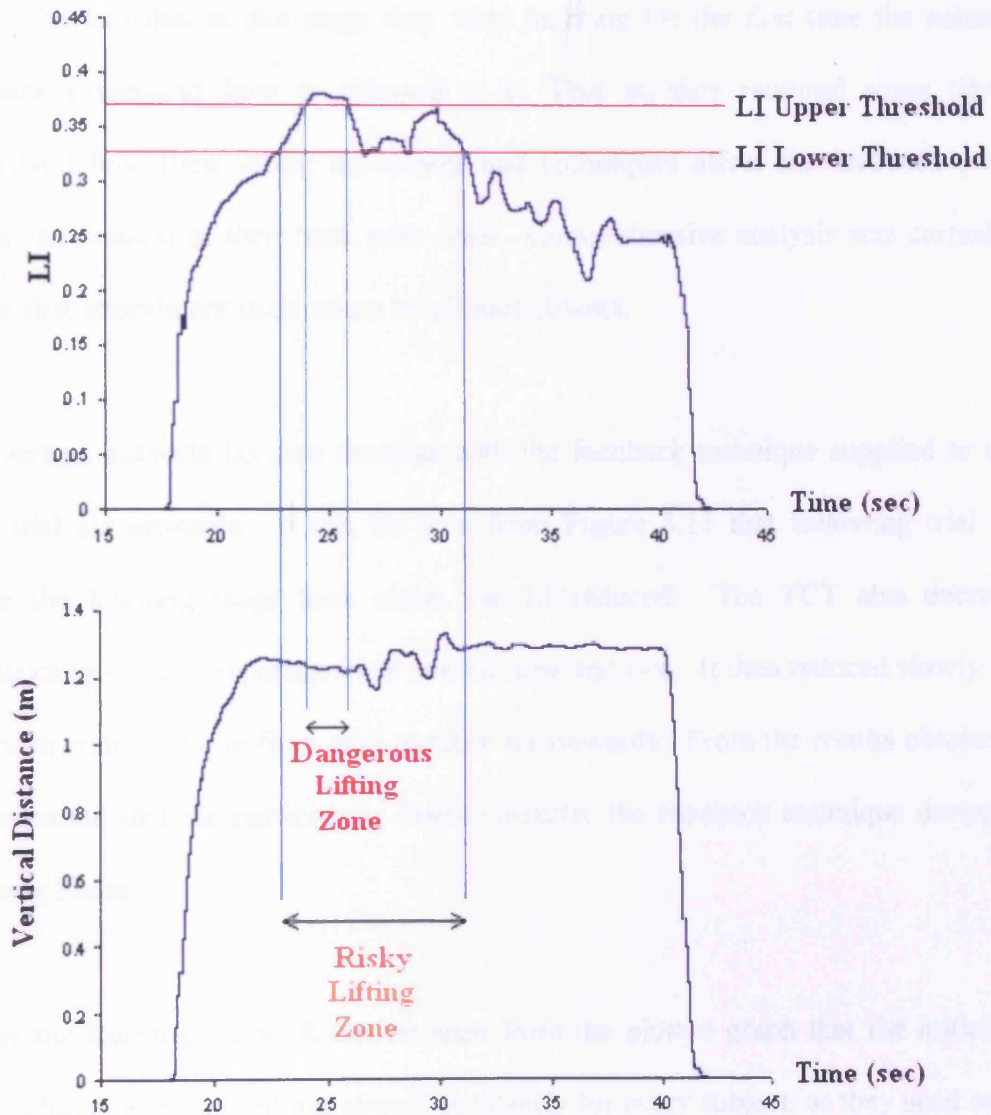

Figure 5.13: Details of learning curve for various lifting zones

5.3.3 Discussion

Subjects learnt the feedback technique well during the Self-Training Phase. This was due to the fact that at this stage they were learning for the first time the nature of feedback given and how to respond to it. That is, they required some time to understand how their lifting movement and techniques affect the feedback (which display LI results) of their back pain risks. Comprehensive analysis was carried out on the first experiment undertaken by all participants.

On average, subjects become familiar with the feedback technique supplied to them from trial six onwards. It can be seen from Figure 5.11 that following trial five, where the learning stage took place, the LI reduced. The TCT also decreased dramatically when comparing trials number one and two. It then reduced slowly until it became almost stable from trial number six onwards. From the results obtained, it was apparent that the participants learnt correctly the feedback technique during the Training Phase.

As for the learning curve, it can be seen from the plotted graph that the initial and lifting phases were carried out almost constantly for every subject, as they need only 2 seconds. In the Test Phase, all participants performed the trials well, with almost the same LI values and speed to complete the lifting tasks. This outcome suggests that the learning technique is important to humans before carrying out the lifting in the real world. By having input in real-time regarding their back condition while performing lifting, as well as learning the techniques of lifting, lower back injury among workers can be minimised.

5.4 General Discussion

A Virtual Environment is a very useful tool with which to train humans to conduct dangerous and expensive tasks. Feedback techniques were introduced to alert a user to their performance and lifting technique. In this case, we used a Combined Colour and Text feedback technique to warn the lifter of risks to their lower back. The effects of using a real object to provide the user with tactile augmentation feedback has been evaluated. The findings proved that results of the participants performing lifting with tactile augmentation were similar when compared to a lift done without tactile augmentation.

Subjects were able to monitor their LI values from the feedbacks (real: tactile feedback, and virtual: visual display feedback) given when conducting the real and virtual weight lifting tasks. Task Completion Time (TCT) was compared between lifting with a Real Weight and a Virtual Weight and statistical analysis proved that the difference was not significant. The same applied to the Lifting Index. No significant difference was found in the LI value between lifting with a Real Weight and a Virtual Weight. We may therefore conclude that the introduction of tactile augmentation did not affect human performance in carrying out manual lifting tasks. Users mostly depend on the virtual visual display feedback (COMBI) given to them as they indicate precise measurement of their lifting performance. Even though previous researchers suggested that the introduction of tactile augmentation would enhance user performance, this probably would not apply to all circumstances. The findings here suggest that after a human is trained on the lifting technique in a virtual environment with the feedback provided, they are able to conduct the manual lifting task in the real

world without affecting their performance and quality of work carried out. Further research may consider using different subjects for different weights if more than 6 kg weights are to be used for the experiment.

The research also examined the training effects on user performance, particularly on lifting trajectory. The focus has been on the learning pattern for training needs. This is important to note as a guide to how long a training process each user will require to be able to perform the work in the real world. A Self-Training Phase was introduced to see how fast and easy it is to learn and understand the feedback techniques that warn the user about their lifting performance in terms of minimising their lower back pain. It was decided to conduct self-training, rather than provide the user with written and demonstrated training, so that subjects' performance could be assessed clearly. A thorough analysis is important and users' learning curve/trajectory has been analysed in more detail.

It has been demonstrated that subjects learn the feedback technique during the first five trials. From trial six onwards, the performance is almost constant. This was found in both TCT and LI values.

Lifting trajectory for the first trial conducted by one participant was studied and evaluated. The subject reacted faster to the given feedback technique by changing the box location and orientation. Once the subject enters the Risky Lifting Zone or Dangerous Lifting Zone, he moved the box to a different location. The LI values fluctuated as the subject was still in the learning stage of understanding the feedback according to his movement. On average, it took up to five trials for all subjects to

understand the change of feedback technique. Trials of ten repetitions would therefore be sufficient for the participants to learn the feedback and lifting technique correctly in VEs. The Test Phase showed the performance of lifting was steady throughout the experiments. All ten trials were performed with almost the same LI values and TCT. These trials demonstrated that the participants would be able to conduct the lifting even without virtual feedback given to them, as they had learnt and could employ the technique in the future.

This research highlighted the fact that training a human to perform manual lifting in VEs is important, as the techniques and cues were understood well. Subsequently humans could perform a real lifting task in a real environment by applying the techniques learnt. The learning curve for every lift has been analysed thoroughly and the findings showed that after five trials, the user is able to perform lifting well.

5.5 Summary

The purpose of this research was to evaluate the effectiveness of real/natural feedback with tactile augmentation, together with virtual feedback for manual lifting simulations. With the recent emphasis on working closer to user's domain when performing 3D tasks, it has been suggested that instrumenting the real device/props would allow the user to work as in a real environment. Having said that, real weights have been used to enhance user realism when performing manual lifting tasks, and to bring the tasks closer to user's domain. However, the experimental findings with and without tactile augmentation did not reveal any significant difference. Even though some of the participants suggest that providing tactile feedback would improve the

feeling of the tasks, the majority of them reported that virtual feedback alone was more than sufficient for them to learn the lifting technique since real time feedback encourages the person to lift with confidence while the measurement of their back condition can be monitored concurrently. It is therefore recommended that virtual lifting without tactile augmentation be used in training humans in VE to perform lifting tasks safely.

The research also assessed thoroughly the learning process in order to understand virtual feedback in manual lifting tasks. It has been found that ten trials is ample for them to become familiar with the virtual feedback of their back condition, as well as responding to it in order to minimise their lower back pain. The information from this research can be used to enhance virtual training simulations in other manual material handling tasks such as carrying, pulling, pushing and also to determine whether or not this outcome is consistent with other manual handling tasks. It could also increase the understanding of human reaction to virtual environments.

Chapter 6

Conclusions and Future Work

The main objective of this research has been to evaluate the effectiveness of providing multimodal virtual feedback to users in VEs during training sessions of manual lifting activities which monitor the user's lower back condition in real-time.

This chapter presents the contributions of the research, summarises the main conclusions and proposes topics for further studies.

6.1 Contributions

The research presented here has mainly considered the area of Virtual Environments. In particular, it addresses the feedback cues available in VEs which best improve safety in Manual Material Handling (MMH) tasks.

This study has developed visual display feedback techniques in real-time for Virtual Environments using CAVELib to evaluate user performance while carrying out manual lifting tasks.

The work has made important findings in the use of visual display feedback techniques in VEs by experimentally comparing and evaluating both singular and multiple/combined visual feedback. The combination of two different visual feedbacks has increased user understanding, whereby they have the option to choose which visual feedback to use as a cue depending on their necessity for coarse or fine control on certain LI values.

This study developed a test using CAVELib to measure user perception of virtual weights. The virtual weights, which vary from 5 kg to 12 kg, were used and the feedback monitoring the Lifting Index (LI) values changed according to the box movement. A NIOSH equation was used to calculate the Recommended Weight Limit (RWL) and Lifting Index (LI) captured by the sensors and these were updated simultaneously with user performance.

The evaluation of a weight perception test was experimentally assessed using the participants and considering the correct-incorrect selections made by them as well as the score rated by the noticeable differences.

This research has also contributed to the study of sound as a medium for auditory feedback in VEs. A sound feedback technique using CAVELib was developed. Bergen Sound Server (BSS), which is an audio server and client library, was added, since CAVELib does not contain any audio routines. Three types of auditory feedback were created: Pitch, White-noise and Tempo.

The effectiveness of the various types of sound was compared by investigating user performance experimentally, executing the task in real-time. The features analysed were Task Completion Time (TCT), Percentage of Harmful Lift (PHL) and Response Time to Feedback (RTF).

The findings also contribute to the study of multimodal feedback techniques. The development of combination techniques, which provide more than one sense of feedback as a cue, was described. For example, the combination of Colour and Pitch feedback techniques were merged for visual and auditory senses respectively.

The combined visual and auditory feedback technique was experimentally tested using participants to observe the improvement of having multimodal feedbacks. The features analysed were Task Completion Time (TCT), Percentage of Harmful Lift (PHL) and Response Time to Feedback (RTF).

This research also investigated the use of “tactile augmentation” or “pseudo-haptic” feedback in adding realism to the users in VEs. Detailed evaluation of manual lifting tasks was developed with both real and virtual feedback techniques which come from Tactile Augmentation and visual feedback respectively. Tactile augmentation used real weighted objects to be lifted by the user.

The feedback technique for tactile augmentation was experimentally evaluated using participants to observe whether or not tactile augmentation could improve user performance. The features analysed were Task Completion Time (TCT) and Lifting Index (LI) values.

This research has also contributed to the field of feedback training in VEs. An evaluation of the training needs in VEs for manual lifting tasks was made. A Self Training Phase was developed with a Test Phase and virtual feedback techniques were used to compare the findings. The result was a guideline to determine the number of trials that needed to be performed.

The developed Training and Test phases were experimentally evaluated using participants to observe the improvement on user performance with the number of trials. The features analysed were Task Completion Time (TCT) and Lifting Index (LI) values. The minimum requirements for training in VEs for manual lifting tasks was outlined.

Another finding of this research was in the investigation of lifting trajectory. The features analysed were Task Completion Time (TCT), Lifting Index (LI) values and the plotted graph of TCT which was then projected to another graph (vertical distance graph). The time taken for Initial Phase, Lifting Phase and Placement Phase in lifting tasks were evaluated.

6.2 Conclusions

Virtual Reality is widely used in commercial and research systems to provide training for new procedure/tasks which contain an element of danger to the user. It is crucial to provide performance feedback to the users in virtual training as it will allow them to learn from their experiences. This research investigated multimodal feedback cues

to enhance user performance in manual lifting tasks and determine the training requirements as a guideline. This research has investigated several issues and the conclusions are outlined as below:

- Visual display feedback performed better in terms of PHL if compared with the condition of no visual display feedback. This confirms hypothesis 1 stated in Chapter 1. However, TCT for visual feedback was longer for all the feedback conditions when compared with no feedback.
- Combined Colour and Text feedback was the best visual display feedback among Colour feedback and Text feedback in providing the user with information of their LBP. This confirms hypothesis 2 stated in Chapter 1.
- The majority of the users preferred Combined Colour and Text feedback. The remainder gave equal preference to both Colour and Text feedback.
- Visual display feedback techniques were effective as users were able to respond to all the feedback techniques provided in real-time.
- Users were able to differentiate the virtual weights that were applied from the virtual lifting feedback given. This confirms hypothesis 3 stated in Chapter 1.
- Auditory feedback was better in performance in PHL when compared with the condition with no auditory feedback. This confirms hypothesis 4 stated in

Chapter 1. However, TCT for auditory feedback was longer for all the feedback conditions when compared with no feedback.

- Pitch was the best auditory feedback in the manual lifting simulation, followed by White-noise and Tempo.
- Auditory feedback techniques were effective as users were able to respond to all the feedback provided in real-time.
- A Combined Auditory and Visual (AV) feedback technique of Pitch and COMBI gave better results in RTF and PHL. This confirms hypothesis 5 stated in Chapter 1. However, its TCT was not the best since Purely Visual still outperformed Combined AV in TCT.
- A Combined Auditory and Visual (AV) feedback technique of Pitch and Colour did not reveal any significant differences in all aspects (TCT, PHL and RTF). It was, however, the longest in TCT.
- A Combined Auditory and Visual (AV) feedback technique of White-noise and COMBI gave significantly poor results in TCT compared to both Purely Visual and Purely Audio.
- The introduction of tactile augmentation, which provides a real weighted object, gives real haptic sensation to the user without affecting their performance. This confirms hypothesis 6 stated in Chapter 1.

- Tactile augmentation gave added information because texture and force characteristics are given as the box is lifted.
- User performance in TCT and LI values for experiments having tactile augmentation were almost similar with the performance without tactile feedback. A user can therefore use the learnt virtual feedback technique to be applied in a real situation.
- Lifting trajectories indicate that the users understand the virtual feedback well, as the reaction of the user can be seen clearly in order for them to get better LI values once they enter unsafe zones. This confirms hypothesis 7 stated in Chapter 1.
- Trial repetitions of ten lifts are sufficient for the user to become familiar with the learnt virtual feedback. This confirms hypothesis 8 stated in Chapter 1.
- Users were able to perform a manual lifting task successfully during a Test Phase with steady performance throughout the experiments, even with no feedback being given.

6.3 Future Work

This study has developed and enhanced understanding of using the provision of multimodal feedback techniques in VEs to train people effectively in performing

manual lifting tasks safely while reducing LBP. The research carried out represents a step forward in the use of Virtual Reality technology in training people in Manual Material Handling activities. The following topics are suggested for future work:

- Speech could be adopted as an auditory feedback technique in warning the user of their lifting condition and performance, whether as stand-alone or combined with Text Feedback technique to provide better information.
- The techniques discussed in this work could be applied to asymmetrical lifting in order to evaluate the effectiveness of virtual feedback.
- Participation of factory workers, especially dealing with lifting/shelving/stacking, could be considered.
- Other Manual Material Handling tasks could be investigated such as carrying, pushing, pulling, walking and climbing.

Appendix A

Tables for Multiplier, an Example of RWL and LI

Tables for Multiplier, an Example of RWL and LI

Horizontal Multiplier

H	HM	H	HM
	in	cm	
≤10	1.00	≤25	1.00
11	.81	28	.88
12	.83	30	.83
13	.77	32	.78
14	.71	34	.74
15	.67	36	.69
16	.63	38	.66
17	.58	40	.63
18	.56	42	.60
19	.53	44	.57
20	.50	46	.54
21	.48	48	.52
22	.46	50	.50
23	.44	52	.48
24	.42	54	.46
25	.40	56	.45
>25	.00	58	.43
		60	.42
		63	.40
		>63	.00

Vertical Multiplier

V	VM	V	VM
in		cm	
0	.78	0	.78
5	.81	10	.81
10	.85	20	.84
15	.89	30	.87
20	.93	40	.90
25	.96	50	.93
30	1.00	60	.96
35	.98	70	.98
40	.93	80	.96
45	.89	90	.96
50	.85	100	.93
55	.81	110	.90
60	.78	120	.87
65	.74	130	.84
70	.70	140	.81
>70	.00	150	.78
		160	.75
		170	.72
		175	.70
		>175	.00

Frequency Multiplier

F lifts/ min	DURATION					
	<1 hour		1-2 hours		2-8 hours	
	V< 30 in	V≥ 30 in	V< 30 in	V≥ 30 in	V< 30 in	V≥ 30 in
≤2	1.00	1.00	.85	.85	.85	.85
3	.97	.97	.92	.92	.81	.81
4	.94	.94	.88	.88	.75	.75
5	.91	.91	.84	.84	.85	.85
6	.88	.88	.79	.79	.55	.55
7	.84	.84	.72	.72	.45	.45
8	.80	.80	.60	.60	.35	.35
9	.75	.75	.50	.50	.27	.27
10	.70	.70	.42	.42	.22	.22
11	.60	.60	.35	.35	.18	.18
12	.52	.52	.30	.30	.00	.15
13	.45	.45	.28	.28	.00	.13
14	.41	.41	.00	.23	.00	.00
15	.37	.37	.00	.21	.00	.00
16	.00	.34	.00	.00	.00	.00
17	.00	.31	.00	.00	.00	.00
18	.00	.28	.00	.00	.00	.00
>15	.00	.00	.00	.00	.00	.00

Distance Multiplier

D	DM	D	DM
in		cm	
≤10	1.00	≤25	1.00
15	.84	40	.93
20	.91	55	.90
25	.86	70	.88
30	.88	85	.87
35	.87	100	.87
40	.87	115	.86
45	.86	130	.86
50	.86	145	.85
55	.85	160	.85
60	.85	175	.85
70	.85	>175	.00
>70	.00		

Coupling Multiplier

COUPLING TYPE	CM	
	V<30 in	V≥30 in
GOOD	1.00	1.00
FAIR	.95	1.00
POOR	.90	.90

Asymmetric
Multiplier

A	AM
deg	
0	1.00
15	.95
30	.90
45	.86
60	.81
75	.76
90	.71
105	.66
120	.62
135	.57
>135	.00

An example of calculation of RWL and LI

$$RWL = LC \times HM \times VM \times DM \times AM \times FM \times CM$$

LC = load constant (23 kg)

HM = horizontal multiplier (25/H)

VM = vertical multiplier (1-(0.003*|V-75|))

DM = distance multiplier (0.82 + (4.5/D))

AM = asymmetric multiplier (1-(0.0032*A))

FM = frequency multiplier

CM = coupling multiplier (good (1); fair (0.95); poor (0.9))

For H = 30 cm, V = 60 cm, D = 40 cm, A = 0, frequency = 10 lifts/min, good coupling and L = 2 kg

$$\begin{aligned}
 RWL &= 23 \times \left[\frac{25}{30} \right] \times [1 - (0.003 \times |60 - 75|)] \times \left[0.82 + \left(\frac{4.5}{40} \right) \right] \times [1 - (0.0032 \times 0)] \times 0.45 \times 1 \\
 &= 23 \times 0.833 \times 0.955 \times 0.9325 \times 1 \times 0.45 \times 1 \\
 &= 7.6778
 \end{aligned}$$

$$LI = \frac{L}{RWL} = \frac{2}{7.6778} = 0.2605$$

Appendix B

VE Sickness Evaluation Form (Pre and Post Immersion) and Checklist

Pre-immersion Subjects Consent Form

I (insert full name here please)..... consent to the procedures required for an evaluation of the visual effects of using virtual reality equipment being carried out on me. An explanation of the nature and purpose of the experiment has been provided by the experimenter.

I understand that to participate in these experiments, certain medical criteria must be met. By initialling the following, I confirm that I do not currently suffer from any of the following:

Hayfever disorders	Asthmatic or respiratory
Migraines or other chronic headaches	Backpain
Heart conditions	Any head injury
Infectious skin complaints and that I am not pregnant	Liver disease

(initial here)

By initialling here, I confirm that I have never suffered from any:

Major Head Injury	Epilepsy
Neck Injuries	Any Middle Ear Diseases
Diabetes	Meningitis

(initial here)

I undertake to obey the laboratory regulations and the instructions of the experimenter regarding safety, subject only to my right to withdraw.

I understand that I may withdraw from the experiment at any time, for any reason, and that I am under no obligation to give any reason for my withdrawal.

I understand that I may suffer from the following symptoms as a result of carrying out the experiment:

Headache	Eyestrain
Blurred vision	Sickness
Dizzy (eyes open)	Dizzy (eyes closed)

I understand that if I experience any of these symptoms during or immediately following the use of the equipment, I should report these symptoms to the experimenter and that I will not be able to leave the laboratory until, in the opinion of the experimenter, it is safe to do so.

I understand that any information I shall give about myself will be treated as confidential by the experimenter.

Signature of Participant Date

Signature of Experimenter Date

Post-Immersion Subject Consent Form

I (insert full name) confirm that I am leaving the laboratory of my own accord. I also confirm that I am not currently feeling nauseous or disorientated.

We advise you not to drive a car or ride a bicycle within one hour of leaving the laboratory. If you experience any unusual symptoms after leaving the laboratory, please report these to the investigator and seek immediate medical advice.

Date

Time

Signature of Participant.....

Signature of Investigator.....

Short Symptom Checklist Recording Tables (SSC)

Name of Participant Date Time

On the scale provided below, do you feel any of the following symptoms?

- 1 Not at all
- 2 Slightly
- 3 Moderately
- 4 Definitely
- 5 Severely

Symptom	Time after immersion (minutes)						
	0	5	10	15	20	25	30
Headache							
Eyestrain							
Blurred vision							
Dizzy (eyes open)							
Dizzy (eyes closed)							
Nausea							

Symptom	Time after immersion (minutes)					
	35	40	45	50	55	60
Headache						
Eyestrain						
Blurred vision						
Dizzy (eyes open)						
Dizzy (eyes closed)						
Nausea						

Appendix C

Participants' Tasks Description - Visual Display Feedback

Visual Display Feedback Techniques for Virtual Lifting Experiment

The aim of this experiment is to evaluate people's reaction to different Visual Display feedback techniques when lifting an object in virtual environments (VE). This experiment monitors the force on your lower back and uses different Visual feedback techniques to present this data to the lifter.

In this research you will use several different experimental conditions using Visual control feedback techniques. You are required to complete the experiment to the best of your ability, as the results will be closely monitored.

Details of the experiments are listed below:

1. Lifting without feedback
2. Lifting with Text Feedback only
3. Lifting with Colour Feedback only
4. Lifting with Combination of Colour and Text Feedback
5. Weight Perception Test

Procedure

1. Sign pre-immersion consent form.
2. Enter your experimental information on the sheet provided.
3. The Experimenter will demonstrate the software and the equipment to be used.
4. You will first be required to practise with the equipment before the experiment can commence.
5. 45 minutes of post-immersion monitoring.
6. Fill in the questionnaire.

You will complete the experiment in approximately one hour.

Appendix D

Questionnaire – Visual Display Feedback Experiment

Questionnaire – Visual Display Feedback Experiment

Part A: Personal Information

1. **Your Age** :
 2. **Your Gender** :
 3. **Occupational status** :
 - Masters Student
 - PhD Student
 - Staff - systems, technical
 - Administrative Staff
 - Other

 4. **Please state your level of computer literacy on a scale of (1...7)**
(never used before) 1 2 3 4 5 6 7 (a great deal)
Please indicate the number which most closely represents your opinion

 5. **Have you ever experienced 'virtual reality' before?**
(never used before) 1 2 3 4 5 6 7 (a great deal)
deal)
-

Part B: Virtual Reality Experience

1. **Please give your assessment as to how well you contributed to the successful performance of the tasks.**
I performed the tasks successfully
(not at all) 1 2 3 4 5 6 7 (a great deal)

2. **To what extent did your performance improve during COLOUR FEEDBACK technique experiment?**
(not at all) 1 2 3 4 5 6 7 (a great deal)

3. **To what extent did your performance improve during TEXT FEEDBACK technique experiment?**
(not at all) 1 2 3 4 5 6 7 (a great deal)

4. **To what extent did your performance improve during COMBINATION OF COLOUR & TEXT FEEDBACK technique experiment?**
(not at all) 1 2 3 4 5 6 7 (a great deal)
5. **To what extent did you notice the feedback differ when the virtual box had a different WEIGHT(light, moderate, heavy)?**
(not at all) 1 2 3 4 5 6 7 (a great deal)
6. **When you think back about your experiment, do you think its easier to respond to the feedback given (compared to the virtual lifting without feedback)?**
(not at all) 1 2 3 4 5 6 7 (a great deal)
7. **Please give your preference as to which type of feedback you think is best in providing greater improvement in your performance.**
- | | | | | |
|--------------------------------|---|---|---|---|
| Colour Feedback | : | 1 | 2 | 3 |
| Text Feedback | : | 1 | 2 | 3 |
| Combine Colour & Text Feedback | : | 1 | 2 | 3 |

If you have any other comments, please use the space below.

Thank you for your feedback and your time spent to be as a subject in “VIRTUAL LIFTING EXPERIMENT”. We sincerely appreciate your contribution.

Appendix E

Participants' Tasks Description – Auditory Feedback

Auditory Feedback Techniques for Virtual Lifting Experiment

The aim of this experiment is to evaluate people's reaction to different Auditory feedback techniques when lifting an object in virtual environments (VE). This experiment monitors the force on your lower back and uses different Auditory feedback techniques to present this data to the lifter.

In this research you will use several different experimental conditions using Auditory control feedback techniques. You are required to complete the experiment to the best of your ability, as the results will be closely monitored.

Details of the experiments are listed below:

1. Lifting without feedback (Neutral)
2. Lifting with White-noise Feedback
3. Lifting with Pitch Feedback
4. Lifting with Tempo Feedback

Procedure

1. Sign pre-immersion consent form.
2. Enter your experimental information on the sheet provided.
3. The Experimenter will demonstrate the software and the equipment to be used.
4. You will first be required to practise with the equipment before the experiment can commence.
5. 45 minutes of post-immersion monitoring.
6. Fill in the questionnaire.

You will complete the experiment in approximately one hour.

Appendix F

Questionnaire – Auditory Feedback Experiment

Questionnaire – Auditory Feedback Experiment

Part A: Personal Information

1. **Your Age** :
 2. **Your Gender** :
 3. **Occupational status** :
 - Masters Student
 - PhD Student
 - Staff - systems, technical
 - Administrative Staff
 - Other

 4. **Please state your level of computer literacy on a scale of (1...7)**
(never used before) 1 2 3 4 5 6 7 (a great deal)
Please indicate the number which most closely represents your opinion

 5. **Have you ever experienced 'virtual reality' before?**
(never used before) 1 2 3 4 5 6 7 (a great deal)
-

Part B: Virtual Reality Experience

1. **Please give your assessment as to how well you contributed to the successful performance of the tasks.**
I performed the tasks successfully
(not at all) 1 2 3 4 5 6 7 (a great deal)

2. **To what extent did your performance improve during WHITE-NOISE FEEDBACK technique experiment?**
(not at all) 1 2 3 4 5 6 7 (a great deal)

3. **To what extent did your performance improve during PITCH FEEDBACK technique experiment?**
(not at all) 1 2 3 4 5 6 7 (a great deal)

4. **To what extent did your performance improve during TEMPO FEEDBACK technique experiment?**
(not at all) 1 2 3 4 5 6 7 (a great deal)

5. When you think back about your experiment, do you think its easier to respond to the feedback given (compared to the virtual lifting without any feedback)?

(not at all) 1 2 3 4 5 6 7 (a great deal)

6. Please give your preference as to which type of feedback you think is best in providing greater improvement in your performance.

White-noise Feedback	:	1	2	3
Pitch Feedback	:	1	2	3
Tempo Feedback	:	1	2	3

7. Why did you choose _____ as your first choice and why _____ as your third choice?

8. Other comment (Please specify here) : _____

Thank you for your feedback and your time spent to be as a subject in “VIRTUAL LIFTING EXPERIMENT”. We sincerely appreciate your contribution.

Appendix G

Time Allocation Approximation

Time Allocation Approximation

Breakdown of Experiment Timing

Event	Approximate Time (min)
Explanation and Informed Consent	5
Experiment with Virtual Weight (2kg)	7
Experiment with Real Weight (2kg)	7
Experiment with Virtual Weight (4kg)	7
Experiment with Real Weight (4kg)	7
Experiment with Virtual Weight (6kg)	7
Experiment with Real Weight (6kg)	7
Post Immersion Form and Questionnaire	5
Total Participant Time	52 minutes

Appendix H

Participants' Tasks Description – Real Weighted Object

Tactile Augmentation using Real Weighted Object

The aim of this experiment is to evaluate people's reaction to Tactile Augmentation effects when lifting an object in virtual environments (VE), but with real weighted objects. This experiment monitors the force on your lower back and uses different Visual feedback techniques to present this data to the lifter. Therefore, the lifter will receive both real and virtual feedback techniques which come from Tactile Augmentation and visual feedbacks respectively

In this research you will conduct three pairs of experiment. Each pair contains Virtual Weight and Real Weight experiment, with three different weights. You are required to complete the experiment to the best of your ability, as the results will be closely monitored.

Details of the experiments are listed below: Experiment

- | | | | |
|--------|----------------|---|-------------|
| 1. 2kg | Virtual Weight | & | Real Weight |
| 2. 4kg | Virtual Weight | & | Real Weight |
| 3. 6kg | Virtual Weight | & | Real Weight |

Sequence for Experiment 1, 2 and 3 was randomized by LSD.

For e.g.

Participant	Experiment Order		
	1 st	2 nd	3 rd
1	2kg	4kg	6kg
2	4kg	6kg	2kg
3	6kg	2kg	4kg
4	2kg	4kg	6kg
...			

And so on and so forth

Procedure

1. Sign pre-immersion consent form.
2. Enter your experimental information on the sheet provided.
3. The Experimenter will demonstrate the software and the equipment to be used.
4. You will first be required to practise with the equipment before the experiment can commence.
5. 45 minutes of post-immersion monitoring.
6. Fill in the questionnaire.

You will complete the experiment in approximately one hour.

Appendix I

Questionnaire - Real Weighted Object

Questionnaire – Real Weighted Object

Part A: Personal Information

1. **Your Age** :
2. **Your Gender** :
3. **Occupational status** :
 - Masters Student
 - PhD Student
 - Staff - systems, technical
 - Administrative Staff
 - Other

4. **Please state your level of computer literacy on a scale of (1...7)**
(never used before) 1 2 3 4 5 6 7 (a great deal)
Please indicate the number which most closely represents your opinion

5. **Have you ever experienced 'virtual reality' before?**
(never used before) 1 2 3 4 5 6 7 (a great deal)

.....

Part B: Virtual Reality Experience

1. **Please give your assessment as to how well you contributed to the successful performance of the tasks.**
I performed the tasks successfully
(not at all) 1 2 3 4 5 6 7 (a great deal)

2. **To what extent did you notice the differences of a Virtual Weight being used for the experiment?**
(not at all) 1 2 3 4 5 6 7 (a great deal)

3. **To what extent did you notice the differences of a Real Weight being used for the experiment?**
(not at all) 1 2 3 4 5 6 7 (a great deal)

4. **To what extent do you agree that using a Real Weight increases your feeling of realism?**
(not at all) 1 2 3 4 5 6 7 (a great deal)

5. When you think back about your experiment, do you prefer to perform training on manual lifting using a Virtual Weight (compared to the lifting with Real Weight)?

(not at all) 1 2 3 4 5 6 7 (a great deal)

Please give your comment on the answer given.

6. Other comment (Please specify here) : _____

Thank you for your feedback and your time spent to be as a subject in “VIRTUAL LIFTING EXPERIMENT”. We sincerely appreciate your contribution.

References

- Adams, R. J., Klowden, D. and Hannaford, B., 2001, "Virtual Training for a Manual Assembly Task", *Haptics-e*, 2(2), pp. 1-7.
- Agruss, C. D., Williams, K. R. and Fathallah, F. A., 2004, "The effect of feedback training on lumbosacral compression during simulated occupational lifting", *Ergonomics*, 47(10), pp. 1103-1115.
- Aldrich, F. K. and Parkin, A. J., 1989, "Listening at speed", *British journal of visual impairment and blindness*, 7(1), pp. 16-18.
- Aldridge, R. J., Carr, K., England, R., Meech, J. F. and Solomonides, T., 1996, "Getting a grasp on virtual reality", *Conference Companion on Human Factors in Computing Systems: Common Ground*, Vancouver, British Columbia, Canada: ACM Press, New York, pp. 229-230.
- Amos, D. K., 2001, "Immersive Virtual Environments to Aid Manual Lifting Simulations", PhD Thesis, Cardiff University.
- Anderson, C. K. and Chaffin, D. B., 1986, "A biomechanical evaluation of five lifting techniques." *Applied Ergonomics*, 17, p. 2– 8.
- Assenmacher, I., Kuhlen, T. and Lentz, T., 2005, "Binaural Acoustics for CAVE-like Environments Without Headphones", In: Blach, R. and Kjems, E. eds., *The Eurographics Association 2005.*, Aalborg, Denmark.
- Bade, R., Schlechtweg, S. and Miksch, S., 2004, "Connecting time-oriented data and information to a coherent interactive visualization", *CHI 2004*, Vienna, Austria: ACM Press, pp. 105-112.

Badler, N. I., Hollick, M. J. and J.P., G., 1993, "Real-time control of a virtual human using minimal sensors", *Presence: Teleoperators and Virtual Environments*, 2(1), pp. 82--86.

Baker, M. P. and Stein, R. J., 1997, "BattleView: Touring the Virtual Battlefield", *Proceedings of the 2nd Annual Federated Lab Symposium*, National Center for Supercomputing Applications.

Bakker, N. H., Werkhoven, P. J. and Passenier, P. O., 1999, "The Effects of Proprioceptive and Visual Feedback on Geographical Orientation in Virtual Environments", *Presence*, 8(1), p. 36--53.

Barker, P. G. and Manji, K. A., 1989, "Pictorial dialogue methods", *International Journal of Man-Machine Studies*, 31, pp. 323-347.

Barnes, J. W., 1994, "Statistical Analysis for Engineers and Scientists: A Computer-Based Approach", Singapore: McGraw-Hill.

Barreto, A. B., Jacko, J. A. and Hugh, P., 2005, "Impact of spatial auditory feedback on the efficiency of iconic human-computer interfaces under conditions of visual impairment", <http://www.sciencedirect.com/science/article/B6VDC-4F9SY1K-1/2/88fe16688f2a356238fbc0c6a24df2e6>.

Begault, D. R., 1994, "3D Sound for Virtual Reality and Multimedia", Massachusetts: Academic Press, Boston.

Beier, K. P., 2000, "Web-Based Virtual Reality in Design and Manufacturing Applications", COMPIT' 2000 (1st International EuroConference on Computer Applications and Information Technology in the Maritime Industries Potsdam), Germany.

Bernard, B. P., 1997, "Musculoskeletal Disorders and Workplace Factors: A critical review of epidemiologic evidence for work-related musculoskeletal disorders of the neck, upper-extremity, and low back", NIOSH 1997 Musculoskeletal Disorders and Workplace Factors, Cincinnati.

Birmanns, S. and Wriggers, W., 2003, "Interactive fitting augmented by force-feedback and virtual reality", *Journal of Structural Biology*, 144, p. 123–131.

Blauert, J. and Lehnert, H., 1991, "Virtual Auditory Environment", 5th International Conference on Advanced Robotics : '91 ICAR, New York, NY: IEEE, pp. 211-216.

Bly, S., 1982, "Presenting information in sound", CHI '82 Conference on Human Factors in Computer Systems: New York: ACM, pp. 371-375.

Bobick, T. G., Belard, J. L., Hsiao, H. and Wassell, J. T., 2001, "Physiological Effects of Back Belt Wearing During Asymmetric Lifting", *Applied Ergonomics*, 32(6).

Boff, K. R. and Lincoln, J. E., 1988, "Engineering Data Compendium: Human Perception and Performance", Ohio: Harry G Armstrong Aerospace.

Bolas, M. T., 1994, "Human Factors in the Design of an Immersive Display", *IEEE Computer Graphics and Applications*, 14(1), pp. 55-57.

Boud, A. C., Baber, C. and Steiner, S. J., 2000, "Virtual Reality: A Tool for Assembly?" *Presence*, 9(5), pp. 486-496.

Bovenzi, M. and Hulshof, C. T., 1999, "An updated review of epidemiologic studies on the relationship between exposure to whole-body vibration and low back pain (1986-1997)", *International Archives of Occupational and Environmental Health*, 72, pp. 351-365.

Brederson, J., Ikits, M., Johnson, C. and Hansen, C., 2000, "The visual haptic workbench", In Proc. of PHANToM Users Group Workshop.

Brewster, S. A., 2002, "Non-speech auditory output", The Human Computer Interaction Handbook, Lawrence Erlbaum Associates, USA, pp. 220-239.

Brook, D., 1997, "Haptic Interfaces in Virtual Reality", <http://www.hpcc.ecs.soton.ac.uk/~dtcb98r/vrhap/vrhap.htm#Fooling>.

Burdea, G. C., 1996, "Force and touch feedback for virtual reality", New York: John Wiley & Sons.

Burdorf, A. and Sorock, G., 1997, "Positive and negative evidence of risk factors for back disorders", Scandinavian Journal of Work and Environmental Health, 23, pp. 243-256.

Burgess-Limerick, R., 2003, "Squat, stoop, or something in between?" International Journal of Industrial Ergonomics, 31(3), pp. 143-148.

Burgess-Limerick, R. and Abernethy, B., 1998, "Effect of load distance on self-selected manual lifting technique", International Journal of Industrial Ergonomics, 22, pp. 367-372.

Buxton, W., Gaver, W. and Bly, S., 1991, "Auditory Interfaces: The Use of Non-Speech Audio at the Interface", In: Robertson, S.P. and Olson, G.M. and Olson, J.S. eds., CHI'91, New Orleans, Louisiana, USA: ACM.

Calhoun, G. L., Valencia, G. and Furness, T., 1987, "Three Dimensional Auditory Cue Simulator for Crew Station Design/Evaluation", Human Factors Society 31st Annual Meeting, Santa Monica, CA.: The Human Factors Society, pp. 1398-1402.

CAVELib, 2000, "CAVELib Manual", http://www.vrco.com/CAVE_USER/.

Chandler, P. and Sweller, J., 1991, "Cognitive Load Theory and the Format of Instruction", *Cognition and Instruction*, 8, pp. 293-332.

Chang, C. C., Hsiang, S., Dempsey, P. G. and McGorry, R. W., 2003, "A computerized video coding system for biomechanical analysis of lifting tasks", *International Journal of Industrial Ergonomics*, 32, p. 239–250.

Chow, D. H. K., Cheng, I. Y. W., Holmes, A. D. and Evans, J. H., 2005, "Postural perturbation and muscular response following sudden release during symmetric squat and stoop lifting", *Ergonomics*, 48(6), p. 591 – 607.

Cobb, G. W., 2002, "Introduction to Design and Analysis of Experiments", Springer, p. 802.

Cobb, S. V. G., Nicholas, S. and Ramset, A., 1999, "Virtual Reality Induced Symptoms and Effects (VRISE)", *Presence*, 8(2), pp. 169-186.

Cook, P., Essl, G., Tzanetakis, G. and Trueman, D., 1998, "Multi-speaker Display Systems for Virtual Reality and Spatial Audio Projection", *Proc. Int. Conf. Auditory Display (ICAD)*, Glasgow, Scotland.

Costello, P. J., 1997, "Health and Safety Issues associated with Virtual Reality - A Review of Current Literature", Leicestershire: Loughborough University, p. 23.

Crison, F., Lecuyer, A., Savary, A., Mellet-d'Huart, D., Burkhardt, J. M. and Dautin, J. L., 2004, "The Use of Haptic and Pseudo-Haptic Feedback for the Technical Training of Milling", *Eurohaptics Conference*, Munich, Germany.

Crossan, A., Brewster, S. A., Reid, S. and Mellor, D., 2000, "Multimodal Feedback Cues To Aid Veterinary Training Simulations", *Proceedings of the First Workshop on Haptic Human-Computer Interaction*, pp. 45-49.

D'huart, M. D., 2002, "Virtual Environment for training: An Art of Enhancing Reality", In: FRASSON C. & JOAB M., E. ed., Workshop Proceedings "Simulation based training", San Sebastian et Biarritz, pp. 63-68.

Dai, F., 1997, "Virtual Reality for Industrial Applications", Germany: Springer.

Das, B. and Shikdar, A., 1999, "Participative versus assigned production standard setting in a repetitive industrial task: a strategy for improving worker productivity", International Journal of Occupational Safety and Ergonomics, 5(3), pp. 417-430.

Dezelic, V., Apel, D. B., Denney, D. B., Schneider, A. J., Hilgers, M. G. and Grayson, R. L., 2005, "Training for new underground rock bolters using virtual reality", Computer Applications in Mining Industries (CAMI).

Doel, K., Kry, P. G. and Pai, D. K., 2001, "Physically-based Sound Effects for Interactive Simulation and Animation", Proceedings of ACM SIGGRAPH'2001, Los Angeles, CA, USA.

Durlach, P. J., Fowlkes, J. and Metevier, C. J., 2005, "Effect of Variations in Sensory Feedback on Performance in a Virtual Reaching Task", Presence, 14(4).

Edgar, G. K. and Bex, P. J., 1995, "Simulated and Virtual Realities - Elements of Perception", In: Carr, K. and England, R. eds. Vision and Displays, London: Taylor and Francis.

Edwards, A., 1989, "Soundtrack: an auditory interface for blind users", Human-Computer Interaction, 4(1), pp. 45-66.

Ellis, R. E., Ismaeil, O. M. and Lipsett, M. G., 1996, "Design and Evaluation of a High-Performance Haptic Interface", Robotica, 14, pp. 321-327.

Eynard, E., Fubini, E., Masali, M., Cerrone, M. and Tarzia, A., 2000, "Generation of virtual man models representative of different body proportions and application to ergonomic design of vehicles", In Proceedings of the XIVth Triennial Congress of the International Ergonomics Association and 44th Annual Meeting of the Human Factors and Ergonomics Association, Ergonomics for the New Millennium', San Diego, CA USA.

Faraday, P. and Sutcliffe, A., 1997, "Designing Effective Multimedia Presentations", CHI 97.

Feintuch, U., Rand, D., Kizony, R. and Weiss, P. L., 2004, "Promoting research and clinical use of haptic feedback in virtual environments", Proceeding of 5th International Conference Disability, Oxford, UK: Virtual Reality & Assoc. Tech.

Ferguson, S. A., Gaudes-Maclaren, L. L., Marras, W. S., Waters, T. R. and Davis, K. G., 2002, "Spinal loading when lifting from industrial storage bins", Ergonomics, 45(6), pp. 399-414.

Ferguson, S. A. and Marras, W. S., 1997, "A literature review of low back disorder surveillance measures and risk factors", Clinical Biomechanics, 12, pp. 211-226.

Ferguson, S. A., Marras, W. S. and Burr, D., 2005, "Workplace design guidelines for asymptomatic vs. low-back-injured workers", Applied Ergonomics, 36(1), pp. 85-95.

Fischer, S., 1994, "Multimedia Authoring", Boston, MA: AP Professional.

Froner, B. N. and Holliman, S., 2005, "Implementating an Improved Stereoscopic Camera Model", Eurographics Theory and Practice of Computer Graphics 2005, Canterbury.

Garg, A. D. and Herrin, G. D., 1979, "Stoop or squat: a biomechanical and metabolic evaluation", AIIE transactions, 11, p. 293 – 302.

Gaver, W. W., 1989, "The SonicFinder: An interface that uses auditory icons", *Human Computer Interaction*, 4(1), pp. 67-94.

Gaver, W. W., Smith, R. B. and O'Shea, T., 1991, "Effective Sounds in Complex Systems: The Arkola Simulation", *Proceedings of CHI 91 ACM Press*, pp. 85-90.

Genaidy, A. M., 1991, "A training program to improve human physical capability for manual handling jobs", *Ergonomics*, 34, pp. 1-11.

Gerovichev, O., Marayong, P. and Okamura, A. M., 2002, "The Effect of Visual and Haptic Feedback on Manual and Teleoperated Needle Insertion", *Proceedings of the Fifth International Conference on Medical Image Computing and Computer Assisted Intervention -- MICCAI 2002, Tokyo, Japan*, pp. 147-154.

Gill, S. A. and Ruddle, R. A., 1998, "Using virtual humans to solve real ergonomic design problem", *Proceedings of the 1998 International Conference on Simulation: IEE Conference Publication*, pp. 223-229.

Green, K., 1997, "Alliance Debuts ImmersaDesk2 at SC97", <http://access.ncsa.uiuc.edu/Releases/97Releases/971114.ID2.html>.

Gupta, R., Whitney, D. and Zeltzer, D., 1997, "Prototyping and Design for Assembly Analysis using Multimodal Virtual Environments", *Computer Aided Design (Special issue on VR in CAD)*, 29(8), pp. 585-597.

Hahn, J. K., Fouad, H., Gritz, L. and Lee, J. W., 1998, "Integration Sounds and Motions in Virtual Environments", *Presence*, 7(1), pp. 67-77.

Hancock, M. S., Shen, C., Forlines, C. and Ryall, K., 2005, "Exploring Non-Speech Auditory Feedback at an Interactive Multi-User Tabletop", Graphics Interface 2005, Victoria, British Columbia, Canada.

Hand, C., 1997, "A survey of 3D interaction techniques", Computer Graphics Forum, 16(5), p. 269–281.

Hartvigsen, J., Lauritzen, S., Lings, S. and Lauritzen, T., 2005, "Intensive education combined with low tech ergonomic intervention does not prevent low back pain in nurses", Occupational and Environmental Medicine, 62, pp. 13-17.

Hathiyari, K., Whitman, L. and Jorgensen, M. J., 2003, "Palletizing tasks in the real world and the virtual world", Proceedings of the 8th Annual International Conference on Industrial Engineering Theory, Las Vegas, NV, pp. 684-689.

Held, R. and Durlach, N., 1991, "Telepresence, time delay and adaptation", In: Ellis, S.R. ed. Pictorial communication in virtual and real environments, New York: Taylor and Francis.

Helmholtz, H., 2000, "Treatise on physiological optics", Thoemmes Press.

Henderson, T., 1994, "Lesson 2: Sound Properties and Their Perception", <http://www.glenbrook.k12.il.us/gbssci/phys/Class/info.html#author>.

Hinckley, K., Pausch, R., Goble, J. C. and Kassell, N. F., 1994, "Passive real-world interface props for neurosurgical visualization", In: Press, A. ed., Proceedings of the SIGCHI conference on Human factors in computing systems: celebrating interdependence, Boston, Massachusetts, United States, pp. 452-458.

Hmeljak, D. M., 2004, "There's something about audio", <http://www.avl.iu.edu/~mitja/>.

Hodges, L. F., 1992, "Tutorial: time-multiplexed stereoscopic computer graphics", IEEE Computer Graphics and Applications, pp. 20-30.

Hodges, L. F. and McAllister, D. F., 1987, "Stereo and alternating pair techniques for display of computer generated images", IEEE Computer Graphics and Applications, 5(9), pp. 38-45.

Hoffman, H. G., 1998, "Physically Touching Virtual Objects Using Tactile Augmentation Enhances the Realism of Virtual Environments", Proceedings of the IEEE Virtual Reality Annual International Symposium '98, Atlanta GA: IEEE Computer Society, Los Alamitos, California, pp. 59-63.

Hoffman, H. G., Groen, J., Rousseau, S., Hollander, A., Winn, W., Wells, M. and Furness, T., 1996, "Tactile Augmentation: Enhancing presence in virtual reality with tactile feedback from real objects", Paper presented at the meeting of the American Psychological Society, San Francisco, Ca.

Hollands, M. A. and Marple-Horvat, D. E., 1996, "Visually guided stepping under conditions of step cycle-related denial of visual information", Experimental Brain Research, 109, 343-356., 109, p. 343-356.

Holliman, N. S., 2005, "Smoothing Region Boundaries in Variable Depth Mapping for Real Time Stereoscopic Images", Stereoscopic Displays and Virtual Reality Systems XVI, SPIE.

Hopkins, G., 2004, "Virtual Reality - Software and Hardware", <http://www.mrl.nott.ac.uk/~gtr/MVR/MVR0506/VRGeneric.pdf>.

Howard, I. P. and Rogers, B. J., 2002, "Seeing in Depth: Volume 1 and 2", Ontario, Canada: Porteous Publishing.

Howarth, P. and Costello, P., 1996, "Visual Effects of Immersion in Virtual Environments: Interim Results", Society for Information Display International Symposium Digest of Technical Papers, San Diego, pp. 885-888.

Hsiang, S. M., Brogmus, G. E. and Courtney, T. K., 1997, "Low back pain (LBP) and lifting technique -- A review", International Journal of Industrial Ergonomics, 19(1), pp. 59-74.

Infed, F., Brown, S., Lee, C., Lawrence, D., Dougherty, A. and Pao, L., 1999, "Combined visual/haptic rendering modes for scientific visualization", In Proc. of 8th Annual ASME Symposium on Haptic Interfaces for Virtual Environments and Teleoperator Systems, p. 93-99.

Insko, B. E., Meehan, M. J., Whitton, M. C. and Brooks, F. P., 2001, "Passive Haptics Significantly Enhances Virtual Environments", Computer Science Technical Report 01-010, University of North Carolina: Chapel Hill.

Isdale, J., 2003, "Introduction to Virtual Environment Technology", The IEEE Virtual Reality 2003 Conference (IEEE-VR2003), Los Angeles, California, USA.

Iwata, H., 2004, "Full-Surround Image Display Technologies", International Journal of Computer Vision, 58(3), pp. 227-235.

Jayaram, S., Jayaram, U., Wang, Y., Tirumali, H., Lyons, K. and Hart, P., 1999, "VADE: A Virtual Assembly Design Environment", IEEE Computer Graphics and Applications, 19(6), pp. 44-50.

Johansson, A. J. and Linde, J., 1998, "Using simple force feedback mechanisms to visualize structures by haptics", the Second Swedish Symposium of MultiModal Communications.

Johnson, D. M. and Stewart, J. E., 1999, "Use of Virtual Environments for the Acquisition of Spatial Knowledge: Comparison Among Different Visual Displays", *Military Psychology*, 11(2), pp. 129-148.

Kaber, D. B., Draper, J. V. and Usher, J. M., 2005, "Chapter 22: Influence of Individual Differences on Virtual Reality Application Design for Individual and Collaborative Virtual Environments", http://vehand.engr.ucf.edu/handbook/Chapters/Chapter22/Chap_22.html.

Kalawsky, R., 1993, "The Science of Virtual Reality and Virtual Environments", Cambridge: Addison-Wesley Longman Publishing Co., Inc.

Kalawsky, R., 1996, "Exploiting Virtual Reality Techniques in Education and Training: Technological Issues", SIMA Report Series.

Kantowitz, B. and Sorkin, R., 1983, "Human factors: Understanding people-system relationships." New York: Wiley.

Kingma, I., Delleman, N. J. and van Dieen, J. H., 2003, "The effect of ship accelerations on three-dimensional low back loading during lifting and pulling activities", *International Journal of Industrial Ergonomics*, 32(1), pp. 51-63.

Klein, B. P., Jensen, R. C. and Sanderson, L. M., 1984, "Assessment of workers' compensation claims for back strains/sprains", *Journal of Occupational Medicine*, 26, p. 443 – 448.

Kolasinski, E. M., 1995, "Simulator sickness in virtual environments", Alexandria, VA.: U.S. Army Research Institute for the Behavioural and Social Sciences.

Kramer, G., Walker, B., Bonebright, T., Cook, P., Flowers, J., Miner, N. and Neuhoff, J., 1999, "Sonification report: Status of the field and research agenda", National Science Foundation.

Kuiper, J. I., Burdorf, A., Verbeek, J. H. A. M., Frings-Dresen, M. H. W., Van Der Beek, A. J. and Viikarijuntura, E. R. A., 1999, "Epidemiologic evidence on manual materials handling as a risk factor for back disorders: a systematic review", *International Journal of Industrial Ergonomics*, 24, p. 389 – 404.

Kumar, S., 1984, "The physiological cost of three different methods of lifting in sagittal and lateral planes", *Ergonomics*, 27, p. 425 – 433.

Lariviere, C., Gagnon, D. and Loisel, P., 2002, "A biomechanical comparison of lifting techniques between subjects with and without chronic low back pain during freestyle lifting and lowering tasks", *Clinical Biomechanics*, 17, pp. 89-98.

Larsson, P., Västfjäll, D. and Kleiner, M., 2001, "Do we really live in a silent world? The (mis)-use of audio in virtual environments", *Applied Virtual Reality in Engineering and Construction*, Chalmers.

Lathan, C., Cleary, K. and Traynor, L., 2000, "Human Centered Design of a Spine Biopsy Simulator and the Effects of Visual and Force Feedback on Path Tracking Performance", *Presence*, 9(4), p. 337–349.

Lathan, C. and Tracey, M., 2002, "The effects of operator spatial perception and sensory feedback on human-robot teleoperation performance", *Presence: Teleoperators and Virtual Environments*, 11(4), pp. 1054-7460.

Lavendar, S. A., 2000, "A test of the lift trainer: an aggressive approach for preventing back injury through training", *Proceeding of the IEA 2000/HFES 2000 Congress*, Santa Monica, pp. 463-465.

Lawrence, D., Lee, C., Pao, L. and Novoselov, R., 2000, "Shock and vortex visualization using a combined visual/haptic interface", *In Proc. IEEE Visualization*, p. 131–138.

Lécuyer, A., Burkhardt, J. M. and Etienne, L., 2004, "Feeling bumps and holes without a haptic interface: the perception of pseudo-haptic textures", Proceedings of the SIGCHI conference on Human factors in computing systems, Vienna, Austria: ACM Press, pp. 239-246.

Lécuyer, A., Coquillart, S. and Coiffet, P., 2000, "Simulating Haptic Information with Haptic Illusions in Virtual Environments", NATO RTA/Human Factors & Medicine Panel Workshop, The Hague, The Netherlands.

Lecuyer, A., Coquillart, S., Kheddar, A., Richard, P. and Coiffet, P., 2000, "Pseudo-haptic feedback: can isometric input devices simulate forcefeedback?" IEEE International Conference on Virtual Reality, New Brunswick, NJ, USA, pp. 83-90.

Lécuyer, A., Megard, C., Burkhardt, J. M., Lim, T., Coquillart, S., Coiffet, P. and Graux, L., 2002, "The Effect of Haptic, Visual and Auditory Feedback on an Insertion Task on a 2-Screen Workbench", Immersive Projection Technology (IPT) Symposium, Orlando, US.

Leskinen, T. P., Stalhammar, H. R., Kuorinka, I. A. and Troup, J. D., 1983, "A dynamic analysis of spinal compression with different lifting techniques", *Ergonomics*, 26, p. 595 – 604.

Lin, C. J., Ayoub, M. M. and Bernard, T. M., 1999, "Computer motion simulation for sagittal plane lifting activities", *International Journal of Industrial Ergonomics*, 24, pp. 141-155.

Lin, Y. H., Chen, C. S., Chen, W. J. and Cheng, C. K., 2002, "Characteristics of manual lifting activities in the patients with low back pain", *International Journal of Industrial Ergonomics*, 29(2), pp. 101-106.

Lindbeck, L. and Arborelius, U. P., 1991, "Inertial effects from single body segments in dynamic analysis of lifting", *Ergonomics*, 34(4), pp. 421-433.

Lindeman, R.W., Sibert, J. L. and Hahn., J. K., 1999, "Hand-Held Windows: Towards Effective 2D Interaction in Immersive Virtual Environments." *IEEE Virtual Reality*.

Lingard, B., 1995, "Human Interfacing Issues of Virtual Reality", <http://web.cs.wpi.edu/~matt/courses/cs563/talks/brian1.html>.

Lintern, G., 1980, "Transfer of Landing Skill after training with supplementary visual cues", *Human Factors*, 22, pp. 81-88.

Liu, T. and Jensen, J. L., 2004, "Effectiveness of auditory-visual stimuli for learning timing skills by children in a repetitive task", *Journal of Sport & Exercise Psychology*, (Suppl.), S124.

Lu, L., Connell, M. and Tullberg, O., 2002, "The Use of Virtual Reality in Interactive Finite Element Analysis: State of the Art Report", Chalmers University of Technology, Gothenburg, Sweden. Sweden: Department of Structural Mechanics, Chalmers University of Technology, Göteborg, Sweden.

Lunney, D. and Morrison, R. C., 1981, "High technology laboratory aids for visually Handicapped chemistry Students", *Journal of Chemical Education*, 58(3), pp. 228-231.

Machover, C. and Tice, S. E., 1994, "Virtual reality", *Computer Graphics and Applications*, IEEE, 14(1), pp. 15 - 16.

MacLean, K. E., 2000, "Designing with Haptic Feedback", *Symposium on Haptic Feedback in the Proceedings of IEEE Robotics and Automation (ICRA'2000)*, San Francisco, CA.

Maravita, A., Spence, C., Sergent, C. and Driver, J., 2002, "Seeing your own touched hands in a mirror modulates crossmodal interactions", *Psychological Science*, 13, p. 350–355.

Marentakis, G. and Brewster, S. A., 2005, "Gesture Interaction with Spatial Audio Displays: Effects of Target Size and Inter-Target Separation", *Proceedings of ICAD 05-Eleventh Meeting of the International Conference on Auditory Display*, Limerick, Ireland.

Marley, R. J. and Duggasani, A. R., 1996, "Effects of industrial back supports on physiological demand, lifting style, and perceived exertion", *International Journal of Industrial Ergonomics*, 17, pp. 445-453.

Marmorstein, S. C., 2002, "Taking ergonomics into consideration yields better chiropractic care for your patients", *The Human Factor*, 4(2), pp. 42-44.

Marras, W. S., Davis, K. G. and Jorgensen, M., 2003, "Gender influences on spine loads during complex lifting", *The Spine Journal*, 3, pp. 93-99.

Marras, W. S., Ferguson, S. A., Burr, D., Davis, K. G. and Gupta, P., 2004, "Spine loading in patients with low back pain during asymmetric lifting exertions", *The Spine Journal*, 4, p. 64–75.

Massimino, M. J. and Sheridan, T. B., 1994, "Sensory Substitution for Force Feedback in Teleoperation", *Presence*, 2(4), pp. 344-352.

Massura, B. 2002. "Visualization lab opens doors for Purdue", *The Exponent (Online)*, Campus, 07-19-2002.

Mazur, K. M. and Reising, J. M., 1990, "The relative effectiveness of three visual depth cues in a dynamic air situation display", Proceedings of Human Factors Society 34th Annual Meeting, pp. 16-20.

McCall, R., O'Neill, S. and Carroll, F., 2004, "Measuring presence in virtual environments", CHI '04, Vienna, Austria: ACM Press, pp. 56 -58.

McKean, C. M. and Potvin, J. R., 2001, "Effects of a simulated industrial bin on lifting and lowering posture and trunk extensor muscle activity", International Journal of Industrial Ergonomics, 28, p. 1–15.

Mendoza, C. and Laugier, C., 2003, "Simulating Cutting in Surgery Applications using Haptics and Finite Element Models", IEEE Virtual Reality Conference 2003 (VR'03), p. 295.

Mérienne, F., Neveu, M., Chevaldonné, M., Guillaume, F., Chevassus, N. and Dureigne, M., 2005, "Human Machine Interface Concept for Virtual Reality Applications", WSCG'2005, Czech Republic: Science Press, pp. 7-9.

Merwin, D. H. and Wickens, C. D., 1991, "2-D vs. 3-D display for multidimensional data visualization: The relationship between task integrality and display proximity", Proceedings of Human Factors Society 35th Annual Meeting, pp. 388-392.

Mezrich, J. J., Frysinger, S. and Slivjanovski, R., 1984, "Dynamic representation of multivariate time series data", Journal of the American Statistical Association, 79, pp. 34-40.

Milgram, P. and Kishino, F., 1994, "A Taxonomy of Mixed Reality Visual Displays", Trans on Information and Systems (Special Issue on Networked Reality), vol E77-D(12), p. 1321–1329.

Miner, N., Gillespie, B. and Caudell, T., 1996, "Examining the Influence of Audio and Visual Stimuli on a Haptic Display", IMAGE Conference Proceedings, Phoenix, AZ, pp. 23-25.

Moody, L., Baber, C. and Arvanitis, T. N., 2001, "The Role of Haptic Feedback in the Training and Assessment of Surgeons using a Virtual Environment", Eurohaptics, Birmingham, UK, pp. 170-173.

Mortensen, J., Vinayagamoorthy, V., Slater, M. and Steed, A., 2002, "Collaboration in Tele-Immersive Environments", In: Müller, S. and Stürzlinger, W. eds., Eighth Eurographics Workshop on Virtual Environments, University College London: The Eurographics Association.

Murakami, T. and Nakajima, N., 1994, "Direct and intuitive input device for 3-D shape deformation", In: Press, A. ed., Proceedings of the SIGCHI conference on Human factors in computing systems: celebrating interdependence, Boston, Massachusetts, United States, pp. 465-470.

Naef, M., Stadt, O. and Gross, M., 2002, "Spatialized audio rendering for immersive virtual environments", Virtual Reality Software and Technology (VRST '02), Hong Kong, China: ACM Press, New York, pp. 65-72.

Nalgirkar, M. and Mital, A., 1999, "A User-Friendly Three-Dimensional Kinetic Model for Analyzing Manual Lifting Tasks", International Journal of Industrial Ergonomics, 23(4), pp. 255-268.

Nave, C. R., 2000, "Doing It by the Numbers: Javascript Calculations in Web-Based Instructional Material", <http://hyperphysics.phy-astr.gsu.edu/Papers/aaptg1.html>.

Neuhoff, J. G., Kramer, G. and Wayand, J., 2002, "Pitch and loudness interact in auditory displays: Can the data get lost in the map?" *Journal of Experimental Psychology: Applied*, 8(1), pp. 17-25.

Oakley, I., McGee, M. R., Brewster, S. and Gray, P., 2000, "Putting the Feel in 'Look and Feel'", In: Press, A. ed., *Proceedings of the SIGCHI conference on Human factors in computing systems*, The Hague, The Netherlands, pp. 415-422.

Pagarkar, M. H., 2004, "Endoscopic Surgery: The (better) VR Way", <http://www.cs.jhu.edu/~habib/papers/HabibullahSensoryEngg.pdf>.

Pape, D., Cruz-Neira, C. and Czernuszenko, M., 1997, "CAVE User's Guide", <http://www.evl.uic.edu/pape/CAVE/prog/CAVEGuide.html#description>.

Patel, H. and Cardinali, R., 1994, "Virtual Reality Technology in Business", *Management Decision*, 32, pp. 5-12.

Patrick, E., Cosgrove, D., Slavkovic, A., Rode, J. A., Verratti, T. and Chiselko, G., 2000, "Using a Large Projection Screen as an Alternative to Head-Mounted Displays for Virtual Environments", *CHI 2000*, Pittsburgh, pp. 478-485.

Patterson, R. D., 1982, "Guidelines for auditory warning systems on civil aircraft", CAA Paper, London: Civil Aviation Authority.

Pausch, R., Crea, T. and Conway, M., 1992, "A Literature Survey for Virtual Environments: Military Flight Simulator Visual Systems and Simulator Sickness", *Presence: Teleoperators and Virtual Environments*, 1(3), pp. 344-363.

Pavani, F., Spence, C. and Driver, J., 2000, "Visual capture of touch: Out-of-the-body experiences with rubber gloves." *Psychological Science*, 11, p. 353-359.

Péruch, P., May, M. and Wartenberg, F., 1997, "Homing in virtual environments: Effects of field of view and path layout", *Perception*, 26, pp. 301-311.

Petzold, B., Zaeh, M. F., Faerber, B., Deml, B., Egermeier, H., Schilp, J. and Clarke, S., 2004, "A study on visual, auditory, and haptic feedback for assembly tasks", *Presence: Teleoperators and Virtual Environments*, 13(1), pp. 16-21.

Pheasant, S., 1996, "Bodyspace: Anthropometry, Ergonomics and the Design of Work", London: Taylor & Francis.

Platt, P. A., Dahn, D. A. and Amburn, P., 1991, "Low-Cost Approaches to Virtual Flight Simulation", In: IEEE ed., *Proceedings of the IEEE 1991 National Aerospace and Electronics Conference NAECON*, New York, pp. 940-946.

Polys, N., Kim, S. and Bowman, D. A., 2005, "Effects of Information Layout, Screen Size, and Field of View on User Performance in Information-Rich Virtual Environments", *ACM Symposium on Virtual Reality Software and Technology (VRST)*, Monterey, CA.

Poupyrev, I., Okabe, M. and Maruyama, S., 2004, "Haptic Feedback for Pen Computing: Directions and Strategies", *Conference on Human Factors in Computing System*, Vienna, Austria, pp. 1309-1312.

Poupyrev, I., Weghorst, S., Billingham, M. and Ichikawa, T., 1998, "Egocentric Object Manipulation in Virtual Environments: Empirical Evaluation of Interaction Techniques", *EUROGRAPHICS' 98*, 17(3).

Rabinowitz, D., Bridger, R. S. and Lambert, M. I., 1998, "Lifting technique and abdominal belt usage: a biomechanical, physiological, and subjective investigation", *Safety Science*, 28(3), pp. 155-164.

Randall, S. B., 1997, "A Guide to Manual Materials Handling and Back Safety", Raleigh, NC: Division of Occupational Safety and Health.

Randall, S. B., 2002, "A Guide to Manual Materials Handling and Back Safety", In: Jeter, G. ed. Raleigh, NC: N.C. Department of Labor Occupational Safety and Health Program.

Rauterberg, M., 1999, "Different effects of auditory feedback in manmachine interfaces", Human Factors in Auditory Warnings, Aldershot, UK: Ashgate Publishing, pp. 225-242.

Regan, E. C. and Price, K. R., 1993, "Some side-effects of immersion virtual reality: the effects of increasing head movements, of rapid interaction, and of seated subjects", Farnborough: Army Personnel Research Establishment.

Reynolds, R. F. and Day, B. L., 2005, "Visual guidance of the human foot during a step", The Physiological Society: Journal compilation, 569(2), pp. 677-684.

Richard, P., Birbent, G., Coiffet, P., Burdea, G., Gomez, D. and Langrana, N., 1996, "Effect of frame rate and force feedback on virtual object manipulation", Presence: Teleoperators and Virtual Environments, 5, pp. 95-108.

Richard, P. and Coiffet, P., 1995, "Human perceptual issues in virtual environments: Sensory substitution and information redundancy", Proceedings of the IEEE International Workshop on Robot and Human Communication, pp. 301-306.

Riley, M. W. and Dhuyvetter, R. L., 2000, "Design cost savings and ergonomics", Proceedings of the XIVth Triennial Congress of the International Ergonomics Association and 44th Annual Meeting of the Human factors and Ergonomics Association: Ergonomics for the New Millennium, San Diego, CA USA.

Ruddle, R., Payne, S. and Jones, D., 1999, "Navigating large-scale virtual environments: What differences occur between helmet-mounted and desk-top displays", *Presence: Teleoperators and Virtual Environments*, 8(2), pp. 157-168.

Rudy, T. E., Boston, J. R., Lieber, S. J., Kubinski, J. A. and Stacey, B. R., 2003, "Body motion during repetitive isodynamic lifting: a comparative study of normal subjects and low-back pain patients", *Pain*, 105(1-2), pp. 319-326.

Sanders, M. S. and McCormick, E. J., 1987, "Human factors in engineering and design", 6th ed ed. New York: McGraw-Hill.

Shackel, B., 2000, "People and computers - some recent highlights", *Applied Ergonomics*, 31, pp. 595-608.

Shaikh, I., Jayaram, U., Jayaram, S. and Palmer, C., 2004, "Participatory Ergonomics Using VR Integrated With Analysis Tools", *Proceedings of the 2004 Winter Simulation Conference*.

Shen, Y., Devarajan, V. and Eberhart, R., 2005, "Haptic Herniorrhaphy Simulation with Robust and Fast Collision Detection Algorithm", *Medicine Meets Virtual Reality*, Long Beach, CA.

Sheridan, T. B., 1992, "Musings on Telepresence and Virtual Presence", *Presence: Teleoperators and Virtual Environments*, 1(1), pp. 120-125.

Sollenberger, R. L. and Milgram, P., 1991, "A comparative study of rotational and stereoscopic computer graphic depth cues", *Proceedings of Human Factors Society*, pp. 1452-1456.

Sourin, A., Sourina, O. and Sen, H. T., 2000, "Virtual Orthopedic Surgery Training", In: Rosenblum, L. and Macedonia, M. eds., IEEE.

Stanney, K. M., Mourant, R. R. and Kennedy, R. S., 1998, "Human Factors Issues in Virtual Environments", *Presence*, 7(4), p. 327–351.

Stfelman, L. J., 1995, "A tool to support speech and non-speech audio feedback generation in audio interfaces", *Proceedings of the 8th annual ACM symposium on User interface and software technology*, Pittsburgh, Pennsylvania, United States: ACM Press, pp. 171-179.

Stone, R., 2000, "Haptic feedback: A potted history, from telepresence to virtual reality", *The First International Workshop on Haptic Human-Computer Interaction*, Glasgow, UK: Springer-Verlag, pp. 1-7.

Straker, L., 2003, "Evidence to support using squat, semi-squat and stoop techniques to lift low-lying objects", *International Journal of Industrial Ergonomics*, 31(3), pp. 149-160.

Swaminathan, K. and Sato, S., 1997, "Interaction Design for Large Displays", *ACM Interactions*, 4(1), pp. 15-24.

Swan, R. C. and Allan, J., 1998, "Aspect Windows, 3-D Visualizations, and Indirect Comparisons of Information Retrieval Systems", *SIGIR'98*, Melbourne, Australia: ACM Inc.

Swinkels-Meewisse, I., Roelofs, J., Oostendorp, R., Verbeek, A. and Vlaeyen, J., 2006, "Acute low back pain: pain-related fear and pain catastrophizing influence physical performance and perceived disability." *Pain*, 120(1-2), pp. 36-43.

Takemura, H. and Kishino, F., 1992, "Cooperative work environment using virtual workspace", *Proc. Computer Supported Cooperative Work (CSCW'92)*, pp. 226-232.

Tan, D. S., Gergle, D., Scupelli, P. G. and Pausch, R., 2003, "With similar visual angles, larger displays improve spatial performance", *CHI 2003*, pp. 217-224.

Tan, D. S., Gergle, D., Scupelli, P. G. and Pausch, R., 2004, "Physically Large Displays Improve Path Integration in 3D Virtual Navigation Tasks", CHI 2004, Vienna, Austria: ACM.

Tecnomatix, U., 2004, "Jack", http://www.ugs.com/products/tecnomatix/human_performance/jack/.

Temple, R. and Adams, T., 2000, "Ergonomic Analysis of a Multi-Task Industrial Lifting Station Using the NIOSH Method", *Journal of Industrial Technology*, 16(2).

Times, 2004, "Pain busters: Backache: The £6bn ache, and how to beat it." <http://www.timesonline.co.uk/article/0,,8123-1250686,00.html>.

Tory, M., Kirkpatrick, A. E., Atkins, M. S. and Moller, T., 2006, "Visualization Task Performance with 2D, 3D, and Combination Displays", *Visualization and Computer Graphics*, 12(1), pp. 2-13.

Tyndiuk, F., Lespinet-Najib, V., Thomas, G. and Schlick, C., 2004, "Impact of large displays on virtual reality task performance", 3rd international Conference on Computer Graphics, Virtual Reality, Visualisation and interaction, Stellenbosch, South Africa.

Tyndiuk, F., Thomas, G., Lespinet-Najib, V. and Schlick, C., 2005, "Cognitive comparison of 3D interaction in front of large vs. small displays", *ACM Symposium on Virtual Reality Software and Technology*, Monterey, CA, USA: ACM Press, pp. 117-123.

Tzelgov, J., Srebro, R., Henik, A. and Kushelevsky, A., 1987, "Radiation search and detection by ear and by eye." *Human Factors*, 29(1), pp. 87-95.

Vince, J., 1998, "Essential Virtual Reality Fast", London: Springer.

Vora, J., Nair, S., Gramopadhye, A. K., Duchowski, A. T., Melloy, B. J. and Kanki, B., 2002, "Using virtual reality technology for aircraft visual inspection training: presence and comparison studies", *Applied Ergonomics*, 33(6), pp. 559-570.

Waddell, G. and Burton, K., 2000, "Occupational Health Guidelines for the Management of Low Back Pain", London.: Faculty of Occupational Medicine.

Wall, S. A., Paynter, K., Shillito, A. M., Wright, M. and Scali, S., 2002, "The Effect of Haptic Feedback and Stereo Graphics in a 3D Target Acquisition Task", *Proc. EuroHaptics 2002*, Edinburgh, UK, pp. 23--29.

Wang, M. J., Huang, G. J., Yeh, W. Y. and Lee, C. L., 1996, "Manual lifting task risk evaluation using computer vision system", *Computers & Industrial Engineering*, 31(3-4), pp. 657-660.

Ware, C. and Balakrishnan, R., 1994, "Reaching for objects in VR displays: lag and frame rate", *ACM Transactions on Computer-Human Interaction*, 1(4), pp. 331-357.

Warwick, K., Gray, J. and Roberts, D., 1993, "Virtual Reality in Engineering", London: The Institution of Electrical Engineers.

Waters, T. R., Putz-Anderson, V. and Garg, A., 1993, "Revised NIOSH equation for the design and evaluation of manual lifting tasks", *Journal of Ergonomics*, 36(7), pp. 749-776.

Waters, T. R., Putz-Anderson, V. and Garg, A., 1994, "Applications Manual For the Revised NIOSH Lifting Equation", Atlanta, U.S.A.: Springfield, VA.

Wegner, K., 1998, "Surgical Navigation System and Method Using Audio Feedback", *Proceedings of ICAD'98*, Glasgow, Scotland, p. 2.

Wei, B., Silva, C., Koutsofios, E., Krishnan, S. and North, S., 2000, "Visualization Research with Large Displays", *Computer Graphics and Applications*, 20(4), pp. 50-54.

Wexelblat, A., 1993, "Virtual Reality : Applications and Explorations", London: Academic Press Limited.

Whitman, L., Jorgensen, M. J., Hathiyari, K. and Malzahn, D., 2004, "Virtual reality: its usefulness for ergonomics experiments", *Proceedings of the 2004 Winter Simulation Conference*, Washington, DC: on press.

Wickens, C. D., 1990, "Three-dimensional stereoscopic display implementation: Guidelines derived from human visual capabilities", *Stereoscopic displays and applications*, SPIE, pp. 2-10.

Wilson, J. R., 1999, "Virtual Environments applications and applied ergonomics", *Applied Ergonomics*, 30, pp. 3-9.

Winer, B. J., Brown, D. R. and Michels, K. M., 1991, *Statistical Principles in Experimental Design*, 3rd Edition ed. McGraw-Hill.

Wioka, M. W., 1995, "Lag in multi-processor virtual reality", *Presence: Teleoperators and Virtual Environments*, 4, pp. 50-63.

Witmer, B. G. and Kline, P. B., 1998, "Judging Perceived and Traversed Distance in Virtual Environments", *Presence: Teleoperators and Virtual Environments*, 7(2), p. 144-167.

Xiao, Y. and Milgram, P., 1992, "Visualisation of Large Networks in 3-D Space: Issues in Implementation and Experimental Evaluation", IBM CASCON, Toronto, ON.

Ye, G., Corso, J. J., Hager, G. D. and Okamura, A. M., 2003, "VisHap: Augmented Reality Combining Haptics and Vision", IEEE International Conference on Systems, pp. 3425-3431.

Zahariev, M. A. and MacKenzie, C. L., 2003, "Auditory, Graphical and Haptic Contact Cues for a Reach, Grasp, and Place Task in an Augmented Environment", ICMI '03, Vancouver, British Columbia, Canada: ACM.

Zee, M. d., Andersen, T. B., Hansen, L., Wong, C., Rasmussen, J. and Simonsen, E., 2003, "Simulation of lifting using the better of two worlds: Forward and inverse dynamics", IX International Symposium on Computer Simulation in Biomechanics, Sydney, Australia.

Zhang, X. and Buhr, T., 2002, "Are back and leg muscle strengths determinants of lifting motion strategy? Insight from studying the effects of simulated leg muscle weakness", International Journal of Industrial Ergonomics, 29, p. 161–169.

Zhang, Y. and Sotudeh, R., 2004, "Evaluation of auditory feedback on task performance in virtual assembly environment", The Fourth International Conference on Computer and Information Technology CIT '04, pp. 206 - 214.

Zhang, Y., Sotudeh, R. and Fernando, T., 2005, "The use of visual and auditory feedback for assembly task performance in a virtual environment", In: Press, A. ed., Proceedings of the 21st spring conference on Computer graphics, Budmerice, Slovakia, pp. 59-66.

Zhu, Z. and Zhang, Z., 1990, "Maximum acceptable repetitive lifting workload by Chinese subjects", Ergonomics, 33, p. 875 – 884.

