

This is an Open Access document downloaded from ORCA, Cardiff University's institutional repository: <https://orca.cardiff.ac.uk/id/eprint/65682/>

This is the author's version of a work that was submitted to / accepted for publication.

Citation for final published version:

Toti, Kiran S., Derudas, Marco, Pertusati, Fabrizio, Sinnaeve, Davy, Van den Broeck, Freya, Margamuljana, Lia, Martins, José C., Herdewijn, Piet, Balzarini, Jan, McGuigan, Christopher and Van Calenbergh, Serge 2014. Synthesis of an apionucleoside family and discovery of a prodrug with anti-HIV activity. *Journal of Organic Chemistry* 79 (11), pp. 5097-5112. 10.1021/jo500659e

Publishers page: <http://dx.doi.org/10.1021/jo500659e>

Please note:

Changes made as a result of publishing processes such as copy-editing, formatting and page numbers may not be reflected in this version. For the definitive version of this publication, please refer to the published source. You are advised to consult the publisher's version if you wish to cite this paper.

This version is being made available in accordance with publisher policies. See <http://orca.cf.ac.uk/policies.html> for usage policies. Copyright and moral rights for publications made available in ORCA are retained by the copyright holders.



Synthesis of an apionucleoside family and discovery of a prodrug with anti-HIV activity

Kiran S. Toti,^a Marco Derudas,^b Fabrizio Pertusati,^b Davy Sinnaeve,^c Freya Van den Broeck,^c Lia Margamuljana,^d José C. Martins,^c Piet Herdewijn,^d Jan Balzarini,^d Christopher McGuigan,^b Serge Van Calenbergh^{a,}*

^aLaboratory for Medicinal Chemistry, Faculty of Pharmaceutical Sciences, Ghent University, Harelbekestraat 72, B-9000 Ghent, Belgium.

^bCardiff School of Pharmacy and Pharmaceutical Sciences, Cardiff University, Redwood Building, King Edward VII Avenue, Cardiff CF10 3NB, UK.

^cNMR and Structure Analysis Unit, Department of Organic Chemistry, Ghent University, Krijgslaan 281 S4, B-9000 Ghent, Belgium.

^dRega Institute for Medical Research, KU Leuven, B-3000 Leuven, Belgium.

* Laboratory for Medicinal Chemistry, Faculty of Pharmaceutical Sciences, UGent, Harelbekestraat 72, B-9000 Ghent, Belgium. Phone: +32 9 264 81 24. Fax: + 32 9 264 81 46.
E-mail: serge.vancalenbergh@ugent.be

Graphical Abstract

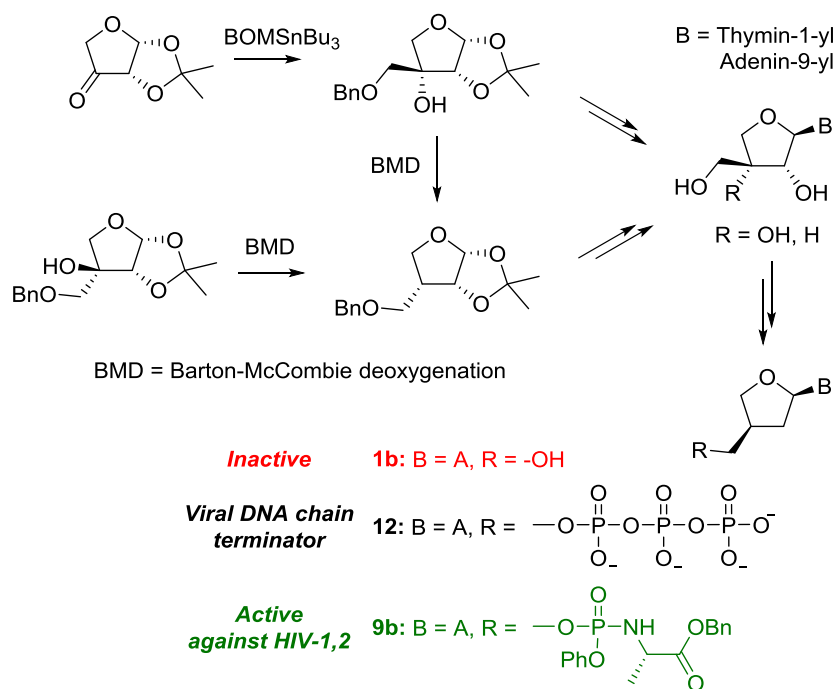

Abstract

We report the synthesis of a family of D- and L-furano-D-apionucleosides, their 3'-deoxy-, as well as their 2',3'-dideoxy-analogues with thymine and adenine nucleobases. Single carbon homologation of 1,2-O-isopropylidene-D-glycero-tetrafuranos-3-ulose (**15**) and optimized glycosylation conditions involving microwave irradiation were key to the successful synthesis of the target compounds. In the course of this work, we rectified some anomalies in the structure assignments reported by others.

While all target nucleosides failed to show significant antiviral activity, we demonstrated that the triphosphate of 2',3'-deoxy-D-apio-D-furanoadenosine (**1**), in contrast to that of its D-apio-L-furanose epimer **2**, was readily incorporated into a DNA template by HIV reverse transcriptase to act as a DNA chain terminator. This led us to convert adenine derivative **1** into two phosphoramidate prodrugs. ProTide **9b** was found active against HIV-1 and HIV-2 ($EC_{50} = 0.5\text{-}1.5 \mu\text{M}$), indicating that the lack of activity of the parent nucleoside

and possibly also other members of the D-apio-D-furanose nucleoside family must be sought in the inefficient cellular conversion to the monophosphate.

Keywords: Apionucleosides, ProTides, antivirals, RT inhibitor, microwave synthesis, nucleoside triphosphate.

Introduction

Although the pharmacological scope of nucleoside analogues is still expanding, they remain most renowned for their utility as antiviral drugs [1]. 2',3'-Dideoxy- β -D-apio-D-furanonucleosides (D-ddANs, **1**, Figure 1) were synthesized in the early 1990s as potential antiviral agents, but were found inactive [2,3,4]. However, some of us recently discovered that the 3'-*O*-phosphonomethylated adenine (A) and thymine (T) analogues **7** exhibit promising anti-HIV properties [5]. Since these phosphonates act as bioisosteres of the phosphorylated species **8**, we decided to reinvestigate the biological activity of these ddANs. We envisioned a synthetic approach that would also give access to the known apionucleosides **3** [6,7], their 3'-deoxy counterparts **2** [8,9,10,11], and inadvertently also the D-apio-L-furanose epimers **4-6**. Furthermore, we planned to expand the potential of the 2',3'-dideoxyapio nucleosides **1** and **4** as antiviral agents by synthesizing their phosphoramidate prodrugs **9**, **10** and **11**. These would ideally lead to the intracellular release of the parent nucleotides like **8** [12], thereby by-passing the often problematic first phosphorylation step in the conversion to the active triphosphate species [13].

Figure 1.

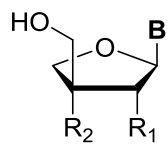

1: $R_1 = R_2 = H$

2: $R_1 = OH; R_2 = H$

3: $R_1 = R_2 = OH$

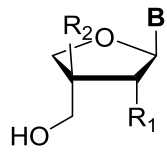

4: $R_1 = R_2 = H$

5: $R_1 = OH; R_2 = H$

6: $R_1 = R_2 = OH$

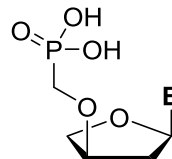

7

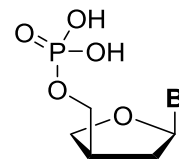

8

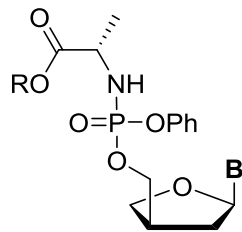

9: $R = Bn$

10: $R = iPr$

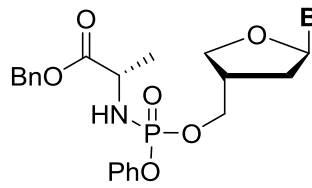

11

a: B = thymin-1-yl
b: B = adenin-9-yl

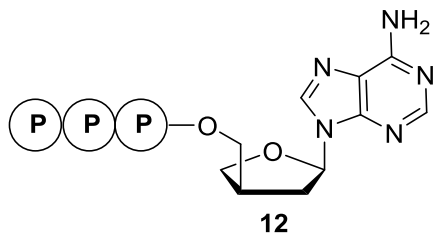

12

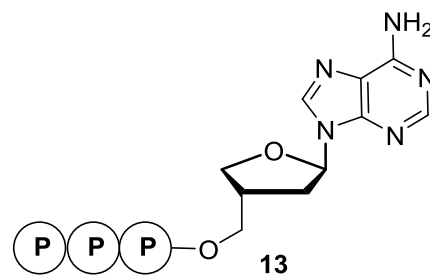

13

Results and Discussion

Chemistry

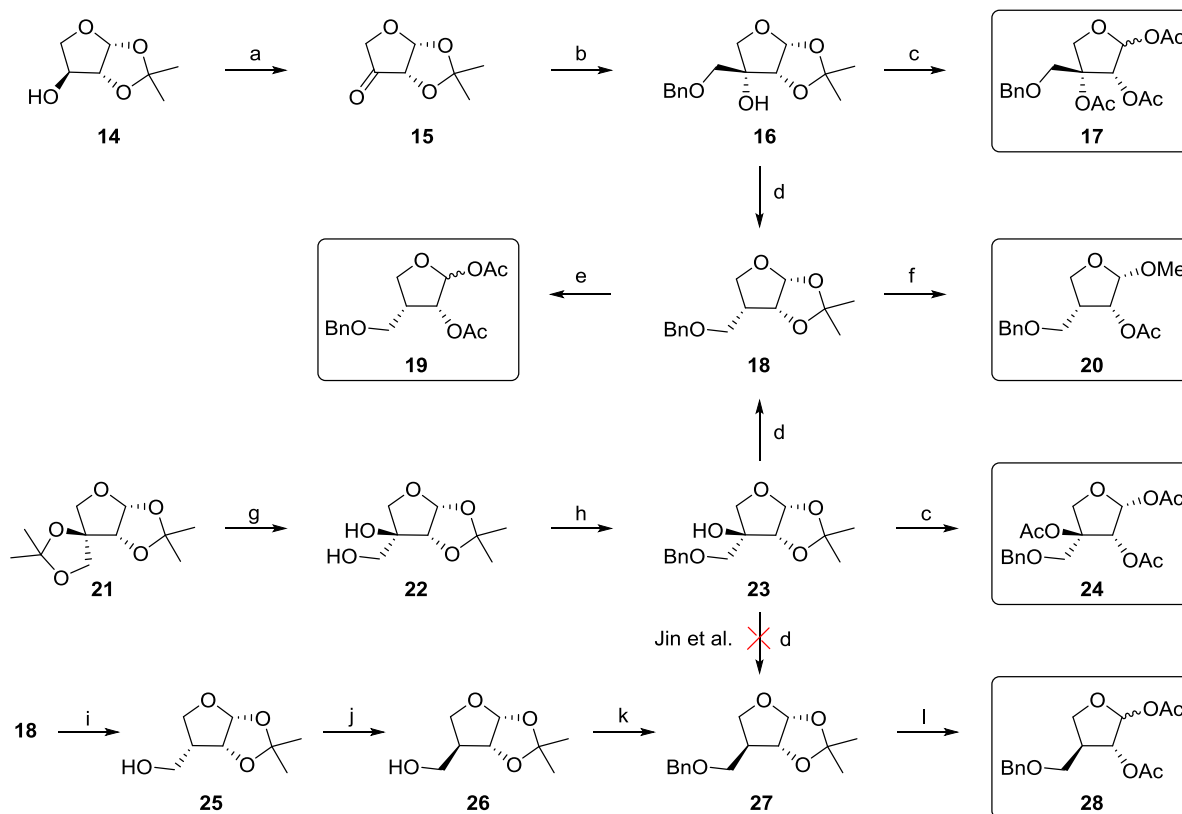

Scheme 1. Synthesis of the D- and L-furano-D-ribose coupling partners **17** and **24** and their 3'-deoxy analogues **19**, **20** and **28**. *Reagents and conditions:* (a) TEMPO, BAIB, CH₂Cl₂, rt, 3-4h, 90%; (b) BOMSnBu₃, n-BuLi, THF, -78 °C, 2h, 68%; (c) (i) 80% aq. AcOH, 80 °C, 8h; (ii) Ac₂O, DMAP, pyridine, 55 °C, 16h, 75%; (d) (i) NaH, CS₂, MeI, THF, 0 °C → rt, 1h; (ii) Et₃B, Bu₃SnH, toluene, rt, 3-4h, 68%; (e) (i) 80% aq. AcOH, 80 °C, 8h; (ii) Ac₂O, DMAP, rt, pyridine, 4h, 57%; (f) (i) *p*-TsOH (*para*-toluenesulfonic acid), MeOH, rt, overnight; (ii) Ac₂O, DMAP, pyridine, 0 °C → rt, 4h, 77%; (g) CH₃COOH-H₂O (2:1), rt, 3 days, 83%; (h) Bu₂SnO, toluene, 140 °C, 2h, TBAB, BnBr, 100 °C, 18h, 94%; (i) H₂, Pd/C, MeOH, rt, 5h, 90%; (j) acetone, conc. H₂SO₄, rt, 1.5h, Na₂CO₃, 45 min, 73% (after 3 cycles); (k) DMF, NaH, 0 °C, 10 min, BnBr, 0 °C → rt, 18h, 95%; (l) (i) 80% aq. AcOH, 80 °C, 18h; (ii) pyridine, Ac₂O, rt, 18h, 79%.

Compounds **16** and **27** were considered valuable intermediates to access the envisaged family of D-furanoapionucleosides (Scheme 1). They were prepared from 1,2-isopropylidene- α -L-threose (**14**), which was obtained in six steps from L-ascorbic acid [14,15]. Interestingly, screening of different oxidation methods [14,16,17] to convert **14** to ketone **15** indicated that TEMPO-BAIB ([Bis-(acetoxy)-iodo]benzene) oxidation, best known for oxidation of primary hydroxyl groups, was the most effective. Conversion of **15** to **16** is feasible by reacting the former with diazomethane to give a spiro-oxirane [18], which can then be opened with benzylalkoxide to give **16** [19]. To avoid the use of diazomethane, we explored several variations of the polarity reversal concept to realize the desired carbon homologation (Table 1). Reaction with benzyloxymethyl chloride in the presence of samarium iodide did not yield the desired product, while the corresponding Grignard reaction gave **16** in disappointing yields [20]. Nucleophilic attack of the ketone with lithiated benzyloxymethyltributyltin afforded **16** in acceptable yield [21], considering the propensity of compound **15** to undergo self-condensation to the aldol dimer [22]. The NMR spectra of **16** were in accordance with reported data [19] and C-3 stereochemistry was further confirmed by a two-dimensional (2D) ^1H - ^1H NOESY experiment. One-pot acid hydrolysis and acetylation of **16** gave the tri-acetylated apiose **17** in a 2:1 α/β anomeric ratio.

Table 1. Conditions for the conversion of compound **15** to **16**

Entry	Reagent	Additive	Solvent/temp	Yield
1	BOMCl	SmI ₂ (2.2 eq)	THF/0 °C	0%
2	BOM-MgCl	HgCl ₂ (0.2 eq)	THF/-78 °C	25%
3	BOM-Sn(nBu) ₃ , BuLi	none	THF/-78 °C	68%

Jin *et al.* reported the conversion of **23** to **27** using Barton-McCombie deoxygenation (BMD) [17]. Surprisingly, BMD of **16** afforded **18** instead of **27**. This led us to reinvestigate the protocol of Jin *et al.* on compound **23**, prepared from the commercially available **21** [23].

In our hands BMD on **23** also gave **18**. The stereochemistry was confirmed by 2D ^1H - ^1H NOESY experiment and by independent synthesis of compound **27**. The formation of **18** is explained by radical quenching from the least hindered face, *i.e.* opposite to the isopropylidene comprising face [24]. Furthermore, Jin *et al.* probably synthesized the enantiomer of **18**, since they started from D-galactose, which should lead to 1,2-*O*-isopropylidene- α -D-threofuranose (*i.e.*, the enantiomer of **14** [14]). Compound **23** was hydrolyzed and acetylated to give the L-furano analogue of triacetylated apiose **24**.

Compound **18** was hydrolyzed and acetylated to give **19** in a 4:1 (β : α) anomeric ratio. The anomeric configuration was inferred from the anomeric proton coupling constants, *i.e.* 0 Hz for the β -isomer and 4.4 Hz for the α -isomer. However, this conversion lacked reproducibility, especially on a larger scale. To overcome this problem, the methyl anomer **20** was synthesized in two steps from **18**. Since the coupling constant for anomeric hydrogen is close to 0 Hz, **20** is assumed to be the β -isomer.

Carey and co-workers found that 1,2-*O*-isopropylidene-L-furano-D-apiose **22** equilibrates into a mixture of the D- and L-furanose form in acidic acetone, which inspired us to use similar conditions for the epimerization of **25** [18]. We hypothesized that the absence of the 3-hydroxyl group would eliminate the repulsive dipole interaction with oxygen at position 2, while the steric interaction of the hydroxymethyl group with the 2-oxygen could result in a favorable D-furano isomer ratio. Hence compound **18** was debenzylated and then equilibrated in acetone-conc. H_2SO_4 to isolate the desired compound **26** in 73% yield after 3 equilibrium cycles. Benzylation of **26** gave **27**, which upon hydrolysis and acetylation rendered 3-deoxy-D-apio-D-furanose derivative **28** in good yields.

Having the coupling synthons **17**, **19**, **20**, **24** and **28** in hand, we set out different coupling reaction conditions for **19** and **20** with silylated thymine or *N*⁶-benzoyladenine under Vorbrüggen conditions (Table 2).

Table 2. Vorbrüggen coupling conditions.

19: R = Ac
20: R = Me
29: B = Thymin-1-yl
30: B = *N*⁶-Bz-Adenin-9-yl

Entry	sugar	silylated nucleobase	reagent	conditions	product (yield) ^a
1	19	T	TMSOTf	1,2-(CH ₂) ₂ Cl ₂ , rt, 4h	29 (quant)
2	19	<i>N</i> ⁶ -BzA	TMSOTf	1,2-(CH ₂) ₂ Cl ₂ , 40 °C, 48h	30 (32%) ^b
3	20	T	TMSOTf	1,2-(CH ₂) ₂ Cl ₂ or CH ₃ CN, rt, 4h	32 ^c
4	20	T	SnCl ₄	CH ₃ CN, rt, 4h	32 ^c
5	20	<i>N</i> ⁶ -BzA	SnCl ₄	CH ₃ CN, rt, 4h	-
6	20	T	TMSOTf ^d	CH ₃ CN, 150 °C, 5 min. microwave	29 + β-anomer (78%) ^e
7	20	<i>N</i> ⁶ -BzA	TMSOTf ^d	CH ₃ CN, 150 °C, 5 min. microwave	30 (60 %)

^a isolated yields, “-” indicates an unresolvable reaction mixture.
^b the 2'-acetyl analogue of **31** was isolated in equal amount.
^c two diastereomers observed by TLC and HRMS analysis.
^d 0.2 equivalents of TMSOTf.
^e inseparable 2:1 mixture of **29** and its β-isomer.

Whereas the acetate anomer **19** reacted smoothly at room temperature in 4h with silylated thymine in the presence of TMSOTf to quantitatively give **29**, coupling with *N*⁶-benzoyladenine only afforded the desired coupling product **30** in 32% yield by heating the reaction mixture at 40 °C for 48h [25]. This low yield resulted from the formation of an equal amount of an unknown isomer. ¹H-NMR of this isomer suffered from peak broadening and indicated the presence of minor impurities. Its UV ($\lambda_{\text{max}} = 331.9$ nm) and ¹³C-spectrum was characteristic of an *N*¹-isomer [26,27]. After treatment with methanolic ammonia for two days, a product was formed that was confidently identified as **31** (Figure 2). The binding

topology of the adenine base to the sugar was determined by NMR. A correlation between H-1' and C-2 in a 2D ^1H - ^{13}C HMBC spectrum indicates that the adenine is either bound via N-1 or N-3. In a 2D ^1H - ^1H NOESY spectrum, nOe cross-peaks were detected between the amide proton and several protons of the sugar moiety, most notably H-1', H-2' and *ortho*-protons of the benzoyl group. In addition to this, *ortho*-protons of the benzoyl moiety also showed nOe interactions with all up (α -face) protons of the furanose ring. These nOe's are improbable if the base is attached via N-3, since in this case the amide group and the sugar moiety would be positioned *para* relative to one another and be spatially too far apart.

Coupling reaction between methylglycoside **20** and silylated thymine (entries 3 and 4), using either TMSOTf or SnCl_4 , resulted in the formation of two main products that gave spots with comparable intensity on TLC. ESI-HRMS analysis allowed identifying these products as the two diastereomers of **32** [17, 28]. The condensation reaction of methylglycoside **20** with silylated benzoyladenine in the presence of anhydrous SnCl_4 gave an unresolvable reaction mixture.

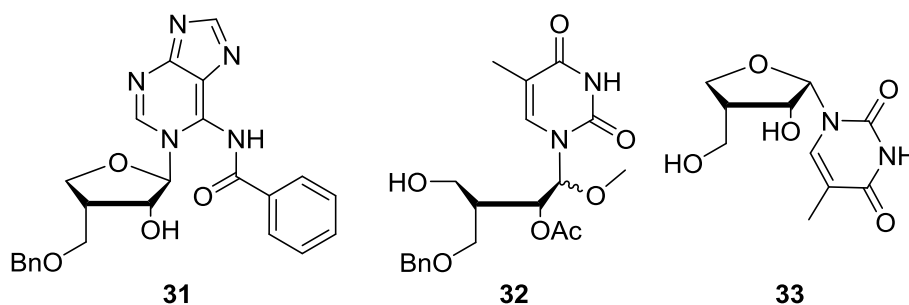
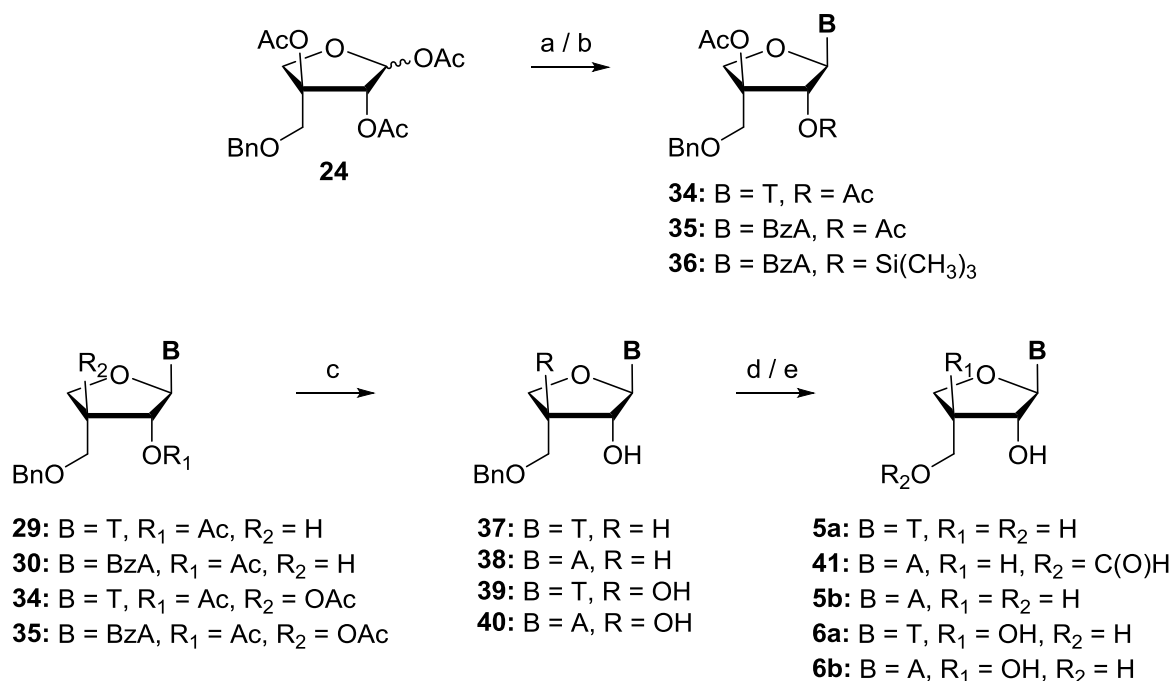

Figure 2. (Deprotected forms of) byproducts or deprotected forms of them formed during Vorbrüggen coupling

Vorbrüggen coupling of the methyl anomer **20** and silylated thymine under microwave irradiation resulted in an inseparable mixture of two isomeric products in a 2:1 ratio [29], even after removal of the acetyl and benzyl protecting groups. The ^1H -NMR spectrum of the minor isomer **33** showed a larger splitting of the anomeric hydrogen doublet (3.2 Hz) compared to the major compound (2.0 Hz), indicating a β -oriented pyrimidine moiety. The

gHMBC confirmed the C1'-N1 attachment, while 2D NOESY ratified the relative stereochemistry.

Conversely, microwave-assisted coupling between **20** and silylated *N*⁶-benzoyladenine gave only the desired α -nucleoside **30** in 60% isolated yield. Clearly, the microwave-assisted coupling with the methyl glycoside is the method of choice to prepare the adenine nucleoside.



Scheme 2. Synthesis of α -L-furano-D-apionucleosides **6a,b** and their 3'-deoxy counterparts **5a,b**.
Reagents and conditions: (a) appropriate silylated base, 1,2-(CH₂)₂Cl₂, TMSOTf, rt, 4h, 85% for **34**; (b) appropriate silylated base, CH₃CN, 0.2 eq. TMSOTf, microwave (MW) 300W, 0 °C→150 °C, 3 min, 150 °C, 5 min, 40% for **35** and 6% for **36**; (c) NH₃, MeOH, rt, 4-48h, 75-96%; (d) H₂, Pd/C, MeOH, rt, overnight, 86% for **5a** from **37** and 71% for **6a** from **39**; (e) (i) Pd(OH)₂, HCOOH-MeOH (1:1 for **5b**, **41** from **38**/1:9 for **6b** from **40**), 55 °C, 5-8h; (ii) NH₃, MeOH, rt, 3h, 80% over two steps for **5b** and **6b**.

Reaction of the triacetyl apiose **24** with silylated thymine under classical Vorbrüggen conditions provided **34** in very good yield (Scheme 2). Microwave conditions were employed to couple **24** with silylated *N*⁶-benzoyladenine, affording **35** and minor amounts of the 2'-OTMS analogue **36**. The coupling products **29**, **30**, **34** and **35** were treated with ammonia in

methanol to provide the desired deacetylated products **37-40**. Debenzylation of L-furano-D-apio thymine nucleosides **37** and **39** to give the 3'-deoxyapionucleoside **5a** and apionucleoside **6a** was realized by Pd-catalyzed hydrogenation. The same reaction condition on adenosines **38** and **40** was ineffective, as well as the use of cyclohexene and ammonium formate. This led us to use formic acid as hydrogen source to give **5b** and **6b**. The byproduct **41** was converted to **5b** upon treatment with ammonia in methanol.

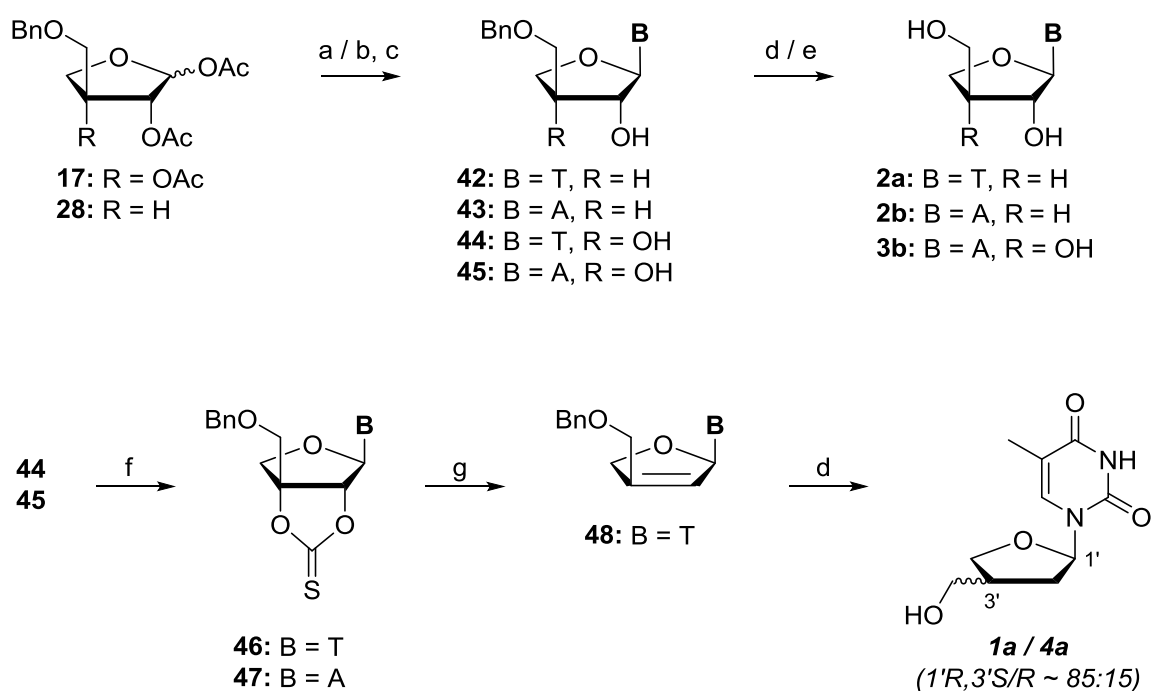

Scheme 3. Synthesis of β -D-furano-D-apionucleosides. *Reagents and conditions:* (a) silylated thymine, 1,2-(CH_2) $_2$ Cl $_2$, TMSOTf, rt, 4h; (b) silylated N^6 -BzA, CH_3CN , 0.2 eq. TMSOTf, MW 300W, 0 °C \rightarrow 150 °C, 3 min, 150 °C, 5 min; (c) 7N NH_3 -MeOH, rt, 4-48h, 46-97% over two steps, 28% for **43** and 11% of its α -anomer; (d) for **42** and **48**, H_2 , Pd/C, MeOH, rt, 4h, 86-89%; (e) (i) Pd(OH) $_2$, HCOOH-MeOH (1:4), 55 °C, 5h (ii) NH_3 , MeOH, rt, 3h, 89% for **2b** and **3b**; (f) thiocarbonyl diimidazole, DMF, 80 °C, 90 min, 89% for **46** and 78% for **47**; (g) P(OCH $_3$) $_3$, 120 °C, 6h, 90%;

Using similar protocols **17** and **28** were converted to **2a,b** and **3b** in acceptable yields (Scheme 3). Compared to the L-series, this sequence gave low yields for both thymine and adenine analogues, in particular for the 3'-deoxy analogues. Moreover, coupling of **28** with silylated benzoyladenine produced significant amount of α -isomer (11%), possibly due to

participation of the 3'-benzyloxymethyl group, with only 28% of desired β -nucleoside. Since the synthesis of **1a,b** via **28** involves many linear steps, we envisaged more convenient access to 2',3'-dideoxy- β -D-apio-D-furanonucleosides **1a,b** involving Corey-Winter olefination and stereoselective hydrogenation as key steps. During catalytic hydrogenation the *syn*-addition of the hydrogen atoms to the double bond is anticipated to occur from the face opposite to the nucleobase [30]. Thiocarbonylation of **44** and **45** using thiocarbonylimidazole provided precursor compounds **46** and **47** for Corey-Winter olefination. Unfortunately, the adenine derivative degraded in trimethylphosphite at 120 °C. The thymine derivative gave the desired product **48** in excellent yield but the hydrogenation reaction resulted in a mixture of diastereomers **1a** and **4a** that were inseparable by column chromatography. This forced us to follow the classical route *via* **2a,b** to the target 2',3'-dideoxy analogues.

Initially, the benzyl protected nucleosides **37** and **38** were subjected to a standard Barton-McCombie protocol to give the 2'-deoxygenated products **53** and **54** (Scheme 4). Different hydrogen sources were explored for the subsequent Pd-catalyzed debenzylation, but only the thymine compound **53** could be converted to the desired product **4a** with curtailed reproducibility. This was attributed to catalyst poisoning by remaining sulfur residues. Hence, we swapped to TBS as a protecting group to give **49-52** from **5a,b** and **2a,b** in excellent yields. Compounds **49-52** were submitted to BMD after conversion to the corresponding xanthates with *p*-tolylchlorothionoformate in the presence of DMAP. These xanthates were isolated after a brief workup and heated in toluene with tributyltin hydride and azobisisobutyronitrile to give the 2',3'-dideoxyapiose nucleosides **55-58**. The TBS group of **55** and **56** was removed using TBAF in THF. However, the removal of the tetrabutylammonium salt to get pure adenosine derivative **4b** was not satisfactory, hence we used NH₄F in methanol at 55 °C for 2 days to give **4a,b** and **1a,b** in excellent isolated yields [31].

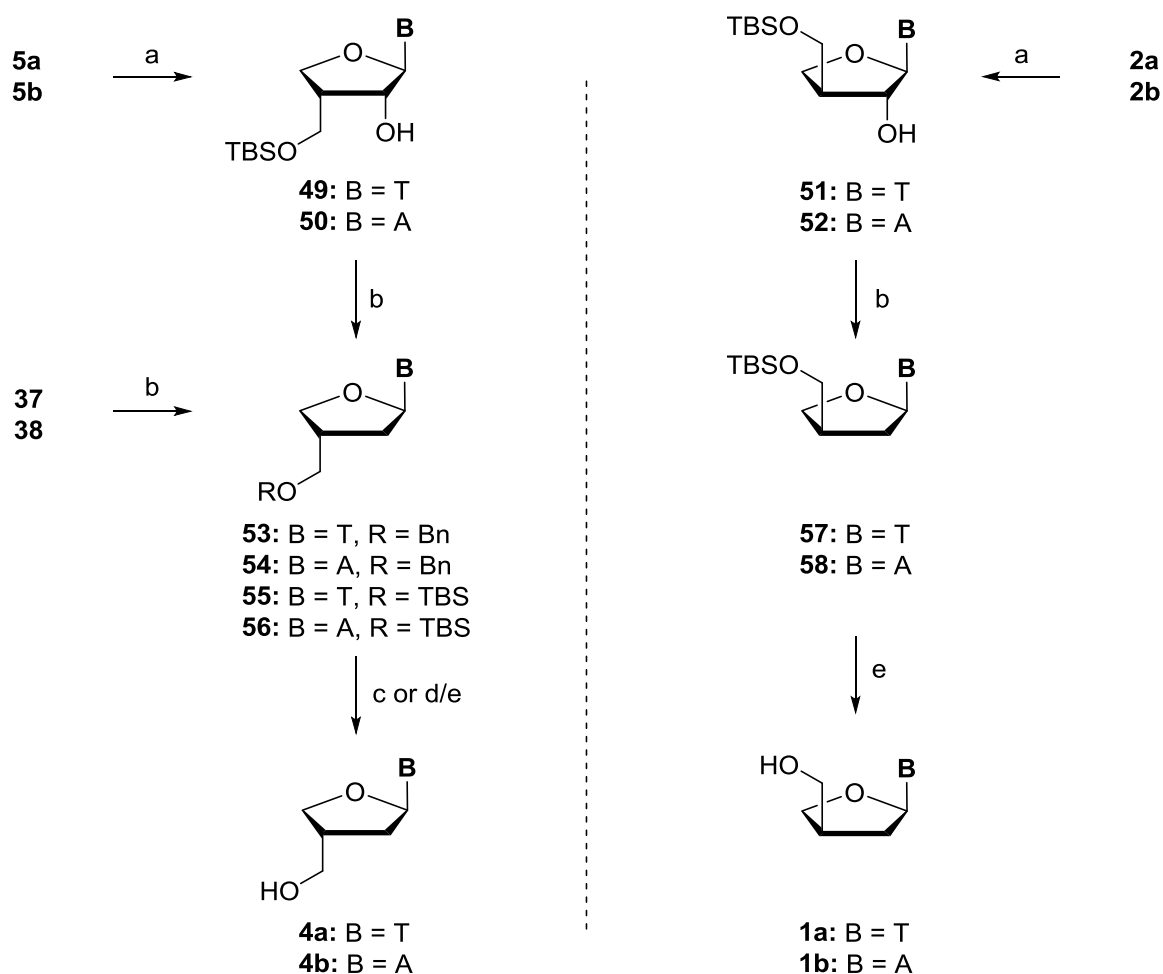

Scheme 4. Synthesis of D- and L-furano-D-dideoxydihydroapionucleosides. *Reagents and conditions:* (a) TBSCl, imidazole, DMF, rt, overnight, 82-95%; (b) (i) *p*-tolylchlorothionoformate, DMAP, ACN, 0 °C → rt, 4h; (ii) Bu₃SnH, AIBN, toluene, reflux, 2-3h, 70-90% over two steps; (c) H₂/Pd-C, methanol, rt, overnight, **53** to **4a**, 63%; (d) TBAF, THF, rt, 3h, **55** to **4a**, 89%; (e) NH₄F, MeOH, 50 °C, 2 days, 86-94%.

To examine the potential of their monophosphate prodrugs as anti-HIV agents, apio-dideoxynucleosides **1b** and **4b** were converted to the corresponding triphosphates **12** and **13**, following the method of Caton-Williams (Scheme 5) [32]. The yield of the D-isomer was low and ¹H NMR indicated internal salt formation. Likewise, the ³¹P NMR of this compound is uncharacteristic of triphosphate salts, as it showed two broad peaks (Figure 3, red). The addition of two equivalent of triethylamine (TEA) disrupted this internal salt leading to the appearance of the characteristic triphosphate peaks (Figure 3, blue).

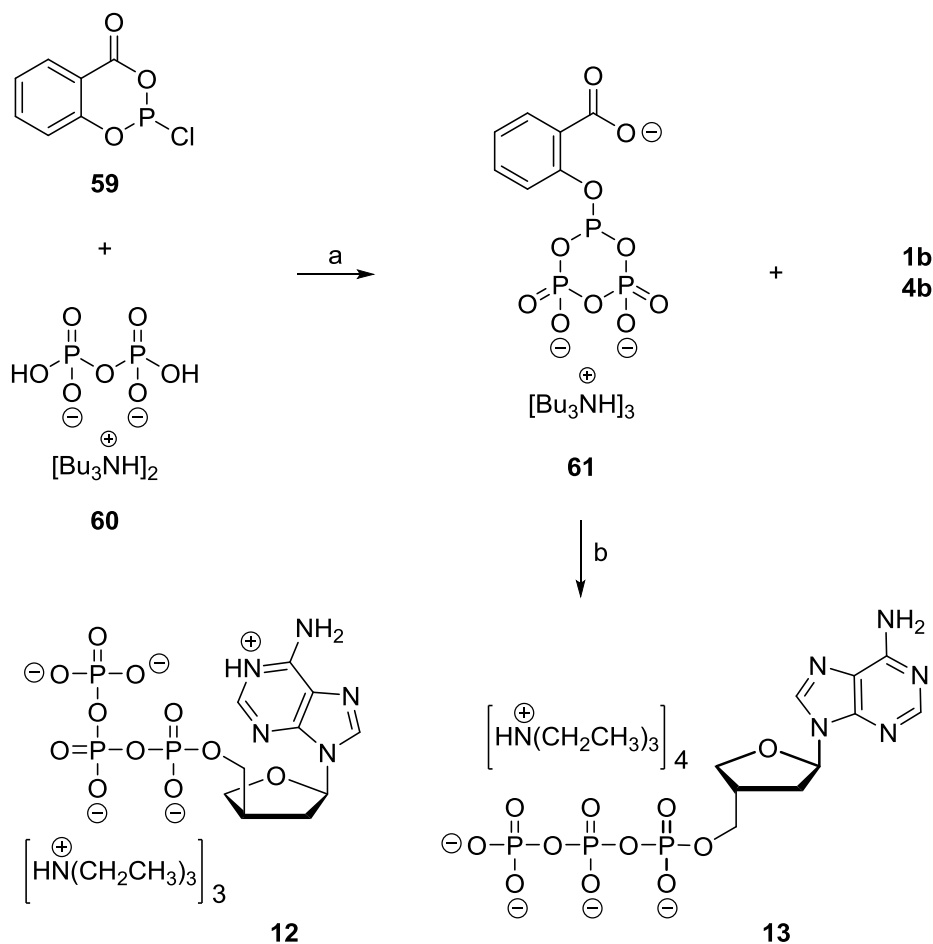

Scheme 5. Synthesis of D- and L-furano-D-dideoxyadenosine triphosphates (D-/L-ddAATP) **12** and **13**. *Reagents and conditions:* (a) **59**, **60**, n-Bu₃N, anh. DMF, rt, 1.5h; (b) (i) **1b/4b**, anh. DMF, rt, 1.5h; (ii) I₂, rt, 20 min, H₂O, rt, 1.5h, 21% for **12** and 48% for **13**.

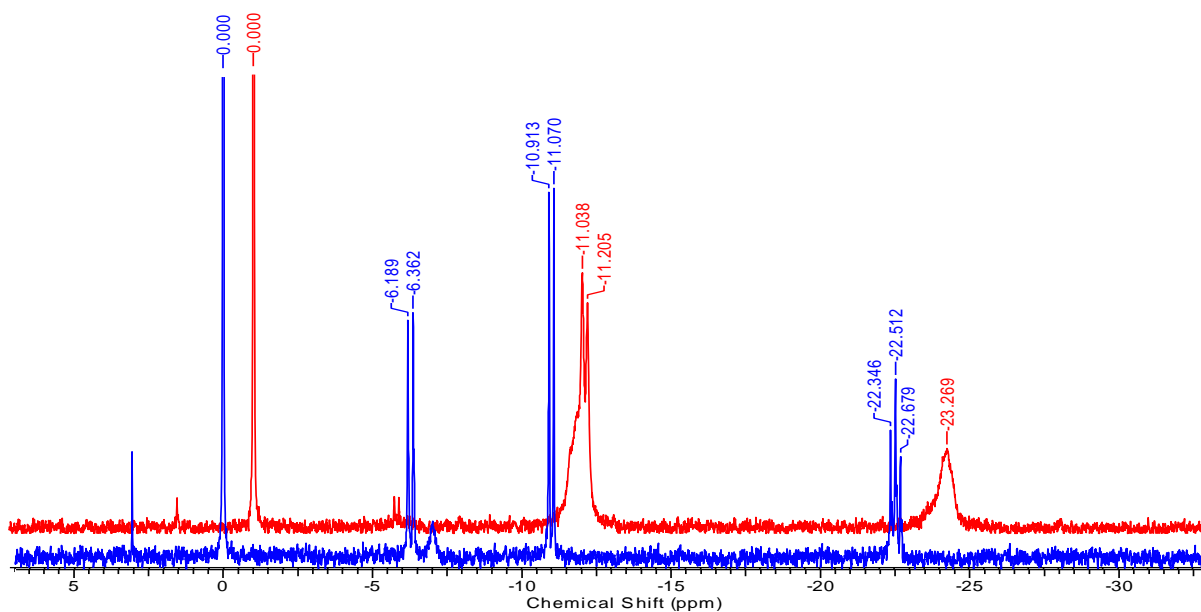
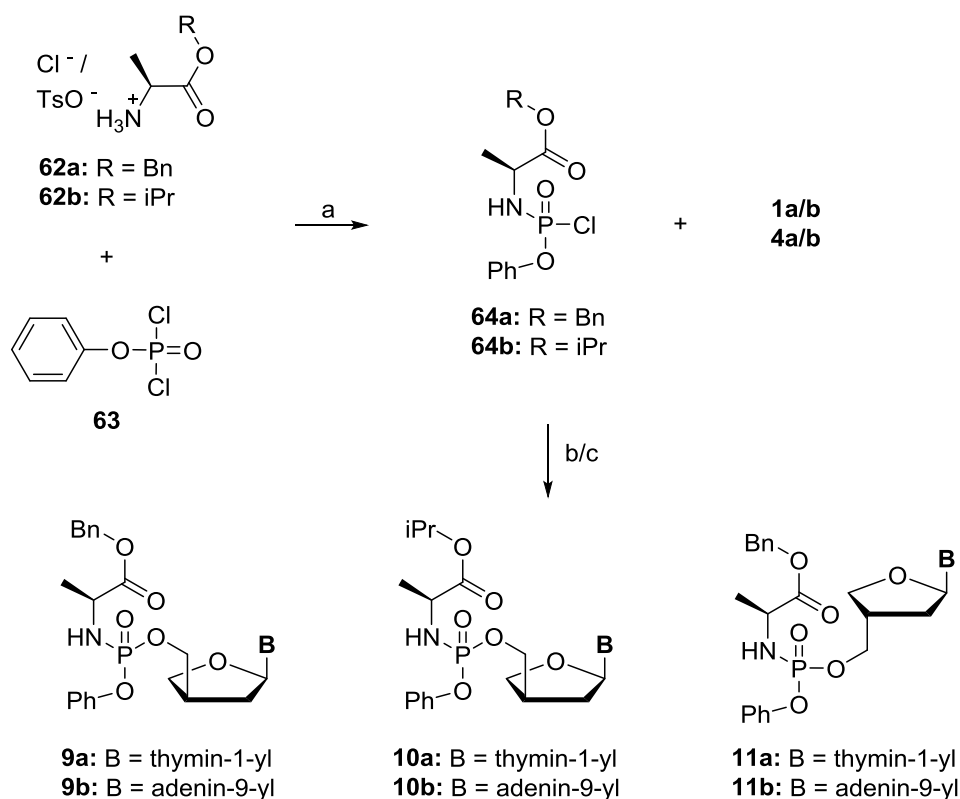

Figure 3. ^{31}P -NMR of **12** before (red) and after TEA treatment (blue).

Nucleoside monophosphate prodrugs (ProTides) were prepared using two different methods (Scheme 6). The thymine analogue **11a** was prepared by coupling **4a** with the phosphorochloridate **64a**, using *tert*-butylmagnesium chloride as hydroxyl activator. Under similar reaction conditions compound **4b** degraded. Hence, all other analogues were coupled with **64a/b** using *N*-methylimidazole (NMI) as a base in a mixture of anhydrous THF and pyridine as solvents. In all cases, the desired compounds were obtained as a mixture of two diastereoisomers resulting from the two possible configurations of the phosphorous stereo center, as confirmed by the presence of two equal height peaks in the ^{31}P -NMR spectrum.



Scheme 6. Synthesis of apionucleoside ProTides. *Reagents and conditions:* (a) CH_2Cl_2 , TEA, -78°C , 30 min, rt, 2h, 87-96%; (b) *t*-butyl magnesium chloride, THF, rt, overnight, 22% for **11a**; (c) NMI, THF, pyridine, rt, 2 days, 15-88%.

DNA Chain termination study using HIV Reverse Transcriptase

A prerequisite for ProTides to show a good biological profile is that the corresponding triphosphates are good substrates for the final target, such as reverse transcriptase (RT) for HIV. Hence we investigated the ability of triphosphates **12** and **13** to act as a substrate of HIV-RT in a primer-template assay [33]. The template has overhanging T residues to test incorporation of the modified A nucleotide. Figure 4 clearly shows that both nucleotides **12** and **13** function as DNA chain terminators. The D-furano analogue **12** is more efficiently incorporated than its 3'-epimer **13**, but compared to natural substrate 2'-deoxyadenosine triphosphate (dATP), requires a higher concentration and longer time for complete

incorporation. The characteristics of **12** towards HIV RT render the corresponding ProTides as potentially useful HIV inhibitors.

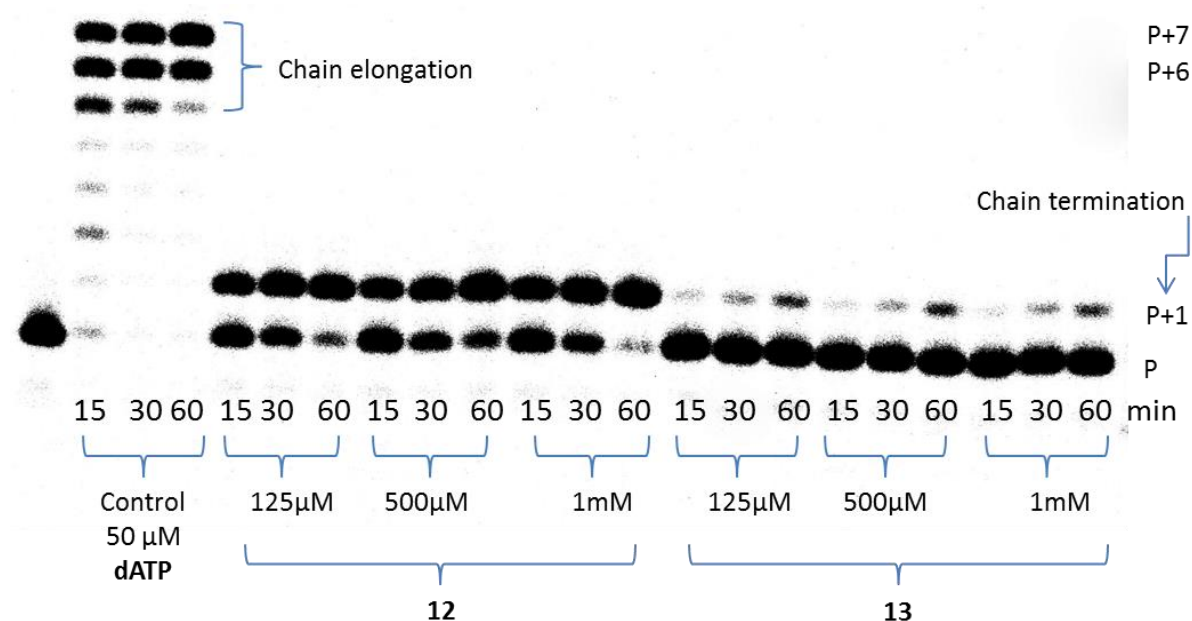

Figure 4. DNA chain termination through incorporation of dideoxydihydro-D-apio-D-furano-adenosine triphosphate (**12**) and dideoxydihydro-D-apio-L-furano-adenosine triphosphate (**13**) by HIV RT. The DNA polymeration mixtures containing 125 nM annealed (labeled) primer-template complex, were treated with 125, 500, or 1000 μM of modified triphosphate (**12/13**) and $0.03 \text{ U}\cdot\mu\text{l}^{-1}$ HIV RT and incubated at 37°C . Aliquots were taken after 15, 30 and 60 min. In the control reaction, $50 \mu\text{M}$ of natural dATP was used. Samples were separated on a 0.4 mm 20% denaturing polyacrylamide gel and the bands visualized using phosphorimaging.

Enzymatic assay using carboxypeptidase Y

The putative mechanism of activation of ProTides (Figure 5) involves an enzymatic cleavage of the ester (step **a**) mediated by an esterase- or carboxypeptidase-type enzyme followed by spontaneous cyclisation with releasing the phenolate anion (step **b**) and to open the unstable mixed anhydride ring by water (step **c**) providing the intermediate metabolite (D/L) **67a/b**. The cleavage of the phosphorous-nitrogen bond of the latter (step **d**) requires a

phosphoramidase-type enzyme, perhaps related to human HINT-1, to release the monophosphate form (D- / L- **68 a/b**).

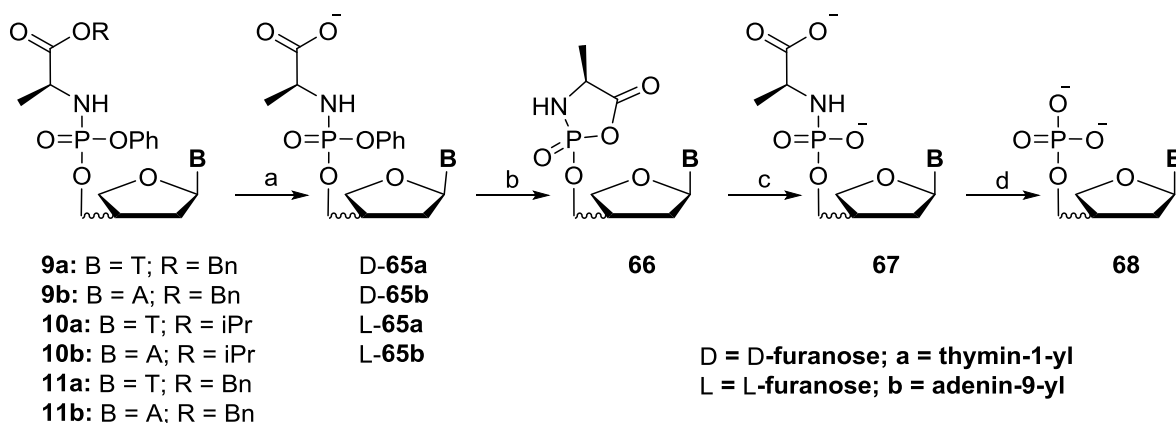

Figure 5. Putative mechanism of bioactivation for monophosphate prodrugs.

In order to investigate this mechanism of bioactivation for ProTides **9a** and **11a,b**, we performed an enzymatic experiment incubating the compounds with carboxypeptidase Y enzyme in acetone- d_6 and Trizma buffer (pH = 7.6) recording a ^{31}P -NMR at specific time intervals. Interestingly, for the L-furano series there is a pronounced difference in rate of hydrolysis among two diastereomers. For instance, one of the diastereoisomer of **11a** (^{31}P -NMR = 3.3 ppm, Figure 6, panel A) seems to be more slowly converted compared to the other. In fact, after 18h, it is still present, even after the addition of an extra portion of enzyme, while the diastereomer at 3.5 ppm appears fully converted after about 10 minutes. In contrast, compound **11b** (^{31}P -NMR = 3.2 and 3.4 ppm, Figure 6, panel B) shows a near complete conversion of both diastereoisomers to the metabolite L-**67b** (^{31}P -NMR = \sim 7.0 ppm) through the intermediate L-**65b** (^{31}P -NMR = \sim 4.5 ppm) after 1 hour, although there again exists a clear difference in kinetics.

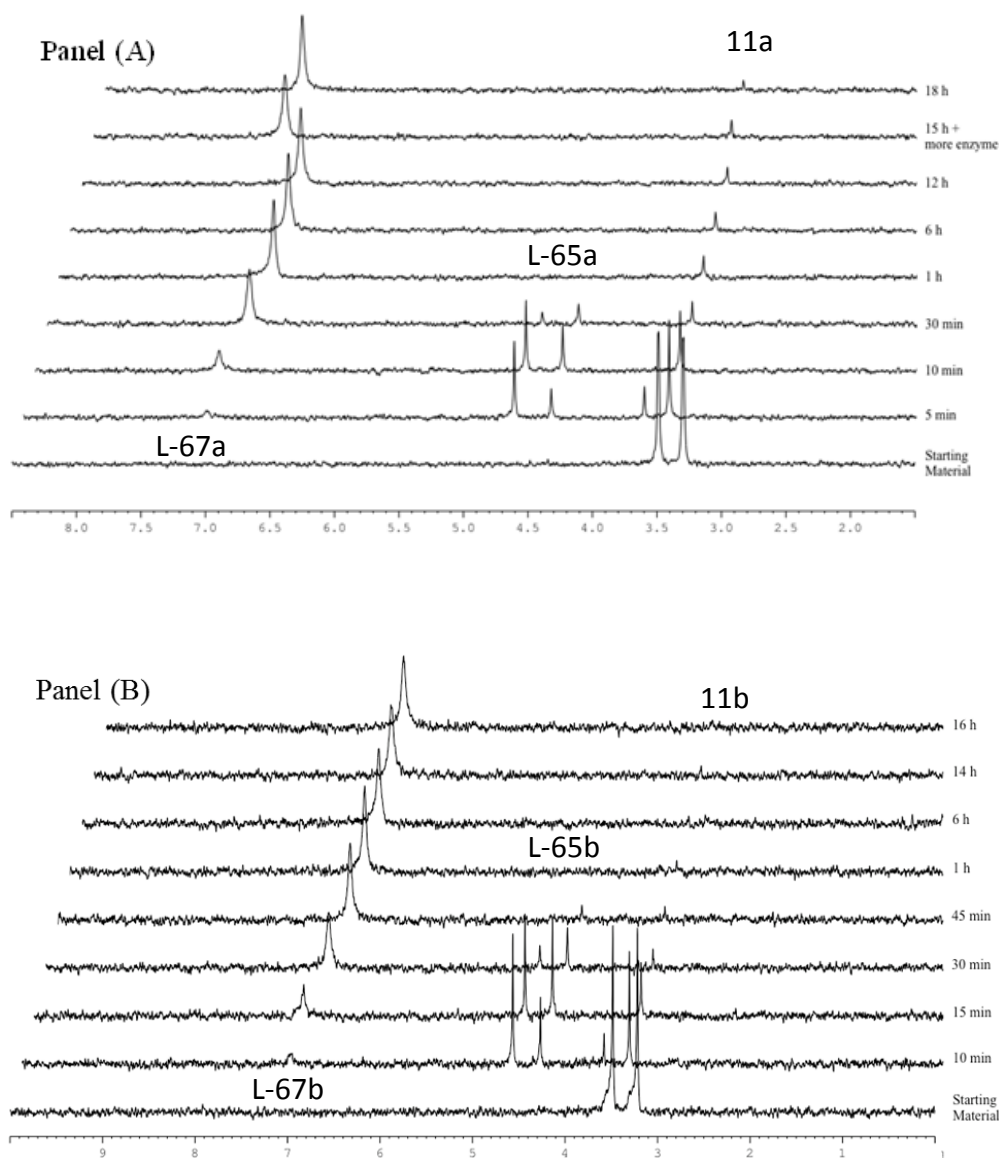

Figure 6. ^{31}P -NMR stack spectra for bioactivation study of compounds **11a** (panel A) and **11b** (panel B) using carboxypeptidase Y enzyme.

Within 20 minutes after addition of the enzyme compound **9a** (^{31}P NMR = 3.5 and 3.7 ppm) was completely converted to the intermediate metabolite D-**65a** (^{31}P -NMR = 4.5 and 4.8 ppm), which was fully converted to compound D-**67a** (^{31}P -NMR = \sim 7.1 ppm) within an hour (Figure 7). In this case no pronounced diastereomeric discrimination by carboxypeptidase

enzyme was observed. Following the trend for adenine analogue **11b**, we assume that **9b** would be processed at the least with the rate of thymine analogue **9a**.

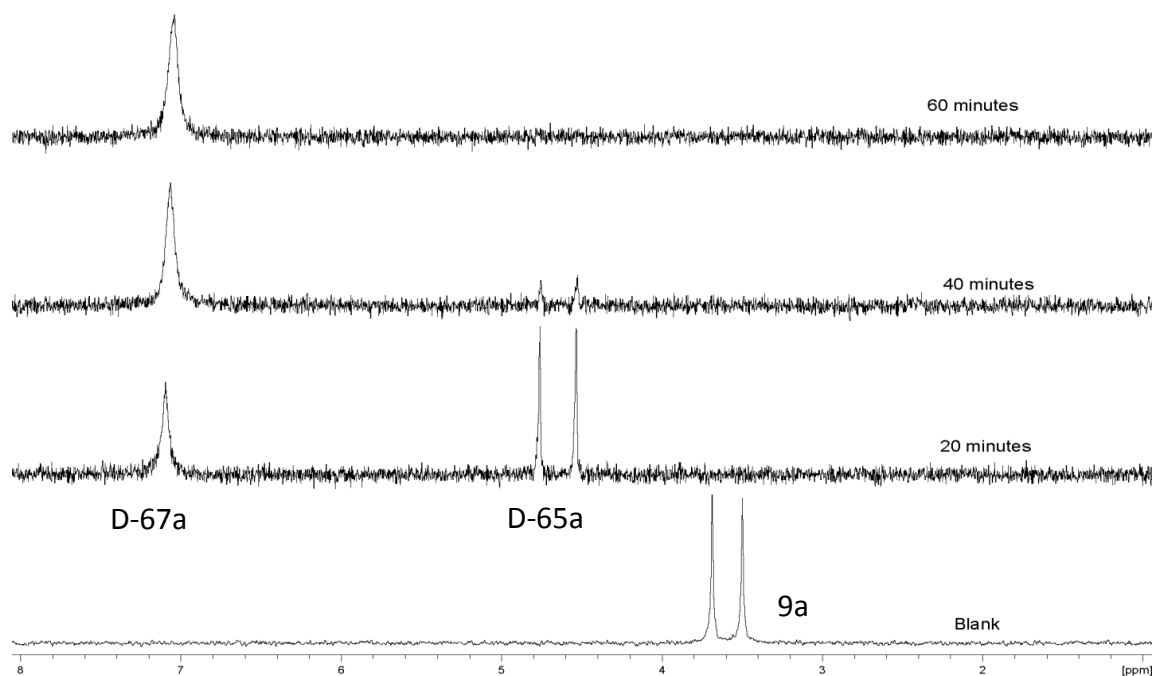

Figure 7. ³¹P-NMR stack spectra for bioactivation study of compound **9a** using carboxypeptidase Y enzyme.

From this study it is evident that both D- and L-furanonucleoside ProTides are readily converted to the intermediate metabolite **67**.

Biological Evaluation

The 2',3'-dideoxy analogues **1a,b** and the 3'-deoxy- β -D-apio-D-furanonucleosides **2a,b** failed to show activity against HIV-1,2 and cytotoxicity. Likewise, the 2',3'-dideoxy analogues **4a,b** and the 3'-deoxy- β -D-apio-L-furanonucleosides **5a,b** lacked significant activity against HIV-1 and HIV-2 and a panel of other DNA and RNA viruses, and were also devoid of cytotoxicity. The thymine-based ProTides **9a** and **10a** were also devoid of anti-HIV

activity, which might be due to inefficient conversion of the alaninyl d-ddATMP to the corresponding monophosphate by HINT-1-type phosphoramidase enzyme or further kinase mediated conversion to the corresponding triphosphate. Alternatively, the latter may be inefficiently incorporated by HIV RT (Table 3).

Interestingly, the 2',3'-dideoxy-D-apio-D-furanoadenosine phosphoramidate ProTides **9b** and **10b** combine potent and moderate anti-HIV activity with reasonable selectivity. The benzylester **9b** exhibits comparable or even somewhat superior anti-HIV activity to the acyclic nucleoside phosphonate *R*-PMPA (tenofovir). The ProTides **9a,b**, **10a,b** and **11a,b** are weak to moderate inhibitors of murine leukemia (L1210), human T-lymphocyte (CEM) and human cervix carcinoma (HeLa) cell proliferation (Table 4).

Table 3. Antiviral activity and cytotoxicity of ProTides **9a,b** and **10a,b**

	EC ₅₀ in MT-4 cells (μM)			EC ₅₀ in CEM cells (μM)	
	HIV-1 (NL4.3)	HIV-2 (ROD)	CC ₅₀	HIV-1 (IIIb)	HIV-2 (ROD)
9a	>250	>250	196	-	-
10a	>250	>250	>250	-	-
9b	0.5	1.0	93	0.5	1.5
10b	26	24	>250	7.5	38
<i>R</i> -PMPA	1.7	1.0	>250	3.0	2.5

^{c-c} = not performed

Table 4. Cytotoxicity data of ProTides **9a,b** and **10a,b**^a

	L1210	CEM	HeLa
9a	113 ± 21	108 ± 11	159 ± 32
9b	110 ± 17	80 ± 4	53 ± 11
10a	> 250	> 250	> 250
10b	226 ± 35	204 ± 3	≥ 250
11a	167 ± 85	113 ± 3	177 ± 103
11b	79 ± 4	73 ± 5	173 ± 58

^a IC₅₀ in μM, murine leukemia cells (L1210/0), human T-lymphocyte cells (CEM/0) and human cervix carcinoma cells (HeLa)

Conclusion

In this study we report the synthesis of a family of D-apionucleosides comprising the A and T members of both possible 3'-epimers of β -D-apiofuranose nucleosides, as well as their 3'-deoxy and 2',3'-dideoxy analogues. Clues in the synthesis of the desired apionucleosides were a carbon homologation of 1,2-*O*-isopropylidene-D-glycero-tetrafuranos-3-ulose (**15**) and optimized glycosylation conditions involving microwave irradiation. In the course of this work, we rectified some anomalies in the structure assignments reported by others.

In accordance with earlier reports the target D-apio-D-furanose nucleosides failed to show antiviral activity and so did their D-apio-L-furanose epimers. However, the triphosphate of 2',3'-dideoxy- β -D-apio-D-furanoadenosine (**12**) (in contrast to its D-apio-L-furanose epimer **13**) was readily accepted by viral DNA polymerase to act as a DNA chain terminator. This led us to convert the parent A and T nucleosides **1a** and **1b** into phosphoramidate prodrugs **9** and **10**. The A analogues **9b** and **10b** indeed showed a considerable anti-HIV activity. This indicates that the lack of activity of the parent 2',3'-dideoxy- β -D-apio-D-furanose nucleoside must be in the result of the inefficient conversion to the monophosphate in the biological assay. This study demonstrates that the large pool of nucleoside analogues that were previously found to lack antiviral activity may contain valuable candidates to be turned into ProTide derivatives exhibiting promising antiviral activity, by efficiently bypassing the first phosphorylation step that is often rate-limiting the intracellular conversion of nucleoside analogues to their bio-active triphosphate derivatives.

Experimental Section

Synthesis

All reagents were from standard commercial sources and of analytic grade. Dry solvents were obtained directly from commercial sources and stored on molecular sieves. All reactions were carried out under argon atmosphere using anhydrous solvents unless specified otherwise. Room temperature or rt refers to 25 ± 5 °C. Precoated Merck silica-gel F254 plates were used for TLC. The spots were examined under ultraviolet light at 254 nm and further visualized by sulphuric acid-anisaldehyde spray. Column chromatography was performed on silica gel (40-63 μm , 60 Å) or on Reveleris flash chromatography system. NMR spectra were recorded on a Varian Mercury 300 MHz or a Bruker Avance II 700 MHz spectrometer or Bruker Avance 500MHz spectrometer. Chemical shifts are given in ppm (δ), calibrated to the residual solvent signals or TMS. Exact mass measurements were performed on Waters LCT PremierXETM Time of flight (TOF) mass spectrometer equipped with a standard electrospray ionization (ESI) and modular LockSpray TM interface. Samples were infused in a $\text{CH}_3\text{CN}/\text{H}_2\text{O}$ (1:1v/v) mixture at 10 mL/min. The microwave reactions were carried out in Milestone MicroSYNTH Advanced Microwave Synthesis Labstation, equipped with 2 X 800 W magnetrons (effective maximum output 1500W pulsed/continuous), an optical fiber temperature sensor, a pressure sensor, in continuous power mode in a closed PTFE vessel. NMR signals of sugar protons and carbons are indicated with a prime, and signals of base protons and carbons are given without a prime.

3-Oxo-1,2-O-isopropylidene- α -D-erythrofurano-*s* (**15**)^[17]: To a solution of compound **14** (1.0 g, 6.24 mmol) in CH_2Cl_2 (12.5 mL) was added bis-acetoxyiodobenzene (BAIB, 2.41 g,

7.5 mmol) followed by (2,2,6,6-tetramethylpiperidin-1-yl)oxyl (TEMPO, 195 mg, 1.25 mmol) at room temperature under an argon atmosphere. The mixture was stirred at room temperature for 4h. The contents of the reaction was directly loaded on silica-gel and eluted with 30% EtOAc-hexanes to afford pure product **15** (890 mg, 90%) as a white solid. ¹H NMR (300 MHz, CDCl₃) δ ppm 1.35 (s, 3H, CH₃), 1.44 (s, 3H, CH₃), 4.03 (dd, *J* = 4.06, 17.6 Hz, 1H, 4-H), 4.29 (s, 1H, 2-H), 4.32 (dd, *J* = 0.6, 17.6 Hz, 1H, 4-H), 6.02 (d, *J* = 4.4 Hz, 1H, 1-H).

1,2-*O*-Isopropylidene-5-(*O*-benzyl)- α -D-apio-D-furanose (16**)**^[19]: To a stirring solution of benzyloxymethyltributyltin (BOMSnBu₃, 5.93 g, 14.4 mmol) in THF (35 mL) at -78 °C under inert condition, was added dropwise *n*-butyllithium (1.6M in hexanes, 19.5 mL, 31.3 mmol) and stirred for additional 1h. To this mixture was then added dropwise a solution of compound **15** (1.9 g, 12.02 mmol) in 10 mL THF and stirred at -78 °C for 3h. The reaction was quenched with saturated NH₄Cl solution and by vigorous stirring. EtOAc (100 mL) was then added to facilitate the layer separation. Organic layer was separated and the aqueous layer was extracted twice with EtOAc (50 mL). Combined organic layers were dried over anhydrous MgSO₄ and evaporated under reduced pressure. The residue was purified by column chromatography eluting with 17% EtOAc-hexanes to afford **16** (2.3 g, 68%) as a white solid. ¹H NMR (300 MHz, CDCl₃) δ ppm 1.37 (s, 3H, CH₃b), 1.58 (s, 3H, CH₃a), 2.85 (s, 1H, 3-OHa), 3.46 (d, *J* = 10.3 Hz, 1H, 5-H), 3.56 (d, *J* = 10.3 Hz, 1H, 5-H), 3.71 (d, *J* = 9.1 Hz, 1H, 4-Ha), 3.80 (d, *J* = 9.1 Hz, 1H, 4-Hb), 4.39 (d, *J* = 3.8 Hz, 1H, 2-Hb), 4.54 - 4.71 (m, 2H, CH₂Ph), 5.76 (d, *J* = 4.1 Hz, 1H, 1-Hb), 7.27 - 7.40 (m, 5H, CH₂Ph).

1,2,3-Tri-(*O*-acetyl)-5-(*O*-benzyl)- α/β -D-apio-D-furanose (17**)**^[34]: A solution of **16** (2.5 g, 8.92 mmol) in 80% aq. acetic acid (25 mL) was stirred at 80 °C for 8h. The reaction mixture was evaporated to give the crude intermediate as syrup. This syrup was dissolved in pyridine

(20 mL) and DMAP was added (100 mg) followed by acetic anhydride (10 mL, 106 mmol). The solution was stirred at 55 °C for 16h. Then, the solvent was removed under vacuum and the resulting residue was partitioned between EtOAc and water. Organic layer separated, combined organic layer was washed with brine, dried over sodium sulfate, and evaporated. The residue was purified by silica-gel column chromatography (15-20% EtOAc-hexanes) to yield **17** (2.45 g, 75%) as a colorless oil as a mixture of α + β isomers (2:1). ^1H NMR (300 MHz, CDCl_3) δ ppm 1.96 (s, 3H, major), 2.08 (s, 3H, major), 2.08 (s, 2H, minor), 2.09 (s, 1H, minor), 2.10 (s, 3H, major), 3.75 (d, $J = 9.7$ Hz, 0.47H, minor), 3.89 (d, $J=10.5$ Hz, 1H, major), 3.96 (d, $J = 9.7$ Hz, 0.5H, minor), 4.05 (d, $J = 10.5$ Hz, 1H, major), 4.22 (d, $J = 10.3$ Hz, 1H, major), 4.26 (d, $J = 10.5$ Hz, 0.52H, minor), 4.32 (d, $J = 10.5$ Hz, 0.5H, minor), 4.34 (d, $J = 10.3$ Hz, 1H, major), 4.51 - 4.62 (m, 3H, major & minor), 5.42 (d, $J = 4.7$ Hz, 0.44H, minor), 5.49 (d, $J = 1.2$ Hz, 1H, major), 6.08 (d, $J = 1.2$ Hz, 1H, major), 6.33 (d, $J = 4.7$ Hz, 0.43H, minor), 7.27 - 7.41 (m, 7H, major & minor). ESI-HRMS $[\text{M}+\text{Na}]^+$ calcd, 389.1212; found, 389.1242.

1,2-*O*-Isopropylidene-3-deoxy-5-(*O*-benzyl)- β -D-apio-L-furanose (18**)**^[17]: To a solution of **16** (3.5 g, 12.5 mmol) in dry THF (75 mL) was added NaH (60% in mineral oil, 1.5 g, 37.45 mmol) at 0 °C and the reaction mixture was stirred at room temperature for 1h. To this mixture were slowly added CS_2 (11.2 mL, 188 mmol) and MeI (24.0 mL, 375 mmol) and stirred at room temperature for 1h. The reaction mixture was evaporated to give crude xanthate. The xanthate was suspended in dry toluene (75 mL), triethylborane (19.0 mL, 19.0 mmol, 1.0 M solution in THF) and *n*- Bu_3SnH (5 mL, 19.0 mmol) were added at room temperature and the mixture was stirred for further 3h. The reaction mixture was quenched with water, extracted with EtOAc, dried over anhydrous MgSO_4 , filtered and evaporated. The residue was purified by silica gel column chromatography (10% EtOAc-hexanes) to give **18** (2.26 g, 68 %) as a colorless oil. ^1H NMR (300 MHz, CDCl_3) δ ppm 1.32 (s, 3H, CH_3a), 1.49

(s, 3H, CH₃b), 2.37 - 2.52 (m, 1H, 3-Ha), 3.52 (dd, $J = 9.2, 7.5$ Hz, 1H, 5-H), 3.69 (dd, $J = 11.3, 8.6$ Hz, 1H, 4-Hb), 3.78 (dd, $J = 9.4, 6.7$ Hz, 1H, 5-H), 4.01 (dd, $J = 8.4, 7.2$ Hz, 1H, 4-Ha), 4.46 - 4.60 (m, 2H, CH₂Ph), 4.65 (t, $J = 4.1$ Hz, 1H, 2-Ha), 5.83 (d, $J = 3.8$ Hz, 1H, 1-Ha), 7.24 - 7.42 (m, 5H, CH₂Ph).

1,2-Di-*O*-acetyl-3-deoxy-5-(*O*-benzyl)- α/β -D-apio-L-furanose (19): A solution of **18** (750 mg, 2.84 mmol) in 80% aq. acetic acid (10 mL) was stirred at 80 °C for 8h. The reaction mixture was evaporated to give the crude intermediate as a syrup. This syrup was dissolved in pyridine (15 mL) and treated with DMAP (50 mg) and acetic anhydride (2.0 mL, 21.2 mmol). The solution was stirred at room temperature for 4h. The solvent was removed under vacuum and the resulting residue was purified by silica-gel column chromatography (20% EtOAc-hexanes) to yield **19** (500 mg, 57%) as a colorless oil ($\alpha:\beta$ anomeric ratio 1:4). Major isomer ¹H NMR (300 MHz, CDCl₃) δ ppm 1.94 (s, 3H, Ac), 1.97 (s, 3H, Ac), 2.83 - 2.96 (m, 1H, 3-H), 3.40 (dd, $J = 9.1, 7.3$ Hz, 1H, 5-H), 3.55 (dd, $J = 9.1, 7.6$ Hz, 1H, 5-H), 3.77 (t, $J = 8.8$ Hz, 1H, 4-H), 4.17 (t, $J = 8.4$ Hz, 1H, 4-H), 4.35 - 4.48 (m, 2H, CH₂Ph), 5.20 (d, $J = 5.0$ Hz, 1H, 2-H), 6.02 (s, 1H, 1-H), 7.18 - 7.32 (m, 5H, CH₂Ph). ¹³C NMR (75 MHz, CDCl₃) δ ppm 20.54 (CH₃CO), 21.01 (CH₃CO), 40.11 (3-C), 66.10 (5-C), 70.93 (4-C), 73.27 (CH₂Ph), 76.07 (2-C), 99.67 (1-C), 127.57 (C_o Ph), 127.71 (C_p Ph), 128.37 (C_m Ph), 137.76 (C_{ipso} Ph), 169.36 (CH₃CO), 169.71 (CH₃CO). ESI-HRMS (M+Na)⁺ calcd: 331.1158; found: 331.1152.

1-*O*-Methyl-2-*O*-acetyl-3-deoxy-5-(*O*-benzyl)- β -D-apio-L-furanose (20)^[17]: A solution of **18** (2.26 g, 8.55 mmol) and *p*-TsOH (700 mg, 4.06 mmol) in MeOH (60 mL) was stirred at room temperature for 16h, neutralized with TEA and evaporated. The residue was partitioned between EtOAc and water, organic layer separated, dried over anhydrous MgSO₄ and evaporated. The residue was purified by column chromatography (20-40% EtOAc-hexanes). The intermediate was dissolved in pyridine (15 mL), acetic anhydride (2.4 mL, 25.2 mmol)

and DMAP (200 mg, 1.68 mmol) were added at 0 °C and the reaction mixture was stirred at room temperature for 4h. The reaction mixture was evaporated, and partitioned between EtOAc and 10% aq. KHSO₄. The organic layer was dried over anhydrous MgSO₄, filtered and evaporated. The residue was purified by silica gel column chromatography (15% EtOAc-hexanes) to give **20** (1.85 g, 77%) as a colorless oil. ¹H NMR (300 MHz, CDCl₃) δ ppm 2.00 (s, 3H, 2-OAc), 2.88-3.02 (m, 1H, 3-H), 3.34 (s, 3H, 1-OMe), 3.46 (dd, *J* = 9.1, 7.31 Hz, 1H, 5-H), 3.62 (dd, *J* = 9.2, 7.2 Hz, 1H, 5-H), 3.78 (t, *J* = 8.6 Hz, 1H, 4-H), 4.14 (t, *J* = 8.5 Hz, 1H, 4-H), 4.46 (d, *J* = 12.0 Hz, 1H, CH₂Ph), 4.52 (d, *J* = 12.0 Hz, 1H, CH₂Ph), 4.83 (s, 1H, 1-H), 5.16 (d, *J* = 5.3 Hz, 1H, 2-H), 7.27 - 7.39 (m, 5H, CH₂Ph).

1,2-*O*-Isopropylidene-β-D-apio-L-furanose (22)^[17]: Compound **21** (5.0g, 21.72 mmol) was dissolved in 50 mL of 2:1 acetic acid-water mixture and stirred at room temperature for 3 days. Solvents were evaporated in vacuo and silica gel column chromatography of the residue (50% EtOAc-hexanes) afforded the title compound **22** as a white solid (3.4 g, 83%). ¹H NMR (300 MHz, CDCl₃) δ ppm 1.33 (s, 3H, C(CH₃)₂), 1.51 (s, 3H, C(CH₃)₂), 2.12 (t, *J* = 5.9 Hz, 1H, 5-OH), 2.69 (s, 1H, 3-OH), 3.71 (dd, *J* = 6.3, 11.16 Hz, 1H, 4-H), 3.80 (d, *J* = 9.8 Hz, 1H, 5-H), 3.94 (d, *J* = 9.4 Hz, 1H, 5-H), 3.96 (dd, *J* = 5.4, 7.50 Hz, 1H, 4-H), 4.38 (d, *J* = 3.8 Hz, 1H, 2-H), 5.99 (d, *J* = 3.7 Hz, 1H, 1-H).

1,2-*O*-Isopropylidene-5-(*O*-benzyl)-β-D-apio-L-furanose (23)^[17, 19]: Compound **22** (3.1 g, 16.3 mmol) and dibutyltin oxide (6.7 g, 26.9 mmol) was dissolved in toluene (120 mL) refluxed at 140 °C for 2h. The reaction mixture was allowed to attain 100 °C then added tetrabutylammonium bromide (2.63 g, 8.15 mmol) and benzyl bromide (3.0 mL, 25.26 mmol). The reaction mixture was stirred at this temperature for 18h. Solvent was evaporated under reduced pressure and the residue purified by silica gel column chromatography (30% EtOAc-hexanes) to afford **23** (4.3 g, 94%) as a white solid. ¹H NMR (300 MHz, CDCl₃) δ

ppm 1.32 (s, 3H, C(CH₃)₂a), 1.48 (s, 3H, C(CH₃)₂b), 2.76 (d, $J = 0.9$ Hz, 1H, 3-OHa), 3.54 (d, $J = 9.7$ Hz, 1H, 5-H), 3.80 (d, $J = 9.7$ Hz, 1H, 5-H), 3.82 (dd, $J = 9.4, 0.9$ Hz, 1H, 4-Ha), 3.88 (dd, $J = 9.4$ Hz, 1H, 4-Hb), 4.35 (dd, $J = 3.5, 0.9$ Hz, 1H, 2-Ha), 4.57 (d, $J = 12.0$ Hz, 1H, PhCH₂), 4.64 (d, $J = 12.0$ Hz, 1H, PhCH₂), 5.98 (d, $J = 3.5$ Hz, 1H, 1-Ha), 7.27 - 7.42 (m, 5H, PhCH₂).

1,2,3-Tri-(*O*-acetyl)-5-(*O*-benzyl)- β -D-apio-L-furanose (24): Following the procedure described for the synthesis of **17**, (2.5g, 8.92 mmol) of **23** rendered pure product **24** (2.45 g, 75%) as an oil. ¹H NMR (300 MHz, CDCl₃) δ ppm 1.96 (s, 3H, COCH₃), 2.07 (s, 3H, COCH₃), 2.10 (s, 3H, COCH₃), 3.89 (d, $J = 10.5$ Hz, 1H, 4-H), 4.05 (d, $J = 10.3$ Hz, 1H, 4-H), 4.22 (d, $J = 10.3$ Hz, 1H, 5-H), 4.34 (d, $J = 10.3$ Hz, 1H, 5-H), 4.50 - 4.62 (m, 2H, PhCH₂), 5.49 (d, $J = 1.2$ Hz, 1H, 2-H), 6.08 (d, $J = 1.2$ Hz, 1H, 1-H), 7.26 - 7.40 (m, 5H, PhCH₂).

1,2-*O*-Isopropylidene-3-deoxy- β -D-apio-L-furanose (25)^[17]: Compound **18** (3.7 g, 14 mmol) was dissolved in methanol (100 mL), to this was added Pd-C (3.7 g, 10% Pd, wet ~50% H₂O). Stream of hydrogen gas was bubbled through the reaction mixture for 5h at room temperature. The catalyst was filtered off and the filtrate concentrated to give crude product which on purification by silica-gel column chromatography (40% EtOAc-hexanes) rendered **25** (2.2 g, 90%) as a colorless oil. ¹H NMR (300 MHz, CDCl₃) δ ppm 1.34 (d, $J = 0.6$ Hz, 3H, C(CH₃)₂), 1.53 (s, 3H, C(CH₃)₂), 2.21 (br. s, 1H, 5-OH), 2.34 (ddtd, $J = 11.4, 6.9, 5.97, 6.0, 4.8$ Hz, 1H, 3-H), 3.82 - 3.91 (m, 3H, 4-H & 5-H's), 3.97 (dd, $J = 8.5, 7.3$ Hz, 1H, 4-H), 4.73 (t, $J = 4.4$ Hz, 1H, 2-H), 5.86 (d, $J = 3.8$ Hz, 1H, 1-H).

1,2-*O*-Isopropylidene-3-deoxy- α -D-apio-D-furanose (26): To a solution of compound **25** (2.2 g, 12.63 mmol) in 400 mL of acetone was added concentrated sulfuric acid (2.2 mL) and the mixture was stirred at room temperature for 1.5h. Then sodium carbonate (14 g) was added and stirred at room temperature for 45 minutes. Inorganic salts were removed by

filtration and the filtrate concentrated under reduced pressure to afford oil. TLC indicated the conversion in favor of required isomer (roughly 2:1). The title compound is slightly polar with respect to starting material (R_f after two runs: 0.35 for **26** and 0.4 for **25**; eluent, 2.5% MeOH in CH_2Cl_2). Silica-gel flash column chromatography (0.5-1.5% MeOH in CH_2Cl_2) afforded title compound and starting material. After three cycles 1.6 g (73%) of **26** was procured as a colorless oil. ^1H NMR (300 MHz, CDCl_3) δ ppm 1.31 (d, $J = 0.6$ Hz, 3H, $\text{C}(\text{CH}_3)_b$), 1.50 (s, 3H, $\text{C}(\text{CH}_3)_a$), 1.89 (br. s, 1H, 5-OH), 2.36 - 2.46 (m, 1H, 3-H), 3.58 (dd, $J = 6.6, 3.4$ Hz, 2H, 5- CH_2), 3.83 (d, $J = 9.1$ Hz, 1H, 4-Hb), 4.10 (dd, $J = 8.9, 5.1$ Hz, 1H, 4-Ha), 4.60 (d, $J = 3.5$ Hz, 1H, 2-H), 5.81 (d, $J = 3.8$ Hz, 1H, 1-H). ^{13}C NMR (75 MHz, CDCl_3) δ ppm 26.20 ($\text{C}(\text{CH}_3)_b$), 26.81 ($\text{C}(\text{CH}_3)_a$), 48.07 (3-C), 62.00 (5-C), 68.74 (4-C), 82.28 (2-C), 105.61 (1-C), 111.25 ($\text{C}(\text{CH}_3)_2$).

1,2-O-Isopropylidene-3-deoxy-5-(O-benzyl)- α -D-apio-D-furanose (27): To an ice cold solution of **26** (1.6 g, 9.2 mmol) in DMF (30 mL) was added NaH (60% in mineral oil, 0.55g, 13.8 mmol) and then benzyl bromide (1.64 mL, 13.8 mmol) dropwise. The reaction mixture was stirred at room temperature overnight. Methanol (5 mL) was added and stirred for further 30 minutes. The volatile materials were removed under vacuo and the residue was partitioned between ethyl acetate and water. The organic layer was separated, dried over anhydrous Na_2SO_4 , evaporated and the residue purified by column chromatography (5-15% EtOAc in hexanes) to afford **27** (2.3 g, 95%) as a colorless oil. ^1H NMR (300 MHz, CDCl_3) δ ppm 1.31 (d, $J = 0.6$ Hz, 3H, $\text{C}(\text{CH}_3)_b$), 1.51 (s, 3H, $\text{C}(\text{CH}_3)_a$), 2.56 (td, $J = 7.5, 5.1$ Hz, 1H, 3-Ha), 3.37 (d, $J = 7.6$ Hz, 2H, 5- CH_2), 3.83 (d, $J = 8.8$ Hz, 1H, 4-Hb) 4.09 (dd, $J = 8.9, 5.1$ Hz, 1H, 4-Ha) 4.51 (d, $J = 3.2$ Hz, 2H, PhCH_2), 4.56 (d, $J = 3.5$ Hz, 1H, 2-Hb), 5.79 (d, $J = 3.5$ Hz, 1H, 1-Hb), 7.27 - 7.41 (m, 5H, PhCH_2). ^{13}C NMR (75 MHz, CDCl_3) δ ppm 26.30 ($\text{C}(\text{CH}_3)_b$), 26.90 ($\text{C}(\text{CH}_3)_a$), 46.07 (3-C), 68.78 (4&5-C), 73.34 (PhCH_2), 82.39 (2-C), 105.55 (1-C),

111.24 ($C(CH_3)_2$) 127.77, 127.90, 128.59, 138.06 ($PhCH_2$). ESI-HRMS for $[M+K]^+$ calcd, 303.0999; found, 303.1078.

1,2-Di-O-acetyl-3-deoxy-5-(O-benzyl)- α/β -D-apio-D-furanose (28): Following the procedure described for the synthesis of **19**, compound **27** (1.3 g, 4.92 mmol) rendered **28** (1.2 g, 79%) as a colorless oil. Mixture of $\alpha+\beta$ (2:1). 1H NMR (300 MHz, $CDCl_3$) δ ppm 2.00 (s, major, $C(CH_3)_2$) 2.04 (s, minor, $C(CH_3)_2$) 2.07 (s, minor, $C(CH_3)_2$) 2.08 (s, major, $C(CH_3)_2$), 2.56 - 2.69 (m, major, 3-H) 2.69 - 2.83 (m, minor, 3-H) 3.46 - 3.74 (m, major & minor, 5-H) 3.80 - 3.94 (m, major & minor, 4-H) 4.20 - 4.34 (m, major & minor, 4-H) 4.51 (s, minor, $PhCH_2$), 4.54 (s, major, $PhCH_2$), 5.05 (t, $J = 4.1$ Hz, minor, 2-H), 5.08 (d, $J = 2.6$ Hz, major, 2-H), 6.13 (s, major, 1-H), 6.33 (d, $J = 4.4$ Hz, minor, 1-H), 7.27 - 7.40 (m, major & minor, $PhCH_2$). ESI-HRMS for $[M+K]^+$ calcd, 347.0897; found, 347.0898.

General condition for Vorbrüggen coupling reaction: All operations were carried out under an argon protected atmosphere.

Silylation of nucleobases: The nucleobase (N^6 -Benzoyl protected in case of adenine) (2 eq.) was suspended in hexamethyldisilazane (50 eq.) containing trimethylsilyl chloride (0.7 eq.) and pyridine (10 eq.). The mixture was heated at reflux overnight. After cooling, the solvent was evaporated and dried under high vacuum.

Coupling at ambient condition (A): To the silylated nucleobase was added compound **17/19/20/24** or **28** (1 eq.) dissolved in dry 1,2-dichloroethane (7 mL/mmol), and trimethylsilyl triflate or anhydrous $SnCl_4$ (2.5 eq.) was added dropwise at room temperature. The clear solution was stirred at rt.

Coupling under microwave condition (B): To the silylated nucleobase was added compound **17/19/20/24** or **28** (1 eq.) dissolved in dry acetonitrile (7 mL/mmol), followed by

the addition of trimethylsilyl triflate (0.2 eq.) at rt. The clear solution was irradiated to microwave (continuous power-300W, preheating 0 °C→150 °C in 3 min, at 150 ± 3 °C for 5 min).

Workup procedure: The reaction mixture was quenched with saturated aqueous NaHCO₃ and extracted with ethyl acetate (3 times). The combined organic layers were dried over anhydrous Na₂SO₄ and evaporated. Purification of the residue by silica-gel flash column chromatography (MeOH-CH₂Cl₂) afforded the pure coupled product as white foam.

1'-(Thymin-1-yl)-2'-O-acetyl-3'-deoxy-5'-O-benzyl- α -D-apio-L-furanose (29): Using condition A, compound **19** (320 mg, 1.04 mmol) gave compound **29** (420 mg) in quantitative yield as a white foam. ¹H NMR (300 MHz, CDCl₃) δ ppm 1.84 (d, J = 0.9 Hz, 3H, 5-CH₃), 1.98 (s, 3H, 2'-OAc), 2.67 - 2.85 (m, 1H, 3'-H), 3.39 (dd, J = 9.1, 7.62 Hz, 1H, 5'-H), 3.57 (dd, J = 9.2, 6.00 Hz, 1H, 5'-H), 3.89 (t, J = 8.9 Hz, 1H, 4'-H), 4.36 (t, J = 8.1 Hz, 1H, 4'-H), 4.43 (s, 2H, CH₂Ph), 5.39 (dd, J = 6.2, 2.3 Hz, 1H, 2'-H), 5.74 (d, J = 2.3 Hz, 1H, 1'-H), 6.89 - 7.02 (d, J = 0.9 Hz, 1H, 6-H), 7.21 - 7.38 (m, 5H, CH₂Ph), 8.85 (br s, 1H, NH). ¹³C NMR (75 MHz, CDCl₃) δ ppm 12.57 (5-CH₃), 20.57 (2'-OCOCH₃), 41.01 (3'-C), 66.31 (5'-C), 71.87 (4'-C), 73.52 (CH₂Ph), 91.20 (1'-C), 110.99 (5-C), 127.71 (CH₂Ph), 127.86 (CH₂Ph), 128.45 (CH₂Ph), 135.13 (6-C), 137.58 (CH₂Ph), 149.97 (2-C), 163.68 (4'-C), 169.65 (2'-OCOCH₃). ESI-HRMS (M+H)⁺ calcd: 375.1556; found: 375.1556.

1'-(N⁶-Benzoyladenin-9-yl)-2'-O-acetyl-3'-deoxy-5'-O-benzyl- α -D-apio-L-furanose (30): Using condition B, compound **20** (1.0 g, 3.56 mmol) gave compound **30** (1.0 g, 60%) as a white foam. ¹H NMR (300 MHz, CDCl₃) δ ppm 2.00 (s, 3H, 2'-OAc), 3.11 - 3.25 (m, 1H, 3'-H), 3.49 (dd, J = 9.2, 7.18 Hz, 1H, 5'-H), 3.63 (dd, J = 9.4, 6.4 Hz, 1H, 5'-H), 4.00 (t, J = 8.5 Hz, 1H, 4'-H), 4.45 (s, 2H, PhCH₂), 4.50 (t, J = 8.1 Hz, 1H, 4'-H), 5.79 (dd, J = 5.9, 2.1 Hz, 1H, 2'-H), 6.04 (d, J = 2.3 Hz, 1H, 1'-H), 7.21 - 7.32 (m, 5H, CH₂Ph), 7.37 - 7.47 (m, 2H, H_m

Bz), 7.47 - 7.56 (m, 1H, H_p Bz), 7.90 - 7.97 (m, 2H, H_o Bz), 7.98 (s, 1H, 8-H), 8.72 (s, 1H, 2-H), 9.11 (s, 1H, NH). ¹³C NMR (75 MHz, CDCl₃) δ ppm 20.58 (2'-OCOCH₃), 41.01 (3'-C), 66.15 (5'-C), 72.12 (4'-C), 73.44 (CH₂Ph), 76.96 (2'-C), 90.24 (1'-C), 123.57 (5-C), 127.66 (C_o, C_p Bn), 127.82 (C_o Bz), 128.44 (C_m Bn), 128.76 (C_m Bz), 132.68 (C_p Bz), 133.58 (C_{ipso} Bz), 137.64 (C_{ipso} Bn), 141.33 (8-C), 149.54 (6-C), 151.19 (4-C), 152.79 (2-C), 164.59 (N⁶Bz-CO), 169.90 (2'-OCOCH₃). ESI-HRMS (M+H)⁺ calcd: 488.1934; found: 488.1937.

Spectral data for compound **1'-(N⁶-Benzoyladenin-1-yl)-3'-deoxy-5'-O-benzyl-α-D-apio-L-furanose (31)**: ¹H NMR (300 MHz, CDCl₃) δ ppm 2.45 - 2.61 (m, 1H, 3'-H), 3.68 (dd, *J* = 9.4, 6.4 Hz, 1H, 5'-H), 3.76 (dd, *J* = 9.5, 6.3 Hz, 1H, 5'-H), 4.22 (t, *J* = 8.8 Hz, 1H, 4'-H), 4.41 (t, *J* = 8.2 Hz, 1H, 4'-H), 4.45 - 4.52 (m, 2H, CH₂Ph), 4.62 (d, *J* = 5.0 Hz, 1H, 2'-H), 6.56 (s, 1H, 1'-H), 7.19 - 7.28 (m, 5H, CH₂Ph), 7.29 - 7.37 (m, 2H, H_m Bz), 7.39 - 7.47 (m, 1H, H_p Bz), 7.97 (s, 1H, 8-H), 8.16 - 8.22 (m, 2H, H_o Bz), 8.40 (s, 1H, 2-H), 12.45 (br s, 1H, NH). ¹³C NMR (75 MHz, CDCl₃) δ ppm 41.20 (3'-C), 65.93 (5'-C), 72.06 (4'-C), 73.56 (CH₂Ph), 77.60 (2'-C), 96.62 (1'-C), 114.65 (5-C), 127.90 (C_o Bn), 128.17 (C_p Bn), 128.48 (C_m Bz), 128.75 (C_m Bn), 129.94 (C_o Bz), 132.41 (C_p Bz), 137.51 (C_{ipso} Bz), 137.80 (C_{ipso} Bn), 141.99 (8-C), 142.16 (2-C), 148.83 (6-C), 157.95 (4-C), 175.46 (Bz CO). ESI-HRMS (M+H)⁺ calcd: 446.1828; found: 446.1839.

1'-(Thymin-1-yl)-3'-deoxy-β-D-apio-L-furanose (33): Spectral data for the compound mixture **33** (minor) + **5a**: ¹H NMR (300 MHz, DMSO-*d*₆) δ ppm 1.77 (d, *J* = 0.9 Hz, 1.06H, minor 5-CH₃), 1.80 (d, *J* = 1.2 Hz, 2.89H, 5-CH₃, major), 2.22 - 2.36 (m, 1H, 3'-H, major), 2.52-2.60 (m, 0.29H, 3'-H, minor) 3.40 - 3.52 (m, 1.43H, 5'-H, major & minor), 3.62 - 3.72 (m, 1.43H, 5'-H, major & minor), 3.73 - 3.81 (m, 1.11H, 4'-H, major), 3.81-3.87 (m, 0.31H, 4'-H, minor), 9.95-4.02 (t, *J* = 7.9 Hz, 0.39H, 4'-H, minor), 4.11-4.16 (m, 0.36H, 2'-H, minor), 4.19 (td, *J* = 5.1, 2.1 Hz, 1.05H, 2'-H, major), 4.33 (t, *J* = 7.9 Hz, 1H, 4'-H, major),

4.51 (t, $J = 5.1$ Hz, 1.34H, 5'-OH, major & minor), 5.29 (d, $J = 4.7$ Hz, 0.37H, 2'-OH, minor), 5.51 (d, $J = 5.0$ Hz, 1.02H, 2'-OH, major), 5.61 (d, $J = 2.1$ Hz, 1H, 1'-H, major), 5.88 (d, $J = 3.2$ Hz, 0.36H, 1'-H, minor), 7.30 (d, $J = 1.2$ Hz, 0.36H, 6-H, minor), 7.38 (d, $J = 1.2$ Hz, 1.02H, 6-H, major), 11.21 (s, 0.39H, NH, minor), 11.27 (s, 1.01H, major). ^{13}C NMR (75 MHz, DMSO- d_6) δ ppm 12.11 (5-CH₃, major), 12.24 (5-CH₃, minor), 43.57 (3'-C, major), 46.06 (3'-C, minor), 57.63 (5'-C, major), 57.74 (5'-C, minor), 69.31 (2'-C, minor), 69.84 (4'-C, minor), 71.16 (4'-C, major), 74.21 (2'-C, major), 87.92 (1'-C, minor), 92.24 (1'-C, major), 106.84 (5-C, minor), 108.92 (5-C, major), 135.74 (6-C, major), 137.99 (6-C, minor), 150.32 (2-C, major), 150.39 (2-C, minor), 163.93 (4-C, major), 164.07 (4-C, minor).

1'-(Thymin-1-yl)-2',3'-di(*O*-acetyl)-5'-*O*-benzyl- α -D-apio-L-furanose (34): Using condition – A, compound **24** (100 mg, 0.27 mmol) gave compound **34** (100 mg, 85%) as a colorless glass. ^1H NMR (300 MHz, CDCl₃) δ ppm 1.95 (d, $J = 1.2$ Hz, 3H, 5-CH₃), 2.04 (s, 3H, Ac), 2.08 (s, 3H, Ac), 3.88 (s, 2H, 5'-H), 4.20 (d, $J = 10.5$ Hz, 1H, 4'-H), 4.55 (s, 2H, CH₂Ph), 4.56 (d, $J = 10.5$ Hz, 1H, 4'-H), 5.63 (d, $J = 5.0$ Hz, 1H, 2'-H), 5.96 (d, $J = 5.0$ Hz, 1H, 1'-H), 7.28 (d, $J = 1.2$ Hz, 1H, 6-H), 7.30 - 7.41 (m, 5H, CH₂Ph), 8.52 (s, 1H, NH). ^{13}C NMR (75 MHz, CDCl₃) δ ppm 12.69 (5-CH₃), 20.51 (Ac-CH₃), 21.58 (Ac-CH₃), 66.68 (5'-C), 73.20 (4'-C), 73.80 (CH₂Ph), 78.06 (2'-C), 86.24 (3'-C), 88.23 (1'-C), 111.44 (5-C), 127.81 (C_o Bn), 128.04 (C_p Bn), 128.54 (C_m Bn), 135.03 (6-C), 137.27 (C_{ipso} Bn), 150.19 (2-C), 163.30 (4-C), 169.13 (Ac-CO), 169.94 (Ac-CO). ESI-HRMS (M+H)⁺ calcd: 433.1611; found: 433.1924.

1'-(*N*⁶-Benzoyladenine-9-yl)-2',3'-di(*O*-acetyl)-5'-*O*-benzyl- α -D-apio-L-furanose (35): Using condition- B, compound **24** (220 mg, 0.6 mmol) gave compound **35** (130 mg, 40%) and **36** (20 mg, 6%). ^1H NMR (300 MHz, CDCl₃) δ ppm 2.04 (s, 3H, Ac), 2.07 (s, 3H, Ac), 3.94 - 4.04 (2d, $J = 10.0$ Hz, 2H, 5'-H), 4.37 (d, $J = 10.5$ Hz, 1H, 4'-H), 4.59 (s, 2H, CH₂Ph),

4.71 (d, $J = 10.5$ Hz, 1H, 4'-H), 6.13 (d, $J = 4.4$ Hz, 1H, 2'-H), 6.17 (d, $J = 4.1$ Hz, 1H, 1'-H), 7.31 - 7.39 (m, 5H, CH₂Ph), 7.51 - 7.56 (m, 2H, H_m Bz), 7.58 - 7.62 (m, 1H, H_p Bz), 8.00 - 8.05 (m, 2H, H_o Bz) 8.23 (s, 1H, 8-H), 8.82 (s, 1H, 2-H), 9.01 (s, 1H, NH). ¹³C NMR (75 MHz, CDCl₃) δ ppm 20.48 (Ac-CH₃), 21.53 (Ac-CH₃), 66.32 (5'-C) 73.79 (CH₂Ph & 4'-C), 78.65 (2'-C), 86.43 (3'-C), 87.93 (1'-C), 123.14 (5-C), 127.81 (C_o Bn) 127.83 (C_o Bz), 128.05 (C_p Bn), 128.54 (C_m Bn), 128.85 (C_m Bz), 132.77 (C_m Bz), 133.59 (C_{ipso} Bn), 137.28 (C_{ipso} Bz), 141.05 (8-C), 149.51 (4-C), 151.79 (6-C), 152.94 (2-C), 164.47 (N⁶COPh), 168.89 (COCH₃), 169.94 (COCH₃). ESI-HRMS (M+H)⁺ calcd: 546.1989; found: 546.2000. Spectral data for compound **1'-(N⁶-Benzoyladenin-9-yl)-2'-(O-trimethylsilyl)-3'-(O-acetyl)-5'-O-benzyl-α-D-apio-L-furanose (36)**: ¹H NMR (300 MHz, CDCl₃) δ ppm 0.14 (s, 9H, 2'-OSi(CH₃)₃) 1.89 (s, 3H, 3'-Ac) 3.96 (d, $J = 10.0$ Hz, 1H, 5'-H) 4.05 (d, $J = 9.7$ Hz, 1H, 5'-H) 4.34 (d, $J = 10.5$ Hz, 1H, 4'-H) 4.49 (d, $J = 11.7$ Hz, 1H, CH₂Ph) 4.57 (d, $J = 12.0$ Hz, 1H, CH₂Ph) 4.71 (d, $J = 10.5$ Hz, 1H, 4'-H) 5.05 (d, $J = 2.6$ Hz, 1H, 2'-H) 6.04 (d, $J = 2.6$ Hz, 1H, 1'-H) 7.27 - 7.39 (m, 5H, CH₂Ph) 7.50 - 7.56 (m, 2H, H_m Bz) 7.57 - 7.62 (m, 1H, H_p Bz) 8.00 - 8.06 (m, 2H, H_o Bz) 8.15 (s, 1H, 8-H) 8.81 (s, 1H, 2-H) 9.08 (s, 1H, NH). ¹³C NMR (75 MHz, CDCl₃) δ ppm -0.12 (SiCH₃), 21.55 (Ac-CH₃), 65.96 (5'-C), 73.70 (CH₂Ph), 74.39 (4'-C), 78.99 (2'-C), 88.13 (3'-C), 91.74 (1'-C), 123.44 (5-C), 127.69 (C_p Bn), 127.85 (C_o Bz), 127.86 (C_o Bn), 128.43 (C_m Bn), 128.86 (C_m Bz), 132.77 (C_p Bz), 133.65 (C_{ipso} Bn), 137.61 (C_{ipso} Bz), 141.27 (8-C), 149.39 (4-C), 151.33 (6-C), 152.67 (2-C), 164.56 (N⁶Bz-CO), 169.97 (Ac-CO). ESI-HRMS (M+H)⁺ calcd: 576.2278; found: 576.2291.

1'-(Thymin-1-yl)-3'-deoxy-5'-O-benzyl-α-D-apio-L-furanose (37): Acetyl protected compound **29** (400 mg, 1.07 mmol) was dissolved in 7N ammonia in MeOH (15 mL). The mixture was stirred at room temperature until completion (for about 3-5h) as indicated by TLC. Solvent was evaporated and the residue was purified by flash column chromatography using 0.5-1 % MeOH-CH₂Cl₂ to afford the title compound **37** (341 mg, 96%) as a white

foam. ¹H NMR (300 MHz, CDCl₃) δ ppm 1.83 (d, *J* = 1.2 Hz, 3H, 5-CH₃), 2.27 - 2.49 (m, 1H, 3'-H), 3.57 (dd, *J* = 9.2, 7.8 Hz, 1H, 5'-H), 3.78 (dd, *J* = 9.2, 6.0 Hz, 1H, 5'-H), 4.03 (dd, *J* = 10.5, 8.5 Hz, 1H, 4'-H), 4.29 - 4.38 (m, 2H, 4'-H & 2'-H), 4.45 (s, 2H, CH₂Ph), 5.02 (br s, 1H, 2'-OH), 5.67 (s, 1H, 1'-H), 7.11 (d, *J* = 1.2 Hz, 1H, 6-H), 7.19 - 7.30 (m, 5H, CH₂Ph), 10.44 (br s, 1H, NH). ¹³C NMR (75 MHz, CDCl₃) δ ppm 12.60 (5-CH₃), 41.34 (3'-C), 66.61 (5'-C), 72.88 (4'-C), 73.55 (CH₂Ph), 75.79 (2'-C), 94.33 (1'-C), 110.49 (5-C), 127.72 (CH₂Ph), 127.74 (CH₂Ph), 128.39 (CH₂Ph), 134.67 (6-C), 137.88 (CH₂Ph), 150.61 (2-C), 164.47 (4-C). ESI-HRMS (M+H)⁺ calcd: 333.1450; found: 333.1458.

1'-(Adenin-9-yl)-3'-deoxy-5'-O-benzyl-α-D-apio-L-furanose (38): Compound **30** (1.0 g, 2.05 mmol) was dissolved in 7N ammonia in MeOH (30 mL). The mixture was stirred at room temperature for 48 h. Solvent was evaporated and the residue was purified by flash column chromatography using 2% MeOH-CH₂Cl₂ to afford the title compound **38** (650 mg, 75%) as a white foam [Procedure to remove acetamide residue if any: Suspend the product in water and then collect it by filtration]. ¹H NMR (300 MHz, DMSO-*d*₆) δ ppm 2.75 - 2.89 (m, 1H, 3'-H), 3.53 (t, *J* = 8.8 Hz, 1H, 5'-H), 3.73 (dd, *J* = 9.4, 5.9 Hz, 1H, 5'-H), 3.86 (t, *J* = 8.2 Hz, 1H, 4'-H), 4.40 (t, *J* = 7.8 Hz, 1H, 4'-H), 4.45 - 4.56 (m, 2H, Bn H), 4.63 (td, *J* = 5.3, 2.1 Hz, 1H, 2'-H), 5.76 (d, *J* = 4.7 Hz, 1H, 2'-OH), 5.90 (d, *J* = 2.3 Hz, 1H, 1'-H), 7.26 (br s, 2H, NH), 7.27 - 7.39 (m, 5H, CH₂Ph), 8.15 (s, 1H, 2-H), 8.23 (s, 1H, 8-H). ¹³C NMR (75 MHz, DMSO-*d*₆) δ ppm 41.70 (3'-C), 66.77 (5'-C), 71.09 (4'-C), 72.25 (Bn C), 74.38 (2'-C), 91.11 (1'-C), 119.16 (5-C), 127.38 (C_o Bn), 127.49 (C_p Bn), 128.21 (C_m Bn), 138.46 (C_{ipso} Bn), 138.98 (8-C), 148.80 (4-C), 152.52 (2-C), 156.00 (6-C). ESI-HRMS (M+H)⁺ calcd: 342.1566; found: 342.1565.

1'-(Thymin-1-yl)-5'-O-benzyl-α-D-apio-L-furanose (39): Following a similar procedure described for compound **37**, compound **34** (100 mg, 0.23 mmol) gave compound **39** (81 mg,

86 %) as a white foam. ^1H NMR (300 MHz, CDCl_3) δ ppm 1.81 (d, $J = 0.9$ Hz, 3H, 5- CH_3), 3.60 (d, $J = 9.7$ Hz, 1H, 4'-H), 3.85 (d, $J = 9.7$ Hz, 1H, 4'-H), 3.90 (d, $J = 1.2$ Hz, 1H, 3'-OH), 4.06 (dd, $J = 9.4, 1.5$ Hz, 1H, 5'-H), 4.17 (d, $J = 9.4$ Hz, 1H, 5'-H), 4.41 (d, $J = 3.5$ Hz, 1H, 2'-H), 4.50 - 4.69 (app-q, $J = 12.0$ Hz, 2H, CH_2Ph), 5.25 (d, $J = 3.5$ Hz, 1H, 2'-OH), 5.72 (s, 1H, 1'-H), 7.23 - 7.37 (m, 5H, CH_2Ph), 7.52 (d, $J = 1.2$ Hz, 1H, 6-H), 10.81 (br s, 1H, NH). ^{13}C NMR (75 MHz, CDCl_3) δ ppm 12.41 (5- CH_3), 69.57 (4'-C), 73.72 (CH_2Ph), 77.01 (5'-C), 79.96 (2'-C), 80.54 (3'-C), 94.36 (1'-C), 108.63 (5-C), 127.77 (C_o Bn), 127.84 (C_p Bn), 128.42 (C_m Bn), 137.55 (C_{ipso} Bn), 137.62 (6-C) 151.28 (2-C), 164.83 (4-C). ESI-HRMS ($\text{M}+\text{H}$)⁺ calcd: 349.1400; found: 349.1384.

1'-(Adenin-9-yl)-5'-O-benzyl- α -D-apio-L-furanose (40): Following a similar procedure described for compound **38**, compound **35** (120 mg, 0.22 mmol) gave compound **40** (73 mg, 93%) as a white foam. The same procedure was employed to convert **36** to **40**. ^1H NMR (300 MHz, $\text{DMSO}-d_6$) δ ppm 3.57 - 3.70 (2d, $J = 9.7$ Hz, 2H, 5'-H), 4.00 (d, $J = 8.8$ Hz, 1H, 4'-H), 4.11 (d, $J = 9.1$ Hz, 1 H4'-H), 4.39 (dd, $J = 5.3, 2.9$ Hz, 1H, 2'-H) 4.51 - 4.64 (2d, $J = 12.3$ Hz, 2H, CH_2Ph), 5.59 (s, 1H, 3'-OH), 5.90 (d, $J = 2.9$ Hz, 1H, 1'-H), 5.97 (d, $J = 5.6$ Hz, 1H, 2'-OH), 7.27 (s, 2H, NH), 7.28 - 7.43 (m, 5H, CH_2Ph) 8.15 (s, 1H, 2-H), 8.29 (s, 1H, 8-H). ^{13}C NMR (75 MHz, $\text{DMSO}-d_6$) δ ppm 71.12 (5'-C), 72.70 (CH_2Ph), 75.55 (4'-C), 79.84 (3'-C), 80.28 (2'-C), 90.68 (1'-C), 118.78 (5-C), 127.34 (C_p Bn), 127.44 (C_o Bn), 128.19 (C_m Bn), 138.50 (C_{ipso} Bn) 139.68 (8-C) 149.03 (4-C) 152.46 (2-C) 155.98 (6-C). ESI-HRMS ($\text{M}+\text{H}$)⁺ calcd: 358.1515; found: 358.1512.

1'-(Thymin-1-yl)-3'-deoxy- α -D-apio-L-furanose (5a)^[11]: Compound **37** (300 mg, 0.9 mmol) was dissolved in MeOH (10 mL), to this was added Pd-C (300 mg, 10% Pd, wet ~50%). A stream of hydrogen gas was bubbled through the reaction mixture with vigorous stirring for about 1 h and the mixture was then stirred under hydrogen atmosphere overnight

at room temperature. The catalyst was filtered off, the filtrate was concentrated and purified by silica-gel flash column chromatography eluting with 6-8% MeOH-CH₂Cl₂ to afford compound **5a** (190 mg, 86%) as a white solid. ¹H NMR (300 MHz, DMSO-*d*₆) δ ppm 1.79 (d, *J* = 1.2 Hz, 3H, 5-CH₃), 2.22 - 2.36 (m, 1H, 3'-H), 3.46 (ddd, *J* = 10.8, 7.7, 5.3 Hz, 1H, 5'-H), 3.62 - 3.71 (m, 1H, 5'-H), 3.76 (t, *J* = 8.6 Hz, 1H, 4'-H), 4.18 (td, *J* = 5.0, 2.1 Hz, 1H, 2'-H), 4.33 (t, *J* = 7.8 Hz, 1H, 4'-H), 4.51 (t, *J* = 5.1 Hz, 1H, 5'-OH), 5.51 (d, *J* = 4.7 Hz, 1H, 2'-OH), 5.61 (d, *J* = 2.1 Hz, 1H, 1'-H), 7.38 (d, *J* = 1.2 Hz, 1H, 6-H), 11.27 (br s, 1H, NH). ¹³C NMR (75 MHz, DMSO-*d*₆) δ ppm 12.09 (5-CH₃), 43.55 (3'-C), 57.61 (5'-C), 71.14 (4'-C), 74.19 (2'-C), 92.22 (1'-C), 108.90 (5-C), 135.73 (6-C), 150.30 (2-C), 163.92 (4-C). ESI-HRMS (M+H)⁺ calcd: 243.0981; found: 243.0990.

1'-(Adenin-9-yl)-3'-deoxy-α-D-apio-L-furanose (5b): Compound **38** (450 mg, 1.32 mmol) was dissolved in 1:1 v/v mixture of MeOH-formic acid (40 mL), to this was added Pd(OH)₂-C (300 mg, 10% Pd, wet ~50%) and stirred at 55 °C for 5-8h. The catalyst was filtered off and the filtrate was concentrated. The residue contained compound **5b** and **41** as a mixture. The residue was dissolved in 7N NH₃-MeOH and stirred at room temperature for 3h. The volatiles were evaporated and the residue purified by silica-gel flash column chromatography eluting with 10-12% MeOH-CH₂Cl₂ to afford compound **5b** (265 mg, 80%) as a white solid. Spectral data for **1'-(adenin-9-yl)-3'-deoxy-5'-O-formyl-α-D-apio-L-furanose (41):** ¹H NMR (300 MHz, DMSO-*d*₆) δ ppm 2.82 - 3.00 (m, 1H, 3'-H), 3.86 (t, *J* = 8.2 Hz, 1H, 4'-H), 4.21 (dd, *J* = 11.0, 7.8 Hz, 1H, 5'-H), 4.32 - 4.46 (m, 2H, 4' & 5'-H's), 4.70 (br s, 1H, 2'-H), 5.93 (d, *J* = 2.1 Hz, 1H, 1'-H), 7.28 (s, 2H, NH), 8.15 (s, 1H, 2-H), 8.24 (s, 1H, 5'-OCOH), 8.25 (s, 1H, 8-H). ¹³C NMR (75 MHz, DMSO-*d*₆) δ ppm 41.34 (3'-C), 61.27 (5'-C), 71.06 (4'-C), 74.73 (2'-C), 91.80 (1'-C), 119.73 (5-C), 139.85 (8-C), 149.44 (4-C), 153.29 (2-C), 156.51 (6-C), 162.81 (5'-OCOH). ESI-HRMS (M+H)⁺ calcd: 280.1046; found: 280.1046. Spectral data for **1-(adenin-9-yl)-3-deoxy-α-D-apio-L-furanose (5b):** ¹H NMR (300 MHz,

DMSO-*d*₆) δ ppm 2.53 - 2.66 (m, 1H, 3'-H), 3.52 (t, $J = 8.8$ Hz, 1H, 5'-H), 3.67 - 3.77 (m, 1H, 5'-H), 3.86 (t, $J = 8.2$ Hz, 1H, 4'-H), 4.35 (t, $J = 7.8$ Hz, 1H, 4'-H), 4.54 (br s, 1H, 5'-OH), 4.63 (br s, 1H, 2'-H), 5.64 (d, $J = 4.7$ Hz, 1H, 2'-OH), 5.89 (d, $J = 2.3$ Hz, 1H, 1'-H), 7.25 (br s, 2H, NH₂), 8.15 (s, 1H, 2-H), 8.22 (s, 1H, 8-H). ¹³C NMR (75 MHz, DMSO-*d*₆) δ ppm 44.10 (3'-C), 57.64 (5'-C), 70.84 (4'-C), 74.39 (2'-C), 91.11 (1'-C), 119.19 (5-C), 138.93 (8-C), 148.80 (4-C), 152.51 (2-C), 156.00 (6-C). ESI-HRMS (M+H)⁺ calcd: 252.1097; found: 252.1090.

1'-(Thymin-1-yl)- α -D-apio-L-furanose (6a): Following a similar procedure described for compound **5a**, compound **39** (210 mg, 0.60 mmol) gave compound **6a** (110 mg, 71%) as a white foam. ¹H NMR (300 MHz, DMSO-*d*₆) δ ppm 1.77 (d, $J = 1.2$ Hz, 3H, 5-CH₃), 3.54 (s, 2H, 5'-H), 3.88 (d, $J = 9.1$ Hz, 1H, 4'-H), 3.93 (br s, 1H, 2'-H), 3.98 (d, $J = 9.1$ Hz, 1 H), 4.57 (br s, 1H, 3'-OH), 5.04 (s, 1H, 5'-OH), 5.67 (d, $J = 2.6$ Hz, 1H, 1'-H), 5.72 (d, $J = 4.7$ Hz, 1H, 2'-OH), 7.62 (d, $J = 1.2$ Hz, 1H, 6-H), 11.25 (br s, 1H, NH). ¹³C NMR (75 MHz, DMSO-*d*₆) δ ppm 12.98 (5-CH₃), 62.95 (5'-C), 76.52 (4'-C), 80.51 (2'-C), 81.00 (3'-C), 92.95 (1'-C), 108.70 (5-C), 137.90 (6-C), 151.19 (2-C), 164.62 (4-C). ESI-HRMS (M+H)⁺ calcd: 259.0930; found: 259.0927.

1'-(Adenin-9-yl)- α -D-apio-L-furanose (6b)^[35]: Compound **40** (20 mg, 0.056 mmol) was dissolved in 9:1 v/v mixture MeOH-formic acid (2 mL), to this was added Pd(OH)₂-C (20 mg, 10% Pd, wet ~50%) and stirred at 55 °C for 5-8h. The catalyst was filtered off, the filtrate was concentrated and the residue was purified by silica-gel flash column chromatography eluting with 10-14% MeOH-CH₂Cl₂ to afford compound **6b** (12 mg, 80%) as a white solid. ¹H NMR (300 MHz, DMSO-*d*₆) δ ppm 3.62 (d, $J = 5.6$ Hz, 2H, 5'-H), 3.98 (d, $J = 9.1$ Hz, 1H, 4'-H), 4.04 (d, $J = 9.1$ Hz, 1H, 4'-H), 4.38 (br s, 1H, 2'-H), 4.64 (t, $J = 5.7$ Hz, 1H, 5'-OH), 5.36 (s, 1H, 3'-OH), 5.85 (d, $J = 4.7$ Hz, 1H, 2'-OH), 5.90 (d, $J = 2.9$ Hz,

1H, 1'-H), 7.26 (s, 2H, NH), 8.15 (s, 1H, 2-H), 8.31 (s, 1H, 8-H). ¹³C NMR (75 MHz, DMSO-*d*₆) δ ppm 62.04 (5'-C), 75.32 (4'-C), 80.13 (2'-C), 80.33 (3'-C), 90.60 (1'-C), 118.70 (5-C), 139.64 (8-C), 148.95 (4-C), 152.34 (2-C), 155.88 (6-C). ESI-HRMS (M+H)⁺ calcd: 268.1046; found: 268.1036.

1'-(Thymin-1-yl)-3'-deoxy-5'-O-benzyl-β-D-apio-D-furanose (42): Using Vorbrüggen coupling condition-A and then following procedure described for **37**, compound **28** (550 mg, 1.78 mmol) gave **42** (360 mg, 60%) as a white foam. ¹H NMR (300 MHz, CDCl₃) δ ppm 1.84 (d, *J* = 0.7 Hz, 3H, 5-CH₃), 2.68 (ddt, *J* = 12.7, 7.7, 6.4 Hz, 1H, 3'-H), 3.51 (dd, *J* = 9.5, 6.6 Hz, 1H, 5'-H), 3.59 (dd, *J* = 9.5, 5.0 Hz, 1H, 5'-H), 4.01 (dd, *J* = 8.8, 7.9 Hz, 1H, 4'-H), 4.22 (dd, *J* = 6.2, 3.9 Hz, 1H, 2'-H), 4.32 (dd, *J* = 8.8, 7.8 Hz, 1H, 4'-H), 4.50 (s, 2H, PhCH₂), 5.60 (d, *J* = 3.8 Hz, 1H, 1'-H), 7.24 (d, *J* = 1.3 Hz, 1H, 6-H), 7.26 - 7.38 (m, 5H, PhCH₂), 9.77 (s, 1H, NH). ¹³C NMR (75 MHz, CDCl₃) δ ppm 12.53 (5-CH₃), 46.38 (3'-C), 68.58 (5'-C), 71.44 (4'-C), 73.31 (PhCH₂), 79.23 (2'-C), 94.34 (1'-C), 110.43 (5-C), 127.66, 127.88, 128.48 (PhCH₂) 134.98 (6-C) 137.78 (PhCH₂), 151.58 (2-C), 164.11 (4-C). ESI-HRMS for [M+H]⁺ calcd, 333.1445; found, 333.1452.

1'-(Adenin-9-yl)-3'-deoxy-5'-O-benzyl-β-D-apio-D-furanose (43): Using Vorbrüggen coupling condition-B and then following procedure described for **38**, compound **28** (1.55 g, 5 mmol) gave **43** (480 mg, 28%) and its α-anomer (200 mg, 11%) as a white solid. ¹H NMR (300 MHz, DMSO-*d*₆) δ ppm 2.60 (quind, *J* = 8.1, 5.0 Hz, 1H, 3'-H), 3.61 (t, *J* = 8.5 Hz, 1H, 5'-H), 3.70 (dd, *J* = 9.7, 5.0 Hz, 1H, 5'-H), 4.05 (t, *J* = 8.8 Hz, 1H, 4'-Hb), 4.17 (t, *J* = 8.2 Hz, 1H, 4'-Ha), 4.51 (s, 2H, PhCH₂), 4.70 (dt, *J* = 7.6, 5.7 Hz, 1H, 2'-H), 5.69 (d, *J* = 5.9 Hz, 1H, 2'-OH), 5.79 (d, *J* = 5.6 Hz, 1H, 1'-H), 7.26 (s, 2H, NH₂), 7.29 - 7.40 (m, 5H, PhCH₂), 8.13 (s, 1H, 2-H), 8.31 (s, 1H, 8-H). ¹³C NMR (75 MHz, DMSO-*d*₆) δ ppm 46.65 (3'-C), 69.19 (5'-C), 70.45 (4'-C), 72.16 (PhCH₂), 75.12 (2'-C), 89.96 (1'-C), 119.23 (5-C), 127.44, 127.46,

128.27, 138.34 (*PhCH*₂), 139.79 (8-C), 149.42 (4-C), 152.57 (2-C), 156.05 (6-C). ESI-HRMS for [M+H]⁺ calcd, 342.1566; found, 342.1553. Spectral data for **1'-(Adenin-9-yl)-3'-deoxy-5'-O-benzyl- α -D-apio-D-furanose**. ¹H NMR (300 MHz, DMSO-*d*₆) δ ppm 2.69 - 2.83 (m, 1H, 3'-H), 3.55 (dd, *J* = 9.5, 7.2 Hz, 1H, 5'-H), 3.66 (dd, *J* = 9.5, 5.1 Hz, 1H, 5'-H), 3.73 (dd, *J* = 8.5, 7.0 Hz, 1H, 4'-H_b), 4.29 (q, *J* = 5.6 Hz, 1H, 2'-H), 4.36 (t, *J* = 8.2 Hz, 1H, 4'-H_a), 4.54 (s, 2H, *PhCH*₂), 5.53 (d, *J* = 5.3 Hz, 1H, 2'-OH), 6.19 (d, *J* = 5.3 Hz, 1H, 1'-H), 7.22 (s, 2H, NH₂), 7.26 - 7.43 (m, 5H, *PhCH*₂), 8.14 (s, 1H, 2-H), 8.16 (s, 1H, 8-H). ¹³C NMR (75 MHz, DMSO-*d*₆) δ ppm 45.32 (3'-C), 69.17 (4'-C), 69.42 (5'-C), 71.98 (2'-C) 72.22 (*PhCH*₂), 84.36 (1'-C), 118.23 (5-C), 127.48, 127.54, 128.30, 138.33 (*PhCH*₂), 140.21 (8-C), 149.55 (4-C), 152.35 (2-C), 155.84 (6-C).

1'-(Thymin-1-yl)-5'-O-benzyl- β -D-apio-D-furanose (44): Using Vorbrüggen coupling condition-A and then following procedure described for **37**, compound **17** (500 mg, 1.36 mmol) rendered **44** (460 mg, 97%) as a white foam. ¹H NMR (300 MHz, CDCl₃) δ ppm 1.89 (d, *J* = 1.2 Hz, 3H, 5-CH₃), 3.49 (d, *J* = 0.9 Hz, 1H, 3'-OH), 3.52 (s, 2H, 5'-H), 4.07 (d, *J* = 9.7 Hz, 1H, 4'-H_b), 4.24 (dd, *J* = 10.0, 0.9 Hz, 1H, 4'-H_a), 4.27 (dd, *J* = 5.6, 3.8 Hz, 1H, 2'-H), 4.38 (d, *J* = 4.1 Hz, 1H, 2'-OH), 4.56 (s, 2H, *PhCH*₂), 5.71 (d, *J* = 5.9 Hz, 1H, 1'-H), 7.22 (d, *J* = 1.2 Hz, 1H, 6-H), 7.27 - 7.40 (m, 5H, *PhCH*₂), 9.18 (s, 1H, NH). ¹³C NMR (75 MHz, CDCl₃) δ ppm 12.51 (5-CH₃), 70.96 (5'-C), 73.69 (*PhCH*₂), 75.67 (4'-C), 76.91 (2'-C), 78.06 (3'-C), 92.38 (1'-C), 111.02 (5-C), 127.77, 128.04, 128.55, 137.41 (*PhCH*₂), 135.54 (6-C), 151.47 (2-C), 163.74 (4-C). ESI-HRMS [M+H]⁺ calcd, 349.1400; found, 349.1414.

1'-(Adenin-9-yl)-5'-O-benzyl- β -D-apio-D-furanose (45): Using Vorbrüggen coupling condition-B and then following procedure described for **38**, compound **17** (2.7 g, 7.37 mmol) rendered **45** (1.2 g, 46%) as a white foam. ¹H NMR (300 MHz, DMSO-*d*₆) δ ppm 3.53 (q, *J* = 10.0 Hz, 2H, 5'-H), 3.83 (d, *J* = 9.1 Hz, 1H, 4'-H), 4.36 (d, *J* = 10.0 Hz, 1H, 4'-H), 4.58 (s,

2H, PhCH₂), 4.89 (t, $J = 7.2$ Hz, 1H, 2'-H), 5.08 (s, 1H, 3'-OH), 5.53 (d, $J = 6.7$ Hz, 1H, 2'-OH), 5.88 (d, $J = 7.6$ Hz, 1H, 1'-H), 7.19 - 7.29 (br.s, 2H, NH₂), 7.29 - 7.45 (m, 5H, PhCH₂), 8.14 (s, 1H, 2-H), 8.34 (s, 1H, 8-H). ¹³C NMR (75 MHz, DMSO-*d*₆) δ ppm 71.28 (5'-C), 72.57 (PhCH₂), 73.78 (2'-C), 74.83 (4'-C), 77.45 (3'-C), 87.78 (1'-C), 119.40 (5-C), 127.29, 127.38, 128.24, 138.40 (PhCH₂), 140.25 (8-C), 149.64 (4-C), 152.56 (2-C), 156.06 (6-C). ESI-HRMS [M+H]⁺ calcd, 358.1515; found, 358.1516.

1'-(Thymin-1-yl)-3'-deoxy- β -D-apio-D-furanose (2a)^[11]: Following the procedure described for the synthesis of **5a**, compound **42** (350 mg, 1.05 mmol) gave **2a** (220 mg, 86%) as a white solid. ¹H NMR (300 MHz, CD₃OD) δ ppm 1.89 (d, $J = 1.2$ Hz, 3H, 5-CH₃) 2.39 - 2.55 (m, 1H, 3'-H), 3.65 (dd, $J = 10.8, 6.7$ Hz, 1H, 5'-H), 3.73 (dd, $J = 11.0, 4.8$ Hz, 1H, 5'-H), 4.02 - 4.10 (t, $J = 8.2$ Hz, 1H, 4'-H), 4.17 - 4.26 (m, 2H, 2' & 4'-H's), 5.72 (d, $J = 5.6$ Hz, 1H, 1'-H), 7.46 (d, $J = 1.2$ Hz, 1H, 6-H). ¹³C NMR (75 MHz, CD₃OD) δ ppm 11.16 (5-CH₃), 48.29 (3'-C), 60.46 (5'-C), 70.25 (4'-C), 75.70 (2'-C), 92.29 (1'-C), 110.42 (5-C), 137.14 (6-C), 151.56 (2-C), 165.23 (4-C). ESI-HRMS for [M+H]⁺ calcd, 243.0981; found, 243.0975.

1'-(Adenin-9-yl)-3'-deoxy- β -D-apio-D-furanose (2b)^[8]: Following the procedure described for the synthesis of **5b**, compound **43** (600 mg, 1.76 mmol) gave **2b** (390 mg, 88%) as a white solid. ¹H NMR (300 MHz, DMSO-*d*₆) δ ppm 2.34 - 2.48 (m, 1H, 3'-H), 3.56 (dd, $J = 10.7, 7.8$ Hz, 1H, 5'-H), 3.68 (dd, $J = 10.7, 4.5$ Hz, 1H, 5'-H), 4.04 (t, $J = 8.8$ Hz, 1H, 4'-H), 4.13 (t, $J = 8.2$ Hz, 1H, 4'-H), 4.62 (t, $J = 6.4$ Hz, 1H, 2'-H), 4.79 (br.s, 1H, 5'-OH), 5.61 (br.s, 1H, 2'-OH), 5.79 (d, $J = 5.6$ Hz, 1H, 1'-H), 7.26 (s, 2H, NH₂), 8.15 (s, 1H, 2-H), 8.31 (s, 1H, 8-H). ¹³C NMR (75 MHz, DMSO-*d*₆) δ ppm 48.98 (3'-C), 60.18 (5'-C), 70.29 (4'-C), 75.12 (2'-C), 89.98 (1'-C), 119.15 (5-C), 139.61 (8-C), 149.46 (4-C), 152.59 (2-C), 156.04 (6-C). ESI-HRMS for [M+H]⁺ calcd, 252.1097; found, 252.1081.

1'-(Adenin-9-yl)- β -D-apio-D-furanose (3b)^[35]: Following the procedure described for the synthesis of **6b**, compound **45** (1.2g, 3.37 mmol) rendered title compound **3b** (800 mg, 89%) as a white solid. ¹H NMR (300 MHz, DMSO-*d*₆) δ ppm 3.46 (q, *J* = 11.1 Hz, 1H, 5'-H), 3.76 (d, *J* = 9.1 Hz, 1H, 4'-H), 4.31 (d, *J* = 9.4 Hz, 1H, 4'-H), 4.80 (t, *J* = 6.4 Hz, 1H, 2'-H), 4.85 (s, 1H, 3'-OH), 4.91 (br. s., 1H, 5'-OH), 5.42 (d, *J* = 6.4 Hz, 1H, 2'-OH), 5.88 (d, *J* = 7.6 Hz, 1H, 1'-H), 7.26 (s, 2H, NH₂), 8.15 (s, 1H, 2-H), 8.33 (s, 1H, 8-H). ¹³C NMR (75 MHz, DMSO-*d*₆) δ ppm 62.42 (5'-C), 73.37 (2'-C), 74.53 (4'-C), 78.23 (3'-C), 87.65 (1'-C), 119.27 (5-C), 139.93 (8-C), 149.72 (4-C), 152.62 (2-C), 156.04 (6-C). ESI-HRMS for [M+H]⁺ calcd, 268.1046; found, 268.1107.

1'-(Thymin-1-yl)-2',3'-(*O*-thiocarbonyl)-5'-(*O*-benzyl)- β -D-apio-D-furanose (46): To a solution of **44** (200 mg, 0.57 mmol) in DMF (4 mL) was added thiocarbonyldiimidazole (112 mg, 0.63 mmol) and the mixture was heated to 80 °C for 90 minutes. The volatiles were removed under reduced pressure and the residue was purified by silica-gel column chromatography (2% MeOH in CH₂Cl₂) to afford the title thiocarbonate **46** (200 mg, 89%) as a pale yellow solid. ¹H NMR (300 MHz, CDCl₃) δ ppm 1.94 (d, *J* = 1.2 Hz, 3H, 5-CH₃), 3.89 (d, *J* = 11.1 Hz, 1H, 5'-H), 4.17 (d, *J* = 10.8 Hz, 1H, 5'-H), 4.30 - 4.42 (m, 2H, 4'-H), 4.57 - 4.71 (m, 2H, PhCH₂), 5.47 (d, *J* = 0.9 Hz, 1H, 1'-H), 5.82 (d, *J* = 1.2 Hz, 1H, 2'-H), 7.03 (d, *J* = 1.2 Hz, 1H, 6-H), 7.27 - 7.38 (m, 5H, PhCH₂), 9.35 (s, 1H, NH). ¹³C NMR (75 MHz, CDCl₃) δ ppm 12.29 (5-CH₃), 67.73 (5'-C), 73.74 (PhCH₂), 77.44 (4'-C), 88.71 (2'-C), 97.49 (1'-C), 100.15 (3'-C), 112.22 (5-C), 127.63, 127.99, 128.52, 137.05 (PhCH₂), 139.36 (6-C), 151.18 (2-C), 163.57 (4-C), 189.42 (CS). ESI-HRMS [M+H]⁺ calcd, 391.0964; found, 391.0544.

1'-(Adenin-9-yl)-2',3'-(*O*-thiocarbonyl)-5'-(*O*-benzyl)- β -D-apio-D-furanose (47):

Following the procedure described for the synthesis of **46**, compound **45** (300 mg, 0.84 mmol)

rendered title compound **47** (260 mg, 78%) as a pale yellow solid. ^1H NMR (300 MHz, CDCl_3) δ ppm 4.03 (d, $J = 10.8$ Hz, 1H, 5'-H), 4.33 (d, $J = 11.1$ Hz, 1H, 4'-H), 4.42 (d, $J = 11.1$ Hz, 1H, 4'-H), 4.45 (d, $J = 10.5$ Hz, 1H, 5'-H), 4.61, 4.75 (d, $J = 12.3$ Hz, 2H, PhCH_2), 5.74 (br. s., 2H, NH_2), 6.14 (s, 1H, 2'-H), 6.20 (s, 1H, 1'-H), 7.29 - 7.40 (m, 5H, PhCH_2), 7.87 (s, 1H, 8-H) 7.95 (s, 1H, 2-H). ^{13}C NMR (75 MHz, CDCl_3) δ ppm 66.95 (5'-C), 73.86 (PhCH_2), 75.00 (4'-C), 88.29 (2'-C), 90.33 (1'-C), 99.62 (3'-C), 119.90 (5-C), 127.98, 128.22, 128.63, 136.93 (PhCH_2), 140.28 (8-C), 149.13 (4-C), 153.04 (2-C), 155.59 (6-C), 189.43 (CS). ESI-HRMS $[\text{M}+\text{H}]^+$ calcd, 400.1079; found, 400.1060.

1'-(Thymin-1-yl)-2',3'-(dideoxydidehydro)-5'-(O-benzyl)- β -D-apio-D-furanose (48): A solution of compound **46** (180 mg, 0.46 mmol) in trimethylphosphite ($\text{P}(\text{OCH}_3)_3$, 8.0 mL) was heated to 120 °C for 6h. The volatile materials were removed under reduced pressure and then co-evaporated 2-3 times with toluene. The residue was purified by silica-gel column chromatography (0-2% MeOH in CH_2Cl_2) to afford **48** (130 mg, 90%) as a white foam. ^1H NMR (300 MHz, CDCl_3) δ ppm 1.91 (d, $J = 1.2$ Hz, 3H, 5- CH_3), 4.25 (s, 2H, 5'-H), 4.58 (s, 2H, PhCH_2), 4.63 - 4.74 (m, 1H, 4'-H), 4.77 - 4.90 (m, 1H, 4'-H), 5.67 - 5.76 (m, 1H, 2'-H) 6.91 (q, $J = 1.2$ Hz, 1H, 6-H), 7.00 (m, 1H, 1'-H), 7.29 - 7.44 (m, 5H, PhCH_2), 8.47 (br. s., 1H, NH). ^{13}C NMR (75 MHz, CDCl_3) δ ppm 12.60 (5- CH_3), 65.08 (5'- CH_2), 73.18 (PhCH_2), 75.57 (4'-C), 90.91 (1'-C), 111.26 (5-C), 119.90 (2'-C), 127.77, 128.11, 128.61, 137.28 (PhCH_2), 135.33 (6-C), 145.44 (3'-C), 150.47 (2-C), 163.63 (4-C). ESI-HRMS $[\text{M}+\text{Na}]^+$ calcd, 337.1159; found, 337.1168.

1'-(Thymin-1-yl)-2',3'-(dideoxydihydro)- β/α -D-apio-D/L-furanose (1a + 4a): Following the procedure described for the synthesis of **25**, compound **48** (120 mg, 0.38 mmol) rendered **1a** and **4a** as inseparable mixtures in 4: 1 ratio respectively (77 mg, 89%) as a white solid.

1'-(Thymin-1-yl)-3'-deoxy-5'-O-(tert-butyldimethylsilyl)- α -D-apio-L-furanose (49):

Compound **5a** (150 mg, 0.62 mmol) was dissolved in DMF (3.5 mL), to this was added imidazole (85 mg, 1.24 mmol) followed by *tert*-butyldimethylsilylchloride (TBSCl, 112 mg, 0.74 mmol). The mixture was stirred at room temperature for 18h. DMF was evaporated under reduced pressure. The residue was partitioned between EtOAc and brine. Organic layer separated, dried over sodium sulphate, solvent evaporated and the residue purified by silica-gel flash column chromatography using 1-2% MeOH-CH₂Cl₂ to afford compound **49** (210 mg, 95%) as a white solid. ¹H NMR (300 MHz, CDCl₃) δ ppm 0.07 (2s, 6H, Si(CH₃)₂), 0.89 (s, 9H, C(CH₃)₃), 1.94 (d, *J* = 0.9 Hz, 3H, 5-CH₃), 2.32-2.46 (m, 1H, 3'-H), 3.84 (d, *J* = 10.3, 7.3 Hz, 1H, 5'-H), 3.97 (d, *J* = 10.3, 5.9 Hz, 1H, 5'-H), 4.10 (t, *J* = 8.5 Hz, 1H, 4'-H), 4.35 (t, *J* = 7.9 Hz, 1H, 4'-H), 4.39 (t, *J* = 4.1 Hz, 1H, 2'-H), 4.81 (d, *J* = 3.2 Hz, 1H, 2'-OH), 5.74 (s, 1H, 1'-H), 7.22 (d, *J* = 1.2 Hz, 1H, 6-H), 10.19 (br s, 1H, NH). ¹³C NMR (75 MHz, CDCl₃) δ ppm -5.51 (Si(CH₃)₂), -5.47 (Si(CH₃)₂), 12.65 (5-CH₃), 18.24 (C(CH₃)₃), 25.85 (C(CH₃)₃), 43.46 (3'-C), 59.75 (5'-C), 72.48 (4'-C), 76.10 (2'-C), 94.60 (1'-C), 110.54 (5-C), 134.84 (6-C), 150.66 (2-C), 164.35 (4-C). ESI-HRMS (M+H)⁺ calcd: 357.1846; found: 357.1852.

1'-(Adenin-9-yl)-3'-deoxy-5'-O-(tert-butyldimethylsilyl)- α -D-apio-L-furanose (50):

Following a similar procedure described for compound **49**, compound **5b** (260 mg, 1.03 mmol) afforded compound **50** (310 mg, 82%) as a white solid. ¹H NMR (300 MHz, CDCl₃) δ ppm 0.10 (s, 3H, SiCH₃), 0.10 (s, 3H, SiCH₃), 0.91 (s, 9H, C(CH₃)₃), 2.65 - 2.78 (m, 1H, 3'-H), 3.97 (dd, *J* = 6.0, 1.32 Hz, 2H, 5'-H), 4.21 (dd, *J* = 8.4, 7.47 Hz, 1H, 4'-H), 4.39 (dd, *J* = 8.5, 7.3 Hz, 1H, 4'-H), 4.81 (dt, *J* = 5.7, 2.7 Hz, 1H, 2'-H), 5.15 (d, *J* = 3.2 Hz, 1H, 2'-OH), 5.94 (br s, 2H, NH), 5.97 (d, *J* = 2.6 Hz, 1H, 1'-H), 7.94 (s, 1H, 8-H), 8.32 (s, 1H, 2-H). ¹³C NMR (75 MHz, CDCl₃) δ ppm -5.52 (SiCH₃), -5.50 (SiCH₃), 18.19 (C(CH₃)₃), 25.81 (C(CH₃)₃), 43.28 (3'-C), 60.02 (5'-C), 71.17 (4'-C), 77.07 (2'-C), 93.00 (1'-C), 120.31 (5-

C), 138.43 (8-C), 148.96 (4-C), 152.73 (2-C), 155.51 (6-C). ESI-HRMS ($M+H$)⁺ calcd: 366.1961; found: 366.1941.

1'-(Thymin-1-yl)-3'-deoxy-5'-O-(tert-butyldimethylsilyl)- β -D-apio-D-furanose (51):

Following a similar procedure described for compound **49**, compound **2a** (200 mg, 0.83 mmol) afforded compound **51** (260 mg, 88%) as a white foam. ¹H NMR (300 MHz, CDCl₃) δ ppm 0.05 (s, 6H, Si(CH₃)₂), 0.87 (s, 9H, C(CH₃)₃), 1.92 (d, J = 1.2 Hz, 3H, 5-CH₃), 2.51 - 2.66 (m, 1H, 3'-H), 3.69 (dd, J = 10.5, 6.2 Hz, 1H, 5'-H), 3.75 (dd, J = 10.3, 4.7 Hz, 1H, 5'-H), 3.94 - 4.07 (m, 2H, 4'-H & 2'-OH), 4.18 (ddd, J = 7.0, 4.0, 2.8 Hz, 1H, 2'-H), 4.28 (t, J = 8.4 Hz, 1H, 4'-H), 5.61 (d, J = 4.1 Hz, 1H, 1'-H), 7.27 (d, J = 1.2 Hz, 1H, 6-H), 9.42 (s, 1H, NH). ¹³C NMR (75 MHz, CDCl₃) δ ppm -5.40, -5.35 (SiCH₃), 12.71 (5-CH₃), 18.34 (C(CH₃)₃), 25.92 (C(CH₃)₃), 48.36 (3'-C), 60.80 (5'-C), 70.95 (4'-C), 78.74 (2'-C), 94.35 (1'-C), 110.69 (5-C), 134.88 (6-C), 151.72 (2-C), 164.07 (4-C). ESI-HRMS for $[M+H]^+$ calcd, 357.1846; found, 357.1855.

1'-(Adenin-9-yl)-3'-deoxy-5'-O-(tert-butyldimethylsilyl)- β -D-apio-D-furanose (52):

Following a similar procedure described for compound **49**, compound **2b** (350 mg, 1.39 mmol) afforded compound **52** (415 mg, 82%) as a white solid. ¹H NMR (300 MHz, CDCl₃) δ ppm 0.03, 0.04 (s's, 2 x 3H, Si(CH₃)₃), 0.85 (s, 9H, C(CH₃)₃), 2.64 - 2.79 (m, 1H, 3'-H), 3.76 (dd, J = 10.4, 6.3 Hz, 1H, 5'-H), 3.85 (dd, J = 10.4, 4.5 Hz, 1H, 5'-H), 4.15 (t, J = 9.1 Hz, 1H, 4'-H), 4.30 - 4.40 (t, J = 8.5 Hz, 1H, 4'-H), 4.52 (dd, J = 8.6, 5.7 Hz, 1H, 2'-H), 5.69 (br.s, 1H, 2'-OH), 5.79 (d, J = 5.9 Hz, 1H, 1'-H), 5.95 (s, 2H, NH₂), 7.97 (s, 1H, 8-H), 8.27 (s, 1H, 2-H). ¹³C NMR (75 MHz, CDCl₃) δ ppm -5.53, -5.49 (SiCH₃), 18.24 (C(CH₃)₃), 25.80 (C(CH₃)₃), 47.70 (3'-C), 61.06 (5'-C), 71.08 (4'-C), 77.36 (2'-C), 92.83 (1'-C), 120.08 (5-C), 138.38 (8-C), 149.18 (4-C), 152.51 (2-C), 155.53 (6-C). ESI-HRMS for $[M+H]^+$ calcd, 366.1961; found, 366.1962.

1'-(Thymin-1-yl)-2',3'-dideoxy-5'-O-benzyl- α -D-apio-L-furanose (53): To a solution of compound **37** (250 mg, 0.75 mmol) and DMAP (184 mg, 1.5 mmol) in acetonitrile (10 mL) was added dropwise *O-p*-tolyl chlorothionoformate (138 μ L, 0.9 mmol) at room temperature. The mixture was stirred for additional 2h, and then the volatile organics were evaporated under reduced pressure. The residue was suspended in EtOAc and washed with water and brine. The organic layer was dried over anhydrous sodium sulfate and the solvent evaporated to dryness. The residue obtained was suspended in toluene (25 mL), tributyltinhydride (0.51 mL, 1.88 mmol) was added followed by at 60-70 °C was added azoisobutyronitrile (AIBN, 250 mg, 1.5 mmol) and heated to 110-120 °C for 3h. Volatile materials were evaporated and the residue was purified by silica-gel flash column chromatography using 0.5-2% MeOH-CH₂Cl₂ to afford compound **53** (167 mg, 70 %) as a white foam. ¹H NMR (300 MHz, CDCl₃) δ ppm 1.86 (d, *J* = 1.2 Hz, 3H, 5-CH₃), 2.06 (ddd, *J* = 13.8, 7.9, 3.8 Hz, 1H, 2'-H), 2.16 (ddd, *J* = 13.8, 7.5, 6.4 Hz, 1H, 2'-H), 2.52 - 2.68 (m, 1H, 3'-H), 3.36 (dd, *J* = 9.1, 7.3 Hz, 1H, 5'-H), 3.45 (dd, *J* = 9.1, 5.6 Hz, 1H, 5'-H), 3.74 (dd, *J* = 8.8, 7.0 Hz, 1H, 4'-H), 4.24 (dd, *J* = 8.8, 7.3 Hz, 1H, 4'-H), 4.45 (s, 2H, CH₂Ph), 5.96 (dd, *J* = 6.4, 4.1 Hz, 1H, 1'-H), 7.07 (d, *J* = 1.2 Hz, 1H, 6-H), 7.20 - 7.33 (m, 5H, CH₂Ph), 8.56 (br s, 1H, NH). ¹³C NMR (75 MHz, CDCl₃) δ ppm 12.65 (5-CH₃), 35.88 (2'-C), 38.06 (3'-C), 70.83 (5'-C), 72.71 (4'-C), 73.39 (CH₂Ph), 86.96 (1'-C), 110.38 (5-C), 127.67 (CH₂Ph), 127.85 (CH₂Ph), 128.49 (CH₂Ph), 135.04 (6-C), 137.76 (CH₂Ph), 150.09 (2-C), 163.72 (4-C). ESI-HRMS (M+H)⁺ calcd: 317.1501; found: 317.1499.

1'-(Adenin-9-yl)-2',3'-dideoxy-5'-O-benzyl- α -D-apio-L-furanose (54): Following a similar procedure described for compound **53**, compound **38** (45 mg, 0.13 mmol) gave compound **54** (30 mg, 70 %) as a white foam. ¹H NMR (300 MHz, CDCl₃) δ ppm 2.32 (ddd (dt), *J* = 13.9, 7.1 Hz, 1H, 2'-H), 2.68 (ddd, *J* = 13.6, 7.8, 2.9 Hz, 1H, 2'-H), 2.81 - 2.95 (m, 1H, 3'-H), 3.45 - 3.58 (m, 2H, 5'-H), 3.90 (dd, *J* = 8.8, 6.4 Hz, 1H, 4'-H), 4.34 (dd, *J* = 8.6, 7.5 Hz, 1H, 4'-

H), 4.53 (s, 2H, *CH*₂Ph), 6.11 (br s, 2H, NH), 6.29 (dd, *J* = 6.9, 3.1 Hz, 1H, 1'-H), 7.27 - 7.39 (m, 5H, *CH*₂Ph), 7.90 (s, 1H, 8-H), 8.32 (s, 1H, 2-H). ¹³C NMR (75 MHz, CDCl₃) δ ppm 35.47 (2'-C), 38.19 (3'-C) 71.02 (5'-C), 72.18 (4'-C), 73.27 (*CH*₂Ph), 85.90 (1'-C), 120.17 (5-C), 127.63 (*CH*₂Ph), 127.78 (*CH*₂Ph), 128.44 (*CH*₂Ph), 137.85 (*CH*₂Ph), 138.45 (8-C), 149.21 (4-C) 152.83 (2-C) 155.53 (6-C). ESI-HRMS (M+H)⁺ calcd: 326.1617; found: 326.1611.

1'-(Thymin-1-yl)-2',3'-dideoxy-5'-O-(*tert*-butyldimethylsilyl)-α-D-apio-L-furanose

(55)^[3]: Following a similar procedure described for compound **53**, compound **49** (190 mg, 0.53 mmol) gave compound **55** (130 mg, 72 %) as a white foam. ¹H NMR (300 MHz, CDCl₃) δ ppm 0.06 (s, 6H, Si(CH₃)₂), 0.90 (s, 9H, C(CH₃)₃), 1.94 (d, *J* = 1.3 Hz, 3H, 5-CH₃), 2.06 (ddd, *J* = 13.8, 8.2, 4.0 Hz, 1H, 2'-H), 2.25 (dt, *J* = 13.8, 6.9 Hz, 1H, 2'-H), 2.48 - 2.63 (m, 1H, 3'-H), 3.58 (dd, *J* = 10.0, 6.8 Hz, 1H, 5'-H), 3.66 (dd, *J* = 10.1, 5.2 Hz, 1H, 5'-H), 3.83 (dd, *J* = 8.8, 6.9 Hz, 1H, 4'-H), 4.26 (dd, *J* = 8.7, 7.2 Hz, 1H, 4'-H), 6.04 (dd, *J* = 6.6, 3.9 Hz, 1H, 1'-H), 7.16 (q, *J* = 1.3 Hz, 1H, 6-H), 8.88 (br s, 1H, NH). ¹³C NMR (75 MHz, CDCl₃) δ ppm -5.51 (SiCH₃), -5.48 (SiCH₃), 12.65 (5-CH₃), 18.23 (C(CH₃)₃), 25.81 (C(CH₃)₃), 35.34 (2'-C), 40.14 (3'-C), 63.37 (5'-C), 72.17 (4'-C), 87.08 (1'-C), 110.35 (5-C), 135.10 (6-C), 150.20 (2-C), 163.90 (4-C). ESI-HRMS (M+H)⁺ calcd: 341.1897; found: 341.1884.

1'-(Adenin-9-yl)-2',3'-dideoxy-5'-O-(*tert*-butyldimethylsilyl)-α-D-apio-L-furanose (56)^[3]:

Following a similar procedure described for compound **53**, compound **50** (300 mg, 0.82 mmol) gave compound **56** (253 mg, 88 %) as a white foam. ¹H NMR (300 MHz, CDCl₃) δ ppm 0.07 (s, 6H, Si(CH₃)₂), 0.91 (s, 9H, C(CH₃)₃), 2.34 (ddd (dt), *J* = 13.7, 7.1 Hz, 1H, 2'-H), 2.62 (ddd, *J* = 13.3, 7.8, 2.9 Hz, 1H, 2'-H), 2.76 (dq, *J* = 13.5, 6.9 Hz, 1H, 3'-H), 3.60 - 3.74 (m, 2H, 5'-H), 3.92 (dd, *J* = 8.8, 6.4 Hz, 1H, 4'-H), 4.31 (dd, *J* = 8.5, 7.3 Hz, 1H, 4'-H), 5.70 (br s, 2H, NH), 6.30 (dd, *J* = 6.7, 2.9 Hz, 1H, 1'-H), 7.93 (s, 1H, 8-H), 8.36 (s, 1H, 2-H).

^{13}C NMR (75 MHz, CDCl_3) δ ppm -5.45 ($\text{Si}(\text{CH}_3)$), -5.42 ($\text{Si}(\text{CH}_3)$), 18.26 ($\text{C}(\text{CH}_3)_3$), 25.84 ($\text{C}(\text{CH}_3)_3$), 34.94 ($2'\text{-C}$), 40.38 ($3'\text{-C}$), 63.54 ($5'\text{-C}$), 71.80 ($4'\text{-C}$), 86.08 ($1'\text{-C}$), 120.32 (5-C), 138.57 (8-C), 149.35 (4-C), 152.96 (2-C), 155.36 (6-C). ESI-HRMS ($\text{M}+\text{H}$) $^+$ calcd: 350.2012; found: 350.2006.

1'-(Thymin-1-yl)-2',3'-dideoxy-5'-(*tert*-butyldimethylsilyl)- β -D-apio-D-furanose (57)^[3]:

Following a similar procedure described for compound **53**, compound **51** (250 mg, 0.70 mmol) gave compound **57** (215 mg, 90 %) as a white foam. ^1H NMR (300 MHz, CDCl_3) δ ppm 0.06 (s, 6H, SiCH_3), 0.89 (s, 9H, $\text{C}(\text{CH}_3)_3$), 1.77 (ddd, $J = 13.3, 8.9, 7.2$ Hz, 1H, $2'\text{-H}$), 1.94 (d, $J = 1.2$ Hz, 3H, 5-CH_3), 2.43 - 2.55 (m, 1H, $2'\text{-H}$), 2.55 - 2.72 (m, 1H, $3'\text{-H}$), 3.60 (dd, $J = 10.3, 5.9$ Hz, 1H, $5'\text{-H}$), 3.67 (dd, $J = 10.3, 5.0$ Hz, 1H, $5'\text{-H}$), 3.94 (t, $J = 7.8$ Hz, 1H, $4'\text{-H}$), 4.07 (t, $J = 8.1$ Hz, 1H, $4'\text{-H}$), 6.06 (dd, $J = 7.0, 6.4$ Hz, 1H, $1'\text{-H}$), 7.21 (q, $J = 1.2$ Hz, 1H, 6-H), 8.31 (br.s, 1H, NH). ^{13}C NMR (75 MHz, CDCl_3) δ ppm -5.47, -5.44 (SiCH_3), 12.62 (5-CH_3), 18.25 ($\text{C}(\text{CH}_3)_3$), 25.82 ($\text{C}(\text{CH}_3)_3$), 34.57 ($2'\text{-C}$), 40.88 ($3'\text{-C}$), 62.64 ($5'\text{-C}$), 71.02 ($4'\text{-C}$), 86.63 ($1'\text{-C}$), 110.87 (5-C), 134.93 (6-C), 150.34 (2-C), 163.79 (4-C). ESI-HRMS for $[\text{M}+\text{H}]^+$ calcd, 341.1897; found, 341.1891.

1'-(Adenin-9-yl)-2',3'-dideoxy-5'-(*tert*-butyldimethylsilyl)- β -D-apio-D-furanose (58)^[3]:

Following a similar procedure described for compound **53**, compound **52** (400 mg, 1.10 mmol) gave compound **58** (310 mg, 81 %) as a white foam. ^1H NMR (300 MHz, CDCl_3) δ ppm 0.05 (s, 6H, SiCH_3), 0.88 (s, 9H, $\text{C}(\text{CH}_3)_3$), 2.33 - 2.50 (m, 1H, $2'\text{-H}$), 2.57 - 2.81 (m, 2H, $2'$ & $3'\text{-H}$'s), 3.71 (d, $J = 5.3$ Hz, 2H, $5'\text{-H}$), 4.04 (t, $J = 8.2$ Hz, 1H, $4'\text{-H}$), 4.14 (t, $J = 7.6$ Hz, 1H, $4'\text{-H}$), 5.82 (br.s, 2H, NH_2), 6.29 (t, $J = 5.9$ Hz, 1H, $1'\text{-H}$), 8.05 (s, 1H, 8-H), 8.36 (s, 1H, 2-H). ^{13}C NMR (75 MHz, CDCl_3) δ ppm -5.44 (SiCH_3), 18.29 ($\text{C}(\text{CH}_3)_3$), 25.85 ($\text{C}(\text{CH}_3)_3$), 34.56 ($2'\text{-C}$), 41.59 ($3'\text{-C}$), 63.00 ($5'\text{-C}$), 71.09 ($4'\text{-C}$), 85.50 ($1'\text{-C}$), 120.22 (5-C), 138.43 (8-C).

C), 149.71 (4-C), 153.00 (2-C), 155.46 (6-C). ESI-HRMS for $[M+H]^+$ calcd, 350.2012; found, 350.2009.

1'-(Thymin-1-yl)-2',3'-dideoxy- α -D-apio-L-furanose (4a)^[3]: Following the hydrogenation procedure described for compound **5a**, compound **53** (150 mg, 0.47 mmol) gave compound **4a** (80 mg, 63 %) as a white solid. Alternatively, compound **55** (110 mg, 0.32 mmol) was dissolved in THF (2 mL) and TBAF (1M, 0.65 mL, 0.65 mmol) was added at room temperature. The reaction mixture was stirred for 3h, solvents evaporated, and the residue was subjected to silica-gel flash column chromatography (4-5% MeOH-CH₂Cl₂) to afford **4a** (65 mg, 89%) as a white solid. ¹H NMR (300 MHz, DMSO-*d*₆) δ ppm 1.80 (d, *J* = 0.9 Hz, 3H, 5-CH₃), 1.96 - 2.13 (m, 2H, 2'-H), 2.45-2.60 (m, 1H, 3'-H), 3.33 - 3.48 (m, 2H, 5'-H), 3.63 (dd, *J* = 8.2, 6.2 Hz, 1H, 4'-H), 4.22 (dd, *J* = 8.2, 7.03 Hz, 1H, 4'-H), 4.76 (t, *J* = 5.3 Hz, 1H, 5'-OH), 5.97 (dd, *J* = 6.4, 4.7 Hz, 1H, 1'-H), 7.43 (d, *J* = 1.2 Hz, 1H, 6-H), 11.24 (s, 1H, NH). ¹³C NMR (75 MHz, CD₃OD) δ ppm 12.58 (5-CH₃), 36.18 (2'-C), 41.73 (3'-C), 63.92 (5'-C), 73.31 (4'-C), 88.50 (1'-C), 111.36 (5-C), 137.85 (6-C), 152.42 (2-C), 166.70 (4-C). ESI-HRMS (M+H)⁺ calcd: 227.1032; found: 227.1041.

1'-(Adenin-9-yl)-2',3'-dideoxy- α -D-apio-L-furanose (4b)^[3]: Compound **56** (350 mg, 1.0 mmol) was dissolved in MeOH (15 mL) in a polypropylene vessel and NH₄F (742 mg, 20 mmol) was added at room temperature. The reaction mixture was stirred at 55 °C for 48h; CH₂Cl₂ (20 mL) was added to the reaction vessel and filtered. The filtrate was evaporated, and the residue was subjected to silica-gel flash column chromatography (10-12% MeOH-CH₂Cl₂) to afford **4b** (205 mg, 87%) as a white solid. ¹H NMR (300 MHz, DMSO-*d*₆) δ ppm 2.21 (app-q, *J* = 6.7, 13.5 Hz, 1H, 2'-H), 2.54 (ddd, *J* = 3.5, 8.2, 12.9 Hz, 1H, 2'-H), 2.76 (sep, *J* = 6.4 Hz, 1H, 3'-H), 3.44 (m, 2H, 5'-H), 3.75 (dd, *J* = 5.3, 8.2 Hz, 1H, 4'-H), 4.18 (t, *J* = 7.9 Hz, 1H, 4'-H), 4.82 (t, *J* = 5.0 Hz, 1H, 5'-OH), 6.27 (dd, *J* = 3.2, 6.7 Hz, 1H, 1'-H),

7.24 (br s, 2H, 6-NH₂'s), 8.15 (s, 1H, 2-H), 8.26 (s, 1H, 8-H). ¹³C NMR (75 MHz, DMSO-*d*₆) 33.88 (2'-C), 40.44 (3'-C), 62.18 (5'-C), 70.85 (4'-C), 84.31 (1'-C), 119.15 (5-C), 139.16 (8-C), 148.93 (4-C), 152.50 (2-C), 155.99 (6-C). ESI-HRMS (M+H)⁺ calcd: 236.1147; found: 236.1131.

1'-(Thymin-1-yl)-2',3'-dideoxy-β-D-apio-D-furanose (1a)^[3]: Following a similar procedure described for the synthesis of compound **4b**, compound **57** (200 mg, 0.59 mmol) gave compound **1a** (115 mg, 86 %) as a white solid. ¹H NMR (300 MHz, CDCl₃) δ ppm 1.71 (t, *J* = 4.7 Hz, 1H, 5'-OH), 1.74 - 1.86 (m, 1H, 2'-H), 1.94 (d, *J* = 1.5 Hz, 3H, 5-CH₃), 2.51 - 2.75 (m, 2H, 2' & 3'-H's), 3.64 - 3.81 (m, 2H, 5'-H), 3.98 (dd, *J* = 8.8, 7.0 Hz, 1H, 4'-H), 4.07 - 4.16 (m, 1H, 4'-H), 6.02 (t, *J* = 6.6 Hz, 1H, 1'-H), 7.27 - 7.30 (q, *J* = 1.4 Hz, 1H, 6-H), 8.43 (br.s, 1H, NH). ¹³C NMR (75 MHz, CDCl₃) δ ppm 12.64 (5-CH₃), 34.70 (2'-C), 40.65 (3'-C), 63.23 (5'-C), 71.16 (4'-C), 86.92 (1'-C), 110.78 (5-C), 135.28 (6-C), 150.26 (2-C), 163.63 (4-C). ESI-HRMS for [M-H]⁻ calcd, 225.0881; found, 225.0875.

1'-(Adenin-9-yl)-2',3'-dideoxy-α-D-apio-D-furanose (1b)^[3]: Following a similar procedure described for the synthesis of compound **4b**, compound **58** (300 mg, 0.86 mmol) gave compound **1b** (190 mg, 94 %) as a white solid. ¹H NMR (300 MHz, DMSO-*d*₆) δ ppm 2.25 - 2.39 (m, 1H, 2'-H), 2.52 - 2.67 (m, 2H, 2' & 3'-H's), 3.48 - 3.65 (m, 2H, 5'-H), 3.89 (t, *J* = 8.2 Hz, 1H, 4'-H), 4.00 (t, *J* = 7.9 Hz, 1H, 4'-H), 4.82 (t, *J* = 5.1 Hz, 1H, 5'-OH), 6.23 (t, *J* = 6.7 Hz, 1H, 1'-H), 7.26 (s, 2H, NH₂), 8.15 (s, 1H, 2-H), 8.32 (s, 1H, 8-H). ¹³C NMR (75 MHz, DMSO-*d*₆) δ ppm 33.73 (2'-C), 41.70 (3'-C), 61.67 (5'-C), 70.77 (4'-C), 84.28 (1'-C), 119.17 (5-C), 139.05 (8-C), 149.17 (4-C), 152.52 (2-C), 156.02 (6-C). ESI-HRMS for [M+H]⁺ calcd, 236.1147; found, 236.1137.

1'-(Adenin-9-yl)-2',3'-dideoxy-β-D-apio-D-furanose triphosphate (12): Compound **1b** (25 mg, 0.106 mmol) and tributylammonium pyrophosphate **60** (117 mg, 0.212 mmol) were

placed in a 50 mL and a 10 mL RB flask respectively, and dried under high vacuum for 1h. 2-chloro-4H-1,3,2-benzodioxaphosphinin-4-one **59** (43 mg, 0.212 mmol) was placed in a separate 10 mL flask and dried briefly (10 min) under high vacuum. Anhydrous DMF (0.25 mL) was added to each flask under argon atmosphere. Tributylamine (dried and stored over 4A molecular sieves, 0.3 mL) was added to the flask containing tributylammonium pyrophosphate (**60**) with stirring. The contents of this flask were added to the flask containing 2-chloro-4H-1,3,2-benzodioxaphosphinin-4-one (**59**) and stirring continued for 1.5h. The cyclic phosphitodiphosphate (**61**) formed was added to a flask containing compound **4b** in DMF. After stirred for 1.5h, 3% iodine solution (9:1 pyridine-water, 2.25 mL) was added drop wise and stirred for 20 min followed by the addition of water (4 mL) and stirred for additional 1.5h. 3M NaCl solution (0.66 mL) was added to the reaction mixture. The reaction mixture was transferred to two centrifuge tubes (~4 mL each) and absolute ethanol (16 mL) was added to each tube, shaken well and immersed in powdered dry ice for 1h. The tubes were centrifuged (20 °C, 3200 rpm, 20 min), and the clear solution decanted to afford crude product as white solid. The crude product was dissolved in distilled water (3.0 mL) and purified using Source-15Q ion exchange HPLC (0.5 mL injection, 0→5 min, 100% H₂O; 5→40 min, 100% H₂O to 100% 1M triethylammonium bicarbonate buffer, linear gradient @flow rate 6 mL/min). The compound eluting at 33 min (or 0.8M triethylammonium bicarbonate buffer) was collected and lyophilized to afford triethylammonium salt of triphosphate **12** as a white solid (17 mg, 21%) as highly hygroscopic colorless solid. ¹H NMR (300 MHz, D₂O) δ ppm 1.27 (t, *J* = 7.3 Hz, 24H, NCH₂CH₃), 1.33 (t, *J* = 7.3 Hz, 3H, NCH₂CH₃), 2.42 (ddd, *J* = 13.6, 8.6, 6.7 Hz, 1H, 2'-H), 2.74 - 2.89 (m, 1H, 2'-H), 2.89 - 3.12 (m, 3H, 3'-H & NCH₂CH₃), 3.19 (q, *J* = 7.3 Hz, 14H, NCH₂CH₃), 3.54 (q, *J* = 7.1 Hz, 2H, NCH₂CH₃), 4.05 (t, *J* = 8.6 Hz, 1H, 4'-H), 4.14 (app-t, *J* = 6.2 Hz, 2H, 5'-H), 4.28 (t, *J* = 8.5 Hz, 1H, 4'-H), 6.35 (t, *J* = 6.7 Hz, 1H, 1'-H), 8.26 (s, 1H), 8.47 (s, 1H). ¹³C NMR (75 MHz,

D₂O) δ ppm 7.34, 8.38, 10.68 (NCH₂CH₃), 33.59 (2'-C), 39.30 (d, J_{p-c} = 8.1 Hz, 3'-C), 42.36, 46.79 (NCH₂CH₃), 66.32 (d, J_{p-c} = 5.9 Hz, 5'-C), 70.79 (4'-C), 85.05 (1'-C), 150.79, 154.26. ³¹P NMR (121 MHz, D₂O) δ ppm -23.28 (br. s, 1P, β -P) -11.20, -11.04 (br. d, 2P, α & γ -P). ESI-HRMS for [M-H]⁻ calcd, 473.9981; found, 473.9987.

1'-(Adenin-9-yl)-2',3'-dideoxy- α -D-apio-L-furanose triphosphate (13): Following the reaction protocol described for the synthesis of **12**, compound **4b** (25 mg, 0.106 mmol) afforded triethylammonium salt of triphosphate **13** as a white solid (45 mg, 48%). ¹H NMR (300 MHz, D₂O) δ ppm 1.21 (t, J = 7.3 Hz, 36H, HN(CH₂CH₃)₃), 2.46 (dt, J = 14.4, 7.3 Hz, 1H, 2'-H), 2.66 (ddd, J = 14.1, 8.1, 3.2 Hz, 1H, 2'-H), 3.10 (q, J = 7.3 Hz, 25H, 3'-H & HN(CH₂CH₃)₃), 3.95 (dd, J = 8.9, 6.3 Hz, 1H, 4'-H), 3.99 - 4.12 (m, 2H, 5'-H), 4.27 (dd, J = 8.8, 7.6 Hz, 1H, 4'-H), 6.37 (dd, J = 7.0, 3.2 Hz, 1 H), 8.16 (s, 1H, 2-H), 8.28 (s, 1H, 8-H). ¹³C NMR (75 MHz, D₂O) δ ppm 8.44 (HN(CH₂CH₃)₃), 33.86 (2'-C), 38.35 (d, J_{p-c} = 8.3 Hz, 3'-C), 46.69 (HN(CH₂CH₃)₃), 66.86 (d, J_{p-c} = 6.1 Hz, 5'-C), 71.38 (4'-C), 85.31 (1'-C), 119.09 (5-C), 140.22 (8-C) 148.61 (4-C), 152.73 (2-C), 155.69 (6-C). ³¹P NMR (121 MHz, D₂O) δ ppm -22.64 (dd, J = 21.1, 19.6 Hz, β P), -11.04 (d, J = 19.6 Hz, α P), -6.34 (d, J = 21.1 Hz, γ P). ESI-HRMS (M-H)⁻ calcd: 473.9981; found: 473.9982.

Phenyl(benzyloxy/isopropoxy-L-alaninyl)phosphorochloridate (64a/b)^[36]: To a stirred solution of phenyldichlorophosphate (0.30 mL, 2.00 mmol), L-alaninebenzyl/ isopropyl ester tosylate/chloride (2.00 mmol) in anhydrous CH₂Cl₂ (15 mL), anhydrous TEA (0.56 mL, 4.00 mmol) was added dropwise under an argon atmosphere at -78 °C. Following the addition the reaction mixture was stirred at -78 °C for 30 min, then at room temperature for 2h. Formation of the desired compound was monitored by ³¹P NMR. After this period the solvent was removed under reduced pressure and the residue triturated with anhydrous diethyl ether. The precipitate was filtered under nitrogen and the solution was concentrated to give **64a/b** (87 -

96%) as yellow oil. Spectral data for **64a**: ^{31}P NMR (CDCl_3 , 202 MHz): δ 7.86, 7.52. ^1H NMR (CDCl_3 , 500 MHz): δ 7.33-7.28 (m, 10H, PhO, OCH_2Ph), 5.15-5.13 (m, 2H, OCH_2Ph), 4.18-4.13 (m, 1H, CHNH), 1.46-1.44 (m, 3H, CH_3). Spectral data for **64b**: ^{31}P NMR (CDCl_3 , 202 MHz): δ 8.13, 7.75. ^1H NMR (CDCl_3 , 500 MHz): δ ppm 7.47-7.16 (m, 5H, PhO), 5.18-4.98 (m, 1H, COOCH), 4.41, 4.33 (2bs, 1H, NHCH), 4.21-4.09 (m, 1H, NHCH), 1.53, 1.51 (2d, 3H, $J = 2.30$, CHCH_3), 1.35-1.27 (m, 6H, $\text{COOCH}(\text{CH}_3)_2$).

1'-(Thymin-1-yl)-2',3'-dideoxy- α -D-apio-D-furanose [phenyl-(benzoxy-L-alaninyl)]

phosphate (9a): To a solution of **1a** (0.048 g, 0.21 mmol) in anhydrous THF (4 mL) was added a solution of phosphorochloridate **64a** (0.22g, 0.64 mmol) in anhydrous THF (2 mL), followed by the drop wise addition, under an argon atmosphere, of anhydrous NMI (0.88 mL, 1.11 mmol) and the reaction mixture was stirred at room temperature for 48 h. After this period, the solvent was removed and the residue taken up in dichloromethane and washed with 0.5 M HCl (2 x 15 mL). The combined organics were dried over MgSO_4 filtered and evaporated. The residue was purified by preparative thin layer chromatography (2000 micron, Aldrich) using a mixture $\text{CH}_2\text{Cl}_2/\text{MeOH}$ 95:5 v/v as eluent to give a **9a** (0.040 g, 35%) as a pale yellow foamy solid. ^1H NMR (500 MHz, CD_3OD) δ ppm 7.47, 7.46 (d, $J = 2.5$ Hz, 2H, H-6), 7.37-7.32 (m, 14H, Ph and CH_2Ph), 7.23-7.18 (m, 6H, Ph), 5.99 (t, $J = 6.0$ Hz, 1H, H-1'), 5.98 (t, $J = 6.0$ Hz, 1H, H-1'), 5.17-5.15 (m, 4H, CH_2Ph), 4.17-4.05 (m, 4H, CH_2OP), 4.04-4.01 (m, 2H, CHCH_3), 4.00-3.87 (m, 4H, CH_2O), 2.79-2.73 (m, 1H, H-3'), 2.72-2.66 (m, 1H, H-3'), 2.05-2.39 (m, 2H, H-2'a), 1.89, 1.88 (d, $J = 1.5$ Hz, 6H, CH_3), 1.81-1.72 (m, 2H, H-2'b), 1.38 (d, $J = 7.5$ Hz, 3H, CHCH_3), 1.35 (d, $J = 7.5$ Hz, 3H, CHCH_3). ^{13}C NMR (125 MHz, CD_3OD) δ ppm 174.93 (d, $J_{\text{CP}} = 5.0$ Hz, CO_2Bn), 174.74 (d, $J_{\text{CP}} = 5.0$ Hz, CO_2Bn), 166.44, 166.42 (CO), 152.30, 152.29 (CO), 152.21 (d, $J_{\text{CP}} = 2.8$ Hz, $\text{C}_{\text{ipso}}\text{OPh}$), 152.16 (d, $J_{\text{CP}} = 2.8$ Hz, $\text{C}_{\text{ipso}}\text{OPh}$), 137.54, 137.52 (C-6), 137.32, 137.31 ($\text{C}_{\text{ipso}}\text{OCH}_2\text{Ph}$), 130.82, 130.80 (Ph), 129.66, 129.64, 129.43, 129.40, 129.36, 129.31 (CH_2Ph), 126.25, 126.23 (Ph), 121.53

(d, $J_{CP} = 4.6$ Hz, Ph), 121.44 (d, $J_{CP} = 5.3$ Hz, Ph), 111.65 (C-5), 88.07, 88.03, (C-1'), 71.65, 71.46 (CH₂O), 68.37 (d, $J_{CP} = 5.0$ Hz, CH₂OP), 68.25 (d, $J_{CP} = 5.0$ Hz, CH₂OP), 67.98 (CH₂Ph), 51.83, 51.65 (CHCH₃), 40.45 (d, $J_{CP} = 3.8$ Hz, C-3'), 40.39 (d, $J_{CP} = 3.8$ Hz, C-3'), 35.20, 35.12 (CH₂), 20.35 (d, $J_{CP} = 7.5$ Hz, CHCH₃), 20.29 (d, $J_{CP} = 7.5$ Hz, CHCH₃), 12.51 (CH₃). ³¹P NMR (202 MHz, CD₃OD) δ ppm 3.88, 3.33. MS (ESI); 566 [M+Na]⁺. HPLC; ACN/H₂O 10/90 v/v to 100/0 in 30 min, $\lambda = 280$ nm, flow 1 mL/min, $t_R = 15.42$ min.

1'-(Adenin-9-yl)-2',3'-dideoxy- α -D-apio-D-furanose [phenyl-(benzoxy-L-alaninyl)]

phosphate (9b): Following the reaction protocol mentioned for the synthesis of compound **9a**, **1b** (0.050 g, 0.21 mmol) was reacted with phosphorochloridate **64a** (0.23 g, 0.66 mmol) to give **9b** (0.030 g, 26%) as a white foamy solid. ¹H NMR (500 MHz, CD₃OD) δ ppm 8.24, 8.23 (2s, 1H, H-8), 8.22, 8.21 (2s, 1H, H-2), 7.40-7.26 (m, 16H, Ph), 7.22-7.15 (m, 4H, Ph), 6.27 (t, $J = 7.0$ Hz, 1H, H-1'), 6.24 (t, $J = 6.5$ Hz, 1H, H-1'), 5.14 (s, 4H, CH₂Ph), 4.26-4.19 (m, 4H CH₂OP), 4.10-3.96 (m, 6H, CH₂O and CHCH₃), 2.91-2.75 (m, 2H, H-3'), 2.69- 2.57 (m, 2H, H2'a), 2.41-2.34 (m, 2H, H2'b), 1.37 (d, $J = 6.5$ Hz, 3H, CH₃), 1.35 (d, $J = 7.0$ Hz, 3H, CH₃). ¹³C NMR (125 MHz, CD₃OD) δ ppm 174.96 (d, $J_{CP} = 4.2$ Hz, CO₂Bn), 174.74 (d, $J_{CP} = 4.6$ Hz, CO₂Bn), 157.32 (C-6), 153.84, 153.83 (C-2), 152.22 (d, $J_{CP} = 2.5$ Hz, C_{ipso}OPh), 152.17 (d, $J_{CP} = 2.5$ Hz, C_{ipso}OPh), 150.36 (C-4), 140.78, 140.74 (C-8), 137.29, 137.28 (C_{ipso}OCH₂Ph), 130.80 (d, $J_{CP} = 0.7$ Hz, Ph), 130.78 (d, $J_{CP} = 0.9$ Hz, Ph), 129.60, 129.38, 129.36, 129.35, 129.30 (CH₂Ph), 126.20 (d, $J_{CP} = 1.3$ Hz, Ph), 126.17 (d, $J_{CP} = 1.3$ Hz, Ph), 121.52 (d, $J_{CP} = 4.6$ Hz, Ph), 121.42 (d, $J_{CP} = 4.6$ Hz, Ph), 120.70, 120.68 (C-5), 87.00, 86.98, (C-1'), 71.82, 71.70 (CH₂O), 68.22 (d, $J_{CP} = 5.5$ Hz, CH₂OP), 68.15 (d, $J_{CP} = 5.5$ Hz, CH₂OP), 67.99, 67.97 (CH₂Ph), 51.83 (d, $J_{CP} = 1.4$ Hz, CHCH₃), 51.65 (CHCH₃), 41.10 (d, $J_{CP} = 7.8$ Hz, C-3'), 41.05 (d, $J_{CP} = 7.8$ Hz, C-3'), 35.23, 35.10 (CH₂), 20.39 (d, $J_{CP} = 7.0$ Hz, CHCH₃), 20.33 (d, $J_{CP} = 7.0$ Hz, CHCH₃). ³¹P NMR (202 MHz, CD₃OD) δ ppm 3.80, 3.28. ESI-MS;

553 [M+H]⁺, 575 [M+Na]⁺. HPLC; ACN/H₂O 10/90 v/v to 100/0 in 30 min, λ = 280 nm, flow 1 mL/min, t_R = 14.36 min.

1'-(Thymin-1-yl)-2',3'-dideoxy-α-D-apio-D-furanose [phenyl-(isopropoxy-L-alaninyl)]

phosphate (10a): Following the reaction protocol mentioned for the synthesis of compound **9a**, **1a** (0.050 g, 0.22 mmol) was reacted with phosphorochloridate **64b** (0.203g, 0.66 mmol) to give **10a** (0.096 g, 88%) as a pale yellow foamy solid. ¹H NMR (500 MHz, CD₃OD) δ ppm 7.58, 7.57 (2s, 2H, H-6), 7.45 (d, *J* = 8.0 Hz, 2H, Ph), 7.44 (d, *J* = 7.5 Hz, 2H, Ph), 7.33-7.28 (m, 6H, Ph), 6.10 (t, *J* = 7.0 Hz, 1H, H-1'), 6.08 (t, *J* = 7.0 Hz, 1H, H-1'), 5.10-5.03 (m, 2H, CH(CH₃)₂), 4.33-4.21 (m, 4H, CH₂OP), 4.16-4.10 (m, 2H, CH₂O), 4.01-3.96 (m, 2H, CH₂O), 3.94-3.89 (m, 2H, CHCH₃), 2.95-2.86 (m, 2H, H-3'), 2.64-2.56 (m, 2H, H-2'a), 1.97 (s, 6H, CH₃), 1.95-1.88 (m, 2H, H-2'b), 1.43 (d, *J* = 7.5 Hz, 3H, CHCH₃), 1.40 (d, *J* = 6.5 Hz, 3H, CHCH₃), 1.34-1.30 (m, 12H, CH(CH₃)₂). ¹³C NMR (125 MHz, CD₃OD) δ ppm (d, *J*_{CP} = 5.4 Hz, CO₂iPr), 174.54 (d, *J*_{CP} = 4.5 Hz, CO₂iPr), 166.46, 166.44 (CO), 152.30 (d, *J*_{CP} = 3.6 Hz, C_{ipso}OPh), 152.28 (CO), 152.25 (d, *J*_{CP} = 3.6 Hz, C_{ipso}OPh), 137.57 (C-6), 130.84, 130.81, 126.25, 126.23 (Ph), 121.54 (d, *J*_{CP} = 4.5 Hz, Ph), 121.47 (d, *J*_{CP} = 5.3 Hz, Ph), 111.69 (C-5), 88.15, 88.12, (C-1'), 71.73, 71.58 (CH₂O), 70.19, 70.16 (CH(CH₃)₂), 68.42 (d, *J*_{CP} = 5.4 Hz, CH₂OP), 68.32 (d, *J*_{CP} = 5.4 Hz, CH₂OP), 51.89, 51.88 (CHCH₃), 40.55 (d, *J*_{CP} = 3.5 Hz, C-3'), 40.49 (d, *J*_{CP} = 3.6 Hz, C-3'), 35.27, 35.18 (CH₂), 22.05, 22.03, 21.98, (CH(CH₃)₂), 20.55 (d, *J*_{CP} = 7.2 Hz, CHCH₃), 20.43 (d, *J*_{CP} = 7.2 Hz, CHCH₃), 12.54, 12.52 (CH₃). ³¹P NMR (202 MHz, CD₃OD) δ ppm 3.89, 3.49. ESI-MS; 518 [M+Na]⁺. HPLC; ACN/H₂O 10:90 v/v to 100:0 in 30 min.; λ = 280 nm, flow 1 mL/min, t_R = 13.79, 13.81 min.

1'-(Adenin-9-yl)-2',3'-dideoxy-α-D-apio-D-furanose [phenyl-(isopropoxy-L-alaninyl)]

phosphate (10b): Following the reaction protocol mentioned for the synthesis of compound **9a**, **1b** (0.050 g, 0.21 mmol) was reacted with phosphorochloridate **64b** (0.201g, 0.66 mmol) to give **10b** (0.054 g, 51%) as a white foamy solid. ¹H NMR (500 MHz, CD₃OD) δ ppm 8.27,

8.25 (2s, 2H, H-8), 8.23, 8.22 (2s, 2H, H-2), 7.35 (d, $J = 8.0$ Hz, 2H, Ph), 7.34 (d, $J = 7.8$ Hz, 2H, Ph), 7.26-7.16 (m, 6H, Ph), 6.29 (t, $J = 7.0$ Hz, 1H, H-1'), 6.28 (t, $J = 7.0$ Hz, 1H, H-1'), 5.02-4.94 (m, 2H, $\text{CH}(\text{CH}_3)_2$), 4.33 (m, 4H, CH_2OP), 4.16-4.05 (m, 4H, CH_2O), 3.93-3.88 (m, 2H, CHCH_3), 2.96-2.89 (m, 2H, H-3'), 2.75- 2.66 (m, 2H, H2'a), 2.49-2.43 (m, 2H, H2'b), 1.35 (d, $J = 7.0$ Hz, 3H, CH_3), 1.33 (d, $J = 7.0$ Hz, 3H, CH_3), 1.23-1.21 (m, 12H, $\text{CH}(\text{CH}_3)_2$). ^{13}C NMR (125 MHz, CD_3OD) δ ppm (d, $J_{\text{CP}} = 4.5$ Hz, CO_2iPr), 174.51 (d, $J_{\text{CP}} = 4.5$ Hz, CO_2iPr), 157.35 (C-6), 153.89 (C-2), 152.27 (d, $J_{\text{CP}} = 3.4$ Hz, $\text{C}_{\text{ipso}}\text{OPh}$), 152.22 (d, $J_{\text{CP}} = 2.6$ Hz, $\text{C}_{\text{ipso}}\text{OPh}$), 150.38 (C-4), 140.82, 140.79 (C-8), 130.81, 126.19, 126.16 (Ph), 121.53 (d, $J_{\text{CP}} = 5.5\text{Hz}$, Ph), 121.45 (d, $J_{\text{CP}} = 5.5$ Hz, CH Ph), 120.73, 120.70 (C-5), 87.04, 87.04, (C-1'), 71.89, 71.83 (CH_2O), 70.15 ($\text{CH}(\text{CH}_3)_3$), 68.32 (d, $J_{\text{CP}} = 6.4$ Hz, CH_2OP), 68.23 (d, $J_{\text{CP}} = 6.4$ Hz, CH_2OP), 51.88, 51.72 (CHCH_3), 41.19 (d, $J_{\text{CP}} = 7.2$ Hz, C-3'), 41.13 (d, $J_{\text{CP}} = 7.2$ Hz, C-3'), 35.24, 35.11 (CH_2), 22.00, 21.95, 21.94, ($\text{CH}(\text{CH}_3)_3$), 20.55 (d, $J_{\text{CP}} = 6.4$ Hz, CHCH_3), 20.43 (d, $J_{\text{CP}} = 6.4$ Hz, CHCH_3). ^{31}P NMR (202 MHz, CD_3OD) δ ppm 3.81, 3.46. ESI-MS; 505 $[\text{M}+\text{H}]^+$, 527 $[\text{M}+\text{Na}]^+$. HPLC; ACN/ H_2O 10/90 v/v to 100/0 in 30 min, $\lambda = 280$ nm, flow 1 mL/min, $t_{\text{R}} = 12.61$ min.

1'-(Thymin-1-yl)-2',3'-dideoxy- α -D-apio-L-furanose [phenyl-(benzoxy-L-alaninyl)]

phosphate (11a): To a solution of **4a** (0.095 g, 0.42 mmol) in anhydrous THF (10 mL) was added 1.0M solution of *tert*-butyl magnesium chloride in THF (0.84 mL, 0.84 mmol) and the reaction mixture was stirred under an argon atmosphere for 30 min. After this period, a solution of **64a** (0.30 g, 0.84 mmol) in anhydrous THF (5 mL) was added dropwise and the reaction mixture was stirred at room temperature for 17 h. After this period, the solvent was removed and the residue was purified by column chromatography, gradient elution of $\text{CHCl}_3/\text{MeOH} = 98/2$ to 95/5 to give **11a** (0.051 g, 22%) as a white solid. ^{31}P NMR (CD_3OD , 202 MHz): δ 3.80, 3.30. ^1H NMR (CD_3OD , 500 MHz): δ 7.40-7.30 (8H, m, H-6, PhO, OCH_2Ph), 7.23-7.18 (3H, m, PhO, OCH_2Ph), 6.01-5.99 (0.5H, m, H-1'), 5.98-5.96 (0.5H, m,

H-1'), 5.17, 5.16 (2H, 2s, OCH₂Ph), 4.28-4.21 (1H, m, H-4' of one diastereoisomer), 4.14-4.00 (3H, m, 3'-CH₂, CHCH₃), 3.75-3.69 (1H, m, H-4' of one diastereoisomer), 2.80-2.74 (0.5H, m, H-3' of one diastereoisomer), 2.73-2.66 (0.5H, m, H-3' of one diastereoisomer), 2.22-2.07 (2H, m, H-2'), 1.90 (3H, 2s, 5-CH₃), 1.38 (1.5H, d, *J* = 7.2 Hz, CHCH₃ of one diastereoisomer), 1.36 (1.5H, d, *J* = 7.4 Hz, CHCH₃ of one diastereoisomer). ¹³C NMR (CD₃OD, 125 MHz): δ 12.56 (5-CH₃), 20.38 (d, *J*_{C-P} = 7.2 Hz, CH₃), 20.44 (d, *J*_{C-P} = 7.2 Hz, CH₃), 35.61, 35.64 (C-2'), 39.73, 39.79 (C-3'), 51.66, 51.83 (CHCH₃), 68.00 (OCH₂Ph), 68.49 (d, *J*_{C-P} = 6.0 Hz, 3'-CH₂), 68.53 (d, *J*_{C-P} = 5.8 Hz, 3'-CH₂), 72.49, 72.54 (C-4'), 88.36, 88.38 (C-1'), 111.30, 111.33 (C-5), 121.50, 121.53, 121.57, 121.61, 126.22, 128.03, 129.33, 129.37, 129.40, 129.42, 129.65, 129.66, 130.83 (arom H), 137.32 C_{ipso} Bn), 137.74, 137.76 (C-6), 152.16, 152.19, 152.23 (C-2, C_{ipso} OPh), 166.52 (C-4), 174.75 (d, *J*_{C-P} = 4.6 Hz, CO), 174.96 (d, *J*_{C-P} = 4.6 Hz, CO). ES-MS = 566.17 (M+Na⁺). HPLC = H₂O/ACN from 100/0 to 0/100 in 30 min = retention time 18.24 min; H₂O/MeOH from 100/0 to 0/100 in 30 min = retention time 25.07 min.

1'-(Adenin-9-yl)-2',3'-dideoxy- α -D-apio-L-furanose [phenyl-(benzoxy-L-alaninyl)] phosphate (11b): To a solution of **4b** (0.10 g, 0.42 mmol) in anhydrous THF (10 mL) and anhydrous pyridine (2 mL) was added a solution of **64a** (0.45g, 1.26 mmol) in anhydrous THF (5 mL), followed by the addition drop wise under an argon atmosphere of anhydrous NMI (0.10 mL, 1.26 mmol) and the reaction mixture was stirred at room temperature for 24 h. After this period, a solution of **64a** (0.30 g, 0.84 mmol) in anhydrous THF (3 mL) and anhydrous NMI (0.07 mL, 0.84 mmol) were added and the reaction mixture was stirred at room temperature for further 24 h. After this period, the solvent was removed and the residue was purified by column chromatography, gradient elution of CH₂Cl₂, then CH₂Cl₂/MeOH = 98/2 then 96/4 then 90/10 to give a white solid which was triturated with diethyl ether to give **11b** (0.035 g, 15%) as a white solid. ³¹P NMR (CD₃OD, 202 MHz): δ 3.86, 3.31. ¹H NMR

(CD₃OD, 500 MHz): δ 8.22, 8.21, 8.20, 8.17 (2H, 4s, H-2, H-8), 7.37-7.16 (10H, m, arom H), 6.31 (0.5H, dd, $J = 7.0$ Hz, 3.30 Hz, H-1' of one diastereoisomer), 6.26 (0.5H, dd, $J = 7.00$ Hz, 3.20 Hz, H-1' of one diastereoisomer), 5.16, 5.15 (2H, 2s, CH₂Ph), 4.29-4.22 (1H, m, H-4'), 4.18-4.02 (3H, m, CHCH₃, 3'-CH₂), 3.86-3.78 (1H, m, H-4'), 3.03-2.89 (1H, m, H-3'), 2.65-2.56 (1H, m, H-2'), 2.35-2.24 (1H, m, H-2'), 1.39 (1.5H, d, $J = 7.0$ Hz, CH₃ of one diastereoisomer), 1.37 (1.5H, d, $J = 7.2$ Hz, CH₃ of one diastereoisomer). ¹³C NMR (CD₃OD, 125 MHz): δ 20.35 (d, $J_{C-P} = 6.7$ Hz, CHCH₃), 20.41 (d, $J_{C-P} = 6.8$ Hz, CHCH₃), 35.38, 35.39 (C-2'), 40.00 (d, $J_{C-P} = 2.7$ Hz, C-3'), 40.06 ($J_{C-P} = 2.8$ Hz, C-3'), 51.66, 51.83 (CHCH₃), 67.95, 67.97 (CH₂Ph), 68.63 (d, $J_{C-P} = 5.7$ Hz, 3'-CH₂), 68.75 (d, $J_{C-P} = 5.8$ Hz, 3'-CH₂), 72.13, 72.15 (C-4'), 86.98 (C-1'), 120.65, 121.48, 121.52, 121.57, 121.61, 126.18, 126.21, 129.31, 129.35, 129.37, 129.61, 129.72, 130.80 (arom H), 137.31 (C_{ipso} Bn), 140.78 (C-2), 152.19 (d, $J_{C-P} = 5.5$ Hz, C_{ipso} OPh), 152.25 (d, $J_{C-P} = 4.7$ Hz, C_{ipso} OPh), 153.67, 153.81 (C-8), 157.30 (C-8), 174.75 (d, $J_{C-P} = 4.7$ Hz, CO), 174.96 (d, $J_{C-P} = 4.5$ Hz, CO). ESI-MS= 575.1640 (M+Na⁺). HPLC = H₂O/ACN from 100/0 to 0/100 in 30 min = retention time 17.05 min.

Bioevaluations

Carboxypeptidase Y enzymatic assay

ProTide (5.5 mg) was dissolved in d₆-acetone (150 μ L), and Trizma buffer (pH 7.6) (300 μ L) was added. The resulting cloudy solution was placed in a NMR tube and a ³¹P NMR experiment at 25 °C was recorded as the blank experiment. Then a solution of carboxypeptidase Y (0.1 mg) in Trizma buffer (150 μ L) was added and a ³¹P NMR experiment was performed recording the experiment at specific intervals.

Cytostatic activity assay

The compounds were evaluated for their potential cytostatic activities against murine leukemia L1210, human CD₄⁺ T-cell lymphocyte CEM and human cervix carcinoma HeLa cancer cells. In brief, different concentrations (5-fold dilutions) of the compounds were incubated at 37°C for 72 h (HeLa and CEM cells) or 48 h in the L1210 bioassay. After the incubation period, the number of viable cells were counted by a Coulter Particle counter and the IC₅₀ was defined as the 50% inhibitory concentration or compound concentration required to inhibit tumor cell proliferation by 50%.

Antiviral assays

The anti-HIV activity was evaluated against the laboratory HIV-1 strain IIIB and HIV-2 strain ROD in human T-lymphocyte CEM or MT-4 cell cultures. Briefly, virus stocks were titrated in human T-lymphocyte CEM or MT-4 cells and expressed as the 50% cell culture infective dose (CCID₅₀, 1 CCID₅₀ being the virus dose required to infect 50% of the cell cultures). CEM or MT-4 cells were suspended in culture medium at ~ 3 x 10⁵ cells/ml and infected with HIV at ~ 100 CCID₅₀. Immediately after viral exposure, 100 µl of the cell suspension was placed in each well of a flat-bottomed microtiter tray containing various concentrations of the test compounds. After a 4-day incubation period at 37 °C, the giant cell formation was microscopically determined in the CEM cell cultures. Cytopathicity in MT-4 cell cultures was estimated by the tetrazolium dye method. Compounds were tested in parallel for their potential cytostatic effects in uninfected CEM cell cultures.

The other antiviral assays for herpes simplex virus type 1 (HSV-1) (KOS), HSV-2 (G), VZV (YS) and CMV (Davis and AD-169) were based on inhibition of virus-induced cytopathicity in HEL cell cultures. Confluent cell cultures in microtiter 96-well plates were inoculated with 100 CCID₅₀ of virus or 20 plaque forming units (VZV) in the presence of varying concentrations of the test compounds. Viral cytopathicity was recorded as soon as it

reached completion in the control virus-infected cell cultures that were not treated with the test compounds

HIV-RT primer-template assay.

Primer oligonucleotides 5' CAGGAAACAGCTATGAC 3' (Sigma Genosys) were labeled with 5' [γ - ^{33}P]-ATP (Perkin Elmer) using T4 polynucleotide kinase (New England Biolabs) according to the manufacturer's protocol. The labeled primers were further purified using illustra MicroSpin G-25 Column (GE Healthcare) and then annealed with template oligonucleotides 5' TTTTTTGTTCATAGCTGTTTCCTG 3' (Eurogentec) in a 1:2 molar ratio by heating the mixture at 75°C for 5 min, followed by slowly cooling to room temperature. The DNA polymerization mixtures containing 125 nM primer-template complex, reaction buffer (supplied with the HIV RT), 125, 500, or 1000 μM of modified triphosphate (**12**, **13**) and 0.03 $\text{U}\cdot\mu\text{l}^{-1}$ HIV reverse transcriptase (Ambion) were incubated at 37°C and aliquots were taken after 15, 30 and 60 min. In the control reaction, 50 μM of natural dATP was used. All polymerase reactions were then stopped by adding a double volume of gel loading buffer (90% formamide, 50mM EDTA, 0.05% bromophenol blue and 0.05% xylene cyanol). Samples were heated at 70°C for 5 min prior to separation on a 0.4mm 20% denaturing polyacrylamide gel. The bands were then visualized using phosphorimaging.

Associated content

Supporting Information: copies of ^1H , ^{13}C , ^{31}P and 2-D NMR spectra of relevant compounds.

This material is available free of charge via the Internet at <http://pubs.acs.org/>.

Funding source

KU Leuven provided support for the antiviral/cytostatic and enzyme testing (GOA 10/014). The 700 MHz equipment of the Interuniversity NMR Facility was financed by

Ghent University, the Free University of Brussels (VUB), and the University of Antwerp via the “Zware Apparatuur” Incentive of the Flemish Government.

Acknowledgements

We thank Mrs. Lizette van Berckelaer, Mrs. Leentje Persoons, Mrs. Leen Ingels, Mrs. Sandra Claes, Mrs. Evelyne Van Kerckhove, Mrs. Frieda De Meyer and Mr. Izet Karalic for excellent technical assistance. D.S. thanks the FWO-Flanders (FWO-Vlaanderen) for a postdoctoral mandate.

References

-
- [1] De Clercq, E. A 40-year journey in search of selective antiviral chemotherapy. *Annu. Rev. Pharmacol. Toxicol.* **2011**, *51*, 1-24.
 - [2] Bamford, M. J.; Humber, D. C.; Storer, R. *Tetrahedron Lett.* **1991**, *32*, 271-274.
 - [3] Sells, T. B.; Nair, V. *Tetrahedron* **1994**, *50*, 117-138.
 - [4] Nair, V.; Jahnke, T. S. *Antimicrob. Agents Chemother.* **1995**, *39*, 1017-1029.
 - [5] Wu, T.; Froeyen, M.; Kempeneers, V.; Pannecouque, C.; Wang, J.; Busson, R.; De Clercq, E.; Herdewijn, P. *J. Am. Chem. Soc.* **2005**, *127*, 5056–5065.
 - [6] Hammerschmidt, F.; Oehler, E.; Polsterer, J.; Zbiral, E.; Balzarini, J.; DeClercq, E. *Liebigs Annalen* **1995**, *3*, 551-558.
 - [7] Parikh, D. K.; Watson, R. R. *J. Med. Chem.* **1978**, *21*, 706-709.
 - [8] Jung, M. E.; Toyota, A.; De Clercq, E.; Balzarini, J. *Mon. Chem.* **2002**, *133*, 499-520.
 - [9] Doboszewski, B.; Herdewijn, P. *Tetrahedron* **1996**, *52*, 1651-1668.
 - [10] Reist, E. J.; Calkins, D. F.; Goodman, L. Branched chain sugars. *J. Am. Chem. Soc.* **1968**, *90*, 3852-3857.
 - [11] Hammerschmidt, F.; Ohler, E.; Polsterer, J. P.; Zbiral, E.; Balzarini, J.; DeClercq, E. *Liebigs Annalen* **1995**, *3*, 559-565.
 - [12] Cahard, D.; McGuigan, C.; Balzarini, J. *Mini-Rev. Med. Chem.* **2004**, *4*, 371-381.

-
- [13] Gallier, F.; Alexandre, J. A. C.; El Amri, C.; Deville-Bonne, D.; Peyrottes, S.; Perigaud, C. *ChemMedChem* **2011**, *6*, 1094-1106.
- [14] Smith III, A. B.; Sulikowski, G. A.; Sulikowski, M. M.; Fujimoto, K. *J. Am. Chem. Soc.* **1992**, *114*, 2567-2576.
- [15] Schoning, K.; Scholz, P.; Wu, X.; Guntha, S.; Delgado, G.; Krishnamurthy, R.; Eschenmoser, A. *Helv. Chim. Act.* **2002**, *85*, 4111-4153.
- [16] Huang, Q.; Herdewijn, P. *J. Org. Chem.* **2011**, *76*, 3742-3753.
- [17] Jin, D. Z.; Kwon, S. H.; Moon, H. R.; Gunaga, P.; Kim, H. O.; Kim, D.; Chuna, M. W.; Jeong, L. S. *Bioorg. Med. Chem.* **2004**, *12*, 1101-1109.
- [18] Ball, D. H.; Carey, F. A.; Klundt, I. L.; Long, Jr. L. *Carbohydr. Res.* **1969**, *10*, 121-128.
- [19] Lee, J.; Lewin, N. E.; Blumberg, P. M.; Marquez, V. E. *Bioorg. Med. Chem.* **1996**, *4*, 1299-1305.
- [20] Scaffidi, A.; Stubbs, K. A.; Dennis, R. J.; Taylor, E. J.; Davies, G. J.; Vocadlo, D. J.; Stick, R. V. *Org. Biomol. Chem.* **2007**, *5*, 3013-3019.
- [21] Bussolo, V. D.; Fiasella, A.; Romano, M. R.; Favero, L.; Pineschi, M.; Crotti, P. *Org. Lett.* **2007**, *9*, 4479-4482.
- [22] Nachman, R. J.; Hoemel, M.; Williams, T. M.; Halaska, R. C.; Mosher, H. S. *J. Org. Chem.* **1986**, *51*, 4802-4806.
- [23] Purchased from Carbosynth, Compton, Berkshire, UK. The suppliers claim in their website as 1,2;3,5-*O*-diisopropylidene-*D*-apio-*D*-furanose but we discovered that it is actually 1,2;3,5-*O*-diisopropylidene-*D*-apio-*L*-furanose **21**.
- [24] Lopin, C.; Gautier, A.; Gauhier, G.; Piettre, S. R. *J. Am. Chem. Soc.* **2002**, *124*, 14668-14675.
- [25] Toti, K. S.; Derudas, M.; McGuigan, C.; Balzarini, J.; Van Calenbergh, S. *Eur. J. Med. Chem.* **2011**, *46*, 3704-3713.
- [26] Framski, G.; Gdaniec, Z.; Gdaniec, M.; Boryski, J. *Tetrahedron* **2006**, *62*, 10123-10129.
- [27] Hiraguchi, K.; Konno, K.; Yamada, K.; Kitagawa, Y.; Nakamura, K. T.; Tanaka, H. *Tetrahedron* **2010**, *66*, 4587-4600.
- [28] Huang, Q.; Herdewijn, P. *Eur. J. Org. Chem.* **2011**, *19*, 3450-3457.
- [29] Sniady, A.; Bedore, M. W.; Jamison, T. F. *Angew. Chem. Int. Ed.* **2011**, *50*, 2155 - 2158.

-
- [30] Kumamoto, H, Onuma, s.; Tanaka, H.; Dutschman, G. E.; Cheng, Y-C. *Antivir. Chem. Chemother.* **2006**, *17*, 225-234.
- [31] Nencka, R.; Sinnaeve, D.; Karalic, I.; Martins, J.; Van Calenbergh, S. *Org. Biomol. Chem.* **2010**, *8*, 5234-5246.
- [32] Caton-Williams, J.; Smith, M.; Carrasco, N.; Huang, Z. *Org. Lett.* **2011**, *13*, 4156-4159.
- [33] Renders, M.; Emmerechtes, G.; Rozenski, J.; Krecmerova, M.; Holy, A.; Herdewijn, P. *Angew. Chem. Int. Ed.* **2007**, *46*, 2501-2504.
- [34] Mbairaroua, O.; Ton-That, T.; Tapiero, C. *Carbohydr. Res.* **1994**, *253*, 79-99.
- [35] Tronchet, J. M. J.; Tronchet, M. J. *Helv. Chim. Acta* **1971**, *54*, 1466-1479.
- [36] Derudas, M; Carta, D; Brancale, A; Vanpouille, C; Lisco, A; Margolis, L; Balzarini, J; McGuigan, C. *J. Med. Chem.* **2009**, *52*, 5520-5530.