

This is an Open Access document downloaded from ORCA, Cardiff University's institutional repository: <https://orca.cardiff.ac.uk/id/eprint/110055/>

This is the author's version of a work that was submitted to / accepted for publication.

Citation for final published version:

Widger, Phillip , Griffith, H. and Haddad, Abderrahmane 2018. Insulation strength of CF3I-CO2 gas mixtures as an alternative to SF6 in MV switch disconnectors. IEEE Transactions on Dielectrics and Electrical Insulation 25 (1) , pp. 330-338. 10.1109/TDEI.2018.006932

Publishers page: <http://dx.doi.org/10.1109/TDEI.2018.006932>

Please note:

Changes made as a result of publishing processes such as copy-editing, formatting and page numbers may not be reflected in this version. For the definitive version of this publication, please refer to the published source. You are advised to consult the publisher's version if you wish to cite this paper.

This version is being made available in accordance with publisher policies. See <http://orca.cf.ac.uk/policies.html> for usage policies. Copyright and moral rights for publications made available in ORCA are retained by the copyright holders.



Insulation Strength of CF_3I - CO_2 Gas Mixtures as an Alternative to SF_6 in MV Switch Disconnectors

P. Widger, H. Griffiths and A. Haddad

Cardiff University, School of Engineering, Advanced High Voltage Engineering Research Centre,
The Parade, Cardiff, CF24 3AA, Wales, UK.

ABSTRACT

This paper evaluates the insulation performance of gas mixtures of trifluoroiodomethane and carbon dioxide (CF_3I - CO_2) in a medium voltage switch disconnector. Practical testing compares the results of CF_3I - CO_2 against SF_6 to examine whether CF_3I - CO_2 could be a viable alternative when directly substituted into manufactured switch disconnectors in a purely insulating role. Positive standard lightning impulses were applied to the MV switchgear to determine whether CF_3I - CO_2 can maintain the withstand voltage for which the switch disconnector is rated when filled with SF_6 . The results show that certain gas mixtures of CF_3I - CO_2 , with a higher concentration of CF_3I , could be used to insulate switch disconnectors against standard lightning impulses at the rated pressure.

Index Terms — Trifluoroiodomethane (CF_3I), Sulphur Hexafluoride (SF_6), Gas Insulation, Gas Insulated Switchgear (GIS).

1 INTRODUCTION

IN recent years, it has been recognized that the global warming potential (GWP) of sulphur hexafluoride (SF_6) is extremely high [1]. Much research has been focused on finding an alternative to SF_6 with all the qualities that make it such an attractive insulating medium but without the detrimental effects it causes to the environment. The 100-year average GWP of SF_6 is 23,900 times that of carbon dioxide (CO_2). In contrast, the GWP is less than 5 for pure trifluoroiodomethane (CF_3I) [2].

Current research for CF_3I and CF_3I - CO_2 gas mixtures has found that pure CF_3I has a dielectric strength 1.2 times that of SF_6 in a uniform electric field [3]. However, its performance in non-uniform field conditions is worse than that of SF_6 [3]. Research has also determined that when current is interrupted by CF_3I or CF_3I - CO_2 gas mixtures, iodine can disassociate itself from CF_3I and attach itself to contacts [4]. This causes the electric field between contacts to alter and reduces the insulating performance of the gas. However, absorbents have been proposed to counteract this iodine deposition [5]. From present research the gaseous by-products of pure CF_3I and CF_3I - CO_2 gas mixtures may include CF_4 , $C_2F_6O_3$, CHF_3 , C_3F_8 , C_2HF_5 , C_2F_5I , C_2F_6 , C_2F_4 , C_2F_5I , C_3F_6 and CH_3I [6][7], however, the quantity of these by-products is still unknown so it is unclear whether this will have an impact on the ability of CF_3I gas mixtures to insulate equipment. It is likely that absorbents will be found to remove these gaseous by-products, however, research is still on-going in this area.

It has also been shown that pure CF_3I has a high boiling point of $-22.5^\circ C$ at 0.1 MPa [2] which could pose a problem for HV switchgear that typically operates at pressures up to 0.5 MPa [8]. However, gas mixtures of CF_3I - CO_2 could be used to mitigate this boiling temperature weakness, as mixing CO_2 with CF_3I lowers the boiling point in comparison with pure CF_3I . Gas mixtures of CF_3I - CO_2 might have an insulation strength lower than that of pure CF_3I so optimum mixture ratios need to be examined [8]. The maximum pressure used within the MV switch disconnectors in this paper is 0.45 bar (g) or 0.145 MPa which means that pure CF_3I could be used within this switchgear. Previous research has shown the use of 30:70% CF_3I - CO_2 gas mixtures in simple electrode geometries [9][10] and a ring main unit in order to insulate vacuum circuit breaker bottles and gas insulated ring switches and maintain the rated withstand level [11][12]. In this paper, gas mixtures of 10:90%, 20:80% and 30:70 % CF_3I - CO_2 were examined in order to investigate the effects of reducing the amount of CF_3I within the gas mixture. The gas insulated switches in this paper were tested above their rated withstand voltage level and at different pressures in order to determine the gas mixtures insulation strength. Examination of the V-t characteristics for the results of the 30:70% CF_3I - CO_2 gas insulated Ringmaster switch disconnector were reported in [13].

The properties of CF_3I could influence the decision to use it as an alternative to SF_6 in distribution equipment. The experimental investigation reported in this paper aims to examine the insulation strength of CF_3I - CO_2 gas mixtures in the complex contact geometry found in practical MV switchgear.

2 BREAKDOWN CHARACTERISTICS OF SWITCH DISCONNECTORS

The Ringmaster SE6 switch disconnector (Figure 1) and the Fluokit M24+ switch disconnector (Figure 2) are both examples of widely-used, SF₆ gas insulated switches on the UK distribution networks. The inside of the switch disconnector's geometry was not altered in any way to improve the insulation performance of CF₃I-CO₂ gas insulation. CF₃I-CO₂ has been shown to have improved insulation capabilities when used in conjunction with electrodes that have a more uniform electric field [3]. The electrodes in both switch disconnectors produce a non-uniform field as they are designed to separate quickly when the switch is operated. The electrodes must also link together to form a strong union when the load switch is placed in the closed position. The exact specifications of these electrode dimensions cannot be disclosed for confidentiality reasons. One of the difficulties when testing with practical three phase units, means that the electrodes do not always give exactly the same gas gap distance each time they are operated, as would be expected in a fixed electrode experiment and this allows for some variation in the results. However, this effect has been limited by producing an average of the three phases for each unit. Each phase was tested individually.

Laboratory tests were carried out using two Ringmaster switch disconnectors and two Fluokit switch disconnectors. One of each design was permanently filled with SF₆ and one was gassed and de-gassed with all the other gas mixtures as specified in the manufacturer's guidelines.

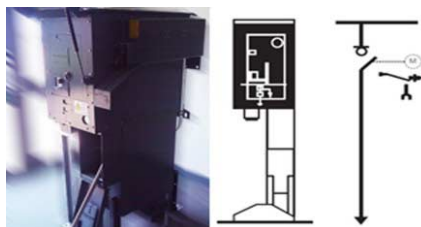

Figure 1. Ringmaster SE6 switch disconnector [14].



Figure 2. Fluokit M24+ switch disconnector [15].

The gas mixtures that are shown in the results refer to pressure mixtures. Pressure mixtures are measured by mixing one gas to a specific pressure and then adding the other to the full filling pressure. These pressure-pressure

ratios are not the same as gas weight-weight mixtures. The molecular weight of CF₃I is much heavier than that of CO₂ and, therefore, more CF₃I is required to fill the same volume to the same pressure compared with CO₂.

The manufacturer's rated insulation capabilities and specifications of the Ringmaster SE6 switch disconnector and the Fluokit M24+ switch disconnector are shown in Table 1. The rated lightning impulse withstand voltage for the Ringmaster switch disconnector is 95 kV when filled with SF₆ and 125 kV for the Fluokit. Any alternative gas would, therefore, need to be able to insulate the equipment and withstand these same voltage levels. The rated filling pressure of the Ringmaster with SF₆ is 0.35 bar (g), the rated filling pressure of the Fluokit with SF₆ is 0.45 bar (g). Both switches are expected to continue operating satisfactorily and have an insulation capability above their rated withstand voltage level if the pressure of the insulating gas reduced to 0 bar (g) or atmospheric pressure. The British standard BS62271-1, relating to switchgear and controlgear, specifies that a sealed-for-life piece of equipment must have a gas leakage of 0.1% per year or less when filled with SF₆ [16]. Switchgear is commonly filled with a positive pressure so that SF₆ can leak outwards, a negative pressure would mean that atmospheric air is much more likely to leak into the gas compartment. If an ingress of air was allowed into the switchgear, an increase in the moisture content within the gas compartment could detrimentally reduce the insulating capabilities of SF₆ or any other insulating gas mixtures used.

Table 1. Manufacturers rated specifications of the Ringmaster switch disconnector [14] and Fluokit switch disconnector [15]

Abbreviation	Description	Ringmaster SE6 Rating	Fluokit M24+ Rating
Up	Rated lightning impulse withstand voltage	95 kV	125 kV
Ud	Rated short-duration power-frequency withstand voltage	38 kV	50 kV
Ur	Rated Voltage	13.8 kV	24 kV
fr	Rated frequency	50/60 Hz	50 Hz
Ir	Rated normal current	630 A	630 A
Pre	Rated filling pressure for insulation and/or operation	0.035 MPa or 0.35 bar (g)	0.045 MPa or 0.45 bar (g)
m	Mass of Unit	350 kg	125 kg
SF ₆ m	Mass of SF ₆ gas	429 g	110 g

The Ringmaster and Fluokit switch disconnectors are three-position switches which have a load switch and an earthing switch. The switch disconnectors can be placed in position to either:

- earth the equipment
- open the load switch but not earth the equipment or
- close the load switch to create a link between the busbar and cable connections.

For the purpose of all the tests carried out in this investigation, a standard lightning impulse (1.2/50 μs) was applied to each phase on one side of the disconnector in turn. The impulse was applied to the busbar connection of the load switch as shown in Figure 3. The switch disconnector was placed into position so that the load break switch and the earth switch were both open. The gas inside the chamber was, therefore, insulating between both the busbar and cable connection (open load break switch) and between the cable and earth connections (open earth switch), as shown in Figure 3. When a standard lightning impulse was applied to one phase on one side of the load break switch, the other two phases were earthed. The cable connections were permanently earthed throughout testing as shown in Figure 3.

The readings from the current transformer measuring the current into the ground, shown in Figure 3, can help determine whether a gas breakdown occurs across the open load switch of the disconnector or at another point on the switchgear. When a standard lightning impulse, as described in BS60060-1 [17], causes a breakdown across the gas insulation, a current reading can be taken from an oscilloscope attached to the current transformer, as shown in Figure 4. In Figure 4, the orange line indicates a standard lightning impulse where a breakdown occurs across the gas gap to the earthed electrode, and a sudden voltage collapse can be observed. At the same instant as when the breakdown occurs, the current transformer records a current reading (green) on the opposite side of the load switch to which the lightning impulse was applied, indicating a gas insulation breakdown.

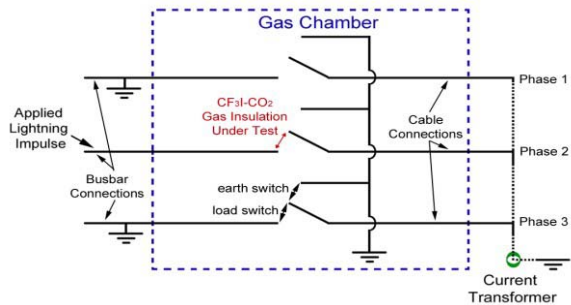

Figure 3. Standard lightning impulse test connections for Ringmaster and Fluokit switch disconnectors.

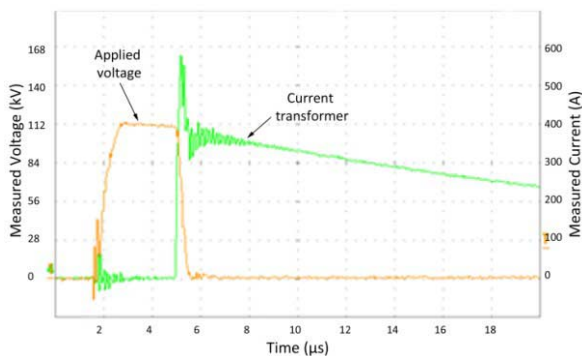

Figure 4. Applied lightning impulse to the Ringmaster switch disconnector with a gas breakdown.

If a flashover occurs, as indicated by the lightning impulse waveform, but a current reading is not registered on the other side of the switch, then an equipment flashover was recorded. An equipment flashover can occur when a lightning impulse is applied above the rated withstand voltage of the switch disconnector and the resulting flashover is across solid/air insulation and not the internal insulation gas that is being tested as shown in Figure 5. External flashover can occur through air to the metal earthed casing of the switch disconnector. Internal flashover can occur around the inside of the epoxy resin gas chamber to another earthed point as shown in Figure 5. These internal epoxy resin flashovers are the result of applying a large quantity of positive lightning impulses to the same unit. This can cause the inside of the epoxy resin chamber to accumulate a residual charge from previous impulses. This residual charge can create a biased path to earth that would not usually occur inside the switchgear. A piece of switchgear on the network would not normally be subjected to such a large number of lightning impulses all of the same polarity as tested here. These residual charges can be difficult to eradicate from the results, as they build up on the inside of the gas chamber which is sealed for the unit's lifetime.

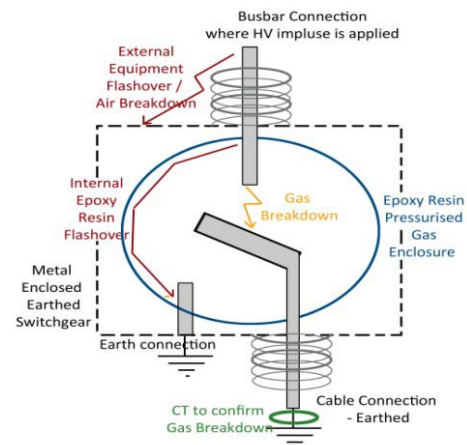

Figure 5. Switch disconnector breakdown events - insulation gas breakdown (orange) and equipment flashover (red)

3 POSITIVE STANDARD LIGHTNING IMPULSE WITHSTAND TEST RESULTS

3.1 EXPERIMENTAL METHOD

The first test undertaken was an impulse dielectric strength test as set out in procedure B of BS60060-1 which has been adapted for switchgear and controlgear. The procedure, which is further explained in BS62271-1 for impulse tests, was adhered to for the withstand voltage test results shown in this section. Positive lightning impulses were applied one after the other to each phase in turn at a constant 95 kV or 125 kV, which is the withstand voltage of the Ringmaster and Fluokit switch disconnectors respectively. A waiting time of 2 mins between impulses was used for this experimentation. The procedure outlines a test where the switchgear is deemed to have passed the impulse tests if the following conditions are fulfilled:

- “Each series has at least 15 tests
- The number of disruptive discharges shall not exceed two for each complete series
- No disruptive discharge on non-self restoring insulation shall occur. This is confirmed by 5 consecutive impulse withstands following the last disruptive discharge.
- This procedure leads to a maximum possible number of 25 impulses per series.” [16]

For each phase and for each gas mixture, at least 15 impulses were applied to determine whether the switch would pass or fail the test. Most phases were tested for 50 impulses (2 x 25 impulse series), if no significant breakdown events were recorded during the test. In order to avoid stress to the switch disconnector, a minimum of 15 impulses was applied when the gas mixture was constantly failing the test, the result was known (as for SF₆) or when the equipment was constantly suffering from epoxy resin flashover due to the number of tests being conducted. For the Ringmaster, all gas mixtures at a pressure of 0.35 bar (g), the rated filling of the switch disconnector, and 0 bar (g) have been tested. For the Fluokit, all gas mixtures at a pressure of 0.45 bar (g), the rated filling of the switch disconnector, and 0 bar (g) have been tested.

3.2 EXPERIMENTAL RESULTS

The results of the positive standard lightning impulse (LI) tests for all three phases of the Ringmaster switch disconnector are shown in Table 2, along with the percentage of gas breakdown events. These results indicate that, for insulation purposes from standard lightning impulses at 95 kV, all CF₃I-CO₂ gas mixtures will pass the gas insulation withstand voltage test for the Ringmaster switch disconnector at its recommended gas filling pressure of 0.35 bar (g). At the lower pressure (0 bar (g)), the gas mixture 10:90% CF₃I-CO₂ does not pass the withstand test and is, therefore, deemed unsuitable. The test results also show that, at 0 bar (g), the gas mixtures 30:70% and 20:80% CF₃I-CO₂ fail on some phases and pass on others with this withstand test, depending on which phase is tested. It is, therefore, recommended that the minimum pressure rating is raised above 0 bar (g) to ensure the Ringmaster passes this test consistently. For pure CO₂ and air, it is shown that the insulation strength of these gases is too low to pass the test. Table 2 indicates the percentage of gas breakdown events has to be virtually non-existent to ensure the switch disconnector passes the test. This ensures the insulation capability of the unit and its safe operation upon the network.

The results of the positive standard lightning impulse MV switchgear impulse tests over all three phases of the Fluokit switch disconnector are shown in Table 3. The results for the Fluokit switch disconnector indicate that all gas mixtures will pass the withstand voltage test except for 100 % CO₂ at 0 bar (g). The difference between the results for the Ringmaster and Fluokit is likely to be caused by contact geometry and the resulting electric field as well as a larger gas gap between open contacts in the Fluokit.

4 POSITIVE U₅₀ STANDARD LIGHTNING IMPULSE INSULATION STRENGTH TEST RESULTS

4.1 EXPERIMENTAL METHOD

Following the withstand tests carried out in section III, it was important to try and test the switchgear beyond its normal withstand capability and determine which gas mixtures were insulating the equipment most effectively. Throughout the following tests, the load switch was placed in the open position and the insulation strength of the gas was tested across a single phase at a time. Positive lightning impulses were applied one after the other using the ‘up-and-down’ method [17] to determine the voltage at which there is a 50% probability of breakdown occurring (U₅₀). This U₅₀ breakdown level was a measure of which gas mixture had the best insulation capability within these specific switch disconnectors which was not immediately clear from the previous tests undertaken.

In the Ringmaster, at least 50 impulses were applied to determine the voltage level of U₅₀ for each phase of each gas mixture. In SF₆, where the gas withstand strength is known to be above the maximum voltage that can be applied to the unit without external or internal flashover occurring, fewer impulses were applied.

In the Fluokit switch disconnector, at least 15 impulses were applied to determine the voltage level of U₅₀ for each phase of each gas mixture. Fewer impulses were applied to the Fluokit than in the Ringmaster because the gas mixtures were, for the most part, able to withstand up to the point where external or internal flashover occurred. This means that some of the results that follow are only a representation of the solid insulation external and internal flashover level and not the gas insulation breakdown level.

Table 2. Positive standard lightning impulse MV switchgear impulse withstand test (Up) in the Ringmaster switch disconnector.

Gas Mixture	Gas Pressure	Phase 1 95 kV Result	Phase 2 95 kV Result	Phase 3 95 kV Result	Percentage of Gas Breakdown Events
100% SF ₆	0.35 BAR (G)	PASS	PASS	PASS	0 %
30-70% CF ₃ I-CO ₂	0 BAR (G)	FAIL	FAIL	PASS	11.33 %
	0.35 BAR (G)	PASS	PASS	PASS	0 %
20-80% CF ₃ I-CO ₂	0 BAR (G)	PASS	FAIL	PASS	4.67 %
	0.35 BAR (G)	PASS	PASS	PASS	0 %
10-90% CF ₃ I-CO ₂	0 BAR (G)	FAIL	FAIL	FAIL	42.00 %
	0.35 BAR (G)	PASS	PASS	PASS	0.67 %
100% CO ₂	0 BAR (G)	FAIL	PASS	FAIL	37.70 %
	0.35 BAR (G)	FAIL	PASS	PASS	8.67 %
100% Air	0 BAR (G)	FAIL	FAIL	FAIL	88.33%
	0.35 BAR (G)	FAIL	FAIL	FAIL	38.00%

Table 3. Positive standard lightning impulse MV switchgear impulse withstand test (Up) in the Fluokit switch disconnector.

Gas Mixture	Gas Pressure	Phase 1 125 kV Result	Phase 2 125 kV Result	Phase 3 125kV Result	Percentage of Gas Breakdown Events
100% SF ₆	0.35 BAR (G)	PASS	PASS	PASS	0 %
30-70% CF ₃ I-CO ₂	0 BAR (G)	PASS	PASS	PASS	0 %
	0.35 BAR (G)	PASS	PASS	PASS	0 %
20-80% CF ₃ I-CO ₂	0 BAR (G)	PASS	PASS	PASS	0 %
	0.35 BAR (G)	PASS	PASS	PASS	2 %
10-90% CF ₃ I-CO ₂	0 BAR (G)	PASS	PASS	PASS	0 %
	0.35 BAR (G)	PASS	PASS	PASS	0.67 %
100% CO ₂	0 BAR (G)	PASS	FAIL	PASS	24.45 %
	0.35 BAR (G)	PASS	PASS	PASS	0 %
100% Air	0 BAR (G)	PASS	PASS	PASS	0.67 %
	0.35 BAR (G)	PASS	PASS	PASS	0 %

For all gas mixtures, a pressure of 0.35 bar (g) (the rated filling pressure) and 0 bar (g) have been used for testing the Ringmaster. For the Fluokit, a pressure of 0.45 bar (g) (the rated filling pressure) and 0 bar (g) have been used during the tests. It was important to test the insulation strength at 0 bar (g) to determine whether the gas would still be able to insulate the contacts even when the minimum operating pressure is reached. This minimum working pressure is the equivalent to the end of life of a piece of switchgear on the network without maintenance or re-filling.

4.2 EXPERIMENTAL RESULTS

These experimental test results show the positive standard lightning impulse (LI) U₅₀ insulation strength of various gas mixtures. The LI U₅₀ test results for the Ringmaster switch disconnector at 0.35 bar (g) are shown in Table 4 and the percentage of gas breakdowns are shown in Figure 6. It was shown that when the gas mixture insulation strength was higher than what the equipment can withstand, only equipment flashovers were recorded. In Table 4, the U₅₀ results which are predominantly gas breakdowns are shown as shaded cells, non-shaded cells represent U₅₀ results, where predominantly equipment flashovers were recorded. In Figure 6, the percentage of gas breakdown and equipment flashover are shown for all gas mixtures at 0.35 bar (g). In Figure 7, the percentage of gas breakdown is shown for the Ringmaster LI U₅₀ tests at 0.35 bar (g) for each phase. From Figure 6 and Figure 7, it is clear that at 0.35 bar (g), the 30:70% CF₃I-CO₂ gas mixture and pure SF₆ are capable of insulating the equipment and so no gas breakdown events were recorded. In Figure 6, it is interesting to note that the majority of gas breakdowns occur on phases 1 and 2, indicating that equipment has a weaker air gap insulation surrounding phase 3. Also, as shown in Figure 6, on phase 3, there is a likely comparative insulation strength of each gas, with the best insulation showing fewer gas breakdowns. Phase 3 shows that 20:80% CF₃I-CO₂ is the strongest gas mixture after 30:70%, then 10:90% CF₃I-CO₂ then air and CO₂.

Table 4. Positive standard lightning impulse U₅₀ in the Ringmaster switch disconnector at 0.35 Bar (g).

Gas Mixture	Phase 1 (kV)	Phase 2 (kV)	Phase 3 (kV)	Average (kV)	Breakdown Description
100% SF ₆	120.59	126.44	121.87	122.97	Equipment Flashover
30-70% CF ₃ I-CO ₂	112.00	105.78	107.10	108.30	Equipment Flashover
	104.02	111.75	108.74	108.17	Phase 1 & 2 Predominantly Gas Breakdown, Phase 3 Equipment Flashover
20-80% CF ₃ I-CO ₂	116.44	113.40	111.95	113.93	Phase 1 & 2 Predominantly Gas Breakdown, Phase 3 Equipment Flashover
	101.51	109.32	100.89	103.90	Predominantly Gas Breakdown
100% CO ₂	101.51	109.32	100.89	103.90	Predominantly Gas Breakdown
100% Air	90.88	101.76	90.03	94.22	Predominantly Gas Breakdown

In Table 5, the LI U₅₀ insulation strength of each gas mixture is shown for a pressure of 0 bar (g) for the Ringmaster switch disconnector. In Table 5 and Figure 8, the majority of the recorded results are for gas breakdown and not equipment flashover. SF₆ was not tested at this pressure because of handling restrictions for this gas. As with the results for 0.35 bar (g), the percentage of gas breakdowns recorded in Figure 9 is fewer for phase 3 compared with the other phases. This is caused by the high percentage of external equipment flashovers on phase 3, indicating the air insulation surrounding this contact is weaker than the other phases. It is important to note that, for all the CF₃I-CO₂ gas mixtures tested at both pressures, the average U₅₀ insulation strength is above the SF₆ rated 95kV withstand strength of the switch disconnector.

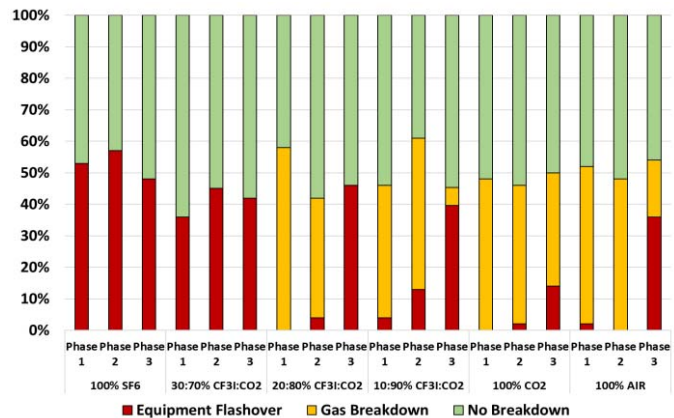

Figure 6. Percentage of gas breakdown and equipment flashover for Ringmaster LI U₅₀ tests at 0.35 bar (g).

The results for the LI U₅₀ insulation strength tests for the Fluokit switch disconnector at 0.45 bar (g) are shown in Table 6. The percentage of gas breakdowns and equipment flashovers for the Fluokit at 0.45 bar (g) is shown in Figure 10. Both Table 6

and Figure 10 show that the majority of events recorded are equipment flashovers and, therefore, demonstrate that the gas has an insulation strength above the U_{50} value presented. It is important to note that internal epoxy resin equipment flashovers were present for all tested gas mixtures. The only significant gas breakdown recorded is for pure CO_2 on phase 2, indicating that this gas has the weakest insulation strength.

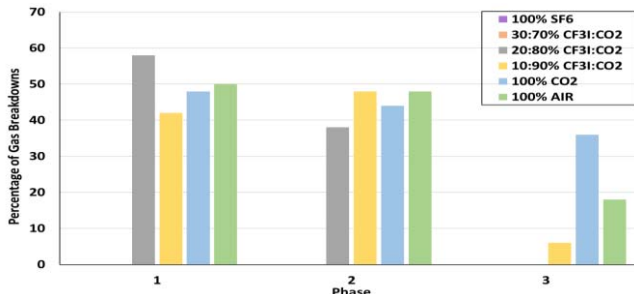

Figure 7. Percentage of gas breakdowns throughout Ringmaster LI U_{50} tests at 0.35 bar (g).

Table 5. Positive standard lightning impulse U_{50} in the Ringmaster switch disconnector at 0 Bar (g).

Gas Mixture	Phase 1 (kV)	Phase 2 (kV)	Phase 3 (kV)	Average (kV)	Breakdown Description
30:70% CF_3I-CO_2	103.99	105.62	96.79	102.13	Predominantly Gas Breakdown
20:80% CF_3I-CO_2	104.04	100.21	100.45	101.56	Predominantly Gas Breakdown
10:90% CF_3I-CO_2	109.22	88.20	102.79	100.07	Predominantly Gas Breakdown
100% CO_2	88.62	103.15	80.84	90.87	Predominantly Gas Breakdown
100% Air	79.58	90.06	84.45	84.69	Predominantly Gas Breakdown

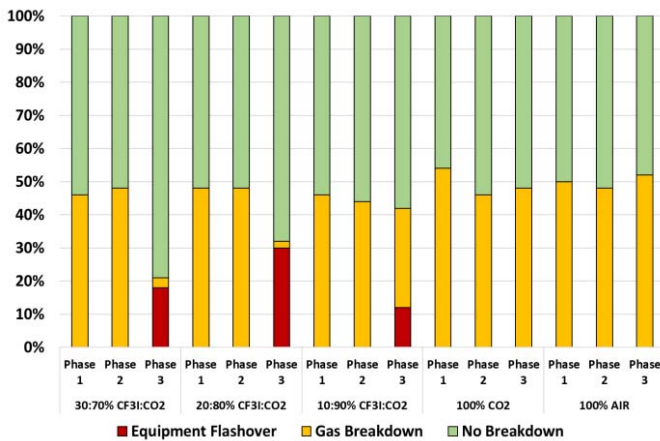

Figure 8. Percentage of gas breakdown and equipment flashover for Ringmaster LI U_{50} tests at 0 bar (g).

The results for the LI U_{50} insulation strength tests for the Fluokit at 0 bar (g) are shown in Table 7. It can be observed that the majority of the results are equipment flashovers and not gas breakdowns. This means that the U_{50} insulation strength of all of the CF_3I-CO_2 gas mixtures are actually higher than the values given. In Figure 11 and Figure 12, the percentage of gas breakdowns is shown, and it is clear

that the majority of gas breakdowns occur on phase 2. This indicates that the contact separation on phase 2 could be smaller than the other phases. Another reason could be that geometry or a surface defect on the contacts on phase 2 is affecting the uniformity of the electric field between the contacts, therefore, reducing the insulation strength of the insulating gas. It is important to note that this defect on phase 2 affects all gas mixtures, especially pure CO_2 , air and the 10:90% CF_3I-CO_2 gas mixture indicating that this gas mixture has the weakest insulation strength of all CF_3I gas mixtures tested. This is probably because of the high content of CO_2 in the 10:90% CF_3I-CO_2 gas mixture which reduces CF_3I 's insulating capabilities. All average U_{50} results recorded for all CF_3I-CO_2 gas mixtures is above the rated 125 kV withstand strength of the Fluokit switch disconnector.

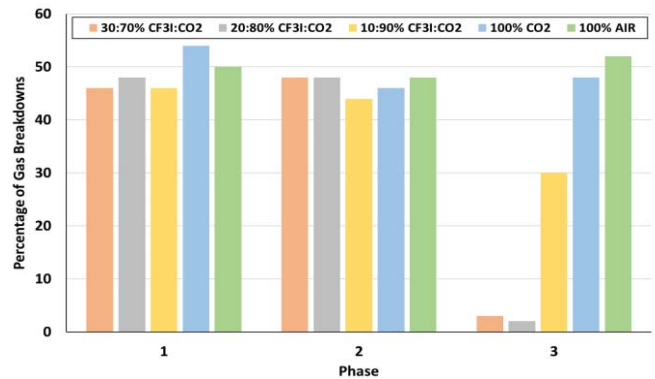

Figure 9. Percentage of gas breakdowns for Ringmaster LI U_{50} at 0 bar (g).

Table 6. Positive standard lightning impulse U_{50} in the Fluokit switch disconnector at 0.45 Bar (g).

Gas Mixture	Phase 1 (kV)	Phase 2 (kV)	Phase 3 (kV)	Average (kV)	Breakdown Description
100% SF_6	146.23	157.99	150.79	151.67	Air Breakdown
10:90% CF_3I-CO_2	145.11	153.01	138.02	145.38	Air Breakdown/Internal Epoxy Flashover
100% CO_2	107.59	139.81	118.35	121.92	Phase 1 & 3 Internal Epoxy Flashover, Phase 2 Gas Breakdown
100% Air	142.06	156.75	137.05	145.28	Air Breakdown/Internal Epoxy Flashover

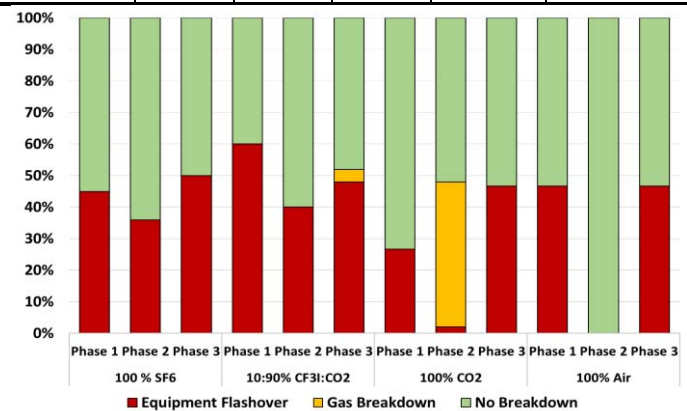

Figure 10. Percentage of gas breakdown and equipment flashover throughout Fluokit Lightning Impulse U_{50} Tests at 0.45 bar (g).

The results shown in Figure 13 are produced using all of the LI U₅₀ results from the Ringmaster and Fluokit, at both pressures. The results shown are affected by equipment flashovers. For both pressures of the Fluokit switch disconnector, the true LI U₅₀ results for all CF₃I-CO₂ gas mixtures are higher than the values shown. The same is true for the Ringmaster results at 30:70% CF₃I-CO₂ and 20:80% CF₃I-CO₂ at 0.35 bar (g) for which the LI U₅₀ shown should be higher if equipment flashovers had not occurred, hence the slight irregularity in these results. The most accurate representation of the LI U₅₀ results for all gases is shown in the Ringmaster results at 0 bar (g) for which there are very few equipment flashovers. These results show that, as the amount of CF₃I in the CF₃I-CO₂ gas mixture is reduced, the insulation strength of the gas mixture is also reduced.

Table 7. Positive standard lightning impulse U₅₀ in the Fluokit switch disconnector at 0 Bar (g).

Gas Mixture	Phase 1 (kV)	Phase 2 (kV)	Phase 3 (kV)	Average (kV)	Breakdown Description
30:70% CF ₃ I-CO ₂	143.66	134.33	132.27	136.75	Air Breakdown/Internal Epoxy Flashover
20:80% CF ₃ I-CO ₂	137.36	140.18	143.86	140.47	Air Breakdown
10:90% CF ₃ I-CO ₂	121.78	154.65	129.54	135.33	Phase 1 & 3 Internal Epoxy Flashover, Phase 2 Gas BD & Equipment Flashover
100% CO ₂	124.55	121.43	102.99	116.32	Phase 1 & 3 Internal Epoxy Flashover, Phase 2 Gas BD & Equipment Flashover
100% Air	136.32	130.07	118.99	128.46	Phase 1 & 3 Internal Epoxy Flashover, Phase 2 Gas BD & Equipment Flashover

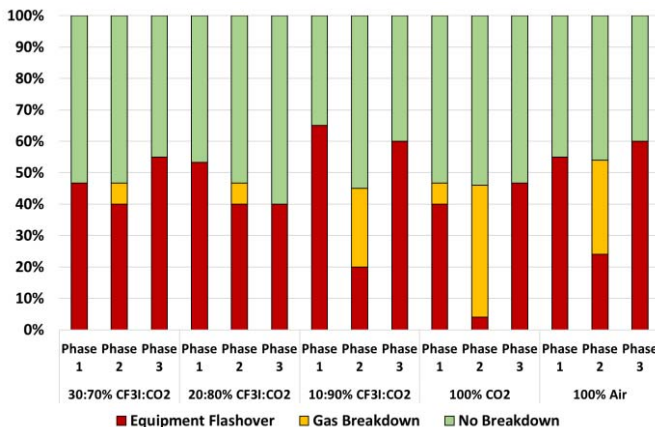

Figure 11. Percentage of gas breakdown and equipment flashover throughout Fluokit Lightning Impulse U₅₀ Tests at 0 bar (g).

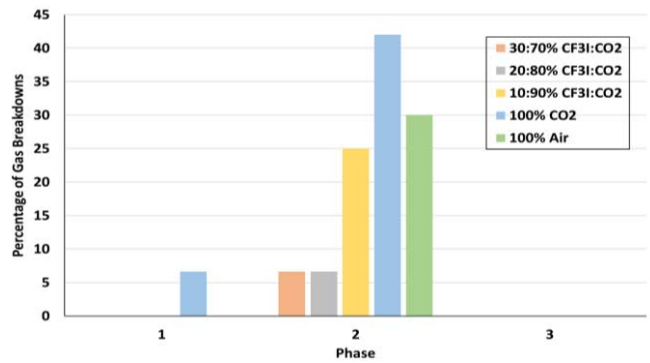

Figure 12. Percentage of gas breakdowns for Fluokit LI U₅₀ tests at 0 bar (g).

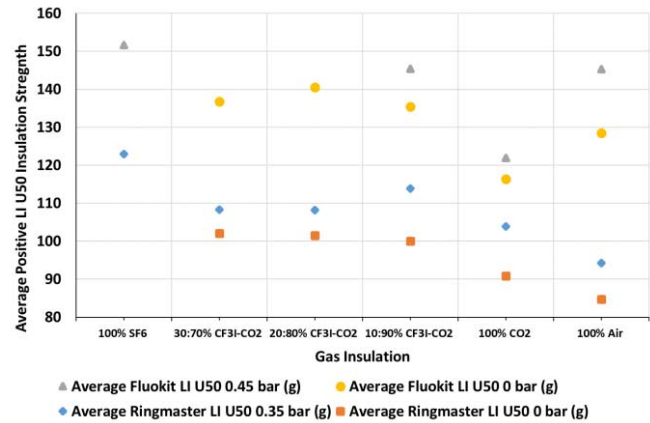

Figure 13. Average positive LI U₅₀ voltages of all three phases using the Ringmaster and Fluokit switch disconnectors.

5 DISCUSSION

The average positive standard LI (U₅₀) insulation strength tests from section III for the Ringmaster switch disconnector along with the results of the 95 kV withstand test from section IV are shown in Figure 14. It can be seen from the figure that the correlation between the two sets of results and the fact that, if the gas breakdown voltage is only marginally above the 95 kV threshold, then the results are recorded as an insulation test failure for the Ringmaster. The results also indicate that if the breakdown strength (U₅₀) of the gas is sufficiently high, then the gas will pass the standard 95 kV withstand voltage test. The opposite is true if the gas mixture has a breakdown strength that is sufficiently low, then it will fail the standard 95 kV withstand voltage test in the Ringmaster. From Figure 14, it can be deduced that all CF₃I-CO₂ gas mixtures have a sufficient breakdown strength to insulate the Ringmaster at 0.35 bar (g). However, failure is much more likely at 0 bar (g). Therefore, a rise in the minimum operating pressure would be required to insulate this switch disconnector with a CF₃I-CO₂ gas mixture.

The average positive standard LI (U₅₀) insulation strength tests for the Fluokit switch disconnector along with the results of the 125 kV withstand tests are shown in Figure 15, where it can be seen that there is a good correlation between the results except for 100% CO₂ at 0.45 bar (g) which has a lower positive LI U₅₀ insulation strength compared with the standard 125 kV but passes the withstand test. This is because the unit suffered

from a large amount of internal epoxy resin flashovers which reduced the recorded value of the insulation strength shown here but did not affect the true insulation strength of the gas. 100% CO₂ is deemed the only gas unsuitable for use in the Fluokit switch disconnector as it did not pass the 125 kV standard withstand test at 0 bar (g) for insulation purposes only.

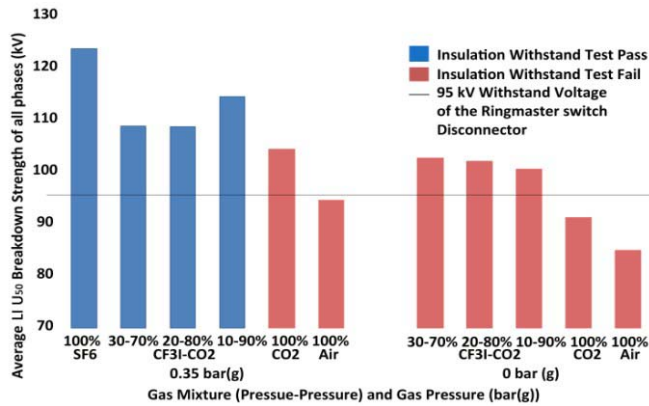

Figure 14. Average positive standard lightning impulse U₅₀ insulation strength and 95 kV withstand test results of various gas mixtures in the Ringmaster switch disconnector.

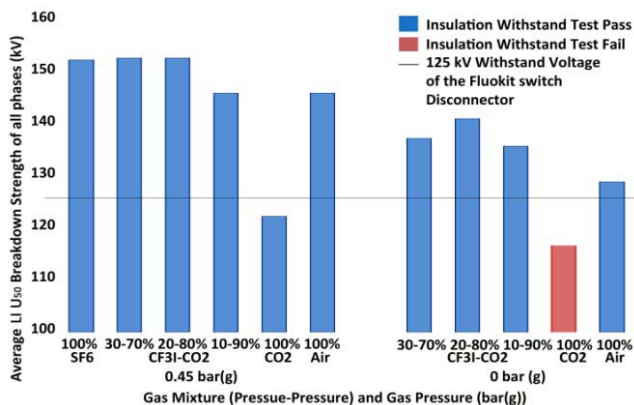

Figure 15. Average positive standard lightning impulse U₅₀ insulation strength and 125 kV withstand test results of various gas mixtures in the Fluokit switch disconnector.

6 CONCLUSION

This paper demonstrates the use of CF₃I-CO₂ gas mixtures as an insulation medium for complex contact geometry found in practical MV switch disconnectors. The tests conducted indicate that gas mixtures of CF₃I-CO₂ could become a promising alternative to SF₆ in the future as a purely insulating gas. The practical experiments undertaken demonstrate for the first time CF₃I-CO₂ gas mixtures can successfully insulate MV switch disconnectors at their rated lightning impulse withstand voltage at the rated filling pressure.

Future work will investigate the long term properties of the gas mixtures and whether they have any detrimental effects on the switchgear and its constituent materials. Work will also explore whether a solution can be found that would allow CF₃I-CO₂ gas mixtures to operate successfully and break high current magnitudes without initiating deterioration to the insulation performance of the gas or equipment.

ACKNOWLEDGMENT

The authors wish to thank the IET Power Networks Research Academy for the PhD scholarship under which this work was undertaken. Also thanks to UK Power Networks and Schneider Electric for their practical support throughout the project.

REFERENCES

- [1] M.S. Kamarudin, M. Albano, P. Coventry, N. Harid and A. Haddad, "A survey on the potential of CF₃I gas as an alternative for SF₆ in high voltage applications", 45th Int'l. Universities' Power Engineering Conf. (UPEC), Cardiff University, Wales, UK, 2010.
- [2] M. Taki, D. Maekawa, H. Odaka, H. Mizoguchi and S. Yanabu. "Interruption Capability of CF₃I Gas as a substitution Candidate for SF₆ Gas", IEEE Trans. Dielectr. Electr. Insul., Vol. 14, No. 2, pp. 341-346, 2007.
- [3] T. Takeda, S. Matsuoka, A. Kumada and K. Hidaka, "Insulation performance of CF₃I and its by-products by spark-over discharge", Int'l. Conf. Electr. Eng., Paper O-142 (ICEE), Okinawa, Japan, 2008.
- [4] P. Widger, L. Chen and A. Haddad, "Deposited By-Products of CF₃I-CO₂ Gas Mixtures after Lightning Impulse Flashover", Universities' Power Eng. Conf. (UPEC), Portugal, 2016.
- [5] H. Kasuya, H. Katagiri, Y. Kawamura, D. Saruhashi, Y. Nakamura, H. Mizoguchi and S. Yanabu, "Measurement of decomposed gas density of CF₃I-CO₂ mixture", 16th Int'l. Sympos. High Voltage Eng. (ISH), Cape Town, South Africa, pp. 744-747, 2009.
- [6] P. Widger and A. Haddad, "Gaseous by-products of a CF₃I-CO₂ gas mixture under lightning impulse and AC breakdowns", 20th Int'l. Sympos. High Voltage Eng. (ISH), Buenos Aires, Argentina, 2017.
- [7] M. Kamarol M. Jamil, S. Ohtsuka, M. Hikita, H. Saitoh and M. Sakiki "Gas by-products of CF₃I under AC partial discharge", Elsevier, J. Electrostatics, Vol. 69, pp. 611-617, 2011.
- [8] H. Katagiri, H. Kasuya, H. Mizoguchi and S. Yanabu, "Investigation of the Performance of CF₃I Gas as a Possible Substitute for SF₆", IEEE Trans. Dielectr. Electr. Insul., Vol. 15, No. 5, pp. 1424-1429, 2008.
- [9] M.S. Kamarudin, L. Chen, P. Widger, K.H. Elnaddab, M. Albano, H. Griffiths and A. Haddad. "CF₃I Gas and Its Mixtures: Potential for Electrical Insulation". Cigre Session 45, Paris, France, 2014.
- [10] M.S. Kamarudin, A. Haddad and S.J. MacGregor, "Experimental investigation of CF₃I-CO₂ gas mixtures under lightning impulses", 20th Int'l. Conf. Gas Discharges and their Applications, Orléans, France, 2014.
- [11] P. Widger, A. Haddad and H. Griffiths, "Breakdown performance of vacuum circuit breakers using alternative CF₃I-CO₂ insulation gas mixture", IEEE Trans. Dielectr. Electr. Insul., Vol. 23, No. 1, pp. 14-21, 2016.
- [12] L. Chen, P. Widger, M.S. Kamarudin, H. Griffiths and A. Haddad. "CF₃I Gas Mixtures: Breakdown Characteristics and Potential for Electrical Insulation", IEEE Trans. Power Delivery, Vol. 32, No. 2, pp. 1089-1097, 2017.
- [13] L. Chen, P. Widger, C. Tateyama, A. Kumada, H. Griffiths, K. Hidaka, A. Haddad. "Breakdown Characteristics of CF₃I/CO₂ Gas Mixtures Under Fast Impulse in Rod-Plane and GIS Geometries", 19th Int'l. Sympos. High Voltage Engineering (ISH), Pilsen, Czech Republic, 2015.
- [14] Schneider Electric. (2012). "MV Distribution Catalogue: Ringmaster Indoor/outdoor secondary distribution switchgear", Schneider Electric. [Online]. [Cited 20 September 2013] Available: <http://www.schneider-electric.co.uk/sites/uk/en/products-services/mv-distribution-energy-automation/products-offer/medium-voltage-secondary-distribution-products/ring-main-unit/ringmaster-range.page#>
- [15] Schneider Electric. (2011). "Technical Characteristics Catalogue: Fluokit Air insulated switchgear up to 24 kV", Schneider Electric. [Online]. [Cited 20 September 2013] Available: <http://www.schneider-electric.com/products/ww/en/3500-mv-switchgear/3520-air-insulated-switchgear-for-secondary-distribution/60704-fluokit-m-24kv/?xtmc=fluokit%2520m24%252B&xtcr=1>
- [16] *High-voltage switchgear and controlgear – Part 1: Common specifications*, British Standard BS62271-1, Chp 5.15.3: pp. 5 and Chp 6.2.4: pp. 61, 2008.
- [17] *High-voltage test techniques – Part 1: General definitions and test requirements*. British Standard BS60060-1, Chp 7.2.1: pp. 33 and Chp 7.3.1.4: pp. 36, 2010.



distribution and transmission networks.

P. Widger received the Ph.D. and B.Eng. degrees in electrical and electronic engineering from Cardiff University, UK in 2014 and 2010 respectively. Between 2010 and 2014, he worked towards his Ph.D. degree in the Advanced High Voltage Engineering Research Centre at Cardiff University, Institute of Energy, School of Engineering. His research is focused on alternatives gases to SF₆, specialising in gas mixtures of CF₃I, for use in



His research interests include earthing systems and transients. He is currently a member of BSI PEL/99, chair of BSI GEL/600, a member of CENELEC TC99X WG1, and TC99/MT4-IEC 61936 He is a chartered engineer and a member of IET.

H. Griffiths obtained a B.Sc. degree from the Polytechnic of Wales and a Ph.D. degree from Cardiff University. Between 1983 and 1990, he worked at the South Wales Electricity Board and the Central Electricity Generating Board as an engineer in distribution and transmission system design. In 1990, he was appointed to the lecturing staff at Cardiff University. He is currently Reader in the High Voltage Energy Systems Group.



He is a member of CIGRE working groups and a member of BSI PEL1/2, IEC TC37. He serves on the scientific committees of several international conferences. He is a Fellow of the IET and Learned Society of Wales.

Haddad (M'13) obtained a first degree in electrical engineering in 1985 and then a Ph.D., degree in High Voltage Engineering in 1990. He is now a Professor in electrical engineering at Cardiff University, with responsibility for research in High Voltage Engineering. His research interests are in overvoltage protection, insulation systems, insulation coordination and earthing of electrical energy systems. He has published an IET-

Power Series Book on "Advances in High Voltage Engineering". He is a member of CIGRE working groups and a member of BSI PEL1/2, IEC TC37. He serves on the scientific committees of several international conferences. He is a Fellow of the IET and Learned Society of Wales.