



Using high-throughput sequencing to track habitat use by thrushes exploiting heterogeneous farmland landscapes.

Jennifer Elizabeth Stockdale, BSc. (Hons), MRes.

Submitted in accordance with the requirements to Cardiff University for the degree of

Doctor of Philosophy

November 2018.

For Dad, Ali, my late Mum, Will and Aaron.

'Until you spread your wings you will have no idea how far you can fly'

Anon

Summary:

Agricultural intensification can affect farmland birds by altering prey availability and reducing the distribution, visibility and/or accessibility of key invertebrate resources. A novel environmental genomics approach was used to track habitat use by thrushes exploiting different habitat elements for food within two contrasting farmland landscapes; a complex landscape in South Wales and a relatively simple landscape in East Anglia. The spatial variation, relative abundance and diversity of ground dwelling invertebrates was determined across different landscape elements, which revealed the links between habitat complexity and prey availability (Chapter 2). A comprehensive examination of suitable COI primer pairs was conducted (Chapter 3), in order to determine the full dietary breadth of farmland thrushes, using a metabarcoding high-throughput sequencing approach (Chapter 4). Application of this approach revealed variation in diet and nestling growth related to spatial factors (between-farm and within-farm location) and temporal factors (between-year and seasonal), as well as substantial overlap in diet between Blackbirds and Song Thrushes (Chapter 4). Comparisons of the relative abundance of different prey taxa in farmland habitats (described in Chapter 2), with the occurrence of prey in the diet of Blackbirds and Song Thrushes, indicated strong preferences for or against particular prey taxa available in the landscape (Chapter 5). The selection by thrushes of prey taxa that are habitat specialists allowed the use of different parts of the farm landscape by foraging thrushes to be deduced. These results together show that a fine-scale mosaic of agricultural elements provides birds with redundancy in terms of the abundance and diversity of suitable prey items to exploit. This novel study provides a model for using high-throughput sequencing to measure trophic relationships, via habitat-linked food webs, to understand the mechanisms which underlie foraging decisions and habitat use in thrushes and the consequences for breeding productivity, nestling growth and condition.

Acknowledgements:

The work presented here was funded by a NERC CASE studentship in conjunction with the British Trust for Ornithology (BTO) grant number NE/J016772/1. Additional funding was provided by NERC Biomolecular Analysis Facility at the University of Sheffield (NBAF-S) for sequencing (NBAF981) and Eco-Explore (Community Interest Company).

First and foremost, I would like to thank my Cardiff supervisors Professor Bill Symondson and Dr Rob Thomas for their continuous advice, invaluable support, endless reassurance and constructive feedback. Thank you for providing the structure I needed when times were so exceptionally hard and for wholeheartedly believing in my ability as a researcher. Secondly, I am incredibly grateful to my external supervisor Dr Gavin Siriwardena for his guidance, invaluable experience and knowledge of farmland birds and for making me feel so welcome during my BTO placement. I am also indebted to Jenny Dunn and Jez Smith. Thank you for listening, many a helpful discussion, guidance with statistical techniques and previous drafts, much needed coffee breaks, keeping me 'sane' and for being there for me no matter what.

Especial thanks to the many people who assisted with the collection and processing of data presented in this thesis. Notably, Alex McCubbin and Jordan Cuff who worked tirelessly to help find and monitor nests, had never ending enthusiasm for digging pitfall traps and excelled at invertebrate identification. It's thanks to Jordan and Vince Lee I have data from Hildersham at all. Alex and Jordan also collected the Wenvoe earthworm and slug data as part of their undergraduate final year projects. I'd also particularly like to thank Alex, Beatrix Felgueiras and Kirsty Franklin for their assistance within the lab. Stephen Vickers provided much needed guidance and assistance with statistical techniques. Kirsty also provided much needed assistance in data entry and processing. Lastly, without the unremitting support, encouragement, field assistance and continual supply of 'wardrobe' chocolate from Emma Bradford, especially during my initial 24 months, I wouldn't have completed this journey.

Thanks to Mr Robert Reader of Burden's Farm, Wenvoe, and Mr Stephen Franklin of Lay Rectory Farm, Hildersham for providing permission to conduct fieldwork on their farms.

My friends and colleagues within the Molecular Ecology Group (C5.15), thank you for the interesting discussions, laughs and a continual supply of cake. To Renata Medeiros Mirra, Isa Rita Russo, Mafalda Costa, Hannah MacDonald, Josie D'Urban-Jackson and the many other people within the office - thank you for making my time in Cardiff so enjoyable.

Finally, last but by no means least, I want to thank my family and my husband Will for their unstinting support, for providing a life beyond my PhD and for helping me to succeed.

Table of Contents:

Declaration:	ii
Dedication:	iii
Summary:	iv
Acknowledgements:	v
Table of Contents:	vii
CHAPTER 1: Introduction:	10
1.1 Agricultural intensification and habitat heterogeneity:	14
1.1.1 Invertebrate availability:	16
1.2.1 Direct and indirect effects:	18
1.3.1 Mitigating the effects of environmental change:	19
1.2 Trophic interactions:.....	20
1.3 Gaps in knowledge:	23
1.4 Study species:	24
1.5 Core hypotheses:	27
1.6 Chapter organisation:	28
CHAPTER 2: Invertebrate abundance:	30
2.1 Introduction:.....	31
2.2 Methods:.....	35
2.2.1 Farm and landscape comparisons:.....	35
2.2.2 Invertebrate assessments:	38
2.2.2.1 Earthworms:	39
2.2.2.2 Molluscs:.....	40
2.2.2.3 Pitfalls:	40
2.2.2.4 Vacuum samples.....	41
2.2.3 Statistical analyses:	42
2.3 Results:.....	43
2.3.1 Farm and landscape comparisons:.....	43

2.3.2	Spatial variation in invertebrate abundance and species richness:.....	44
2.3.2.1	Earthworms:	44
2.3.2.2	Molluscs:.....	47
2.3.2.3	Pitfalls:	51
2.4	Discussion:	59
2.5	Supplementary material	66
	68
CHAPTER 3: Primer evaluation:		74
3.1	Introduction:.....	75
3.2	Methods:.....	84
3.2.1	Finding universal primers:.....	84
3.2.2	In silico evaluation:.....	86
3.2.3	In vitro evaluation:	87
3.3	Results:.....	89
3.4	Discussion	99
3.5	Acknowledgements:	103
3.6	Supplementary material:	104
CHAPTER 4: Diet of Thrushes:.....		106
4.1	Introduction:.....	107
4.2	Methods:.....	111
4.2.1	Sites and faecal sample collection	111
4.2.2	Laboratory analysis of faecal samples.....	112
4.2.3	Bioinformatics:	114
4.2.4	Statistical analysis:.....	116
4.2.4.1	Rarefaction analysis:.....	116
4.2.4.2	Nestling growth:	116
4.2.4.3	Dietary breadth, overlap and temporal variation:	117
4.2.4.4	Associations between diet, nestling age and condition:.....	118
4.2.4.5	Dietary breadth and overlap of adults and nestlings.....	118
4.3	Results:.....	119
4.3.1	Overall High-Throughput Sequencing results:	119

4.3.2	Rarefaction analysis:	120
4.3.3	Nestling growth: Generalised Additive Mixed Model (GAMM) analysis:	122
4.3.4	Number of MOTUs:	125
4.3.5	Dietary breadth, overlap and spatio-temporal variation:.....	126
4.3.6	Associations between dietary composition and nestling body condition:	128
4.4	Discussion:	131
CHAPTER 5: Habitat associations:.....		135
5.1	Introduction:.....	136
5.2	Methods:.....	140
5.2.1	Dietary Preference Analysis:	140
5.2.2	Habitat Specific Prey Methods:	141
5.2.3	Analysis of spatial and temporal variation in diet:.....	142
5.3	Results:.....	143
5.3.2	Habitat specificity of invertebrate taxa:.....	149
5.3.3	Multivariate analyses of spatio-temporal variation in thrush diet:	151
5.4	Discussion:	158
CHAPTER 6: General Discussion:.....		165
6.1	Considerations:	169
6.2	Environmental change:	170
6.3	Implications for findings at a local/regional and national scale:.....	171
6.4	Future directions:	171
6.5	Does it matter? The consequences of the research for the discipline:.....	172
References:		174

CHAPTER 1: Introduction:



“We can't solve problems by using the same kind of thinking we used when we created them.”

Albert Einstein

Across the United Kingdom (UK), farmland is the dominant habitat type with an overall utilised agricultural area of 17.4 million hectares, accounting for 71% of the total land cover and contributing £8,196 million to the Gross Domestic Product for 2016 (DEFRA 2017a). Farmland is diverse, comprising a wide range of different land uses, including arable and horticultural crops, temporary and permanent grassland, common rough grazing and uncropped arable land. Agricultural intensification, in part driven by the Common Agricultural Policy (CAP) and agricultural practices intended to boost productivity, has impacted habitat heterogeneity at multiple spatial scales and led to a widespread decline in farmland biodiversity and abundance in recent decades (Benton *et al.* 2003). Wildlife population declines associated with agricultural intensification impact multiple taxa, with the majority of negatively affected taxa being habitat specialists (Siriwardena *et al.* 1998; Robinson and Sutherland 2002).

An assessment of 1,064 farmland species, for which trends are available within the recent State of Nature Report, found that 60% of species have decreased and 34% have decreased strongly (Burns *et al.* 2013). The decline in UK farmland bird populations, since the 1970s, is greater than those in any other habitat, and the farmland bird indicator¹ value is currently around 45% of the 1970 baseline value (DEFRA 2017b). Reduction in biodiversity at one trophic level can have a pronounced impact on biodiversity further along the food chain (e.g. Haddad *et al.* 2009, highlighted how a reduction in plant species decreases arthropod diversity). Cascading effects of pesticides can cause population level declines of farmland bird species through reduced invertebrate availability during the breeding season (Hallmann *et al.* 2014). Furthermore, the effects of land use change on biodiversity might currently be seriously underestimated as the reaction of many plant and animal populations lag behind contemporary environmental degradation (Dullinger *et al.* 2013).

Birds are viewed as important bio-indicators of environmental change as they are sensitive to broad scale changes, as surrogates for variations in other less readily-monitored wildlife, and as important barometers of environmental quality and the functional health of farmland ecosystems (Padoa-Schioppa *et al.* 2006; Renwick *et al.* 2012). Thus, these reported declines

¹ The UK Farmland bird indicator is based on combined population trends for 19 bird species that are dependent on farmland and not able to thrive in other habitats.

are a major conservation concern (Whelan *et al.* 2015), as birds experience contractions in range (Donald and Greenwood 2001) and reductions in abundance that can lead to local extinctions (Chamberlain and Fuller 2000).

Farmland provides a suitable and important habitat in which to understand the role that the heterogeneity of landscape structure, vegetation, and invertebrates play in determining bird abundance generally, both at the landscape scale and at a smaller scale, for example, at the field scale (Pickett and Siriwardena 2011). Heterogeneous, complex farming landscapes contain many different commercially-grown crops, interspersed with natural vegetation and field boundaries. Across a landscape, mixed crop and livestock systems provide spatially intricate mixes of tillage and grassland, as cropping systems usually revolve around forage or feed requirements of livestock (Ryschawy *et al.* 2012). In contrast, simple farming landscapes contain only a small number of crop types distributed in large and relatively uniform fields (Baudry and Bunce 1991; Tschardtke *et al.* 2005; Sirami *et al.* 2007). Many bird species require a diversity of resources over spatial and temporal gradients to provide sufficient foraging habitats and suitable nest sites within reach of these foraging areas. This reliance on suitable foraging resources makes them directly sensitive to any changes in the trophic levels below them. A decrease in habitat heterogeneity may also play a part in reducing the diversity, availability and accessibility of insects to foraging birds (Vickery *et al.* 2001; McCracken and Tallwin 2004), and hence fail to provide all their nutritional requirements (Southwood and Cross 2002).

Dietary studies are essential in understanding the full spectrum of the trophic ecology of a species, and the impact of variations in both quality and quantity of potential prey across a breeding season on diet composition (Naef-Daenzer *et al.* 2000). In recent years, there has been considerable development in both the methodology and application of novel dietary tracing methods, as the advent of biomarker and molecular based approaches has enhanced the precision of diet composition estimates (Pompanon *et al.* 2012; Nielsen *et al.* 2017). These novel molecular methods consistently outperform the more traditional morphological studies of prey remains in their ability to identify and quantify dietary components (Traugott *et al.* 2013), but they have their own sampling issues.

In this study, a novel environmental genomics approach is used to analyse and compare the diets of adult and nestling thrush species in simple and complex farmland landscapes. Birds and their invertebrate trophic resources provide a tractable and informative model for understanding the relationships between habitat heterogeneity, foraging behaviour, and the trophic connections between the birds and different landscape elements (e.g. hedgerows, field margins, crops).

This project will consider Blackbirds *Turdus merula* and Song Thrushes *Turdus philomelos*. The behaviour and ecology of these species is generally well understood; they are mobile, nests are relatively easy to find and not too sensitive to disturbance, good data exists on their demography and populations at a national scale, and they are able to respond rapidly to changes in their environment (Furness *et al.* 1993; Gregory and Van Strien 2010). In light of the importance of trophic relationships in influencing demographic change (Metcalf and Monaghan 2001), further insights into the trophic mechanisms driving habitat exploitation may be revealed by considering the availability of prey species within different habitat elements, as well as the dietary preferences of the focal species itself. The dietary composition and optimal prey selection by birds may reflect both the overall availability and local distribution of key invertebrate resources across heterogeneous landscapes.

Firstly, the study examines the spatial variation and availability of invertebrate prey groups across differing landscape elements within farms of differing complexity (Chapter 2). Secondly, the suitability of known ‘universal’ cytochrome oxidase COI primers are evaluated (Chapter 3) to ensure suitability for their subsequent application for characterising invertebrate dietary preferences of farmland thrushes (Chapter 4). Compositional changes in the diet of nestling Blackbirds and Song Thrushes in relation to age, condition and the availability of key invertebrate prey are investigated, to identify the importance of different landscape elements (or mixtures of such components) to the nestling provisioning and breeding productivity of farmland birds (Chapters 4 and 5). Finally, several detailed nest level case study examples are provided which use null models to analyse the structure of trophic relationships and identify habitat-linked resource selection.

The aim of this introductory Chapter is four fold: (1) to review and summarise the current literature on the impacts that changes in agricultural practice and landscape heterogeneity have on invertebrate prey populations, and the trophic mechanisms underlying the direct and indirect effects of these changes on birds; (2) to present a review of methods used in dietary analysis; (3) to introduce the study species, and (4) to provide the justification and organisation of the research described in this thesis. This chapter focuses on temperate and lowland farmland as these are the systems most relevant to the research presented. A further caveat is the emphasis on the importance of heterogeneity in the context of requirements of individual species, rather than farmland bird communities as a whole. Finally, I will outline the principal objectives of this thesis and the hypotheses to be addressed in the individual data chapters.

1.1 Agricultural intensification and habitat heterogeneity:

The Common Agricultural Policy (CAP), created in 1962, was a significant factor driving the intensification of farming, as subsidies and guaranteed prices drove higher levels of production (Donald *et al.* 2001; Pe'er *et al.* 2014; Reif and Vermouzek 2018). Concurrent declines in farmland biodiversity due to agricultural intensification were recorded across Europe (e.g. Siriwardena *et al.* 1998; Donald *et al.* 2001; Wretenberg *et al.* 2006; Reif *et al.* 2008; Baldi and Batary 2011). Furthermore, accession to the European Union and uptake of the CAP was associated with a marked increase in agricultural intensity, significant deterioration of farmland biodiversity (Donald *et al.* 2002) and steep declines of farmland bird populations (E.g: Poland: Kujawa 2002; Czechia: Reif and Vermouzek 2018).

The resulting loss of farmland habitat heterogeneity at multiple spatial scales has been a profound driver of declines in biodiversity (Benton *et al.* 2003; but see Batary *et al.* 2011). Complex natural ecosystems have been converted to simplified managed landscapes through the intensification of resource use and increased application of fertilisers and pesticides on a local and landscape scale (Tschardtke *et al.* 2005). At the national scale, an east-west polarisation of farming practice has occurred within the UK, involving a loss of land use diversity, as arable farming increasingly dominates in the east, contrasting with the retention of the more heterogeneous mixture of habitats associated with livestock grazing in the west

(Robinson *et al.* 2001, Boatman *et al.* 2007). Within regions of the British Isles (e.g. East Anglia), the diversity of cropping regimes has declined across farms and mixed livestock and arable farming systems have largely disappeared, resulting in greatly simplified landscapes (Pickett and Siriwardena 2011). These patterns are continuing to change, however; for example, since 2008 the area of arable land within Wales has doubled, to 16% (Statistics for Wales 2015).

Agricultural intensification is a key cause of the population declines shown by many farmland bird species over the last four decades (Wilson *et al.* 1997; Donald *et al.* 2001; Tschardtke *et al.* 2005; Jerrentrup *et al.* 2017). Specific causes of declines differ between species, but the three key drivers of these declines as a consequence of intensification are (1) habitat loss, including a decrease in the availability of suitable nest sites, (2) a reduction in summer invertebrate availability, and (3) decreased availability of seed food in winter (Wilson *et al.* 2009). Seed-eating species have shown some of the largest/steepest population declines (Fuller *et al.* 1995), but most of these species also rely on invertebrates as a source of high-protein nestling food during the breeding season, when insects also form part of their diet (Baillie *et al.* 1997). In general, the greater the diversity of habitat elements that a farmed landscape contains through mixed management practices, the wider the range of trophic resources on offer to predators (Heikkinen *et al.* 2004). At the farm scale, habitat heterogeneity is crucial to bird populations during the winter (Siriwardena *et al.* 2000) and is associated with increased adult productivity during the summer (Anderson *et al.* 2002; Berg 2008). On a finer scale, increasing agricultural intensification has resulted in the reduction of within-field diversity of vegetation, resulting in spatial and structural uniformity over arable landscapes (Altieri 1999; Benton *et al.* 2003) lessening the abundance, accessibility and detectability of potential invertebrate prey for farmland birds (Vickery *et al.* 2001). Many aspects of agricultural intensification are intrinsically interlinked (e.g. removal of hedgerows combined with increased use of fertilisers and pesticides), and commonly interact, resulting in a decrease in habitat heterogeneity across a range of spatial scales.

The two main components of landscape heterogeneity explicitly recognised are (i) composition (variety in different cover types), and (ii) configuration (complex spatial patterning of resources) (Duelli 1997; Fahrig *et al.* 2011). Several studies have considered the

mechanisms by which landscape heterogeneity might impact multiple species in a community (e.g. Birds: Hiron *et al.* 2015; Jeliaskov *et al.* 2016; Invertebrates: Fox 2013; Bertrand *et al.* 2016). Landscape-scale processes are critical in understanding how environmental change may affect ecosystems. However, they are often taxon-specific and scale-dependent (e.g. Siriwardena *et al.* 2000; Weibull *et al.* 2003). The taxon-specific nature of the response may arise partly because an organism's response to environmental heterogeneity depends on its perception of the environment, and this perception may vary substantially between different taxa (Wiens 1989).

1.1.1 Invertebrate availability:

Despite being an essential food source for most farmland birds, data regarding the relative abundance and biomass of invertebrates in the most commonly grown arable crops is scarce (but see Douglas *et al.* 2010). The majority of invertebrate agro-ecology research is biased towards pest species of agricultural and horticultural concern; the use of natural biological control agents by predatory insects (Symondson *et al.* 2002); or focused on the response of individual species to management intensity at the field level. As pest species can cause considerable damage to crops, diminish their productivity, reduce profitability and cause significant economic losses. Research also focuses on the key ecosystem services provided by pollinators and their contribution to crop production (Klein *et al.* 2007).

Whilst not as extensively documented, the abundance and diversity of invertebrates in the farmed landscape has declined concurrently with farmland bird declines (e.g. Aebischer 1991; Sotherton and Self 2000; Wilson *et al.* 2009). For example, Aebischer (1991) estimated that invertebrate abundance in cereal fields had declined by approximately 75% since agrochemicals were introduced in the 1950s. The impact on farmland birds, and concurrent changes in abundance and diversity, are reported by Donald *et al.* (2001), who showed that an increase in cereal yield, which is closely related to agrochemical use, predicts over 30% of the decline in abundance of European farmland bird populations. The main cause of the declines is considered to be pesticide use (Carson 1962; Boatman *et al.* 2004; Hallmann *et al.* 2014). In recent years, although the total volume of pesticides applied has decreased, a concurrent increase in efficacy per unit volume has resulted in little change regarding the detrimental

biological impacts (Chiron *et al.* 2014). The reductions in invertebrate abundance due to pesticides are responsible for the population decline observed in Grey Partridge *Perdix perdix* (Sotherton *et al.* 1993), for which management including agri-environment options, such as conservation headlands, increases population sizes (Aebischer *et al.* 2005). Declines in invertebrate abundance have also led to reduced breeding success for other species (e.g. Yellowhammer *Emberiza citrinella*: Boatman *et al.* 2004; Morris *et al.* 2005; Hart *et al.* 2006); and Corn Bunting *Emberiza calandra*: Brickle *et al.* 2000). Other possible contributing factors responsible for the decrease in invertebrate detectability and accessibility are specialisation of farming, increased drainage of farmland, changes in the timing and depth of ploughing, decreased “under-sowing” of one crop with another, uniformity of sward structure, and a reduction in the area of uncultivated field margins (Wilson *et al.* 1999; Sotherton and Self 2000; Vickery *et al.* 2001).

Invertebrate taxa often have differential responses to agricultural intensification depending on their life history traits, mobility patterns and which parameters of landscape structure or intensification they are sensitive to (Benton *et al.* 2002). A time lag in the response of invertebrate assemblages to past environmental conditions may also occur (Alignier and Aviron 2017). Earthworms are affected by physical, mechanical disturbance of arable land through tillage and ploughing which has been shown to halve population sizes in a matter of years (Edwards and Lofty 1977) and reduce biomass and biodiversity (Briones and Schmidt 2017). However, chemical input onto farmland is often viewed as a greater threat (Edwards and Bohlen 1966), as they alter individual earthworm behaviour such as feeding rate, increase individual mortality, stunt growth rates and reduce fecundity which all contribute to a reduction in the overall community biomass and density (Pelosi *et al.* 2014). Arthropod abundance and diversity reduce with habitat simplicity, as they require access to suitable overwintering habitats in adjacent non-crop areas. (Sotherton 1984). The mean body size of carabid beetles has also been shown to decrease along a gradient of agricultural intensification (Hanson *et al.* 2016). Exposure to pesticides have been associated with changes in bee behaviour reducing their foraging success (Henry *et al.* 2012) and reduction in colony growth and queen production (Whitehorn *et al.* 2012). Landscape structure and complexity is especially important for butterfly abundance and diversity (Weibull *et al.* 2000). Networks of

hedgerows provide food plants, vital transport corridors, territorial sites, and shade and shelter (Dover and Sparks 2000).

1.2.1 Direct and indirect effects:

Life-history theory predicts that trade-offs between reproductive and survival traits occur as a result of a finite availability of resources. Within the farmland study system, direct mechanisms of impact can be separated into summer effects during the breeding season, and over-winter effects during the non-breeding season. However, for this overview, direct winter effects such as over-winter food availability (Siriwardena *et al.* 2007) will not be considered further. Food availability is one of the most important environmental factors shaping developmental processes and a main determinant of reproductive success in animals influencing multiple behavioural and demographic mechanisms which affect population-level processes (Martin 1987). Thereby, impacting upon the reproductive decisions made by adult birds, through decisions about clutch and egg size, the number and timing of breeding attempts, and parental investment (Monaghan and Nager 1997; Nager *et al.* 1997; Wiebe and Bortolotti 1995; Török *et al.* 2004; Durant *et al.* 2005). Many bird species exhibit hatching asynchrony, thought to be a mechanism of clutch size optimisation in relation to available food resources (Magrath 1989). Adult breeding productivity is linked to foraging success in different foraging habitats (Anderson *et al.* 2002; Berg 2008) through a reduced parental work rate in habitats with higher foraging success and during periods of food abundance (Wernham and Bryant 1998). The composition and quality of food provided to nestling birds is critical for their growth and development. During early nestling development, the energy demands of growing nestlings increase considerably, and their growth requires changes in the amount and type of food provisioned by parents (e.g. Bowers *et al.* 2014; Orłowski *et al.* 2015). Conditions during early life can determine ageing patterns and life history strategies throughout the individual's lifespan, resulting in long-term consequences (Briga *et al.* 2017). However, the exact mechanisms through which resource availability affects survival and reproduction remain unclear, as food abundance interacts with other ecological indirect factors such as vigilance and perceived predation risk (Evans 2004; Dunn *et al.* 2010), greater local density of conspecifics (Dunn *et al.* 2015), increased exposure to disease (Stockdale *et al.* 2015), and compromised immune function (Hegemann *et al.* 2013).

1.3.1 *Mitigating the effects of environmental change:*

Reform of the CAP began in the 1980s breaking the link between subsidies and production and thus removing the artificial incentives to intensification. Further reforms, in 1999, attempted to reduce the negative environmental impacts of agricultural intensification by introducing voluntary agri-environment schemes (AES), financially rewarding farmers for implementing more wildlife-friendly farming methods to improve the ecological condition of farms (e.g. Kleijn *et al.* 2006; Davey *et al.* 2010; Pe'er *et al.* 2017). Jointly funded by the Common Agricultural Policy (CAP) and national governments, AES are conditional on specific management requirements with the overall management objective of restoring habitat heterogeneity and biodiversity. In England, many of the management options available aim to provide resources for farmland birds by improving habitat heterogeneity and creating or restoring habitats which provide nesting sites and invertebrate food for birds during the breeding season. At a field scale, options include the provision of beetle banks (grasses and herbs planted as habitat for invertebrates), buffer strips (uncultivated field margins), over-winter stubble (rather than ploughed-in stubble) and floristically enhanced margins (planted with seed-bearing herbs).

Evidence for the effectiveness of AES in conserving and promoting biodiversity has been highly inconsistent; depending on ecological contrast, landscape context and land use intensity (Kleijn *et al.* 2011); but see (Bright *et al.* 2015; Walker *et al.* 2018). AES appear to be most effective when they involve the deployment of bespoke conservation measures which create a high ecological contrast with the wider landscape, tailored to the requirements of individual range-restricted species (e.g. Corn Bunting *Emberiza calandra*; Perkins *et al.* 2011). Well-designed, targeted species-specific AES measures can also yield wider biodiversity benefits (e.g. Wilkinson *et al.* 2012). Environmental mitigation is a rapidly changing field, prone to swift shifts due to policy change, notably CAP reform (Pe'er *et al.* 2014; Gamero *et al.* 2017). In England, following reviews of the CAP and efficacy of AES, a revised agri-environment scheme called “Countryside Stewardship” was launched in 2015. However, the recent decision of the UK to pursue Brexit and leave the European Union represents a highly significant moment in agricultural and rural development policy,

triggering great uncertainty regarding the future of the Countryside Stewardship scheme and environmental incentives for farmers beyond 2020 (Whitfield and Marshall 2017).

1.2 Trophic interactions:

The nature of trophic interactions and their response to environmental change is a fundamental issue in ecology. Dietary studies provide vital data for understanding animal ecology, evolution and conservation (Symondson 2002; Krahn *et al.* 2007). The field has expanded from simple theoretical models of predator-prey interactions (e.g. Lotka-Volterra equations) and resource partitioning in ecological communities (Schoener 1974), to dynamic food web models (Williams and Martinez 2000), and empirically characterising trophic networks using DNA-based techniques (Traugott *et al.* 2013; Nielsen *et al.* 2017).

Traditionally, direct observation of feeding has been utilised to determine the diet of a suite of different animals (e.g. Impala *Aepycevos melampus*: Dunham 1980; Spotted Hyenas *Crocuta crocuta*: Henschel *et al.* 1990). This technique was also favoured to determine the diet of chicks at a nest site with the use of a hide (e.g. Guillemots *Uria aalge*: Birkhead 1977; Blackbirds: Chamberlain *et al.* 1999). However, whilst beneficial in some cases, direct observation generally fails to detect rare prey species, small invertebrates and many marine and soil fauna. Another classic technique is microscopic examination of faeces or morphological inspection of prey remains in a predator's stomach contents (Duffy and Jackson 1986). This technique also has major limitations due to the labour-intensive analysis, the skills necessary to identify remains, its potential to underestimate the importance of certain soft-bodied prey groups, or account for any differential gut passage rates of different prey groups (Holecheck *et al.* 1982).

More invasive techniques for studying avian diet include the use of neck ligatures on nestlings to temporarily prevent them swallowing food delivered by parents (e.g. Johnson *et al.* 1980, Little *et al.* 2009), or the flushing out of a bird's stomach (e.g. Hull 1999), which was used as an alternative to lethal-sampling to obtain stomach samples (e.g. Croxall *et al.* 1985). The use of neck ligatures, which often causes distress to both nestlings and the adults feeding them, can alter the feeding rate and behaviour of parent birds and often results in high

nestling mortality (Schnack 1991, Little *et al.* 2009). Neck ligatures are also limited in their usage, as they can only be deployed for a short period of time when nestlings are within a certain age range (Moreby and Stoate 2000). Stomach flushing through regurgitation is often performed through the forced intake of a saline solution (Gionfriddo 1995) or tartar emetic (Zduniak 2005). This method involves catching and handling animals and can often have adverse effects on the birds sampled and their offspring (Chiaradia 2003). Therefore, sample sizes are often restricted due to ethical considerations and limited to accessible colonial-nesting birds due to the operational constraints of the stomach-flushing method. Forced regurgitation studies can also be hindered by unidentifiable partially-digested remains and recovery biased by differential digestion or retention of prey items (e.g. King penguins *Aptenodytes patagonicus*: Gauthier-Clerc *et al.* 2000).

To overcome the problems of invasive techniques, molecular approaches have been developed, such as the use of prey-specific antibodies (reviewed by Symondson 2002), a protein electrophoretic approach (Walrant and Loreau 1995), and stable isotope studies (Bearhop *et al.* 2003, Inger and Bearhop 2008). All of these approaches encountered problems, such as being unable to measure the full breadth of the diet, account for the diet of more generalist species, provide a clear resolution of trophic links, or provide a precise identification of the contents of the last meal (Traugott *et al.* 2007; Pompanon *et al.* 2012). In recent years, DNA-based approaches have been utilised to provide a targeted approach to dietary analysis using polymerase chain reactions (PCR). Prey-specific PCR primers are designed to amplify the DNA of a limited number of taxa, making them valuable for studying predator-prey systems (reviewed by Symondson 2002; King *et al.* 2008). Furthermore, methodological improvements have increased the breadth of this dietary analysis through development of group-specific (or “general”) primers, allowing the amplification of the extracted DNA of multiple species, followed by cloning and the subsequent sequencing of amplicons allowing the identification of individual taxa (see Sutherland 2000; Deagle *et al.* 2007). The cloning approach allows the analysis of dietary composition without the need to predict target prey species and, with suitably general primers, the method can detect any dietary components that may be present, including soft-bodied prey items. Despite this, the barcoding approach is labour intensive, expensive, generates few sequences and is unsuitable for mass screening to determine the complete dietary breadth of species.

The high demand for low-cost sequencing methods has resulted in the development of high-throughput (or next-generation) sequencing technologies that allow millions of sequences to be generated through mass parallel sequencing. Amplicons must be compared to a curated reference library to identify sequences (e.g. GenBank, Barcode of Life Database (BOLD)), or a personally compiled database based on specimens previously recorded in the diet of the taxa of interest, as well as other potential prey species commonly found from the field sites (e.g. Dunn *et al.* 2018). High-throughput sequencing (HTS) diet assessment was first used by (Deagle *et al.* 2009) and allows the complete dietary breadth of species to be determined by providing precise taxonomic identification of prey items within highly diverse diets, including uncommon prey items and species never previously recorded as they leave no hard-parts in the faeces (Brown *et al.* 2012). Results can even be obtained from degraded faecal samples up to five days old (Oehm *et al.* 2011).

Nonetheless, like all dietary techniques available, HTS methods can also be limited by problems such as PCR errors, amplification of contaminants and sequence errors, and requires the validation of data for accuracy, and correct taxon assignment. Amplification of the non-target predator DNA can also limit the detection of prey items through HTS (McInnes *et al.* 2017a). False positives (detection of taxa that have not been actively selected as live prey) can arise due to scavenging, which is particularly problematic when considering the population dynamics of predator-prey interactions (Foltan *et al.* 2005); (Juen and Traugott 2005). Secondary predation (when the predator consumes a second predator that has consumed the detected prey species) is also a significant source of error, depending on the digestion rates of the species involved (Harwood *et al.* 2001; Sheppard *et al.* 2005). Quantitative interpretations of sequence proportions generated via HTS require careful analysis and sufficient experimental design to extract the complex interactions between factors influencing detectability, such as the influence of primer tags, sequencing direction and filtering quality (Deagle *et al.* 2013).

Considerable development in both the methodology and application of novel HTS techniques has been assessed in several comprehensive reviews which summarise the history of molecular dietary analysis (Symondson 2002), best practices for research approach (King *et al.* 2008), and systematically and quantitatively compare the different approaches (Pompanon

et al. 2012; Alberdi *et al.* 2017; Nielsen *et al.* 2017, Alberdi *et al.* 2018a). Workflows and recommendations have also been published surrounding the importance of sample preparation and fidelity of library generation (Murray *et al.* 2015), and the use of bioinformatics to validate HTS data and to aid taxonomic identification in diet metabarcoding studies (Clare *et al.* 2016; Corse *et al.* 2017; Richardson *et al.* 2017).

1.3 Gaps in knowledge:

Declines in farmland birds are of major conservation concern, in part because birds are considered to be sensitive bio-indicators of the functional health of farmland ecosystems. Farmland birds are directly affected by changes in habitat heterogeneity (Benton *et al.* 2003) and the resulting decline in the abundance, availability and accessibility of key invertebrate taxa is thought to be a driving factor behind population declines (Barnett *et al.* 2004; Hart *et al.* 2006). Despite the breadth of research in this subject, many studies that seek to relate habitat quality to reproductive success are based on simple measures of habitat quality and the extent of abundance of certain physical features of habitats, rather than qualitative measures such as the trophic resources that different habitat elements provide. Consequently, major gaps exist in our understanding of the complex interactions between agricultural factors, and landscape heterogeneity. Specifically, there is a need for improved knowledge about how birds exploit fragmented farmland habitats and utilise different landscape elements (e.g. field margins, hedgerows and crops) for food:

Gap 1: Consideration of the spatial variation, relative abundance and diversity in food availability for insectivorous vertebrates within habitats of differing complexity (Moreby and Stoate 2001; Holland *et al.* 2002).

Gap 2: Determining the full dietary breadth of farmland birds using comprehensive molecular methods.

Gap 3: Examining the links between diet composition and nestling growth and condition (Metcalf and Monaghan 2001).

Gap 4: Understanding the mechanisms behind foraging habitat selection, and whether dietary composition reflects invertebrate availability and/or optimal prey selection by birds.

Gap 5: Analysing the foraging preferences of our focal bird species in relation, not simply to habitat complexity, but specifically, to the availability of habitat elements associated with strong exploitation links, identified by the determining the full dietary breadth of farmland birds (see Gap 2).

The results of this unique study will increase our understanding of the relationship between habitat complexity, the trophic importance of different landscape elements, individual variation in diet composition and nestling productivity. These pieces of information will provide a model for using HTS to determine foraging relationships, via habitat-specific trophic networks, to address major conservation issues and enable conservation organisations, such as the British Trust for Ornithology, to provide detailed guidance with respect to criteria for future agricultural subsidies aimed at enhancing biodiversity.

1.4 Study species:

This project will consider farmland thrushes as tractable model species with which to investigate relationships between habitat heterogeneity and bird abundance, distribution, diet and habitat utilisation.

The Blackbird is a medium sized thrush (family Turdidae), which is a resident breeder and winter migrant to the British Isles and is common across a wide variety of habitats including woodland, farmland and urban environments. Data held by the British Trust for Ornithology (BTO) show long-term declines in Blackbird abundance up to the mid-1990s, followed by a strong (6%) but partial recovery, driven by increases mainly in Wales, north-western England and Scotland (Baillie *et al.* 2013). In 2009 there were estimated to be 5.1 (4.9 – 5.3) million breeding pairs across a wide variety of habitats within the UK (Musgrove *et al.* 2013). There has been a widespread but moderate increase across Europe since 1980 (PECBMS 2017). Annual population changes correlate best with adult survival, but population processes appear to differ between eastern and western Britain; with annual population growth rates lower in

the east of Britain (Robinson *et al.* 2012). Reduced survival is thought to have driven the decline (Siriwardena *et al.* 1998), potentially as a consequence of agricultural intensification (Fuller *et al.* 1995). However, as population declines have occurred across a range of habitats, including woodland, additional factors are probably involved. Reproductive success is sensitive to variation in precipitation (Chamberlain *et al.* 1999; Paradis *et al.* 2000) and cumulative soil moisture levels (Miller *et al.* 2017). Using novel multi-state, multi-stage models, (Miller *et al.* 2017) found that daily blackbird survival probabilities were lower in rural or urban habitats when compared to human-rural habitats (e.g. countryside villages), supporting the hypothesis that intermediate habitats offer a better balance between high predation rates in the wider countryside and restricted food availability in urban areas.

Blackbirds are generally monogamous and territorial. Clutches of 2 – 5 eggs are usually laid from mid-March to late June (Snow 1955a), during which time a pair can raise two or more broods. Only the female incubates, but both birds feed the nestlings until they fledge 13 – 14 days after hatching (Snow 1958). The pair also feed the young for 15 – 24 days after fledging (Snow 1958b; Ebenman and Karlsson 1984), although early in the breeding season the female often re-nests before the young are independent, so that the male provides most of the parental care (Snow 1958b; Edwards 1985).

Song Thrushes (family Turdidae) are a resident breeder and winter migrant to the British Isles, and are common across farmland, woodland and urban habitats. Since the early 1970s, Song Thrushes have declined rapidly as a breeding species in lowland Britain (Baillie *et al.* 2001), with marked declines on farmland, where approximately 70% of pairs have been lost (Peach *et al.* 2004). Recent BTO data shows a general increase of 7% since 1997 (strongest in Wales and northern England; little change in Northern Ireland and south-eastern England), but population levels remain comparatively low (Baillie *et al.* 2013). Consequently, the Song Thrush is red-listed as a species of conservation concern in the UK. In 2009, there were believed to be 1.2 million territories within the UK (Musgrove *et al.* 2013). The Song Thrush has had a widespread moderate increase across Europe since 1980 (PECBMS 2017). Baillie *et al.* (2001) examined extensive long-term demographic data held by the BTO and found no indication of changes in ‘per breeding attempt’ nesting success. However, the results of an intensive study conducted by the Royal Society for the Protection of Birds (RSPB) suggested

that, on lowland arable farmland, breeding Song Thrushes mitigated the impacts of food shortages on chicks by confining their nesting attempts to periods when the abundance of invertebrates was sufficient to raise a brood of young (Gruar *et al.* 2003). Additional factors that may have had negative impacts on farmland Song Thrush populations include: reduced survival during the post fledging period and first winter fully grown birds during their first year of life (Thomson *et al.* 1997; Robinson *et al.* 2004), direct and indirect effects of pesticides (Campbell *et al.* 1997), loss and degradation of key nesting and feeding habitats (Mason 1998), food availability during periods of dry weather (Mason 1998; Gruar *et al.* 2003), increased depredation of nests and adults from increasing avian and mammalian predator populations (Thomson *et al.* 1998; Paradis *et al.* 2000; Stoate and Szczur 2010). However, many of these factors are not deterministic and may even act in opposite directions.

Song Thrushes are territorial and lay 3 – 5 eggs in a nest of twigs, grass and moss lined with a thick inner cup of mud that is often mixed with fragments of rotten wood and then cemented with saliva (Ferguson-Lees *et al.* 2011). The breeding season runs from mid-March to July, during which time a pair can raise 2 or 3 broods (Snow 1955a). The female incubates the eggs for 14 – 15 days, and nestlings will fledge after 14 – 15 days in the nest (Cramp 1988). The pair feed the nestlings together, and once they fledge the male continues to feed the juvenile birds whilst the female prepares to lay again (Snow 1955b).

Blackbirds feed mainly on earthworms, slugs, caterpillars, beetles and spiders. Fruit is also prevalent in the diet, particularly in late summer and early winter. Dietary studies have focused on nestlings (Snow 1958; Török 1981; Török 1985; Török and Ludvig 1988; Schnack 1991; Chamberlain *et al.* 1999; Szentkirályi and Krištín 2002) and identified a generalist diet with nestlings provisioned with a diverse range of invertebrates. However, nestlings provisioned on earthworm-rich diets were significantly heavier than those fed mainly on caterpillars (Chamberlain *et al.* 1999). Microscopic analysis of faeces revealed that nestling Song Thrushes are fed on earthworms, snails, adult beetles and insect larvae (Gruar *et al.* 2003). A limited number of studies have considered nestling diet and found Song Thrush have a narrower dietary breadth than that of Blackbirds (Schnack 1991; Török 1985; Gajdoš and Krištín 1997). Experiments have also been conducted with Song Thrush nestlings to determine the impacts of food restrictions, overfeeding, and the implications of these

experimental manipulations for energy utilisation, histology and gut function, and found that nestlings were unable to actively respond to changing food availability by slowing their pace of growth (Konarzewski *et al.* 1996; Konarzewski and Starck 2000). Studies considering the diet of adult thrushes are rare but see Gruar *et al.* (2003), who examined the diet of adult Song Thrushes using microscopic analysis of faecal samples. None of these studies were able to analyse dietary components down to species level.

Changes in the abundance and availability of prey due to varying soil conditions and rainfall through the season may influence diet. Both of the focal thrush species are able to have multiple broods within a season, thus allowing any seasonal or age-related differences in diet to be determined. Gruar *et al.* (2003) reported a pronounced seasonal decline in the quality of diet, as Song Thrushes had to shift from earthworms and snails to an increasing proportion of spiders due to the dry weather of late summer. A dietary switch was also reported by Chamberlain *et al.* (1999) as the availability of earthworms was dependent on rainfall on farmland, and Blackbirds switched to caterpillars during dry periods. Earthworms and slugs respond to abiotic conditions, such as increasingly dry summer soil conditions, by descending deeper into soil and aestivating (Gerard 1967; Hunter 1996), thus reducing their accessibility to foraging thrushes. Thrushes may also alter their diet in relation to age, growth, nutritional and energy requirements. Several species are known to feed a higher proportion of spiders to younger chicks, potentially as the smaller prey items contain less chitin and high levels of taurine crucial for the development of the central nervous system and bile formation (Ramsay and Houston 2003; Radford 2008). Gruar *et al.* (2003) found compositional changes in the diet of Song Thrush dependent on age, as nestlings had a larger proportion of insect larvae within examined faeces than adults which had a diet dominated by earthworms (Gerard 1967).

1.5 Core hypotheses:

The current investigation attempts to utilise a novel environmental genomics approach to address how birds exploit patchy habitats for invertebrate resources, a poorly-studied area of research (as specified in section 1.3; *Gaps in knowledge*). By analysing invertebrates from different landscape elements (Gap 1) and using genetic analysis of faecal samples (Gap 2), the

potential constraint of dietary breadth on reproductive success will be determined (Gap 3) and prey exploitation linked to habitat structure to identify spatial and trophic associations between birds (Gap 4) and different landscape elements (e.g. crops, field margins, hedgerows and woodland patches; Gap 5).

The chapters set out in this thesis discuss and investigate the use of HTS to track habitat use by thrushes exploiting heterogeneous farmland landscapes. Specifically, four core hypotheses were tested:

- (1) Landscape heterogeneity is associated with dietary diversity; complex landscapes provide birds with redundancy in terms of diversity of suitable prey items to exploit.
- (2) Use of landscape elements by foraging thrushes differs with farmland complexity. Competition is predicted to be higher and overall population density is predicted to be lower within simple landscapes.
- (3) Habitat exploitation will vary seasonally with changing availability of prey.
- (4) Nest productivity and nestling growth and condition is lower in relatively simple landscapes than in more complex landscapes, due to diet.

1.6 Chapter organisation:

Each chapter builds sequentially on from the next and provides a framework for the steps that practitioners would need to take in order to utilise environmental genomics to track how birds exploit fragmented habitats to find food. In Chapter 2, the spatial variation, relative abundance and diversity in invertebrate food availability for Blackbirds and Song Thrushes was quantified across landscapes of differing complexity using a broad taxonomic-spectrum sampling approach and a suite of different sampling methods, followed by the identification of potential prey taxa to Order level. In Chapter 3, *in silico* and *in vitro* evaluation was used to determine the suitability of over 100 different combinations of known ‘universal’ COI primer pairs, to ensure that the primers selected could amplify all known prey taxa, including Annelida, Gastropod Molluscs and Arachnids. Two broad COI primer pairs were selected: a

short primer pair to maximise diversity and sensitivity, and an extended region to improve taxonomic resolution and quality-check species identity. In Chapter 4, a metabarcoding and HTS approach was used to analyse the full spectrum of the trophic networks of the target Thrush species. Compositional changes in the diet of nestling Thrushes in relation to growth and condition were evaluated, as well as any temporal and seasonal changes in diet. Chapter 5 considers direct links between the availability of key invertebrate prey and the relative importance of different landscape elements demonstrating the utility of this novel method, using detailed nest-level examples as illustrative case studies. One important application of such case studies is to investigate whether diet provisioning and breeding productivity of farmland Thrushes is constrained by landscape structure. Finally, I bring together all these different types of information in Chapter 6, to identify how Thrushes exploited fragmented farmland habitat to find food, to place these findings within the wider context of agro-ecology and farmland bird conservation, and to highlight future research priorities.

CHAPTER 2: **Invertebrate abundance:**



“I think we consider too much the good luck of the early bird and not the bad luck of the early worm”

Franklin D. Roosevelt

Spatial variation, relative abundance and diversity in invertebrate prey groups across farmed landscapes.

Agricultural intensification has been linked to severe and widespread declines in the abundance and diversity of a wide range of taxa. Invertebrates are an essential dietary component for most farmland bird species. However, invertebrate availability across a landscape is rarely quantified. The distribution of key invertebrate resources across heterogeneous landscapes will influence both availability of invertebrates as food, and optimal prey selection by foraging birds. Spatial variation in invertebrate abundance and diversity of different taxa that had previously been identified from the literature as important components of the diet of Blackbirds and Song Thrushes were assessed using four different methodologies (mustard extractions for earthworms, baited slug refuges, vacuum and pitfall sampling). The results revealed striking spatial variation between different landscape elements (e.g. hedgerow, field margin, crop) in the relative abundance and diversity of invertebrate food availability for farmland birds within two contrasting farmed landscapes. This study highlights the importance of habitat heterogeneity in general, and non-cropped boundary habitats in particular, as being of importance for maintaining a high overall abundance and diversity of invertebrates as a resource for foraging birds in agricultural landscapes.

2.1 Introduction:

In recent decades, agricultural intensification and the subsequent increase in agricultural productivity has impacted habitat heterogeneity at multiple scales. The reduction in mixed arable-livestock farming, and a decline in the diversity of cropping regimes, along with a switch from spring to autumn sowing of crops, subsequent intensification of resource use and the increased application of fertilisers and pesticides, have all contributed to reduced habitat complexity (Altieri 1999; Benton *et al.* 2003; Pickett and Siriwardena 2011). In addition, the loss of semi-natural marginal habitats such as hedgerows, ponds and uncultivated field margins has been detrimental to wildlife. These aspects of agricultural intensification have occurred concurrently, making it hard to isolate their individual impacts (Newton 2004), but collectively they have contributed to the simplification of farmland ecosystems (Matson *et al.*

1997; Tschardtke *et al.* 2005). The impacts of agricultural intensification have been linked to declines in the abundance and diversity of a wide range of taxa including plants (Storkey *et al.* 2012), mammals (Smith *et al.* 2005), birds (Donald *et al.* 2001; Wilson *et al.* 2005) and invertebrates (Schmidt *et al.* 2005; Oliver *et al.* 2010).

Invertebrates are essential ecosystem components that assume key structural and functional roles, underpin ecological processes and provide fundamental trophic resources; however, they are often poorly studied, as research tends to be vertebrate-focused (Grodsky *et al.* 2015). Invertebrate agro-ecology research is often biased towards pest species of agricultural concern, due to the considerable damage and economic losses these species can cause; or focused on the services provided by pollinators and their contribution to crop production (Klein *et al.* 2007).

Within UK farmland, invertebrates are reported to have decreased by 62% (Burns *et al.* 2013), despite being underrepresented as a group within the analysis, due to data deficiency. Butterflies have declined by 41%, moth species associated with farmland by 64% and carabid beetles by 70% (Burns *et al.* 2013; Fox 2013; Holland and Luff 2000). These widespread declines in invertebrate taxa are related to the intensification of agricultural production e.g. increased specialisation of farming, decreased under-sowing, timing and depth of ploughing, a reduction in the number of uncultivated margins (Wilson *et al.* 1999; Sotherton and Self 2000), and the increased impact of pesticides (Aebischer *et al.* 1991). Extensive land drainage reduced the availability and accessibility of edaphic invertebrates by lowering the water-table (Newton *et al.* 2004). The demise of undersowing, to establish ley grassland into the previous spring cereal crop, which was once common practice on farms, has declined and its termination could also be responsible for the decline of beneficial insects such as sawflies (Symphyta spp.; Aebischer 1990). Significant negative relationships have been reported between several invertebrate groups (Acrididae, Araneae, Coleoptera and Lepidoptera) and the use of insecticides, the timing of their application (summer applications were more damaging than autumn ones), and their taxonomic spectrum of activity (Wilson *et al.* 1999; Ewald and Aebischer 2000). Many invertebrate species have also declined due to the indirect effect of herbicides and a reduction in the availability of their host arable weeds.

The reduced availability of key resources has been linked to severe and widespread farmland bird population declines. For many farmland birds, invertebrates are an essential dietary component and are particularly important for developing nestlings that often depend on protein-rich invertebrates for the nutrition needed for growth and for thermoregulation (Moreby and Stoate 2000). Insufficient chick food is known to reduce the breeding success of Grey Partridge *Perdix perdix*, Eurasian skylark *Alauda arvensis*, Yellowhammer *Emberiza citrinella* and Corn Bunting *Emberiza calandra* (Brickle *et al.* 2000; Boatman *et al.* 2004; Hart *et al.* 2006; Morris *et al.* 2005; Sotherton *et al.* 1993). Poorly fed chicks often exhibit slower growth rates, and suffer an increased risk of predation, both due to a greater duration of the nestling period and because hungry broods beg more frequently and louder (Haff and Magrath 2011). In addition, poorly fed chicks often have lower resistance to disease/parasites through reduced immune capacity (Hoi-Leitner *et al.* 2001; Most *et al.* 2011) and adverse weather conditions (Naef-Daenzer and Keller 1999; Arlettaz *et al.* 2010; Bouwhuis *et al.* 2015).

Food availability for insectivorous vertebrates is rarely quantified, especially across heterogeneous landscapes, and vertebrate diet may reflect both resource availability and predator dietary preferences. Despite being an essential food source for most farmland birds, data regarding the relative abundance and biomass of invertebrates in the most commonly grown arable crops is scarce (but see Douglas *et al.* 2010). Obtaining a comprehensive measure of the relative abundance and diversity of invertebrates across a landscape is difficult, however, due to the suite of different sampling methods required to capture the diversity of functional guilds of relevance, as well as the time needed to collect and process samples, and the ability to accurately identify potentially thousands of specimens. In many contexts, identification of invertebrates to species level is both impractical and expensive. Pocock *et al.* (2012) were able to overcome the logistical constraints of working at a whole-farm scale to sample multiple ecological networks simultaneously. However, they required a team of 14 field assistants and 15 taxonomists to undertake replicated sampling across the 125-hectare farm for two years. However, knowledge of invertebrate availability across a landscape is essential to shed light on optimal prey selection by birds. Invertebrate identifications to Order level are sufficient to compare prey availability for foraging

vertebrates in areas of different land uses in agricultural landscapes, providing a broad-spectrum sampling approach (Moreby and Stoate 2001; Biaggini *et al.* 2007).

No single sampling method can effectively sample all invertebrate taxa and capture the diversity of relevant functional guilds. Various biases are associated with each of the different sampling methods. Earthworm extraction techniques are subject to bias regarding life history, size and species (Lawrence and Bowers 2002). Discrepancies can be exacerbated based on the efficiency of the chemical expellant, sampling method used and preceding environmental factors (Pelosi *et al.* 2009). Pitfall trap catch is influenced not only by abundance, but also by the activity of ground-active arthropods during the sampling period (Brown and Matthews 2016). Sweep-netting is another commonly used technique for sampling invertebrates but as sweeps-nets cannot readily penetrate the vegetation and the sweeping action can disperse small insects', samples are often biased toward foliar insects near the tips of vegetation or heavier more active insects (Cooper and Whitmore 1990; Buffington and Redak 1998). Vacuum sampling is more cumbersome than sweep-netting and less effective at collecting large insects. However, vacuum sampling is an effective method for targeting invertebrates near the ground and in low vegetation where many birds forage (Cooper and Whitmore 1990).

The central aim of this Chapter is to determine the invertebrate community composition, relative abundance and diversity of different invertebrate taxa within different landscape elements, across two farming landscapes of differing habitat complexity. Whilst also obtaining detailed species level data for Clitellata (worms), Gastropoda (slugs and snails), and Coleoptera (beetles) which had been previously identified from the literature as important components of the diet of Blackbirds *Turdus merula* and Song Thrushes *Turdus philomelos* (Blackbirds: Török 1981; Török and Ludvig 1988; Chamberlain *et al.* 1999; Song Thrushes: Davies and Snow 1965; Gruar *et al.* 2003; Murray 2004). Knowledge of invertebrate availability was then related to the growth and condition of nestlings (Chapter 4), to further our understanding of how birds exploit patchy habitats and the strength of trophic links between birds and different landscape elements (e.g. crops, field margins, hedgerows and woodland patches) (Chapter 5). Developing an understanding of the invertebrate food resources provided by habitat elements is essential if agro-ecosystems are to be managed

more sustainably and the ongoing, and highly concerning, declines in farmland birds are to be reversed.

Invertebrates were sampled across the different landscape elements of a farm of mixed livestock and arable land-use and high habitat complexity in Wenvoe, South Glamorgan, Wales, and a more specialised arable farm with lower habitat complexity, in Hildersham, Cambridgeshire, England. Vacuum sampling, pitfall trapping, mustard extractions for earthworms and baited refuges for slugs were all deployed to investigate the following hypotheses:

- (1) The farm landscape differs in terms of complexity (field size, perimeter length and crop types) between South Glamorgan (more complex) and Cambridgeshire (less complex).
- (2) The overall abundance and diversity of invertebrate taxa differ between landscape elements within each farm landscape.
 - a) Non-cropped boundary habitats (field margins, woodland margins, hedgerows) will be of particular importance for maintaining a high overall abundance and richness of invertebrates as a resource for foraging birds in agricultural landscapes.
 - b) Undisturbed landscape elements (woodlands, woodland margins, hedgerows) will contain the greatest abundance and species richness of earthworms.

2.2 Methods:

2.2.1 *Farm and landscape comparisons:*

Stratified sampling to determine the spatial variation of invertebrate abundance across farmed landscapes was conducted at Burdon's Farm (Wenvoe, South Glamorgan, 51°26'24.8"N 3°16'17.9"W), which comprises an area of mixed farming and high habitat complexity (Figure 2.1). The South Wales region is described as a complex arable landscape dominated

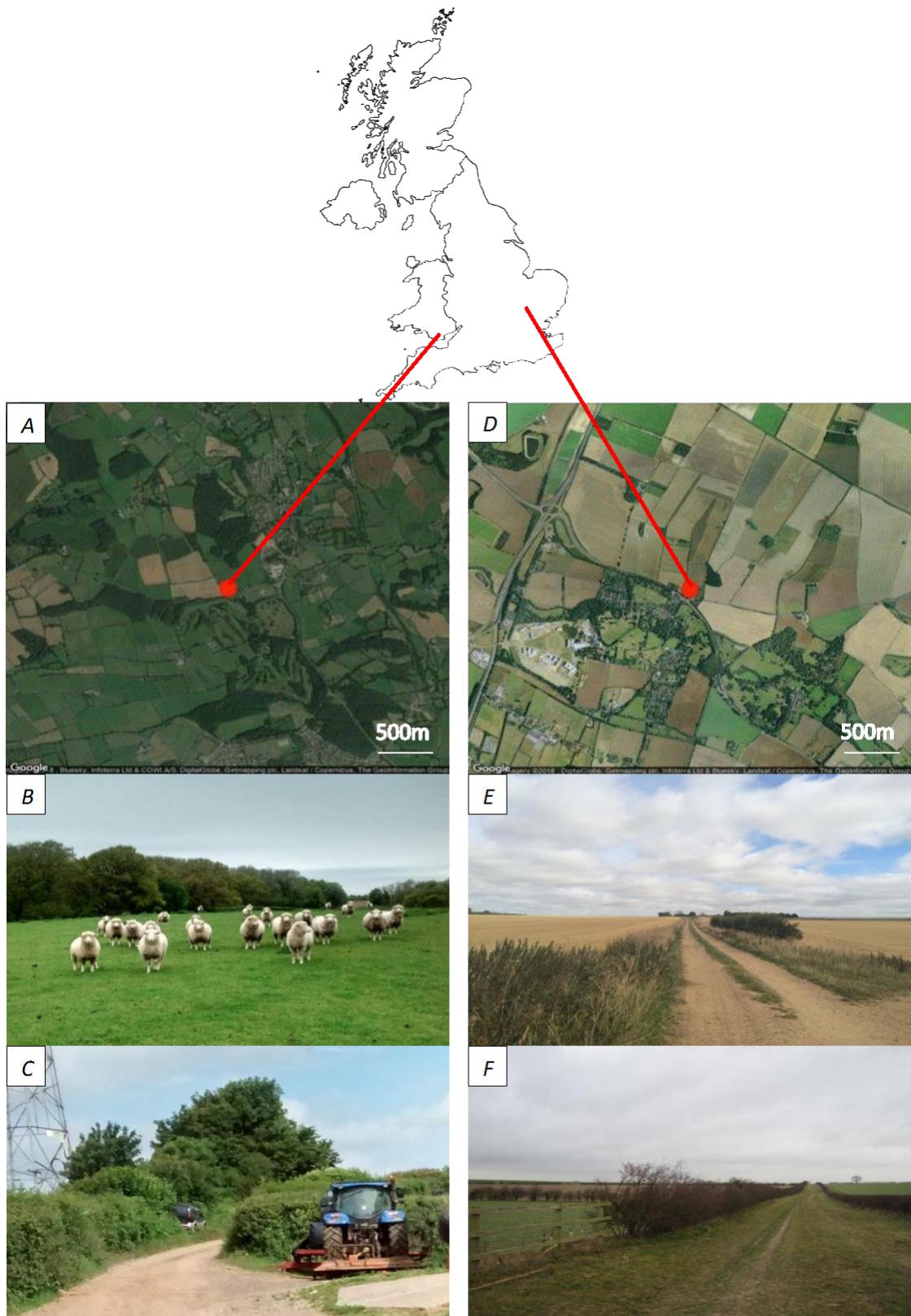

Figure 2.1: Map showing locations of study sites. *A, B, C*: mixed farming area of high habitat complexity at Wenvoe, Wales. *D, E, F*: intensive agricultural area with lower habitat complexity in Cambridge, England. *A* and *D*: aerial photographs Imagery © 2018 Google, Map data. *B* and *E*: representative landscape taken from each farm. *C* and *F*: typical hedgerow from the farms.

by 57% grassland (Welsh Agricultural Statistics 2015). However, since 2008 the area of arable crops has been increasing every year from 9% in 2008 to 17% in 2015. Within South Wales the average conventional farm size is 45 hectares (ha), lower than the UK average of 80 ha (DEFRA 2017a) and fewer than 3% of Welsh farms are larger than 200ha. Invertebrate sampling was also conducted at Lay Rectory Farm, (Hildersham, Cambridgeshire, 52°07'20.1"N 0°14'24.0"E), in an area of widespread arable farms and agricultural intensification (defined in Tschardtke *et al.* 2005) with lower habitat complexity than in South Glamorgan (Figure 2.1). Both farms are managed under an environmental stewardship scheme aimed at maintaining and enhancing biodiversity (Wenvoe - Glastir Entry Scheme; Hildersham - Higher Level Stewardship Agreement).

To assess the complexity of both farms and to ensure they were representative of the surrounding wider landscape, Land Cover[®] *plus*: Crops land-use data was obtained from the Centre for Ecology and Hydrology. This data portal provides land classification data for every land parcel larger than 2 ha categorised as arable/horticultural or improved grassland. Data was obtained for 2015 for both farms. A 15 km by 15 km square was centred around each of the farms, covering a total geographic area of 225 km². Within these quadrats, the total area of Land Cover[®] *plus*: Crops coverage excluding built-up areas was 83 km² for Wenvoe and 197 km² for Hildersham. The total field area, total field perimeter length and crop type, were recorded for each farm. Crops were classed as winter wheat, winter barley, spring barley, oilseed rape, potatoes, sugar beet, maize, improved grass and other (including peas, vegetables and early maize).

More detailed landscape elements and boundary types were grouped into several broad classes (adapted from Gibson *et al.* 2007) and mapped using a handheld Garmin GPSmap 60CSX unit, in conjunction with discussions with both farmers on land use management, and scrutiny of detailed environmental stewardship agreement maps. Hedgerows were defined as a boundary formed by closely growing bushes or shrubs. The location, length and width of all hedgerows were mapped and any hedgerow management (e.g. laying or trimming) was also recorded. Field margins consisted of any area of uncultivated semi-natural habitat greater than 1 metre in width that formed the perimeter of a field between the crop and boundary line. Woodland margins were similar to field margins except they were located between the crop

and a woodland boundary line. Beetle banks (Hildersham only) are formed from tussocky grass banks, about two metres wide, which bisect the middle of fields larger than 16 ha. Woodlands and copses included both established woodlands (with a closed canopy), and any non-linear area with more than three trees close enough that their canopies formed continuous cover when in leaf. The levels of management were also recorded. Any solitary trees within fields or along field boundaries were not included. Cover crops for wild birds were areas planted with specific seed mixes either to maintain bird populations or to support released game birds on the farm. The two farms planted different seed mixes, as detailed below.

2.2.2 *Invertebrate assessments:*

Blackbirds and Song Thrushes are known to feed on a wide variety of organisms; however, the majority of their prey taxa are represented by Clitellata, Gastropoda, Coleoptera, Arachnida and larvae of Insecta (mainly Lepidoptera and Diptera: Tipulidae). Previous research has shown that Lepidoptera larvae make up only a small proportion of nestling diet (6 – 8% Gruar *et al.* 2003, 0% Murray 2004). Rather than ensuring that every available prey taxon was sampled, the following methodologies provide a repeatable and standardised means for representing an index of invertebrate prey availability allowing for the biases associated with different sampling methods. Sampling was optimised for taxa that are known to form an important component of thrush diet to determine how ‘bird food’ distribution varies across the different landscape elements within farmland. To ensure we sampled all the available landscape elements across each farm, a stratified sampling strategy was deployed. Sampling of each site was conducted in different years due to logistical constraints.

For each of the four different invertebrate sampling methods implemented, the following landscape elements were sampled. At Wenvoe, samples were collected from different grass (n = 4 fields), maize (n = 4), and arable fields (n = 4, of which winter arable n = 2; spring arable n = 2). Woodland copses (n = 4 sites) and cover crops (n = 4) were also sampled. Cover crops consisted primarily of Rye *Secale cereale*, Triticale *Triticale hexaploide*, Quinoa *Chenopodium quinoa* and Kale *Brassica oleracea*. Finally, samples were collected from hedgerows (n = 24 locations), margins (n = 24) and woodland margins (n = 12) spread across the farm. Overall, a total of 84 different locations were sampled. Within fields, cover crops

and woodland copses, different numbers of replicate samples were taken, depending on the sampling methods, detailed below.

At Hildersham, samples were collected from spring arable (n = 4 fields; barley *Hordeum vulgare* n = 2; wheat *Triticum aestivum* n = 2), winter arable (n = 4; barley n = 2; wheat = 2), sugar beet *Beta vulgaris* (n = 2), potato *Solanum sp.* (n = 1), and grass fields (n = 1). Woodland copses (n = 4 sites), hedgerows (n = 24) margins (n = 24) cover crops (n = 4) and beetle banks (n = 3) were also sampled from across the farm. Cover crops consisted of four different varieties of Kale *Brassica sp.* (coleor kale, goldeneye kale, camaro marrowstem kale and king's kale rape), Linseed *Linum usitatissimum*, Fodder Radish *Raphanus sativus*, False Flax *Camelina sativa*, Mustard *Brassica juncea*, Quinoa, and Phacelia *Phacelia tanacetifolia*. In total, 68 different locations were surveyed across the farm, once again the number of replicate samples obtained depended on the sampling method.

2.2.2.1 Earthworms:

Sampling for earthworms was conducted at both Wenvoe (28th October – 6th November 2013) and Hildersham (18th June - 2nd July 2014). Stratified sampling was conducted at different times of years due to logistics, time constraints and the availability of student helpers. Within each field type (e.g. grass, cover crop), four replicate quadrats were randomly located, with the constraint that plots were at least 50 m apart. Individual quadrats were also sampled within hedgerows, margins and wood margins spread out across the farm. A total of 140 quadrats were sampled across the Wenvoe farm landscape and 110 quadrats at Hildersham. At each location, the ground was cleared of all vegetation and debris within a 0.25 m² quadrat, and a GPS position was taken using a handheld Garmin GPSmap 60CSx. Leaf litter was carefully checked for the presence of epigeic earthworms, which were collected. A mustard solution expellant was prepared by diluting 300ul allyl-isothiocyanate (AITC) and 8 ml 95% methanol in 5 litres of water, following a protocol provided by the late Professor John Morgan, Cardiff University (personal communication). Emerging specimens were collected for 15 minutes after irrigation. Adults were differentiated from juveniles by the presence of a clitellum and separated into different containers. Specimens were washed to remove any excess soil, and the total biomass of adults and juveniles in each quadrat was recorded using a digital balance (± 0.1 g). Earthworms were then fully immersed in 100% ethanol for storage

until subsequent identification. For each quadrat, adult earthworms were identified to species (Sims and Gerard 1985; Sherlock 2012) under a dissecting Leica Zoom 2000 microscope. All species identifications were confirmed by Professor John Morgan, Cardiff University. The abundance of adult earthworms of each species and the total number of juvenile worms was also recorded for each quadrat.

2.2.2.2 *Molluscs:*

Surveying for slugs and snails occurred at the same time as earthworm sampling. No slug pellet applications had been applied at either farm location in the six months prior to sampling. During the sampling period at Wenvoe (28th October 2013 – 6th November 2013), mean air temperature did not drop below 5°C and there were no overnight frosts. Slug refuges were placed close to the same locations as the earthworm quadrats across the farms. Paired refuges were placed 2 m apart and consisted of an inverted plastic plant pot tray (Sankey Ltd.) of 13 cm diameter, under which 35 g of Layers' poultry mash was placed (Glen *et al.* 2006). Baited refuges were set in the afternoon and left overnight for a minimum of 18 hours. Upon collection, slugs were removed from the underside of the plant pot tray and collected from an area of 0.25 m² centred around the refuge. At each location, paired refuges were pooled and the total slug biomass for each quadrat was recorded using a digital balance (± 0.1 g). Any snails found were also collected. Samples were stored in 100% absolute ethanol (Sigma Aldrich, UK) in 30 ml universal tubes. A Leica Zoom 2000 dissection microscope was used to examine the slugs and to identify each collected specimen to species level, with the use of identification keys (Cameron *et al.* 1986; Rowson *et al.* 2015). To ensure correct species identification, individuals that proved difficult to identify were double checked by Professor William Symondson, Cardiff University, for confirmation.

2.2.2.3 *Pitfalls:*

In order to sample general invertebrate diversity across the agricultural landscape, pitfall traps were used in a single session over 3 weeks at each farm (Oliver and Beattie 1996; Duelli *et al.* 1999). Pitfall sampling was conducted during June 2014 across the farm at Wenvoe, and during July 2015 across the farm at Hildersham. Pitfalls were dug-in at least one week in advance, using a soil corer to standardise and minimise disturbance effects (Greenslade 1973), before returning to set them. A two-cup design was used, with a transparent plastic

shell of ca. 8 cm in diameter and an inner sampling pot of the same diameter. A non-toxic killing and preservative mixture of water and washing up liquid was used to reduce the surface tension. Extracted soil was used to ensure the rim of the pitfall trap was completely flush with the ground. To prevent unwanted by-catch of small mammals and exclude rain (as well as birds), a clear plastic lid of ca. 10 cm diameter was held in position about 1 cm above the rim of the pitfall trap using pieces of wooden stirrer stick. Several rocks were then placed on top of the trap to prevent access to the collected invertebrates by birds.

At each sampling location, four pitfall traps were set, one at each corner of a 0.25 m² quadrat. Following the methodology for worms and slugs for each different landscape type, 4 replicates (each consisting of 4 pitfall traps) were randomly located within a field, with the constraint that sampling locations were at least 50 m apart. Pitfall sampling was also undertaken in hedgerows, margins and woodland margins across the farms. A total of 140 quadrats were sampled across the Wenvoe farmed landscape and 110 quadrats at Hildersham. Once set, traps were left open for a minimum of 48 hours during dry weather before returning to collect any specimens. Traps were reset if significant rainfall occurred during the sampling period. The position of each set of 4 pitfall traps was recorded with a handheld Garmin GPSmap 60CSx and the location marked using a bamboo cane with red ribbon tied to the top. Specimens were carefully rinsed in water to remove excess dirt and washing up liquid, and then frozen for subsequent identification. At each location, the contents of the 4 pitfall traps were pooled to represent one sample. The following taxa were identified to Order level to provide a broad spectrum sampling approach: Acarina (mites), Araneae (spiders), Coleoptera (beetles), Collembola (springtails), Dermaptera (earwigs), Diptera (flies), Panpulmonata (slugs and snails), Glomerida (pill-millipedes), Hemiptera (true bugs), Hymenoptera (ants, bees and wasps), Isopoda (isopods), Ixodida (ticks), Lepidoptera (butterflies and moths), Lithobiomorpha (stone centipedes), Mecoptera (scorpionflies), Neuroptera (lacewings), Opiliones (harvestmen), and Orthoptera (grasshoppers).

2.2.2.4 *Vacuum samples*

Vacuum sampling was carried out using a converted (reversed-airflow) McCulloch BVM 250 petrol powered leaf blower-vac, during June 2014 at Wenvoe, and July 2015 at Hildersham. For each sample, the device was used for a period of 45 seconds whilst moving the sampler

back and forth over the ground. Ten samples were taken per field, six per beetle bank (Hildersham only) and four along each hedge, margin or woodland margin, at least 10 m apart from one another. Samples were collected into a 48 cm fine mesh bag which was secured inside the inlet pipe of the blower-vac and held in place with a jubilee clip. After each sampling period, the contents of the bag including all debris were transferred into a sealed labelled food bag and frozen until subsequent analysis. The following taxa were identified to Order level: Acarina (mites), Araneae (spiders), Coleoptera (beetles), Collembola (springtails), Dermaptera (earwigs), Diptera (flies), Panpulmonata (slugs and snails), Geophilomorpha (centipedes), Glomerida (pill-millipedes), Hemiptera (true bugs), Hymenoptera (ants, bees and wasps), Isopoda (isopods), Julida (millipedes), Lepidoptera (butterflies and moths), Lithobiomorpha (stone centipedes), Neuroptera (lacewings), Opiliones (harvestmen), Orthoptera (grasshoppers), Polydesmida (millipedes), Psocoptera (booklice), Pseudoscorpiones (pseudoscorpions), and Trichoptera (caddisflies).

2.2.3 *Statistical analyses:*

This study explored the composition and abundance of invertebrates across different landscape elements within two farms of differing complexity. Preliminary analyses were conducted to ensure that the two farms selected were representative of the wider landscape, whilst differing in habitat complexity. Mann-Whitney tests were used to compare field area and perimeter, between each farm and the wider area and between the two different landscapes. Monte Carlo-simulated Fisher's tests with 10,000,000 replicates were used when conventional Fisher's tests were not possible due to statistical computing constraints.

The variation between landscape elements in the total number of invertebrates collected and the abundance of different Orders were investigated for data collected from pitfall and vacuum sampling. Species-level data were available for earthworms and slugs, so the influence of landscape element on total abundance and species diversity could be investigated. All analyses were conducted using the statistical software R, version 3.4.0 (R Core Development Team 2017), fitting Generalised Linear Mixed Models (GLMMs) using the R package 'lme4' (Bates *et al.* 2013) with negative binomial error structures and field number as a random term, to account for geographical autocorrelation. Analyses were

performed separately for Wenvoe and Hildersham as farms were sampled in different years and, as expected, preliminary analyses at each stage reported a significant difference in the total abundance of invertebrates collected across each of the four different sampling methods. Models were validated by calculating the overdispersion statistic and checking the distribution of residuals for normality and homoscedasticity. Candidate models were compared using the Akaike's Information Criterion (AIC) to ensure the most suitable error structure, link function, and value for the dispersion parameter 'theta' were selected each time, following Thomas *et al.* (2017).

Rarefaction analyses were conducted using the R package 'vegan' (Oskanen *et al.* 2016) to estimate the proportion of total taxonomic units detected (either at the level of species: Earthworms and slugs; or invertebrate Orders) in the different habitat elements for each of the four different sampling methods at both Wenvoe, South Glamorgan and Hildersham, Cambridgeshire.

2.3 Results:

2.3.1 Farm and landscape comparisons:

Preliminary investigations confirmed that the two different farming landscapes had differing levels of complexity. Fields in the more complex mixed farming landscape of South Glamorgan were on average 3.71 hectares (ha) smaller (Mann-Whitney Test: $W = 852060$, $n = 1821$ and 1865 fields, $P < 0.0001$), with perimeters 390 m shorter ($W = 834850$, $n = 1821$ and 1865 , $p < 0.0001$) when compared to the extensive arable region of Cambridgeshire.

When directly comparing Burdon's Farm, Wenvoe with Lay Rectory Farm, Hildersham, fields were 3.08 ha smaller on average ($W = 119$, $n = 21$ and 24 , $P = 0.002035$), with perimeters 290 m shorter on average ($W = 129$, $n = 21$ and 24 , $P = 0.005$). There was also a significant difference in crop types (Monte Carlo F-test, $P > 0.0001$), with 3 additional crop types (winter barley, sugar beet and potatoes) being recorded at Lay Rectory Farm.

Lay Rectory Farm, Hildersham, was representative of the wider Cambridgeshire landscape, with no significant difference between the farm and the wider landscape in either field size ($W = 23670$, $n = 24$ and 1841 , $p = 0.627$) or field perimeter length ($W = 22083$, $n = 24$ and 1841 , $p = 0.911$). Burdon's farm, Wenvoe was slightly atypical and not completely representative of the wider South Glamorgan landscape, with fields 1.12 ha larger ($W = 25696$, $n = 21$ and 1800 , $P = 0.007$) and perimeters 102 m longer on average, though this difference in perimeter length was marginally non-significant ($W = 23856$, $n = 21$ and 1800 , $P = 0.051$).

A greater diversity of crop types was recorded within Cambridgeshire than in South Glamorgan (Monte Carlo F-test, $P < 0.0001$) with fields of potatoes and sugar beet present at Lay Rectory Farm, Hildersham Cambridgeshire but not at Burdon's Farm, Wenvoe, South Glamorgan, and fewer fields of improved grassland at Lay Rectory Farm. This reflects the greater emphasis on arable farming in Cambridgeshire and on livestock farming in South Glamorgan.

2.3.2 *Spatial variation in invertebrate abundance and species richness:*

A total of 28,062 invertebrates were identified from 25 Orders across the different landscape elements from both farms. Rarefaction analyses for each of the four different sampling methods confirmed we had detected over 80% of taxonomic units for all of the different landscape elements from both farms and that sampling intensity was sufficient to quantify the spatial variation, relative abundance and diversity in invertebrate prey groups across farmed landscapes (Appendix: Figure S2.1 – Figure S2.6b). This excludes the pitfall trapping at Hildersham for the potato and grass fields, where less than 50% of taxonomic units were detected. A relatively small number of taxa formed a large proportion of the farmland invertebrate communities, as detailed below.

2.3.2.1 *Earthworms:*

Earthworms were collected from 135 of the 140 quadrats across the farm at Wenvoe. Overall, 2877 earthworms were collected; of these, 1136 were adult and therefore identifiable through morphological keys and assigned to 11 different species. The three most abundant species

represented 83.62% of all identified specimens. *Allolobophora chlorotica* was the most numerous species and accounted for 60.82% (691/1136) of the identified specimens, followed by *Allolobophora rosea* 12.94% (147/1136) and *Lumbricus terrestris* 9.86% (112/1136).

Total worm abundance varied significantly between the different landscape elements found at Wenvoe (GLMM model; LRT = 31.446, d.f. = 8,128, $P < 0.0001$; Figure 2.2) Cover crops ($+1.3396 \pm 0.3723$ $P < 0.0001$), grass ($+1.2769 \pm 0.3724$ $P < 0.0001$), margins ($+0.8092 \pm 0.2342$ $P < 0.0001$) and the recently planted winter arable crop ($+1.4948 \pm 0.4973$ $P < 0.0001$) all had significantly more earthworms than hedgerows. The estimated effects are relative to an intercept value of 2.1178 with ‘hedgerow’ set at the reference level, ‘zero’ values for the other measured parameters and ‘field number’ as a random effect.

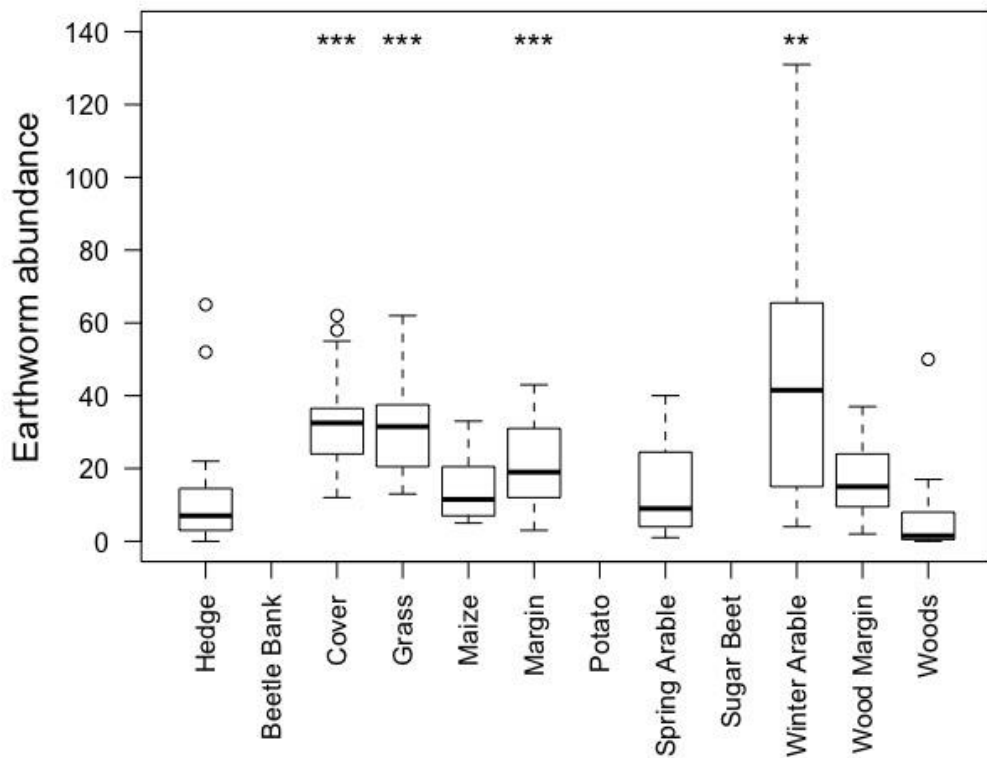

Figure 2.2: Total abundances of individual earthworms (adults and juveniles of all species) in different habitat types at Burdon’s Farm, Wenvoe, South Glamorgan. Significance markers refer to comparisons between each habitat and hedgerows (the reference category). Missing bars represent habitats that were not present in the Wenvoe study site.

Landscape element also had a significant effect when considering the total number of different species of earthworms recorded (GLMM; LRT = 40.904, d.f. = 8,129, $P < 0.0001$) and accounting for geographical random structure (Figure 2.3). A maximum of 6 different species of earthworm were recorded from different landscape elements.

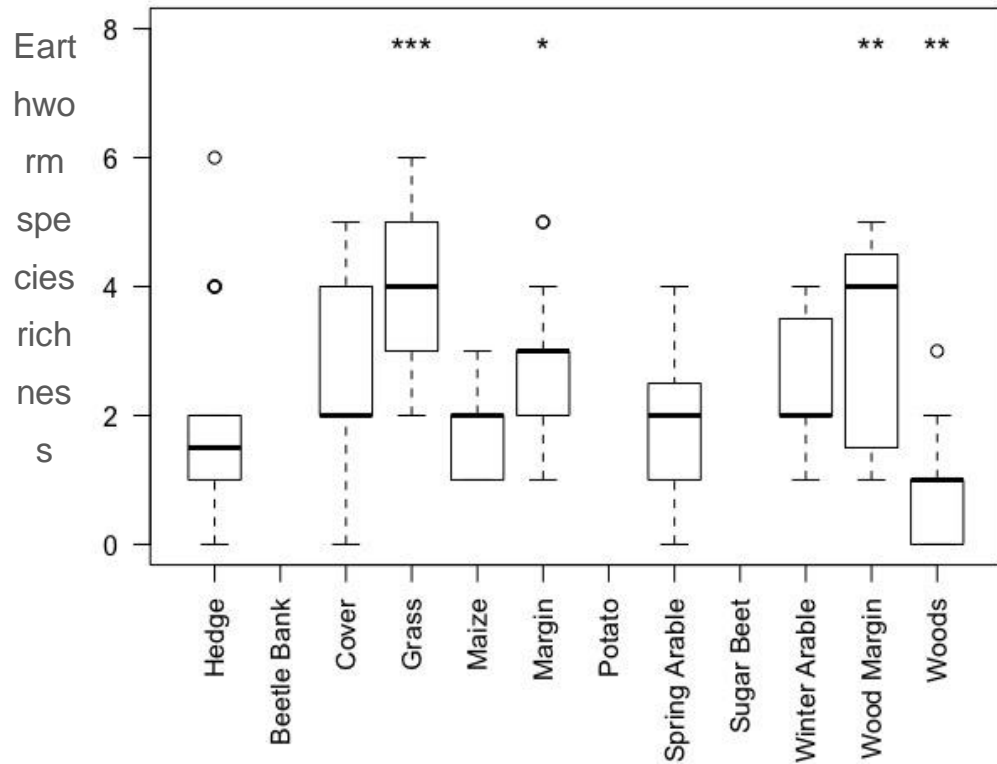

Figure 2.3: Species richness of adult earthworms in different habitat types in Wenvoe. Significance markers refer to comparisons between each habitat and hedgerows as the reference category. Missing bars represent habitats that were not present in the Wenvoe study site.

The undisturbed landscape elements were found to contain the greatest diversity of worm species (parameter estimates relative to hedgerow; grass $+0.835 \pm 0.193$, $P < 0.0001$; margin 0.398 ± 0.193 , $P = 0.039$; and woodland margin $+0.575 \pm 0.217$; $P = 0.008$) relative to an intercept value of 0.629 ± 0.149 with the reference level set at ‘hedgerow’, and ‘zero’ values for the remaining parameters. Species diversity was lowest in the relatively dense and compact woodland soil (woodland -0.9163 ± 0.3249 , $P = 0.0048$).

During sampling at Hildersham, 43 earthworms were collected from 27 of 110 quadrats. Thirty-five of these were juvenile and not assigned to species, and the remaining 8 adults were assigned to *Lumbricus rubellus* (n = 5) and *L. terrestris* (n = 3). Despite the very limited sample size, landscape element was found to have a significant effect on total worm abundance across the farm (GLMM; LRT = 33.286, d.f. = 9,97, P < 0.0001) (Figure 2.4). Sample sizes did not allow a habitat comparison for earthworm species abundance at Hildersham.

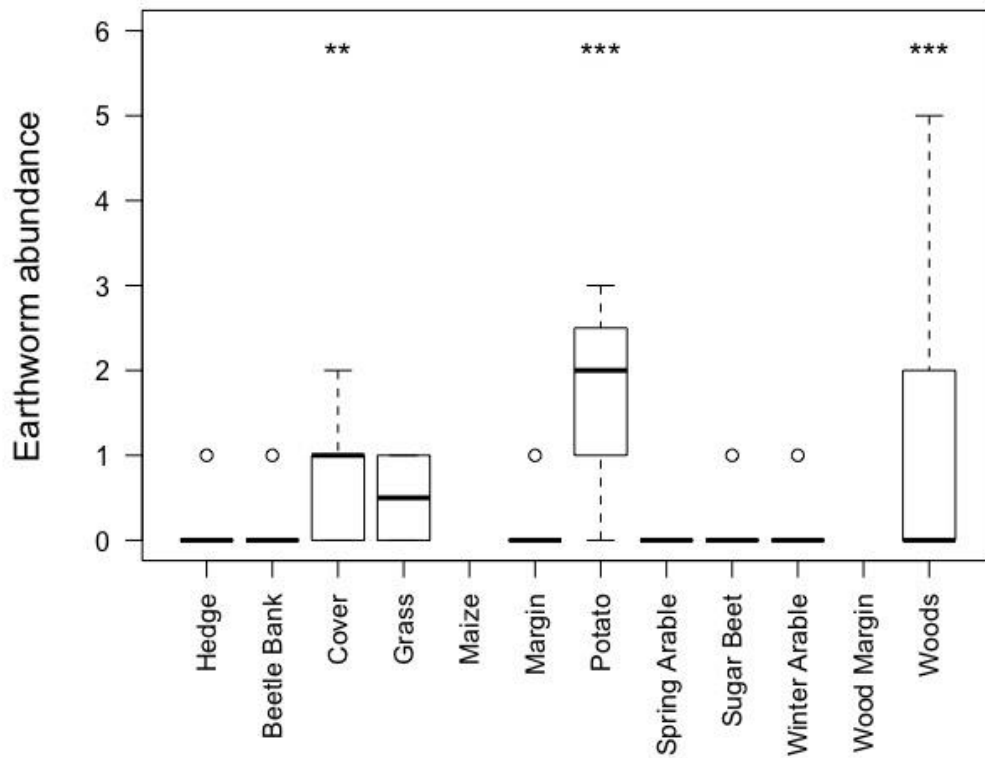

Figure 2.4: Total abundances of individual earthworms (adults and juveniles of all species) in different habitat types in Hildersham. Significance markers refer to comparisons between each habitat and hedgerows as the reference category. Missing bars represent habitats that were not present in the Hildersham study site

2.3.2.2 Molluscs:

A total of 2,317 slugs and 242 snails were collected from across Burdon's Farm at Wenvoe, South Glamorgan, from 140 different quadrats with paired baited refuges. Slugs were

assigned to 17 different species, and the three most abundant species account for 80.62% (1868/2317) of the identified specimens. *Deroceras reticulatum* was the most numerous species and accounted for 67.93% (1574/2317) of the identified specimens, followed by *Arion hortensis* 8.24% (191/2317) and *A. distinctus* 4.45% (103/2317)

Total snail abundance varied significantly between the different landscape elements across Burdon’s Farm at Wenvoe, South Glamorgan (GLMM; LRT = 26.987, d.f. = 8,268, $P < 0.0001$; Figure 2.5) when including ‘field number’ as a random effect to account for non-independence of data and geographical random structure.

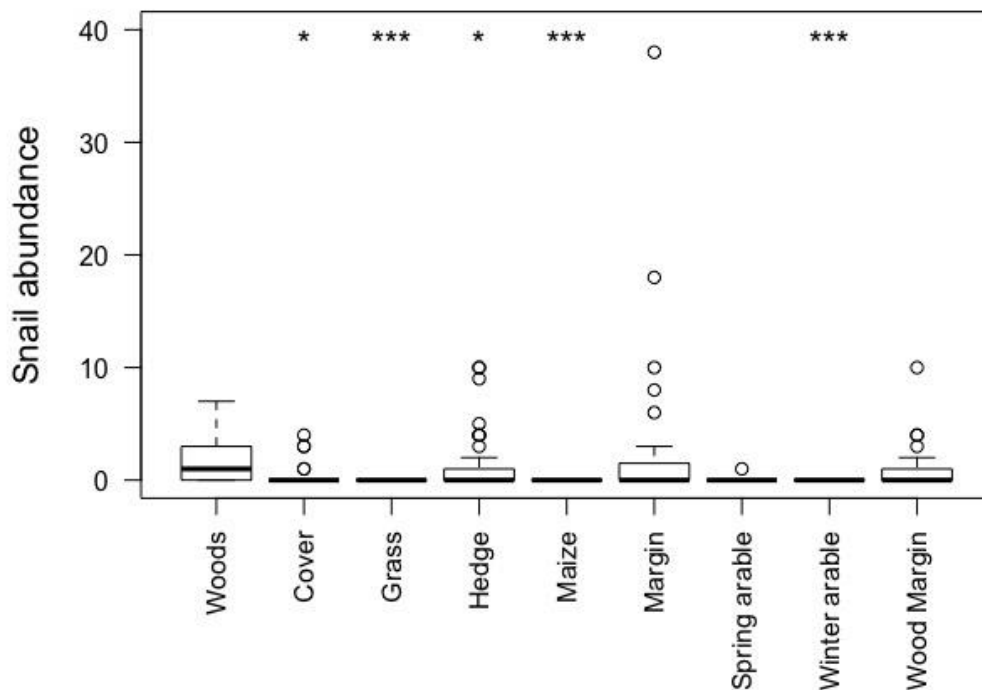

Figure 2.5: Total abundances of individual snails in different habitat types at Burdon’s Farm, Wenvoe, South Glamorgan. Significance markers refer to comparisons between each habitat and woodlands as the reference category.

The largest number of snails were collected from woodland, and least from winter arable, grass and maize fields. Parameter estimates represent snail abundance relative to the reference category of woodland (cover crop -0.8421 ± 0.356 , $P = 0.018$; grass -1.290 ± 0.362 , $P =$

0.0004; hedgerows -0.567 ± 0.286 , $P = 0.047$; maize -1.203 ± 0.315 , $P = 0.0001$; margin -0.301 ± 0.303 , $P = 0.320$; spring arable -0.687 ± 0.359 , $P = 0.056$; winter arable -1.508 ± 0.381 , $P < 0.0001$; woodland margin -0.444 ± 0.311 , $P = 0.153$).

Overall, total slug abundance varied significantly between the different landscape elements across Burdon's Farm at Wenvoe, South Glamorgan (GLMM; LRT = 44.251, d.f. = 8,268, $P < 0.0001$; Figure 2.6) when including 'field number' as a random effect to account for non-independence of data and geographical random structure. The largest number of slugs were collected from the arable fields, and least from hedgerows. Parameter estimates represent slug abundance relative to the reference category of woodland (spring arable $+1.300$, ± 0.592 , $P = 0.0282$; winter arable $+0.998$, ± 0.492 , $P = 0.046$; hedgerows -1.474 , ± 0.512 , $P = 0.004$).

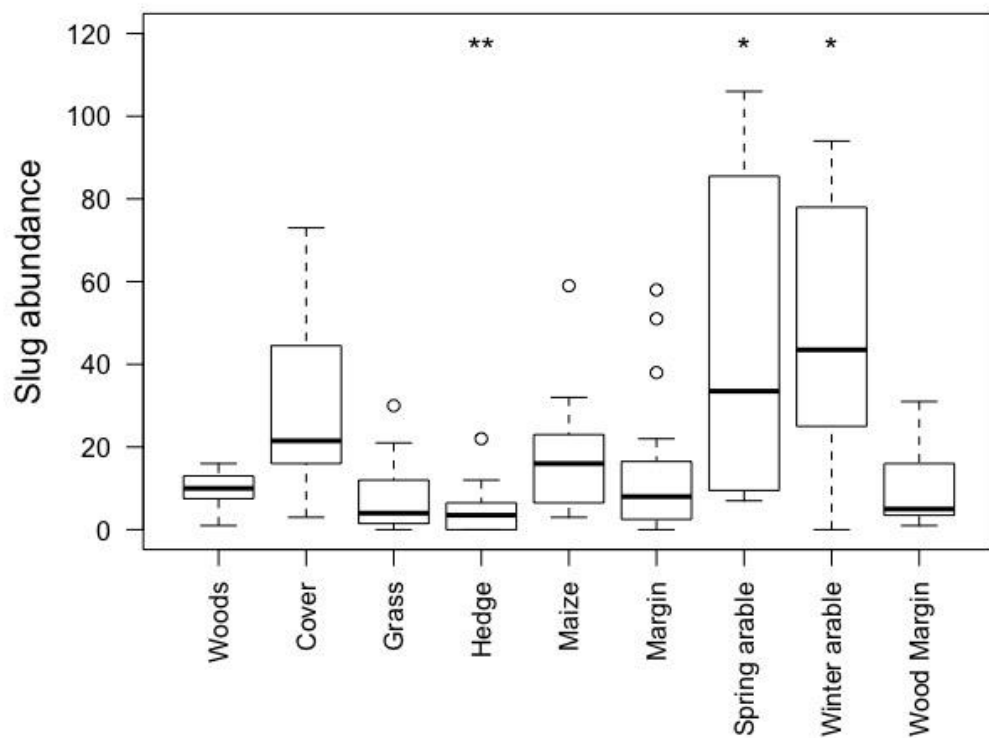

Figure 2.6: Total abundances of individual slugs in different habitat types at Burdon's Farm, Wenvoe, South Glamorgan. Significance markers refer to comparisons between each habitat and woodlands as the reference category.

The number of different slug species recorded varied significantly between the different types of landscape element (GLMM; LRT = 22.642, d.f. = 8, 269 P <0.0001; Figure 2.7). Up to ten different species of slug were recorded from different landscape elements. Grass fields and the non-cropped boundary elements were found to contain the lowest diversity of slug species (parameter estimates relative to the reference category of woodlands; grass -0.587 ± 0.268 , P = 0.049; hedgerow -0.860 ± 0.263 , P = 0.001; and margin -0.577 ± 0.259 , P = 0.026).

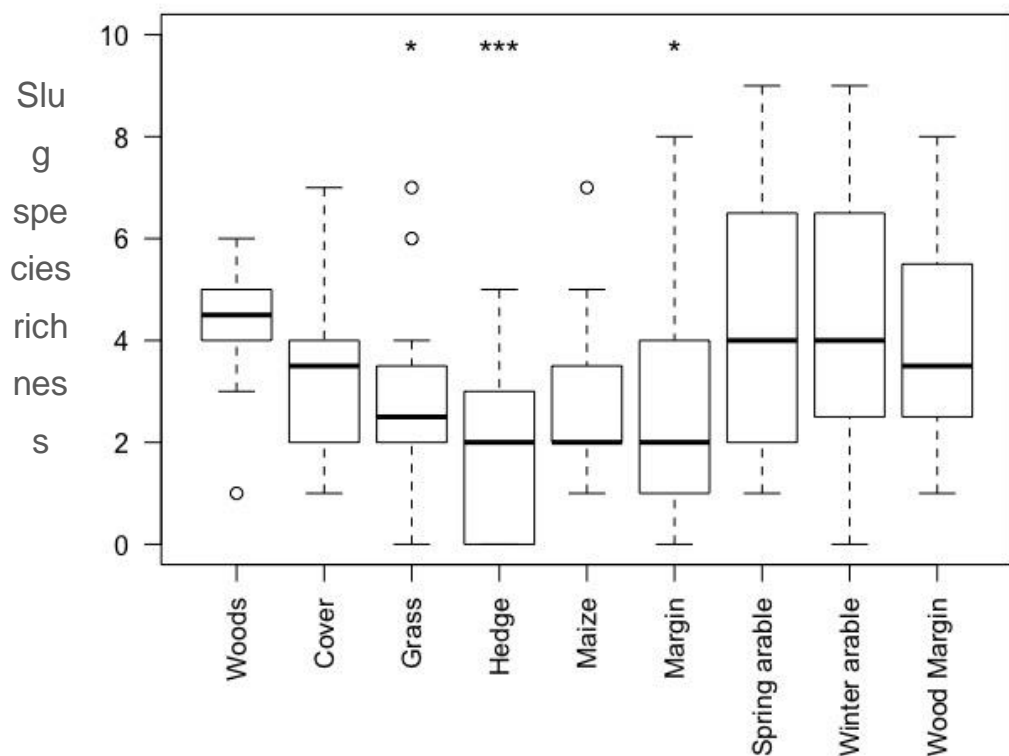

Figure 2.7: Species richness of slugs in different habitat types at Wenvoe. Significance markers refer to comparisons between each habitat and woodland as the reference category.

Despite using the same methodology at Hildersham as at Wenvoe (setting baited refuges), no slugs or snails were collected from any of the sampling locations across the agricultural landscape of Hildersham. The lack of slugs could be due in part to the particularly dry period when sampling occurred, and the predominantly calcareous soil type across the farm known to negatively affect breeding and survival (personal communication Mr Franklin -farmer).

2.3.2.3 Pitfalls:

Pitfall sampling across the Wenvoe farm resulted in a total of 5,946 invertebrates being collected, representing 16 different Orders, dominated by Coleoptera 70.65% (4201/5946), with Araneae 10.14% (603/5946), Diptera 8.09% (481/5946), Isopoda 4.89% (291/5946), Hymenoptera 3.63% (216/5946) and 11 other Orders representing < 2.5% of the total catch.

Total invertebrate abundance as sampled by pitfalls varied significantly between the different landscape elements found across the farmed landscape at Wenvoe (GLMM model; LRT = 42.467, d.f. = 8,133, $P < 0.0001$; Figure 2.8). Apart from spring arable crops, all different landscape elements have significantly higher numbers of invertebrates relative to the reference category of 'hedgerow', when including 'field number' as a random effect to account for non-independence of data and geographical random structure.

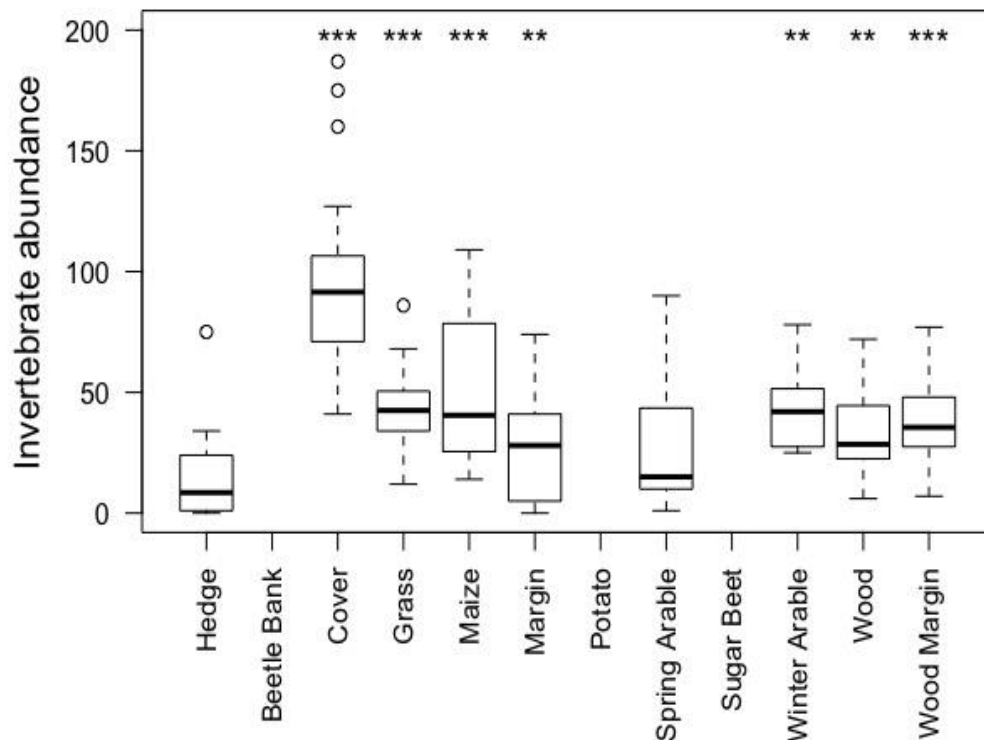

Figure 2.8: Total abundances of individual invertebrate Orders sampled using pitfall traps, in different habitat types in Hildersham. Significance markers refer to comparisons between each habitat and hedgerows as the reference category. Missing bars represent habitats that were not present at the Hildersham site.

The total number of invertebrate Orders captured in the pitfall traps was also significantly influenced by landscape elements. Up to eight different invertebrate Orders were recorded in pitfall samples in any one habitat type across Wenvoe (GLMM; LRT = 26.020, d.f. = 8,134, P = 0.0010; Figure 2.9). Woodlands were found to contain the highest diversity of invertebrate Orders ($+ 0.427 \pm 0.161$, P = 0.008), with the lowest diversity in the monoculture provided by maize fields (-0.337 ± 0.161 , P = 0.037), relative to the reference level of ‘hedgerow’.

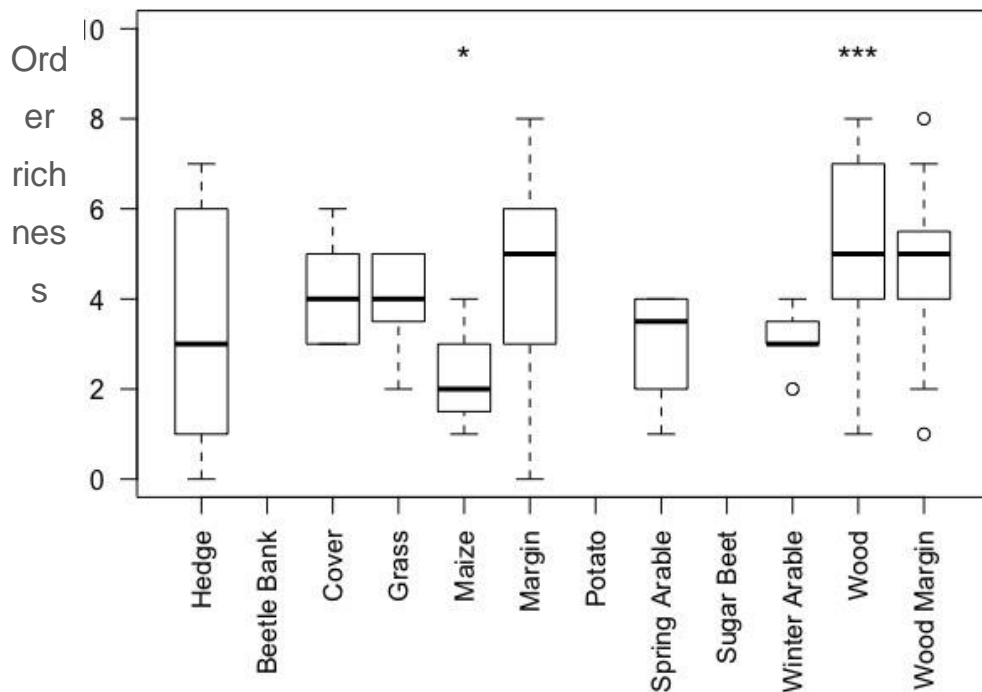

Figure 2.9: Total richness of individual invertebrate Orders sampled using pitfall traps in different habitat types in Wenvoe. Significance markers refer to comparisons between each habitat and hedgerows as the reference category. Missing bars represent habitats that were not present at the Wenvoe site.

A total of 3,104 invertebrates were collected by pitfall traps from different landscape elements across the Hildersham farm, representing 13 different Orders, dominated by Hymenoptera 34.92% (1084/3104), Coleoptera 25.06% (778/3104), and Isopoda 19.49% (603/3104), Diptera 6.51% (202/3104), Araneae 4.83% (150/3104), Opilliones 3.25%

(101/3104), Hemiptera 1.90% (59/3104) and 6 other Orders representing < 4% of the total catch.

Total invertebrate abundance varied significantly between the different landscape elements found across the farmed landscape at Hildersham (GLMM model; LRT = 69.701, d.f. = 9,124, $P < 0.0001$; Figure 2.10). However, only field margins ($+0.640 \pm 0.2792$ $P = 0.0218$) and potato fields (-2.1470 ± 0.6115 $P < 0.0001$) were significantly different in abundance relative to the reference category of 'hedgerow'.

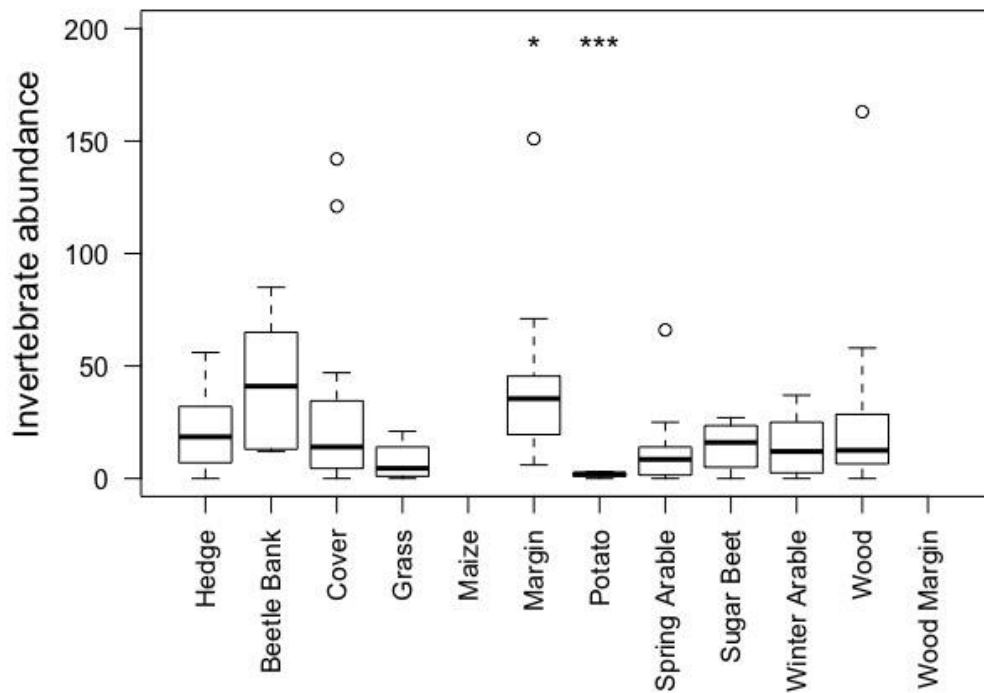

Figure 2.10: Total abundances of individual invertebrates sampled using pitfall traps in different habitat types at Hildersham. Significance markers refer to comparisons between each habitat and hedgerows as the reference category. Missing bars represent habitats that were not present at the Hildersham site.

Overall, landscape element was also found to have a significant effect on the total Order abundance across the farm, with up to nine different invertebrate Orders recorded from hedgerows (GLMM; LRT = 41.272, d.f. = 9,125, $P < 0.0001$; Figure 2.11).

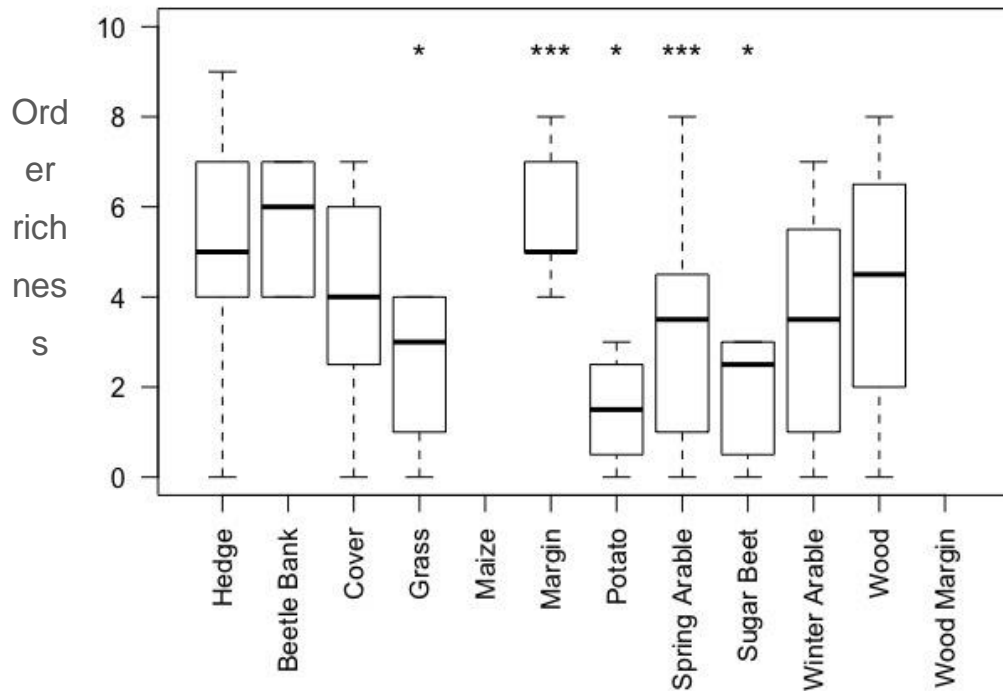

Figure 2.11: Total richness of individual invertebrate Orders sampled using pitfall traps in different habitat types at Hildersham. Significance markers refer to comparisons between each habitat and hedgerows as the reference category. Missing bars represent habitats that were not present at the Hildersham site

The purpose of this study was to determine the availability of key invertebrate prey for farmland birds and not to conduct a direct comparison of invertebrates between farms of differing complexity, particularly because stratified sampling was conducted in different years at the two farms. However, broad comparisons are possible; pitfall trapping yielded 16 different invertebrate Orders in the more heterogeneous mixed arable and livestock farm at Wenvoe, whereas only 13 different invertebrate Orders were recorded within the more homogeneous arable landscape at Hildersham. The community composition also differed

between the two farms, with samples at Wenvoe dominated by Coleoptera 70.65%, Araneae 10.14% and Diptera 8.09%. In contrast, Hymenoptera 34.92% (1084/3104), Coleoptera 25.06% (778/3104), and Isopoda 19.49% were the main taxa collected in the relatively simplified Hildersham landscape.

2.3.2.4 Vacuum sampling:

Vacuum sampling across the Wenvoe farm resulted in a total of 7,695 invertebrates being collected, representing 20 different Orders, dominated by Hemiptera 27.64% (2127/7695), Diptera 23.72% (1825/7695), Coleoptera 20.06% (1544/7695), with Araneae 12.41% (955/7695), Hymenoptera 6.96% (536/7695), Collembola 6.26% (482/7695) and 14 other Orders representing < 2.5% of the total invertebrates collected.

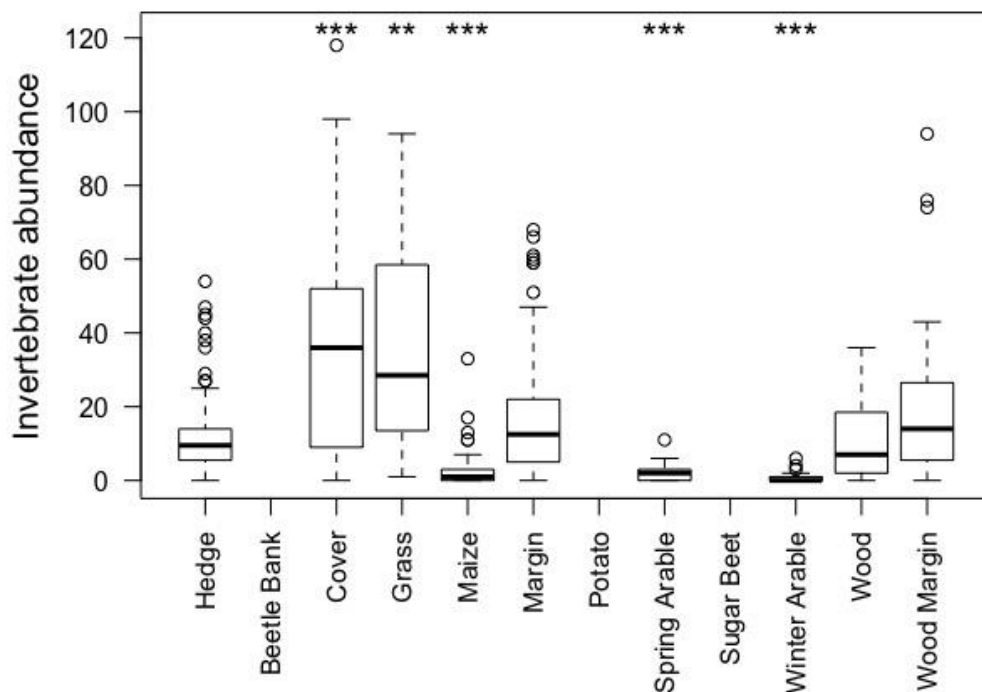

Figure 2.12: Total abundances of individual invertebrates sampled using vacuum sampling in different habitat types at Wenvoe. Significance markers refer to comparisons between each habitat and hedgerows as the reference category. Missing bars represent habitats that were not present at the Wenvoe site.

Total invertebrate abundance varied significantly between the different landscape elements found across the farmed landscape at Wenvoe (GLMM model; LRT = 265.79, d.f. = 8,431, $P < 0.0001$; Figure 2.12). Only field margins ($P = 0.099$), woodland margins ($P = 0.089$) and woodlands ($P = 0.361$) were not significantly different in abundance relative to the reference category of ‘hedgerow’.

Overall, landscape element was also found to have a significant effect on the total Order richness across the farm at Hildersham, with up to nine different invertebrate Orders recorded from hedgerows (GLMM; LRT = 165.99, d.f. = 8,432, $P < 0.0001$; Figure 2.13). The sparse monoculture created by the maize, spring and winter arable crops had significantly fewer invertebrate Orders (parameter estimates relative to hedgerow; maize -0.895 ± 0.144 , $P < 0.0001$; spring arable -0.773 ± 0.178 , $P < 0.0001$; and winter arable -0.924 ± 0.186 ; $P < 0.0001$).

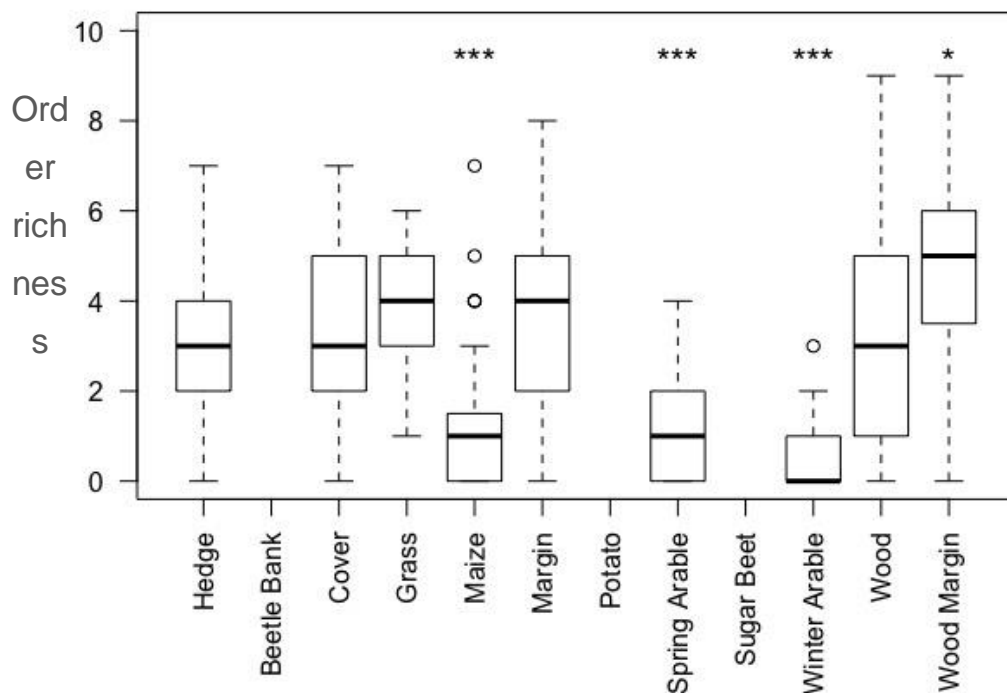

Figure 2.13: Total richness of individual invertebrate Orders sampled using vacuum sampling in different habitat types at Wenvoe. Significance markers refer to comparisons between each habitat and hedgerows as the reference category. Missing bars represent habitats that were not present at the Wenvoe site

Vacuum sampling across the Hildersham farm resulted in a total of 5,696 invertebrates being collected, representing 16 different Orders, dominated by Araneae 32.29% (1845/5696), Hemiptera 17.06% (6972/5696), Coleoptera 14.68% (836/5696), and Hymenoptera 12.27% (699/5696), with Diptera 8.36% (476/5696), Collembola 4.49% (256/5696), Isopoda 3.98% (227/5696) and 9 other Orders representing < 6.5% of the total samples.

Total invertebrate abundance varied significantly between the different landscape elements found across the farmed landscape at Hildersham (GLMM model; LRT = 412.79, d.f. = 9,300, $P < 0.0001$; Figure 2.14). Once again, relative to the reference category of ‘hedgerow’ the arable monoculture crops with uniform sward supported significant fewer invertebrates (potato $-2.791 \pm 0.548 < 0.0001$; spring arable $-1.366 \pm 0.2447 < 0.0001$; sugar beet $-2.188 \pm 0.336 < 0.0001$; winter arable $-1.661 \pm 0.242 < 0.0001$). However, only field margins ($P = 0.099$), woodland margins ($P = 0.089$) and woodlands ($P = 0.361$) showed no significant difference in abundance relative to the reference category of ‘hedgerow’.

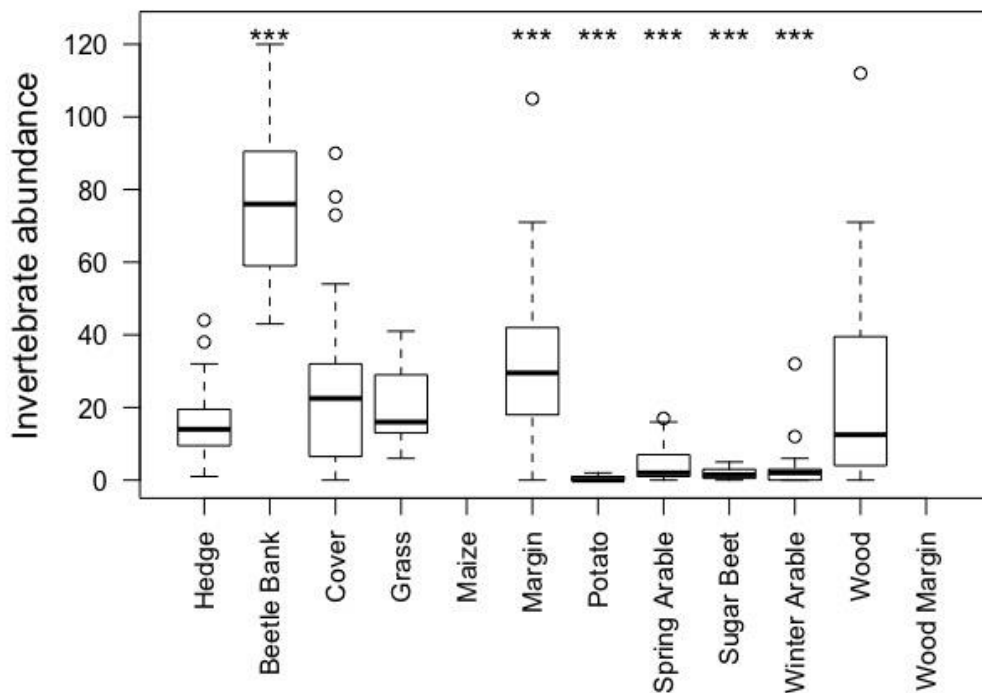

Figure 2.14: Total abundances of individual invertebrates captured using vacuum sampling in different habitat types at Hildersham. Significance markers refer to comparisons between each habitat and hedgerows as the reference category. Missing bars represent habitats that were not present at the Hildersham site.

Overall landscape element was also found to have a significant effect on the total Order richness across the farm, with up to nine different invertebrate Orders recorded from hedgerows (GLMM; LRT = 208.64, d.f. = 9,301, $P < 0.0001$; Figure 2.15). Non-cropped field margins and beetle banks contained a significantly higher number of invertebrate Orders (parameter estimates relative to Hedgerow; Beetle Bank + 0.535 ± 0.219 $P = 0.014$; Margin + 0.275 ± 0.133 $P = 0.039$).

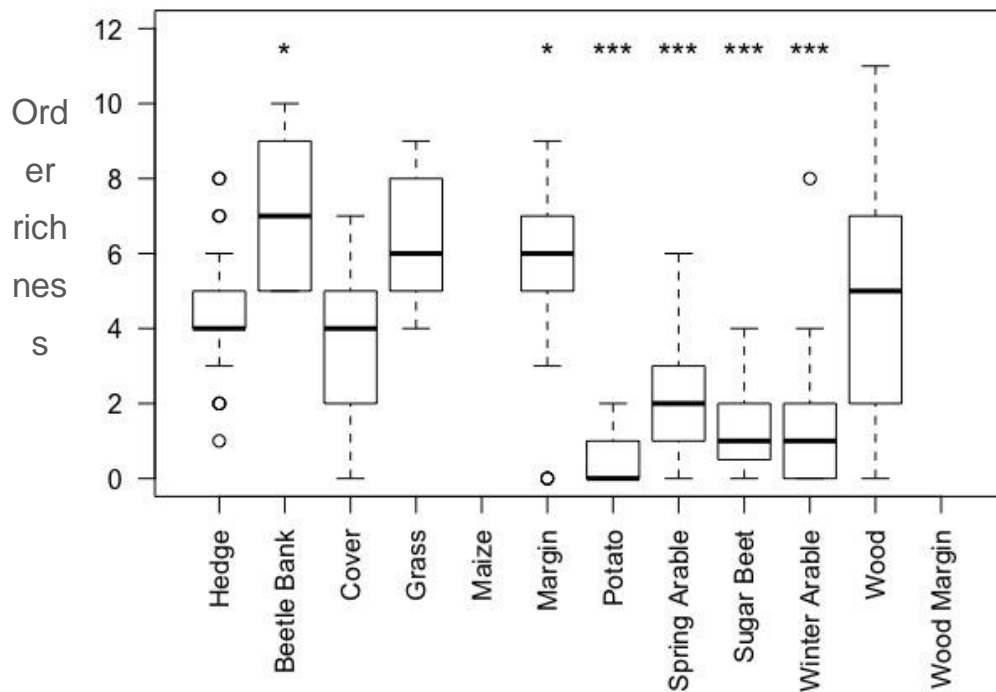

Figure 2.15 Total richness of individual invertebrate Orders in different habitat types at Hildersham. Significance markers refer to comparisons between each habitat and hedgerows as the reference category. Missing bars represent habitats that were not present at the Hildersham farm.

Whilst direct comparisons between the two farms cannot be made due to the sampling being carried out in different years at the two farms, it is worth noting by vacuum sampling, 20 different Orders were collected and the community composition at Wenvoe was dominated by Hemiptera 27.64%, Diptera 23.72%, Coleoptera 20.06% and Araneae 12.41%. In contrast, Araneae 32.29%, Hemiptera 17.06%, Coleoptera 14.68%, and Hymenoptera 12.27%

dominated the vacuum samples from the simplified Hildersham landscape, where 14 different Orders were collected.

2.4 Discussion:

In this study, the abundance and diversity of key invertebrate resources across two contrasting farm landscapes were quantified using a broad-spectrum sampling approach and a suite of different sampling methods across different landscape elements. Understanding the distribution of invertebrate food resources provided by different landscape elements is critical to the understanding of prey selection by birds and whether diet reflects availability or preference, if agro-ecosystems are to be managed more sustainably, and the current declines in farmland birds reversed. This study has revealed striking spatial variation in relative abundance and diversity of food availability for insectivorous (invertivorous) farmland vertebrates.

Farm and landscape comparisons confirmed that both of the farms selected were broadly representative of the wider landscape in that region. The farmland landscape of the South Wales region differed from that of Cambridgeshire in terms of greater spatial complexity and consisted of smaller fields, with shorter perimeters, when compared to the more intensively managed, less complex agricultural landscape of Cambridgeshire. Stratified sampling of invertebrates was carried out using four different methodologies, to determine how 'bird food' distribution varies across the different elements within farmland, in two contrasting farming landscapes. This was the primary aim of this chapter, rather than a direct comparison of invertebrates between farms of different complexity, as due to logistical constraints, sampling was conducted in different years at the two farms. Invertebrate abundance may vary between years, even within the same crop type (Aebischer 1991; Moreby and Southway 2002), as well as varying within years (Holland & Reynolds 2003), and between crop types (Holland *et al.* 2002; Moreby and Southway 2002). However, broad comparisons are possible; invertebrate trapping across the more heterogeneous mixed arable and livestock farm at Wenvoe, South Glamorgan, yielded a greater number of invertebrate individuals and a higher taxonomic richness at the Order level, for each of the four different methodologies. Generally, these results supported previous research showing that an increasing proportion of

more natural areas correlates positively with the increased abundance and diversity of taxa found in more heterogeneous landscapes (Aviron *et al.* 2005; Tschardtke *et al.* 2005; Billeter *et al.* 2008; Weibull *et al.* 2003). Invertebrate abundance and diversity are also positively correlated with a greater diversity of cropping (Siriwardena *et al.* 2000; Benton *et al.* 2003), and negatively correlated with mean crop field size; the latter association was found to be unrelated to the cover of natural and semi-natural areas (Fahrig *et al.* 2015). A diversity of cover types should provide habitat and resources for a larger variety of invertebrates, probably at least partly due to the stability of these cover crops over time, relative to the frequently disturbed commercial crops, and also due to the inability of many invertebrate species to access their critical resources within the highly-productive monoculture environment. Overall, invertebrate species richness increased with habitat complexity, and a fine-grained mosaic of agricultural habitats appears to provide sufficient foraging habitats for bird species which require a diversity of resources over spatial and temporal gradients (reviewed in Vickery *et al.* 2009)

Non-cropped boundary habitats (field margins, beetle banks, hedgerows), were found to be of particular importance for maintaining a high overall abundance and richness of invertebrates as a resource for foraging birds in agricultural landscapes. Field boundaries have been shown to be important for maintaining biodiversity within crops for invertebrates, often providing an over-wintering site for the less mobile invertebrates such as the larger Carabidae and Lycosidae (Holland *et al.* 2009; Holland and Fahrig 2000; Merckx *et al.* 2009; Merckx *et al.* 2012). The mid-field location of “beetle banks” aims to reduce the distance that arthropods must disperse across arable fields (by providing “stepping stones” for dispersing invertebrates and provide refuges for beneficial invertebrates (Thomas *et al.* 1991). Thus, beetle banks contain more stable and abundant invertebrate populations when compared to conventional farmland habitats such as cereal crops (Thomas *et al.* 2001; MacLeod *et al.* 2004).

Different landscape elements were revealed to hold significantly different foraging resources for thrushes, when considering important taxa previously identified in the diet of farmland thrushes, with the overall abundance and richness of invertebrate taxa differing between landscape elements within each farm landscape. Earthworms are a crucial component of the breeding season diet of farmland thrushes (Chamberlain *et al.* 1999; Gruar *et al.* 2003).

Across the Wenvoe farm site, earthworm abundance was found to differ significantly between landscape elements. The relatively undisturbed grass and field margin sites supported significantly more earthworms, and a greater species richness of earthworms, than the arable fields where agronomic operations can negatively influence earthworm abundance. Ploughing, tillage and other physical disturbance is known to impact heavily on earthworms, both directly and indirectly, through reduced food availability and physical impediment (Briones and Schmidt 2017). Chemical applications (fertilisers and pesticides) can have a negative impact on earthworm populations. Many molluscicides contain copper, which can cause earthworms to avoid affected soils (Van Zwieten *et al.* 2004), as copper accumulation in earthworm tissue is highly toxic to them (Qiu *et al.* 2014).

Livestock grazing of grass fields across the Wenvoe site is known to positively impact the frequency and biomass of earthworms, as organic matter in the form of dung provides a rich nutrient source for earthworm populations. Earthworms were significantly less abundant in the woodland quadrats, which is likely to be due to the dense soil having reduced penetrability, physically impeding the earthworms.

Earthworm extraction techniques are subject to bias regarding life history, size and species (Lawrence and Bowers 2002). The efficiency of extraction techniques to sample earthworms can also be biased by preceding environmental factors. Nevertheless, the technique provides a repeatable and standardised method for measuring earthworm abundance and species diversity in different locations. Sampling in Hildersham in late June during a prolonged dry period may have resulted in a limited number of earthworms, as individuals may have entered aestivation, reducing overall earthworm activity significantly (Eisenhauer *et al.* 2008). In contrast, sampling was carried out in Wenvoe during October, when recent rainfall was likely to have made earthworms more active and thus more likely to respond to the chemical expellant. However, site-differences in sampling periods were due to the constraints of work schedules.

Molluscs are another essential prey resource for foraging thrushes. Most previous research into slugs has been undertaken as a means of assessing the biological control of gastropod pests (Glen *et al.* 2005; Hommay *et al.* 2003), rather than determining their abundance in

terms of prey availability for farmland thrushes. Results must be interpreted with caution as sampling was conducted in late October and will not necessarily represent the availability of slugs for foraging birds during the breeding season. For example, the high number of slugs collected from the arable crops may not be representative of their availability in these crops at other times of year, as the farmer had yet to apply the winter application of molluscicide, SluXX. Slug refuges set across Hildersham in late June yielded no slugs, as drier conditions, unfavourable to mollusc activity, may have caused slugs to reside deeper in the soil (Hunter 1966) and thus become less likely to be detected under the refuges. The low moisture content of the calcareous soils of the Hildersham farm are known to negatively impact on slug breeding and survival (Carne-Cavagnaro *et al.* 2006).

Pitfall trapping across the Wenvoe farm was dominated by Coleoptera; an important prey resource in the diet of farmland birds (Wilson *et al.* 1999; Holland *et al.* 2006), especially Song Thrushes (Gruar *et al.* 2003). Several studies have found that increased farmland heterogeneity increases the abundance and species richness of Coleoptera, especially Carabid beetles (Holland and Luff 2000; Vasseur *et al.* 2013, Bertrand *et al.* 2016). Cover crops are an agri-environment option that increase heterogeneity of farmed landscapes and when managed correctly provide invertebrates with shelter, a suitable microclimate and a habitat rich with arable plants. Differential seed growth of the cover crops can result in sparse patches of ground and increased visibility and/or accessibility of potential prey (Morris *et al.* 2002). Non-cropped boundary habitats such as field margins and woodland margins were also important for invertebrate abundance; here the structure of the vegetation may provide a physical obstruction, reducing the detectability and accessibility of prey for foraging birds (Vickery *et al.* 2001). Foraging thrushes prefer shorter stubble, where foraging is more efficient due to a reduced need for predator vigilance.

Within the Hildersham farm, potatoes had the lowest number of invertebrate taxa sampled by both pitfall trapping and vacuum sampling, most probably due to the intensive soil cultivations during establishment, the late development of ground cover and the high insecticide inputs compared to other arable crops (Holland *et al.* 1994), all of which create adverse conditions for invertebrates.

Pitfall traps are a commonly used technique for sampling ground-active arthropods and provide an estimate of “activity-density” – that is the abundance of each Order in the samples as a reflection both of their activity during the sampling period and their density within the sampled habitat (Brown and Matthews 2016). Given that this study was primarily designed for within-farm habitat comparisons and was not aiming to obtain absolute species densities, the majority of the relative biases and potential interpretation issues encountered with pitfall trapping were not relevant (Topping and Sunderland 1992). Pitfall traps were used to generate a snapshot of the relative abundances of different ground-active invertebrates within different elements of the farmed environment. Active prey may be more accessible to foraging birds due to the dense swards and structural simplification of arable landscapes (Vickery *et al.* 2001).

At both farm sites, the overall composition of invertebrate Orders sampled by pitfall trapping differed in relation to habitat type. However, the importance of landscape elements for invertebrate abundance were similar between the two farms, with a larger invertebrate abundance and diversity collected from cover crops, grass fields and non-cropped boundary habitats than the monoculture provided by maize, and arable crops. Beetle banks were specifically designed to provide insect-rich habitats for foraging birds under agri-environment schemes (Thomas *et al.* 1991; 2001) and are often found dividing large arable fields. This conservation intervention appeared to be highly successful as beetle banks had the highest invertebrate diversity across the Hildersham farm site, when compared to all other landscape elements.

Vacuum sampling is a more effective method than sweep-netting for collecting invertebrates near the ground and in low vegetation favoured by foraging thrushes. However, sampling is biased to smaller invertebrates (< 15mm) and less effective at collecting large insects, particularly grasshoppers (Doxon *et al.* 2011). As prey size is an important cue in avian prey selection, consideration of the size of prey obtained from vacuum sampling is required and pairing the method with pitfall trapping is recommended.

The abundance of each invertebrate Order differed between crops, however logistical constraints on assessing the size or mass of each individual meant we could not calculate

biomass along with taxonomic identification. Such an approach would have considerably increased the already labour-intensive process of identifying invertebrates to Order. Previous research has shown a discrepancy between invertebrate abundance and biomass, as the relative dominance of each taxon changed considerably when accounting for biomass and the availability of bird invertebrate food resources (Holland *et al.* 2011)

Increased compositional (variety in different cover types) and configurational (complex spatial patterning of resources) landscape complexity can result in ‘winners’ and ‘losers’ within an ecological community, as different species are associated with different land cover types and may have differing preferences for vegetation structure and sward complexity. A landscape that increases the diversity of one species group may negatively impact diversity of another, leading to low cross-taxa congruence of species diversity across habitat elements (Hess *et al.* 2006; Wolters *et al.* 2006). Relatively tall and dense, structurally diverse swards, experiencing low levels of management, have been shown to support abundant invertebrates and larger species of Coleoptera and Orthoptera (e.g. Siepel 1990, Blake *et al.* 1994). Alternatively, when vegetation is maintained at low heights (5–15cm), higher densities of phytophagous and saprophagous species of Collembola, Coleoptera and Hymenoptera, can be found (McHugh 2015). Frequent management of margin habitats through cutting can result in a reduction in the abundance and diversity of most species, and higher-order taxonomic groups within the invertebrate community (Morris 2000; McCracken and Tallowin 2004). Previous studies have also highlighted the preference of Araneae for habitats with fewer niches (Blake *et al.* 2013).

Vegetation structure can also directly affect the foraging efficiency of farmland birds, through physical obstruction and by reducing the detectability and accessibility of key invertebrate prey. Species such as Blackbird and Starling *Sturnus vulgaris* prefer shorter stubble, where the need for vigilance is less, and so foraging more efficient; increased vegetation height will decrease their ability to detect predators, their mobility and their ability to detect prey (Whittingham and Markland, 2002; Butler *et al.* 2005). However, predator avoidance strategies vary between species, and in contrast Grey Partridges *Perdix perdix* and Corncrakes *Crex crex* rely on crypsis to avoid predation and prefer plots with taller vegetation. The ability to detect and access prey will also be influenced by vegetation structure; for example, high

proportions of bare ground increase the accessibility of invertebrate prey (Perkins *et al.* 2000). Farmland birds experience a trade-off between the magnitude of resource provision, time spent foraging (which also determines the risk of nest predation), and energy expended travelling to foraging patches (Brickle *et al.* 2000).

Overall this study attempted to address a previously recognised knowledge gap identified in Chapter 1, by assessing the spatial variation, relative abundance, and diversity in food availability for invertebrate feeding farmland birds, within habitats across landscapes of differing complexity. Invertebrates are an essential dietary component for most farmland bird species, and the abundance, diversity and detectability of invertebrates during the breeding season play a key role in the reproductive success of farmland birds (Holland *et al.* 2006; Holland *et al.* 2011). Nationally, invertebrate taxa are severely declining in abundance and diversity on farmland (Burns *et al.* 2013). Furthermore, the range of some taxa is contracting (Holland 2002; Fox *et al.* 2014) and species dominance is changing (Chamberlain and Fuller 2001), which may disrupt food supplies for birds. The decline of farmland invertebrates has been attributed to changes in farming practices, including increased specialisation of farming, decreasing undersowing, depth and timing of cultivation, reduction in the areas of non-cropped boundary habitats and the introduction and widespread use of insecticides, molluscicides and herbicides. Changes in invertebrate food accessibility, quality or quantity, are believed to be, at least in part, responsible for passerine population declines through both a reduction in fledging success, and subsequent reduction in recruitment. As well as a requirement for increased adult work rate during the breeding season to adequately provision the brood. Indeed, access to resources rather than food abundance *per se* could be the critical factor in determining habitat use by farmland birds (Atkinson *et al.* 2005). Developing an understanding of the invertebrate food resources provided by different landscape elements is critical to the understanding of prey selection by birds, and the implications for thrush diet and foraging behaviour of the spatial variation in invertebrate abundance and diversity are discussed further in Chapter 5.

2.5 Supplementary material

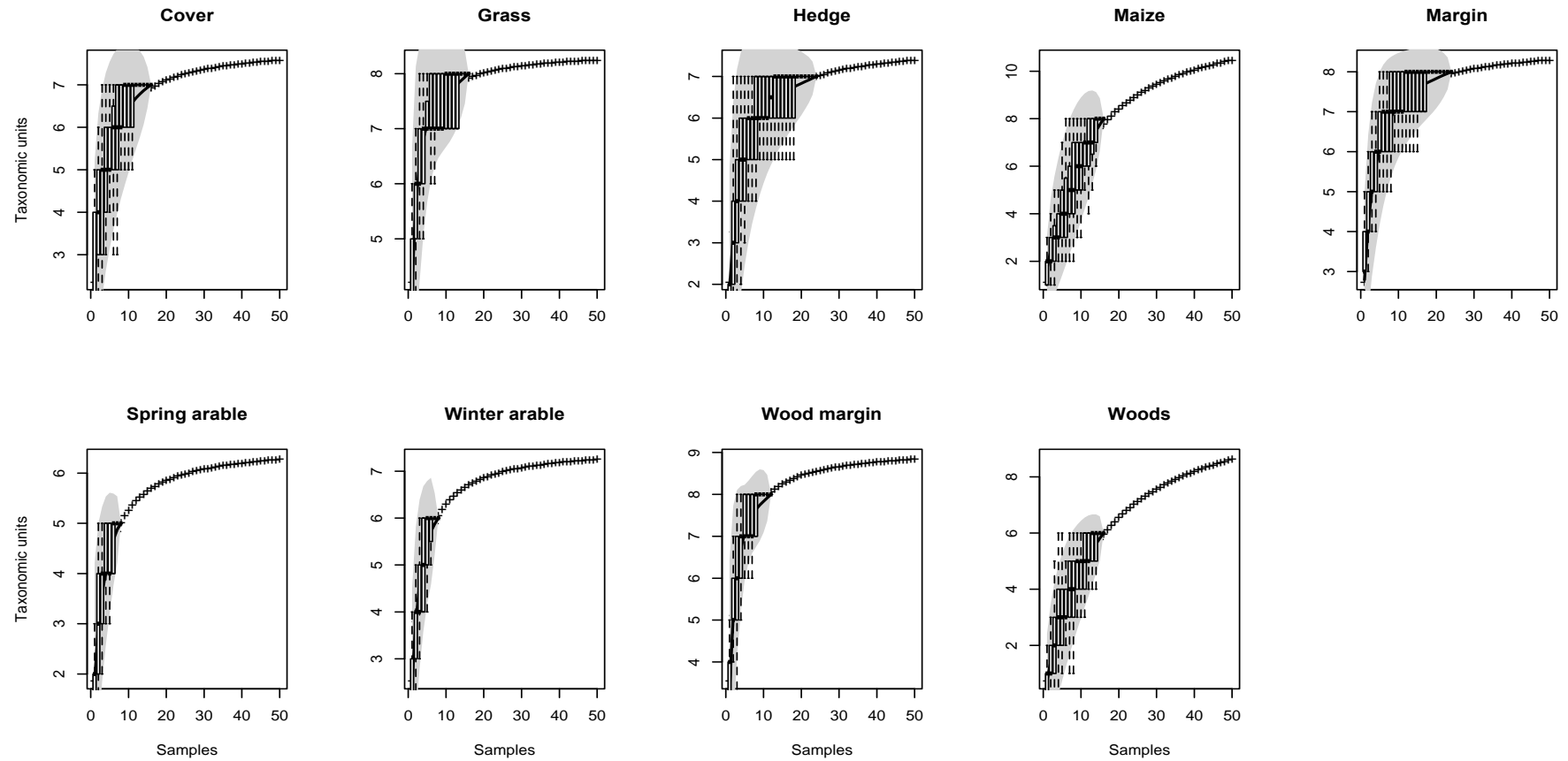

Figure S2.1: Species accumulation curves for the different habitat types at Burdon's Farm, Wenvoe, South Glamorgan, based on the accumulation of taxonomic units (species) detected across successive mustard extractions for earthworms. Boxplots from raw data based on 100 permutations of samples in a random order are overlaid by confidence intervals (grey shading) and predicted points, denoted by "+".

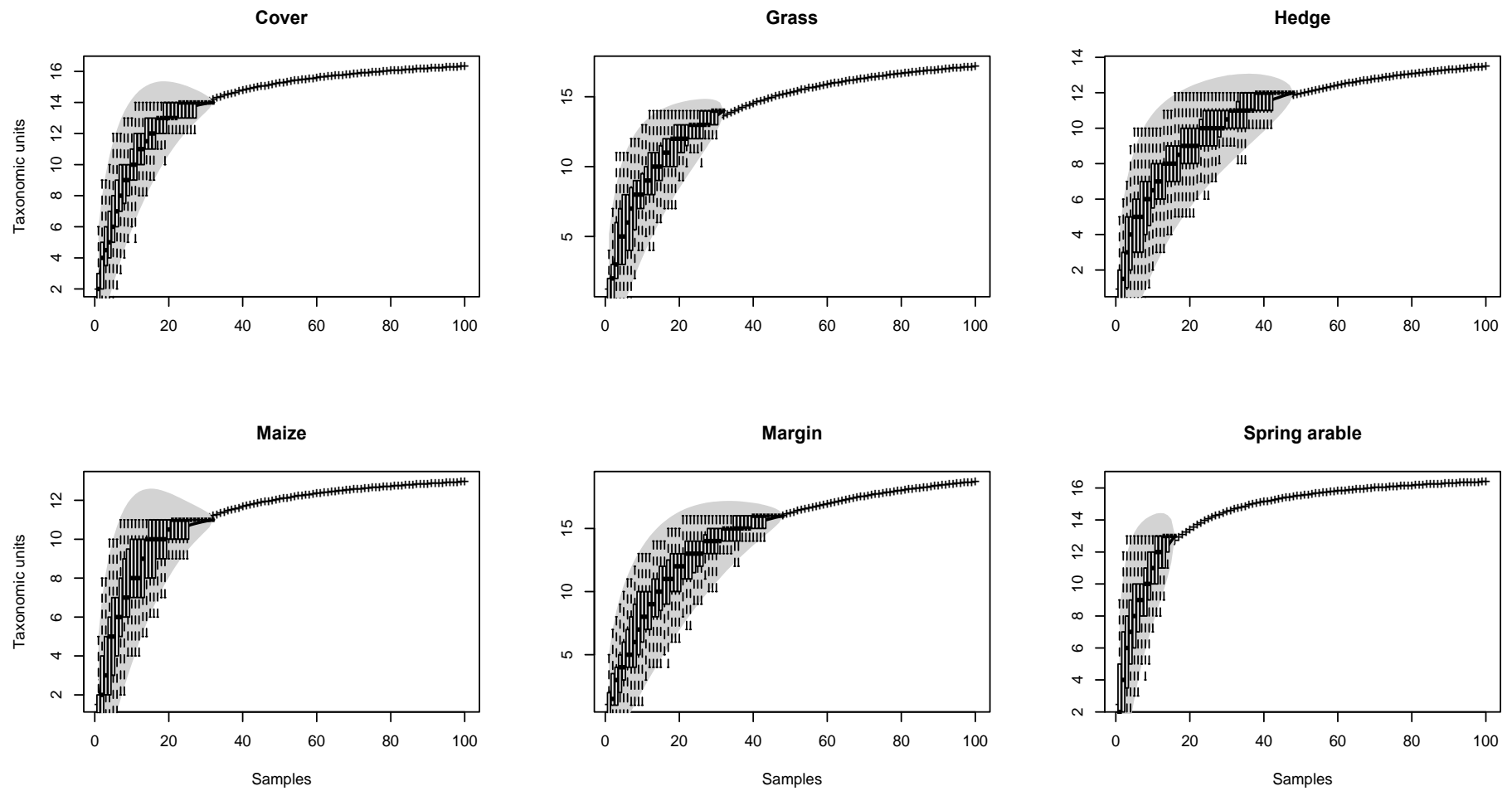

Figure S2.2a: Species accumulation curves for the different habitat types at Burdon's Farm, Wenvoe, South Glamorgan, based on the accumulation of taxonomic units (Species) detected across successive baited slug refuges. Boxplots from raw data based on 100 permutations of samples in a random order are overlaid by confidence intervals (grey shading) and predicted points, denoted by "+".

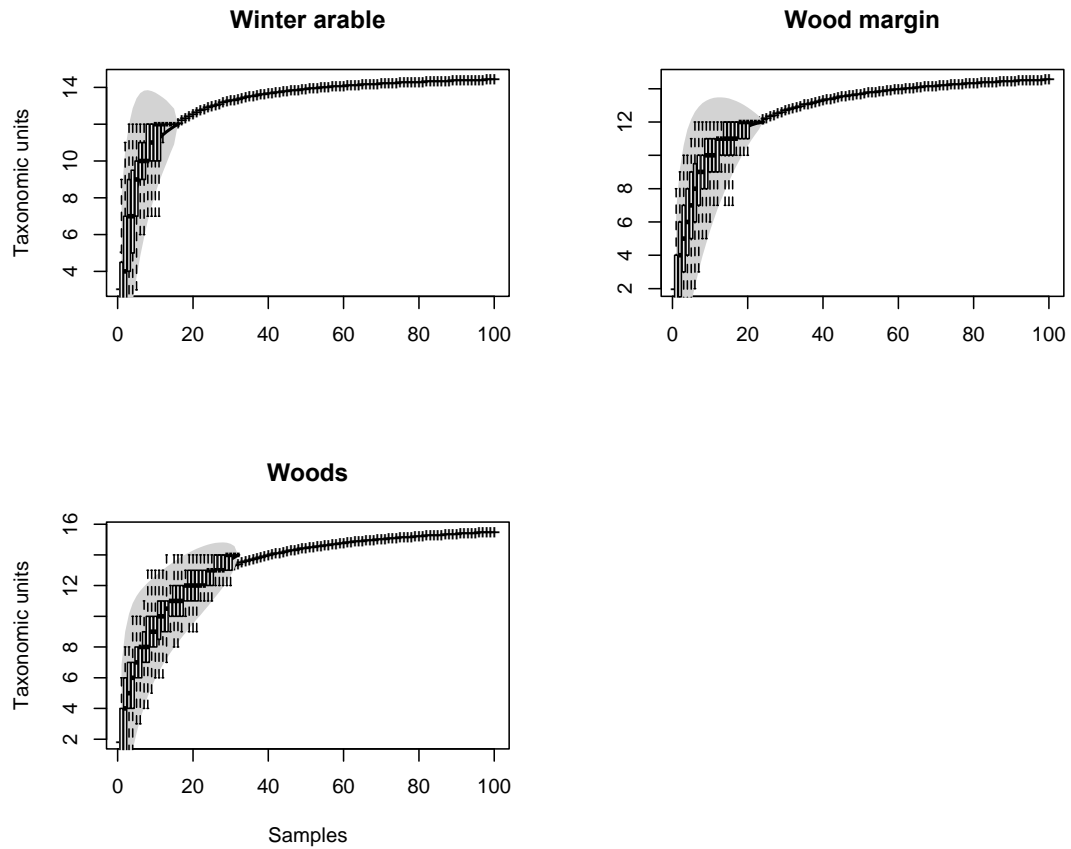

Figure S2.2b: Species accumulation curves for the remaining different habitat types at Burdon's Farm, Wenvoe, South Glamorgan, based on the accumulation of taxonomic units (Species) detected across successive baited slug refuges. Boxplots from raw data based on 100 permutations of samples in a random order are overlaid by confidence intervals (grey shading) and predicted points, denoted by "+"

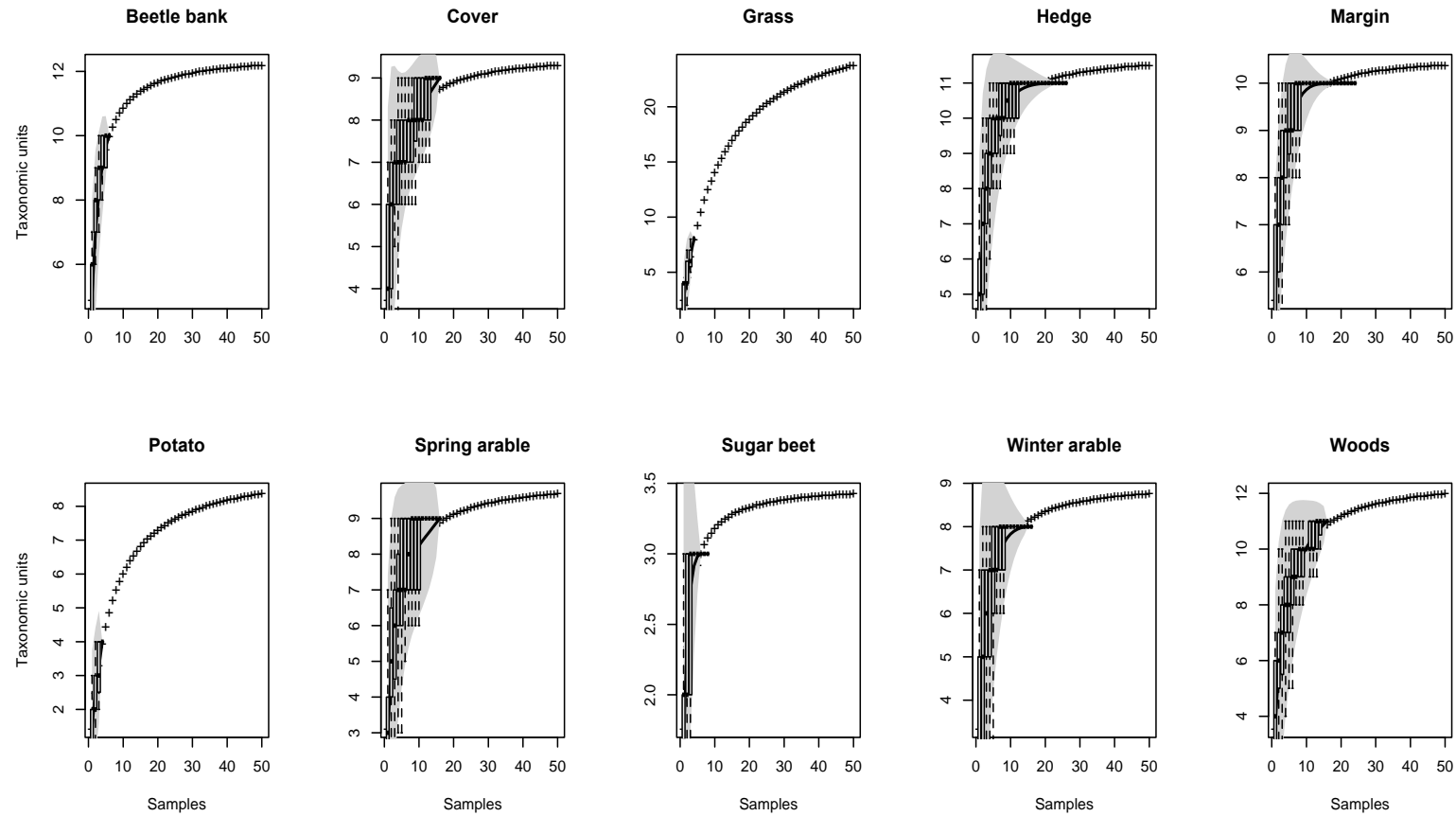

Figure S2.3: Species accumulation curves for the different habitat types at Lay Rectory Farm, Hildersham, Cambridgeshire based on the accumulation of taxonomic units (Orders) detected across successive pitfall traps. Boxplots from raw data based on 100 permutations of samples in a random order are overlaid by confidence intervals (grey shading) and predicted points, denoted by “+”.

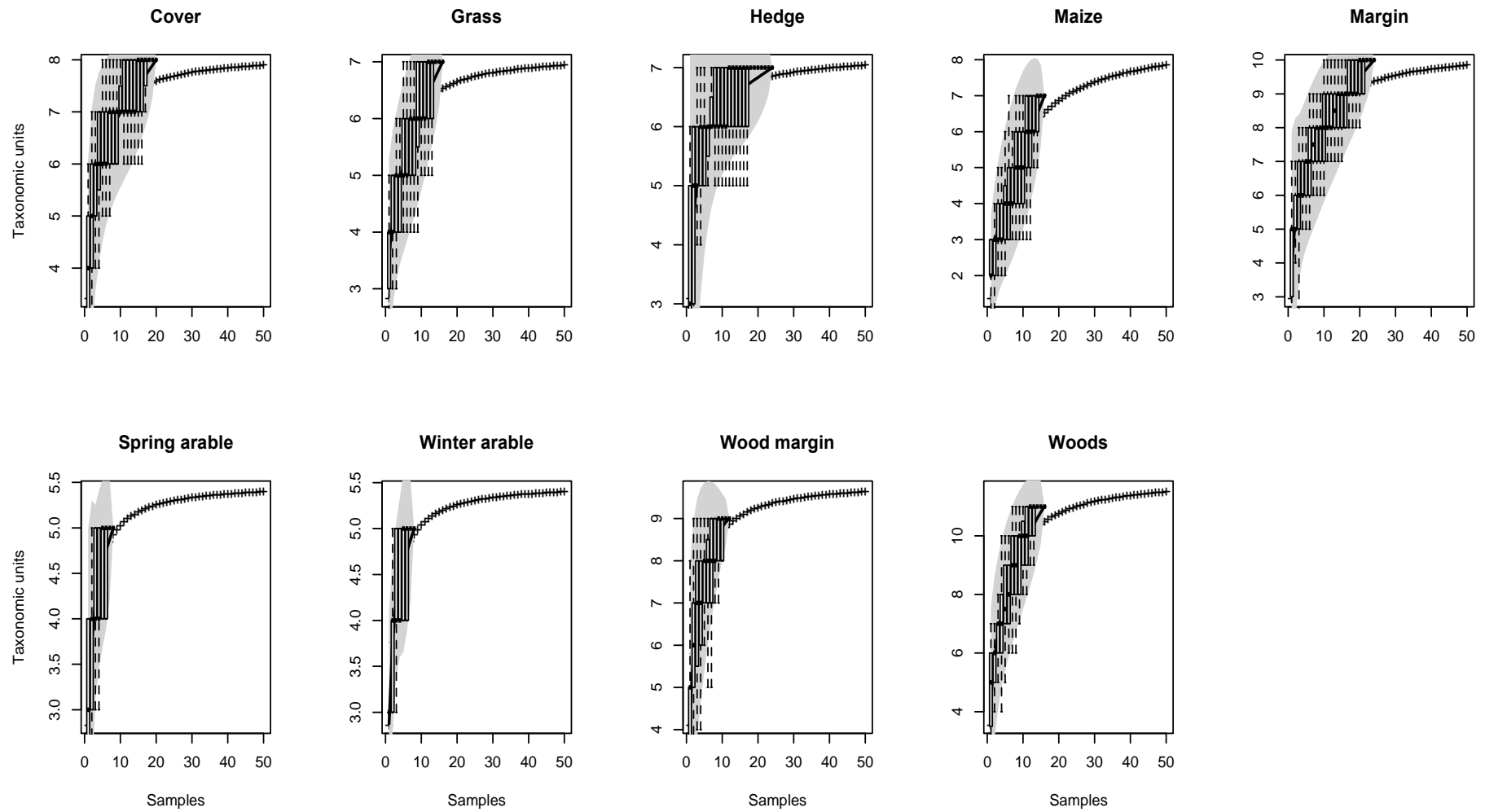

Figure S2.4: Species accumulation curves for the different habitat types at Burdon's Farm, Wenvoe, South Glamorgan based on the accumulation of taxonomic units (Orders) detected across successive pitfall traps. Boxplots from raw data based on 100 permutations of samples in a random order are overlaid by confidence intervals (grey shading) and predicted points, denoted by "+".

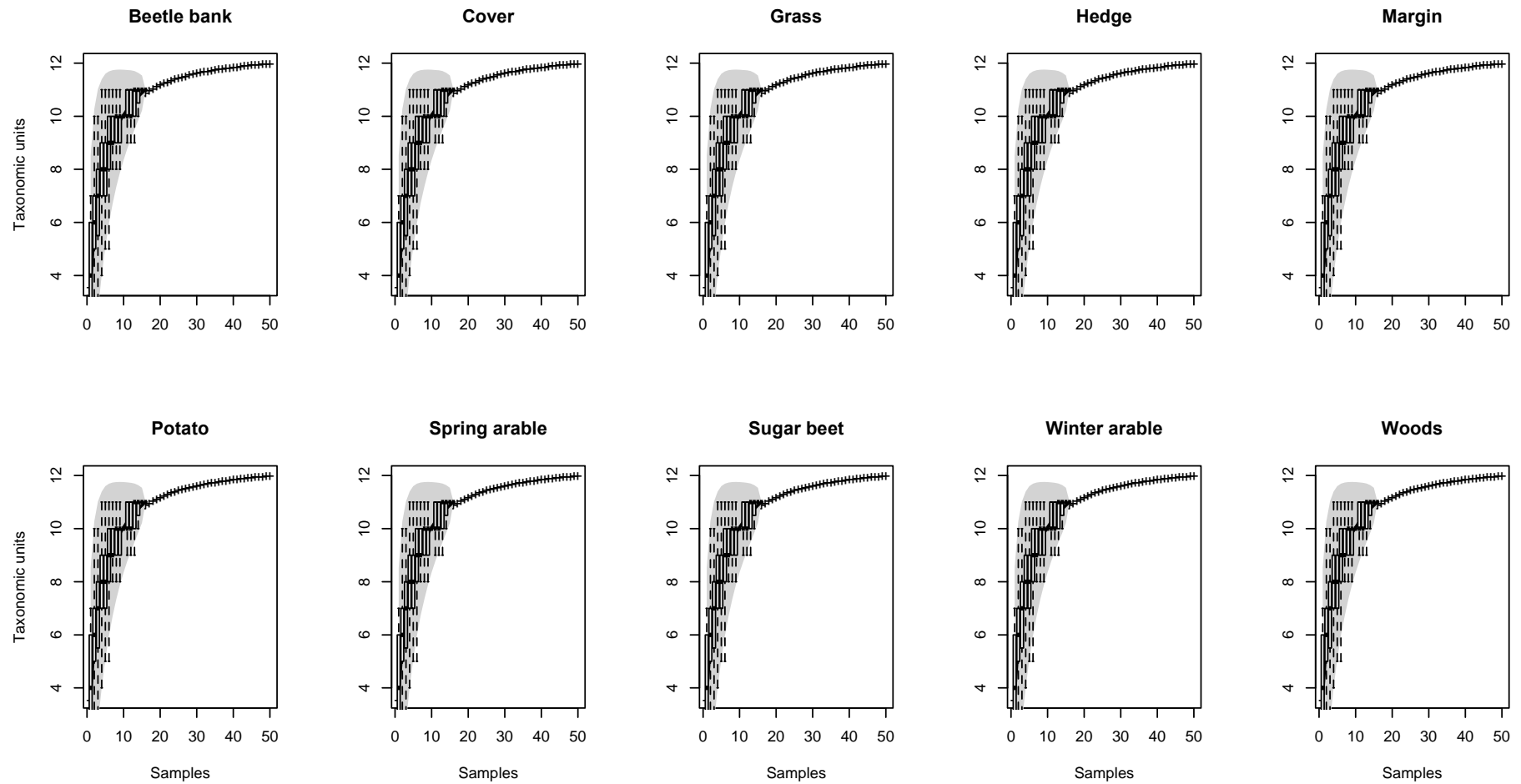

Figure S2.5: Species accumulation curves for the different habitat types at Lay Rectory Farm, Hildersham, Cambridgeshire based on the accumulation of taxonomic units (Orders) detected across successive vacuum samples. Boxplots from raw data based on 100 permutations of samples in a random order are overlaid by confidence intervals (grey shading) and predicted points, denoted by “+”

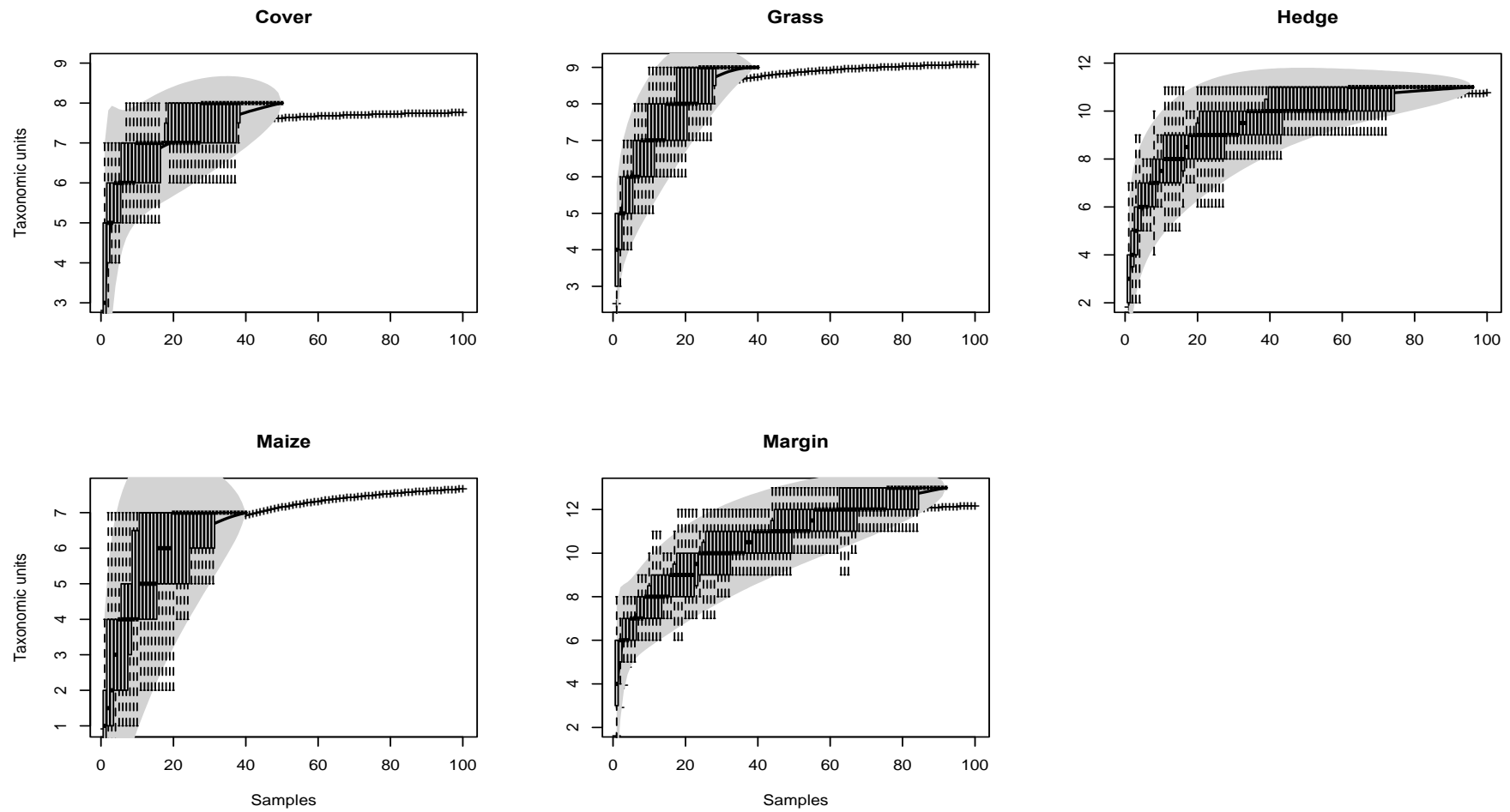

Figure S2.6a: Species accumulation curves for the different habitat types at Burdon’s Farm, Wenvoe, South Glamorgan, based on the accumulation of taxonomic units (Orders) detected across successive vacuum samples. Boxplots from raw data based on 100 permutations of samples in a random order are overlaid by confidence intervals (grey shading) and predicted points, denoted by “+”

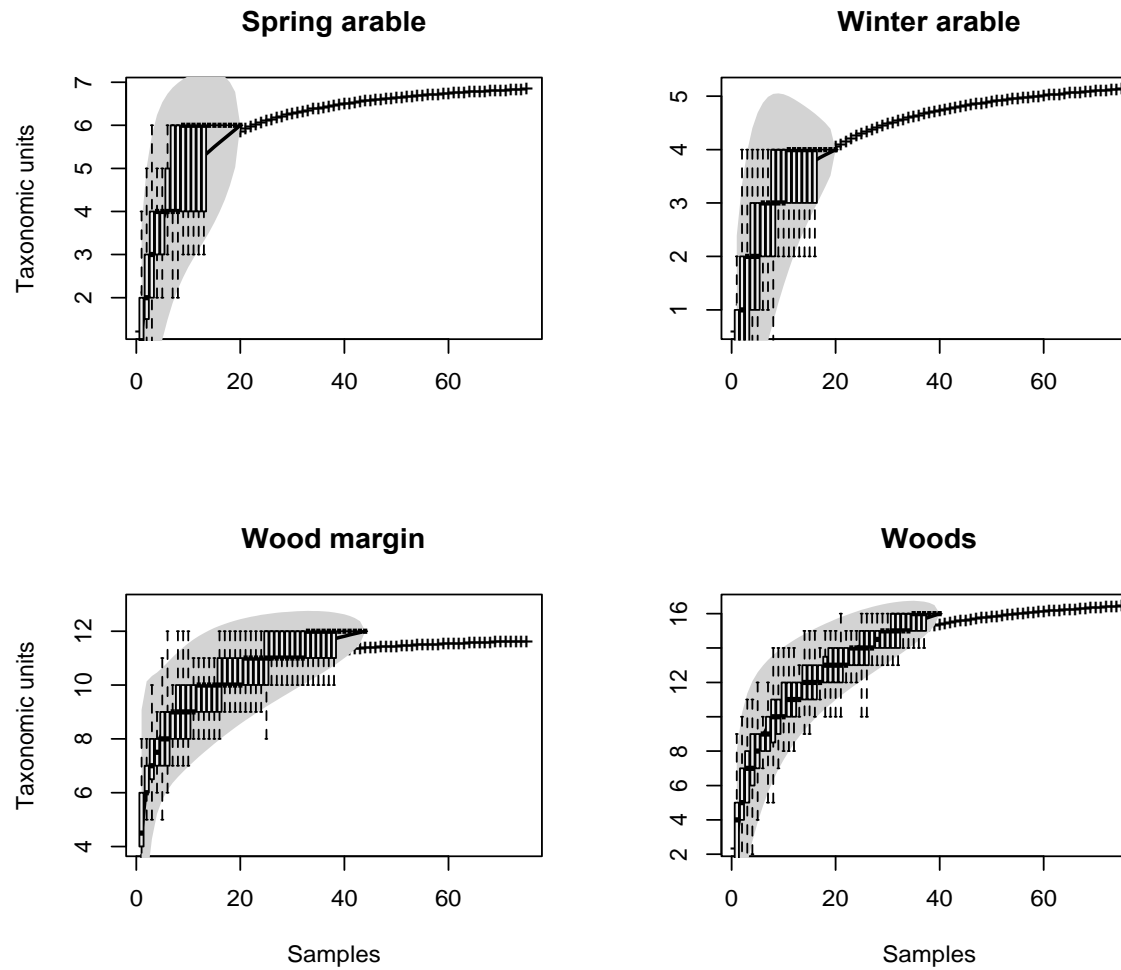

Figure S2.6b: Species accumulation curves for the different habitat types at Burdon’s Farm, Wenvoe, South Glamorgan, based on the accumulation of taxonomic units (Orders) detected across successive vacuum samples. Boxplots from raw data based on 100 permutations of samples in a random order are overlaid by confidence intervals (grey shading) and predicted points, denoted by “+”

CHAPTER 3: **Primer evaluation:**



“That’s the wise thrush; he sings each song twice over, lest you should think he never
could recapture the first fine careless rapture!”

Robert Browning

***In silico* evaluation of COI metabarcoding primers available for high-throughput sequencing dietary analysis, and subsequent application for characterising dietary preferences.**

Dietary studies are essential to understand the full spectrum of the trophic ecology of a species. Over the last decade, DNA-based methods for inferring diet, and network analyses of ecological systems, have expanded with new technologies and analytical techniques. The success and accuracy of dietary studies using metabarcoding and high-throughput sequencing (HTS) are contingent on knowledge of the limitations and advantages of both the target region and of the primer pair selected. Ideal primers should be informative, with broad taxonomic coverage and the ability to provide species-level resolution. The suitability of known ‘universal’ cytochrome oxidase (COI) primers, deemed the gold standard for analysis of the diets of terrestrial invertebrates, were evaluated *in silico*, against a database of complete mitochondrial genomes, using ecoPCR. In total, 19 forward and 22 reverse primers were considered and verified in 118 different combinations, which amplify a fragment of between 100 and 350 base pairs (bp) of the COI gene region. Further *in vitro* evaluation was then carried out for 21 primer combinations. The primer pair jgLCO1490/EPT-long-uniRed targeted a short amplicon of 133 bp to maximise taxonomic coverage and hence the overall abundance of prey sequences. The primers mICOLintF/CI-N-2191(Nancy) targeted a longer amplicon of 306 bp to improve taxonomic resolution. Both primer pairs were selected for their suitability for screening faecal samples collected from Blackbirds and Song Thrushes in farmland habitats.

3.1 Introduction:

Understanding trophic interactions is a fundamental task in ecology. Dietary analyses provide the key for understanding species interactions (Razgour *et al.* 2011; Salinas-Ramos *et al.* 2015), and determining intra- and inter-specific niche specialisation (Kratina *et al.* 2012). Niche overlap, resource partitioning and competition between species can also be assessed (Sherry *et al.* 2016). Such studies allow us to understand the regulation and flow of nutrients through food webs, the structure of ecological communities, and their dynamics (Clare 2014;

Evans *et al.* 2016; Roslin and Majaneva 2016). In fact, determining diet is a vital prerequisite for a detailed understanding of animal ecology, evolution and conservation.

Over the years, a suite of different techniques has been used to describe and quantify dietary ranges and components, allowing for the analysis of food webs and their dynamics. Molecular analysis of faeces (Symondson 2002) provides an alternative, non-invasive approach to determine animal diet. Molecular methods can supplement or replace direct observation of foraging (Chamberlain *et al.* 1999b; Deagle *et al.* 2006), visual inspection and microscopic examination of faeces (Gruar *et al.* 2003), and more invasive techniques such as the use of neck ligatures to prevent nestlings swallowing food (e.g. Johnson *et al.* 1980). However, prey DNA is often highly degraded, preventing the amplification of long fragments (Ball *et al.* 2006; King *et al.* 2008; Pompanon *et al.* 2012).

Prior to 2009, the majority of molecular-based dietary analysis studies were carried out using polymerase chain reaction (PCR) based sequencing approaches (Höss *et al.* 1992; Kohn and Wayne 1997). This procedure was time-consuming, labour-intensive and expensive, and required amplification of DNA using either general primers or group-specific primers, followed by the cloning of PCR products within bacteria and subsequent direct sequencing of the cloned products to identify individual prey taxa. The development of high throughput (next-generation) sequencing (HTS) techniques, first deployed in dietary analysis by (Deagle *et al.* 2009) now provides a robust means of accurately and cost-effectively examining the complete dietary breadth of species at a scale and level of precision not previously available. These methods offer taxonomic identification of prey items within highly diverse diets, including both rare prey items and species never formerly recorded as prey, as they leave no hard parts in faeces (Brown *et al.* 2012). This revolution in research on predator-prey interactions is providing an unprecedented level of insight into trophic interactions, species interactions and ecological networks.

Molecular analyses of trophic interactions utilise the metabarcoding approach, defined by Cristescu (2014) as “a rapid method of high-throughput, DNA-based identification of multiple species from a complex and possibly degraded sample of eDNA, or mass collection of specimens”. Thus, the goal of metabarcoding is to maximise taxonomic coverage and

assess complete diversity with the use of one or two gene regions. Metabarcoding provides unique opportunities to identify multiple unknown prey organisms from a single sample, by isolating DNA, amplifying a 'universal' barcode through PCR, HTS and finally, taxonomic assignment of sequences into Molecular Operational Taxonomic Units (MOTUs; Floyd *et al.* 2002), and identifying taxa by comparison with a barcode library. Using these methods, millions of DNA sequences can be obtained from a single sample. Metabarcoding was developed initially by/for microbiologists (Sogin *et al.* 2006), but is now widely implemented across a range of ecological contexts, including dietary analyses of both herbivores and carnivores (Pompanon *et al.* 2012; Clare 2014).

The success and accuracy of dietary studies utilising metabarcoding and HTS are contingent on methods being aligned with a clearly defined research question, *a priori* knowledge of the target animals' potential diet from observations and previous literature, and comprehension of the limitations and advantages of both the method selected and the target region (Nielsen *et al.* 2017). Both the primer pair and target loci chosen will determine accuracy, efficiency, taxon detectability and subsequent identification, as molecular analyses utilising metabarcoding rely on the amplification of a particular region of interest from an often-unknown mixture of different taxa. There is no such thing as a universal barcode, as each barcode has its limitations, and molecular markers should be chosen that have sufficient taxonomic resolution, yet have a sufficiently broad taxonomic range to provide the best coverage for the study system selected. Metabarcoding primers should target hypervariable highly informative regions and provide a representative amplification of all DNA molecules present. Finally, primers should target short amplicon fragments due to the highly degraded nature of the DNA in, for example, faeces or environmental samples. Ideally, primers would be extremely general and capable of generating amplicons for all potential prey species, even for a generalist host species. Amplicons could then be compared to a curated reference library to identify sequences (e.g. GenBank, Barcode of Life Database (BOLD), or a personally compiled database). Both the confidence, and the resolution, of taxonomic assignments of unknown metabarcoding sequences into MOTUs are highly dependent on the richness of reference sequence databases for the target region (Gibson *et al.* 2014; Porter *et al.* 2014).

Primers that target both mitochondrial and nuclear ribosomal DNA (12S, 18S, 28S) are relatively conserved and can amplify a broad range of Phyla, but are often not suitable for metabarcoding. A small number of primers have been developed to target the 12S region (Sutherland 2000; Riaz *et al.* 2011; Shehzad *et al.* 2012). While the 12S region has high rates of molecular evolution, making it suitable for species delineation and identification, the taxonomic reference database for this region is limited, which can hamper the interpretation of 12S sequences. Nuclear ribosomal 18S and 28S markers have been developed to amplify short segments of DNA, but can often underestimate diversity, as these regions have evolved slowly and therefore have less frequently been used for metabarcoding studies (but see 18S: Corse *et al.* 2010; 28S: Vestheim and Jarman 2008). The 18S gene region is commonly used as a DNA marker for microbial eukaryotes (Creer *et al.* 2010). Primers that target 18S are often used in combination with 16S markers to detect broad taxonomic assemblages; however, taxonomic ambiguity remains, as these regions are not efficient at taxonomic resolution. For example, Deagle *et al.* (2007) used a combination of 16S, 18S and 28S primers to analyse the diverse marine prey (amphipods, cephalopods, euphausiids and fish) of Macaroni Penguins *Eudyptes chrysolophus* during chick rearing, identifying prey to the level of order or suborder.

Of the mitochondrial genes encoding ribosomal DNA, 16S possesses hypervariable regions with sufficient phylogenetic signal to discriminate taxa, flanked by regions of highly conserved sequence suitable for primer design. Consequently, 16S ribosomal DNA is the preferred candidate for the molecular analysis of seabird diets (Deagle *et al.* 2010; Alonso *et al.* 2014; Waap *et al.* 2017). Despite the potential for taxonomic resolution and conserved regions, limited studies have considered 16S primers for invertebrate metabarcoding; apart from gastropods, for which taxon 16S has been used extensively (Boyer *et al.* 2013). The use of 16S in broad taxonomic analyses is constrained by the prevalence of insertions and deletions (“indels”) that greatly complicate sequence alignments due to secondary structuring. Consequently, the databases of available barcodes available for terrestrial arthropods are limited when considering 16S.

Several recent studies have suggested that amplified 16S ribosomal markers equalled or bettered results from COI primers, as they provide broader taxonomic coverage and less

biased results than the more widely used COI region (e.g. Clarke *et al.* 2014; Deagle *et al.* 2014). However, contradictory conclusions have been reported due to the complication of selecting an appropriate MOTU clustering threshold (Alberdi *et al.* 2017; Clarke *et al.* 2017). With any marker region there is a trade-off: for more conserved ribosomal regions the potential for superior taxonomic coverage may come at the expense of species-level resolution and introns (non-coding sections). Compared to traditional Sanger sequencing, HTS platforms have a higher error rate (Edgar and Flyvbjerg 2015). Sequencing errors in ribosomal genes caused by single nucleotide polymorphisms and indels are challenging to detect and could result in a higher probability of error in defining MOTUs, leading to subsequent errors in ecological applications and conclusions. To effectively use these regions for metabarcoding, extensive knowledge of ribosomal DNA, careful selection of bioinformatics pipelines, and computation skill are required.

COI is a protein-coding mitochondrial DNA gene that is present in all taxa, except for a limited number of protozoa (Folmer *et al.* 1994). COI exhibits a faster substitution rate than nuclear rDNA, which increases the taxonomic resolution that can be achieved using this gene region. The region's mutational properties (e.g. the high rate of substitution in the third codon position) offer the opportunity to detect and eliminate most HTS errors to prevent overestimates of MOTUs (Quince *et al.* 2009; Emerson *et al.* 2011).

DNA-based species identification through barcoding was standardised by Hebert *et al.* (2003), having been first introduced by Arnot *et al.* (1993). Initially, the suitability of COI as a barcoding region was highly scrutinised (e.g. Rubinoff *et al.* 2006), until enough empirical data demonstrated the technical plausibility and utility of COI as a standard marker capable of recognising species boundaries (e.g. Smith *et al.* 2008). Thus, COI became the standard barcode for the identification of animal specimens due to its robustness, reliability and taxonomic resolution, leading to the creation of BOLD: The Barcode of Life Data System (Ratnasingham and Hebert 2007; Taberlet *et al.* 2012). This rapidly expanding extensive reference database at standardised loci makes it possible to identify sequences to the species level, substantially increasing the benefits of the marker region. Overall, COI is a commonly used and convenient region, ideal for terrestrial macroscopic life and some freshwater applications, with all the gold standard requirements for HTS (Clare 2014).

When targeting COI, metabarcoding primers should be designed within the standardised barcoding region to allow validation of MOTUs generated against reference sequences associated with taxonomic information (Taberlet *et al.* 2012). However, with any target region, there can be problems. Several studies report problems resulting from the high level of variability within the ‘Folmer’ barcoding region (~658bp; Folmer *et al.* 1994), making it problematic to locate conserved primer-binding sites for amplifying unbiased short barcodes (Deagle *et al.* 2007; Deagle *et al.* 2014; Sharma and Kobayashi 2014). As the third codon position is relatively unconstrained, this increases the chance of primer mismatches when targeting genetically diverse taxonomic groups such as insects (Deagle *et al.* 2014). The coexistence of multiple mitochondrial haplotypes within an individual (heteroplasmy), documented in various insect species across several Orders, may cause marked divergences between the results of Sanger sequencing and MOTUs from HTS (e.g. 12% of Lepidoptera species examined by (Shokralla *et al.* 2014)). Deagle *et al.* (2014), report that a plateau in sequence divergence (as variation at less constrained locations becomes saturated between distantly related taxa due to homoplasy) may also hinder the development of group-specific primers.

Choosing the appropriate region, and metabarcodes, are crucial for the successful recovery of DNA from environmental samples including faeces, and for taxonomic assignment of unknown specimens. As highlighted above, each region has its limitations and barcodes should be evaluated and carefully selected to provide the detection rates and taxonomic coverage for the research in hand. If research is not constrained by a lack of funds, then the use of more than one region should be considered, provided that comprehensive reference libraries are available for a broad range of different taxa. If necessary, researchers may need to create a barcode library by extracting DNA from a wide range of known dietary items or prey species available in a predator’s environment, and constructing a local reference library (e.g. Dunn *et al.* 2018). Obtaining additional biological information about the taxa that are potentially available as prey reduces the likelihood of missing important dietary contributions.

Empirical testing both *in silico* and *in vitro* provides further assurance that primers are suitable for that particular application (Ficetola *et al.* 2010; Clarke *et al.* 2014; Elbrecht and Leese 2017b; Piñol *et al.* 2018). Metabarcoding primers need to be:

- (1) Informative – Primers should be of sufficient length to contain enough phylogenetic information (but shorter barcodes are recovered more successfully from degraded biological material)
- (2) Sufficiently variable – High levels of variability with the amplicon will allow for taxonomic resolution at the species level
- (3) ‘Universal’ – Ideal metabarcodes must have conserved flanking regions to allow for the design of primers that will amplify a broad range of taxa, i.e. have high taxonomic coverage
- (4) Highly discriminatory – Low intraspecific divergence but high interspecific divergence (the ‘barcoding gap’ - e.g. Meyer and Paulay 2005; Martinsson *et al.* 2017)
- (5) Standardised – The same DNA region can be used for different taxonomic groups

In some dietary analysis studies, limitations may have led to conservative MOTU estimates, combining different taxa together in the same MOTU (Clare *et al.* 2016). Alternatively, an overextension of dietary observations may arise from mis-classification of conspecific sequences as coming from different MOTUs. Razgour *et al.* (2011) report that they may overestimate prey dietary species richness for cryptic bat species by 12%; while Clare *et al.* (2009) recorded evidence of more than twice the number of Families of prey items within Eastern Red Bat *Lasiurus borealis* diet than previously known.

The optimal target sequence length will vary depending on the gene region selected, and taxonomic resolution targeted, often resulting in a trade-off. Shorter lengths are required to overcome problems of degraded DNA, resulting in low amplification success and higher contamination by non-prey items, but the reduced length amplicons may allow limited phylogenetic discrimination and be biased towards overestimation of diversity (Clare *et al.* 2011). For COI, Hajibabaei *et al.* (2006) report a theoretical lower limit of 109 bp for taxonomic discrimination, and successfully sequenced 90% of the specimens in assemblages of moth and wasp museum specimens. Similarly, Meusnier *et al.* (2008), reported that 90% identification success at the species level is obtained with 100 bp amplicons. Provided the

amplicon is located within the 'Folmer' full-length DNA barcode region, (Hajibabaei *et al.* 2006) concluded that 135 bp fragments of COI could distinguish most species. The commonly used Zeale primers are 157 bp in length (Zeale *et al.* 2011). Barcodes of 250 bp can provide 95% species resolution, compared to a resolution of 97% when considering full length ~658 bp 'Folmer' COI barcodes (Meusnier *et al.* 2008).

If the primers selected are too degenerate, targets may amplify at lower and often unpredictable efficiency, with increased levels of non-specific amplification, variation in amplicon length and bias (Najafabadi *et al.* 2008; Klindworth *et al.* 2013; Elbrecht *et al.* 2018). Clarke *et al.* (2014) used generic arthropod COI primers and only managed to recover between 43% and 64% of species in a known mixture of arthropod DNA. Within amplified environmental mixtures, DNA sequences with lower GC content may be overrepresented, resulting in an overestimation of abundance for certain species (Suzuki and Giovannoni 1996).

Challenges may also occur if non-target DNA (e.g. predator, parasites) swamp the intended dietary information. Universal metazoan primers (e.g. Leray *et al.* 2013) will amplify all DNA present within faecal samples, but non-target DNA (such as the predator whose diet is of interest) can dominate sequences amplified from a sample, reducing the dietary information obtained (Piñol *et al.* 2014). The performance of the primers may also be hindered due to dominating non-target DNA increasing primer biases, amplification and sequencing artefacts, and reducing the potential of HTS, especially if prey and predator are phylogenetically close. McInnes *et al.* (2017a), extracted DNA from 598 scat samples collected from Shy Albatross *Thalassarche cauta* and obtained 2.9 million reads with metazoan 18S primers, of which only 15.6% were food sequences. In a separate study by McInnes *et al.* (2017b), only 449 of 1460 scat samples collected from Black-browed Albatross *Thalassarche melanophris* and Campbell Albatross *Thalassarche impavida* returned 'prey' DNA sequences when screened with general metazoan primers. The use of blocking primers may inadvertently block similar groups to some degree (Vestheim and Jarman 2008; Piñol *et al.* 2015). The utilisation of primers that amplify predator DNA may be unavoidable if a diverse range of food items are eaten, as the interpretation of dietary results may be incorrect if all the trophic connections are not correctly identified. Therefore, if

primers are selected that amplify non-target DNA, sample sizes must be increased, larger capacity HTS chips should be selected to return a greater number of sequences, and consideration must be given to increased processing and sequencing costs (Piñol *et al.* 2014; McInnes *et al.* 2017a), in order to obtain enough sequences from sufficient samples to address the underlying research question.

Conducting metabarcoding studies to determine trophic interactions with problematic primers can introduce biases. The frequently used Zeale *et al.* (2011) primers are subject to massive amplification bias (Piñol *et al.* 2018), and provide only adequate coverage for Hemiptera, Orthoptera, Coleoptera, and Hymenoptera (Clarke *et al.* 2014). Brandon-Mong *et al.* (2015) reported meagre amplification success with individual specimens during preliminary testing to evaluate suitable primers for a diverse set of arthropod Orders from a tropical Malaise trap. The forward primer ZBJ-ArtF1c (Zeale *et al.* 2011) may have a high number of mismatches due to the lack of degeneracy in only a moderately conserved flanking region (Elbrecht and Leese 2017b). The forward primer LCO1490 (Folmer *et al.* 1994) has just 4 conserved bases out of 25 bp, which results in a high number of mismatches due to the lack of degeneracy, and inadequate representation across Gastropods, Hymenopterans, Echinoderms and Nematodes (Yu *et al.* 2012; Sharma and Kobayashi 2014; Elbrecht and Leese 2017b). The primers EPT-long-univR (Hajibabaei *et al.* 2011), mICOIntF (Leray *et al.* 2013) and Uni-minibarF1 (Meusnier *et al.* 2008), contain design flaws (lacking necessary wobble bases, or have unnecessary inosine bases at a conserved position), and critical mismatches at the 3' end (Elbrecht and Leese 2017a). Just one mismatching base at the 3' end can substantially lower the extension efficiency of PCR and is capable of producing a 1000-fold underestimate of abundance (Huang *et al.* 1992; Piñol *et al.* 2014), by affecting primer sensitivity.

The present Chapter aims to evaluate the suitability of known 'universal' COI primers for invertebrates, from the literature, both *in silico* using ecoPCR and *in vitro*, and to select the best group-specific primers based on their capacity to:

- (1) Provide high levels of variability allowing good taxonomic coverage and species-level resolution

- (2) Avoid the amplification of non-target predator DNA
- (3) Work under optimal PCR conditions to achieve unbiased amplification
- (4) Amplify DNA from faecal samples collected from Blackbirds and Song Thrushes, but not amplify DNA from these predators

The careful selection of COI primers will be vital for their subsequent application for characterising dietary preferences of farmland thrushes (Chapter 4). By avoiding the use of blocking probes, we ensure that prey DNA sequences are not also inadvertently blocked. Two broad COI primer pairs suitable for dietary analysis, capable of amplifying not only Insecta, but also Annelida, Gastropoda, Mollusca and Arachnida, will be selected. These will comprise a short primer pair to maximise diversity and sensitivity, and an extended region to expand and quality-check taxonomic identity within the constraints of the < 300 bp read requirements of current HTS platforms.

3.2 Methods:

3.2.1 *Finding universal primers:*

Potential ‘universal’ COI primers capable of amplifying all invertebrate prey DNA were identified from previous literature and DNA-based dietary studies (Table 3.1). Priority was given to metabarcoding primers suitable for HTS assessment limited to the COI barcoding region (Hebert *et al.* 2003). In total, 19 forward and 22 reverse primers were considered and verified in 118 different combinations, which amplify between 100 and 350 bp of the COI gene region (Figure 3.1; Table S3.1). These criteria accounted for the current amplicon length limitations in HTS technology (current maximum of 2 x 300 base paired-end reads on Illumina Miseq allowing for overlap between paired-end sequence and the addition of individual sample and Illumina tags; Illumina 2016), and necessity to detect degraded DNA in faecal samples (King *et al.* 2008; Pompanon *et al.* 2012).

Table 3.1: Primers validated in this study to amplify the COI gene region. Direction F, forward; R, reverse. Primer sequences in bold were modified for this study.

Primer	Sequence (5' – 3')	First reference	3' location	Direction	BP
LCO1490	GGTCAACAAATCATAAAGATATTGG	Folmer <i>et al.</i> 1994	1514	F	25
LCO1490L	GGTCWACWAATCATAAAGATATTGG	Nelson <i>et al.</i> 2007	1514	F	25
LCO1490ed	TCAACMAATCATAAAGATATTGG	This study	1514	F	23
dgLCO1490	GGTCAACAAATCATAAAGAYATYGG	Meyer <i>et al.</i> 2005	1514	F	25
jpgLCO1490	TITCIACIAAYCAYAARGAYATTGG	Geller <i>et al.</i> 2013	1514	F	25
Jyothi	TTCTCAACAAATCATAAAGATATTGG	Zickovich and Bohonak 2007	1514	F	26
LepF1	ATTCACCAATCATAAAGATATTGG	Hajibabaei <i>et al.</i> 2006	1514	F	25
UniminibarF1	TCCACTAATCACAARGATATTGGTAC	Meusnier <i>et al.</i> 2008	1517	F	26
ZBJ-ArtF1c	AGATATTGGAACWTTATATTTTATTTTGG	Zeale <i>et al.</i> 2011	1535	F	30
C1-J-1632	TGATCAAATTTATAAT	Kambhampati and Smith 1995	1632	F	16
UniminibarR	GAAAATCATAATGAAGGCATGAGC	Meusnier <i>et al.</i> 2008	1668	R	24
EPTlong-uniRed	AARAAAATYATAAYAAAIGCGTG	This study	1671	R	23
EPTlong-uniR	AARAAAATYATAAYAAAIGCGTGIAIIGT	Hajibabaei <i>et al.</i> 2011	1671	R	29
C1-J-1709	AATTGGGGGGTTTGGAAATTG	Simon <i>et al.</i> 1994	1709	F	21
C1-J-1709deg	AATTGGWGWWTYGGAAAYTG	Simon <i>et al.</i> 2006	1709	F	21
C1-J-1718mod	GGAGGATTGGAAATTGATTAGT	Dallas <i>et al.</i> 2003	1715	F	23
ZBJArtR2c	WACTAATCAATTWCCAAATCCTCC	Zeale <i>et al.</i> 2011	1716	R	24
C1-J1718	GGGGGGTTTGGAAATTGATTAGTGCC	Simon <i>et al.</i> 1994	1718	F	26
C1-N1738	TTTATTCGTGGGAATGCTATGTC	Simon <i>et al.</i> 2006	1738	R	23
C1-N1738deg	TTTATTCGTGGRAATGCYATRTC	Simon <i>et al.</i> 2006	1738	R	23
C1-J-1751 Ron	GGAGCTCTGACATAGCATTCCC	Simon <i>et al.</i> 1994	1751	F	23
UEA3	TATAGCATTCCCACGAATAAATAA	Lunt <i>et al.</i> 1996	1763	F	24
HCO1777	ACTTATATTGTTTATACGAGGGAA	Brown 2010	1777	R	24
HCO1777ed	AAHCTYATRTRTTIADICDGGRAA	This study	1777	R	24
mICOlintR	GGRGGRTASACSGTTCASCCSGTSCC	Leray <i>et al.</i> 2013	1833	R	26
C1-N-1843d	GMWARWGGWGGRTAWACWGTTC	Zhang and Hewitt 1997	1843	R	23
UEA2	TCAAGATAAAGGAGGATAAACAGTTC	Lunt <i>et al.</i> 1996	1844	R	26
mICOlintF	GGWACWGGWTGAACWGTWTAYCCYCC	Leray <i>et al.</i> 2013	1859	F	26
C1-J-1859 RonII	GGTACAGGTTGAACTGTTTACCCTCC	Simon <i>et al.</i> 1994	1859	F	26
UEA4	AATTCGGTCAGTTAATAATATAG	Lunt <i>et al.</i> 1996	2087	R	24
UEA5	AGTTTTAGCAGGAGCAATTACTAT	Lunt <i>et al.</i> 1996	2090	F	24
COI-E	TATACTTCTGGGTGTCCGAAGAATCA	Bely and Wray 2004	2173	R	26
LepR	TAAACTTCTGGATGTCCAAAAAATCA	Hajibabaei <i>et al.</i> 2011	2173	R	26
HCO2198	TAAACTTCAGGGTGACCAAAAAATCA	Folmer <i>et al.</i> 1994	2173	R	23
HCO2198B	TAAACTTCAGGGTGACCAAAAAATAC	Zickovich and Bohonak 2007	2173	R	26
HCO2198-L	TAAACTTCWGGRTGWCCAAARAATCA	Nelson <i>et al.</i> 2007	2173	R	26
dgHCO2198	TAAACTTCAGGGTGACCAARAAYCA	Meyer <i>et al.</i> 2005	2173	R	26
jpgHCO2198	TAIACYTCIGGRTGICRAARAAYCA	Geller <i>et al.</i> 2013	2173	R	26
C1-N-2191	GGTAAAATTTAAAATATAAACTTC	Kambhampati and Smith 1995	2188	R	23
C1-N-2191mod	CAGGTAAAATTTAAAATATAAACTTCTGG	Dallas <i>et al.</i> 2003	2191	R	28
C1-N-2191 (Nancy)	CCCGGTAAAATTTAAAATATAAACTTC	Simon <i>et al.</i> 1994	2191	R	26

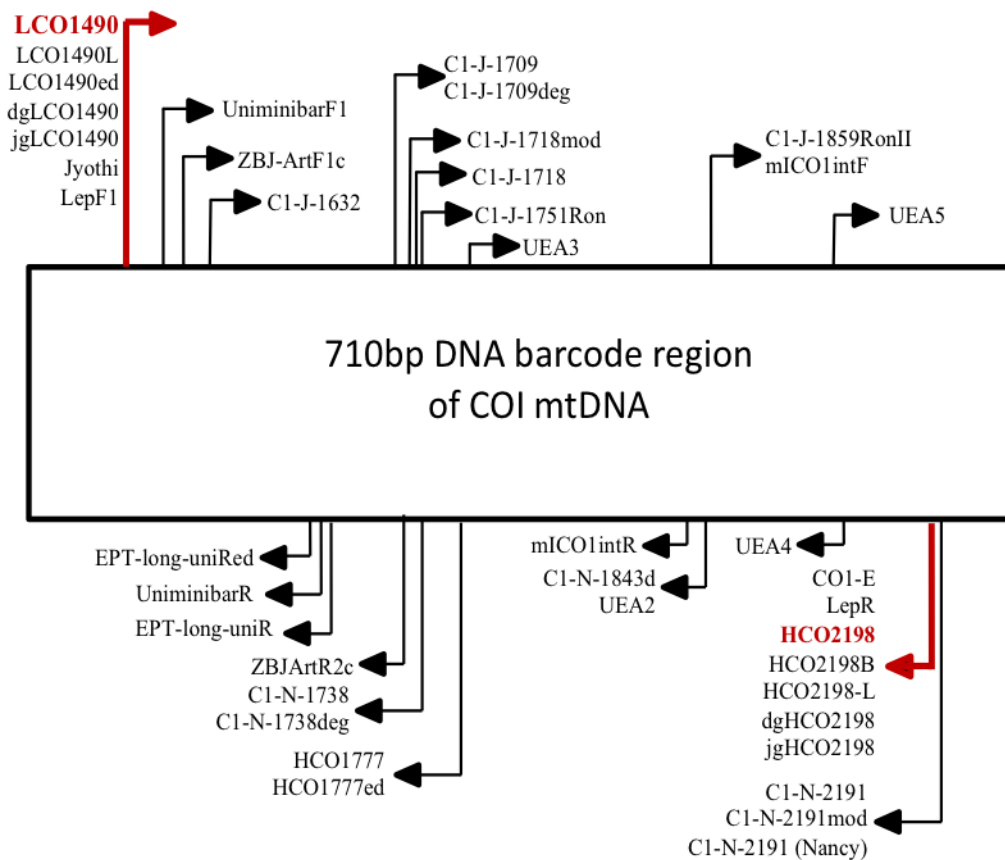

Figure 3.1: Relative positions of primers tested for Cytochrome Oxidase (COI) mitochondrial gene; in relation to the Folmer *et al.* (1994) primers LCO1490 and HCO2198 (red).

3.2.2 *In silico* evaluation:

All available complete invertebrate mitochondrial genomes were downloaded from GenBank (accessed April 2016) representing 1615 species, 1158 genera and 96 Orders. ecoPCR (Ficetola *et al.* 2010) was used to assess the taxonomic coverage (B_c) and resolution capacity (B_s) of each different combination. ecoPCR utilises a pattern-matching algorithm to simulate real PCR conditions and identify sequences within a database that can be amplified by a given primer pair, by constraining the relative order of, and maximum distance between, primer binding sites, as well as controlling for the number of mismatches between primer and target sequences (Bellemain *et al.* 2010; Ficetola *et al.* 2010; Clarke *et al.* 2014). Simulations were run allowing for 3 mismatches per primer, excluding the last 3 bases of the 3' end, which were fixed. Amplicon length was restricted to be between 100 – 350 bp. Overall, 20 primer

combinations that had a taxonomic coverage of > 50% were selected for further *in vitro* testing and assessment. Primer combinations were analysed with NetPrimer (PREMIER Biosoft International) to provide a comprehensive analysis of the suitability of each primer pair considering melting temperatures, all secondary structures including hairpins, self-dimers and cross-dimers, minimising the formation of primer dimer and ensuring the 3' ended in a C or G to promote binding. Degenerate primers were evaluated with Multiple Primer Analyzer (Thermo Fischer Scientific) to ensure primers were below the maximum degeneracy threshold of 128 recommended by Najafabadi *et al.* (2008). The primer pair ZBJ-Art (Zeale *et al.* 2011) were also included in further testing, despite having a lower taxonomic coverage as they are widely used for gut content analysis (cited by 153 studies as of March 2017).

3.2.3 *In vitro* evaluation:

Selected primer combinations were validated with *in vitro* PCR against a standardised set of 20 different individual invertebrate samples comprising a range of Insect, Gastropod, Annelid and Arachnid Orders (Table 3.3). Different invertebrates were sourced either by collecting specimens from invertebrate sampling across farmland (Chapter 2), or using previously extracted DNA from other members of Prof. Symondson's research group. DNA was also extracted from a dead Blackbird and Song Thrush to determine whether the host species' DNA was amplified. DNA was extracted from the tissue of collected invertebrate and avian specimens using a DNeasy Blood and Tissue Kit (Qiagen, Manchester, UK) according to the manufacturer's instructions. Aliquots of identified slug DNA were donated by Dr Ben Rowson (National Museum Wales, Cardiff).

All PCRs were carried out in a 10 µl reaction volume containing 1 X QIAGEN Multiplex PCR buffer (containing 3 mM MgCl₂, dNTP mix and HotStarTaq DNA Polymerase; Qiagen, Manchester, UK), 0.2 µM of each primer and 1 µl template DNA. Double-distilled water was used as a negative PCR control to ensure a lack of contamination. The thermal conditions consisted of an initial denaturation at 95°C for 15 minutes followed by 35 cycles of 95°C for 30 seconds, an annealing temperature of either 50°C or 55°C for 90 seconds, 72°C for 1 minute; with a terminal extension of 72°C for 10 minutes. PCR protocols were carried out on a Veriti 96-Well Thermal Cycler (Applied Biosystems, Foster City, CA, USA) and resulting

products were visualised on a 1% agarose gel stained with SYBR[®]Safe (ThermoFisher Scientific, Paisley, UK).

The top three primer pairs were selected based on their ability to detect a wide range of invertebrate orders during *in vitro* evaluation, without amplifying non-target 'avian predator' DNA. These three primer pairs were rigorously tested further *in vitro* on a greater range of Orders and taxa identified from the literature as likely to occur in the diet of Blackbirds (Chamberlain *et al.* 1999a) and Song Thrushes (Davies and Snow 1965; Gruar *et al.* 2003; Murray 2004), to ensure that primers were suitable for the research question and could differentiate prey taxa at the species level. To determine their suitability for future dietary analysis studies, the top three primer pairs were tested against a range of different vertebrate samples that were provided from the archive collection of the Molecular Ecology Laboratory, Cardiff University (European Robin *Erithacus rubecula*, Common Crane *Grus Grus*, Woodpigeon *Columba palumbus*, Pied Flycatcher *Ficedula hypoleuca*, Golden Oriole *Oriolus oriolus*, European Nightjar *Caprimulgus europaeus*, European Dipper *Cinclus cinclus*, Brown Trout *Salmo trutta* and European Hedgehog *Erinaceus europaeus*). Tissue samples for several bat species (Common Pipistrelle Bat *Pipistrellus pipistrellus*, Daubenton's Bat *Myotis daubentonii*, Brown Long-eared Bat *Plecotus auritus*, Lesser Horseshoe Bat *Rhinolophus hipposideros* and Noctule Bat *Nyctalus noctula*), Common Toad *Bufo bufo* and Slow Worm *Anguis fragilis* were also donated. DNA was extracted from vertebrate samples using a DNeasy Blood and Tissue Kit as above. All additional PCRs were carried out following the protocol and thermal conditions stated above with an annealing temperature of 50°C, before products were visualised on a 1% agarose gel stained with SYBR[®]Safe (ThermoFisher Scientific, Paisley, UK).

Finally, to ensure the final metabarcoding primers selected were suitable for characterising the dietary preferences of farmland thrushes, the top three primer pairs were used to screen a subsample of 20 faecal samples collected from Blackbirds and Song Thrushes (Chapter 4). The collection of faecal samples is described in detail in Chapter 4. DNA was extracted from each faecal sample using a slightly modified version of the QIAamp[®] DNA Stool Mini Kits (Qiagen, Manchester, UK) detailed in Dunn *et al.* (2016). PCRs were carried out in 10 µl reaction volumes following the protocol described above with an annealing temperature of

50°C. Samples were visualised under UV light on a 1% agarose gel stained with SYBR®Safe (ThermoFisher Scientific, Paisley, UK).

3.3 Results:

From the 118 different primer pairs assessed using ecoPCR, 20 combinations had a taxonomic coverage of 50% or greater (Table 3.2). The final primer combination ZBJ-ArtF1c/ZBJ-ArtR1c, frequently used in the literature for gut content analysis, had a much lower taxonomic coverage of 25.26% (408/1615 species) estimated using ecoPCR.

Table 3.2: Taxonomic coverage (Bc) and resolution (Bs) at the species level of different ‘universal’ COI primer combinations estimated by *in silico* PCR against a database of complete invertebrate mitochondrial genomes. Primer combinations in bold performed best *in vitro*, detecting the most taxa without amplifying non-target predator DNA.

Forward primer	Reverse primer	Bc	Bs
LCO1490L	HCO1777ed	54.24 (876/1615)	94.86 (831/876)
LCO1490ed	CI-N-1738deg	65.70 (1061/1615)	95.85 (1017/1061)
LCO1490ed	HCO1777ed	75.23 (1215/1615)	96.05 (1167/1215)
jpgLCO1490	CI-N-1738deg	72.14 (1165/1615)	96.05 (1119/1165)
jpgLCO1490	HCO1777ed	83.65 (1351/1615)	96.15 (1299/1351)
jpgLCO1490	EPT-long-uniR	75.79 (1224/1615)	93.14 (1140/1224)
jpgLCO1490	EPT-long-uniRed	50.71 (819/1615)	89.74 (735/819)
Jyothi	CI-N-1738deg	51.58 (833/1615)	95.32 (794/833)
Jyothi	HCO1777ed	56.97 (920/1615)	95.54 (879/920)
ZBJ-ArtF1c	ZBJ-ArtR1c	25.26 (408/1615)	90.69 (370/408)
CI-J-1632	HCO1777ed	69.41 (1121/1615)	91.08 (1021/1121)
CI-J-1632	CI-N-1843d	61.92 (1000/1615)	95.20 (952/1000)
CI-J-1709	CI-N-1843d	56.16 (907/1615)	94.16 (854/907)
CI-J-1709deg	CI-N-1843d	80.62 (1302/1615)	94.39 (1229/1302)
mICO1intF	LepR	65.45 (1057/1615)	96.50 (1021/1057)
mICO1intF	HCO2198	63.03 (1018/1615)	96.95 (987/1018)
mICO1intF	HCO2198-L	81.73 (1320/1615)	96.97 (1280/1320)
mICO1intF	dgHCO2198	78.95 (1275/1615)	97.10 (1238/1275)
mICO1intF	jpgHCO2198	92.26 (1490/1615)	97.32 (1450/1490)
mICO1intF	CI-N-2191	67.80 (1095/1615)	97.08 (1063/1095)
mICO1intF	CI-N-2191(Nancy)	54.12 (874/1615)	97.03 (848/878)

Of the primer pairs analysed *in vitro*, 13 amplified non-target ‘predator’ DNA and were consequently deemed unsuitable. The amplification success of the remaining primers varied, with one primer combination (CI-J-1632/ HCO1777ed) amplifying barely any taxa (Table 3.3). Despite having the lowest taxonomic coverage and resolution when compared to a reference database of mitochondrial genomes the primer pairs LCO1490L/HCO1777ed, jgLCO1490/EPT-long-uniRed and mICOIntF/CI-N-2191 (Nancy) performed the best in laboratory testing and importantly did not amplify non-target DNA. Consequently, these three primers pairs were tested on the greater range of Orders and taxa identified from the literature to be present in diet of Blackbirds and Song Thrushes (Table 3.4).

Table 3.3: COI ‘universal primers’ tested against a range of taxa (Y indicate amplification success). Primer combinations in red performed best *in vitro*, and were tested on the greater range of Orders and taxa identified from the literature to be present in diet of Blackbirds and Song Thrushes.

	Species	Order, Family	LCO1490L/ HCO1777ed = 239bp		LCO1490ed/ C1N1738deg = 201bp		LCO1490ed/ HCO1777ed = 239bp		jgLCO1490/ CI-N-1738deg = 201bp		jgLCO1490/ HCO1777ed = 239bp	
			50°C	55°C	50°C	55°C	50°C	55°C	50°C	55°C	50°C	55°C
Earthworm	<i>Lumbricus terrestris</i>	Haplotaxida, Lumbricidae	Y	-	-	Y	Y	-	Y	Y	Y	-
Earthworm	<i>Dendrodrilus rubidus</i>	Haplotaxida, Lumbricidae	Y	Y	Y	Y	Y	-	Y	Y	Y	-
Leaf hopper	<i>Aphrodes alpinus</i>	Hemiptera, Cicadellidae	Y	-	Y	Y	Y	-	Y	Y	Y	-
Millipede	<i>Cylindroiulus punctatus</i>	Diplopoda, Julidae	Y	-	Y	Y	Y	-	Y	Y	Y	-
Bee	<i>Apis mellifera</i>	Hymenoptera, Apidae	Y	-	Y	Y	Y	-	Y	Y	Y	-
Spider	<i>Pardosa sp.</i>	Araneae, Lycosidae	Y	-	-	-	-	-	Y	-	-	-
Ladybird	<i>Coccinella septempunctata</i>	Coleoptera, Coccinellidae	Y	Y	-	Y	Y	-	Y	Y	-	-
Centipede	<i>Cryptops hortensis</i>	Chilopoda, Cryptopidae	Y	Y	Y	-	Y	-	Y	Y	-	-
Snail	<i>Helix aspersa</i>	Gastropoda, Helicidae	Y	-	-	-	Y	-	Y	-	-	-
Springtail	<i>Folsomia candida</i>	Collembola, Isotimidae	Y	Y	Y	-	Y	-	Y	Y	Y	-
Cockroach	<i>Blattella germanica</i>	Blattodea, Blattellidae	Y	-	Y	Y	-	-	Y	-	-	-
Hoverfly	<i>Myathropa florea</i>	Diptera, Syrphidae	Y	-	Y	-	-	-	Y	-	Y	-
Cricket	<i>Acheta domesticus</i>	Orthoptera, Gryllidae	Y	-	Y	Y	-	-	Y	-	Y	-
Earwig	<i>Forficula auricularia</i>	Dermaptera, Forficulidae	Y	-	Y	-	-	-	Y	Y	Y	-
Lawn Shrimp	<i>Arcitalitrus sylvaticus</i>	Amphipoda, Talitridae	Y	-	Y	-	-	-	Y	-	Y	-
Carpet Moth	<i>Trichophaga tapetzella</i>	Lepidoptera, Tineidae	Y	Y	Y	Y	Y	-	Y	-	Y	-
Cranefly	<i>Tipula paludosa</i>	Diptera, Tipulidae	Y	Y	Y	Y	Y	-	Y	Y	Y	-
Cased Caddis	<i>Rhyacophila sp</i>	Trichoptera, Rhyacophilidae	Y	Y	Y	-	-	-	Y	Y	Y	-
Stone Fly	<i>Isoperla grammatical</i>	Plecoptera, Perlodidae	Y	Y	Y	Y	Y	-	Y	Y	Y	-
Flatworm	<i>Planaria sp.</i>	Tricladida, Planariidae	Y	-	Y	-	-	-	Y	-	-	-
Mayfly	<i>Baetis rhodani</i>	Ephemeroptera, Baetidae	Y	Y	Y	Y	Y	-	Y	Y	Y	-
Slug	<i>Arion (Carinarion) fasciatus</i>	Gastropoda, Arioniidae	Y	Y	-	-	Y	Y	-	Y	Y	-
Slug	<i>Lehmannia marginata</i>	Gastropoda, Limacidae	Y	-	-	-	Y	Y	-	-	-	-
Slug	<i>Deroceras invadens</i>	Gastropoda, Agriolimacidae	Y	-	-	-	Y	-	-	-	Y	-
Blackbird	<i>Turdus merula</i>	Passeriformes, Turdidae	-	-	Y	-	Y	-	Y	Y	Y	-
Song Thrush	<i>Turdus philomelos</i>	Passeriformes, Turdidae	-	-	Y	Y	Y	-	Y	Y	Y	-

Table 3.3: COI ‘universal primers’ tested against a range of taxa (Y indicate amplification success). Primer combinations in red performed best *in vitro*, and were tested on the greater range of Orders and taxa identified from the literature to be present in diet of Blackbirds and Song Thrushes.

Species	Order, Family	jgLCO1490/ EPT-long-uniR = 128bp		jgLCO1490/ EPT-long-uniRed = 133bp		Jyothi/ CI-N-1738deg = 201bp		Jyothi/ HCO1777ed = 239bp		ZBJ-ArtF1c/ ZBJArtR2c = 157bp		
		50°C	55°C	50°C	55°C	50°C	55°C	50°C	55°C	50°C	55°C	
		Earthworm	<i>Lumbricus terrestris</i>	Haplotaxida, Lumbricidae	Y	Y	Y	Y	Y	Y	Y	-
Earthworm	<i>Dendrodrilus rubidus</i>	Haplotaxida, Lumbricidae	Y	-	Y	-	Y	Y	Y	-	Y	Y
Leaf hopper	<i>Aphrodes alpinus</i>	Hemiptera, Cicadellidae	-	-	Y	-	Y	Y	Y	-	Y	Y
Millipede	<i>Cylindroiulus punctatus</i>	Diplopoda, Julidae	Y	-	Y	-	Y	Y	Y	-	Y	Y
Bee	<i>Apis mellifera</i>	Hymenoptera, Apidae	Y	-	Y	-	Y	Y	Y	-	-	-
Spider	<i>Pardosa sp.</i>	Araneae, Lycosidae	Y	-	Y	-	Y	-	-	-	Y	Y
Ladybird	<i>Coccinella septempunctata</i>	Coleoptera, Coccinellidae	Y	-	Y	-	Y	Y	Y	-	-	Y
Centipede	<i>Cryptops hortensis</i>	Chilopoda, Cryptopidae	Y	-	Y	-	Y	Y	Y	-	-	Y
Snail	<i>Helix aspersa</i>	Gastropoda, Helicidae	Y	-	Y	-	Y	-	Y	-	-	-
Springtail	<i>Folsomia candida</i>	Collembola, Isotimidae	Y	Y	Y	Y	Y	Y	Y	-	Y	Y
Cockroach	<i>Blattella germanica</i>	Blattodea, Blattellidae	Y	Y	Y	Y	Y	Y	Y	-	Y	Y
Hoverfly	<i>Myathropa florea</i>	Diptera, Syrphidae	Y	-	Y	-	Y	Y	Y	-	Y	Y
Cricket	<i>Acheta domesticus</i>	Orthoptera, Gryllidae	Y	Y	Y	Y	Y	Y	Y	-	Y	Y
Earwig	<i>Forficula auricularia</i>	Dermaptera, Forficulidae	Y	Y	Y	Y	Y	Y	Y	-	Y	Y
Lawn Shrimp	<i>Arcitalitrus sylvaticus</i>	Amphipoda, Talitridae	Y	Y	Y	Y	Y	Y	-	-	-	-
Carpet Moth	<i>Trichophaga tapetzella</i>	Lepidoptera, Tineidae	Y	-	Y	Y	Y	Y	Y	Y	Y	Y
Cranefly	<i>Tipula paludosa</i>	Diptera, Tipulidae	Y	-	Y	Y	Y	Y	Y	Y	Y	Y
Cased Caddis	<i>Rhyacophila sp</i>	Trichoptera, Rhyacophilidae	Y	-	Y	Y	Y	Y	Y	-	Y	Y
Stone Fly	<i>Isoperla grammical</i>	Plecoptera, Perlodidae	Y	-	Y	Y	Y	Y	Y	Y	Y	Y
Flatworm	<i>Planaria sp.</i>	Tricladida, Planariidae	-	-	Y	-	Y	Y	Y	-	Y	Y
Mayfly	<i>Baetis rhodani</i>	Ephemeroptera, Baetidae	Y	Y	Y	Y	Y	Y	Y	Y	Y	Y
Slug	<i>Arion (Carinarion) fasciatus</i>	Gastropoda, Arioniidae	Y	-	Y	-	Y	-	Y	Y	Y	Y
Slug	<i>Lehmannia marginata</i>	Gastropoda, Limacidae	Y	-	Y	Y	Y	-	Y	-	Y	Y
Slug	<i>Deroceras invadens</i>	Gastropoda, Agriolimacidae	Y	-	Y	Y	-	-	Y	-	Y	Y
Blackbird	<i>Turdus merula</i>	Passeriformes, Turdidae	Y	Y	-	-	Y	-	-	-	-	-
Song Thrush	<i>Turdus philomelos</i>	Passeriformes, Turdidae	Y	-	-	-	Y	-	Y	-	-	-

Table 3.3: COI ‘universal primers’ tested against a range of taxa (Y indicates amplification success). Primer combinations in red performed best *in vitro*, and were tested on the greater range of Orders and taxa identified from the literature to be present in diet of Blackbirds and Song Thrushes.

Species	Order, Family	CI-J-1632/ HCO1777ed = 121bp		CI-J-1632/ CI-N-1843d = 188bp		CI-J-1709/ CI-N-1843d = 111bp		CI-J-1709deg/ CI-N-1843d = 111bp		mICO1intF/ LepR = 288bp		
		50°C	55°C	50°C	55°C	50°C	55°C	50°C	55°C	50°C	55°C	
		Earthworm	<i>Lumbricus terrestris</i>	Haplotaxida, Lumbricidae	-	-	Y	-	-	-	Y	Y
Earthworm	<i>Dendrodrilus rubidus</i>	Haplotaxida, Lumbricidae	-	-	-	-	Y	Y	Y	Y	Y	Y
Leaf hopper	<i>Aphrodes alpinus</i>	Hemiptera, Cicadellidae	-	-	-	Y	Y	Y	Y	Y	Y	Y
Millipede	<i>Cylindroiulus punctatus</i>	Diplopoda, Julidae	-	-	-	Y	Y	Y	Y	Y	Y	Y
Bee	<i>Apis mellifera</i>	Hymenoptera, Apidae	-	-	Y	Y	Y	Y	Y	Y	Y	Y
Spider	<i>Pardosa sp.</i>	Araneae, Lycosidae	-	-	-	-	Y	Y	Y	Y	Y	Y
Ladybird	<i>Coccinella septempunctata</i>	Coleoptera, Coccinellidae	-	-	Y	-	Y	Y	Y	Y	Y	Y
Centipede	<i>Cryptops hortensis</i>	Chilopoda, Cryptopidae	-	-	-	-	Y	Y	Y	Y	Y	Y
Snail	<i>Helix aspersa</i>	Gastropoda, Helicidae	-	-	-	-	Y	Y	Y	Y	Y	Y
Springtail	<i>Folsomia candida</i>	Collembola, Isotimidae	-	-	-	Y	Y	Y	Y	Y	Y	Y
Cockroach	<i>Blattella germanica</i>	Blattodea, Blattellidae	-	-	-	-	Y	Y	Y	Y	Y	Y
Hoverfly	<i>Myathropa florea</i>	Diptera, Syrphidae	-	-	Y	Y	Y	Y	Y	Y	Y	Y
Cricket	<i>Acheta domesticus</i>	Orthoptera, Gryllidae	-	-	Y	-	Y	Y	-	Y	Y	Y
Earwig	<i>Forficula auricularia</i>	Dermaptera, Forficulidae	-	-	-	-	Y	Y	-	Y	Y	Y
Lawn Shrimp	<i>Arcitalitrus sylvaticus</i>	Amphipoda, Talitridae	-	-	Y	Y	Y	Y	Y	Y	Y	Y
Carpet Moth	<i>Trichophaga tapetzella</i>	Lepidoptera, Tineidae	-	-	Y	Y	Y	Y	Y	Y	Y	Y
Cranefly	<i>Tipula paludosa</i>	Diptera, Tipulidae	-	-	-	-	Y	Y	Y	Y	Y	Y
Cased Caddis	<i>Rhyacophila sp</i>	Trichoptera, Rhyacophilidae	-	-	-	-	Y	Y	Y	Y	Y	Y
Stone Fly	<i>Isoperla grammatical</i>	Plecoptera, Perlodidae	-	-	Y	-	Y	Y	Y	Y	Y	Y
Flatworm	<i>Planaria sp.</i>	Tricladida, Planariidae	-	-	-	-	Y	Y	Y	Y	Y	Y
Mayfly	<i>Baetis rhodani</i>	Ephemeroptera, Baetidae	-	-	-	-	Y	Y	Y	Y	Y	Y
Slug	<i>Arion (Carinarion) fasciatus</i>	Gastropoda, Arioniidae	Y	-	Y	-	Y	Y	Y	Y	Y	Y
Slug	<i>Lehmannia marginata</i>	Gastropoda, Limacidae	Y	-	-	-	Y	Y	-	-	Y	Y
Slug	<i>Deroceras invadens</i>	Gastropoda, Agriolimacidae	-	-	-	-	Y	Y	Y	Y	Y	Y
Blackbird	<i>Turdus merula</i>	Passeriformes, Turdidae	-	-	-	-	Y	Y	Y	Y	Y	Y
Song Thrush	<i>Turdus philomelos</i>	Passeriformes, Turdidae	-	-	-	Y	Y	Y	Y	Y	Y	Y

Table 3.3: COI ‘universal primers’ tested against a range of taxa (Y indicate amplification success). Primer combinations in red performed best *in vitro*, and were tested on the greater range of Orders and taxa identified from the literature to be present in diet of Blackbirds and Song Thrushes.

		mICO1intF/ Nancy = 306bp	
		50°C	55°C
Earthworm	<i>Lumbricus terrestris</i>	Haplotaxida, Lumbricidae	Y Y
Earthworm	<i>Dendrodrilus rubidus</i>	Haplotaxida, Lumbricidae	Y Y
Leaf hopper	<i>Aphrodes alpinus</i>	Hemiptera, Cicadellidae	Y Y
Millipede	<i>Cylindroiulus punctatus</i>	Diplopoda, Julidae	Y Y
Bee	<i>Apis mellifera</i>	Hymenoptera, Apidae	Y Y
Spider	<i>Pardosa sp.</i>	Araneae, Lycosidae	Y Y
Ladybird	<i>Coccinella septempunctata</i>	Coleoptera, Coccinellidae	Y Y
Centipede	<i>Cryptops hortensis</i>	Chilopoda, Cryptopidae	Y Y
Snail	<i>Helix aspersa</i>	Gastropoda, Helicidae	Y Y
Springtail	<i>Folsomia candida</i>	Collembola, Isotimidae	Y Y
Cockroach	<i>Blattella germanica</i>	Blattodea, Blattellidae	Y Y
Hoverfly	<i>Myathropa florea</i>	Diptera, Syrphidae	Y Y
Cricket	<i>Acheta domesticus</i>	Orthoptera, Gryllidae	Y Y
Earwig	<i>Forficula auricularia</i>	Dermaptera, Forficulidae	Y Y
Lawn Shrimp	<i>Arcitalitrus sylvaticus</i>	Amphipoda, Talitridae	Y Y
Carpet Moth	<i>Trichophaga tapetzella</i>	Lepidoptera, Tineidae	Y Y
Crane fly	<i>Tipula paludosa</i>	Diptera, Tipulidae	Y Y
Cased Caddis	<i>Rhyacophila sp</i>	Trichoptera, Rhyacophilidae	Y Y
Stone Fly	<i>Isoperla grammatica</i>	Plecoptera, Perlodidae	Y Y
Flatworm	<i>Planaria sp.</i>	Tricladida, Planariidae	Y Y
Mayfly	<i>Baetis rhodani</i>	Ephemeroptera, Baetidae	Y Y
Slug	<i>Arion (Carinarion) fasciatus</i>	Gastropoda, Arioniidae	Y Y
Slug	<i>Lehmannia marginata</i>	Gastropoda, Limacidae	Y Y
Slug	<i>Deroceras invadens</i>	Gastropoda, Agriolimacidae	Y Y
Blackbird	<i>Turdus merula</i>	Passeriformes, Turdidae	- -
Song Thrush	<i>Turdus philomelos</i>	Passeriformes, Turdidae	- -

Table 3.4: COI ‘universal primers’ tested against a greater range of taxa identified from the literature to be present in the diet of farmland thrushes (Y indicate amplification success). Primer combinations in bold were selected for their suitability to screen faecal samples collected from Blackbirds and Song Thrushes in farmland habitats.

	Species	Order, Family	kgLCO1490/ EPT-long- uniRed	LCO1490L/ HCO1777ed	MICO1intF/ Nancy
			= 133 bp	= 239 bp	= 306 bp
			50°C	50°C	50°C
Earthworm	<i>Allolobophora chlorotica</i>	Haplotaxida, Lumbricidae	Y	Y	-
Earthworm	<i>Octolasion cyaneum</i>	Haplotaxida, Lumbricidae	Y	Y	Y
Earthworm	<i>Aporrectodea caliginosa</i>	Haplotaxida, Lumbricidae	Y	Y	-
Slug	<i>Arion (Arion) flagellus</i>	Gastropoda, Arioniidae	Y	Y	Y
Slug	<i>Arion (Mesarion) subfuscus</i>	Gastropoda, Arioniidae	Y	Y	Y
Slug	<i>Arion (Carinarion) silvaticus</i>	Gastropoda, Arioniidae	Y	Y	Y
Slug	<i>Arion (Kobeltia) hormesis</i>	Gastropoda, Arioniidae	Y	Y	Y
Slug	<i>Limax cinereoniger</i>	Gastropoda, Limacidae	Y	Y	Y
Slug	<i>Deroceras reticulatum</i>	Gastropoda, Agriolimacidae	Y	Y	Y
Slug	<i>Tandonia budapestensis</i>	Gastropoda, Milacidae	Y	Y	Y
Slug	<i>Boettgerilla pallens</i>	Gastropoda, Boettgerillidae	Y	Y	Y
Beetle	<i>Staphylinus olens</i>	Coleoptera, Staphylinidae	Y	Y	Y
Beetle	<i>Amara bifrons</i>	Coleoptera, Carabidae	Y	Y	Y
Beetle	<i>Notiophilus biguttatus</i>	Coleoptera, Carabidae	-	Y	-
Spider	<i>Lepthyphantes tenuis</i>	Araneae, Linyphiidae	Y	-	Y
Spider	<i>Clubiona comta</i>	Araneae, Clubionidae	Y	Y	Y
Spider	<i>Pardosa pullata</i>	Araneae, Lycosidae	Y	-	Y
Spider	<i>Philodromus sp.</i>	Araneae, Philodromidae	Y	Y	Y
Moth	<i>Asteroscopus sphinx</i>	Lepidoptera, Noctuidae	Y	Y	Y
Moth	<i>Noctua comes</i>	Lepidoptera, Noctuidae	Y	Y	Y
Moth	<i>Xestia c nigrum</i>	Lepidoptera, Noctuidae	Y	Y	Y
Moth	<i>Epirrita dilutata</i>	Lepidoptera, Geometridae	Y	Y	Y
Butterfly	<i>Maniola jurtina</i>	Lepidoptera, Nymphalidae	Y	Y	Y
Butterfly	<i>Ochlodes sylvanua</i>	Lepidoptera, Hesperidae	Y	Y	Y
Butterfly	<i>Pieris rapae</i>	Lepidoptera, Pieridae	Y	Y	Y
Butterfly	<i>Melanargia galathea</i>	Lepidoptera, Nymphalidae	Y	Y	Y

Table 3.5: COI ‘universal primers’ tested against a range of taxa (Y indicate amplification success). Primer combinations in bold were selected for their suitability to screen faecal samples collected from Blackbirds and Song Thrushes in farmland habitats.

Species	Order, Family	kgLCO1490/ EPT-long-uniRed = 133 bp	LCO1490L/ HCO1777ed = 239 bp	MICO1intF/ Nancy = 306 bp	
		50°C	50°C	50°C	
Bat	<i>Pipistrellus spp.</i>	Chiroptera, Vespertilionidae	Y	Y	Y
Bat	<i>Myotis daubentonii</i>	Chiroptera, Vespertilionidae	Y	Y	Y
Bat	<i>Plecotus auritus</i>	Chiroptera, Vespertilionidae	Y	Y	Y
Bat	<i>Rhinolophus hipposideros</i>	Chiroptera, Rhinolophidae	Y	Y	Y
Bat	<i>Nyctalus noctula</i>	Chiroptera, Vespertilionidae	Y	Y	Y
Slow Worm	<i>Anguis fragilis</i>	Squamata, Anguidae	Y	Y	Y
Toad	<i>Bufo bufo</i>	Anura, Bufonidae	Y	Y	Y
Hedgehog	<i>Erinaceus europaeus</i>	Eulipotyphla, Erinaceidae	Y	Y	Y
Trout	<i>Salmo trutta</i>	Salmoniformes, Salmonidae	Y	Y	-
Robin	<i>Erithacus rubecula</i>	Passeriformes, Muscapidae	-	-	-
Crane	<i>Grus grus</i>	Gruiformes, Gruidae	-	-	-
Woodpigeon	<i>Columba palumbus</i>	Columbiformes, Columbidae	-	-	-
Nightjar	<i>Caprimulgus europaeus</i>	Caprimulgiformes, Caprimulgidae	-	Y	-
Pied Flycatcher	<i>Ficedula hypoleuca</i>	Passeriformes, Muscicapidae	-	-	-
Golden Oriole	<i>Oriolus oriolus</i>	Passeriformes, Oriolidae	Y	-	-
Dipper	<i>Cinclus cinclus</i>	Passeriformes, Cinclidae	-	-	-

Overall, when considering their suitability for future dietary analysis studies, the top three primer pairs did not detect any avian DNA (Blackbird, Song Thrush, Robin, Woodpigeon, Common Crane, Pied Flycatcher, Golden Oriole, Nightjar, or Dipper), but did amplify DNA from the five different species of bat, Common Toad, Slow Worm, Brown Trout and Hedgehog (Table 3.5). However, the primer pair LCO1490L/HCO1777ed performed poorly when used to screen a subsample of Blackbird and Song Thrush faecal samples, amplifying DNA from only two of the 20 samples analysed (Table 3.6). However, the primer pairs jgLCO1490/EPT-long-uniRed and mICO1intF/CI-N-2191(Nancy) detected invertebrate prey DNA in 85% (17/20) and 75% (15/20) of the faecal samples, respectively.

Table 3.6: COI ‘universal primers’ tested against a subset of Blackbird and Song Thrush faecal samples (Y indicate amplification success). Primer combinations in bold performed best *in vitro*, and were selected for their suitability to screen faecal samples collected from Blackbirds and Song Thrushes in farmland habitats.

Faecal sample	jgLCO1490/ EPT- long-uniRed = 133 bp	LCO1490L/ HCO1777ed = 239 bp	MICO1intF/ Nancy = 306 bp
	50°C	50°C	50°C
Blackbird S1	Y	-	Y
Blackbird S2	Y	Y	-
Blackbird S3	Y	-	Y
Blackbird S4	Y	Y	Y
Blackbird S5	Y	-	Y
Blackbird S6	-	-	-
Blackbird S7	Y	-	Y
Blackbird S8	Y	-	Y
Blackbird S9	Y	-	Y
Blackbird S10	Y	-	Y
Song Thrush S1	Y	-	Y
Song Thrush S2	Y	-	-
Song Thrush S3	Y	-	Y
Song Thrush S4	Y	-	Y
Song Thrush S5	Y	-	Y
Song Thrush S6	-	-	-
Song Thrush S7	-	-	-
Song Thrush S8	Y	-	Y
Song Thrush S9	Y	-	Y
Song Thrush S10	Y	-	Y

Consequently, after rigorous *in vitro* testing, the primer pairs jgLCO1490/EPT-long-uniRed targeting a short amplicon of 133 bp to maximise diversity, and mICOIntF/CI-N-2191(Nancy), targeting a longer amplicon of 306 bp to expand and quality check taxonomic identity, were selected for their suitability to screen faecal samples collected from Blackbirds and Song Thrushes in farmland habitats.

3.4 Discussion

The suitability of known ‘universal’ COI primers for invertebrates were evaluated both *in silico* using ecoPCR, and *in vitro* to select two general primer pairs suitable for dietary analysis. From the 118 primer combinations considered in this study, the majority showed low taxonomic coverage and provided poor taxonomic resolution when tested against a database of complete invertebrate mitochondrial genomes. Further empirical testing of 21 primer pairs *in vitro* allowed us to determine two primer pairs that would be suitable for characterising the dietary preferences of farmland thrushes. To safeguard the optimal performance of the final primer pairs selected, further testing against specific taxonomic groups of interest was conducted. This ensured that the selected primers amplified all known important prey taxa (at the level of Order) previously identified in the diet of Blackbirds and Song Thrushes, but did not amplify host DNA and were thus suitable for analysing the diets of these birds in contrasting landscape types.

Metabarcoding primers evaluated were located within the standardised COI barcoding region, to allow validation and comparison of MOTUs arising from the subsequent sequencing with reference sequences available in barcoding databases. Two primer pairs were selected: jgLCO1490/EPT-long-uniRed, which targeted a short amplicon of 133 bp to maximise the diversity of amplified taxa; and mICOIntF/CI-N-2191(Nancy), which targeted a longer amplicon of 306 bp, to allow a more specific and accurate taxonomic identification. The final primers selected were below the maximum degeneracy threshold of 128 recommended by Najafabadi *et al.* (2008) and the 3' ended in a C or G to promote binding. Careful evaluation to determine suitable degenerate COI primers can ensure reasonable detection rates and taxonomic coverage can be achieved with COI metabarcodes (Brandon-Mong *et al.* 2015; Elbrecht and Leese 2017b). The primers selected can amplify a wide range of invertebrate

Orders, including Panpulmonata and Annelida, whilst avoiding the amplification of non-target predator avian DNA. However, the two primer pairs did amplify DNA from different bat species, a Common Toad, Slow Worm, Brown Trout *Salmo trutta* and European Hedgehog *Erinaceus europaeus*, suggesting limited use beyond avian dietary analysis projects. Extensive empirical testing was conducted to determine the suitability of the selected primer pairs to characterise the dietary preferences of farmland thrushes. However, context-specific primer evaluation would be required when selecting primers for a different research question.

Acknowledging the limitations, biases and validation problems that practitioners face when conducting sequenced-based dietary analyses are essential for obtaining reliable results. All known primers fail to amplify some taxa (Brandon-Mong *et al.* 2015; Elbrecht and Leese 2017b), so primer evaluation must follow a strict framework (MacDonald and Sarre 2016) to ensure the optimum primers are selected for the specific research question. When using metabarcoding primers with HTS, a certain amount of degeneracy is required, as a lack of degeneracy can lead to substantial bias. However, if primers are too degenerate, targets may amplify at lower and often unpredictable efficiency (Najafabadi *et al.* 2008; Klindworth *et al.* 2013).

Initially, potential ‘universal’ COI primers capable of amplifying all invertebrate prey DNA were identified from previous literature and DNA-based dietary studies. The list of primers considered is by no means exhaustive as new COI primers continue to be developed and tested (e.g. BF1 – BR2; Elbrecht and Leese 2017b). Selected primers had either been developed using reference barcode sequences downloaded from GenBank or BOLD for a particular taxonomic target (e.g. (Zeale *et al.* 2011; Leray *et al.* 2013), or developed on mitochondrial genomes (e.g. Geller *et al.* 2013). Both methods of primer development are problematic. Primers developed by downloading relevant sequences from reference databases can result in artificial inflation for specific taxa, whereas complete mitochondrial genome datasets may be insufficient or too rare for many taxonomic groups (Elbrecht and Leese 2017b). In addition, primers may have been developed for a specific purpose, warranting the need to amplify a specific taxonomic group (e.g. Zeale *et al.* (2011), developed ZBJ-ArtF1c/ZBJ-ArtR1c primers to detect arthropod prey in bat faeces).

To try and account for the problem of incomplete datasets, the R package ‘PrimerMiner’ was deployed (Elbrecht and Leese 2017b). PrimerMiner batch-downloads DNA barcode sequences for specified target taxonomic groups from GenBank and BOLD; sequences are then clustered into operational taxonomic units (OTUs). This increases the amount of reference data available compared to using mitochondrial genomes alone, whilst reducing the biases introduced by the different number of available sequences of certain taxa. However, attempts to run PrimerMiner were unsuccessful due to problems aligning the sheer number of sequences for certain invertebrate Orders (e.g. Lepidoptera), especially when a reference genome was not available (e.g. Panpulmonata). Consequently, primers were evaluated on a database of complete mitochondrial genomes following the methods of (Clarke *et al.* 2014). To ensure the suitability of primers selected, and to try to account for the over-simplification and biases derived from evaluating primers *in silico*, against a limited database of mitochondrial genomes, rigorous *in vitro* testing was conducted. This ensures that the primers were capable of meeting the needs of the specific research question and could amplify a wide range of the potential prey taxa that have previously been identified in the diet of the target species.

Evaluated primers were tested on pure extracts of single species, rather than artificial mixtures of invertebrate DNA: amplification from pure (single-taxon) samples will not predict the efficiency of primers in mixed-taxon samples due to differing levels of inhibitory compounds (Clarke *et al.* 2014). Amplification bias may hinder the detection of all taxa present in a sample and significantly alter the results of metabarcoding studies, but it is rarely considered in the current literature. For example, in a study by Elbrecht and Leese (2017a), the number of sequences obtained varied among taxa by several orders of magnitude when using the primers LCO1490/HCO2198 (Folmer *et al.* 1994) to amplify artificial samples comprising 52 different taxa of freshwater invertebrates. When the same artificial samples were also amplified with two newly designed but more degenerate COI primer pairs, primer efficiencies and read abundance were very similar across Orders, but varied slightly between primer sets (Elbrecht and Leese 2017a). However, since the completion of the primer evaluation part of this study, new guidelines have been published to reduce the challenges and limitations that arise from using HTS for diet analysis (Alberdi *et al.* 2018). Recent research has also considered the sensitivity of degenerate primers to slippage, often binding 1-2 bp

upstream and causing variation in amplicon length (Elbrecht *et al.* 2018). Further work to determine any bias from using the two selected primer pairs in ‘mock communities’ should be conducted as differences in inhibitor concentrations could affect results by altering amplification efficiency.

Even after the careful selection of primers, the choice of MID tag code used to identify individual samples, direction of sequencing and quality filtering can have different, erratic and inconsistent impacts on the extraction and identification of sequences (Deagle *et al.* 2013). Fusion primers, despite being easy to use with a single-step PCR, can decrease PCR efficiency, although the alternative two-step PCR may be more prone to tag-jumping (Schnell *et al.* 2015).

Finally, having critically evaluated primers based on *a priori* knowledge of a species’ previous diet, for a specific research question, deploying the correct bioinformatic pipelines is crucial. The most common approach to analyse metabarcoding data is to assign sequences to clusters based on user-defined similarity thresholds (as a standard, 3% sequence divergence is often applied (Floyd *et al.* 2002)). A representative sequence of each cluster or molecular operational taxonomic unit (MOTU) can then be assigned to a taxonomic identity when compared to a reference database (GenBank or BOLD), allowing for both known and unknown taxa to be included in analyses.

The accuracy of MOTU-based approaches for species delimitation is highly sensitive to PCR artefacts (e.g. chimeras) and sequencing errors, and no rule or metric will universally apply to all genetic markers or taxonomic groups (Brown *et al.* 2015). Another limitation of MOTUs is that they were never originally intended to be used as a species concept (Floyd *et al.* 2002) and are an attempt at a reasonable estimate of diversity, rather than corresponding directly to species identities. Several recent studies have tested the efficacy of data analysis methods used to derive MOTUs, by comparing different analytical procedures, filtering thresholds and clustering algorithms (Flynn *et al.* 2015; Clare *et al.* 2016). Depending on the assignment procedure selected, a considerable trade-off may occur between taxonomic identification (accuracy) and resolution of DNA metabarcoding sequences (Richardson *et al.* 2017). Corse *et al.* (2017) recently proposed a ‘from-benchtop-to-desktop’ workflow for validating HTS

data and taxonomic identification in diet metabarcoding studies, which combined different approaches for taxonomic assignment based on low frequency noise filters. Overestimation, or overextension, of MOTU number can impact both data interpretation (Clare 2014) and downstream applications such as ecological/conservation management (Cristescu 2014). However, Clare *et al.* (2016) found that, despite differences in MOTU number obtained through different analytical procedures, the effect on simple ecological interpretation was small, and in most cases the same ecological conclusion would be drawn despite wide variation in estimates of niche overlap.

DNA metabarcoding using COI primers is currently the most effective approach for characterising the dietary preferences of terrestrial birds that forage on invertebrates. Primers should be carefully selected and fully evaluated based on the specific research question and *a priori* knowledge of the diet of the species of interest. In the present study, primers derived from previous studies were empirically tested with the relevant predators, both *in silico* and *in vitro*, before two primer pairs were selected for the specific metabarcoding project. The effectiveness of the selected primers for investigating the diet of Blackbirds and Song Thrushes is described in detail in the subsequent Chapters.

3.5 Acknowledgements:

Aliquots of known-species slug DNA were kindly provided by Dr Ben Rowson, (National Museum Wales, Cardiff) (Appendix S3.2). Thanks to Dr Dean Waters for providing the Bat samples, Dr Rhys Jones for providing a Slow Worm tissue sample and Dr Fred Slater for providing a dead Common Toad. Dr Pablo Orozco terWengel and Jordan Cuff were instrumental in battling with ecoPCR to provide the *in silico* analysis of primer pairs. Finally, I thank Alex McCubbin and Kirsty Franklin for their laboratory assistance with screening primers.

3.6 Supplementary material:

Table S3.1: COI universal primer combinations which produce amplicons of between 100 and 350 bp.

	EPTLong uniR	Unimini barR	EPTLong uniRed	ZBJArt R2c	C1-N- 1738	C1-N- 1738deg	HCO1777	HCO1777 ed	mICOIntR	C1-N- 1843d	UEA2
LCO1490	128	130	133	178	201	201	239	239	293		
LCO1490L	128	130	133	178	201	201	239	239	293		
LCO1490ed	128	130	133	178	201	201	239	239	293		
dgLCO1490	128	130	133	178	201	201	239	239	293		
kgLCO1490	128	130	133	178	201	201	239	239	293		
Jyothi	128	130	133	178	201	201	239	239	293		
LepF1	128	130	133	178	201	201	239	239	293		
UniminibarF1	125	127	130	175	198	198	236	236	290		
ZBJ-ArtF1c	107	109	112	157	180	180	218	218	272		
C1-J-1632							121	121	175	188	186
C1-J-1709										111	109
C1-J-1709deg										111	109
C1-J-1718mod										105	103
C1-J-1718										105	100
	UEA4	COIE	LepR	HCO 2198	HCO 2198B	HCO 2198L	dgHCO 2198	kgHCO 2198	C1-N- 2191	C1-N-2191 mod	C1-N-2191 Nancy
C1-J-1751Ron	312										
UEA3	300										
C1-J1859RonII	204	288	288	291	288	288	288	288	306	304	306
mICO1intF	204	288	288	291	288	288	288	288	306	304	306

Table S3.2: Details of the aliquots of known-species slug DNA kindly donated by Dr Ben Rowson (National Museum Wales, Cardiff) and used to test the suitability of selected primer pairs.

Morphological species	Museum accession number	Specimen number
<i>Arion (Arion) flagellus</i>	NMW.Z.2011.038.00004	AB5
<i>Arion (Mesarion) subfuscus</i>	NMW.Z.2012.041.00023	12m8
<i>Arion (Carinarion) circumscriptus</i>	NMW.Z.2012.041.00013	12m19
<i>Arion (Carinarion) silvaticus</i>	NMW.Z.2011.037.00057	I99
<i>Arion (Carinarion) fasciatus</i>	NMW.Z.2012.041.00058	DF2
<i>Arion (Kobeltia) distinctus</i>	NMW.Z.2012.041.00016	12m21
<i>Arion (Kobeltia) hortensis</i>	NMW.Z.2012.041.00122	PYC7
<i>Arion (Kobeltia) intermedius</i>	NMW.Z.2011.037.00039	I69
<i>Limax cinereoniger</i>	NMW.Z.2012.041.00003	12BB5
<i>Limax maximus</i>	NMW.Z.2012.041.00035	DC13
<i>Lehmannia marginata</i>	NMW.Z.2012.041.00056	DF14
<i>Deroceras reticulatum</i>	NMW.Z.2012.041.00043	DC21
<i>Deroceras invadens</i>	NMW.Z.2012.041.00054	DF11
<i>Deroceras laeve</i>	NMW.Z.2012.041.00147	SN7
<i>Tandonia budapestensis</i>	NMW.Z.2012.041.00108	NF17
<i>Tandonia sowerbyi</i>	NMW.Z.2012.041.00038	DC16
<i>Boettgerilla pallens</i>	NMW.Z.2012.041.00089	M30

CHAPTER 4: Diet of Thrushes:

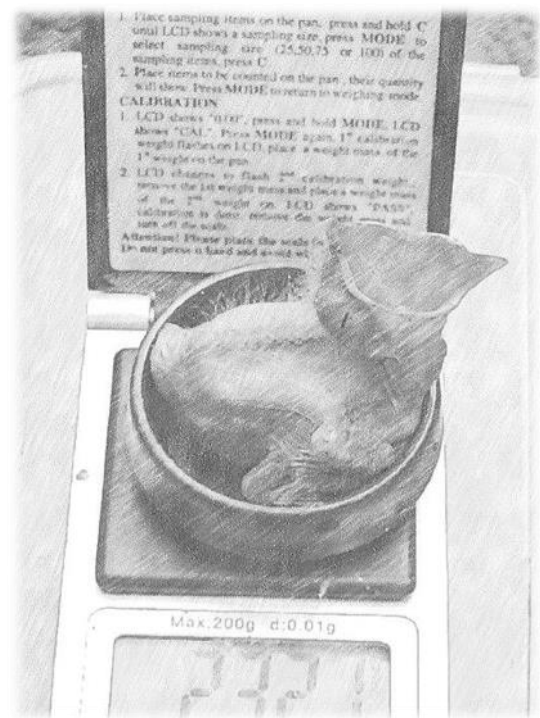

“A bird doesn’t sing because it has an answer. It sings because it has a song”

Maya Angelou

Using high-throughput sequencing to examine the links between diet composition, growth and condition for thrushes in a farmed landscape

Food availability during the breeding season is a fundamental determinant of fitness for altricial nestlings, as the period of growth and development can have long term implications for condition, post-fledging survival and lifetime breeding success. Blackbirds and Song Thrushes provide highly tractable model species with which to investigate the links between diet composition in the nest and nestling growth and condition, using high-throughput sequencing (HTS). Primer pairs jgLCO1490/EPT-long-uniRed and mICOIntF/CI-N-2191(Nancy) (Chapter 2) were used to screen faecal samples collected from adults and nestling thrushes in farmland habitats of differing complexity. A total of 338 taxonomic units were identified from faecal samples, of which 76% were identified to species, 21% to genus, and the remaining 3% to family. Adult thrushes were generally consistent between years in what they fed their nestlings, with considerable overlap between the diet of Blackbird and Song Thrush nestlings each year; although there was a significant difference in the number of molecular taxonomic units between years. Nestlings showed evidence of compensatory growth between 5 and 8 days of age, and Blackbird nestlings in nests within the relatively simplified landscape at Hildersham failed to reach the threshold body mass of 55g, previously described as the minimum 8-day nestling mass required for survival to independence. Nestling diet changed with age, with both Blackbirds and Song Thrushes feeding a higher proportion of earthworms to older chicks. In addition, a higher proportion of earthworms within Blackbird nestling diet was positively associated with nestling body condition; no other prey taxa were significantly associated with nestling condition. Overall, these results highlight the broad dietary range of both species, the inter-specific, intra-specific, and age-related variation in nestling diet, and the consequences of dietary composition for nestling growth and survival.

4.1 Introduction:

Animal population sizes are often limited by food availability (Lack 1954; Martin 1987; Newton 2013). During the breeding season, food availability is often of crucial importance to breeding success, as reproductive allocation requires nutrition-dependent decisions about

clutch size, egg size, the number and timing of breeding attempts, and parental investment (Monaghan and Nager 1997; Wiebe and Bortolotti 1995; Török *et al.* 2004; Durant *et al.* 2005). Unpredictable food availability may result in brood reduction or hatching asynchrony (Magrath 1989), reduced survival prospects of fledged young (Magrath 1991), and impact upon adult fitness (Julliard *et al.* 1997). The nestling period of growth and development is critical, when food limitation may result in both an immediate reduction in fitness, and long-term consequences including reduced post-fledging survival, reduced probability of recruitment to the breeding population, reduced number of breeding seasons and reduced lifetime reproductive success (Lindström 1999; Brzek and Konarzewski 2001; Naef-Daenzer and Gruebler 2016). Ultimately, food limitation and nutritional stress during the breeding season have been linked to population declines (Kitaysky *et al.* 2009; Harrison *et al.* 2011).

For altricial nestlings, fast growth of many anatomical traits such as body size and mass, is restricted to the short period between hatching and fledging, thought to be an adaptation to reduce the time when the chicks are exposed to predators whilst in the nest (Starck and Ricklefs 1998). Thus, nestling growth is a fundamental determinant of fitness, as fledglings in good body condition are more likely to survive than those in poorer condition (Magrath 1991; Naef-Daenzer *et al.* 2001; Bouwhuis *et al.* 2015). The speed of growth is positively related to food intake (Gebhardt-Henrich and Richner 1998; Naef-Daenzer and Keller 1999), and therefore ultimately depends on food availability within the parental territory (Richner 1989), parental quality and their provisioning abilities (Chamberlain *et al.* 1999), and competition among nestlings for the available food brought to the nest (Neuenschwander *et al.* 2003).

Declines in farmland birds are of major conservation concern, in part because birds are considered to be sensitive bio-indicators of environmental quality. The abundance of invertebrates in the farmed landscape has declined concurrently with farmland bird declines (e.g. Aebischer 1991; Sotherton and Self 2000; Wilson *et al.* 2009). Agricultural intensification has had a detrimental effect on invertebrate abundance and availability, through the increased use of agrochemicals (e.g. Aebischer 1991), reduction in invertebrate availability through increased vegetation density (e.g. Douglas *et al.* 2009), and altered land use and management (Wilson *et al.* 1999; Sotherton and Self 2000; Møller 2001). The abundance, diversity, detectability and accessibility of invertebrates during the breeding

season plays a fundamental role in the reproductive success of insectivorous birds (e.g. Sotherton *et al.* 1993; Morris *et al.* 2005), and the reduction in availability of invertebrates is thought to be a driving factor behind the ongoing population declines of many farmland passerines (Møller 2001; Hart *et al.* 2006).

Dietary studies are essential in understanding the full spectrum of the trophic ecology of a species, and the impact of variations in both quality and quantity of potential invertebrate prey across a breeding season on diet composition (Naef-Daenzer *et al.* 2000). Over the last decade, DNA based methods for inferring diet, and network analyses of ecological systems have advanced considerably, with new technologies and analytical techniques. Traditional methods for studying diet, including direct observation of foraging (Chamberlain *et al.* 1999), visual inspection and microscopic examination of faeces (Gruar *et al.* 2003), and more invasive techniques such as the use of neck ligatures (Johnson *et al.* 1980), have been replaced by methods such as high-throughput sequencing (HTS) dietary assessment. This technique was first employed by Deagle *et al.* (2009) and allows the complete dietary breadth of species to be determined by providing precise taxonomic identification of prey items within highly diverse diets; this includes both uncommon prey items and species never previously recorded, as they leave no hard-parts in faeces (Brown *et al.* 2012).

No previous studies have examined the possibility of direct links between diet composition in the nest and indicators of future life-history success, such as nestling growth (Metcalf and Monaghan 2001), using HTS techniques. Thrushes provide ideal tractable model species with which to investigate the relationship between availability of key invertebrate groups, dietary composition, trophic ecology and growth and condition of nestlings. The Blackbird *Turdus merula* and Song Thrush *Turdus philomelos* are resident breeders and winter migrants in the UK, recorded across a wide variety of habitats including woodland, farmland and urban environments. Other spatial factors which may influence diet composition, nestling condition and reproductive success, such as fine-scale habitat around each nest and weather variables, are discussed in Chapter 5.

In the UK, Blackbirds underwent a long-term decline from the early 1970s until the mid-1990s, followed by a strong but partial recovery, driven mainly by increases in Wales, north-

western England and Scotland, but this recovery has recently stalled (Robinson *et al.* 2015). Annual population changes correlate best with adult survival (Robinson *et al.* 2012) and reduced adult survival is thought to have driven the population decline (Siriwardena *et al.* 1998), potentially as a consequence of agricultural intensification (Fuller *et al.* 1995). Research by Hatchwell *et al.* (1996), comparing Blackbirds nesting in woodland and farmland on Wytham Estate, Oxfordshire in 1991 – 1993, found that birds nesting in farmland exhibited demographic characteristics expected of a population in sub-optimal habitat. This was indicated by demographic factors, such as a greater number of young males breeding in farmland and a higher turn-over of breeding Blackbirds in farmland, with breeding birds moving from farmland into woodland. Blackbirds feed on a wide range of invertebrates including earthworms, slugs, caterpillars, beetles and spiders. Fruit can also be an important component of the diet outside the breeding season, particularly in late summer and early winter. Previous dietary studies have focused on nestlings (Snow 1958, Török 1981, Török 1985, Török and Ludvig 1988, Schnack 1991, Chamberlain *et al.* 1999, Szentkirályi and Krištín, 2002), and identified a generalist diet, with chicks being provisioned with a diverse range of invertebrates.

In contrast to Blackbirds, Song Thrushes have declined rapidly since the early 1970s as a breeding species in lowland Britain (with declines strongest in Wales and northern England; little change in Northern Ireland and south-eastern England; Robinson *et al.* 2015), with marked declines on farmland where approximately 70% of pairs have been lost (Peach *et al.* 2004). Consequently, the Song Thrush is red-listed as a species of conservation concern in the UK (Eaton *et al.* 2015). Baillie *et al.* (2001) examined extensive long-term demographic data and found no indication of changes in ‘per attempt’ nesting success. However, the results of an intensive study conducted by the Royal Society for the Protection of Birds (RSPB) suggested that on lowland arable farmland, breeding Song Thrushes mitigated the impacts of food shortages on nestlings by confining their nesting attempts to periods when invertebrate availability was adequate to raise a brood of young (Gruar *et al.* 2003).

Microscopic analysis of faeces revealed that Song Thrush nestlings and adults feed mainly on earthworms, snails, adult beetles and insect larvae (Gruar *et al.* 2003). A limited number of studies have compared nestling diet between the two thrush species and found that Song

Thrushes have a narrower dietary breadth than that of Blackbirds (Schnack 1991; Török 1985; Gajdoš and Krištín 1997). Both Blackbird and Song Thrush can have multiple broods within a season, so it is possible that there are changes in nestling diet between successive breeding attempts, as well as within an individual breeding attempt, as chicks age and grow.

Overall this chapter aims to determine the full dietary breadth of farmland Blackbirds and Song Thrushes using comprehensive molecular methods (Gap 2) to address Gap 3 by examining the links between diet composition and nestling growth and condition. Specifically, these data will test the following hypotheses:

- (1) Nestling diet is more diverse in a more complex landscape (South Glamorgan) than in a less complex landscape (Cambridgeshire).
- (2) The diet of nestlings varies in relation to nestling age, with a change in the proportion of different prey taxa.
- (3) Across a season the proportion of different prey taxa in the diet of nestling thrushes will change according to prey availability
- (4) Blackbird nestlings in simplified habitats (Cambridgeshire) may be less likely to reach the weight threshold (55g at 8 days old; Magrath 1991) to survive to independence.
- (5) Different prey taxa may be associated with better overall body condition for nestling thrushes

4.2 Methods:

4.2.1 Sites and faecal sample collection:

Fieldwork was carried out during the main nesting period for Song Thrushes and Blackbirds in March to August, and was conducted on a farm of mixed livestock and arable land-use and high habitat complexity in Wenvoe, South Glamorgan during 2013 – 2015, and also on a

more specialised arable farm with lower habitat complexity, in Hildersham, Cambridgeshire during 2015 (described in Chapter 2). Nest searching effort was consistent across farm sites and between years. To determine breeding density, walks of the field boundaries were conducted from a different starting point each time, every three weeks between mid-March and early July, and territories mapped according to the location of singing males. No territory surveys were carried out under wet or windy conditions as this reduced singing behaviour and made locating and following birds more difficult. To aid with territory mapping, the location of every individual thrush seen or heard was also plotted on farm maps

Nests were located by tapping with a stick along hedgerows to flush birds from nests, cold searching likely nesting locations, or by observing adults carrying building material or food back to the nest. Once located, nests were marked using a handheld Garmin GPSmap 60CSx unit and monitored every 3 – 4 days until hatching. Upon hatching, nestlings were handled every other day until the risk of ‘exploding’ out of the nest prematurely became too high, typically at 7 – 9 days, depending on chick development rate (Ferguson *et al.* 2011; Streby *et al.* 2013). Handling involved weighing individuals with a digital balance ($\pm 0.1\text{g}$), and recording morphometrics using callipers (minimum tarsus length $\pm 0.1\text{mm}$, head-beak length $\pm 0.1\text{mm}$) to determine growth rates. If hatch day was unknown, nestlings were aged by comparison of feather growth with nestlings of known age. Faecal samples were collected into individually labelled Eppendorf tubes and frozen at -20°C until subsequent analysis.

Adult Blackbirds and Song Thrushes were also caught at Wenvoe, using mist nets and tape lures set in copses around the farm. When caught, adults were ringed with a uniquely numbered British Trust for Ornithology metal ring, weighed ($\pm 0.1\text{g}$) and maximum wing chord measured ($\pm 0.5\text{mm}$). Faecal samples were collected from the inside of clean bird bags, in which the birds were temporarily held after capture. All faecal samples collected were frozen at -20°C as soon as possible after collection (1 – 8 hours) until subsequent analysis.

4.2.2 Laboratory analysis of faecal samples:

DNA was extracted from each faecal sample using a slightly modified version of the QIAamp[®] DNA Stool Mini Kits (Qiagen, Manchester, UK), extending the digestion step to 30

min, increasing the drying step to 3 min centrifugation and reducing the final elution volume to 100 μ l. To reduce the risk of contamination, faecal extractions were conducted within a laminar flow hood in a separate lab to that used for PCR set-up. Extraction controls (n = 40) were used throughout for each batch of faecal extractions. Universal 'mini-barcode' primers jgLCO1490 (TNTCNACNAAYCAYAARGAYATTGG; Geller *et al.* 2013), and EPT-long-uniRed (AARAAAATYATAAYAAANGCGTG; modified from Hajibabaei *et al.* 2011), were used to amplify a 133 bp region of the cytochrome c oxidase (COI) mitochondrial gene. To amplify a longer 306 bp fragment of COI, samples were also screened with mICO1intF (GGWACWGGWTGAACWGTWTAYCCYCC; Leray *et al.* 2013), and C1-N-2191/Nancy (CCCGGTAAAATTAATAAATAAACTTC; Simon *et al.* 1994). Both primer pairs are evaluated in Chapter 3. Each faecal sample was labelled with a unique combination of HTS grade forward and reverse 10 bp MID tags (Brown *et al.* 2014). Extraction controls and PCR negatives were included to test for contamination arising from laboratory practice, reagents or the environment. PCRs were carried out in 10 μ l reaction volumes containing 5 μ l multiplex buffer (Qiagen, Manchester, UK), 1.7 μ l H₂O 0.2 μ l forward primer (10 μ M), 1 μ l reverse primer (10 μ M) added individually, 0.1 μ l Bovine Serum Albumin (BSA; New England Biolabs, UK), and 2 μ l DNA. Reaction conditions consisted of an initial denaturation at 95°C for 15 minutes; 40 cycles of 95°C for 30 seconds, 50°C for 90 seconds, 72°C for 90 seconds and a final extension of 72°C for 10 minutes. To limit false positives and tag jumping, PCR set-up was performed in a UV-irradiated clean hood, MID tags were ordered in batches, and PCR negatives and positive controls were used throughout (following recommendations detailed in Murray *et al.* 2015; Schnell *et al.* 2015, and Ficetola *et al.* 2016).

Samples were visualised under UV light on a 2% agarose gel stained with SYBR@Safe (ThermoFisher Scientific, Paisley, UK), and pooled according to intensity of the PCR product when compared to a standardised 100 bp ladder. A BioAnalyzer (Agilent Technologies, Santa Clara, CA), was used to check the pooled peak amplicon size, determine DNA concentration and to check for the presence of primer dimer. Samples were purified in pools of similar DNA concentration using a QIAquick PCR Purification kit (Qiagen, Manchester, UK), quantified using a Qubit (ThermoFisher Scientific, Waltham, MA), and pools subsequently combined in order to provide an approximately equal amount of amplicon DNA from each faecal sample. Extraction and PCR negative controls were included to act as library controls and sequenced

alongside samples, to obtain as much information as possible about any combination that might distort results. Finally, Agencourt AMPure XP purification beads (Beckman Coulter, Pasadena, CA), were used to perform a final clean-up of the pools of individually-tagged amplicons and remove any remaining primer dimer. The NEBNext Ultra DNA Library Prep Kit for Illumina (New England Biolabs, Ipswich, UK), was used to prepare the pooled MID tagged amplicons for paired end sequencing. The library was sequenced using 250 bp paired-end reads on a MiSeq desktop sequencer (Illumina, San Diego, CA).

4.2.3 Bioinformatics:

Illumina adapters were removed and paired-end sequences filtered for quality, removing low quality leading or trailing bases using Trimmomatic v0.36 (Bolger *et al.* 2014) with a minimum quality score of 20 over a sliding window of 4 bp, retaining sequences within a minimum length of 80 bp. Filtered trimmed paired sequences were aligned using FLASH (Magoc and Salzberg 2011), before retaining sequences with an exact match to the oligos used for PCR by means of the “trim_seqs” command in Mothur (Schloss *et al.* 2009), which demultiplexes sequences into faecal sample specific files, removing the MID tag and primer sequences from the reads. Sequences were condensed into molecular operational taxonomic units (MOTUs) using USEARCH software v9.2.64 (Edgar 2010), first by de-replicating to remove any infrequent haplotypes with fewer than 10 sequences within a faecal sample, then discarding potential chimeras (“uchime2_denovo”), and finally clustering at 97% similarity (as discussed in Clare *et al.* 2011 for the COI barcode region).

The BLAST algorithm (Altschul *et al.* 1997), was used to query the NCBI nucleotide database and classify all MOTUs using a cut-off of 90% sequence identity and valuation of bit scores, which indicate how good the alignment is. Due to the short length of the sequences obtained (133bp), a rigorous filtering process and stringent match criteria were implemented, to allow higher precision in MOTU assignment and to reduce redundancy and noise (Flynn *et al.* 2015), as any ecological conclusions should be robust to sensible parameter choices (Clare 2016). The following criteria were adapted from Razgour *et al.* (2011), and Hawkins *et al.* (2015), to create five identification confidence levels using a threshold of 99% (rather than

>98.5%) for a species, to reflect the shorter amplicon length compared to the 157bp sequences generated using the Zeale *et al.* (2011) primers:

- (1) Solid match (>99%) to one species (0 – 1bp difference)
- (2) Match (>98%) (2bp difference) assigned to genus
- (3) If the sequence matched more than one species (>99%) belonging to different genera, only one of which was a species recorded in the UK, the assignment was made at the species level to the UK species
- (4) If the sequence matched more than one species from the same genus, tribe or family, more than one of which occurs in the UK, the lowest (most ancestral) common taxonomic rank was assigned, down to the level of Order
- (5) If the sequences matched a species not known to be recorded in the UK, this was reduced to the lowest common UK taxonomic rank

Any sequence matches with more than a 3bp difference were disregarded, because taxonomic assignments using COI below 97.4% are potentially erroneous (Alberdi *et al.* 2012), and error prone, unless target fauna are comprehensively barcoded (Wilson 2010). Any MOTUs matching bacterium, gastrotrichs, fungus, algae or the known laboratory contaminant German cockroach *Blattella germanica* were discarded.

To deal with any background contamination within PCR negatives and extraction blanks, a sequence read number approach was taken (Dunn *et al.* 2018). Any sequences found in samples with unused MID tag combinations, which could only be attributed to background contaminants or “tag jumping” (Kircher *et al.* 2012; Schnell *et al.* 2015), were also considered. Sequences reported only in negatives were removed. For the remaining negatives and unused MID tag combinations, we identified the highest read number within a negative sample and then removed this sequence from any sample where the read number was below this threshold, allowing for consideration of specific contaminant sequences at the molecular identifier. Finally, multiple sequences matching the same taxonomic unit were combined.

4.2.4 *Statistical analysis:*

This study considers associations between the proportion of different Orders within the diet, with the growth and body condition of nestling thrushes. The presence or absence of each MOTU within each sampling unit was used for dietary analysis. MOTUs were categorised at the Order-level for the analysis of trophic ecology (Pompanon *et al.* 2012). Dietary components were classified into seven broad categories: Araneae (spiders), Coleoptera (beetles), Crassicolitellata (earthworms), Diptera (flies), Lepidoptera (butterflies and moths), Panpulmonata (slugs and snails), and other (which included rarer prey items such as Julida (millipedes), Orthoptera (grasshoppers), and Polydesmida (millipedes)). These effects were investigated using the statistical software R, version 3.4.0 (R Core Development Team, 2017). Analyses were performed separately for Blackbirds and Song Thrush, after preliminary analyses reported a significant difference in age-specific body mass between the two focal species.

Breeding density was not included as a covariate within any models as the data collected was not deemed to be of good enough quality due to time constraints, difficulties interpreting the difference between global home range and nesting home range (Peach *et al.* 2004), and changes in the territory size of birds throughout the nesting period (Møller 1990).

4.2.4.1 *Rarefaction analysis:*

We conducted rarefaction analysis using the R package ‘vegan’ (Oskanen *et al.* 2016), to determine species accumulation curves for nestling thrushes of both species and adult Blackbirds at Wenvoe, estimating the proportion of total MOTUs and overall dietary diversity captured. For this analysis, nestling samples were pooled and analysed at the nest level to determine the power of the sampling achieved.

4.2.4.2 *Nestling growth:*

Generalised additive mixed models (GAMMs) were fitted separately for Blackbird and Song Thrush nestlings, using the R package ‘gamm4’ (Wood 2011), with ‘gamma’ distribution of errors and ‘identity’ link functions. Repeated measures from nestlings within a brood were accounted for by including ‘unique nest’ (i.e. nest identity) as a random intercept effect, to

represent repeated measurements from each nest. The smoothing parameter was set at 6 “knots”, to balance the explanatory power of the model against minimising over-fitting of the data (Hastie and Tibshirani 1990). Models were validated using residual diagnostic plots to verify the assumptions of normality and homogeneity of model residuals, to evaluate over-dispersion and to test for unduly influential observations (Zuur *et al.* 2010).

4.2.4.3 *Dietary breadth, overlap and temporal variation:*

Analysis was carried out at the level of the individual brood. Multiple faecal samples from nest-mates of the same age were extracted and processed separately, and data from nestlings within each brood were subsequently combined after the bioinformatics stage to avoid pseudo-replication in subsequent statistical analysis. Nestling weights and morphometrics (head length and tarsus length) were also averaged across each nest (i.e. at the level of the sampling unit), to avoid pseudo-replication due to non-independence of measurements from nest-mates. Measurements taken from “runt” nestlings or asynchronously late-hatched nest mates were excluded, as these nestlings were markedly smaller (defined as having an initial minimum of 3mm smaller tarsus, 2mm smaller head and 2g lighter in weight than the next-largest sibling), and these size differences became more pronounced with age. These runts often died prematurely.

To investigate differences in diet across the multiple prey taxa eaten by Blackbirds and Song Thrushes, we performed a multidimensional scaling (MDS) analysis. MDS returns a set of observations into a dimensional space, where the distances among points are optimised to reflect the dissimilarities between samples (broods of known age). We performed MDS on a matrix of “Bray-Curtis” distances between the broods, to represent the diet in two-dimensional space (k=2).

Generalised linear mixed-effects models (GLMMs) using the R package ‘lme4’ (Bates *et al.* 2013), were used to investigate differences in the number of taxonomic units. Unique nest identity was included as a random effect to account for repeated measures (e.g repeated nestling measurements from the same nest), with a ‘negative binomial’ error family and an overdispersion parameter (theta value) of 6. Models were validated following Thomas *et al.* (2017), by calculating the overdispersion statistic, and checking the distribution of residuals

for normality and homoscedasticity. The final models were selected using backwards stepwise deletion.

To investigate any changes in the proportion of different Orders within the diet throughout the breeding season, generalised linear mixed-effects models (GLMMs) using the R package ‘lme4’ (Bates *et al.* 2013) were carried out. Once again, unique nest identity was included as a random effect to account for repeated measures with a ‘negative binomial’ error family and ‘log’ link function.

4.2.4.4 Associations between diet, nestling age and condition:

GLMMs were also used to determine whether the proportion of different prey Orders changed in relation to nestling age. Unique nest identity was included as a random effect to account for repeated measures with a ‘binomial’ error family, scaling for day and weighted by differences in MOTU number, to allow for a converging model. Separate GLMMs were run for each of the seven different categories of dietary components and the appropriate link function was selected for each different model: ‘log’ - Diptera, Lepidoptera and Panpulmonata; ‘cloglog’ - Araneae and Coleoptera; ‘probit’ - Haplotaxida; and ‘cauchit’ – Other.

An index of mean nestling condition was created for each species, using residuals from a linear regression of each brood’s mean nestling weight on mean tarsus length (Labocha and Hayes 2012). Dirichlet regressions for compositional diet data (Sánchez and Dos Santos 2015), were fitted using the R package ‘DiRichletReg’ (Maier 2014), to identify how the relative proportions of categories of taxonomic units within each dietary category related to nestling condition.

4.2.4.5 Dietary breadth and overlap of adults and nestlings:

To calculate dietary overlap between adults and nestlings at the taxonomic unit level, we calculated Pianka’s measure of overlap (Pianka 1986) in R, with the package ‘EcoSimR’ (Gotelli and Ellison 2013).

4.3 Results:

Between 2013 and 2015, 174 thrush nests were monitored in Wenvoe (Blackbird n = 111, Song Thrush n = 63), of which 80 reached the nestling stage (Blackbird n = 48; Song Thrush n = 32). A total of 639 measurements were taken from nestlings monitored in Wenvoe. Faecal samples were collected from 526 nestlings and DNA was successfully amplified and sequenced from 410 extractions (Blackbird n = 257; Song thrush n = 153). During 2015, 17 nests were also monitored in Hildersham (Blackbird n = 15; Song Thrush n = 2), of which 6 reached the nestling stage. Seventy measurements were recorded from nestlings at Hildersham, and DNA was successfully amplified and sequenced from 54 extractions. Thirty-two faecal samples were collected from adult thrushes at Wenvoe (Blackbird = 29, Song Thrush = 3). The following results examine the links between how food availability and diet influence nestling growth and condition over the breeding season.

4.3.1 *Overall High-Throughput Sequencing results:*

Faecal samples were sequenced on three separate Illumina runs. Unfortunately, no sequences for the longer amplicon survived the bioinformatics process, as the shorter primer pairs were preferentially amplified within each HTS run. All the results presented are therefore for the short amplicon pair.

The first run resulted in 10,649,758 paired reads, and following quality filtering and removal of Illumina adapters, 6,517,306 sequences remained, of which 4,491,366 were aligned paired reads. After eliminating reads without an exact primer match, 2,837,334 sequences remained. Following de-replication, 2,028 unique sequences remained. After applying a 98% threshold, and discarding sequences from bacteria, fungi, and six sequences which were found at their highest read numbers in negative control samples, 805 unique sequences remained, assigned to 308 taxonomic units.

The second run generated 12,254,054 paired reads, 9,763,033 sequences remained after quality filtering resulting in 7,774,307 aligned paired reads. Only reads with an exact primer match were kept, resulting in 4,999,684 sequences. After de-replication, 3,860 unique

sequences remained. Once again, a 98% threshold was applied and sequences from bacteria and fungi discarded. Twenty-seven sequences were removed, as they were found at their highest read number in negative control samples. Overall, 674 sequences remained, assigned to 103 taxonomic units.

The third Illumina run resulted in 10,949,012 paired reads, and following removal of adaptors and quality filtering, 5,850,703 sequences remained, of which 4,040,437 were aligned paired pairs. After eliminating reads without an exact primer match, 2,688,606 sequences were retained and after de-replication, 1162 unique sequences remained. After applying the 98% threshold, deleting three sequences that were found at their highest read numbers in negative control samples, and discarding sequences from bacteria and fungi, 446 sequences remained, assigned to 126 taxonomic units

After bioinformatics processing, the three pools were combined for analysis. A total of 338 taxonomic units were identified from faecal samples, of which 255 were identified to species (75.5%), an additional 71 to genus (21%), 10 to family level (3%) and the remaining two to order (0.5%). At the farm in Wenvoe, Blackbird nestling samples contained 238 MOTUs, of which 129 were found only in Blackbirds and 109 MOTUs were shared with Song Thrush. Song Thrush nestling samples contained 167 MOTUs, of which 58 were unique to Song Thrush. Blackbird adult samples contained 73 MOTUs, of which 17 were only found in adult samples. Two MOTUs were unique to adult Song Thrush ($n = 3$), which were excluded from analyses and comparisons due to the very small sample size. At the farm in Hildersham, Blackbird nestling samples contained 114 MOTUs, of which 85 were only found in Blackbird samples and 29 MOTUs were shared with Song Thrush. An additional 19 MOTUs were only found in Hildersham Song Thrush samples (total 48 MOTUs).

4.3.2 *Rarefaction analysis:*

Rarefaction analysis for samples collected from Wenvoe suggested that we detected over 50% of the available taxonomic units for Blackbird and Song Thrush nestlings, and for Blackbird adults (Figure 4.1). The estimated (asymptotic) dietary breadth was 240 taxonomic units for

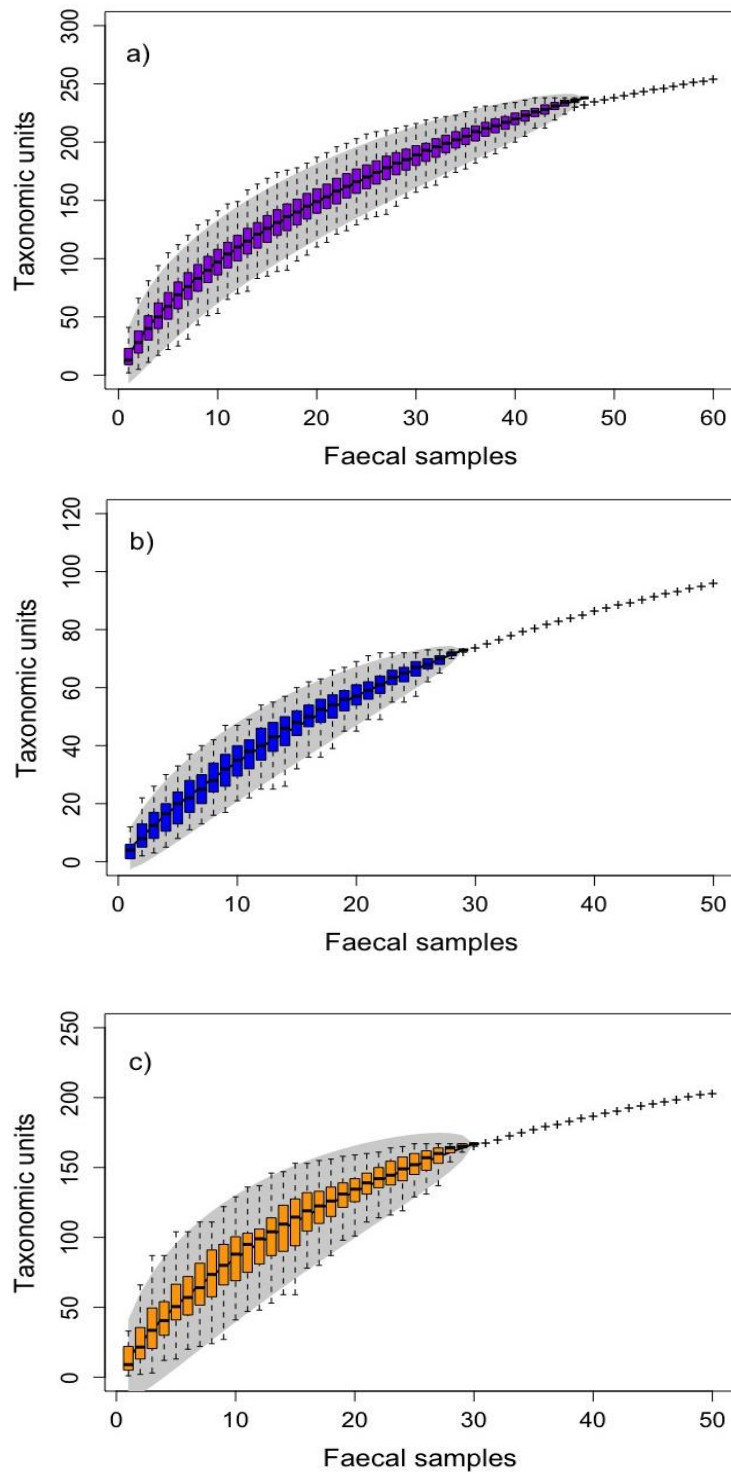

Figure 4.1: Species accumulation curves for a) nestling Blackbirds; b) adult Blackbirds and c) nestling Song Thrush at Burdon’s Farm, Wenvoe, South Glamorgan, based on the accumulation of taxonomic units detected across successive faecal samples. Boxplots from raw data based on 100 permutations of samples in a random order are overlaid by confidence intervals (grey shading) and predicted points, denoted by “+”.

nestling Blackbirds when considering samples pooled at the nest level (n = 48), compared to 160 taxonomic units from 29 nests for Song Thrush

4.3.3 Nestling growth: Generalised Additive Mixed Model (GAMM) analysis:

An initial GAMM model to explain nestling mass confirmed that Blackbird nestlings were significantly heavier than Song Thrush nestlings ($-4.240 \text{ g} \pm 0.594$, $P < 0.0001$), when controlling statistically for nestling age (GAMM model; $F = 50.597$, d.f. = 1,675, $P < 0.0001$). Analysis was then conducted for Blackbirds and Song Thrush separately. To aid analysis different site/year combinations were created (e.g. W13 – which represents nests from Wenvoe in 2013), rather than treating year and site as two independent variables with statistical models.

A GAMM model to explain the mass of Blackbird nestlings (Table 4.1) revealed that there was a significant effect of season represented in the model by “hatch day” (nestlings were slightly but significantly larger later in the season $+ 0.055 \text{ g} \pm 0.015$, $P < 0.0001$), but no significant effect of brood size on nestling mass ($P = 0.986$) was reported. Blackbirds often raise two or more broods in a season, but the status of individual nest attempts (1st/2nd/3rd broods) in this study was unknown.

Table 4.1: GAMM to explain body mass of Blackbird nestlings in relation to brood size, date (HatchDay), and nestling age, at the different site/year combinations. Individual nest ID was used as a random term in the GAMM.

Parameter	Estimate \pm SE	F	d.f.	P
Brood size	0.005 \pm 0.276	0.018	1	0.9858
Hatch day	0.055 \pm 0.015	3.613	1	0.0003
Site/year C15	-2.389 \pm 1.906	-1.254	1	0.2107
Site/year W13	-2.174 \pm 1.513	-1.436	1	0.1517
Site/year W14	-0.308 \pm 1.402	-0.219	1	0.8265
Smoothed terms		F	Effective d.f.	P
s(Chick.age):W15		119.3	3.780	< 0.0001
s(Chick.age):C15		193.7	1.930	< 0.0001
s(Chick.age):W13		424.4	2.022	< 0.0001
s(Chick.age):W14		273.3	3.074	< 0.0001

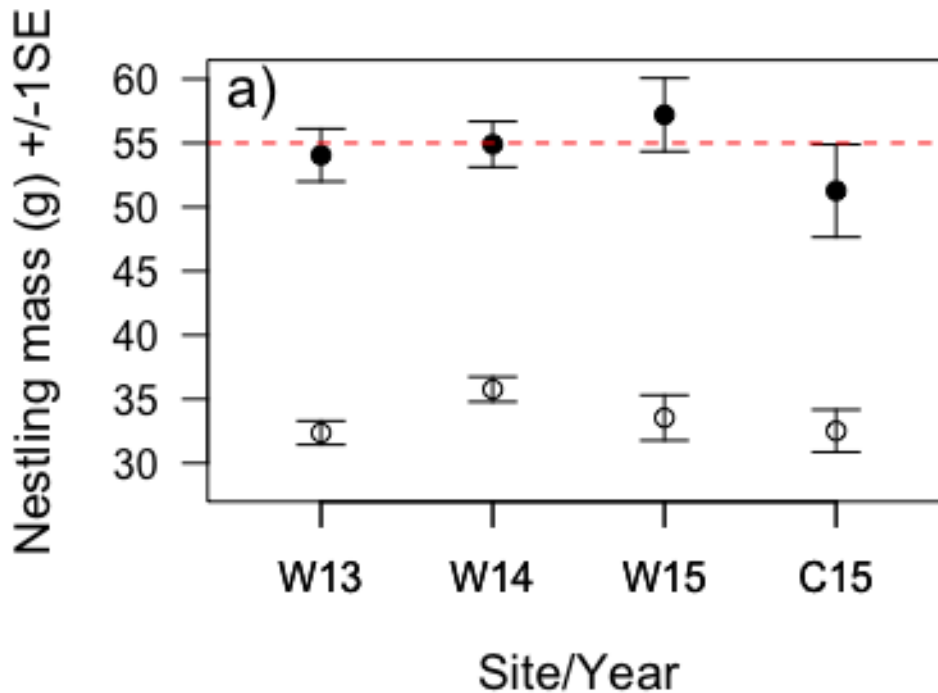

Figure 4.2: GAMM model predictions for Blackbird nestling body mass in different site-year combinations. W = Wenvoe study site, South Glamorgan. C = Hildersham study site, Cambridgeshire. 13/14/15 indicates the years 2013/14/15. Open circles indicate 5-day old nestlings and closed circles indicate 8-day old nestlings. Error bars indicate +/- 1SE. The red dotted line indicates the threshold body mass that 8-day old Blackbird chicks need to exceed if they are to successfully survive beyond independence (Magrath 1991).

There were significant differences in the age-specific body mass of Blackbird nestlings in the different site/year combinations illustrated in Figure 4.2. In particular, the 8-day old nestlings at Hildersham, Cambridgeshire (C15), failed to exceed the threshold of 55g that has been previously described as the minimum 8-day old nestling mass required for survival to independence (Magrath 1991), and deemed to be an accurate measure of nestling quality. Despite a poor start in 2013, nestlings at Wenvoe (W13) experienced a period of compensatory growth over three days to reach the 55g threshold by day 8.

A GAMM model to explain the mass of Song Thrush nestlings (Table 4.2) revealed that there was a significant effect of brood size on nestling mass (nestlings were slightly but significantly smaller in larger broods – $1.393\text{g} \pm 0.273$, $P < 0.0001$), but no significant effect of hatch day on nestling mass ($P = 0.916$). However, Song Thrushes often raise two or more broods in a season and the status of nest attempts for every pair was unknown.

Table 4.2: GAMM to explain body mass of Song Thrush nestlings in relation to brood size, date (HatchDay), and nestling age, at the different site/year combinations. Individual nest ID was used as a random term in the GAMM.

Parameter	Estimate \pm SE	F	d.f.	P
Brood size	-1.393 \pm 0.273	-5.100	1	< 0.0001
Hatch day	0.001 \pm 0.010	0.106	1	0.9157
Site/year C15	0.330 \pm 1.639	0.201	1	0.8405
Site/year W13	-3.337 \pm 1.519	-2.088	1	0.0377
Site/year W14	-1.433 \pm 1.566	-0.915	1	0.3612
Smoothed terms		F	Effective d.f.	P
s(Chick.age):W15		196.9	1.000	< 0.0001
s(Chick.age):C15		231.0	2.641	< 0.0001
s(Chick.age):W13		541.0	1.284	< 0.0001
s(Chick.age):W14		354.5	3.092	< 0.0001

There were significant differences in the age-specific body mass of Song Thrush nestlings in the different site/year combinations (Figure 4.3). Nestlings were heaviest in Wenvoe during 2013 (W13), whereas the following year appeared to be a poor year for the growth and condition of nestlings, which were significantly lighter ($-3.337\text{g} \pm 1.519$, $P = 0.0377$).

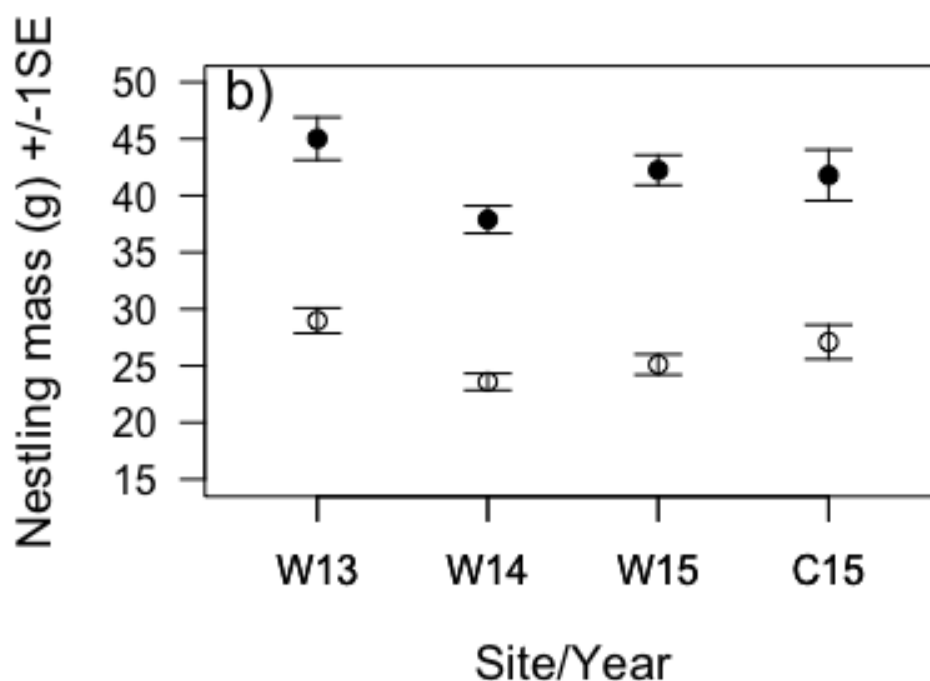

Figure 4.3: GAMM model predictions for Song Thrush nestling body mass in different site-year combinations. W = Wenvoe study site, South Glamorgan. C = Hildersham study site, Cambridgeshire. 13/14/15 indicates the years 2013/2014/2015. Open circles indicate 5-day old nestlings and closed circles indicate 8-day old nestlings. Error bars indicate \pm 1SE.

4.3.4 Number of MOTUs:

A GLMM was used to compare the number of MOTUs detected in each sample in relation to nestling age, date, species and site/year. Nest ID was used as a random term within this model. This model showed that there was a significant difference in number of MOTUs between species (GLMM: LRT = 4.213, d.f. = 1,172, $P = 0.040$), with Song Thrushes having a significantly smaller number of MOTUs per nestling sample than Blackbirds, and a significant difference in MOTUs between site/year combinations (LRT = 34.369, d.f. = 3, 172, $P < 0.0001$).

For Blackbirds, there was no significant change in number of MOTUS per nestling sample across the study season (LRT = 1.060, d.f. = 1,103, $P = 0.303$), or with chick age (LRT = 0.963, d.f. = 1,103, $P = 0.326$). There was significant site/year variation in the number of MOTUs recorded in Blackbird nestling diet (LRT = 29.4467, df = 3, 103, $P < 0.0001$), with Hildersham in 2015 having a significantly higher number of MOTUS than at Wenvoe in any of the three years; Figure 4.5).

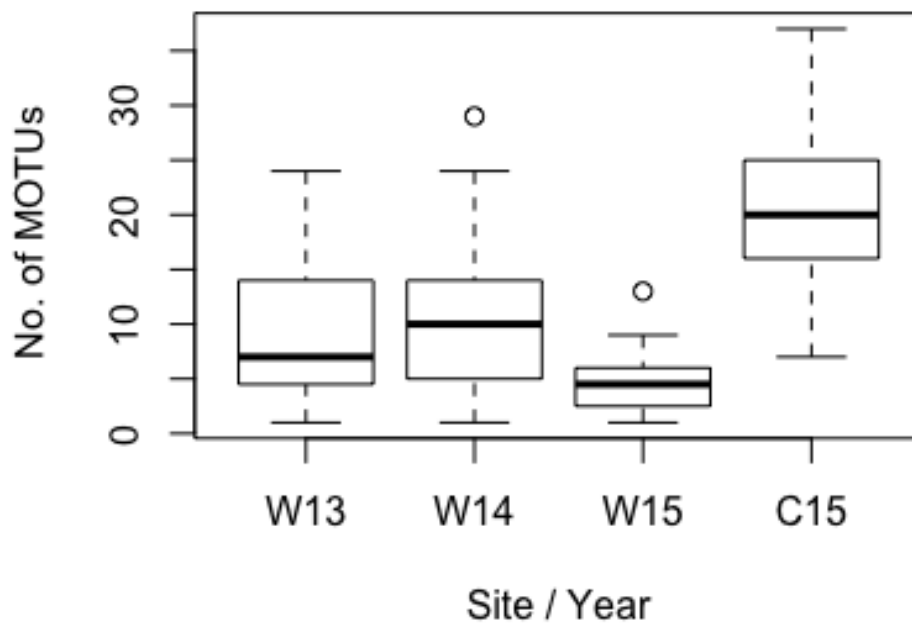

Figure 4.5: Number of MOTUs detected in nestling Blackbird diet samples in different site-year combinations. W = Wenvoe study site, South Glamorgan. C = Hildersham study site, Cambridgeshire. 13/14/15 indicates the years 2013/2014/2015.

For Song Thrushes, there was no significant change in number of MOTUS per nestling sample across the study season (LRT = 0.7441, d.f. = 1, 62, P = 0.3883), or with chick age (LRT = 0.0006, d.f. = 1,62, P = 0.9809). There was significant site/year variation in the number of MOTUs recorded in Song Thrush nestling diet (LRT = 22.0614, d.f. = 3, 62, P<0.0001), with Hildersham in 2015 and Wenvoe in 2013 having a significantly higher number of MOTUs per sample than Wenvoe in 2014-15 (Figure 4.6).

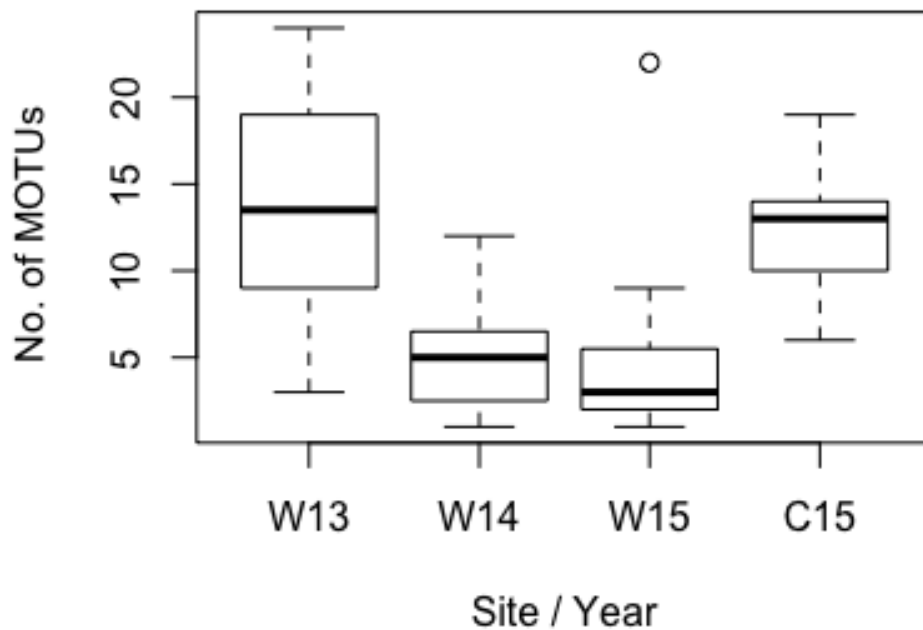

Figure 4.6: Number of MOTUs detected in nestling Song Thrush diet samples in different site-year combinations. W = Wenvoe study site, South Glamorgan. C = Hildersham study site, Cambridgeshire. 13/14/15 indicates the years 2013/14/15.

4.3.5 *Dietary breadth, overlap and spatio-temporal variation:*

Pianka's overlap values were 0.789 between Blackbird adults and nestlings at Wenvoe, and 0.551 between nestling Song Thrush and Blackbirds at Wenvoe; both of these overlap values were statistically significant at $P < 0.0001$. Multi-dimensional scaling (MDS) was used to examine dietary overlap between site-year combinations for each of the thrush species. These visualisations showed substantial similarity in the diet in different site-year combinations for both Blackbirds (Figure 4.7) and Song Thrushes (Figure 4.8).

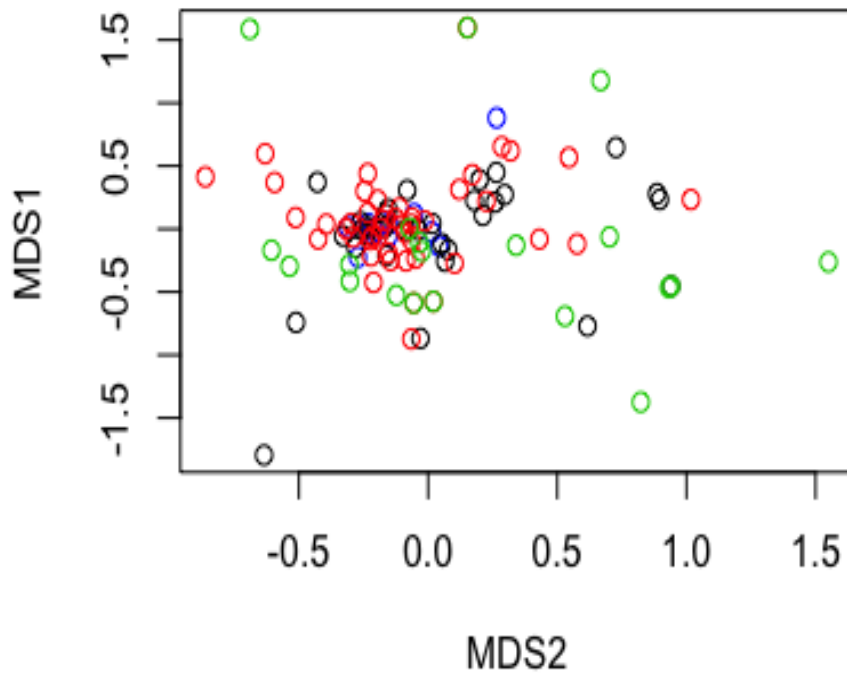

Figure 4.7: Multi-dimensional scaling visualisation, showing variation in Blackbird diet across multiple taxa, represented in 2-dimensions. The graph shows strong overlap in diet between the different site-year combinations (Wenvoe 2013, Black; Wenvoe 2014, Red; Wenvoe 2015, Green; Hildersham, Cambridgeshire, 2015, Blue).

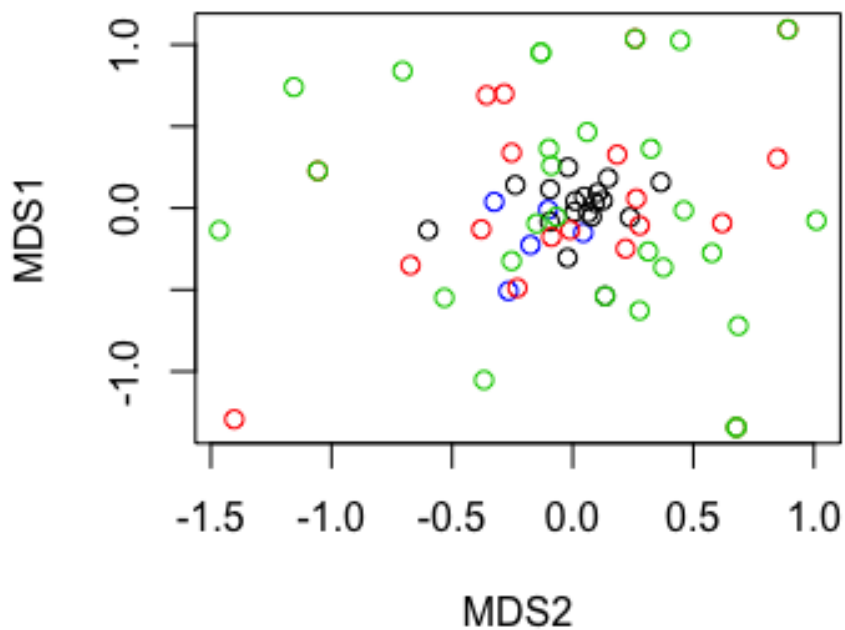

Figure 4.8: Multi-dimensional scaling visualisation, showing variation in Song Thrush diet across multiple taxa, represented in 2-dimensions. The graph shows strong overlap in diet between the different site-year combinations (Wenvoe 2013, Black; Wenvoe 2014, Red; Wenvoe 2015, Green; Hildersham, Cambridgeshire, 2015, Blue).

4.3.6 Associations between dietary composition and nestling body condition:

The Dirichlet regression for compositional diet data identified only one taxon as having a significant relationship with Blackbird nestling body condition. The proportion of earthworms within Blackbird nestling diet showed a positive effect on condition; a higher proportion of Crassiditellata (earthworms) in the diet was associated with higher body condition (Table 4.3; Figure 4.9).

Table 4.3: Results of a Dirichlet regression analysis of Blackbird nestling body condition (dependent variable) in relation to different taxonomic components of nestling diet (independent variables).

Taxon	Beta-coefficient	SE	Z	P
Araneae	0.014	0.034	0.394	0.694
Coleoptera	-0.003	0.036	-0.078	0.937
Crassiditellata	0.079	0.038	2.044	0.041
Diptera	0.050	0.037	1.348	0.178
Lepidoptera	-0.004	0.041	-0.086	0.931
Pulmonata	-0.007	0.032	-0.232	0.817
Other	0.032	0.038	0.840	0.401

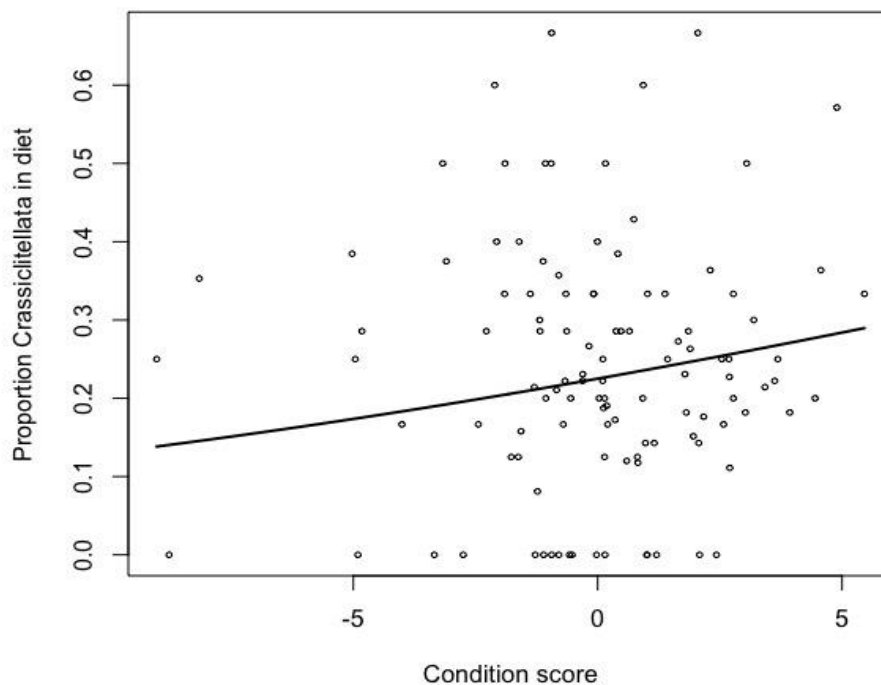

Figure 4.9: Dirichlet regression model predictions for Blackbird nestling body condition score versus the proportion of earthworms in the nestlings' diet.

An equivalent Dirichlet regression identified no significant associations between diet and Song Thrush nestling condition ($P > 0.05$ for all taxa; not shown).

Taxon-specific analysis of diet identified significant associations between the relative abundance of specific taxa in the diet of nestling Blackbirds, and several independent variables. Specifically, the abundance of earthworms in the diet of nestling Blackbirds at Wenvoe (Table 4.4) was significantly and positively associated with chick age (Chick.age.zero; older nestlings were more likely to yield earthworm DNA), and farm-year combination (Site.year; nestlings at Hildersham in 2015 were less likely to yield earthworm DNA than nestlings at Wenvoe in any year). None of the other categories of taxonomic unit showed a significant relationship with nestling age (results not shown).

Table 4.4: GLMM analysis of spatio-temporal variation in earthworm % abundance in the diet of nestling Blackbirds at Wenvoe.

	Estimate	Std. Error	Z value	Pr(> z)
(Intercept)	-0.8699	0.1132	-7.683	<0.0001
Chick.age.zero	0.0460	0.0198	2.320	0.0203
Site.yearW14	-0.0159	0.1027	-0.155	0.8771
Site.yearW15	0.1614	0.1727	0.935	0.3498
Site.yearC15	-0.2991	0.1303	-2.296	0.0217
Scale(Day)	-0.0500	0.0514	-0.974	0.3301
Condition	-0.0085	0.0170	-0.500	0.6173

Chick age (Chick.age.zero) was also the only dietary category significantly associated with abundance of earthworms in the diet of nestling Song Thrushes at Wenvoe (Table 4.5).

Table 4.5: GLMM analysis of spatio-temporal variation in earthworm % abundance in the diet of nestling Song Thrushes at Wenvoe.

	Estimate	Std. Error	Z value	Pr(> z)
(Intercept)	1.5757	0.7855	2.006	0.0449
Chick.age.zero	0.1701	0.0428	3.970	<0.0001
Day	0.0074	0.0073	1.018	0.3085
Site.yearW14	0.0096	0.6576	0.015	0.9883
Site.yearW15	-0.5704	0.6794	-0.840	0.4011
Site.yearC15	-0.3630	0.9134	-0.397	0.6911

Results for the dietary composition on Song Thrushes from our study sites were compared to values from the previous literature (Table 4.6).

Table 4.6: Composition of Song Thrush diet in the present study (Burdon’s Farm, Wenvoe, South Glamorgan, and Lay Rectory Farm, Hildersham, Cambridgeshire), in comparison with previous dietary studies. Values indicate percentage contribution of each taxonomic grouping to the overall diet in each site/study.

Major prey groupings	This study		Gruar <i>et al.</i> 2003		Murray 2004
	South Glamorgan	Cambridge	Sussex	Essex	Leicestershire
Araneae	6.0	8.3	4.1	2.7	9.9
Coleoptera	16.4	10.4	21.3	15.8	12.6
Adults	-	-	15.1	11.6	-
Larvae	-	-	6.2	4.2	-
Earthworms	6.7	12.5	35.4	32.3	26.7
Diptera	26.2	18.8	3.3	6.1	11.1
Adults	-	-	2.2	2.9	-
Larvae	-	-	1.1	3.2	-
Lepidoptera	15.2	12.5	6.4	8.3	-
Adults	-	-	0.5	0.2	-
Larvae	-	-	5.9	8.1	-
Pulmonata	11.6	14.6	-	-	27.5
Snails	-	-	19.1	28.9	-
Miscellaneous larvae	-	-	-	-	3.8
Others	17.7	22.9	7.7	4.7	8.4
Collembola	3.0	6.3	0.1	0.3	-
Diplopoda	-	-	0.0	0.2	-
Julida	2.4	2.1	-	-	-
Glomerida	0.6	0.0	-	-	-
Ephemeroptera	1.8	2.1	-	-	-
Formicidae	-	-	1.8	1.1	-
Hemiptera	4.3	2.1	< 0.1	0.0	-
Hymenoptera	0.0	2.1	-	-	-
Isopoda	0.6	0.0	-	-	-
Isoptera	-	-	0.2	1.0	-
Opiliones	0.0	0.0	< 0.1	0.0	-
Orthoptera	1.2	2.1	0.3	0.2	-
Plecoptera	0.6	2.1	-	-	-
Thysanoptera	0.6	0.0	0.0	0.0	-
Trichoptera	2.4	4.2	-	-	-
Unidentified	-	-	5.3	1.8	-
Number of faecal samples	153	17	99	40	73

In accordance with previous studies, Song Thrush have a diet dominated by earthworms, Coleoptera and insect larvae, although, comparisons of the relative importance of different prey groups are hindered by the use of different sampling methods (neck ligatures, microscopic examination and HTS). Equivalent studies which provided enough detail could not be found for Blackbirds.

4.4 Discussion:

High-throughput sequencing was used to determine the complete dietary breadth of Blackbirds and Song Thrushes in farms of differing complexity. Nestling diet was found to be more diverse, with a greater number of MOTUs recorded in the diet of thrushes in the complex landscape (South Glamorgan) than in the less complex landscape (Cambridgeshire). Adult thrushes were generally consistent between years in what they fed their nestlings. Food abundance, foraging success and overall reproductive success may be limited by factors including vigilance and perceived predation risk, habitat, accessibility of key prey resources, and weather. There was significant site/year variation in the age specific body mass of nestlings and number of MOTUs recorded in the diet of both thrush species. Across a season, there was no change in the proportion of different prey taxa in the diet of nestling thrushes. Previous research has shown a pronounced seasonal dietary switch, due to the reduced availability of key invertebrate resources during periods of dry weather, as earthworms and slugs respond to abiotic conditions by descending deeper into the soil and aestivating (Gerard 1967; Hunter 1996), reducing their accessibility to foraging thrushes. Gruar *et al.* (2003) reported a marked seasonal decline in the quality of diet, as Song Thrushes shifted from earthworms to snails, and then to an increasing proportion of spiders due to the dry weather of late summer. A dietary switch was also reported by Chamberlain *et al.* (1999), as the availability of earthworms was dependent on rainfall on farmland, and Blackbirds switched to caterpillars during dry periods.

Species-specific brood trait associations with hatch day were found for Blackbirds, with nestlings being slightly heavier later in the breeding season, although, knowledge regarding the success of previous nesting attempts and brood status were not known. Previous research often reports the opposite result with lighter nestlings recorded later in the breeding season

due to declining female body condition and changing environmental conditions (Gruar *et al.* 2003; Liljeström *et al.* 2012). Overall, Blackbirds were able to provision their nestlings adequately throughout the breeding season across a range of conditions with no effect of brood size on nestling weights.

A significant effect of brood size was found for Song Thrushes, with larger broods having a negative effect on the weight of nestlings. The results support previous experiments manipulating brood size which have shown increased brood size causes low nestling weights and reduced recapture rates (Tinbergen and Boerlijst 1990). Although research by Chamberlain *et al.* (1999), and Murray (2004), reported a significant increase in provisioning rate with brood size in both male and female thrushes. Adult breeding productivity is linked to foraging success in different foraging habitats (Anderson *et al.* 2002; Berg 2008). Unpredictable food availability may rest in a trade-off between parental investment and further reproductive success, as reduced parental quality can have knock on effects impacting upon adult fitness (Julliard *et al.* 1997). During periods of food abundance, a reduced parental work rate can occur in habitats with higher foraging success and prey availability (Wernham and Bryant 1998).

Results obtained highlighted a direct link between diet composition in the nest and nestling growth, an indicator of future life history success. For altricial nestlings, the fast growth of many anatomical traits such as body size and mass, is restricted to the short period between hatching and nestling, with a direct positive relationship between the speed of growth and food intake (Gebhardt-Henrich and Richner 1998; Naef-Daenzer and Keller 1999). Despite a poor start in Wenvoe during 2013, undernourished nestlings at 5 days old showed evidence of compensatory growth over three days, and reached the threshold of 55g that has previously been described as the minimum 8-day old nestling mass required for survival to independence (Magrath 1991), and deemed to be an accurate measure of nestling quality. Whilst compensatory growth allows nestlings to fledge at a suitable size and time, several studies have demonstrated a resulting short-term biometric effect, reduced histology and gut function, and an increase in corticosterone (Crisuolo *et al.* 2008; Honarmand *et al.* 2010; Konarzewski *et al.* 1996; Konarzewski and Starck 2000; Kriengwatana *et al.* 2014). Nestling growth is a fundamental determinant of fitness, as fledglings in good body condition are more likely to

survive than those in poorer condition. Poorly fed nestlings can also suffer an increased risk of predation, due to both an extended nestling period and because hungry broods beg more frequently and louder (Haff and Magrath 2011). Conditions during early life can determine ageing patterns and life history strategies throughout the individual's lifespan, resulting in long-term consequences, as reproductive success is an important determinant of species' population change (Briga *et al.* 2017).

Only earthworms were found to be associated with better overall body condition for nestling thrushes, when considering an index of mean nestling condition created using residuals from a linear regression of each brood's mean nestling weight on mean tarsus length (Labocha and Hayes 2012). There were no clear associations between other prey taxa and nestling body condition for either Blackbirds or Song Thrushes. Fledglings in good body condition are more likely to survive than those in poorer condition (Magrath 1991; Naef-Daenzer *et al.* 2001; Bouwhuis *et al.* 2015). Chamberlain *et al.* 1999 previously found nestlings provisioned on earthworm-rich diets were significantly heavier than those fed mainly on caterpillars, when considering mean nestling mass per brood. Nestling diet changed with age, with both Blackbirds and Song Thrushes feeding a higher proportion of earthworms to older nestlings. The size of the nestling and its ability to swallow are factors which will limit the size of prey brought by the parents. Thus, as expected, nestlings receive a gradual increase in the size and biomass of prey items as they grow. Gruar *et al.* (2003) found compositional changes in the diet of Song Thrush dependent on age class, as nestlings had a larger proportion of insect larvae within examined faeces than adults which had a diet dominated by earthworms. However, they only compared across the entire nestling period, and did not consider age-related variation of nestling diet.

The results from HTS confirm a high dietary overlap between Blackbird and Song Thrush nestlings, although significant differences in dietary composition were also found. As in previous studies (Schnack 1991; Török 1985; Gajdoš and Krištín 1997), Song Thrush nestlings were found to have a narrower dietary breadth with fewer recorded MOTUs. Significant dietary overlap between Blackbird adults and nestlings was also found, however, it was not possible to link samples from adult birds with samples from nestlings in specific nests.

The invertebrate orders found in this dietary study are generally similar to those found by other researchers which identified a generalist diet, with nestlings provisioned with a diverse range of invertebrates and earthworms, slugs, beetles, caterpillars and spiders being particularly important prey items (Snow 1958; Török 1981; Török 1985; Török and Ludvig 1988; Schnack 1991; Chamberlain *et al.* 1999; Szentkirályi and Krištín 200; Gruar *et al.* 2003; Murray *et al.* 2004). Differences may be as a result of different sampling methods (neck ligatures, microscopic examination and HTS), and also partly attributable to the effects of local vegetation differences, weather and season on invertebrate availability. Published work on avian diet often identifies invertebrate prey in insufficient detail to reveal all the invertebrate families that were identified as present within the diet. Overall, HTS results outperform previous traditional morphological methods of diet assessment in terms of sensitivity (the number of different taxa identified) and taxonomic resolution. This study also validates the use of the carefully selected primer pair jgLCO1490/EPT-long-uniRed (Chapter 3) which targeted a short amplicon of 133 bp to maximise the diversity of amplified taxa. Taxonomic discrimination at the species level was 76%, with a further 21% of taxonomic units identified to genus, and the remaining 3% to family.

In light of the importance of trophic relationships in influencing demographic change (Metcalf and Monaghan 2001), and evidence for compensatory growth reported, further insights into the trophic mechanisms driving habitat exploitation may be revealed by considering the availability of prey species within different habitat elements, as well as the dietary preferences of the focal species itself (Chapter 5). Overall, these results highlight the broad dietary range of both species, the inter-specific, intra-specific and age-related variation in nestling diet, and the consequences of dietary composition for nestling growth and survival. Future research could consider the macronutrient content of key invertebrate resources which would provide further insight into the importance of each dietary item for the fitness of the consumer.

CHAPTER 5: **Habitat associations:**



“A bird sitting on a tree is never afraid of the branch breaking, because her trust is not on the branch but on her own wings”

Anon

Tracking the foraging activity of thrushes across farmland landscapes, using molecular investigation of diet

For invertebrate-eating birds, particularly those with limited foraging ranges during the nesting period, heterogeneity at the farm scale (between fields), and within fields, is thought to be particularly important. The foraging preferences of Blackbirds and Song Thrushes in relation not simply to habitat complexity, but specifically to the availability of habitat elements associated with strong exploitation links, were considered by combining data regarding the relative abundance of different prey taxa in farmland habitats (Chapter 2) with the occurrence of prey in the diet (Chapter 4). Blackbirds in the relatively simplified landscape of Hildersham had more Coleoptera in their diet than expected; suggesting that beetles are a greater part of Blackbird diet in situations such as at Hildersham during the sampling period, where earthworms and molluscs are scarce. Diptera were also over-represented in the diet of both species. Overall, results show that a fine-scale mosaic of agricultural elements provides birds with redundancy in terms of the abundance and diversity of suitable prey items to exploit. Although, access to resources, rather than food abundance *per se*, could be a critical factor in determining habitat use by farmland birds. In order to increase the diversity and heterogeneity of habitat elements and improve the availability of key invertebrate resources for foraging birds, greater management of non-boundary habitats, such as field margins and broad agri-environment options which focus on quality rather than quantity of habitat, may be necessary.

5.1 Introduction:

Changes in land use due to agricultural intensification have been associated with a loss of heterogeneity at the landscape scale (Robinson and Sutherland 2002; Butler *et al.* 2007). The subsequent homogenisation and degradation of suitable habitats (Altieri 1999), and reduced availability of resources (Benton *et al.* 2003), have had multiple detrimental impacts on biodiversity (Tscharntke *et al.* 2005), especially for farmland birds (Donald *et al.* 2001; Teillard *et al.* 2014; Santana *et al.* 2017). Many bird species require a diversity of resources over spatial and temporal gradients, to provide sufficient foraging habitats and suitable nest sites. Landscape-scale heterogeneity (between farms) is positively correlated with increased

species diversity and composition of bird communities (Fuller *et al.* 1997; Benton *et al.* 2003; Winqvist *et al.* 2011), rather than abundance (Siriwardena *et al.* 2000). Species with large home ranges or territories can exploit the spatial diversity of differing habitat types for feeding and nesting opportunities (Pickett and Siriwardena 2011). The majority of these patterns appear to be particularly pronounced in winter, especially for granivorous birds, reflecting a need for seeds and grain.

For invertebrate-eating birds, particularly those with limited foraging ranges during the nesting period, heterogeneity at the farm scale (between fields), and within fields, is particularly important. The overall value of non-cropped boundary features, such as hedgerows, ditches and field margins, for farmland birds is well recognised (Chapter 2); however, the proportion of non-cropped areas available to foraging birds has declined (Stoate *et al.* 2001). An increase in farming intensification has led to the loss of around 50% of Britain's hedgerows since the 1940s, resulting in a reduction in nesting habitat for farmland birds, and a decrease in invertebrate availability for bird species for which hedgerows form an essential foraging habitat (Maudsley 2000; Robinson and Sutherland 2002; Whittingham and Evans 2004). Uncultivated field margins can support a rich range of invertebrate prey (Meek *et al.* 2002; Westbury *et al.* 2017). However, these buffer strips have had limited benefits for farmland birds during the breeding season (Baker *et al.* 2012), highlighting the need for sympathetic management of non-cropped boundary habitats (Douglas *et al.* 2009; Vickery *et al.* 2009; Fritch *et al.* 2017). Access to resources, rather than food abundance *per se* could be a critical factor in determining habitat use by farmland birds (Atkinson *et al.* 2005). Boundaries that comprise a hedge and uncultivated margin, under varying degrees of management, can further increase heterogeneity within boundary features, and may even enhance invertebrate food resources within adjacent fields through 'positive spill-over' of invertebrates from source habitats of high invertebrate abundance, into surrounding habitats of lower abundance (Vickery *et al.* 2002; Rand *et al.* 2006).

A marked reduction in heterogeneity within fields, a more uniform structure, and/or increased sward density, can have further functional and ecological significance for foraging success of farmland birds. Crop structure can directly affect the abundance or diversity of invertebrate prey, and their detectability and accessibility to foraging birds (Wilson *et al.* 2005; Dunn *et*

al. 2010). Indirectly, crop structure and sward density can impact on the trade-off between time allocated to feeding versus vigilance for predators, depending on the anti-predation strategy of different species (Whittingham *et al.* 2006). Overall, the progressive simplification of farmed landscapes, and reduction in heterogeneity across different spatial scales, leads to a loss of the combination of landscape features needed by breeding birds (Gabriel *et al.* 2010; Vickery *et al.* 2014).

A fine-grained mosaic of agricultural habitats is particularly crucial for hedgerow nesting species that are limited by habitat types, and which forage in crops up to 500 m from the nest site (e.g. Grey Partridge *Perdix perdix*: Green 1984; Tree Sparrow *Passer montanus*: Field and Anderson 2004; Yellowhammer *Emberiza citrinella*: Douglas *et al.* 2009). Song Thrushes *Turdus philomelos* and Blackbirds *Turdus merula* have been found to have an even smaller nesting home range during the breeding season than the aforementioned species. Radio-telemetry revealed that Song Thrushes travel approximately 100 m from the nest during the nesting period (Peach *et al.* 2004; Murray 2004). However, nest site selection may be a more critical determinant of breeding success for Song Thrush than are surrounding foraging opportunities (Sparks *et al.* 1996; Kelleher and O'Halloran 2007). Young Song Thrushes dispersed 100 m from the nest up to seven days after fledging but did not subsequently move significantly further from the nest, remaining in cover until independence (Snow 1955a; Simms 1978; Hill 1998). Blackbird nests are more likely to be found near a hedgerow intersection (Lack 1988), and nesting home ranges and foraging distances often increase during the breeding season, as birds travel further to forage, up to a maximum distance of 80 m from the nest (Török and Ludvig 1988). However, during periods of low food abundance, adult Blackbirds nesting in farmland have been recorded flying distances in excess of 300 m to provision their brood (Chamberlain *et al.* 1999).

Low food availability within the nesting home range can increase predation risk (Evans 2004; Dunn *et al.* 2010) through greater nest detectability, due to the increased begging of hungry nestlings (Haskell 1994), and reduced nest defence by adults (Schmidt 1999). Reduced invertebrate availability may also have detrimental consequences on nestling survival through brood reduction (Magrath 1989), and can affect nestling growth and development (Naef-Daenzer and Keller 1999), increase their risk of hypothermia (Potts 2012), and delay fledging

(Johnston 1993). Adults may have to increase energy expenditure to adequately provision nestlings (Wright *et al.* 1998) which, through carry-over effects into the next breeding cycle, can reduce subsequent breeding productivity and impact adult survival (Vickery and Arlettaz 2012).

Restoring the heterogeneity and complexity of agricultural landscapes has been proposed as a method to mitigate biodiversity declines caused by intensification of farming practices. In general terms, the more habitat elements within a farmed landscape, the greater the complexity, as a broader range of resources are available, supporting a higher diversity and abundance of organisms (Heikkinen *et al.* 2004). Agri-environment schemes (AES) have been the primary policy mechanism adopted to ameliorate impacts of agricultural intensification on wildlife populations (Donald *et al.* 2006). In England, many of the AES options available aim to provide resources for farmland birds, by attempting to improve habitat heterogeneity, through creating or restoring habitats focused on ensuring nesting habitat and invertebrate resources during spring and summer, and seed food during winter (Natural England 2013a; 2013b). Within Wales, the Glastir whole-farm sustainable land management scheme replaces several previous AES and aims to combat climate change, improve water management and maintain and enhance biodiversity. AES schemes have been successful in increasing invertebrate abundance and diversity in farming landscapes; for example, by funding incentives for creation of specific landscape features, such as cover crops, “beetle banks” and un-cultivated field margins (Thomas *et al.* 1991). Several studies have described associations between farmland birds and AES habitats (e.g. Wilson 2001; Douglas *et al.* 2009; Bright *et al.* 2015). There is a current lack of understanding of the potential mechanisms underlying the success, or otherwise, of AES regarding their impact on bird density and the use of different habitats by foraging birds (but see McHugh *et al.* 2016).

Attempts to increase nestling survival within farmland habitats, by increasing invertebrate abundance and availability to foraging birds, require an understanding of both the spatial distribution and availability of key prey (Chapter 2), and the invertebrate taxa commonly represented in nestling diet (Chapter 4). Overall, these approaches can be combined to investigate the ecological preferences of nesting habitat and foraging site requirements. Many previous studies are based on simple measures of habitat quality and the extent of abundance

of certain physical features of habitats, in an attempt to relate habitat quality to reproductive success, rather than qualitative measures such as the trophic resources that different habitat elements provide.

In this Chapter, data from both previous data Chapters are combined, to understand the trophic connections between the birds and different landscape elements, when provisioning nestlings. The following hypotheses were tested:

- (1) Dietary composition of thrushes reflects the presence and relative abundance of different potential prey taxa at the farm scale. Both Blackbirds and Song Thrushes, having a generalist diet, would provision their nestlings with prey in proportion to the availability of each prey taxon in the local environment.
- (2) Dietary composition of thrushes varies spatially and temporally, in relation to independent variables such as year, stage of breeding season, farm location, and weather.
- (3) Foraging thrushes exploit different elements of the landscape to different extents; *a priori* expectations were that Woodlands, hedgerows and conservation features such as cover crops would be more heavily used than crop and pasture fields.

Complex landscapes should provide foraging birds with redundancy, in terms of a diversity of suitable prey items to exploit. The strength of links between the birds and their choice of prey, and the distribution of that prey across the landscape, is expected to reveal the birds' utilisation of patchy farmland landscapes. This study therefore addresses the importance of different landscape elements (or mixtures of such components) to the nestling provisioning and breeding productivity of farmland birds.

5.2 Methods:

5.2.1 *Dietary Preference Analysis:*

Dietary preferences of Blackbirds and Song Thrushes were examined by comparisons of the relative frequency of occurrence of different taxa in the nestling diet of the two species, with

the relative frequency of the same taxa in the farmland environment. The analyses in this Chapter combine the invertebrate abundance and distribution data from Chapter 2 and the thrush dietary data from Chapter 4; methods for the collection and analysis of these data are described in detail in their respective Chapters. These comparisons were made using a simulation-based method, implemented using the R package “econullnetr” (Vaughan *et al.* 2017). This method calculates a “strength of preference” value for each prey taxon considered, indicating whether the prey appears in the diet more or less than is expected, given its relative abundance in the field samples; positive values indicate a preference for the prey taxon, and negative values indicate avoidance.

The different sampling methods used in the field (pitfall traps, vacuum sampling, worm and mollusc sampling), each have different efficacy for different prey taxa (Chapter 2). Therefore, separate prey preference analyses for the four different sampling methods were carried out, including in each analysis only those taxa that were the primary focus of the sampling method in question (e.g. only molluscs for the mollusc-sampling method, etc.). Furthermore, only those taxa that appeared at least once in both the diet of the nestlings and in the field sampling, were included in the analysis for each species-sampling method combination. An important caveat of this approach is that the resulting strength of preference values are directly comparable between prey taxa considered within each sampling method but are not directly comparable between prey taxa sampled using different sampling methods.

The calculated preferences for specific prey taxa, and avoidance of other taxa that were also present in the landscape, were used to interpret the likely foraging locations of the Blackbirds and Song Thrushes, given the spatial variation in abundance of the different prey taxa across different components of the farm landscape, as quantified in Chapter 2.

5.2.2 *Habitat Specific Prey Methods:*

Habitat specificity was examined using GLMM models to test for differences in abundance of individual slug and worm taxa between different landscape elements.

5.2.3 *Analysis of spatial and temporal variation in diet:*

Spatial and temporal variance in diet was analysed using permutational multivariate analysis of variance (perMANOVA), using the ‘adonis’ function in the R package ‘vegan’ (Oksanen *et al.* 2015), with the weighting for MOTU number accounting for potential sample size bias of using overall percentages for dietary orders. Backwards stepwise deletion was used to select the final perMANOVA model. Finally, multivariate differences in diet were also examined using multivariate generalised linear models (MGLM), implemented using the ‘manyglm’ function from the R package ‘mvabund’ (Wang *et al.* 2012). MGLMs were performed with a negative binomial error structure, weighted for differences in MOTU number due to sample size, before the final model was determined using backwards stepwise deletion.

The independent variables used in both the perMANOVA and manyGLM analyses were chosen to represent environmental variation across different temporal and spatial scales:

- Large spatial scale = site
- Small spatial scale = unique.nest
- Large temporal scale = year
- Short temporal scale = Chick.age + Day
- Weather influences on diet = temperature + rainfall

5.2.4 *Nest-scale analysis of foraging locations:*

The aim of this analysis was to investigate the likely source within the landscape of the prey taxa delivered to Thrush nestlings in each nest. To do this, the similarity between the relative abundance of different prey species in nesting diet, and the relative abundance of the same prey species in each of the specific landscape elements (individual fields, hedgerows, etc.) surrounding the individual nest site, within a radius of 200m, was examined.

The degree of similarity between nestling diet and prey species availability in different landscape elements was quantified using the p-values of Fisher’s exact tests as an index of similarity. These Fisher’s exact tests were applied pairwise, to each nest and landscape element. Lower p-values indicate less similarity between diet and prey abundance for that landscape element; conversely, higher p-values indicate greater similarity. To make these

similarity index values directly comparable between landscape elements, the abundance values in diet and landscape element were first standardized to an equal sample size, by converting the count values to integer percentage values (% of each prey species in the total count).

These nest-scale landscape-element analyses were carried out for the two most abundant major taxonomic groups featuring in Thrush diet at each nest; namely slugs (Pulmonata), earthworms (Crassichitellata), or beetles (Coleoptera), depending on which two of these three groups contributed most to the primary diet at each nest. As invertebrate abundance may vary between years, even when considering the same crop type (Aebischer 1991; Moreby and Southway 2002), only nests monitored from the same year invertebrate sampling took place were considered (Wenvoe, 2014; Hildersham, 2015). Nests with sufficient invertebrate sampling data from the surrounding landscape, were chosen to illustrate this approach and demonstrate the utility of this novel method. Detailed nest-level examples are provided for **3** Blackbird and **2** Song Thrush nests at Wenvoe, and for **1** Blackbird nest at Hildersham.

5.3 Results:

5.3.1 Prey selection by thrushes at the farm scale:

Strength of preference tests were carried out, using the “econullnetR” algorithm (Vaughan *et al.* 2017), for the different prey taxa detected in the diets of nestling Blackbirds and Song Thrushes, at Wenvoe and Hildersham. These comparisons showed that in general, thrushes provisioned their nestlings with prey broadly in proportion to their relative abundance at the farm-scale (Figure 5.1 – 5.3, Tables 5.1-5.6). However, some prey were significantly less represented in thrush diet than would be expected given their abundance at the farm scale, and other prey taxa were significantly more represented than expected.

For example, Blackbirds and Song Thrushes at Wenvoe ate significantly less of the slug species *D. reticulatum* than would be expected, given this slug species’ abundance at the farm scale (Figure 5.1, panel 2a). The under-representation of *D. reticulatum* in Blackbird and Song Thrush diet can be related to the geographical variation in abundance of this slug

species across the landscape (Figure 5.5, Tables 5.7-5.9). *D. reticulatum* is relatively scarce in woodland, wood margin and hedgerow habitats, indicating that thrushes may be foraging in these habitats, rather than in arable crops where this species of slug is relatively abundant.

1 Earthworms

a Blackbirds at Wenvoe

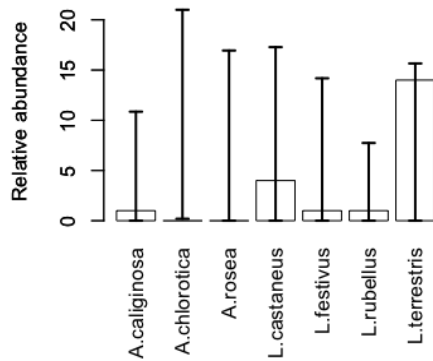

b Song Thrushes at Wenvoe

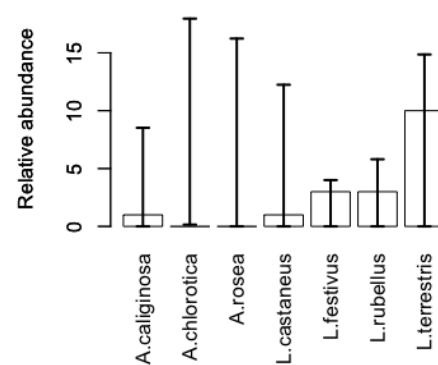

2 Molluscs

a Blackbirds at Wenvoe

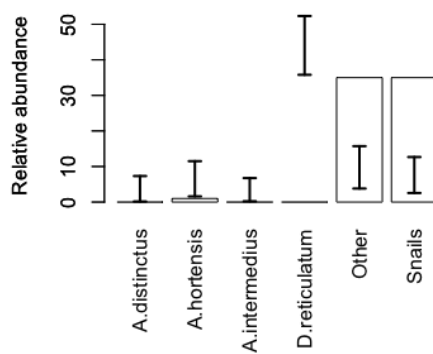

b Song Thrushes at Wenvoe

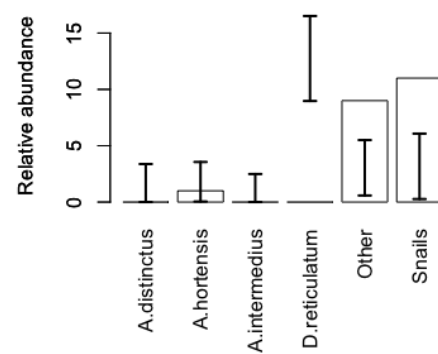

Figure 5.1: Strength of preference comparisons between different Earthworm and Mollusc prey taxa detected in the diets of nestling Blackbirds and Song Thrushes, at Wenvoe and Hildersham. Bars represent relative abundance in the diet, and error intervals represent abundance in samples obtained using different sampling methods in the field. Error intervals that do not overlap bars reveal less of this prey in the diet than expected from its observed frequency in the wild, at the farm scale and a ‘weaker’ preference. Error intervals that fall within bars indicate a ‘stronger’ preference with more of this prey in the diet than expected from its observed frequency in the wild. Overlap between the bars and error intervals reveal species eaten in proportion to their availability and no significant preference (see Table 5.1 and Table 5.2 for details of the individual strength of preference comparisons).

Table 5.1: Strength of preference comparisons between different earthworms detected in the diets of nestling Blackbirds and Song Thrushes, at Wenvoe. “Weaker” = less of this prey in the diet than expected from its observed frequency in the wild, at the farm-scale. “Stronger” = more of this prey in the diet than expected from its observed frequency in the wild. “NS” = reveal species eaten in proportion to their availability in the wild and no significant preference.

Consumer	Resource	Observed	Null	Lower 95% CL	Upper 95% CL	Test	SES
Blackbird	<i>A. caliginosa</i>	1	0.6762	<0.0001	10.5288	NS	0.1072
Blackbird	<i>A. chlorotica</i>	0	12.5713	0.2234	20.9970	Weaker	-1.7322
Blackbird	<i>A. rosea</i>	0	3.0275	<0.0001	16.9277	Weaker	-0.6197
Blackbird	<i>L. castaneus</i>	4	0.9448	<0.0001	7.0986	NS	1.1073
Blackbird	<i>L. festivus</i>	1	0.4460	<0.0001	2.7093	NS	0.2083
Blackbird	<i>L. rubellus</i>	1	1.0401	<0.0001	14.3953	NS	-0.0118
Blackbird	<i>L. terrestris</i>	14	2.2942	<0.0001	17.9617	NS	2.3243
Song Thrush	<i>A. caliginosa</i>	1	1.0982	<0.0001	10.7315	NS	-0.0331
Song Thrush	<i>A. chlorotica</i>	0	10.9334	0.0054	17.9989	Weaker	-1.6457
Song Thrush	<i>A. rosea</i>	0	2.3419	<0.0001	16.7699	Weaker	-0.4940
Song Thrush	<i>L. castaneus</i>	1	1.1242	<0.0001	14.4599	NS	-0.0367
Song Thrush	<i>L. festivus</i>	3	0.2929	<0.0001	4.0724	NS	2.1314
Song Thrush	<i>L. rubellus</i>	3	1.0013	<0.0001	13.6533	NS	0.5977
Song Thrush	<i>L. terrestris</i>	10	1.2081	<0.0001	8.0135	Stronger	3.0905

Table 5.2: Strength of preference comparisons between different molluscs detected in the diets of nestling Blackbirds and Song Thrushes, at Wenvoe. “Weaker” = less of this prey in the diet than expected from its observed frequency in the wild, at the farm scale. “Stronger” = more of this prey in the diet than expected from its observed frequency in the wild. “NS” = reveal species eaten in proportion to their availability in the wild and no significant preference.

Consumer	Resource	Observed	Null	Lower 95% CL	Upper 95% CL	Test	SES
Blackbird	<i>A. distinctus</i>	0	2.9239	0.1946	6.8560	Weaker	-1.6012
Blackbird	<i>A. hortensis</i>	1	5.2868	1.8531	11.0355	Weaker	-1.7779
Blackbird	<i>A. intermedius</i>	0	2.5313	0.3798	6.3247	Weaker	-1.5087
Blackbird	<i>D. reticulatum</i>	0	44.1418	34.3951	52.7723	Weaker	-8.9468
Blackbird	Other	35	9.6854	4.4144	17.6563	Stronger	7.4098
Blackbird	Snails	35	6.4308	2.3357	12.8845	Stronger	10.4346
Song Thrush	<i>A. distinctus</i>	0	0.8429	0.0019	3.8576	Weaker	-0.8831
Song Thrush	<i>A. hortensis</i>	1	1.5431	0.1102	3.7322	NS	-0.4834
Song Thrush	<i>A. intermedius</i>	0	0.8373	0.0035	3.2231	Weaker	-0.9185
Song Thrush	<i>D. reticulatum</i>	0	12.8754	9.1535	16.6948	Weaker	-6.6688
Song Thrush	Other	9	2.7124	0.4513	5.7103	Stronger	4.1302
Song Thrush	Snails	11	2.1888	0.2931	5.5104	Stronger	5.9424

3 Pitfall traps

a Blackbirds at Wenvoe

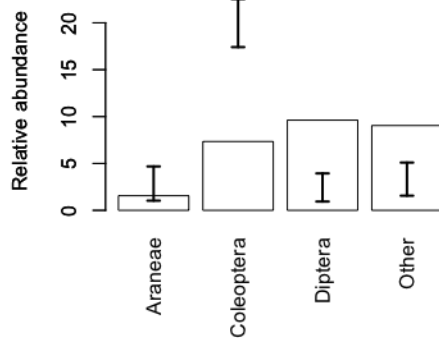

b Song Thrushes at Wenvoe

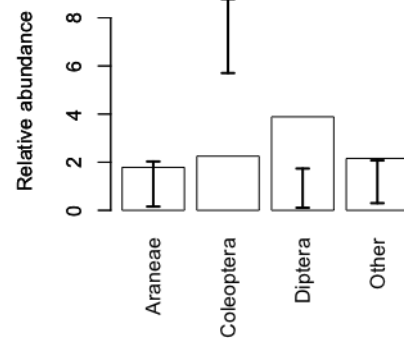

c Blackbirds at Hildersham

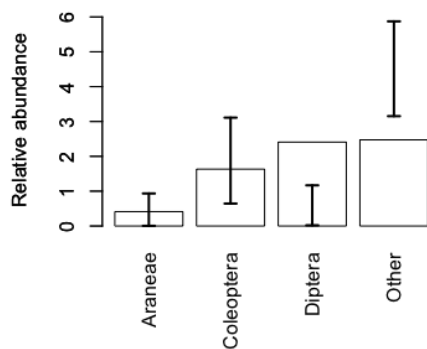

d Song Thrushes at Hildersham

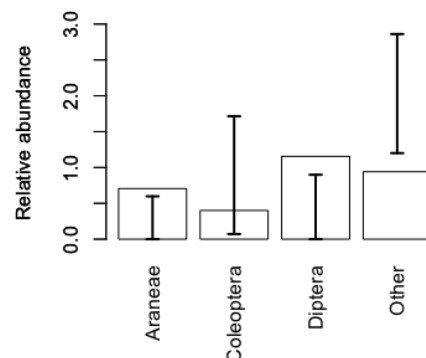

Figure 5.2: Strength of preference comparisons between different prey taxa detected in the diets of nestling Blackbirds and Song Thrushes, at Wenvoe and Hildersham. Bars represent relative abundance in the diet, and error intervals represent abundance in samples obtained using different sampling methods in the field. Error intervals that do not overlap bars reveal less of this prey in the diet than expected from its observed frequency in the wild, at the farm scale and a ‘weaker’ preference. Error intervals that fall within bars indicate a ‘stronger’ preference with more of this prey in the diet than expected from its observed frequency in the wild. Overlap between the bars and error intervals reveal species eaten in proportion to their availability and no significant preference (see Table 5.3 and Table 5.4 for details of the individual strength of preference comparisons).

Table 5.3: Strength of preference comparisons between different invertebrates sampled using pitfall traps and detected in the diets of nestling Blackbirds and Song Thrushes, at Wenvoe. “Weaker” = less of this prey in the diet than expected from its observed frequency in the wild, at the farm-scale. “Stronger” = more of this prey in the diet than expected from its observed frequency in the wild. “NS” = reveal species eaten in proportion to their availability in the wild and no significant preference.

Consumer	Resource	Observed	Null	Lower 95% CL	Upper 95% CL	Test	SES
Blackbird	Araneae	1.5598	2.8442	1.2839	4.5502	NS	-1.3699
Blackbird	Coleoptera	7.3414	19.6932	17.3833	22.2847	Weaker	-8.8798
Blackbird	Diptera	9.6160	2.2024	1.1060	3.9075	Stronger	10.2437
Blackbird	Other	9.0440	2.8214	1.6037	4.3002	Stronger	8.0522
Song Thrush	Araneae	1.7858	1.0180	0.1535	2.5432	NS	1.3209
Song Thrush	Coleoptera	2.2512	7.0768	5.2864	8.5042	Weaker	-5.6354
Song Thrush	Diptera	3.8869	0.8731	0.1785	2.1200	Stronger	5.7138
Song Thrush	Other	2.1583	1.1143	0.2454	2.4419	NS	1.7545

Table 5.4: Strength of preference comparisons between different invertebrates sampled using pitfall traps and detected in the diets of nestling Blackbirds and Song Thrushes, at Hildersham. “Weaker” = less of this prey in the diet than expected from its observed frequency in the wild, at the farm-scale. “Stronger” = more of this prey in the diet than expected from its observed frequency in the wild. “NS” = reveal species eaten in proportion to their availability in the wild and no significant preference.

Consumer	Resource	Observed	Null	Lower 95% CL	Upper 95% CL	Test	SES
Blackbird	Araneae	0.4122	0.3125	0.0001	1.0198	NS	0.3416
Blackbird	Coleoptera	1.6323	1.6851	0.7071	3.2893	NS	-0.0746
Blackbird	Diptera	2.4078	0.5049	0.0167	1.6721	Stronger	4.6472
Blackbird	Other	2.4728	4.4227	2.8935	5.7026	Weaker	-2.6820
Song Thrush	Araneae	0.7057	0.1220	<0.0001	0.7164	NS	2.7905
Song Thrush	Coleoptera	0.4008	0.7256	0.0624	1.5416	NS	-0.8307
Song Thrush	Diptera	1.1551	0.1628	0.0002	0.6643	Stronger	4.8657
Song Thrush	Other	0.9411	2.1923	1.4098	3.0326	Weaker	-2.7631

4 Vacuum samples

a Blackbirds at Wenvoe

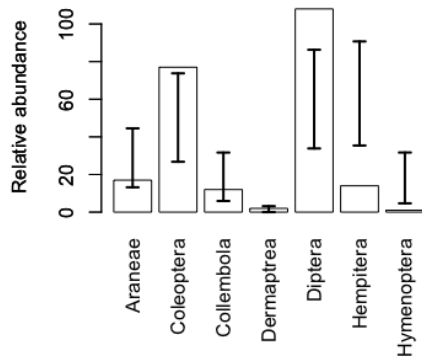

b Song Thrushes at Wenvoe

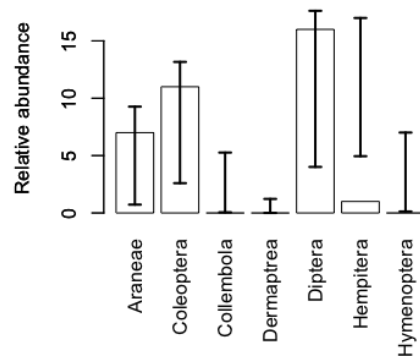

c Blackbirds at Hildersham

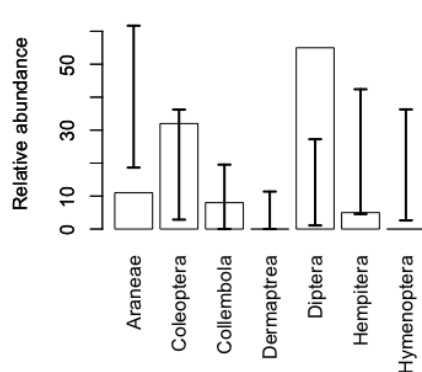

d Song Thrushes at Hildersham

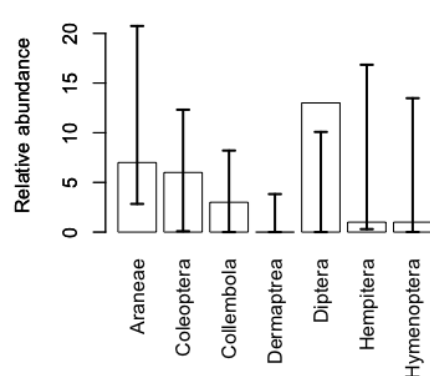

Figure 5.3: Strength of preference comparisons between different prey taxa detected in the diets of nestling Blackbirds and Song Thrushes, at Wenvoe and Hildersham. Bars represent relative abundance in the diet, and error intervals represent abundance in samples obtained using different sampling methods in the field. Error intervals that do not overlap bars reveal less of this prey in the diet than expected from its observed frequency in the wild, at the farm scale and a ‘weaker’ preference. Error intervals that fall within bars indicate a ‘stronger’ preference with more of this prey in the diet than expected from its observed frequency in the wild. Overlap between the bars and error intervals reveal species eaten in proportion to their availability and no significant preference (see Table 5.5 and Table 5.6 for details of the individual strength of preference comparisons).

Table 5.5: Strength of preference comparisons between different invertebrates sampled using vacuum sampling and detected in the diets of nestling Blackbirds and Song Thrushes, at Wenvoe. “Weaker” = less of this prey in the diet than expected from its observed frequency in the wild, at the farm-scale. “Stronger” = more of this prey in the diet than expected from its observed frequency in the wild. “NS” = reveal species eaten in proportion to their availability in the wild and no significant preference.

Consumer	Resource	Observed	Null	Lower 95% CL	Upper 95% CL	Test	SES
Blackbird	Araneae	17	29.7721	15.4952	48.4309	NS	-1.3689
Blackbird	Coleoptera	77	49.6511	30.9564	72.2920	Stronger	2.5743
Blackbird	Collembola	12	14.0132	3.8241	25.3433	NS	-0.3392
Blackbird	Dermaptera	2	0.5554	<0.0001	3.7580	NS	1.3057
Blackbird	Diptera	108	56.4277	34.3059	77.9560	Stronger	4.4587
Blackbird	Hemiptera	14	64.0126	41.7336	85.7443	Weaker	-4.1891
Blackbird	Hymenoptera	1	16.5680	41.5347	32.1866	Weaker	-2.2078
Song Thrush	Araneae	7	3.8788	0.7134	9.6529	NS	1.3793
Song Thrush	Coleoptera	11	7.4855	2.6290	14.7563	NS	1.0979
Song Thrush	Collembola	0	2.2530	0.0358	6.5718	Weaker	-1.2533
Song Thrush	Dermaptera	0	0.1208	<0.0001	1.1096	Weaker	-0.2793
Song Thrush	Diptera	16	8.4963	3.5911	14.9852	Stronger	2.3790
Song Thrush	Hemiptera	1	10.0009	4.0319	16.6126	Weaker	-2.6540
Song Thrush	Hymenoptera	0	2.7647	0.1989	6.7404	Weaker	-1.5154

Table 5.6: Strength of preference comparisons between different invertebrates sampled using vacuum sampling and detected in the diets of nestling Blackbirds and Song Thrushes, at Hildersham. “Weaker” = less of this prey in the diet than expected from its observed frequency in the wild, at the farm-scale. “Stronger” = more of this prey in the diet than expected from its observed frequency in the wild. “NS” = reveal species eaten in proportion to their availability in the wild and no significant preference.

Consumer	Resource	Observed	Null	Lower 95% CL	Upper 95% CL	Test	SES
Blackbird	Araneae	11	37.6135	19.1207	61.7835	Weaker	-2.1925
Blackbird	Coleoptera	32	18.1854	3.8187	36.4260	NS	1.4968
Blackbird	Collembola	8	6.2450	0.0709	19.7873	NS	0.3311
Blackbird	Dermaptera	0	1.6430	<0.0001	9.0885	Weaker	-0.5686
Blackbird	Diptera	55	10.9061	0.9744	28.6833	Stronger	5.4258
Blackbird	Hemiptera	5	21.5173	4.9078	41.8083	NS	-1.5953
Blackbird	Hymenoptera	0	14.8896	3.1891	32.5624	Weaker	-1.8004
Song Thrush	Araneae	7	11.7623	2.9430	21.6499	NS	-0.9036
Song Thrush	Coleoptera	6	4.9595	0.0832	12.3631	NS	0.2859
Song Thrush	Collembola	3	1.6006	<0.0001	7.3648	NS	0.5953
Song Thrush	Dermaptera	0	0.4361	<0.0001	3.6628	Weaker	-0.4049
Song Thrush	Diptera	13	2.7131	0.0051	9.0063	Stronger	3.6341
Song Thrush	Hemiptera	1	5.3333	0.2296	14.3964	NS	-1.0282
Song Thrush	Hymenoptera	1	4.1951	0.1007	13.4161	NS	-0.8346

Other significantly less-preferred prey of both Blackbirds and Song Thrushes at Wenvoe, were the earthworms *A. chlorotica* and *A. rosea* (Table 5.1), Coleopteran beetles (Figure 5.2; panel 3a, b), and Hemipteran bugs (Figure 5.3; panels 4 a,b).

Prey that were eaten significantly more than would be expected, given their abundance at the farm scale at Wenvoe, were; the earthworm *L. terrestris* in the diet of Song Thrushes (Figure 5.1, panel 1b; Table 5.1), and snails (Figure 5.1, panel 2a,b; Table 5.2) and Diptera in the diet of both Blackbirds and Song Thrushes (Figure 5.2, panel 3a, b; Tables 5.3).

At Hildersham, similar mismatches were evident between the relative abundance of different prey taxa at the farm scale, and the occurrence of those prey taxa in the diets of nestling thrushes. However, at Hildersham no earthworms or molluscs were sampled. Among the other taxa sampled, under-represented taxa were Dermaptera, Araneae and Hymenoptera in the diet of nestling Blackbirds (Figure 5.3, panel 4c; Table 5.6), and Dermaptera in the diet of nestling Song Thrushes (Figure 5.3, panel 4d; Table 5.6). As at Wenvoe, Diptera were over-represented in the diet of both species (Figure 5.2, panel 3c, d; Table 5.4), but in contrast to Wenvoe, where Coleoptera are underrepresented by >50%, Blackbirds at Hildersham had taken Coleoptera broadly in proportion to their actual abundance (Table 5.4) suggesting that beetles are a greater part of Blackbird diet in situations such as at Hildersham during the sampling period, where earthworms and molluscs are scarce.

5.3.2 *Habitat specificity of invertebrate taxa:*

The three most abundant worm species all exhibited habitat specificity when considering their spatial abundance across the different landscape elements (*Allolobophora chlorotica* LRT= 19.457, d.f. = 11, P= 0.05336; *Allolobophora rosea* LRT = 58.288, d.f. = 11 P > 0.0001 and *Lumbricus terrestris* LRT = 16.783, d.f. = 8, P = 0.03245). *A. chlorotica* was the numerically dominant earthworm species, recorded across all landscape elements. *A. rosea* showed a significant preference for grassland (+1.1724 ± 0.3530, P > 0.0001), whereas, *L. terrestris* was rarely found in woodland and arable soils and was moderately more abundant in undisturbed margin sites (+ 0.3915 ± 0.1600, P = 0.0144).

Likewise, GLMM models of abundance of mollusc taxa in relation to landscape features showed habitat specificity of the three most abundant slug species (Figure 5.4: Tables 5.7-5.9).

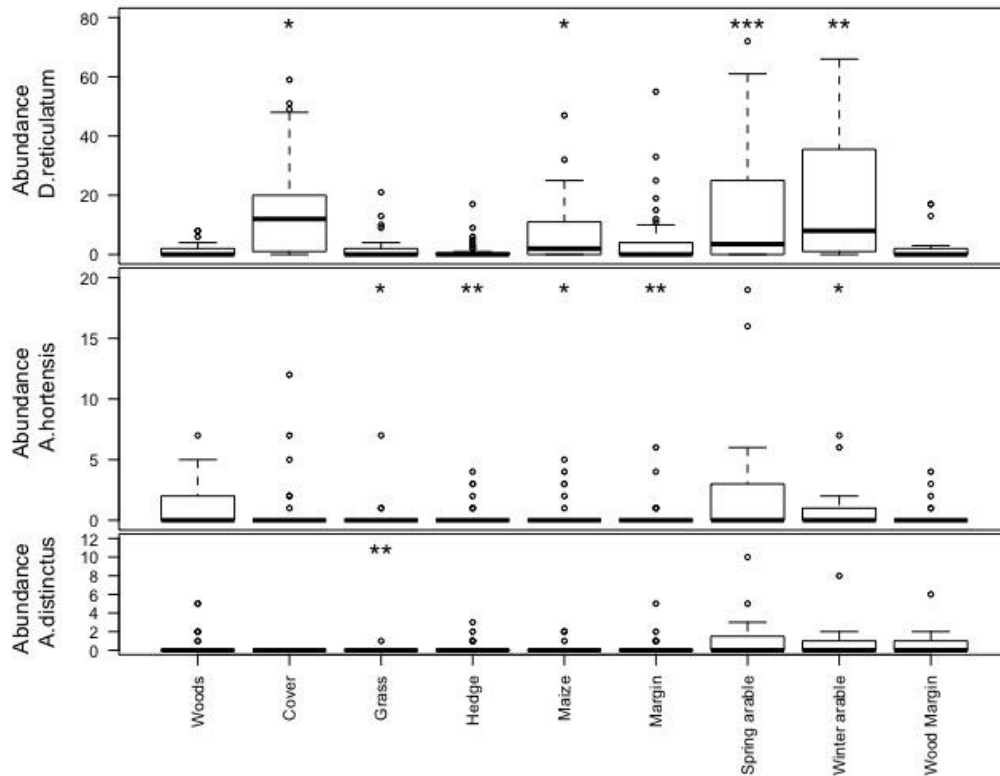

Figure 5.4: Abundances in different landscape elements of the three most abundant slug species at Wenvoe. Significance markers refer to comparisons between each habitat and woods as the reference category.

Table 5.7: GLMM model of abundance of *D.reticulatum* in different landscape features, relative to abundance in woodland (GLMM model; LRT = 81.712, d.f. = 8, $P < 0.0001$).

	Estimate	Std. Error	Z value	Pr(> z)
(Intercept)	0.7957	0.7974	0.998	0.3183
Cover	2.4474	1.0251	2.388	0.0170
Grass	0.1789	0.8775	0.204	0.8385
Hedgerow	-1.1004	0.8052	-1.367	0.1717
Maize	1.6836	0.8354	2.015	0.0439
Margin	0.7439	0.8326	0.893	0.3716
Spring arable	2.8574	0.8578	3.331	0.0009
Winter arable	2.3026	0.8638	2.666	0.0077
Woodland margin	0.4520	0.8374	0.540	0.5894

Table 5.8: GLMM model of abundance of *A. hortensis* in different landscape features, relative to abundance in woodland (GLMM model; LRT = 22.14, d.f = 8, P = 0.004662).

	Estimate	Std. Error	Z value	Pr(> z)
(Intercept)	1.0989	0.2128	5.164	<0.0001
Cover	-0.2187	0.2955	-0.740	0.4593
Grass	-0.6679	0.2966	-2.252	0.0243
Hedgerow	-0.7650	0.2387	-3.205	0.0014
Maize	-0.5529	0.2632	-2.101	0.0356
Margin	-0.6888	0.2506	-2.748	0.0060
Spring arable	0.1466	0.3126	0.469	0.6391
Winter arable	-0.7397	0.3176	-2.329	0.0199
Woodland margin	-0.4520	0.2629	-1.719	0.0856

Table 5.9: GLMM model of abundance of *A. distinctus* in different landscape features, relative to abundance in woodland (GLMM model; LRT = 39.022, d.f = 8, P < 0.0001).

	Estimate	Std. Error	Z value	Pr(> z)
(Intercept)	-1.0504	0.6018	-1.745	0.0809
Cover	-12.4066	362.1967	-0.034	0.9727
Grass	-3.3428	1.2258	-2.727	0.0064
Hedgerow	-1.0902	0.7240	-1.506	0.1321
Maize	-0.3888	0.8108	-0.480	0.6315
Margin	-0.9006	0.7310	-1.232	0.2180
Spring arable	1.2780	0.8649	1.478	0.1395
Winter arable	0.7498	0.7610	0.985	0.3245
Woodland margin	-0.1920	0.7274	-0.264	0.7918

5.3.3 *Multivariate analyses of spatio-temporal variation in thrush diet:*

The model of variation in Blackbird nestling dietary composition at Wenvoe, using the “ManyGLM” method (Table 5.10A, B), revealed significant associations with Julian date (Day), nest identity (Unique nest) and monthly rainfall. The “perMANOVA” method (Table 5.11A, B) identified a slightly different set of associations, namely Julian date (Day), nestling age (Chick.age.zero) and farm-year combination (Site.year).

Table 5.10: ManyGLM analysis of variables associated with variation in nestling Blackbird diet at Wenvoe. A) Starting model, containing all candidate independent variables. B) Final model containing only significant independent variables.

A)				
	d.f.	AIC	LRT	Pr(>Chi)
<none>	-	5618.3	-	-
Day	7	5614.5	10.21	0.1772
Site.year	21	5576.3	0.00	1.0000
Chick.age.zero	7	5614.2	9.87	0.1963
Unique nest	364	5405.3	515.03	<0.0001
Monthly rainfall	7	5618.4	14.06	0.0501
Mean temperature	7	5617.4	13.10	0.0697
Weight	7	5642.3	38.00	<0.0001
B)				
	d.f.	AIC	LRT	Pr(>Chi)
<none>	-	5587.1	-	-
Day	7	5599.1	26.01	0.0005
Unique nest	364	5352.9	493.81	<0.0001
Monthly rainfall	7	5588.1	15.07	0.0351

Table 5.11: PerMANOVA analysis of variables associated with variation in nestling Blackbird diet at Wenvoe. A) Starting model, containing all candidate independent variables. B) Final model containing only significant independent variables.

A)						
	d.f.	Sum of Squares	Mean Squares	F Model	R²	Pr(>F)
Chick.age.zero	1	0.3339	0.3339	2.4314	0.0206	0.029
Day	1	0.2673	0.2673	1.9468	0.0164	0.085
Site.year	3	1.1342	0.3781	2.7532	0.0698	0.001
Unique nest	47	6.5656	0.1397	1.0173	0.4042	0.452
Monthly rainfall	1	0.1580	0.1580	1.1506	0.0097	0.338
Mean temperature	1	0.0939	0.0939	0.6837	0.0058	0.632
Residuals	56	7.6899	0.1373	-	0.4734	-
Total	110	16.2428	-	-	1.0000	-
B)						
	d.f.	Sum of Squares	Mean Squares	F Model	R²	Pr(>F)
Chick.age.zero	1	0.3339	0.3339	2.4165	0.0206	0.046
Day	1	0.2673	0.2673	1.9349	0.0165	0.094
Site.year	3	1.1342	0.3781	2.7563	0.0698	0.001
Residuals	105	14.5074	0.1382	-	0.8932	-
Total	110	16.2428	-	-	1.0000	-

For Song Thrush nestlings at Wenvoe, the “ManyGLM” method (Table 5.12A, B) identified dietary composition to be significantly associated with the same variables as for nestling Blackbirds, namely Julian date (Day), nest identity (Unique.nest) and monthly rainfall. The “Permanova” method (Table 5.13A, B) identified significant associations between nestling diet and nestling age (Chick.age.zero), farm-year combination (Site.year), nest identity (Unique.nest) and monthly rainfall.

Table 5.12: Many GLM analysis of variables associated with variation in nestling Song Thrush diet at Wenvoe. A) Starting model, containing all candidate independent variables. B) Final model containing only significant independent variables.

A)				
	d.f.	AIC	LRT	Pr(>Chi)
<none>	-	3255.4	-	-
Day	7	3252.8	11.35	0.1240
Site.year	21	3211.8	-1.62	1.0000
Chick.age.zero	7	3255.0	13.63	0.0583
Unique nest	217	3190.1	368.68	<0.0001
Monthly rainfall	7	3282.8	41.38	<0.0001
Mean temperature	7	3248.9	7.47	0.3817
Weight	7	3246.4	4.94	0.6668
B)				
	d.f.	AIC	LRT	Pr(>Chi)
<none>	-	3200.7	-	-
Day	7	3202.0	15.36	0.1240
Unique nest	217	3146.7	379.99	<0.0001
Monthly rainfall	7	3225.1	38.42	<0.0001

Table 5.13: PerMANOVA analysis of variables associated with variation in nestling Song Thrush diet at Wenvoe. A) Starting model, containing all candidate independent variables. B) Final model containing only significant independent variables.

A)						
	d.f.	Sum of Squares	Mean Squares	F Model	R²	Pr(>F)
Chick.age.zero	1	0.6797	0.6797	4.8039	0.0474	0.001
Day	1	0.3192	0.3192	2.2559	0.0222	0.057
Site.year	3	1.1415	0.3805	2.6893	0.0795	0.002
Unique nest	27	6.9140	0.2561	1.8099	0.4818	0.001
Monthly rainfall	1	0.3577	0.3577	2.5283	0.0249	0.025
Mean temperature	1	-0.0132	-0.0132	-0.0931	-0.0009	0.999
Residuals	35	4.9520	0.1415	-	0.3510	-
Total	69	14.3508	-	-	1.0000	-

B)

	d.f.	Sum of Squares	Mean Squares	F Model	R ²	Pr(>F)
Chick.age.zero	1	0.6797	0.6797	4.9366	0.0474	0.001
Site.year	3	1.1360	0.3787	2.7504	0.0792	0.006
Unique nest	27	7.0821	0.2623	1.9051	0.4935	0.001
Monthly rainfall	1	0.3588	0.3588	2.6063	0.0250	0.037
Residuals	37	5.0942	0.1377	-	0.3550	-
Total	69	14.3508	-	-	1.0000	-

Nest-level examination of the similarities between nestling diet and the availability of the same prey species in different habitat elements (Figure 5.5, panel a - f), was used to estimate the relative importance of each landscape element in provisioning of food for the nestlings in the focal nest. A set of Blackbird and Song Thrush nests were selected as illustrative case studies of this approach; these were nests where invertebrate sampling had been carried out in each of the major habitat elements within a 200m radius of the nest (the typical foraging distance of thrushes in farmland (Chamberlain *et al.* 1999; Peach *et al.* 2004; Murray 2004).

a) Blackbird Nest: W14_17 (Wenvoe)

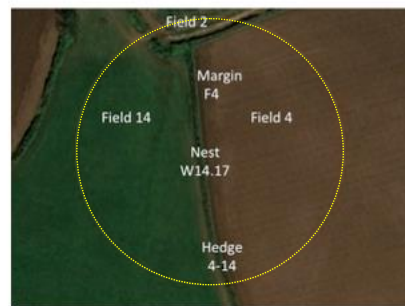

3 visits, chicks < 7 days old

Field 2 = winter wheat

Field 4 = winter wheat

Field 14 = grass

Margin of Field 4

Hedge 4-14

Total hedge length in circle = 265m

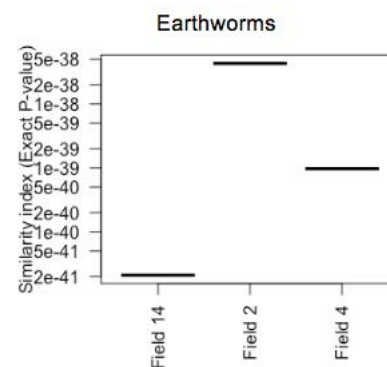
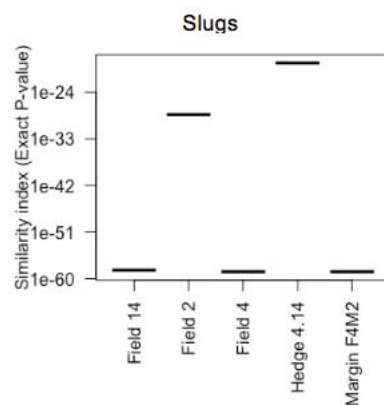

b) Blackbird Nest: W14_2 (Wenvoe)

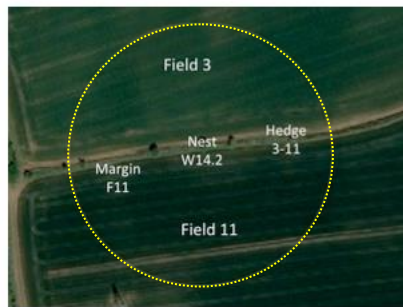

3 visits, chicks < 6 days old

Field 3 = maize

Field 11 = spring barley

Margin of Field 11

Hedge 3-11

Total hedge length in circle = 200m

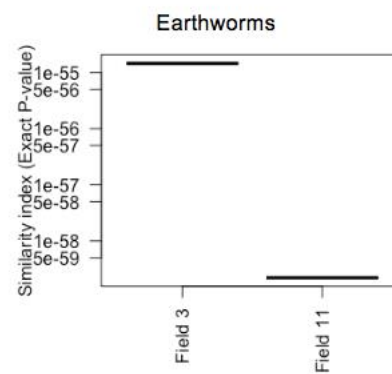
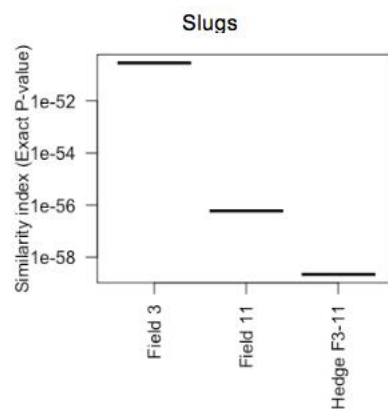

c) Blackbird Nest: W14_21 (Wenvoe)

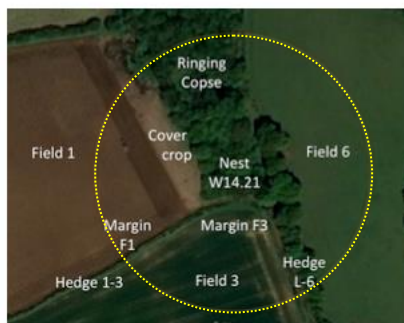

3 visits, chicks < 9 days old

Field 1 = spring barley

Field 3 = maize

Field 6 = grass (only margin was surveyed)

Ringing copse = woodland

Margins F1 F3

Hedges 1-3 & L-6

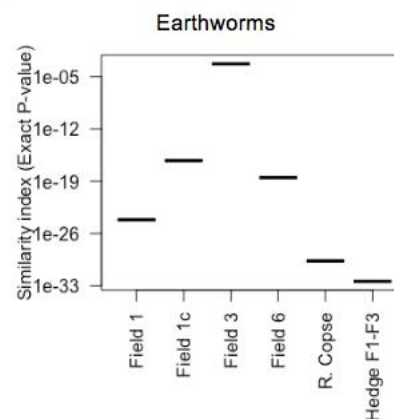
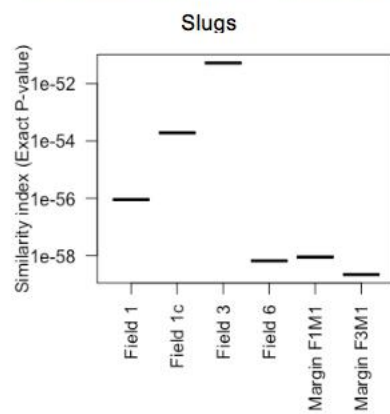

d) Song Thrush Nest: W14_29 (Wenvoe)

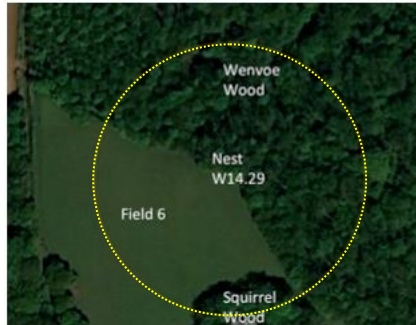

3 visits, chicks < 7 days old

Field 6 – grass

Wenvoe wood WVV

Squirrel wood WSW

Total hedge length in circle – 0m

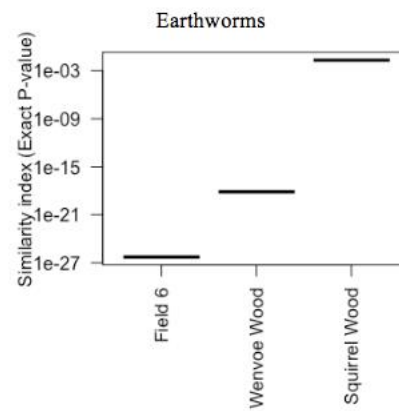
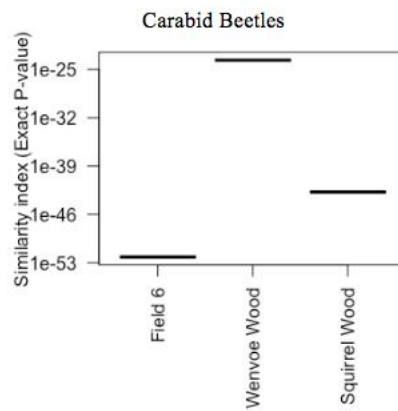

e) Song Thrush Nest: W14_26 (Wenvoe)

5 visits, chicks < 11 days old

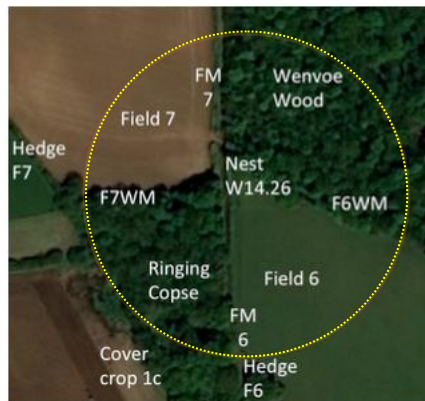

Field 6 – grass

Field 7 – maize

Ringing copse

Wenvoe wood

Cover crop 1b

Field margins F6M1 and F7M1

Wood margins F6WM, F7MW, WMF7-L

Hedgerows HLF6 and HLF7

Total hedge length in circle = 233m

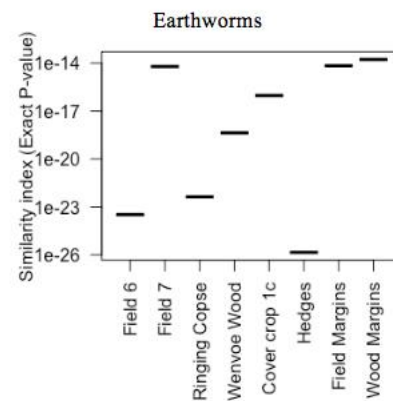
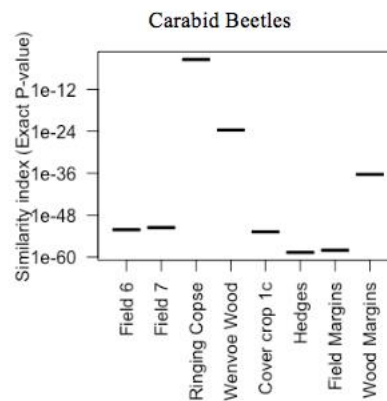

f) Blackbird Nest: C15.4 (Hildersham)

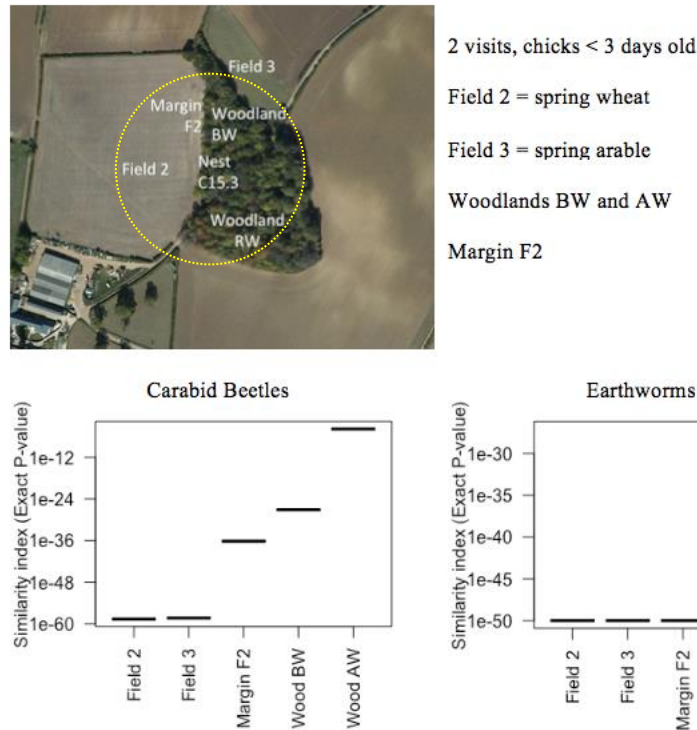

Figure 5.5: Maps of individual Blackbird (a-c, f) and Song Thrush (d,e) nests, at Wenvoe (a-e) and Hildersham (f), together with similarity of the species composition of prey in nestling diet, with the relative abundance of the same species of prey in each landscape feature within 200m of the nest (radius of circle). Similarity between diet and prey availability was quantified using the p-value of Fisher's exact tests (standardised for variations in sample size), comparing nestling dietary composition with the relative availability of the same prey species in each landscape element (see Methods for further details).

The results identified the landscape elements in which the relative abundance of different invertebrate species most closely resembled the relative abundance of invertebrate species in the diet of nestlings in the focal nest. At Blackbird nest W14.17 at Wenvoe, the greatest similarities with nestling diet were found with the earthworm fauna of a nearby winter wheat crop and adjacent hedgerows, and the slug fauna of the winter wheat crop. The nestling diet at this nest was least similar to the fauna of a nearby grass pasture (Figure 5.5, panel a). Nestling diet at Blackbird nest W14.2 at Wenvoe, was most similar to the invertebrate fauna of a nearby maize crop, and (to a lesser extent) a barley crop. The slug component of nestling diet

at this nest was least similar to the slug fauna of a nearby hedgerow (Figure 5.5, panel b). At Blackbird nest W14.21 at Wenvoe, the greatest similarity was with the invertebrate fauna of a nearby maize crop, followed by a spring barley crop and grass pasture. The diet of nestlings in this nest showed notably least similarity with the invertebrate fauna of adjacent woodland or hedgerows (Figure 5.5, panel c).

At Song Thrush nest W14.29 at Wenvoe, the nestling diet most closely resembled the earthworm and Carabid fauna of adjacent woodland, and was less similar to a nearby grass pasture (Figure 5.5, panel 3d). At Song Thrush nest W14.26, Carabid component of the nestling diet most closely resembled the Carabid fauna of nearby woodland and wood-margins, whereas the earthworm component of the nestling diet most strongly resembled the earthworm fauna of a nearby maize crop, wood/field margins, a cover crop, and (to a lesser extent) nearby woodland. The nestling diet at this nest was notably least similar to the earthworm and Carabid fauna of nearby hedgerows (Figure 5.5, panel e).

Only one thrush nest at Hildersham had sufficient dietary and field-invertebrate data for this type of analysis. This was Blackbird nest C15.4, where the invertebrate composition of nestling diet was most similar to the invertebrate fauna of nearby woodland, and (for Carabids but not earthworms) there was some similarity to nearby field margins (Figure 5.5, panel 3f).

5.4 Discussion:

A novel environmental genomics approach was utilised to track habitat use by thrushes exploiting heterogeneous farmland landscapes. The results from dietary preference analyses revealed that thrushes foraged selectively, with some taxa (such as snails, flies and the earthworm *L. terrestris*) being more strongly represented in nestling diet than would be expected from their abundance at the farm scale. Whereas other taxa (such as the earthworms *A. chlorotica* and *A. rosea* and the slug *D. reticulatum*) were less strongly represented than expected. Both *A. chlorotica* and *A. rosea* have a widespread range and low habitat specificity, with a preference for arable land and field margins (Natural England 2014), whereas, *L. terrestris* has high habitat specificity and is moderately abundant across undisturbed grassland sites (Natural England 2014). There were similarities between

Blackbirds and Song Thrushes in the taxa preferentially consumed, as well as similarities between the two farms in this respect. The main exception was the under-representation of Carabid beetles in the diet of thrushes at Wenvoe, where earthworms and molluscs were abundant, whereas Carabids were over-represented in the diet of thrushes at Hildersham, in circumstances (Summer 2015) when earthworms and molluscs were exceedingly scarce due to drought conditions during the sampling period. This unexpected difference in apparent preference for or against Carabids is consistent with density-dependent diet-switching from more-preferred prey taxa (earthworms and molluscs) to less-preferred prey taxa (Carabid beetles), when ecological circumstances prevented preferred prey from being found by foraging thrushes (Peach *et al.* 2004). Gruar *et al.* (2003) considered the diet and body condition of Song Thrushes in stable and declining lowland arable farm populations and found summer diet was dominated by earthworms, snails and beetles.

The dietary composition of thrushes varied spatially and temporally, in relation to independent variables such as year, stage of breeding season, chick age, farm location, and weather. The two types of model, using different underlying computational approaches, each identified sets of independent variables that were associated with variation in the multivariate composition of nestling diet. The independent variables identified by the two methods were not identical, indicating that although there are clearly ecological drivers of the observed variation in nestling diet, it is not clear which of the candidate variables are the primary drivers of that variation. Nevertheless, these models together suggest that temporal (year, Julian date), spatial (farm location) and environmental (weather) variables may each influence diet, at least in specific contexts. Previous research has highlighted how reproductive success is sensitive to variation in precipitation (Chamberlain *et al.* 1999; Paradis *et al.* 2000) and cumulative soil moisture levels (Miller *et al.* 2017). Gruar *et al.* (2003) reported a pronounced seasonal decline in the quality of diet, as Song Thrushes had to shift from earthworms and snails to an increasing proportion of spiders due to the dry weather of late summer. A dietary switch was also reported by Chamberlain *et al.* (1999), as the availability of earthworms was dependent on rainfall on farmland and Blackbirds switched to caterpillars during dry periods. However, unlike previous studies, we were unable to test for more detailed relationships between dietary composition and rainfall during the 7 days prior to faecal sample collection as, since 2011, the Met Office only provide data on monthly rainfall.

As expected, significant variation in nestling diet was recorded between nests. Foraging thrushes were expected to exploit different elements of the landscape to different extents; *a priori* expectations were that woodlands, hedgerows and conservation features, such as cover crops, would be more heavily used than crop and pasture fields. This hypothesis was tested using an index of similarity between nestling diet at individual nests, and the relative abundance of different prey taxa in different elements of the surrounding landscape. To directly address the central tenet of the thesis, that dietary analysis can reveal important information about how farmland thrushes exploit the trophic resources across different parts of the farmed landscape, six individual nests were selected as case studies to illustrate this approach. Each nest chosen had (i) sufficient information about nestling dietary composition, and (ii) sufficient sampling of each of the primary components of nestling diet, within the main landscape features within a 200m radius of the nest (this radius being based on the foraging range of Blackbirds and Song Thrushes observed in previous studies Chamberlain *et al.* 1999; Murray 2004; Peach *et al.* 2004).

The picture that emerges from these case studies, for both Blackbirds and Song Thrushes, is of considerable variation in the similarity of the diet of nestlings and the invertebrate fauna of different landscape elements. This provides evidence of non-random choices of foraging locations of parent thrushes, reflected in the species-composition of the prey provided to nestlings in different parts of the farmland landscape. The variety of apparent foraging choices at the six case-study nests used to illustrate this approach, suggests that there is considerable between-nest variation in which landscape elements are used as primary foraging locations.

At most nests, more than one landscape element appeared to contribute substantially to the nestling diet, indicating a degree of redundancy in the landscape, in terms of where thrushes were able to obtain food for their nestlings. Thus, highlighting the importance of heterogeneity between fields and within fields, particularly for species with a limited foraging range during the nesting period. Important landscape elements for foraging thrushes provisioning individual nests included: natural landscape features such as woodland and wood-margins, artificially created features (hedgerows and crops –particularly maize, winter wheat and spring barley), and features specifically created for their conservation value

(uncultivated field margins, cover crops). The notable exception to this pattern of use of multiple landscape elements was the Blackbird nest at Hildersham, where the nestling diet appeared to be obtained primarily from the woodland elements (and to a lesser extent the field margin) in this otherwise very homogenous arable-farming landscape.

At some nests (e.g. Song Thrush nests W14.26 and W14.29), habitats such as woodland, hedgerows, field/wood margins and cover crops, that were expected *a priori* to be important for foraging thrushes, did indeed appear to contribute substantially to nestling diet. However, at other nests (e.g. Blackbird W14.2) landscape elements that were not expected *a priori* to be important for foraging thrushes appeared to be important. Specifically, maize, winter wheat and (to a lesser extent) spring barley, appeared to provide an important contribution, indicating that commercial crops are not “ecological deserts”, as far as foraging thrushes are concerned.

The overall value of landscape heterogeneity, variety in different cover types and complex spatial patterning of resources, is well recognised (Duelli 1997; Fahrig *et al.* 2011); the provision of a wider range of resources supports a higher diversity and abundance of organisms (Heikkinen *et al.* 2004). Non-cropped boundary features such as hedgerows, ditches and field margins are particularly important for farmland birds (Chapter 2), supporting a rich range of invertebrate prey (Meek *et al.* 2002; Westbury *et al.* 2017). However, previous research has found these buffer strips have had limited benefits for farmland birds during the breeding season (Baker *et al.* 2012). Uniform vegetation structure and/or increased sward density can directly affect the foraging efficiency of thrushes, through physical obstruction and by reducing the detectability and accessibility of key invertebrate prey (Wilson *et al.* 2005; Dunn *et al.* 2010). Crop structure and sward density can impact on the trade-off between time allocated to feeding, vigilance for predators and energy expended travelling between habitats to exploit a particular prey type. Sympathetic management of non-cropped boundary habitats is required to increase the functional and ecological significance of landscape elements for foraging birds (Douglas *et al.* 2009; Vickery *et al.* 2009; Fritch *et al.* 2017). Boundary habitats under varying degrees of management, can further increase heterogeneity and enhance invertebrate food resources within adjacent fields, through

‘positive spill-over’ of invertebrates from source habitats of high invertebrate abundance, into surrounding accessible habitats of lower abundance (Vickery *et al.* 2002; Rand *et al.* 2006).

Overall, this chapter demonstrates the potential for using high-throughput sequencing (HTS) to measure trophic relationships, via habitat-linked food webs, to understand the mechanisms which underlie foraging decisions and habitat use in thrushes. However, there are some limitations to the approach which need to be taken into consideration. Whilst a range of methods were required to capture the diversity of functional guilds of relevance to foraging thrushes, each of these methods has an associated sampling bias. Items were recorded within the diet of farmland thrushes (Chapter 4) that were not sampled during invertebrate surveys (Chapter 2). Furthermore, due to the time needed to collect and process samples, and the depth of knowledge required to accurately identify thousands of specimens a broad-spectrum sampling approach was adopted identifying invertebrates to Order. Species-level identifications were only provided for earthworms, slugs and carabid beetles. In future, identifying invertebrates to the family level will provide additional detail when considering dietary preference analyses.

In comparison to more traditional morphological analyses to determine the diet of thrushes, such as the use of neck ligatures (Murray 2004), and microscopic analysis of faecal samples (Chamberlain *et al.* 1999; Gruar *et al.* 2003), HTS allows the complete dietary breadth of species to be determined. HTS provides information regarding dietary diversity and trophic links at a finer taxonomic resolution, including uncommon prey items and species never previously recorded as they leave no hard-parts in the faeces (Alberdi *et al.* 2018). However, HTS methods can also be limited by problems such as PCR errors, amplification of contaminants and sequence errors. Care needs to be taken during experimental design (Alberi *et al.* 2018), sample preparation (Murray *et al.* 2015), primer selection (Chapter 3) and the bioinformatics process (Clare *et al.* 2016; Richardson *et al.* 2017), to reduce the inherent biological and technical biases.

False positives (detection of taxa that have not been actively selected as live prey) can arise due to scavenging (Juen and Traugott 2005), and secondary predation (when the predator consumes a second predator that has consumed the detected prey species), is also a significant

source of error, depending on the digestion rates of the species involved (Harwood *et al.* 2001; Sheppard *et al.* 2005). Metabarcoding is also unable to differentiate between different tissue types and whether the prey item was at the larval or adult stage. The presence or absence of a prey species within the diet can be reliably determined, but not the biomass consumed or nutritional benefits of a particular species (Deagle *et al.* 2009; Coissac *et al.* 2012; Hibert *et al.* 2013; Elbrecht & Leese 2015). Quantification of PCR-based dietary metabarcoding results is problematic due to differential digestion rates of prey, primer biases and random sampling during sequencing (Murray *et al.* 2011; Leray and Knowlton 2017; Pinol *et al.* 2018). Correction factors can be determined to allow for amplification bias and differing digestion rates (Thomas *et al.* 2016), but these can be laborious to design and may vary prominently between taxa. Even so, the developmental stage of the prey and the DNA density of the consumed tissue are difficult to correct for with DNA data (Murray *et al.* 2011). Large sample sizes can partially overcome the issues surrounding quantification. Dietary items that occur more frequently across the dataset can provide a semi-quantitative measure at the brood/population level. By considering the frequency of occurrence we can determine which species should be considered as important within the diet.

Despite the limitations and biases, high-throughput DNA sequencing-based approaches have two principal advantages over traditional methods: the ability to process and sequence high numbers of samples in parallel and the ability to identify prey down to the taxonomic species level (Alberdi *et al.* 2018a). In the future, shotgun-sequencing approaches which circumvent issues with amplification bias may become more available (Coissac *et al.* 2016; Paula *et al.* 2016; Bista *et al.* 2018). Although, due to the extremely low concentration of target DNA in faecal samples, the costs associated with achieving the sequencing depths necessary to detect ecologically meaningful results, (Alberdi *et al.* 2017), poor reference databases, and low read counts susceptible to false positives (Paula *et al.* 2016), hamper the uptake of this approach.

The novel environmental genomics approach developed and applied in this thesis provides a conceptual and methodological framework for using high through-put sequencing to relate trophic relationships, via habitat-linked food webs, to address major conservation issues. Any application of the method developed generates multivariate data and consideration should be given to the appropriate statistical model required. In this study analysis of spatial

and temporal variation in blackbird and song thrush diet was assessed using both perMANOVA and ManyGLM models, and each method identified slightly different sets of independent variables that were important.

Previous research has assessed multivariate analysis of prey composition using ‘distance-based’ measures such as perMANOVA (e.g. Crisol-Martínez *et al.* 2016; Oehm *et al.* 2017; Waap *et al.* 2017). The analysis involves creating a null condition by randomising the data and determining a measure of similarity by comparing this to the variables with permutations. However, the statistical power of this method is very low, except for variables with high variance. Rare prey items might introduce bias in multivariate analyses and mask important patterns of species composition in multivariate space (Warton *et al.* 2012). One solution to the overestimation of rare species may be to remove prey that were only eaten by a single predator (e.g. Brown *et al.* 2014b) or exclude prey that occurs in less than 5% of the total number of samples (e.g. Waap *et al.* 2017). As rare prey items may be of no biological relevance for studies taking a resource partitioning approach (see Clare 2014). To some degree larger sample sizes may also control for overrepresentation of rare prey. Alternatively, a model-based multivariate approach such as ManyGLM maybe more suitable (e.g. Riccioni *et al.* 2018). This method allows modelling of response variables in a generalised linear model framework, with the option of a negative binomial response distribution, and has been shown to have better power properties than perMANOVA approaches (Warton *et al.* 2011). Both models have different pros and cons. Researchers applying the environmental genomics approach developed and applied in this thesis in the future will need to decide which multivariate method is most suited to the research question to be addressed given the available sample sizes and considered importance of rare prey items.

CHAPTER 6: **General Discussion:**



“I'm stronger because I had to be, I'm smarter because of my mistakes, happier because of the sadness I've known and now wiser because I learned.”

Anon.

Widespread declines in farmland biodiversity and the abundance of wildlife over the last four decades are well documented and are understood to have been driven by changes in agricultural practices and subsequent habitat destruction, fragmentation and degradation at multiple spatial scales (Fuller *et al.* 1995; Benton *et al.* 2003; Burns *et al.* 2013). The reduced availability of key invertebrate resources has been linked to severe farmland bird population declines. In this study, I have utilised high-throughput sequencing to track habitat use by thrushes exploiting two contrasting farmland landscapes. I have assessed the potential mechanisms underlying the relationship between habitat heterogeneity, bird foraging behaviour, and the trophic connections between the birds and different landscape elements (e.g. hedgerows, field margins, crops). A combination of surveys of the distribution and abundance of potential prey, extensive methodological development and testing of suitable primers, and a novel environmental genomics approach, were used to address the ‘gaps in knowledge’ identified in Chapter 1, and to provide an understanding of how farmland thrushes exploit fragmented habitats to find food in both simple and complex farmed landscapes. Common Blackbirds and Song Thrushes are well suited for this study, because many aspects of their biology, behaviour and ecology are well understood. Despite this knowledge, little is known about the mechanisms by which habitat fragmentation affects the foraging ecology and breeding biology of thrushes. The general aims of this thesis were to review and determine the effects of habitat heterogeneity on the nestling provisioning and breeding productivity of Blackbirds and Song Thrushes in two contrasting farmland landscapes. Each chapter builds sequentially on from the last and provides a framework for the steps that practitioners would need to take in order to utilise environmental genomics to track how birds exploit fragmented habitats to find food, namely: (i) invertebrate sampling, (ii) primer selection, and (iii) dietary analyses using high-throughput sequencing, before (iv) combining data on invertebrate availability and dietary composition to (v) track trophic relationships, via habitat-linked food webs. The specific aims were to determine:

- (4) The spatial variation, relative abundance and diversity in invertebrate prey groups across differing landscape elements within farms of differing complexity (Chapter 2).
- (5) Two broad COI primer pairs capable of amplifying all known prey taxa; a short primer pair to maximise diversity and sensitivity, and an extended region to improve taxonomic resolution and quality-check species identity (Chapter 3).

- (6) The full dietary breadth of farmland thrushes, using comprehensive molecular methods (Chapter 4).
- (7) How diet composition influences nestling growth and condition (Chapter 4)
- (8) The mechanisms behind foraging habitat selection by farmland thrushes and whether dietary composition reflects invertebrate abundance and diversity (Chapter 5).

In Chapter 2, invertebrate food availability was quantified extensively across the two farms of differing complexity, using a suite of different sampling methods to capture the necessary diversity followed by identification of potential prey taxa to Order level. The results provided a comprehensive measure of the distribution, relative abundance and diversity of invertebrates across a landscape. The great variation in invertebrate abundance, species composition, and diversity between different landscape elements, provides empirical support for the concept of an effect of increasing heterogeneity on invertebrate abundance and diversity at the whole-farm scale. Such knowledge of invertebrate availability across a landscape is essential to understand how and why diet composition varies spatially and temporally, and the consequences of such dietary variation for nestling growth and breeding productivity. This work builds upon similar studies determining the availability of plant and invertebrate resources for farmland birds (Holland *et al.* 2006; Holland *et al.* 2011). There are several studies considering the abundance of invertebrates across farmland, and most previous research on the influence of farmland heterogeneity on invertebrates has focused on individual Orders or Families. In contrast the present study has quantified how the distribution of invertebrates of multiple Orders and numerous species varies across different landscape elements. Developing an understanding of the invertebrate food resources provided by arable crops and non-cropped boundary habitats is essential, if we hope to address the current declines in farmland birds through more sustainable management of agro-ecosystems, including the provision of invertebrate-rich landscape features through agri-environment schemes.

In Chapter 3, an extensive evaluation of all known universal cytochrome oxidase (COI) primers within the Folmer barcoding region were evaluated *in silico*, against a database of

complete mitochondrial genomes, using ecoPCR. The success and accuracy of dietary studies using metabarcoding are contingent on careful selection of primers suitable for screening faecal samples and detecting invertebrate taxa within the diet of thrushes. In total, 19 forward and 22 reverse primers were considered and verified in 118 different combinations, which amplify a fragment of between 100 and 350 base pairs. Further empirical testing *in vitro* was conducted for 21 primer combinations. Two broad spectrum COI primer pairs suitable for dietary analysis capable of amplifying not only Insects, but also Annelida, Gastropoda Mollusca and Arachnida were selected. These comprised a short primer pair (jgLCO1490/EPT-long-uniRed) to maximise diversity and sensitivity, and an extended region (mICOIintF/CI-N-2191(Nancy)) to improve taxonomic resolution and to quality-check species identity.

In Chapter 4, the universal COI primers (developed in Chapter 3), were used to screen faecal samples collected from adults and nestling thrushes and determine the full dietary breadth of thrushes in farmland habitats of differing complexity. A total of 338 taxonomic units were identified from faecal samples, of which 76% were identified to species, 21% to genus, and the remaining 3% to family. Adult thrushes were generally consistent between years in what they fed their nestlings, with considerable overlap between the diet of Blackbird and Song Thrush nestlings each year. Food availability during the breeding season is a fundamental determinant of fitness for altricial nestlings, as the period of growth and development can have long term implications for condition, post-fledging survival and lifetime breeding success (Metcalf and Monaghan 2001). Nestlings showed evidence of compensatory growth between 5 and 8 days of age, and Blackbird nestlings in nests within the relatively simplified landscape at Hildersham failed to reach the threshold body mass of 55g, previously described as the minimum 8-day nestling mass required for survival to independence. Nestling diet changed with age, with both Blackbirds and Song Thrushes feeding a higher proportion of earthworms to older chicks. In addition, a higher proportion of earthworms within age-specific Blackbird nestling diet was positively associated with nestling body condition; no other prey taxa were significantly associated with nestling condition. Overall, these results highlight the broad dietary range of both species, the inter-specific, intra-specific and age-related variation in nestling diet, and the consequences of dietary composition for nestling growth and survival.

In Chapter 5, comparisons of the relative abundance of different prey taxa in farmland habitats (Chapter 2), with the occurrence of prey in the diet of Blackbirds and Song Thrushes (Chapter 4), indicated strong preferences for or against particular prey taxa available in the landscape. The selection by thrushes of prey taxa that are habitat specialists allowed the use of different parts of the farm landscape by foraging thrushes to be deduced. Diptera were over-represented in the diet of both species, but in contrast to Wenvoe, Blackbirds in the relatively simplified landscape of Hildersham had more Coleoptera in their diet than expected, suggesting that beetles are a greater part of Blackbird diet in situations such as at Hildersham during the sampling period, where earthworms and molluscs are scarce. These results together show that a fine-scale mosaic of agricultural elements provides birds with redundancy in terms of the abundance and diversity of suitable prey items to exploit. Greater management of non-boundary habitats (such as beetle banks within commercial crops), and agri-environment options (such as cover crops and fallow field margins), may be necessary to increase the diversity and heterogeneity of landscape elements, and hence to improve the availability of key invertebrate resources for foraging birds.

Overall, this novel study provides a model for using high-throughput sequencing to measure trophic relationships, via habitat-linked food webs, to understand the mechanisms which underlie foraging decisions and habitat use in thrushes and the consequences for breeding productivity, nestling growth and condition.

6.1 Considerations:

Although this study presents robust findings based on original research, several shortfalls and weaknesses have been identified:

- (1) Sample sizes of nestling diet data within the relatively simplified landscape of Hildersham were small, due to high levels of nest predation. Adults birds that need to travel further distances in order to forage will ultimately leave their nests exposed for longer, in landscapes such as Hildersham where suitable foraging locations are sparsely distributed across the landscape.

- (2) Any consistent differences in the diet of parent and nestling thrushes were not determined, as sample sizes of adult dietary data were small, and it was not possible to link samples from adult birds with samples from nestlings in specific nests.
- (3) Thrushes are multi-brooded; however, we were unable to trace multiple broods for each breeding pair through the season, due to the difficulties of locating nests, and dynamic territory boundaries of thrushes breeding in the more complex landscape at Wenvoe.

6.2 Environmental change:

Agricultural management and climate change are the major drivers of biodiversity change in the UK (Perrings *et al.* 2006; Burns *et al.* 2016). Farmland is the dominant habitat across the UK and must be carefully managed to meet the food security needs of an ever-expanding global population, concomitant industrial and political demands and conservation efforts to protect biological diversity.

Climate change has the potential to significantly influence food availability, via impacts on invertebrate abundance and distributions. There is increasing evidence that species reliant on soil-dwelling invertebrates such as the Blackbird and Song Thrush may be sensitive to drought, with low rainfall reducing prey numbers directly, or limiting accessibility by initiating movement of annelids and arthropods deeper into the substrate, and/or reducing the ability of birds to probe for food (Pearce-Higgins 2010).

The recent decision of the UK to pursue Brexit and leave the European Union (EU) represents a highly significant moment in agricultural and rural policy, triggering great uncertainty regarding the future of the EU-funded Countryside Stewardship scheme and environmental incentives for UK farmers beyond 2020 (Whitfield and Marshall 2017). The potential ramifications for nature conservation are considerable. However, Brexit could bring about opportunities for re-designing agri-environment schemes to make funding more effective at creating conservation benefits, through evidence-based measures underpinned by a programme of monitoring and evaluation. The detailed understanding provided by this study,

of the mechanisms behind how birds exploit fragmented farmland for food could be used by conservation research organisations, such as the British Trust for Ornithology as part of this evidence-base, to provide detailed guidance to governmental and NGO bodies, particularly with respect to criteria for future farmer subsidies aimed at enhancing biodiversity.

6.3 Implications for findings at a local/regional and national scale:

This thesis has identified a need for a fine-scale mosaic of agricultural elements which provides birds with redundancy, in terms of the abundance and diversity of suitable prey items to exploit. Management of agro-ecosystems should consider the spatial arrangement of uncropped foraging habitat, together with the provision of preferred nesting habitat (hedgerows and woodland in the case of Blackbirds and Song Thrushes). Consideration of farm-scale provision of such landscape elements is important to prevent an ecological trap from developing, whereby preferred nesting habitat does not provide sufficient food for rearing nestlings, resulting in lower parental provisioning rates, nesting growth rates and fledging success, creating a population sink (Dunn *et al.* 2015). Habitat heterogeneity has been shown to have positive effects on the growth and condition of nestlings at a local scale. However, this seldom translates into population increases at a national level (Davey *et al.* 2010a; Davey *et al.* 2010b; Baker *et al.* 2010). Whilst knowledge of the foraging decisions and habitat use of birds for provisioning the nest is important, greater consideration needs to be given to the area and distribution of these habitats across a landscape-scale (Henderson *et al.* 2012). The redeveloped agri-environment scheme, Countryside Stewardship, aims to focus on quality rather than quantity of habitat, and to address widespread environmental issues by encouraging applicants to choose work-packages that help deliver landscape scale biodiversity benefits, by means of groups of specific management options that should benefit wild pollinators, farmland birds and other wildlife (DEFRA, 2014a).

6.4 Future directions:

In order to achieve the focused aims of this thesis, a wide range of potentially important aspects of farmland, invertebrate and bird ecology are ignored. For example, work should be expanded to determine the diet of thrushes across the annual cycle, including over winter

when invertebrate prey is relatively scarce, and to consider the trophic connections and environmental causes of reduced survival of fledged birds in the immediate post-fledging period and over the first winter. Without taking these issues into account, the true future for these birds cannot be reflected with confidence. However, the approach developed and applied in this thesis provides a conceptual and methodological framework for such future work and provides a clearer focus on a set of key research questions to be addressed.

Conservation-focused research based on this model is currently being expanded to consider the dietary needs of Turtle Doves *Streptopelia turtur* within farmland (Dunn *et al.* 2018), and the use of molecular tools to test the effectiveness of bespoke habitat agri-environment options, aimed to provide a continuous source of seed food for breeding turtle doves (Dunn *et al.* in prep). Further application of this research could be applied across temperate zones to further understanding of optimal foraging, habitat selection, and foraging behaviour of animals in a diversity of ecosystems.

6.5 Does it matter? The consequences of the research for the discipline:

By combining the study of invertebrate prey populations with the dietary preferences and foraging ecology of farmland thrushes, this thesis has presented an integrated approach to understand the mechanisms behind foraging ecology and the trophic connections between the birds and different landscape elements. To do this, I have developed and applied a novel environmental genomics approach to build on the vast body of previous research undertaken into farmland birds. Specifically, this study:

- (1) Provides strong support for the importance of optimal prey choice for foraging thrushes, and reveals strong preferences for or against prey taxa available in the landscape as a whole.
- (2) Confirms the impact of dietary composition on the growth and condition of nestlings.
- (3) Details variation in diet and nestling growth related to spatial, temporal and environmental factors.

(4) Reveals the selective exploitation of different landscape elements by foraging thrushes.

(5) Provides support for the provision of a fine-scale mosaic of agricultural elements to provide birds with redundancy, in terms of diversity of suitable prey items to exploit.

These findings provide an important step towards understanding the mechanisms which underlie foraging decisions and habitat use in Blackbirds and Song Thrush, and the consequences for breeding productivity, nestling growth and condition. Methods developed within this thesis are novel and provide a model for using high through-put sequencing to relate trophic relationships, via habitat-linked food webs, to address major conservation issues.

References:

- Aebischer, N. J. (1990). Assessing pesticide effects on non-target invertebrates using long-term monitoring and time-series modelling. *Functional Ecology* **4**: 369-373.
- Aebischer, N. J. (1991). Twenty years of monitoring invertebrates and weeds in cereal fields in Sussex. *The Ecology of Temperate Cereal Fields* 305-330.
- Aebischer, N., Brockless, M. and Graham, N. (2005). *Grey partridge recovery project*. Game Conservance Trust Review of 2005 **27**: 38-89
- Alberdi, A., Aizpurua, O., Bohmann, K., Gopalakrishnan, S., Lynggaard, C., Nielsen, M., Gilbert, M.T.P. (2018a). Promises and pitfalls of using high-throughput sequencing for diet analysis. *Molecular Ecology Resources*. e12960
- Alberdi, A., Aizpurua, O., Gilbert, M. T. P., Bohmann, K. and Mahon, A. (2018b). Scrutinizing key steps for reliable metabarcoding of environmental samples. *Methods in Ecology and Evolution* **9**: 134-147.
- Aligier, A., and Aviron, S., (2017). Time-lagged response of carabid species richness and composition to past management practices and landscape context of semi-natural field margins. *Journal of Environmental Management* **204**: 282-292.
- Altieri, M. A. (1999). The ecological role of biodiversity in agroecosystems. In *Invertebrate Biodiversity as Bioindicators of Sustainable Landscapes*:19-31.
- Alonso, H., Granadeiro, J. P., Waap, S., Xavier, J., Symondson, W. O., Ramos, J. A. and Catry, P. (2014). An holistic ecological analysis of the diet of Cory's shearwaters using prey morphological characters and DNA barcoding. *Molecular Ecology* **23**: 3719-3733.
- Altschul, S. F., Madden, T. L., Schäffer, A. A., Zhang, J., Zhang, Z., Miller, W. and Lipman, D. J. (1997). Gapped BLAST and PSI-BLAST: a new generation of protein database search programs. *Nucleic Acids Research* **25**: 3389-3402.
- Anderson, G. Q. A., Gruar, D. J., Wilkinson, N. I. and Field, R. H. (2002). Tree sparrow *Passer montanus* chick diet and productivity in an expanding colony. *Aspects of Applied Biology* **67**: 35-42.
- Arlettaz, R., Schaad, M., Reichlin, T. S. and Schaub, M. (2010). Impact of weather and climate variation on Hoopoe reproductive ecology and population growth. *Journal of Ornithology* **151**: 889-899.
- Arnot, D. E., Roper, C. and Bayoumi, R. A. L. (1993). Digital codes from hypervariable tandemly repeated DNA sequences in the *Plasmodium falciparum* circumsporozoite gene can genetically barcode isolates. *Molecular and Biochemical Parasitology* **61**: 15-24.
- Atkinson, P. W., Fuller, R. J., Vickery, J. A., Conway, G. J., Tallowin, J. R. B., Smith, R. E. N., Haysom, K. A. *et al.* (2005). Influence of agricultural management, sward structure and food resources on grassland field use by birds in lowland England. *Journal of Applied Ecology* **42**: 932-942.

- Aviron, S., Burel, F., Baudry, J. and Schermann, N. (2005). Carabid assemblages in agricultural landscapes: impacts of habitat features, landscape context at different spatial scales and farming intensity. *Agriculture, Ecosystems and Environment* **108**: 205–217.
- Baillie, S. R., Gregory, R. D. and Siriwardena, G. M. (1997). Farmland bird declines: Patterns, processes and prospects. *Biodiversity and Conservation in Agriculture* **69**: 65-87.
- Baillie, S. R., Crick, H. Q. P., Balmer, D. E., Bashford, R. I., Beaven, L. P., Freeman, S. N., Marchant, J. H. *et al.* (2001). *Breeding Birds in the Wider Countryside: Their Conservation Status 2000*. British Trust for Ornithology, Thetford, UK.
- Baillie, S. R., Marchant, J. H., Leech, D. I., Massimo, D., Eglington, S. M., Johnston, A., Noble, D. G. *et al.* (2013). *BirdTrends 2012: trends in numbers, breeding success and survival for UK breeding birds*. BTO Research Report No. 644.
- Baker, D. J., Freeman, S. N., Grice, P. V. and Siriwardena, G. M. (2012). Landscape scale responses of birds to agri-environment management: a test of the English Environmental Stewardship scheme. *Journal of Applied Ecology* **49**: 871-882.
- Baldi, A. and Batáry, P. (2011). Spatial heterogeneity and farmland birds: different perspectives in Western and Eastern Europe. *Ibis* **153**: 875-876.
- Ball, M. C., Pither, R., Manseau, M., Clark, J., Petersen, S. D., Kingston, S., Morrill, N. *et al.* (2006). Characterization of target nuclear DNA from faeces reduces technical issues associated with the assumptions of low-quality and quantity template. *Conservation Genetics* **8**: 577-586.
- Barnett, P. R., Whittingham, M. J., Bradbury, R. B. and Wilson, J. D. (2004). Use of unimproved and improved lowland grassland by wintering birds in the UK. *Agriculture, Ecosystems and Environment* **102**: 49-60.
- Batáry, P., Fischer, J., Baldi, A., Crist, T. O. and Tschardtke, T. (2011). Does habitat heterogeneity increase farmland biodiversity? *Frontiers in Ecology and the Environment* **9**: 152-153.
- Bates, D., Maechler, M., Bolker, B. and Walker, S. (2013). lme4: Linear mixed-effects models using Eigen and R syntax. R Package version 1.0-5. <https://cran.r-project.org/web/packages/lme4/index.html>
- Baudry, J. and Bunce, B. (1991). Ecological consequences of land use changes: questions for research. *Opt Méditerranée* **A-15**: 141-143.
- Bearhop, S., Furness, R. W., Hilton, G. M., Votier, S. C. and Waldron, S. (2003). A forensic approach to understanding diet and habitat use from stable isotope analysis of (avian) claw material. *Functional Ecology* **17**: 270-275.
- Bellemain, E., Carlsen, T., Brochmann, C., Coissac, E., Taberlet, P. and Kausarud, H. (2010). ITS as an environmental DNA barcode for fungi: an *in silico* approach reveals potential PCR biases. *BMC Microbiology* **10**: 189-198.
- Bely, A. E. and Wray, G. A. (2004). Molecular phylogeny of nauidid worms (Annelida: Clitellata) based on cytochrome oxidase I. *Molecular Phylogenetics and Evolution* **30**: 50-63.

- Benton, T. G., Bryant, D. M., Cole, L. and Crick, H. Q. (2002). Linking agricultural practice to insect and bird populations: a historical study over three decades. *Journal of Applied Ecology* **39**: 673-687.
- Benton, T. G., Vickery, J. A. and Wilson, J. D. (2003). Farmland biodiversity: is habitat heterogeneity the key? *Trends in Ecology and Evolution* **18**: 182-188.
- Berg, Å. (2008). Habitat selection and reproductive success of Ortolan Buntings *Emberiza hortulana* on farmland in central Sweden—the importance of habitat heterogeneity. *Ibis* **150**: 565-573.
- Bertrand, C., Burel, F. and Baudry, J. (2016). Spatial and temporal heterogeneity of the crop mosaic influences carabid beetles in agricultural landscapes. *Landscape Ecology* **31**: 451-466.
- Bethke, R. W. and Nudds, T. D. (1995). Effects of climate change and land use on duck abundance in Canadian prairie-parklands. *Ecological Applications* **5**: 588-600.
- Biaggini, M., Consorti, R., Dapporto, L., Dellacasa, M., Paggetti, E. and Corti, C. (2007). The taxonomic level order as a possible tool for rapid assessment of Arthropod diversity in agricultural landscapes. *Agriculture, Ecosystems and Environment* **122**: 183-191.
- Billeter, R., Liira, J., Bailey, D., Bugter, R., Arens, P., Augenstein, I. et al. (2008). Indicators for biodiversity in agricultural landscapes: a pan-European study. *Journal of Applied Ecology* **45**: 141-150.
- Birkhead, T. R. (1977). Adaptive significance of the nestling period of guillemots *Uria aalge*. *Ibis* **119**: 544-549.
- Bista, I., Carvalho, G.R., Tang, M., Walsh, K., Zhou, X., Hajibabaei, M., Shokralla, S., et al. (2018). Performance of amplicon and shotgun sequencing for accurate biomass estimation in invertebrate community samples. *Molecular Ecology Resources* **18**(5): 1020-1034
- Blake, S., Foster, G.N., Eyre, M.D. and Luff, M.L. (1994). Effects of habitat type and grassland management practices on the body size and distribution of carabid beetles. *Pedobiologia* **38**: 502-512.
- Blake, R.J., Woodcock, B.A., Westbury, D.B., Sutton, P. and Potts, S.G. (2013) Novel management to enhance spider biodiversity in existing grass buffer strips. *Agricultural and Forest Entomology* **15**: 77-85
- Boatman, N. D., Brickle, N. W., Hart, J. D., Milsom, T. P., Morris, A. J., Murray, A. W., Murray, K. A. et al. (2004). Evidence for the indirect effects of pesticides on farmland birds. *Ibis* **146**: 131-143.
- Boatman, N. D., Parry, H. R., Bishop, J. D. and Cuthbertson, A. G. (2007). Impacts of agricultural change on farmland biodiversity in the UK. *Biodiversity under threat*: 1-32
- Bolger, A. M., Lohse, M. and Usadel, B. (2014). Trimmomatic: a flexible trimmer for Illumina sequence data. *Bioinformatics* **30**: 2114-2120.
- Bouwhuis, S., Vedder, O., Garroway, C. J. and Sheldon, B. C. (2015). Ecological causes of multilevel covariance between size and first-year survival in a wild bird population. *Journal of Animal Ecology* **84**: 208-218.

- Bowers, E. K., Nietz, D., Thompson, C. F. and Sakaluk, S. K. (2014). Parental provisioning in house wrens: effects of varying brood size and consequences for offspring. *Behavioral Ecology* **25**: 1485-1493.
- Boyer, S., Wratten, S. D., Holyoake, A., Abdelkrim, J. and Cruickshank, R. H. (2013). Using next-generation sequencing to analyse the diet of a highly endangered land snail (*Powelliphanta augusta*) feeding on endemic earthworms. *PLoS One* **8**: e75962.
- Brandon-Mong, G. J., Gan, H. M., Sing, K. W., Lee, P. S., Lim, P. E. and Wilson, J. J. (2015). DNA metabarcoding of insects and allies: an evaluation of primers and pipelines. *Bulletin of Entomological Research* **105**: 717-727.
- Brickle, N. W., Harper, D. G., Aebischer, N. J. and Cockayne, S. H. (2000). Effects of agricultural intensification on the breeding success of corn buntings *Miliaria calandra*. *Journal of Applied Ecology* **37**: 742-755.
- Briga, M., Koetsier, E., Boonekamp, J. J., Jimeno, B. and Verhulst, S. (2017). Food availability affects adult survival trajectories depending on early developmental conditions. *Proceedings of the Royal Society B* **284**: 20162287.
- Bright, J. A., Morris, A. J., Field, R. H., Cooke, A. I., Grice, P. V., Walker, L. K., Fern, J. *et al.* (2015). Higher-tier agri-environment scheme enhances breeding densities of some priority farmland birds in England. *Agriculture, Ecosystems and Environment* **203**: 69-79.
- Briones, M. J. I. and Schmidt, O. (2017). Conventional tillage decreases the abundance and biomass of earthworms and alters their community structure in a global meta-analysis. *Global Change Biology* **23**: 4396-4419.
- Brown, D. S. (2010). *Molecular analysis of the trophic interactions of British reptiles*. PhD thesis, Cardiff University.
- Brown, D. S., Jarman, S. N. and Symondson, W. O. (2012). Pyrosequencing of prey DNA in reptile faeces: analysis of earthworm consumption by slow worms. *Molecular Ecology Resources* **12**: 259-266.
- Brown, D. S., Symondson, W. O. C., Burger, R., Cole, N., Vencatasamy, D., Clare, E. L., and Montaxam, A., (2014b). Dietary competition between the alien Asian Musk Shrew (*Suncus murinus*) and a reintroduced population of Telfair's Skink (*Leiolopisma telfairii*). *Molecular Ecology* **23**:3695–370
- Brown, D. S., Ebenezer, K. L. and Symondson, W. O. (2014). Molecular analysis of the diets of snakes: changes in prey exploitation during development of the rare smooth snake *Coronella austriaca*. *Molecular Ecology* **23**: 3734-3743.
- Brown, E. A., Chain, F. J., Crease, T. J., MacIsaac, H. J. and Cristescu, M. E. (2015). Divergence thresholds and divergent biodiversity estimates: can metabarcoding reliably describe zooplankton communities? *Ecology and Evolution* **5**: 2234-2251.
- Brown, G. R. and Matthews, I. M. (2016). A review of extensive variation in the design of pitfall traps and a proposal for a standard pitfall trap design for monitoring ground-active arthropod biodiversity. *Ecology and Evolution* **6**: 3953-3964.

- Brzęk, P. and Konarzewski, M. (2001). Effect of food shortage on the physiology and competitive abilities of sand martin (*Riparia riparia*) nestlings. *Journal of Experimental Biology* **204**: 3065-3074.
- Burns, F., Eaton, M. A., Gregory, R. D., Al Fulaij, N., August, T. A., Biggs, J., Bladwell, S. *et al.* (2013). *State of Nature report*. The State of Nature Partnership.
- Burns, F., Eaton, M. A., Barlow, K. E., Beckmann, B. C., Brereton, T., Brooks, D. R., Brown, P. M. J. *et al.* (2016). Agricultural management and climatic change are the major drivers of biodiversity change in the UK. *PLoS One* **11**: e0151595.
- Butler, S. J., Vickery, J. A. and Norris, K. (2007). Farmland biodiversity and the footprint of agriculture. *Science* **315**: 381-384.
- Butler, S.J., Whittingham, M.J., Quinn, J.L. and Cresswell, W. (2005) Quantifying the interaction between food density and habitat structure in determining patch selection. *Animal Behaviour* **69**: 337–343.
- Cameron, R. A. D., Jackson, N. and Eversham, B. (1986). *A field guide to the slugs of the British Isles*. Field Studies Council, Taunton.
- Campbell, L. H., Avery, M. I., Donald, P., Evans, A. D., Green, R. E. and Wilson, J. D. (1997). *A review of the indirect effects of pesticides on birds*. JNCC Report 227. Joint Nature Conservation Committee, Peterborough.
- Carne-Cavagnaro, V. L., Keller, M. A. and Baker, G. H. (2006). Soil moisture and soil type influence the breeding behavior of the pest snail *Ceratomyxa virgata* (da Costa). *Applied Soil Ecology* **33**: 235-242.
- Carson, R. (2002). *Silent spring*. Houghton Mifflin Harcourt.
- Chamberlain, D. E., Hatchwell, B. J. and Perrins, C. M. (1999a). Importance of feeding ecology to the reproductive success of Blackbirds *Turdus merula* nesting in rural habitats. *Ibis* **141**: 415-427.
- Chamberlain, D. E., Wilson, A. M., Browne, S. J. and Vickery, J. A. (1999b). Effects of habitat type and management on the abundance of skylarks in the breeding season. *Journal of Applied Ecology* **36**: 856-870.
- Chamberlain, D. E. and Fuller, R. J. (2000). Local extinctions and changes in species richness of lowland farmland birds in England and Wales in relation to recent changes in agricultural land-use. *Agriculture, Ecosystems and Environment* **78**: 1-17.
- Chamberlain, D. E. and Fuller, R. J. (2001). Contrasting patterns of change in the distribution and abundance of farmland birds in relation to farming system in lowland Britain. *Global Ecology and Biogeography* **10**: 399-409.
- Chiaradia, A., Costalunga, A. and Kerry, K. (2003). The diet of little penguins (*Eudyptula minor*) at Phillip Island, Victoria, in the absence of a major prey—Pilchard (*Sardinops sagax*). *Emu-Austral Ornithology* **103**: 43-48.
- Chiron, F., Chargé, R., Julliard, R., Jiguet, F. and Muratet, A. (2014). Pesticide doses, landscape structure and their relative effects on farmland birds. *Agriculture, Ecosystems and Environment* **185**: 153-160.

- Clare, E. L. (2014). Molecular detection of trophic interactions: emerging trends, distinct advantages, significant considerations and conservation applications. *Evolutionary Applications* **7**: 1144-1157.
- Clare, E. L., Fraser, E. E., Braid, H. E., Fenton, M. B. and Hebert, P. D. (2009). Species on the menu of a generalist predator, the eastern red bat (*Lasiurus borealis*): using a molecular approach to detect arthropod prey. *Molecular Ecology* **18**: 2532-2542.
- Clare, E. L., Barber, B. R., Sweeney, B. W., Hebert, P. D. and Fenton, M. B. (2011). Eating local: influences of habitat on the diet of little brown bats (*Myotis lucifugus*). *Molecular Ecology* **20**: 1772-1780.
- Clare, E. L., Chain, F. J., Littlefair, J. E. and Cristescu, M. E. (2016). The effects of parameter choice on defining molecular operational taxonomic units and resulting ecological analyses of metabarcoding data. *Genome* **59**: 981-990.
- Clarke, L. J., Soubrier, J., Weyrich, L. S. and Cooper, A. (2014). Environmental metabarcodes for insects: in silico PCR reveals potential for taxonomic bias. *Molecular Ecology Resources* **14**: 1160-1170.
- Clarke, L. J., Beard, J. M., Swadling, K. M. and Deagle, B. E. (2017). Effect of marker choice and thermal cycling protocol on zooplankton DNA metabarcoding studies. *Ecology and Evolution* **7**: 873-883.
- Coissac, E., Hollingsworth, P.M., Lavergne, S. and Taberlet, P. (2016). From barcodes to genomes: extending the concept of DNA barcoding. *Molecular Ecology* **25**: 1423–1428.
- Corse, E., Meglecz, E., Archambaud, G., Ardisson, M., Martin, J. F., Tougard, C., Chappaz, R. *et al.* (2017). A from-benchtop-to-desktop workflow for validating HTS data and for taxonomic identification in diet metabarcoding studies. *Molecular Ecology Resources* **17**: e146-e159
- Cramp, S., 1988. *Handbook of the Birds of Europe the Middle East and North Africa. The Birds of the Western Palearctic*, vol. V. Oxford University Press, Oxford, UK
- Creer, S., Fonseca, V. G., Porazinska, D. L., Giblin-Davis, R. M., Sung, W., Power, D. M., Packer, M. *et al.* (2010). Ultrasequencing of the meiofaunal biosphere: practice, pitfalls and promises. *Molecular Ecology* **19** (1): 4-20.
- Crisol-Martínez, E., Moreno-Moyano, L.T., Wormington, K.R., Brown, P.H., Stanley, D., (2016) Using next-generation sequencing to contrast the diet and explore pest-reduction services of sympatric bird species in Macadamia orchards in Australia. *PLoS ONE* **11**(3): e0150159
- Cristescu, M. E. (2014). From barcoding single individuals to metabarcoding biological communities: towards an integrative approach to the study of global biodiversity. *Trends in Ecology and Evolution* **29**: 566-571.
- Croxall, J. P., Prince, P. A., Baird, A. and Ward, P. (1985). The diet of the southern rockhopper penguin *Eudyptes chrysocome chrysocome* at Beauchene Island, Falkland Islands. *Journal of Zoology* **206**: 485-496.

- Dallas, J. F., Cruickshank, R. H., Linton, Y. M., Nolan, D. V., Patakakis, M., Braverman, Y., Capela, R. *et al.* (2003). Phylogenetic status and matrilineal structure of the biting midge, *Culicoides imicola*, in Portugal, Rhodes and Israel. *Medical and Veterinary Entomology* **17**: 379-387.
- Davey, C. M., Vickery, J. A., Boatman, N. D., Chamberlain, D. E. and Siriwardena, G. M. (2010). Entry Level Stewardship may enhance bird numbers in boundary habitats. *Bird Study* **57**: 415-420.
- Davey, C. M., Vickery, J. A., Boatman, N. D., Chamberlain, D. E., Parry, H. R. & Siriwardena, G. M. (2010a) Assessing the impact of Entry Level Stewardship on lowland farmland birds in England. *Ibis* **152**: 459-474.
- Davey, C. M., Vickery, J. A., Boatman, N. D., Chamberlain, D. E., Parry, H. R. & Siriwardena, G. M. (2010b) Regional variation in the efficacy of Entry Level Stewardship in England. *Agriculture, Ecosystems & Environment* **139**: 121-128.
- Davies, P. W. and Snow, D. W. (1965). Territory and food of the Song Thrush. *British Birds* **58**: 161-175.
- Deagle, B. E., Tollit, D. J., Jarman, S. N., Hindell, M. A., Trites, A. W. and Gales, N. J. (2005). Molecular scatology as a tool to study diet: analysis of prey DNA in scats from captive Steller sea lions. *Molecular Ecology* **14**: 1831-1842.
- Deagle, B. E., Eveson, J. P. and Jarman, S. N. (2006). Quantification of damage in DNA recovered from highly degraded samples--a case study on DNA in faeces. *Frontiers in Zoology* **3**: 11.
- Deagle, B. E., Gales, N. J., Evans, K., Jarman, S. N., Robinson, S., Trebilco, R. and Hindell, M. A. (2007). Studying seabird diet through genetic analysis of faeces: a case study on macaroni penguins (*Eudyptes chrysolophus*). *PLoS One* **2**: e831.
- Deagle, B. E., Kirkwood, R. and Jarman, S. N. (2009). Analysis of Australian fur seal diet by pyrosequencing prey DNA in faeces. *Molecular Ecology* **18**: 2022-2038.
- Deagle, B. E., Chiaradia, A., McInnes, J. and Jarman, S. N. (2010). Pyrosequencing faecal DNA to determine diet of little penguins: is what goes in what comes out? *Conservation Genetics* **11**: 2039-2048.
- Deagle, B. E., Jarman, S. N., Coissac, E., Pompanon, F. and Taberlet, P. (2014). DNA metabarcoding and the cytochrome c oxidase subunit I marker: not a perfect match. *Biology Letters* **10**: 20140562
- Deagle, B. E., Thomas, A. C., Shaffer, A. K., Trites, A. W. and Jarman, S. N. (2013). Quantifying sequence proportions in a DNA-based diet study using Ion Torrent amplicon sequencing: which counts count? *Molecular Ecology Resources* **13**: 620-633.
- DEFRA. (2014). Introducing Countryside Stewardship. Department for Environment, Food and Rural Affairs, Department of Agriculture, Environment and Rural Affairs, London, UK.
- DEFRA. (2017a). Agriculture in the United Kingdom 2016. Department for Environment, Food and Rural Affairs, Department of Agriculture, Environment and Rural Affairs (Northern Ireland), Welsh Assembly Government, The Department for Rural Affairs and Heritage, The Scottish Government, Rural and Environment Science and Analytical Services, York, UK.

- DEFRA. (2017b). Wild Bird Populations in the UK, 1970 to 2016. Biodiversity Statistics Team, Department for Environment, Food and Rural Affairs, York, UK.
- Donald, P. F. and Greenwood, J. J. (2001). Spatial patterns of range contraction in British breeding birds. *Ibis* **143**: 593-601.
- Donald, P. F., Green, R. E. and Heath, M. F. (2001). Agricultural intensification and the collapse of Europe's farmland bird populations. *Proceedings of the Royal Society of London B* **268**: 25-29.
- Donald, P. F., Sanderson, F. J., Burfield, I. J. and Van Bommel, F. P. (2006). Further evidence of continent-wide impacts of agricultural intensification on European farmland birds, 1990–2000. *Agriculture, Ecosystems and Environment* **116**: 189-196.
- Donald, P. F., Pisano, G., Rayment, M. D. and Pain, D. J. (2002). The Common Agricultural Policy, EU enlargement and the conservation of Europe's farmland birds. *Agriculture, Ecosystems and Environment* **89**: 167-182.
- Dormann, C. F., Gruber, B. and Fründ, J. (2008). Introducing the bipartite package: analysing ecological networks. *Interaction* **1**: 0-2413793.
- Douglas, D. J., Vickery, J. A. and Benton, T. G. (2009). Improving the value of field margins as foraging habitat for farmland birds. *Journal of Applied Ecology* **46**: 353-362.
- Douglas, D. J., Vickery, J. A. and Benton, T. G. (2010). Variation in arthropod abundance in barley under varying sowing regimes. *Agriculture, Ecosystems and Environment* **135**(1-2): 127-131.
- Dover, J., Sparks, T. (2000). A review of the ecology of butterflies in British hedgerows. *Journal of Environmental Management* **60** (1):51-63
- Doxon, E. D., Davis, C. A. and Fuhlendorf, S. D. (2011). Comparison of two methods for sampling invertebrates: vacuum and sweep-net sampling. *Journal of Field Ornithology* **82**: 60-67.
- Duelli, P. (1997). Biodiversity evaluation in agricultural landscapes: an approach at two different scales. *Agriculture, Ecosystems and Environment* **62**: 81-91.
- Duelli, P., Obrist, M. K. and Schmatz, D. R. (1999). Biodiversity evaluation in agricultural landscapes: above-ground insects. In *Invertebrate Biodiversity as Bioindicators of Sustainable Landscapes*: 33-64.
- Duffy, D. C. and Jackson, S. (1986). Diet studies of seabirds: a review of methods. *Colonial Waterbirds*: 1-17.
- Dullinger, S., Essl, F., Rabitsch, W., Erb, K. H., Gingrich, S., Haberl, H., Hulber, K. *et al.* (2013). Europe's other debt crisis caused by the long legacy of future extinctions. *Proceedings of the National Academy of Science of the USA* **110**: 7342-7347.
- Dunham, K. M. (1980). The diet of impala (*Aepyceros melampus*) in the Sengwa wildlife research area, Rhodesia. *Journal of Zoology* **192**: 41-57.

- Dunn, J. C., Hamer, K. C. and Benton, T. G. (2010). Fear for the family has negative consequences: indirect effects of nest predators on chick growth in a farmland bird. *Journal of Applied Ecology* **47**: 994-1002.
- Dunn, J. C., Hamer, K. C. and Benton, T. G. (2015). Anthropogenically-Mediated Density Dependence in a Declining Farmland Bird. *PLoS One* **10**: e0139492.
- Dunn, J. C., Stockdale, J. E., McCubbin, A., Thomas, R. C., Goodman, S. J., Grice, P. V., Morris, A. J. *et al.* (2016). Non-cultured faecal and gastrointestinal seed samples fail to detect Trichomonad infection in clinically and sub-clinically infected columbid birds. *Conservation Genetics Resources* **8**: 97-99.
- Dunn, J. C., Stockdale, J. E., Moorhouse-Gann, R. J., McCubbin, A., Hipperson, H., Morris, A. J., Grice, P. V. *et al.* (2018). The decline of the Turtle Dove: Dietary associations with body condition and competition with other columbids analysed using high-throughput sequencing. *Molecular Ecology* **27**(16): 3386-3407.
- Dunn, J. C., Stockdale, J. E., McCubbin, A., Hipperson, H., Morris, A. J., Grice, P. V. *et al.* Use of molecular tools to test usage of bespoke habitat: a case study using the rapidly declining turtle dove *Streptopelia turtur*. *In preparation for submission to Functional Ecology*.
- Durant, J. M., Hjermmann, D. Ø., Anker-Nilssen, T., Beaugrand, G., Mysterud, A., Pettorelli, N. and Stenseth, N. C. (2005). Timing and abundance as key mechanisms affecting trophic interactions in variable environments. *Ecology Letters* **8**: 52-958.
- Ebenman, B. and Karlsson, J. (1984). Urban blackbirds (*Turdus merula*): from egg to independence. *Annales Zoologici Fennici* **21**: 249-251.
- Eaton, M., Aebischer, N., Brown, A., Hearn, R., Lock, L., Musgrove, A., Noble, D. *et al.* (2015). Birds of Conservation Concern 4: the population status of birds in the UK, Channel Islands and Isle of Man. *British Birds* **108**: 708-746.
- Edgar, R. (2010). *Usearch*. Lawrence Berkeley National Laboratory (LBNL), Berkeley, CA (United States).
- Edgar, R. C. and Flyvbjerg, H. (2015). Error filtering, pair assembly, and error correction for next-generation sequencing reads. *Bioinformatics* **31**: 3476-3482.
- Edwards, P. J. (1985). Brood division and transition to independence in Blackbirds *Turdus merula*. *Ibis* **127**: 42-59.
- Edwards, C.A., and Lofty, J.R. (1996). *Biology and Ecology of Earthworms*, London, Chapman and Hall.
- Edwards, C.A., and Lofty, J.R. (1977) *Biology of Earthworms*, London, Chapman and Hall.
- Eisenhauer, N., Straube, D. and Scheu, S. (2008). Efficiency of two widespread non-destructive extraction methods under dry soil conditions for different ecological earthworm groups. *European Journal of Soil Biology* **44**: 141-145.
- Elbrecht, V., Hebert, P. D. N. and Steinke, D. (2018). Slippage of degenerate primers can cause variation in amplicon length. *Scientific Reports* **8**: 10999.

- Elbrecht, V. and Leese, F. (2017a). PrimerMiner: an r package for development and in silico validation of DNA metabarcoding primers. *Methods in Ecology and Evolution* **8**: 622-626.
- Elbrecht, V. and Leese, F. (2017b). Validation and Development of COI Metabarcoding Primers for Freshwater Macroinvertebrate Bioassessment. *Frontiers in Environmental Science* **5**: 11
- Emerson, B. C., Cicconardi, F., Fanciulli, P. P. and Shaw, P. J. (2011). Phylogeny, phylogeography, phylobetadiversity and the molecular analysis of biological communities. *Philosophical Transactions of the Royal Society of London B* **366**: 2391-2402.
- Evans, K. L. (2004). The potential for interactions between predation and habitat change to cause population declines of farmland birds. *Ibis* **146**: 1-13.
- Evans, D. M., Kitson, J. J. N., Lunt, D. H., Straw, N. A., Pocock, M. J. O. and Poisot, T. (2016). Merging DNA metabarcoding and ecological network analysis to understand and build resilient terrestrial ecosystems. *Functional Ecology* **30**: 1904-1916.
- Ewald, J. A. and Aebischer, N. J. (2000). Trends in pesticide use and efficacy during 26 years of changing agriculture in southern England. *Environmental Monitoring and Assessment* **64**: 493-529.
- Fahrig, L., Baudry, J., Brotons, L., Burel, F. G., Crist, T. O., Fuller, R. J., Sirami, C. *et al.* (2011). Functional landscape heterogeneity and animal biodiversity in agricultural landscapes. *Ecology Letters* **14**: 101-112.
- Fahrig, L., Girard, J., Duro, D., Pasher, J., Smith, A., Jovorek, S., King, D., Freemark Lindsay, K., Mitchell, S., and Tischendorf L. (2015). Farmlands with smaller crop fields have higher within-field biodiversity. *Agriculture, Ecosystems and Environment* **200**: 219-234
- Ferguson-Lees, J., Castell, R. and Leech, D. (2011). *A field guide to monitoring nests*. British Trust for Ornithology, Thetford.
- Ficetola, G. F., Coissac, E., Zundel, S., Riaz, T., Shehzad, W., Bessi re, J., Taberlet, P. *et al.* (2010). An *In silico* approach for the evaluation of DNA barcodes. *BMC Genomics* **11**: 434-444.
- Ficetola, G. F., Taberlet, P. and Coissac, E. (2016). How to limit false positives in environmental DNA and metabarcoding? *Molecular Ecology Resources* **16**: 604-607.
- Field, R. H. and Anderson, G. Q. (2004). Habitat use by breeding Tree Sparrows *Passer montanus*. *Ibis* **146**: 60-68.
- Floyd, R., Abebe, E., Papert, A. and Blaxter, M. (2002). Molecular barcodes for soil nematode identification. *Molecular Ecology* **11**: 839-850.
- Flynn, J. M., Brown, E. A., Chain, F. J., MacIsaac, H. J. and Cristescu, M. E. (2015). Toward accurate molecular identification of species in complex environmental samples: testing the performance of sequence filtering and clustering methods. *Ecology and Evolution* **5**: 2252-2266.
- Folmer, O., Black, M., Hoeh, W., Lutz, R. and Vrijenhoek, R. (1994). DNA primers for amplification of mitochondrial cytochrome c oxidase subunit I from diverse metazoan invertebrates. *Molecular Marine Biology and Biotechnology* **3**: 294-299.

- Foltan, P., Sheppard, S., Konvicka, M. and Symondson, W. O. (2005). The significance of facultative scavenging in generalist predator nutrition: detecting decayed prey in the guts of predators using PCR. *Molecular Ecology* **14**: 4147-4158.
- Fox, R. (2013). The decline of moths in Great Britain: a review of possible causes. *Insect Conservation and Diversity* **6**: 5-19.
- Fox, R., Oliver, T. H., Harrower, C., Parsons, M. S., Thomas, C. D. and Roy, D. B. (2014). Long-term changes to the frequency of occurrence of British moths are consistent with opposing and synergistic effects of climate and land-use changes. *Journal of Applied Ecology* **51**: 949-957.
- Fritch, R. A., Sheridan, H., Finn, J. A. and Kirwan, L. (2011). Methods of enhancing botanical diversity within field margins of intensively managed grassland: a 7-year field experiment. *Journal of Applied Ecology* **48**: 551-560.
- Fuller, R. J., Gregory, R. D., Gibbons, D. W., Marchant, J. H., Wilson, J. D., Baillie, S. R., and Carter, N. (1995). Population declines and range contractions among lowland farmland birds in Britain. *Conservation Biology* **9**: 1425-1441.
- Fuller, R. J., Trevelyan, R. J. and Hudson, R. W. (1997). Landscape composition models for breeding bird populations in lowland English farmland over a 20-year period. *Ecography* **20**: 295-307.
- Furness, R. W., Greenwood, J. J. D. and Jarvis, P. J. (1993). Can birds be used to monitor the environment? In *Birds as monitors of environmental change*. Springer, Dordrecht.
- Gabriel, D., Sait, S. M., Hodgson, J. A., Schmutz, U., Kunin, W. E. and Benton, T. G. (2010). Scale matters: the impact of organic farming on biodiversity at different spatial scales. *Ecology Letters* **13**: 858-869.
- Gajdoš, P. and Krištin, A. (1997). Spiders (Araneae) as bird food. *Proceedings of the 16th European Collection of Arachnologists*:91-105
- Gamero, A., Brotons, L., Brunner, A., Foppen, R., Fornasari, L., Gregory, R. D., Herrando, S. *et al.* (2017). Tracking Progress Toward EU Biodiversity Strategy Targets: EU Policy Effects in Preserving its Common Farmland Birds. *Conservation Letters* **10**: 395-402.
- Gauthier-Clerc, M., Le Maho, Y., Clerquin, Y., Drault, S., and Handrich, Y. (2000). Ecophysiology: penguin fathers preserve food for their chicks. *Nature* **408**: 928.
- Gebhardt-Henrich, S. and Richner, H. (1998). Causes of growth variation and its consequences for fitness. *Oxford Ornithology Series*, **8**: 324-339.
- Geller, J., Meyer, C., Parker, M. and Hawk, H. (2013). Redesign of PCR primers for mitochondrial cytochrome c oxidase subunit I for marine invertebrates and application in all-taxa biotic surveys. *Molecular Ecology Resources* **13**: 851-861.
- Gerard, G. M. (1967). Factors affecting earthworms in pastures. *Journal of Applied Ecology* **36**: 235-252
- Gibson, J., Shokralla, S., Porter, T. M., King, I., van Konynenburg, S., Janzen, D. H., Hallwachs, W. *et al.* (2014). Simultaneous assessment of the macrobiome and microbiome in

a bulk sample of tropical arthropods through DNA metasytematics. *Proceedings of the National Academy of Sciences of the USA* **111**: 8007-8012.

Gibson, R. H., Pearce, S., Morris, R. J., Symondson, W. O. C. and Memmott, J. (2007). Plant diversity and land use under organic and conventional agriculture: a whole-farm approach. *Journal of Applied Ecology* **44**: 792-803.

Gionfriddo, J. P., Best, L. B. and Giesler, B. J. (1995). A saline-flushing technique for determining the diet of seed-eating birds. *The Auk* **112**: 780-782.

Glen, D. M., Kreye, H., Buchs, W., El Titi, A., Ulber, B. and Worz, M. (2005). Assessing the risk of slug damage to oilseed rape and the need for control measures. *IOBC/WPRS Bulletin* **28**: 75-78

Glen, D. M., Bamber, G., Batchelor, C., Bohan, D., Fisher, J., Foster, V., Godfrey, M. *et al.* (2006). *Integrated slug control in arable crops: Risk assessment, trapping, agronomy and chemical control*. HGCA project report 393. HGCA, London.

Gotelli, N. J. and Ellison, A. M. (2013). EcoSimR 1.00. URL: <http://www.uvm.edu/~ngotelli/EcoSim/EcoSim.html>.

Green, R. (1984). The feeding ecology and survival of partridge chicks (*Alectoris rufa* and *Perdix perdix*) on arable farmland in East Anglia. *Journal of Applied Ecology* **21**: 817-830.

Greenslade, P. J. M. (1973). Sampling ants with pitfall traps: digging-in effects. *Insectes Sociaux* **20**: 343-353.

Gregory, R. D. and van Strien, A. (2010). Wild bird indicators: using composite population trends of birds as measures of environmental health. *Ornithological Science* **9**: 3-22.

Grodsky, S. M., Iglay, R. B., Sorenson, C. E. and Moorman, C. E. (2015). Should invertebrates receive greater inclusion in wildlife research journals? *The Journal of Wildlife Management* **79**: 529-536.

Gruar, D., Peach, W. J. and R, T. (2003). Summer diet and body condition of Song Thrushes *Turdus philomelos* in stable and declining farmland populations. *Ibis* **145**: 637-649.

Haddad, N. M., Crutsinger, G. M., Gross, K., Haarstad, J., Knops, J. M. and Tilman, D. (2009). Plant species loss decreases arthropod diversity and shifts trophic structure. *Ecology Letters* **12**: 1029-1039.

Haff, T. M. and Magrath, R. D. (2011). Calling at a cost: elevated nestling calling attracts predators to active nests. *Biology Letters* **7**: 493-495.

Hajibabaei, M., Smith, M. A., Janzen, D. H., Rodriguez, J. J., Whitfield, J. B. and Hebert, P. D. N. (2006). A minimalist barcode can identify a specimen whose DNA is degraded. *Molecular Ecology Notes* **6**: 959-964.

Hajibabaei, M., Shokralla, S., Zhou, X., Singer, G. A. and Baird, D. J. (2011). Environmental barcoding: a next-generation sequencing approach for biomonitoring applications using river benthos. *PLoS One* **6**: e17497.

- Hallmann, C. A., Foppen, R. P., van Turnhout, C. A., de Kroon, H. and Jongejans, E. (2014). Declines in insectivorous birds are associated with high neonicotinoid concentrations. *Nature* **511**: 341-343.
- Hanson, H. I., Palmu, E., Birkhofer, K., Smith, H. G. & Hedlund, K. (2016). Agricultural land use determines the trait composition of ground beetle communities. *PLoS One* **11**, 30146329.
- Harrison, X. A., Blount, J. D., Inger, R., Norris, D. R. and Bearhop, S. (2011). Carry over effects as drivers of fitness differences in animals. *Journal of Animal Ecology* **80**: 4-18.
- Hart, J. D., Milsom, T. P., Fisher, G., Wilkins, V., Moreby, S. J., Murray, A. W. A. and Robertson, P. A. (2006). The relationship between yellowhammer breeding performance, arthropod abundance and insecticide applications on arable farmland. *Journal of Applied Ecology* **43**: 81-91.
- Harwood, J. D., Phillips, S. W., Sunderland, K. D. and Symondson, W. O. C. (2001). Secondary predation: quantification of food chain errors in an aphid–spider–carabid system using monoclonal antibodies. *Molecular Ecology* **10**: 2049-2057.
- Haskell, D. (1994). Experimental evidence that nestling begging behaviour incurs a cost due to nest predation. *Proceedings of the Royal Society of London Series B* **257**: 161-164.
- Hastie, T. J. and Tibshirani, R. J. (1990). *Generalized additive models*. Volume 43 of Monographs on Statistics and Applied Probability.
- Hatchwell, B. J., Chamberlain, D. E. and Perrins, C. M. (1996). The reproductive success of blackbirds *Turdus merula* in relation to habitat structure and choice of nest site. *Ibis* **138**: 256-262.
- Hawkins, J., de Vere, N., Griffith, A., Ford, C. R., Allainguillaume, J., Hegarty, M. J., Baillie, L. *et al.* (2015). Using DNA metabarcoding to identify the floral composition of honey: A new tool for investigating honey bee foraging preferences. *PLoS One* **10**: e0134735.
- Hebert, P. D., Cywinska, A., Ball, S. L. and deWaard, J. R. (2003). Biological identifications through DNA barcodes. *Proceedings of the Royal Society of London B* **270**: 313-321.
- Hegemann, A., Matson, K. D., Flinks, H., and Tieleman, B. I. (2013). Offspring pay sooner, parents pay later: experimental manipulation of body mass reveals trade-offs between immune function, reproduction and survival. *Frontiers in Zoology* **10**: 77.
- Heikkinen, R. K., Luoto, M., Virkkala, R. and Rainio, K. (2004). Effects of habitat cover, landscape structure and spatial variables on the abundance of birds in an agricultural–forest mosaic. *Journal of Applied Ecology* **41**: 824-835.
- Henderson, I.G., Holland, J.M., Storkey, J., Lutman, P., Orson, J. & Simper, J. (2012) Effects of the proportion and spatial arrangement of un-cropped land on breeding bird abundance in arable rotations. *Journal of Applied Ecology* **49**: 883–891.
- Henry, M., Béguin, M., Requier, F., Rollin, O., Odoux, J-F., Aupinel, P., Aptel, J., Tchamitchian, S. and Decourtve, A. (2012). A common pesticide decreases foraging success and survival in honey bees. *Science* **336**: 348–350.
- Henschel, J. R. and Skinner, J. D. (1990). The diet of the spotted hyaenas *Crocuta crocuta* in Kruger National Park. *African Journal of Ecology* **28**: 69-82.

- Hess, G.R., Bartel, R.A., Leidner, A.K., Rosenfeld, K.M., Rubino, M.J., Snider, S.B., and Ricketts, T.H., (2006). Effectiveness of biodiversity indicators varies with extent, grain, and region. *Biological Conservation* **132**: 448–457.
- Hill, I. F. (1998). *Post-nestling mortality and dispersal in Blackbirds and Song Thrushes*. PhD thesis, University of Oxford.
- Hiron, M., Berg, Å., Eggers, S., Berggren, Å., Josefsson, J. and Pärt, T. (2015). The relationship of bird diversity to crop and non-crop heterogeneity in agricultural landscapes. *Landscape Ecology* **30**: 2001-2013.
- Hoi-Leitner, M., Romero-Pujante, M., Hoi, H. and Pavlova, A. (2001). Food availability and immune capacity in serin (*Serinus serinus*) nestlings. *Behavioral Ecology and Sociobiology* **49**: 333-339.
- Holechek, J. L., Vavra, M. and Pieper, R. D. (1982). Botanical composition determination of range herbivore diets: a review. *Journal of Range Management* **35**: 309-315.
- Holland, J. and Fahrig, L. (2000). Effect of woody borders on insect density and diversity in crop fields: a landscape-scale analysis. *Agriculture, Ecosystems and Environment* **78**: 115–122.
- Holland, J. M., Hewitt, M. V. and Drysdale, A. D. (1994). Predator populations and the influence of crop type and preliminary impact of integrated farming systems. *Aspects of Applied Biology* **40**: 217-224.
- Holland, J. M. (2002). *The agroecology of carabid beetles*. Intercept Limited.
- Holland, J. M. and Luff, M. L. (2000). The effects of agricultural practices on Carabidae in temperate agroecosystems. *Integrated Pest Management Reviews* **5**: 109-129.
- Holland J.M., and Reynolds C.J.M. (2003) The impact of soil cultivation on arthropod emergence on arable land. *Pedobiologia* **47**: 181–191.
- Holland, J. M., Southway, S. E., Ewald, J. A., Birkett, T. C., Begbie, M., Hart, J. D., Parrott, D. and Allcock, J. (2002). Invertebrate chick food for farmland birds: spatial and temporal variation in different crops. *Aspects of Applied Biology* **67**: 27-34
- Holland, J. M., Hutchison, M. A. S., Smith, B. and Aebischer, N. J. (2006). A review of invertebrates and seed-bearing plants as food for farmland birds in Europe. *Annals of Applied Biology* **148**: 49-71.
- Holland, J. M., Smith, B. M., Birkett, T. C. and Southway, S. (2011). Farmland bird invertebrate food provision in arable crops. *Annals of Applied Biology* **160**: 66-75.
- Hommay, G., Kienlen, J. C., Jacky, F. and Gertz, C. (2003). Daily variation in the number of slugs under refuge traps. *Annals of Applied Biology* **142**: 333-339.
- Höss, M., Kohn, M. and Paabo, S. (1992). Excrement analysis by PCR. *Nature* **359**: 199.
- Huang, M., Arnheim, N. and Goodman, M. F. (1992). Extension of base mispairs by Taq DNA polymerase: implications for single nucleotide discrimination in PCR. *Nucleic Acids Research* **20**: 4567-4573.

- Hull, C. L. (1999). Comparison of the diets of breeding royal (*Eudyptes schlegeli*) and rockhopper (*Eudyptes chrysocome*) penguins on Macquarie Island over three years. *Journal of Zoology* **247**: 507-529.
- Hunter, P. J. (1966). Distribution and abundance of slugs on an arable plot in Northumberland. *Journal of Animal Ecology* **35**: 543-557.
- Inger, R. and Bearhop, S. (2008). Applications of stable isotope analyses to avian ecology. *Ibis* **150**: 447-461.
- Jeliazkov, A., Mimet, A., Chargé, R., Jiguet, F., Devictor, V. and Chiron, F. (2016). Impacts of agricultural intensification on bird communities: New insights from a multi-level and multi-facet approach of biodiversity. *Agriculture, Ecosystems and Environment* **216**: 9-22.
- Jerrentrup, J. S., Dauber, J., Strohbach, M. W., Mecke, S., Mitschke, A., Ludwig, J., and Klimek, S. (2017). Impact of recent changes in agricultural land use on farmland bird trends. *Agriculture, Ecosystems and Environment* **239**: 334 – 341.
- Johnson, E. J., Best, L. B. and Heagy, P. A. (1980). Food sampling biases associated with the “ligature method”. *Condor* **82**: 186-192.
- Johnston, R. D. (1993). Effects of diet quality on the nestling growth of a wild insectivorous passerine, the house martin *Delichon urbica*. *Functional Ecology* **7**: 255-266.
- Juen, A. and Traugott, M. (2005). Detecting predation and scavenging by DNA gut-content analysis: a case study using a soil insect predator-prey system. *Oecologia* **142**: 344-352.
- Julliard, R., McCleery, R. H., Clobert, J. and Perrins, C. M. (1997). Phenotypic adjustment of clutch size due to nest predation in the great tit. *Ecology* **78**: 394-404.
- Kambhampati, S. and Smith, P. T. (1995). PCR primers for the amplification of four insect mitochondrial gene fragments. *Insect Molecular Biology* **4**: 233-236.
- Kelleher, K. M. and O'Halloran, J. (2007). Influence of nesting habitat on breeding Song Thrushes *Turdus philomelos*. *Bird Study* **54**: 221-229.
- King, R. A., Read, D. S., Traugott, M. and Symondson, W. O. (2008). Molecular analysis of predation: a review of best practice for DNA-based approaches. *Molecular Ecology* **17**: 947-963.
- Kircher, M. (2012). Analysis of high-throughput ancient DNA sequencing data. In *Ancient DNA* (pp. 197-228). Humana Press.
- Kitaysky, A. S., Wingfield, J. C. and Piatt, J. F. (1999). Dynamics of food availability, body condition and physiological stress response in breeding black-legged kittiwakes. *Functional Ecology* **13**: 577-584.
- Kleijn, D., Baquero, R. A., Clough, Y., Diaz, M., De Esteban, J., Fernandez, F., Gabriel, D. *et al.* (2006). Mixed biodiversity benefits of agri-environment schemes in five European countries. *Ecology Letters* **9**: 243-254
- Kleijn, D., Rundlof, M., Scheper, J., Smith, H. G. and Tschardtke, T. (2011). Does conservation on farmland contribute to halting the biodiversity decline? *Trends in Ecology and Evolution* **26**: 474-481.

- Klein, A-M., Vaissière, B. E., Cane, J. H., Steffan-Dewenter, I., Cunningham, S. A., Kremen, C. and Tscharntke, T. (2007). Importance of pollinators in changing landscapes for world crops. *Proceedings of the Royal Society of London B* **274**(1608): 303-313.
- Klindworth, A., Pruesse, E., Schweer, T., Peplies, J., Quast, C., Horn, M. and Glockner, F. O. (2013). Evaluation of general 16S ribosomal RNA gene PCR primers for classical and next-generation sequencing-based diversity studies. *Nucleic Acids Research* **41**: e1.
- Kohn, M. H. and Wayne, R. K. (1997). Facts from feces revisited. *Trends in Ecology and Evolution* **12**: 223-227.
- Konarzewski, M., Kowalczyk, J., Swierubska, T. and Lewonczuk, B. (1996). Effect of short-term feed restriction, realimentation and overfeeding on growth of song thrush (*Turdus philomelos*) nestlings. *Functional Ecology* **10**: 97-105.
- Konarzewski, M. and Starck, J. M. (2000). Effects of food shortage and oversupply on energy utilization, histology, and function of the gut in nestling song thrushes (*Turdus philomelos*). *Physiological and Biochemical Zoology* **73**: 416-427.
- Krahn, M. M., Pitman, R. L., Burrows, D. G., Herman, D. P. and Pearce, R. W. (2008). Use of chemical tracers to assess diet and persistent organic pollutants in Antarctic Type C killer whales. *Marine Mammal Science* **24**: 643-663.
- Kratina, P., LeCraw, R. M., Ingram, T. and Anholt, B. R. (2012). Stability and persistence of food webs with omnivory: Is there a general pattern? *Ecosphere* **3**: 1-18
- Kujawa, K. (2002) Population density and species composition changes for breeding bird species in farmland woodlots in western Poland between 1964 and 1994. *Agriculture, Ecosystems and Environment* **91**: 261-271
- Labocha, M. K. and Hayes, J. P. (2012). Morphometric indices of body condition in birds: a review. *Journal of Ornithology* **153**: 1-22.
- Lack, D. (1954). *The natural regulation of animal numbers*. The Clarendon Press; Oxford.
- Lack, P. C. (1988). Hedge intersections and breeding bird distribution in farmland. *Bird Study* **35**: 133-136.
- Lawrence, A. P. and Bowers, M. A. (2002). A test of the 'hot' mustard extraction method of sampling earthworms. *Soil Biology and Biochemistry* **34**: 549-552.
- Leray, M., Agudelo, N., Mills, S. C. and Meyer, C. P. (2013). Effectiveness of annealing blocking primers versus restriction enzymes for characterization of generalist diets: unexpected prey revealed in the gut contents of two coral reef fish species. *PLoS One* **8**: e58076.
- Lindström, J. (1999). Early development and fitness in birds and mammals. *Trends in Ecology and Evolution* **14**: 343-348.
- Little, L. P., Strong, A. M. and Perlut, N. G. (2009). Aggressive response of adult Bobolinks to neck ligatures on nestlings. *The Wilson Journal of Ornithology* **121**: 441-444.

- Lunt, D. H., Zhang, D. X., Szymura, J. M., and Hewlitt, O. M. (1996). The insect cytochrome oxidase I gene: evolutionary patterns and conserved primers for phylogenetic studies. *Insect Molecular Biology* **5**: 153-165.
- MacDonald, A. J., and Sarre, S.D. (2016). A framework for developing and validating taxon-specific primers for specimen identification from environmental DNA. *Molecular Ecology Resources* **17**(4): 708-720.
- MacLeod, A., Wratten, S.D., Sotherton, N.W. & Thomas, M.B. (2004) "Beetle banks" as refuges for beneficial arthropods in farmland: long-term changes in predator communities and habitat. *Agricultural and Forest Entomology* **6**: 147– 154
- Magoč, T. and Salzberg, S. L. (2011). FLASH: fast length adjustment of short reads to improve genome assemblies. *Bioinformatics* **27**: 2957-2963.
- Magrath, R. D. (1989). Hatching asynchrony and reproductive success in the blackbird. *Nature* **339**: 536.
- Magrath, R. D. (1991). Nestling weight and juvenile survival in the blackbird, *Turdus merula*. *The Journal of Animal Ecology* **60**: 335-351.
- Maier, M. J. (2014). DirichletReg: Dirichlet regression for compositional data in R.
- Martin, T. E. (1987). Food as a limit on breeding birds: a life-history perspective. *Annual Review of Ecology and Systematics* **18**: 453-487.
- Martinsson, S., Rhoden, C. and Erseus, C. (2017). Barcoding gap, but no support for cryptic speciation in the earthworm *Aporrectodea longa* (Clitellata: Lumbricidae). *Mitochondrial DNA Part A* **28**: 147-155.
- Mason, C. F. (1998). Habitats of the song thrush *Turdus philomelos* in a largely arable landscape. *Journal of Zoology* **244**: 89-93.
- Matson, P. A., Parton, W. J., Power, A. G., and Swift, M. J. (1997). Agricultural intensification and ecosystem properties. *Science* **277**: 504-509.
- Maudsley, M. J. (2000). A review of the ecology and conservation of hedgerow invertebrates in Britain. *Journal of Environmental Management* **60**: 65-76.
- McCracken, D. I., and Tallowin, J. R. (2004). Swards and structure: the interactions between farming practices and bird food resources in lowland grasslands. *Ibis* **146**: 108-114.
- McHugh, N. M. (2015). Breeding farmland birds and the role of habitats created under agri-environment schemes. PhD Thesis, Imperial College London.
- McHugh, N. M., Goodwin, C. E., Hughes, S., Leather, S. R. and Holland, J. M. (2016). Agri-environment scheme habitat preferences of Yellowhammer *Emberiza citrinella* on English farmland. *Acta Ornithologica* **51**: 199-209.
- McInnes, J. C., Alderman, R., Deagle, B. E., Lea, M.-A., Raymond, B., Jarman, S. N. and Bunce, M. (2017a). Optimised scat collection protocols for dietary DNA metabarcoding in vertebrates. *Methods in Ecology and Evolution* **8**: 192-202.

- McInnes, J. C., Alderman, R., Lea, M. A., Raymond, B., Deagle, B. E., Phillips, R. A., Stanworth, A. *et al.* (2017b). High occurrence of jellyfish predation by black-browed and Campbell albatross identified by DNA metabarcoding. *Molecular Ecology* **26**: 4831-4845
- Meek, B., Loxton, D., Sparks, T., Pywell, R., Pickett, H. and Nowakowski, M. (2002). The effect of arable field margin composition on invertebrate biodiversity. *Biological Conservation* **106**: 259-271.
- Merckx, T., Feber, R. E., Dulieu, R. L., Townsend, M. C., Parsens, M. S., Bourn, N. A. D., Riordan, P., and MacDonald, D.W., (2009). Effect of field margins on moths depends on species mobility: field-based evidence for landscape-scale conservation. *Agriculture Ecosystems and Environment* **129**: 302–309.
- Merckx, T., Marini, L., Feber, R. E., MacDonald, D. E., (2012). Hedgerow trees and extended-width field margins enhance macro-moth diversity: implications for management. *Journal of Applied Ecology* **49**: 1396–1404.
- Metcalf, N. B. and Monaghan, P. (2001). Compensation for a bad start: grow now, pay later? *Trends in Ecology and Evolution* **16**: 254-260.
- Meusnier, I., Singer, G. A., Landry, J. F., Hickey, D. A., Hebert, P. D. and Hajibabaei, M. (2008). A universal DNA mini-barcode for biodiversity analysis. *BMC Genomics* **9**: 214.
- Meyer, C. P. and Paulay, G. (2005). DNA barcoding: error rates based on comprehensive sampling. *PLoS Biology* **3**: e422.
- Miller, M. W., Leech, D. I., Pearce-Higgins, J. W. and Robinson, R. A. (2017). Multi-state, multi-stage modeling of nest-success suggests interaction between weather and land-use. *Ecology* **98**: 175-186.
- Møller, A. P. (1990). Changes in the size of avian breeding territories in relation to the nesting cycle. *Animal Behaviour* **40**(6): 1070-1079.
- Møller, A. P. (2001). The effect of dairy farming on barn swallow *Hirundo rustica* abundance, distribution and reproduction. *Journal of Applied Ecology* **38**: 378-389.
- Monaghan, P. and Nager, R. (1997). Why don't birds lay more eggs? *Trends in Ecology and Evolution* **12**: 270–274.
- Moreby S. J., and Southway S. E. (2002) Cropping and year effects on the availability of invertebrate groups important in the diet of nestling farmland birds. *Aspects of Applied Biology* **67**: 107–112.
- Moreby, S. J. and Stoate, C. (2000). A quantitative comparison of neck-collar and faecal analysis to determine passerine nestling diet. *Bird Study* **47**: 320-331.
- Moreby, S. J. and Stoate, C. (2001). Relative abundance of invertebrate taxa in the nestling diet of three farmland passerine species, Dunnock *Prunella modularis*, Whitethroat *Sylvia communis* and Yellowhammer *Emberiza citrinella* in Leicestershire, England. *Agriculture, Ecosystems and Environment* **86**: 125-134.
- Morris, M. G. (2000). The effects of structure and its dynamics on the ecology and conservation of arthropods in British grasslands. *Biological Conservation* **95**: 129–142.

- Morris, A. J. and Bradbury, R. B. (2002). Determinants of patch selection by Yellowhammers *Emberiza citrinella* foraging in cereal crops. *Aspects of Applied Biology* **67**: 43-50.
- Morris, A. J., Wilson, J. D., Whittingham, M. J. and Bradbury, R. B. (2005). Indirect effects of pesticides on breeding yellowhammer (*Emberiza citrinella*). *Agriculture, Ecosystems and Environment* **106**: 1-16.
- Murray, D. C., Coghlan, M. L. and Bunce, M. (2015). From benchtop to desktop: important considerations when designing amplicon sequencing workflows. *PLoS One* **10**: e0124671.
- Murray, K. A. (2004). *Factors affecting foraging of breeding farmland birds*. PhD Thesis. Open University, Milton Keynes.
- Musgrove, A., Aebischer, N., Eaton, M., Hearn, R., Newson, S., Noble, D., Parsons, M. *et al.* (2013). Population estimates of birds in Great Britain and the United Kingdom. *British Birds* **106**: 64-100.
- Naef-Daenzer, B. and Keller, L. F. (1999). The foraging performance of great and blue tits (*Parus major* and *P. caeruleus*) in relation to caterpillar development, and its consequences for nestling growth and fledging weight. *Journal of Animal Ecology* **68**: 708-718.
- Naef-Daenzer, L., Naef-Daenzer, B. and Nager, R. G. (2000). Prey selection and foraging performance of breeding Great Tits *Parus major* in relation to food availability. *Journal of Avian Biology* **31**: 206-214.
- Naef-Daenzer, B., Widmer, F. and Nuber, M. (2001). Differential post-fledging survival of great and coal tits in relation to their condition and fledging date. *Journal of Animal Ecology* **70**: 730-738.
- Naef-Daenzer, B. and Grübler, M. U. (2016). Post-fledging survival of altricial birds: ecological determinants and adaptation. *Journal of Field Ornithology* **87**: 227-250.
- Nager, R., Ruedger, C. and van Noordwijk, A. (1997). Nutrient or energy limitation on egg formation: a feeding experiment in great tits. *Journal of Animal Ecology* **66**: 495-507.
- Najafabadi, H. S., Torabi, N. and Chamankhah, M. (2008). Designing multiple degenerate primers via consecutive pairwise alignments. *BMC Bioinformatics* **9**: 55.
- Natural England. (2013a). Environmental Stewardship Handbook. Entry Level Stewardship, Fourth Edition. Natural England, Peterborough,
- Natural England. (2013b). Environmental Stewardship Handbook. Higher Level Stewardship, Fourth Edition. Natural England, Peterborough,
- Natural England (2014). Earthworms in England: distribution, abundance and habitats. Commissioned report for Natural England, Exeter, UK.
- Nelson, L. A., Wallman, J. F. and Dowton, M. (2007). Using COI barcodes to identify forensically and medically important blowflies. *Medical and Veterinary Entomology* **21**: 44-52.
- Neuenschwander, S., Brinkhof, M. W., Kölliker, M. and Richner, H. (2003). Brood size, sibling competition, and the cost of begging in great tits (*Parus major*). *Behavioral Ecology* **14**: 457-462.

- Newton, I. (2004). The recent declines of farmland bird populations in Britain: an appraisal of causal factors and conservation actions. *Ibis* **146**: 579-600.
- Newton, I. (2013). *Bird Populations*. (Collins New Naturalist Library Book 124). HarperCollins UK.
- Nielsen, J. M., Clare, E. L., Hayden, B., Brett, M. T. and Kratina, P. (2017). Diet tracing in ecology: method comparison and selection. *Methods in Ecology and Evolution* **9**: 278-291.
- Oehm, J., Juen, A., Nagiller, K., Neuhauser, S. and Traugott, M. (2011). Molecular scatology: how to improve prey DNA detection success in avian faeces? *Molecular Ecology Resources* **11**: 620-628.
- Oehm, J., Thalinger, B., Eisenkölbl, S., & Traugott, M. (2017). Diet analysis in piscivorous birds: What can the addition of molecular tools offer? *Ecology and Evolution*, **7**, 1984–1995
- Oksanen, J., Blanchet, F. G., Kindt, R., Legendre, P., Minchin, P. R., O'Hara, R. B., Simpson, G. L. *et al.* (2013). Package 'vegan'. *Community ecology package, version*, 2(9).
- Oliver, I. and Beattie, A. J. (1996). Designing a cost-effective invertebrate survey: a test of methods for rapid assessment of biodiversity. *Ecological Applications* **6**: 594-607.
- Oliver, T., Roy, D. B., Hill, J. K., Brereton, T. and Thomas, C. D. (2010). Heterogeneous landscapes promote population stability. *Ecology Letters* **13**: 473-484.
- Orłowski, G., Wuczyński, A. and Karg, J. (2015). Effect of brood age on nestling diet and prey composition in a hedgerow specialist bird, the Barred Warbler *Sylvia nisoria*. *PloS one* **10**: e0131100.
- Padoa-Schioppa, E., Baietto, M., Massa, R. and Bottoni, L. (2006). Bird communities as bioindicators: The focal species concept in agricultural landscapes. *Ecological Indicators* **6**: 83-93.
- Paradis, E., Baillie, S. R., Sutherland, W. J., Dudley, C., Crick, H. Q. and Gregory, R. D. (2000). Large-scale spatial variation in the breeding performance of song thrushes *Turdus philomelos* and blackbirds *T. merula* in Britain. *Journal of Applied Ecology* **37**: 73-87.
- Paula, D.P., Linard, B., Crampton-Platt, A., Srivathsan, A., Timmermans, M.J.T.N., Sujji, E.R., Pires, C.S.S., *et al.* (2016). Uncovering Trophic Interactions in Arthropod Predators through DNA Shotgun-Sequencing of Gut Contents. *PLoS ONE* **11**: 1–14.
- Pe'er, G., Dicks, L. V., Visconti, P., Arlettaz, R., Báldi, A., Benton, T. G., Collins, S. *et al.* (2014). EU agricultural reform fails on biodiversity. *Science* **344**: 1090-1092.
- Peach, W. J., Robinson, R. A., and Murray, K. A. (2004). Demographic and environmental causes of the decline of rural Song Thrushes *Turdus philomelos* in lowland Britain. *Ibis* **146**: 50-59.
- Pearce-Higgins, J. W. (2010). Using diet to assess the sensitivity of northern and upland birds to climate change. *Climate Research* **45**: 119-130.
- PECBMS. (2017).. *Population Trends of Common European Breeding Birds: 2017 Update*. Prague.

- Pelossi, C., Barot, S., Capowiez, Y., Hedde, M., and Vandembulcke, F. (2014). Pesticides and earthworms: a review. *Agronomy for Sustainable Development* **34**(1): 199-228.
- Pelosi, C., Bertrand, M., Capowiez, Y., Boizard, H., and Roger-Estrade, R. (2009). Earthworm collection from agricultural fields: Comparisons of selected repellents in presence/absence of hand-sorting. *European Journal of Soil Biology* **45**: 176-183.
- Perkins, A. J., Maggs, H. E., Watson, A. and Wilson, J. D. (2011). Adaptive management and targeting of agri-environment schemes does benefit biodiversity: a case study of the corn bunting *Emberiza calandra*. *Journal of Applied Ecology* **48**: 514-522.
- Perrings, C., Jackson, L., Bawa, K., Brussaard, L., Brush, S., Gavin, T., Papa, R. *et al.* (2006). Biodiversity in Agricultural Landscapes: Saving Natural Capital without Losing Interest. *Conservation Biology* **20**: 263-264.
- Pianka, E. R. (1986). Ecology and Natural History of Desert Lizards: Analyses of the Ecological Niche and Community Structure.
- Pickett, S. R. A. and Siriwardena, G. M. (2011). The relationship between multi-scale habitat heterogeneity and farmland bird abundance. *Ecography* **34**: 955-969.
- Piñol, J., Mir, G., Gomez-Polo, P. and Agusti, N. (2015). Universal and blocking primer mismatches limit the use of high-throughput DNA sequencing for the quantitative metabarcoding of arthropods. *Molecular Ecology Resources* **15**: 819-830.
- Piñol, J., San Andres, V., Clare, E. L., Mir, G. and Symondson, W. O. (2014). A pragmatic approach to the analysis of diets of generalist predators: the use of next-generation sequencing with no blocking probes. *Molecular Ecology Resources* **14**: 18-26.
- Piñol, J., Senar, M.A., and Symondson, W.O.C. (2018). The choice of universal primers and the characteristics of the species mixture determines when DNA metabarcoding can be quantitative. *Molecular Ecology*: e14776
- Pocock, M.J.O., Evans, D.M., and Memmott, J. (2012). The robustness and restoration of a network of ecological networks. *Science* **335**: 973-977.
- Pompanon, F., Deagle, B. E., Symondson, W. O., Brown, D. S., Jarman, S. N. and Taberlet, P. (2012). Who is eating what: diet assessment using next generation sequencing. *Molecular Ecology* **21**: 1931-1950.
- Porter, T. M., Gibson, J. F., Shokralla, S., Baird, D. J., Golding, G. B. and Hajibabaei, M. (2014). Rapid and accurate taxonomic classification of insect (class Insecta) cytochrome c oxidase subunit 1 (COI) DNA barcode sequences using a naïve Bayesian classifier. *Molecular Ecology Resources* **14**: 929-942.
- Potts, G. D. (2012). *Partridges: Countryside Barometer*. Collins New Naturalist Library, Book 121. HarperCollins UK.
- Qiu, H., Peijnenburg, W., van Gestel, C. A. M. and Vijver, M. G. (2014). Can commonly measurable traits explain differences in metal accumulation and toxicity in earthworm species? *Ecotoxicology* **23**: 21-32.

- Quince, C., Lanzen, A., Curtis, T. P., Davenport, R. J., Hall, N., Head, I. M., Read, L. F. *et al.* (2009). Accurate determination of microbial diversity from 454 pyrosequencing data. *Nature Methods* **6**: 639-641.
- R Core Development Team. (2017) R: A language and environment for statistical computing.
- Radford, A. N. (2008). Age-related changes in nestling diet of the cooperatively breeding Green Woodhoopoe. *Ethology* **114**: 907-915.
- Ramsay, S. L. and Houston, D. C. (2003). Amino acid composition of some woodland arthropods and its implications for breeding tits and other passerines. *Ibis* **145**: 227-232.
- Rand, T. A., Tylianakis, J. M. and Tscharntke, T. (2006). Spillover edge effects: the dispersal of agriculturally subsidized insect natural enemies into adjacent natural habitats. *Ecology Letters* **9**: 603-614.
- Ratnasingham, S. and Hebert, P. D. (2007). BOLD: The Barcode of Life Data System (www.barcodinglife.org). *Molecular Ecology Notes* **7**: 355-364.
- Razgour, O., Clare, E. L., Zeale, M. R., Hanmer, J., Schnell, I. B., Rasmussen, M., Gilbert, T. P. *et al.* (2011). High-throughput sequencing offers insight into mechanisms of resource partitioning in cryptic bat species. *Ecology and Evolution* **1**: 556-570.
- Reif, J., and Vermouzek, Z. (2018). Collapse of farmland bird populations in an Eastern European country following its EU accession. *Conservation Letters*: e12585.
- Reif, J., Voříšek, P., Štastný, K., Bejček, V. and Petr, J. (2008). Agricultural intensification and farmland birds: new insights from a central European country. *Ibis* **150**: 596-605.
- Renwick, A. R., Johnston, A., Joys, A., Newson, S. E., Noble, D. G. and Pearce-Higgins, J. W. (2012). Composite bird indicators robust to variation in species selection and habitat specificity. *Ecological Indicators* **18**: 200-207.
- Riaz, T., Shehzad, W., Viari, A., Pompanon, F., Taberlet, P. and Coissac, E. (2011). ecoPrimers: inference of new DNA barcode markers from whole genome sequence analysis. *Nucleic Acids Research* **39**: e145.
- Riccioni, G., Stagioni, M., Piccinetti, C., and Libralato, S., (2018). A metabarcoding approach for the feeding habits of European hake in the Adriatic Sea. *Ecology and Evolution* **8**: 10435-10447,
- Richardson, R. T., Bengtsson-Palme, J. and Johnson, R. M. (2017). Evaluating and optimizing the performance of software commonly used for the taxonomic classification of DNA metabarcoding sequence data. *Molecular Ecology Resources* **17**: 760-769.
- Richner, H. (1989). Habitat-specific growth and fitness in carrion crows (*Corvus corone corone*). *The Journal of Animal Ecology* **58**: 427-440.
- Ricklefs, R. E. and Starck, J. M. (Eds.). (1998). *Avian growth and development: evolution within the altricial-precocial spectrum*. Oxford University Press.
- Robinson, R., Wilson, J. and Crick, H. (2001). The importance of arable habitat for farmland birds in grassland landscapes. *Journal of Applied Ecology* **38**: 1059-1069.

- Robinson, R. A. and Sutherland, W. J. (2002). Post-war changes in arable farming and biodiversity in Great Britain. *Journal of Applied Ecology* **39**: 157-176.
- Robinson, R. A., Green, R. E., Baillie, S. R., Peach, W. J. and Thomson, D. L. (2004). Demographic mechanisms of the population decline of the song thrush *Turdus philomelos* in Britain. *Journal of Animal Ecology* **73**: 670-682.
- Robinson, R. A., Baillie, S. R. and King, R. (2012). Population processes in European Blackbirds *Turdus merula*: a state-space approach. *Journal of Ornithology* **152**: 419-433.
- Robinson, R. A., Marchant, J. H., Leech, D. I., Massimo, D., Sullivan, M. J. P., Eglington, S. M., Barimore, C. *et al.* (2015). BirdTrends 2015: trends in numbers, breeding success and survival for UK breeding birds. Research Report 678. British Trust for Ornithology, Thetford.
- Roslin, T. and Majaneva, S. (2016). The use of DNA barcodes in food web construction-terrestrial and aquatic ecologists unite! *Genome* **59**: 603-628.
- Rowson, B., Turner, J., Anderson, R. and Symondson, B. (2015). *Slugs of Britain and Ireland: Identification, Understanding and Control*. Field Studies Council.
- Rubinoff, D., Cameron, S. and Will, K. (2006). A genomic perspective on the shortcomings of mitochondrial DNA for "barcoding" identification. *Journal of Heredity* **97**: 581-594.
- Ryschawy, J., Choisis, N., Choisis, J., Joannon, A., and Gibon, A. (2012). Mixed crop-livestock systems: An economic and environmental-friendly way of farming? *Animal* **6**(10): 1722-1730.
- Salinas-Ramos, V. B., Herrera Montalvo, L. G., Leon-Regagnon, V., Arrizabalaga-Escudero, A. and Clare, E. L. (2015). Dietary overlap and seasonality in three species of mormoopid bats from a tropical dry forest. *Molecular Ecology* **24**: 5296-5307.
- Sánchez, M. S. and Dos Santos, D. A. (2015). Understanding the spatial variations in the diets of two Sturnira bats (Chiroptera: Phyllostomidae) in Argentina. *Journal of Mammalogy* **96**: 1352-1360.
- Santana, J., Reino, L., Stoate, C., Moreira, F., Ribeiro, P. F., Santos, J. L., Rotenberry, J. T. *et al.* (2017). Combined effects of landscape composition and heterogeneity on farmland avian diversity. *Ecology and Evolution* **7**: 1212-1223.
- Schloss, P. D., Westcott, S. L., Ryabin, T., Hall, J. R., Hartmann, M., Hollister, E. B., Lesniewski, R. A. *et al.* (2009). Introducing mothur: open-source, platform-independent, community-supported software for describing and comparing microbial communities. *Applied and Environmental Microbiology* **75**: 7537-7541.
- Schmidt, K. A. (1999). Foraging theory as a conceptual framework for studying nest predation. *Oikos* **85**: 151-160.
- Schmidt, M. H., Roschewitz, I., Thies, C. and Tschardtke, T. (2005). Differential effects of landscape and management on diversity and density of ground-dwelling farmland spiders. *Journal of Applied Ecology* **42**: 281-287.
- Schnack, S. (1991). Breeding biology and nesting diet of the Blackbird *Turdus merula* L. and Song Thrush *Turdus philomelos* CL Brehm in Vienna and in an adjacent wood. *Acta Ornithologica* **26**: 85-106.

- Schnell, I. B., Bohmann, K. and Gilbert, M. T. (2015). Tag jumps illuminated--reducing sequence-to-sample misidentifications in metabarcoding studies. *Molecular Ecology Resources* **15**: 1289-1303.
- Schoener, T. W. (1974). Resource partitioning in ecological communities. *Science* **185**:27-39.
- Sharma, P. and Kobayashi, T. (2014). Are "universal" DNA primers really universal? *Journal of Applied Genetics* **55**: 485-496.
- Shehzad, W., Riaz, T., Nawaz, M. A., Miquel, C., Poillot, C., Shah, S. A., Pompanon, F. *et al.* (2012). Carnivore diet analysis based on next-generation sequencing: application to the leopard cat (*Prionailurus bengalensis*) in Pakistan. *Molecular Ecology* **21**: 1951-1965.
- Sheppard, S. K., Bell, J., Sunderland, K. D., Fenlon, J., Skervin, D. and Symondson, W. O. (2005). Detection of secondary predation by PCR analyses of the gut contents of invertebrate generalist predators. *Molecular Ecology* **14**: 4461-4468.
- Sherlock, E. (2012). *Key to the Earthworms of the UK and Ireland*. FSC.
- Sherry, T. W., Johnson, M. D., Williams, K. A., Kaban, J. D., McAvoy, C. K., Hallauer, A. M., Rainey, S. *et al.* (2016). Dietary opportunism, resource partitioning, and consumption of coffee berry borers by five species of migratory wood warblers (Parulidae) wintering in Jamaican shade coffee plantations. *Journal of Field Ornithology* **87**: 273-292.
- Shokralla, S., Gibson, J. F., Nikbakht, H., Janzen, D. H., Hallwachs, W. and Hajibabaei, M. (2014). Next-generation DNA barcoding: using next-generation sequencing to enhance and accelerate DNA barcode capture from single specimens. *Molecular Ecology Resources* **14**: 892-901.
- Siepel, H. (1990). The influence of management on food size in the menu of insectivorous birds. *Proceedings of the Section Experimental and Applied Entomology of the Netherlands Entomological Society* **1**: 69-74.
- Simms, E. (1978). *British thrushes*. Harper Collins.
- Simon, C., Frati, F., Beckenbach, A., Crespi, B., Liu, H. and Flook, P. (1994). Evolution, weighting, and phylogenetic utility of mitochondrial gene sequences and a compilation of conserved polymerase chain reaction primers. *Annals of the entomological Society of America* **87**: 651-701.
- Simon, C., Buckley, T. R., Frati, F., Stewart, J. B. and Beckenbach, A. T. (2006). Incorporating Molecular Evolution into Phylogenetic Analysis, and a New Compilation of Conserved Polymerase Chain Reaction Primers for Animal Mitochondrial DNA. *Annual Review of Ecology, Evolution, and Systematics* **37**: 545-579.
- Sims, R. W. and Gerard, B. M. (1985). *Earthworms: keys and notes for the identification and study of the species*. Brill Archive.
- Sirami, C., Brotons, L. and Martin, J. L. (2007). Vegetation and songbird response to land abandonment: from landscape to census plot. *Diversity and Distributions* **13**: 42-52.
- Siriwardena, G. M., Baillie, S. R., Buckland, S. T., Fewster, R. M., Marchant, J. H. and Wilson, J. D. (1998). Trends in the abundance of farmland birds: a quantitative comparison of smoothed Common Birds Census indices. *Journal of Applied Ecology* **35**: 24-43.

- Siriwardena, G. M., Crick, H. Q., Baillie, S. R. and Wilson, J. D. (2000). Agricultural land-use and the spatial distribution of granivorous lowland farmland birds. *Ecography* **23**: 702-719.
- Siriwardena, G., Stevens, D., Anderson, G., Vickery, J., Calbrade, N. and Dodd, S. (2007). The effect of supplementary winter seed food on breeding populations of farmland birds: evidence from two large-scale experiments. *Journal of Applied Ecology* **44**: 920–932.
- Smith, R. K., Vaughan Jannings, N. and Harris, S. (2005). A quantitative analysis of the abundance and demography of European hares *Lepus europaeus* in relation to habitat type, intensity of agriculture and climate. *Mammal Review* **35**: 1-24
- Smith, M. A., Poyarkov, N. A., Jr. and Hebert, P. D. (2008). DNA barcoding: CO1 DNA barcoding amphibians: take the chance, meet the challenge. *Molecular Ecology Resources* **8**: 235-246.
- Snow, D. W. (1955a). The Breeding of the Blackbird, Song Thrush, and Mistle Thrush in Great Britain Part II. Clutch-Size. *Bird Study* **2**: 72-84.
- Snow, D. W. (1955b). The Breeding of Blackbird, Song Thrush Mistle Thrush in Great Britain Part III. Nesting Success. *Bird Study* **2**: 169-178.
- Snow, D. W. (1958a). The breeding of the Blackbird *Turdus merula* at Oxford. *Ibis* **100**: 1-30.
- Snow, D. W. (1958b). *A study of blackbirds*. British Museum of Natural History.
- Sogin, M. L., Morrison, H. G., Huber, J. A., Welch, D. M., Huse, S. M., Neal, P. R., Arrieta, J. M. *et al.* (2006). Microbial diversity in the deep sea and the underexplored “rare biosphere”. *Proceedings of the National Academy of Sciences of the USA* **103**: 12115-12120.
- Sotherton, N. W. (1984). The distribution and abundance of predatory arthropods overwintering on farmland. *Annals Applied Biology* **105**: 423-429.
- Sotherton, N. W. and Self, M. J. (2000). Changes in plant and arthropod biodiversity on lowland farmland: an overview. *Ecology and Conservation of Lowland Farmland Birds*, 26-35.
- Sotherton, N. W., Robertson, P. A. and Dowell, S. D. (1993). Manipulating pesticide use to increase the production of wild game birds in Britain. *National Quail Symposium Proceedings* **3**: 13.
- Southwood, T. R. and Cross, D. J. (2002). Food requirements of grey partridge *Perdix perdix* chicks. *Wildlife Biology* **8**: 175-183.
- Sparks, T. H., Parish, T. and Hinsley, S. A. (1996). Breeding birds in field boundaries in an agricultural landscape. *Agriculture, Ecosystems and Environment* **60**: 1-8.
- Statistics for Wales. (2015). *Welsh Agricultural Statistics 2015*. Statistical Publication Unit, Cardiff.
- Stoate, C. and Szczur, J. (2010). Could game management have a role in the conservation of farmland passerines? A case study from a Leicestershire farm. *Bird Study* **48**: 279-292.

- Stockdale, J. E., Dunn, J. C., Goodman, S. J., Morris, A. J., Sheehan, D. K., Grice, P. V. and Hamer, K. C. (2015). The protozoan parasite *Trichomonas gallinae* causes adult and nestling mortality in a declining population of European Turtle Doves, *Streptopelia turtur*. *Parasitology* **142**: 490-498.
- Storkey, J., Meyer, S., Still, K. S. and Leuschner, C. (2011). The impact of agricultural intensification and land-use change on the European arable flora. *Proceedings of the Royal Society of London B* **279** (1732): 1421–1429.
- Streby, H. M. and Andersen, D. E. (2013). Testing common assumptions in studies of songbird nest success. *Ibis* **155**: 327-337.
- Sutherland, R. M. (2000). *Molecular analysis of avian diet*. PhD Thesis. University of Oxford.
- Suzuki, M. T. and Giovannoni, S. J. (1996). Bias Caused by Template Annealing in the Amplification of Mixtures of 16S rRNA Genes by PCR. *Applied Environmental Microbiology* **62**: 625-630.
- Symondson, W. O. C. (2002). Molecular identification of prey in predator diets. *Molecular Ecology* **11**: 627-641.
- Symondson, W. O. C., Sunderland, K.D., and Greenstone, M.H., (2002). Can Generalist Predators be Effective Biocontrol Agents? *Annual Review of Entomology* **47**: 561-594.
- Szentkirályi, F. and Kristín, A. (2002). Lacewings and snakeflies (Neuroptera, Raphidioptera) as prey for bird nestlings in Slovakian forest habitats. *Acta Zoologica Academiae Scientiarum Hungaricae* **48**: 329-340.
- Taberlet, P., Coissac, E., Hajibabaei, M. and Rieseberg, L. H. (2012). Environmental DNA. *Molecular Ecology* **21**: 1789-1793.
- Teillard, F., Antoniucci, D., Jiguet, F. and Tichit, M. (2014). Contrasting distributions of grassland and arable birds in heterogenous farmlands: Implications for conservation. *Biological Conservation* **176**: 243-251.
- Thomas, M. B., Wratten, S. D. and Sotherton, N. W. (1991). Creation of island habitats in farmland to manipulate beneficial arthropods: predator densities and emigration. *Journal of Applied Ecology* **28**: 906-917.
- Thomas, S. R., Goulson, D. and Holland, J. M. (2001). Resource provision for farmland gamebirds: the value of beetle banks. *Annals of Applied Biology* **139**: 111-118.
- Thomas, R. and the Guidebook Development Team. (2017). *Data Analysis with R statistical software: A Guidebook for Scientists*. Eco-Explore, UK.
- Thomson, D. L., Baillie, S. R. and Peach, W. J. (1997). The demography and age-specific annual survival of song thrushes during periods of population stability and decline. *Journal of Animal Ecology* **66**: 414-424.
- Thomson, D. L., Green, R. E., Gregory, R. D. and Baillie, S. R. (1998). The widespread declines of songbirds in rural Britain do not correlate with the spread of their avian predators. *Proceedings of the Royal Society of London B* **265**: 2057-2062.

- Tinbergen, J. M., and Boerlijst, M. C. (1990). Nestling Weight and Survival in Individual Great Tits (*Parus major*). *Journal of Animal Ecology* **59**(3): 1113-1127
- Topping, C. J. and Sunderland, K. D. (1992). Limitations to the use of pitfall traps in ecological studies exemplified by a study of spiders in a field of winter wheat. *Journal of Applied Ecology* **29**: 485-491.
- Török, J. (1981). Food composition of nestling blackbirds in an oak forest bordering on an orchard. *Opuscula Zoologica (Budapest)* **17**: 145-156.
- Török, J. (1985). Comparative ecological studies on Blackbird and Song Thrush populations. I. Nutritional ecology. *Opuscula Zoologica (Budapest)* **21**: 105-135.
- Török, J. and Ludvig, É. (1988). Seasonal changes in foraging strategies of nesting blackbirds (*Turdus merula* L.). *Behavioral Ecology and Sociobiology* **22**: 329-333.
- Török, J., Hegyi, G., Toth, L. and Konczey, R. (2004). Unpredictable food supply modifies costs of reproduction and hampers individual optimization. *Oecologia* **141**: 432-443.
- Traugott, M., Schallhart, N., Kaufmann, R. and Juen, A. (2008). The feeding ecology of elaterid larvae in central European arable land: new perspectives based on naturally occurring stable isotopes. *Soil Biology and Biochemistry* **40**: 342-349.
- Traugott, M., Kamenova, S., Ruess, L., Seeber, J. and Plantegenest, M. (2013). *Empirically Characterising Trophic Networks. Ecological Networks in an Agricultural World*. 177-224.
- Tscharntke, T., Klein, A. M., Kruess, A., Steffan-Dewenter, I. and Thies, C. (2005). Landscape perspectives on agricultural intensification and biodiversity - ecosystem service management. *Ecology Letters* **8**: 857-874.
- Van der Most, P. J., de Jong, B., Parmentier, H. K. and Verhulst, S. (2011). Trade-off between growth and immune function: a meta-analysis of selection experiments. *Functional Ecology* **25**: 74-80.
- Van Zwieten, L., Rust, J., Kingston, T., Merrington, G. and Morris, S. (2004). Influence of copper fungicide residues on occurrence of earthworms in avocado orchard soils. *Science of the Total Environment* **329**: 29-41.
- Vasseur, C., Joannon, A., Aviron, S., Burel, F., Meynard, J. M. and Baudry, J. (2013). The cropping systems mosaic: How does the hidden heterogeneity of agricultural landscapes drive arthropod populations? *Agriculture, Ecosystems and Environment* **166**: 3-14.
- Vaughan, I. P., Gotelli, N. J., Memmott, J., Pearson, C. E., Woodward, G. and Symondson, W. O. (2018). eonullnetr: An r package using null models to analyse the structure of ecological networks and identify resource selection. *Methods in Ecology and Evolution* **9**: 728-733.
- Vestheim, H. and Jarman, S. N. (2008). Blocking primers to enhance PCR amplification of rare sequences in mixed samples - a case study on prey DNA in Antarctic krill stomachs. *Frontiers in Zoology* **5**: 12.
- Vickery, J.A., Feber, R.E. and Fuller, R.J. (2009). Arable field margins managed for biodiversity conservation: A review of food resource provision for farmland birds. *Agriculture, Ecosystems & Environment* **133**: 1-13.

- Vickery, J. A., Tallowin, J. R., Feber, R. E., Asteraki, E. J., Atkinson, P. W., Fuller, R. J. and Brown, V. K. (2001). The management of lowland neutral grasslands in Britain: effects of agricultural practices on birds and their food resources. *Journal of Applied Ecology* **38**: 647-664.
- Vickery, J., Carter, N. and Fuller, R. J. (2002). The potential value of managed cereal field margins as foraging habitats for farmland birds in the UK. *Agriculture, Ecosystems and Environment* **89**: 41-52.
- Vickery, J. and Arlettaz, R. (2012). The importance of habitat heterogeneity at multiple scales for birds in European agricultural landscapes. In Fuller, R. (Ed.) *Birds and Habitat: Relationships in Changing Landscapes* (Ecological Reviews 177-204). Cambridge University Press, Cambridge.
- Vickery, J. A., Ewing, S. R., Smith, K. W., Pain, D. J., Bairlein, F., Škorpirová, J. and Gregory, R. D. (2014). The decline of Afro-Palaeartic migrants and an assessment of potential causes. *Ibis* **156**: 1-22.
- Waap, S., Symondson, W. O. C., Granadeiro, J. P., Alonso, H., Serra-Goncalves, C., Dias, M. P. and Catry, P. (2017). The diet of a nocturnal pelagic predator, the Bulwer's petrel, across the lunar cycle. *Scientific Reports* **7**: 1384.
- Walker, L.K., Morris, A.J., Cristinacee, A., Dadam, D., Grice, P.V., and Peach, W.J. (2018). Effects of higher-tier agri-environment scheme on the abundance of priority farmland birds. *Animal Conservation* **21**: 183-192.
- Walrant, A. and Loreau, M. (1995). Comparison of Isoenzyme Electrophoresis and Gut Content Examination for Determining the Natural Diet of the Groundbeetle Species *Abax ater* (Coleoptera: Carabidae). *Entomologia Generalis* **19**: 253-253.
- Wang, Y. I., Naumann, U., Wright, S. T. and Warton, D. I. (2012). mvabund—an R package for model-based analysis of multivariate abundance data. *Methods in Ecology and Evolution* **3**: 471-474.
- Warton, D. I., Wright, S. T., and Wang, Y. (2012). Distance- based multivariate analyses confound location and dispersion effects. *Methods in Ecology and Evolution* **3**:89– 101
- Weibull, A. C., Bengtsson, J., and Nohlgren, E. (2000). Diversity of butterflies in the agricultural landscape: the role of farming system and landscape heterogeneity. *Ecography* **23**: 743-750.
- Weibull, A. C., Östman, Ö. and Granqvist, Å. (2003). Species richness in agroecosystems: the effect of landscape, habitat and farm management. *Biodiversity and Conservation* **12**: 1335-1355.
- Wernham, C. V. and Bryant, D. M. (1998). An experimental study of reduced parental effort and future reproductive success in the puffin, *Fratercula arctica*. *Journal of Animal Ecology* **67**: 25-40.
- Westbury, D. B., Woodcock, B. A., Harris, S. J., Brown, V. K. and Potts, S. G. (2017). Buffer strip management to deliver plant and invertebrate resources for farmland birds in agricultural landscapes. *Agriculture, Ecosystems and Environment* **240**: 215-223.

- Whelan, C. J., Şekerciöglu, Ç. H. and Wenny, D. G. (2015). Why birds matter: from economic ornithology to ecosystem services. *Journal of Ornithology* **156**: 227-238.
- Whitehorn, P.R., O'Connor, S., Wackers, F.L., Goulson, D. (2012). Neonicotinoid pesticide reduces bumble bee colony growth and queen production. *Science* **336**: 351–352.
- Whitfield, S. and Marshall, A. (2017). Defining and delivering ‘sustainable’ agriculture in the UK after Brexit: interdisciplinary lessons from experiences of agricultural reform. *International Journal of Agricultural Sustainability* **15**: 501-513
- Whittingham, M. J. and Evans, K. L. (2004). The effects of habitat structure on predation risk of birds in agricultural landscapes. *Ibis* **146**: 210-220.
- Whittingham, M. J. and Markland, H. (2002). The influence of substrate on the functional response of an avian granivore and its implications for farmland bird conservation. *Oecologia* **130**: 637–644.
- Whittingham, M. J., Stephens, P. A., Bradbury, R. B. and Freckleton, R. P. (2006). Why do we still use stepwise modelling in ecology and behaviour? *Journal of Animal Ecology* **75**: 1182-1189.
- Wiebe, K. L. and Bortolotti, G. R. (1995). Egg size and clutch size in the reproductive investment of American kestrels. *Journal of Zoology* **237**: 285-301.
- Wiens, J. A. (1989). Spatial Scaling in Ecology. *Functional Ecology* **3**: 385-397
- Wilkinson, N. I., Wilson, J. D. and Anderson, G. Q. A. (2012). Agri-environment management for corncrake *Crex crex* delivers higher species richness and abundance across other taxonomic groups. *Agriculture, Ecosystems and Environment* **155**: 27-34.
- Williams, R. J. and Martinez, N. D. (2000). Simple rules yield complex food webs. *Nature* **404**: 180.
- Wilson, J., Evans, J., Browne, S. and King, J. (1997). Territory Distribution and Breeding Success of Skylarks *Alauda arvensis* on Organic and Intensive Farmland in Southern England. *Journal of Animal Ecology* **34**: 1462–1478.
- Wilson, J. D., Morris, A. J., Arroyo, B. E., Clark, S. C. and Bradbury, R. B. (1999). A review of the abundance and diversity of invertebrate and plant foods of granivorous birds in northern Europe in relation to agricultural change. *Agriculture, Ecosystems and Environment* **75**: 13-30.
- Wilson, J. D. (2001). Foraging habitat selection by skylarks *Alauda arvensis* on lowland farmland during the nestling period. In: Donald, P. F. and Vickery, J. A. (Eds.) *Ecology and Conservation of Skylarks Alauda arvensis*. RSPB, Sandy.
- Wilson, J. D., Whittingham, M. J. and Bradbury, R. B. (2005). The management of crop structure: a general approach to reversing the impacts of agricultural intensification on birds? *Ibis* **147**: 453-463.
- Wilson, J., Evans, A. and Grice, P. (2009) *Bird Conservation and Agriculture*. Cambridge University Press, Cambridge.

- Wilson, J. J. (2010). Assessing the value of DNA barcodes and other priority gene regions for molecular phylogenetics of Lepidoptera. *PLoS One* **5**: e10525.
- Winqvist, C., Bengtsson, J., Aavik, T., Berendse, F., Clement, L. W., Eggers, S., Fischer, C. *et al.* (2011). Mixed effects of organic farming and landscape complexity on farmland biodiversity and biological control potential across Europe. *Journal of Applied Ecology* **48**: 570-579.
- Wolters, V., Bengtsson, J., and Zaitsev, A.S., (2006). Relationship among the species richness of different taxa. *Ecology* **87**: 1886–1895.
- Wood, S. (2011). gamm4: Generalized additive mixed models using mgcv and lme4. R package version 0.1-3. <https://cran.r-project.org/web/packages/gamm4/index.html>
- Wretenberg, J., Lindström, Å., Svensson, S., Thierfelder, T. and Pärt, T. (2006). Population trends of farmland birds in Sweden and England: similar trends but different patterns of agricultural intensification. *Journal of Applied Ecology* **43**: 1110-1120.
- Wright, J., Both, C., Cotton, P. A. and Bryant, D. (1998). Quality vs. quantity: energetic and nutritional trade-offs in parental provisioning strategies. *Journal of Animal Ecology* **67**: 620-634.
- Yu, D. W., Ji, Y., Emerson, B. C., Wang, X., Ye, C., Yang, C. and Ding, Z. (2012). Biodiversity soup: metabarcoding of arthropods for rapid biodiversity assessment and biomonitoring. *Methods in Ecology and Evolution* **3**: 613-623.
- Zduniak, P. (2005). Forced regurgitation with tartar emetic as an effective and safe method to study diet composition in hooded crow nestlings. *European Journal of Wildlife Research* **51**: 122-125.
- Zeale, M. R., Butlin, R. K., Barker, G. L., Lees, D. C. and Jones, G. (2011). Taxon-specific PCR for DNA barcoding arthropod prey in bat faeces. *Molecular Ecology Resources* **11**: 236-244.
- Zhang, D. X. and Hewitt, G. M. (1997). Assessment of the universality and utility of a set of conserved mitochondrial COI primers in insects. *Insect Molecular Biology* **6**: 143-150.
- Zickovich, J. M. and Bohonak, A. J. (2007). Dispersal ability and genetic structure in aquatic invertebrates: a comparative study in southern California streams and reservoirs. *Freshwater Biology* **52**: 1982-1996.
- Zuur, A. F., Ieno, E. N. and Elphick, C. S. (2010). A protocol for data exploration to avoid common statistical problems. *Methods in Ecology and Evolution* **1**: 3-14.

“A good thesis is a finished thesis!”

Robert J. Thomas