

# **Decarbonising Fishery Ports Through Smart Cluster Energy Systems**

**Ateyah Ahmed Alzahrani**

**A thesis presented for the degree of Doctor of  
Philosophy**



**School of Engineering**

**Cardiff University**

**September 2021**

# Abstract

The rising energy prices at seaports and fishing industries pose a major challenge because the pace of work and high demand for fish products has increased dramatically. This comes at a time of growing international pressure and global motivations to address climate change and reduce carbon emissions in many different sectors of the economy.

In the literature review, a few research studies were found to highlight the optimal use of power energy in ports, while some studies proposed certain measures that contribute to some extent to reducing energy consumption and carbon emissions. However, there is an absence of a study that discusses the possibility of developing a holistic energy analysis and management that can be scaled from a site to a community level to achieve economically and environmentally viable benefits to the community.

The research study that is described in this thesis aims to develop a comprehensive integrated system for the optimal use of energy in seaports through the development of a smart grid system that is based on the renewable energy at Milford Haven Port, which was developed and used as an applied case study. It is hoped that this study will contribute to reducing energy prices and that the port will achieve economic benefits by sharing its surplus power with the national grid.

A five-stage research methodology has been developed, starting with the process of collecting and analysing data on fishery buildings, known as an energy audit. It then develops energy simulation models at the port using energy simulation software. The next stage aims to propose a smart grid model at multi-levels, namely a building, port and a community of 200 houses around a fishery port. The next stage consists of the development of two smart decision-making systems: the first aimed at sharing surplus power with the neighbours of the port through a Peer

---

to Peer (P2P) energy sharing approach; and the second aims to achieve financial incomes for the port by selling surplus power to the national grid when energy prices rise, a price-based control strategy is used in this system

The model was developed and tested within 24 hours on randomly selected days during the four seasons of the year. The simulation was characterised by the fact that it was carried out instantaneously to get an accurate result, which resembles a real-life system. In addition, the optimal number of energy storage systems was determined at multi-levels, which achieve the self-sufficiency of the electric power that is needed to meet the energy demand during the day.

Finally, a proposed road map has been developed to achieve nearly zero carbon fishery ports that can be applied to different ports in different locations.

# Contents

Summary	i
List of figures	xi
List of tables	xii
Acknowledgements	xiii
List of Publication	xiv
Acronyms	xv
1 Introduction	1
Introduction	1
1.1 Background . . . . .	1
1.2 Key drivers for addressing climate agenda . . . . .	3
1.2.1 Global motivation toward decarbonisation . . . . .	3
1.2.2 Introduction of distributed renewable energy sources . . . . .	5
1.2.3 Energy decentralisation . . . . .	6
1.2.4 Energy market . . . . .	7
1.2.5 Industry 4.0 . . . . .	9
1.3 The case of seaports . . . . .	10
1.4 Problem Statement . . . . .	12
1.5 Research Questions and Objectives . . . . .	12
1.6 Contributions . . . . .	13
1.7 Thesis Outline . . . . .	14



2	Literature Review	17
	Literature Review	17
2.1	Introduction . . . . .	17
2.2	Key findings of related research studies on decarbonising seaports	18
2.2.1	Carbon reduction . . . . .	20
2.2.2	Renewable energy adoption . . . . .	25
2.2.3	Cost optimisation . . . . .	29
2.2.4	Adoption of smart control technologies . . . . .	30
2.2.5	Regulatory landscape for greening seaports . . . . .	33
2.2.6	Best practice guidelines for smart green ports . . . . .	34
2.3	Evolution of the seaport environmental regulatory landscape . . .	35
2.4	Previous projects that focused on decarbonising seaports and terminals . . . . .	38
2.5	Smart port approach . . . . .	40
2.6	The impact of energy systems in decarbonisation of seaports . . .	44
2.6.1	Centralised energy system . . . . .	44
2.6.2	Decentralised energy system (DES) . . . . .	47
2.6.3	Energy storage system . . . . .	50
2.6.4	Summary . . . . .	55
2.7	The key components to greening seaports . . . . .	55
2.7.1	Background . . . . .	55
2.7.2	Smart grid . . . . .	56
2.7.3	Microgrid . . . . .	59
2.7.4	Virtual power plant . . . . .	62
2.7.5	Net zero energy building (NZEB) . . . . .	63
2.7.6	Artificial intelligence . . . . .	64
2.7.7	Information and communication technology . . . . .	65
2.7.8	Internet of Things . . . . .	66
2.7.9	Summary . . . . .	66
2.8	Energy analysis and simulation techniques . . . . .	67
2.8.1	Overview . . . . .	67
2.8.2	Energy auditing . . . . .	68

## CONTENTS

---

2.8.3	Modeling and simulation of an energy system . . . . .	70
2.8.4	Scheduling appliances technique . . . . .	73
2.8.5	Applied Real decision-making systems for Energy Management systems . . . . .	75
2.9	The current status of Energy use at fishery Ports . . . . .	76
2.9.1	Energy cost . . . . .	77
2.9.2	The challenges of energy use for fish industries . . . . .	78
2.10	Gap identification . . . . .	79
2.10.1	The lack of total lifecycle approach to seaports decarbonisation . . . . .	80
2.10.2	The lack of semantic-based modelling, forecasting and optimisation of seaports energy systems . . . . .	81
2.10.3	The lack of secure and reliable seaport energy services . . . . .	83
2.10.4	The lack of a transition towards prosumer-driven seaport energy communities . . . . .	84
2.11	Summary . . . . .	85
3	Methodology . . . . .	88
	Methodology . . . . .	88
3.1	Introduction . . . . .	88
3.1.1	Research methodology approach . . . . .	88
3.1.2	Refined scope of the research . . . . .	90
3.2	Case study design and implementation . . . . .	91
3.2.1	Problem based industrial case . . . . .	91
3.3	Case study design and implementation . . . . .	95
3.3.1	Simulation-based energy analysis at the district level . . . . .	95
3.3.2	Simulation-based energy optimisation at district level . . . . .	96
3.4	Research structure . . . . .	100
3.4.1	Phase one . . . . .	100
3.4.2	Phase two . . . . .	101
3.4.3	Phase three . . . . .	102
3.5	Conclusion . . . . .	102

4	Energy modeling and simulation of a Fishery Port	104
	Energy modeling and simulation of a Fishery Port	104
4.1	Modelling approach . . . . .	104
4.2	Energy simulation programs . . . . .	109
4.2.1	DesignBuilder . . . . .	109
4.2.2	EnergyPlus . . . . .	110
4.2.3	Building Control Virtual Test Bed (BCVTB) . . . . .	111
4.3	Implementing the simulation model . . . . .	112
4.3.1	Energy modeling for fish processing industries . . . . .	112
4.3.2	Co-Simulation of energy systems at fish processing industries in MHPA . . . . .	119
4.4	Initial insights . . . . .	124
4.4.1	Simulation results . . . . .	124
4.4.2	Integrating buildings with the solar farm using BCVTB . . .	125
4.4.3	Result of optimising schedules in Packaway . . . . .	126
4.5	Discussion and Conclusion . . . . .	130
5	Developing a micro-grid for a Fishery Port at multi-level	135
	Developing a micro-grid for a Fishery Port at multi-level	135
5.1	Introduction . . . . .	135
5.2	Methodological approach to modelling and simulating a micro-grid in a fishery port . . . . .	136
5.3	Modeling and implementing a micro-grid in the selected case study (Building level) . . . . .	138
5.3.1	Load profile (building Level) . . . . .	140
5.3.2	PV power supply . . . . .	141
5.3.3	Grid connection . . . . .	143
5.3.4	Energy storage (battery system) . . . . .	143
5.3.5	Charge/discharge control algorithm . . . . .	145
5.3.6	Implementation of a micro-grid in the selected case study	147
5.4	Scaling up the micro-grid at a fishery port . . . . .	148
5.5	Scaling up a micro-grid to promote energy community sharing . .	152

## CONTENTS

---

5.6	Results and Discussion . . . . .	154
5.6.1	Micro-grid at building level . . . . .	154
5.6.2	Scale-up Micro-grid at Fishery port level . . . . .	159
5.6.3	Scale-up Micro-grid to promote energy community sharing	160
5.7	Conclusion . . . . .	162
6	Optimal control strategies for Fishery ports micro-grids	165
	Optimal control strategies for Fishery ports micro-grids	165
6.1	Energy community entities at fishery port . . . . .	165
6.2	Developing real-time decision making to promote nearly zero carbon fishery port . . . . .	167
6.2.1	Smart control based pricing . . . . .	168
6.2.2	Smart control of P2P energy sharing . . . . .	168
6.3	Results and discussion . . . . .	170
6.3.1	Optimise energy use by applying the price-based control strategy . . . . .	172
6.3.2	Optimise energy use by integrating the energy storage capacity of electric boats . . . . .	173
6.3.3	Optimise energy use with P2P energy sharing control strategy	174
6.4	Conclusions . . . . .	176
7	Conclusion and Future works	177
	Conclusion and Future works	177
7.1	Research findings . . . . .	177
7.1.1	Developing simulation capability at fishery port . . . . .	178
7.1.2	Deploy and implement micro-grid at fishery port . . . . .	179
7.1.3	Promote real-time decision making toward decarbonizing seaports . . . . .	180
7.1.4	Revisiting the Hypothesis . . . . .	181
7.2	Contribution to the Body of Knowledge . . . . .	182
7.3	Limitations and challenges . . . . .	183
7.4	Future work . . . . .	183

## CONTENTS

---

7.4.1	Total life-cycle approach to seaports decarbonisation . . .	184
7.4.2	Semantic-based modelling, forecasting and optimization of seaports energy systems . . . . .	185
7.4.3	Secure and reliable seaports energy services . . . . .	186
7.4.4	Transition towards Prosumer-driven seaport energy com- munities . . . . .	187
7.4.5	Propose roadmap for delivering a zero carbon fishery port with an energy community . . . . .	188
7.4.6	Develop a smart decision making system to deliver a zero carbon fishery port . . . . .	194
A	Appendix	241
	Appendix	241

# List of Figures

1.1	Global carbon emissions since 1970 to 2016 . . . . .	2
1.2	The Total Global Primary Energy Supply between 1992-2018 . . . . .	2
1.3	Global renewable energy capacity from 2001 to 2018 . . . . .	6
1.4	Energy market layout . . . . .	8
2.1	The phases of the review process . . . . .	20
2.2	Timeline of the main motivations for decarbonisation in the UK . . . . .	36
2.3	A comparison between traditional seaports and smart ports . . . . .	43
2.4	Centralised power system paradigm . . . . .	47
2.5	Main Distributed Generation Technologies . . . . .	49
2.6	The Fundamental Concept of Energy Storage . . . . .	51
2.7	Applicable power range and discharge power duration of different energy storage type . . . . .	52
2.8	A comparison between cost and capacity between different energy storage technologies . . . . .	53
2.9	Battery storage system . . . . .	54
2.10	The seven domains of smart grid component based on NIST . . . . .	58
2.11	The interaction between smart grid technologies in a power system . . . . .	59
2.12	The structure of a microgrid with DER . . . . .	61
2.13	The fundamentals of a NZEB design . . . . .	64
2.14	The proposed seaport data space architecture . . . . .	67
2.15	Energy auditing phases . . . . .	69
2.16	HVAC scheduling types . . . . .	74
3.1	The Research Onion . . . . .	89
3.2	Milford Haven Port Authority . . . . .	94

## LIST OF FIGURES

---

3.3	The process of modeling and simulation using DesignBuilder and EnergyPlus . . . . .	96
3.4	Input Output variables for a smart grid model using simulink . . .	97
3.5	Input output variables for a smart grid model based on control price	99
3.6	Input output variables for a smart grid model based P2P power sharing . . . . .	99
3.7	The Main Methodology of Research for the Scope of this Thesis .	103
4.1	Modelling and simulation using DesignBuilder and EnergyPlus . .	105
4.2	Modelling and simulation using DesignBuilder and EnergyPlus . .	106
4.3	Input Output data for simulation container using DesignBuilder and EnergyPlus . . . . .	107
4.4	Interface between energy models and power generation sources using BCVTB . . . . .	108
4.5	The Process of simulation in DesignBuilder . . . . .	109
4.6	Energy simulation process of EnergyPlus software . . . . .	110
4.7	The process of integration multi software in BCVTB platform . . .	111
4.8	Packaway building model using DesignBuilder . . . . .	114
4.9	K Shed model . . . . .	116
4.10	M Shed model . . . . .	116
4.11	F Shed model . . . . .	117
4.12	J Shed model . . . . .	118
4.13	Solar Farm . . . . .	119
4.14	The conceptual integration between power demand and supply within the energy cluster . . . . .	122
4.15	Integrating power supply and demand in BCVTB . . . . .	123
4.16	Total power consumption of the buildings in the Milford Haven port	125
4.17	Simulation based optimisation BCVTB . . . . .	127
4.18	Result of integrating buildings with the solar farm in BCVTB . . . .	128
5.1	Grid component for the fishery industry . . . . .	137
5.2	Input Output variables for a smart-grid model using Simulink . . .	139
5.3	3D-model of Packaway building in Milford Haven . . . . .	140

## LIST OF FIGURES

---

5.4	PV generation model in SIMULINK platform . . . . .	143
5.5	Infinity grid model in SIMULINK platform . . . . .	144
5.6	Battery model in the SIMULINK platform . . . . .	145
5.7	Control charge algorithm using main storage system . . . . .	146
5.8	Control charge algorithm using main storage system and backup storage . . . . .	147
5.9	Simulation models of the buildings in the port of Milford Haven .	149
5.10	Control charge strategy for industries and the local community . .	151
5.11	Control charge algorithm using main storage system . . . . .	153
5.12	Optimising energy use with the micro-grid model . . . . .	155
5.13	Micro-grid system . . . . .	156
5.14	State of charge for four seasons [ a- winter, b-spring, c-summer, d-autumn] . . . . .	158
5.15	The simulation results when integrating industries in the fishery port with the solar farm . . . . .	160
5.16	Simulation results for the expanded energy community around fish- ery port . . . . .	162
6.1	The grid energy community at fish industry . . . . .	167
6.2	P2P energy sharing architecture and components . . . . .	170
6.3	Optimising energy cost using the price-based control strategy . . .	173
6.4	Optimising energy use when using electric boat battery storage .	174
6.5	Optimising energy use based on a P2P energy sharing control strategy	175
7.1	Roadmap for Delivering a Zero Carbon Fishery Port with Energy Community . . . . .	190



# List of Tables

2.1	Carbon reduction studies in Seaports . . . . .	21
2.2	Previous studies on greening seaports . . . . .	31
2.3	Previous studies on greening seaports . . . . .	32
2.4	List of projects investigating green seaports and port activities . .	41
2.5	The estimated energy usage and expenses at fish industries - UK .	78
3.1	Related Studies . . . . .	92
4.1	The comparison between the actual and simulation result of Pack- away . . . . .	126
4.2	Impact of energy consumption per appliance . . . . .	128
4.3	The appliance usage list in the Packaway building . . . . .	129
4.4	Optimized appliances schedules for the Packaway Building . . . .	130
4.5	Comparison between model and actual data for the Packaway build- ing . . . . .	132
5.1	List of the main appliances in Packaway building . . . . .	141
5.2	Optimum battery size trials for smart energy community . . . . .	163

# Acknowledgements

First of all, I thank Allah Almighty for making it easy for me to study a PhD at Cardiff University.

I extend my thanks and appreciation to all those who helped me in my studies, foremost of whom was his Excellency Professor Yacine Rezgui, who stood with me, and who gave and refined my scientific research skills!

I also extend my heartfelt thanks to Dr. Ioan Petri and Dr. Ali Ghoroghi for their help and guidance in my PhD journey.

I also wish to thank the piSCES Project team for providing access for data to research and development in my PhD.

I also would like to thank my friends at BRE Centre for Sustainable Engineering who support me during my study.

I would especially like to thank His Excellency Major General Dr. Saud Al-Shehri for his continuous support in scientific research and various fields of knowledge.

I sincerely thank my beloved mother, my brothers and sisters, and my dear wife, Najmah al-Muslim, who stood with me during my PhD trip, and all my friends who supported me and stood with me during my PhD Journey.

I also send this gift to my sons Ahmed, Ammar and Moaath. I ask Allah to see them as distinguished, carrying the flag of knowledge and excellence, and looking forward to a promising future full of excitement and challenges.

# List of Publication

## Conference papers

1. Alzahrani, A., Petri, I. and Rezgui, Y., 2020. Analysis and simulation of smart energy clusters and energy value chain for fish processing industries. *Energy Reports*, 6, pp.534-540.
2. Alzahrani, A., Petri, I. and Rezgui, Y., 2019, June. Modelling and implementing smart micro-grids for fish-processing industry. In 2019 IEEE International Conference on Engineering, Technology and Innovation (ICE/ITMC) (pp. 1-8). IEEE.
3. Alzahrani, A., Petri, I. and Rezgui, Y., 2021, June. Optimal Control Based Price strategies for Smart Fishery ports Micro-Grids. In 2021 IEEE International Conference on Engineering, Technology and Innovation (ICE/ITMC) (pp. 1-8). IEEE. (paper accepted)

## Journal papers

1. Alzahrani, A., Petri, I., Rezgui, Y. and Ghoroghi, A., 2020. Developing Smart Energy Communities around Fishery Ports: Toward Zero-Carbon Fishery Ports. *Energies*, 13(11), p.2779.
2. Petri, I., Alzahrani, A., Reynolds, J. and Rezgui, Y., 2020. Federating Smart Cluster Energy Grids for Peer-to-Peer Energy Sharing and Trading. *IEEE Access*, 8, pp.102419-102435.
3. Alzahrani, A., Petri, I., Rezgui, Y. and Ghoroghi, A., 2021. Decarbonizing seaport: current directions and future research. *Energy Strategy Reviews*. (under progress)

# Acronyms

CO <sub>2</sub>	Carbon Dioxide
COP21	Conference of the Parties
RES	Renewable Energy Sources
EU	European Union
RTG	Rubber Tired Gantries
OPS	Onshore Power Supply
AMS	Automatic Mooring System
EMS	Energy Management System
PV	Photovoltaic
PCD	Seaport Container Distribution
MAS	Multi-Agent System
IPCC	Intergovernmental Panel on Climate Change
WPCI	World Seaport Climate Initiative
GHG	Greenhouse Gas emissions
PEEP	seaport Energy Environmental Plan
Rewec3	Resonant Wave Energy Converter
ISWEC	Inertial Sea Wave Energy Converter
IoT	Internet of Things
UNFCCC	United Nations Framework Convention on Climate Change
RO	Renewable Obligation
NFFO	Non-Fossil Fuel Obligation
FIT	Feed-In Tariff
DER	Distributed Energy Resources
DES	Decentralized Energy System
DG	Distributed Generation
ICT	Information and Communication Technology
VPP	Virtual Power Plant

## LIST OF TABLES

---

DSO	Distribution System Operator
AI	Artificial Intelligence
ANN	Artificial Neural Networks
GA	Genetic Algorithm
FL	Fuzzy Logic
ES	Expert Systems
LCA	Lifecycle Assessment
NIST	National Institute of Standards and Technology
P2P	Peer-to-Peer
BESS	Battery Energy Storage System

# CHAPTER 1

## Introduction

### 1.1 Background

In recent years, there has been a significant change in the earth's climate as result of global warming and an increase in the level of carbon dioxide in the atmosphere [1]. The Intergovernmental Panel on Climate Change (IPCC) reported that there has been a remarkable change in the atmosphere and ocean currents since 1950 [2]. One of the main reasons for climate change is the excessive use of primary energy sources as result of the Industrial Revolution, which has caused a large amount of carbon to be emitted into the atmosphere. Using primary fuel resources such as fossil fuels has caused an increase in Ghg emissions into the atmosphere, which is predicted to lead to global warming, climate change and ozone layer depletion. Figure 1.1 illustrates the rise of global carbon emissions from 1970 to 2016.

The main source of carbon emissions is burning fossil fuels. Fossil fuels are formed from ancient plants and animals that lived on the Earth millions of years ago. Currently, fossil fuels are used to produce energy in cars, generators, trains, planes. The fuel combustion process in engines produces exhaust gases that consist of air pollutants such as Sulphur Dioxide ( $\text{SO}_2$ ), particulate matter (soot), Nitrogen Oxide ( $\text{NO}_x$ ) and a large amount of Carbon Dioxide( $\text{CO}_2$ ) [4].

Energy use is the cornerstone of climate change. Therefore, the basic need to use energy for different purposes in different sectors around the world needs to be taken into consideration. The global demand for primary energy sources has increased due to demographic growth. Meanwhile, the increase in the number of electricity users and the Industrial Revolution in developing countries have contributed significantly to economic growth around the world since the last century .

## 1.1. BACKGROUND

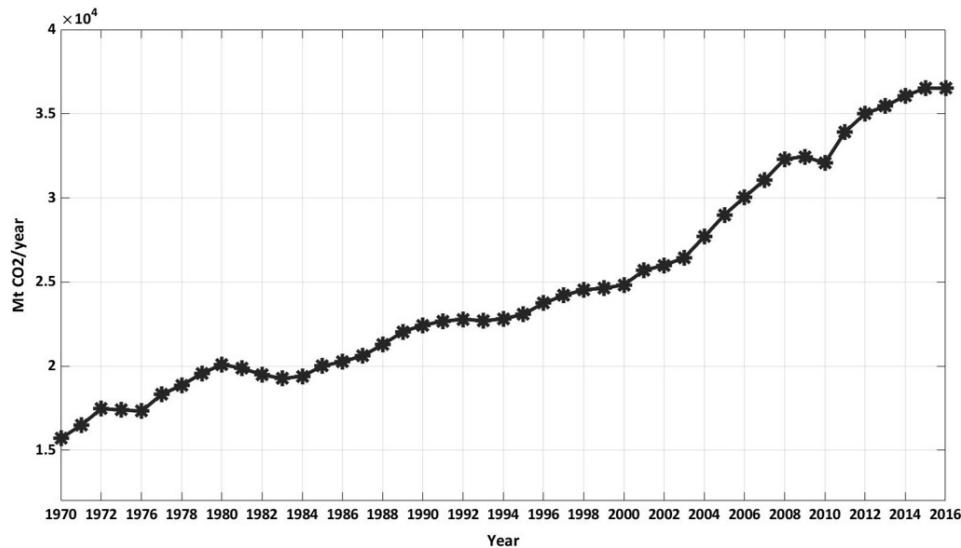

Figure 1.1: Global carbon emissions since 1970 to 2016 [3]

It is expected that the world's need for energy will increase during the next decade because of population growth and increased industrial activities. The industrial sector is predicted to increase its energy consumption by 40 percent by 2040 [5].

Figure 1.2 illustrates the total global primary energy supply from 1990 to 2018.

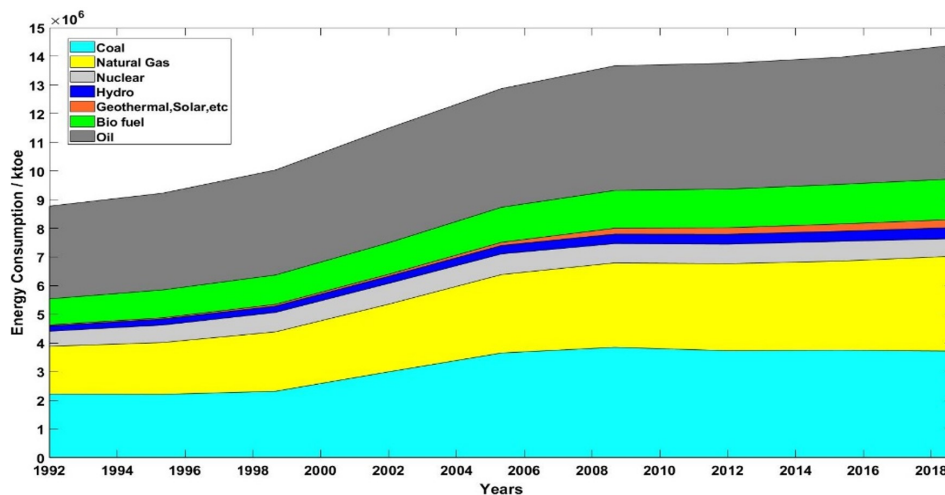

Figure 1.2: The Total Global Primary Energy Supply between 1992-2018 [6]

However, there is need to transition toward clean, affordable and resilient energy sources that will mitigate carbon emissions and limit the effects of global warming. Consequently, governments and countries should act and deal with climate change to limit its impact on the earth and its people. The first steps for international action in dealing with climate change began with the launch of in-

tergovernmental panel on climate change in 1988 [7] . This was followed by the United Nation’s Framework Convention of Climate Change (UNFCCC) in 1994 [8]. In 1997, the Tokyo Protocol was adopted by more than 192 participating countries, which aims to activate and operate the UNFCCC. This led to a commitment from the major industrial and economic countries to reduce carbon emissions. The Tokyo Protocol entered into force in 2005 [9].

Subsequently, 184 countries agreed a plan to combat climate change in Paris in 2015. The majority of decision-makers promised to start making practical steps to eliminate global average temperature changes and reduce emissions, and to increase the utility of renewable energy sources [10]. As a result of the global agreement to tackling climate change, some countries have started to set the rules, legislation and policies of renewable energy to reduce CO<sub>2</sub> emissions and increase the use of renewable energy sources. Annunziata et al. [10], Moya et al. [11] highlighted the main three prospective that governments can use to limit CO<sub>2</sub> emissions, which are the integration of energy efficiency and renewable energy requirements, translate investment in energy savings into economic value, and a commitment towards the “zero-energy buildings” target. In 2016, Moya mentioned that governments need to continuously focus on energy efficiency programs as a successful experience for developing countries to decrease Ghg emissions and save energy [12]. In 1997, the European Union (EU) was one of the first coalitions in the world set targets to reduce CO<sub>2</sub> emissions and increase the use of renewable energy resources [4]. The main objectives of the European Union to tackle climate change are to decrease greenhouse gas emissions, ensure the security of supply and improve EU competitiveness [13].

## 1.2 Key drivers for addressing climate agenda

### 1.2.1 Global motivation toward decarbonisation

Due to increased awareness about global warming and the importance of following a decarbonisation plan at the global level, many countries have started to move towards decarbonisation. In 1990, the US Pollution Prevention Law focused on reducing the amount of pollution using cost-effective changes in a life-cycle process.



## 1.2. KEY DRIVERS FOR ADDRESSING CLIMATE AGENDA

---

This law was applied at government level, including the industrial sector. This law focuses on different criteria to eliminate pollution, such as changing the use of technologies, processes and implementing training to increase energy efficiency and minimise pollution through different applications [14].

In 2011, the Europe Commission published its low carbon roadmap for EU member state, which stated that by 2050 the EU should cut its greenhouse gas emissions by 80-95 percent. To achieve this target, the EU members must increase the level of development and deployment of clean technology [15].

The United Kingdom was one of the first countries to start to implement a long term plan to reduce carbon emissions and increase the use of renewable energy resources. In 1989, the UK aimed to replace fossil fuel by nuclear energy to produce electricity under the Non-Fossil Fuel Obligation (NFFO) [16]. This was followed by the global motivation programme, known as the Climate Change Programme, which aimed to reduce CO<sub>2</sub> emission by 15-18 percent below the 1990 level by 2010 and also reduce overall ghg emission [17].

In 2002, the UK government enacted the new Renewable Obligation (RO). This obligation makes it mandatory for the supplier to secure a specific share of electricity from renewable energy or they have to pay a penalty. Another of these policies has been enacted in 2003 2003/87/EC, known as the Emission Trading Scheme [ETS], which is one of the main tools to reduce ghg emissions in the EU [18]. This scheme limits emissions from more than 11000 heavy energy-using emission in more than 31 countries. The scheme works as a cap and trade mechanism. The cap sets the total amount of ghg that can be emitted by the installation, while the companies receive or trade the emission allowances that can be traded [19]. In 2008, a new act from the government has been introduced related to the dangerous of climate change. This act requires to cut GHG emissions by about 34 percent in 2020 and 80 percent by 2050. The government sets a budget in several periods to achieve the target of decreasing carbon emissions to 2050 [20]. Another important policy that has been applied in Europe since 1980 is the Feed-In-Tariff [FIT], which began to be applied in Denmark, Germany and Italy in 1990 [21].

The concept of [FIT] is “policy pricing, guaranteeing renewable energy generators a fixed price for the electricity they produce”, which will attract considerable

capacity [22]. The FIT's advantage is the guaranteed price, which will allow householders with solar panels to buy power through RE markets. The EU also set a new directive 2001/77/EC to promote electricity production from renewable energy resources [23]. In addition, to increase the deployment and development of RES, the EU in 2009 issued the renewable energy directive 28/2009/EC to promote the use of renewable energy resources with 20 percent of total power production by 2020 [24].

In 2011, a new law was enacted by the EU Commission that required all members to apply the industrial emission directive. This law aims to increase the level of protection of human health and the environment by decreasing the level of industrial emissions in the EU. This law is based on five criteria, as follows: integrated approach, best available techniques, flexibility, environment inspection and public participation [25]. In 2012, the UK set up a new approach that was known as the "Green Deal", which aimed to help homeowners to improve their energy savings and find the best option to pay for them. This was followed in 2014 by a government announcement of a plan to deploy smart meters in homes from 2014 to 2019, which aimed to install more than 53 million smart meters for gas and electricity [26].

### 1.2.2 Introduction of distributed renewable energy sources

The use of renewable energy sources has increased dramatically in different sectors around the world. However, there is a global trend to transition energy use from fossil fuel to renewable energy sources [27], which is hoped to reduce global emissions from burning fossil fuels. In 2016, around 14 percent of the total energy primary supply came from renewable energy supply. However, approximately 70 percent of renewable primary energy supply comes from biomass energy, which was followed by 20 percent from hydro-power [28]. In contrast, the proportion of primary energy supply from geothermal, solar and wind rose gradually from 3.23 percent to 11.66 percent between 1990 and 2016, respectively [29].

The global renewable energy capacity rose by 8.3 percent in 2017. By the end of 2017, the total renewable energy generation capacity was about 2179 Gigawatt. Furthermore, the total amount of renewable energy served off-grid renewable

## 1.2. KEY DRIVERS FOR ADDRESSING CLIMATE AGENDA

power to more than 146 million users [30]. Figure 1.3 demonstrates the global growth of renewable energy generation from 2001 to 2018, by energy source [31].

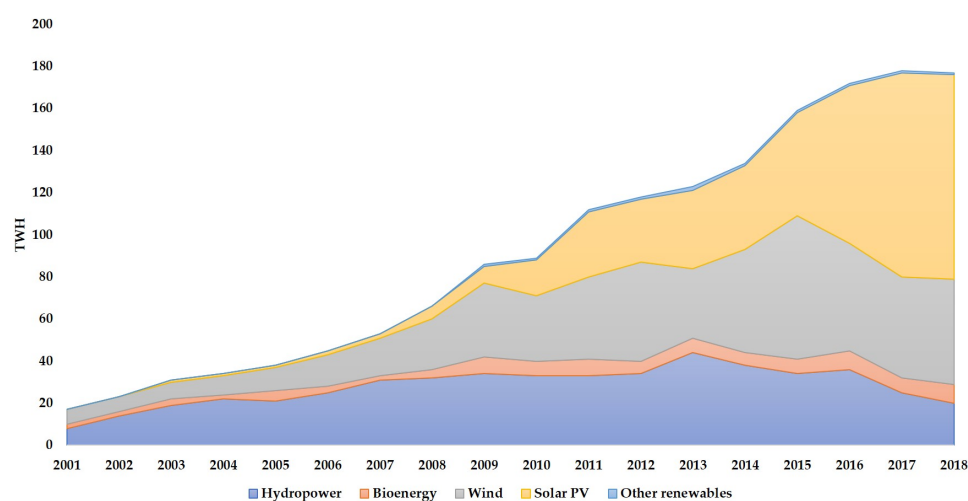

Figure 1.3: Global renewable energy capacity from 2001 to 2018 [31]

### 1.2.3 Energy decentralisation

Originally, Direct Current [DC] power was supplied locally from small power generator units; however, this system suffered from limited units of power voltage. Later, Alternative Current [AC] based power grids were introduced that enabled electricity to be carried over long distances from large power stations (e.g. Drax in the UK), which is known as a centralised energy system [32].

The last decade has witnessed a significant transition of energy policy due to issues such as the limited supply of fossil fuels and global warming, together with an increase in the population growth rate. Consequently, some countries have started to deploy small power generation units to increase the security of supply and to meet power demand, which is known as a decentralised energy system or Distributed Generation. The role of distributed generation is to provide flexibility and reliability to the grid because it uses small sized plants and efficient generation [33]. In addition, distribution energy generation is able to exploit local energy generation resources and install energy storage at local sites [34]. The main energy policies that have been enacted to deploy decentralised energy systems are to deregulate the energy market and tackle climate change. This will help to deploy

decentralised energy systems, as well as increase the competitiveness between entities [35]. Paliwal et al. [36] found that the transition from centralised power generation to decentralised power generation is accelerating. Furthermore, RES integration with a decentralised energy system decreases reliance on depleting fossil fuel, increases security of power supply and reduces carbon emissions.

### 1.2.4 Energy market

The global transition from a regulated to deregulated power market started in the last three decades. However, this transition needs a new system to organise the energy market. Consequently the power exchange and power pool were established to enable energy providers, energy traders and large consumers to participate in energy market to buy or sell energy [37]. In 1989, the UK was the first country in the European Union to privatise its electricity industry, although the action plan to start privatisation electricity industry began in 1990 [38]. Wholesale electricity competition was introduced in 1998 and the whole retail market was deregulated by National Power, which means that all consumers have the freedom to choose their power supply. At that time, the number of electricity customers was about 22 million end-users [39]. The wholesale market is designed to be much like a commodity market. Generators sell electricity to suppliers through bilateral contracts, Over The Counter (OTC) trades and spot markets. In 2010, 91.5 percent of power traded in the UK was OTC traded and about 9 percent was exchange traded. Currently, there are three exchange providers in the UK's electricity markets: the APX GROUP, Nasdaq OMX N2EX and the intercontinental exchange. Figure 1.4 demonstrates the process of Energy market (ICE)) [40].

In 2010, half of the electricity consumed in the UK was produced by the largest three companies. Seven companies had a market share increase of 5 percent. Meanwhile, 68 percent of the retail supply is dominated by the major energy suppliers. Electricity trades every 30 minutes blocks (settlement periods) in the wholesale market and it will continue to 60 minutes before settlement period, which is called gate closure. After the closure gate (National Grid Electricity Transmission and the system operator) are responsible for supply and demand on second-by-second basis. National Grid Electricity Transmission [NGET] assesses the situation

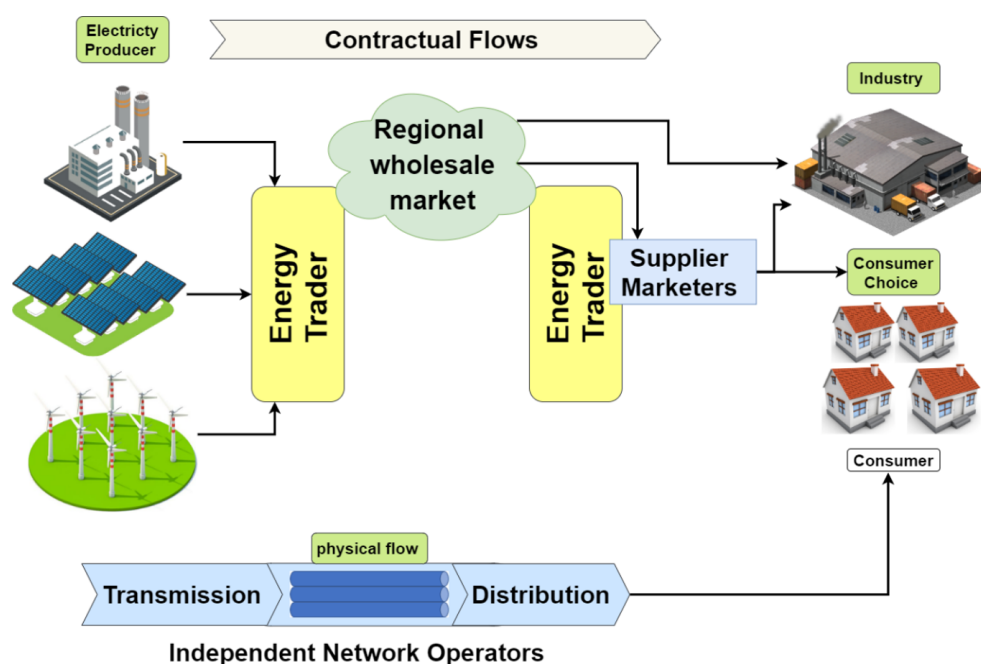

Figure 1.4: Energy market layout [40]

of the system and takes balancing actions, mostly using the balancing mechanism to correct any imbalance [41]. In 1990, the retail electricity supply market opened to competition [42].

Today, six large vertical integrated energy suppliers dominate the retail markets in the United Kingdom, which are Centrica plc, E.On UK, EDF Energy, RWE N Power, Scottish and Southern Power [SSE] and Scottish Power [43]. The National Electricity Transmission System [NETS] is the responsible for transmitting electricity from the generator to the consumers. NETS includes around 25 000 km of high-voltage overhead lines (275) kilo-volts and above in England and Wales, and 132 kilo-volts and above in Scotland and offshore). Regulatory regional monopoly transmission owned and maintained Transmission Onshore Assets [TOs). NGET is considered to be a part of the national grid and in 1995 it was listed on the London Stock Exchange with a multi-ownership base. NGET has the responsibility for ensuring that electricity supply and demand stay in balance and the system in stable with limited technical and operating work [41, 44]. The regulator, Ofgem, was concerned about the security of supply by 2009 and the Labour government reported the decarbonisation of generation and development through the Committee of Climate Change in 2010 [39], as follows:

- Security of supply,
- Low carbon emission from electricity,
- Affordable.

In 2012, the European Union introduced its plan for the future of the European electricity market, including developing, implementation, target model coupling by 2014, and a draft energy bill with policy overview. In the same year, the interconnector between Ireland and Wales started [17].

The Labor government published an energy act in 2013, which focused on decarbonisation of generation and reforms of the electricity market [17]. In 2014, Ofgem proposed market investigation by the competition and market authority [45]. Electricity market reform is a government policy to invest in secure, low-carbon electricity, improve the security of the United Kingdom's electricity supply, and improve affordability for consumers [39]. It will also help to bring forward investment in low-carbon technologies in an affordable, secure and sustainable manner [46].

### 1.2.5 Industry 4.0

The last few years have witnessed radical transformation of the global industrial landscape, due to fast growth of the new generation of technology with smart features that can increase production, minimise the cost and optimise the work environment via different approaches [47]. The Industry 4.0 is a high technology initiative strategy that has been discussed in both research and technical fields after an article published in 2020 by the German government [48]. Industry 4.0 can emerge between the physical and digital worlds through the Cyber Physical System (CPS), which will enhance productivity and efficiency among industries. The new approach will combine among different kinds of new technologies, such as CPSs, the Internet of Things (IoT), Internet of Services (IoS), Robotics, Big Data, Cloud Manufacturing and Augmented Reality [AR] [49]. In addition, integration among these technologies will make factories smarter [50]. The concept of a smart factory refers to different developments in the new generation of the industrial sector based on integration, digitalisation, flexible structures and smart solutions [51].

The combination of software, hardware and machines leads to an improvement in productivity, and reduces waste, cost and unnecessary resources [52]. The IoT will play a vital role in energy management in the industry sector via smart meters, which collect data of energy use in different sectors of industry in real time. This will improve energy efficiency and reduce waste via EMS in smart industry [53, 54, 55].

## 1.3 The case of seaports

Seaports are important contributors to economic growth worldwide [56]. Seaports have always played an important role in facilitating import and export movements between countries, and they have directly contributed to the formation of international trade and global supply chains [57].

As result of the congestion of commercial activities from ships and the operations of lifting and unloading containers, as well as the local presence of fish industries, modern seaports and their surrounding cities have become carbon intensive and have substantial pollution levels [58].

The most polluted cities in the world are all coastal cities, which is exacerbated by the fact that 70 percent of emissions from ships worldwide occur within 400 km from coastal areas [59]. Based on a health board study: (a) the emissions from seaports and ships affects about 19,000 people with lung cancer, while (b) approximately 60,000 die annually from different conditions caused by pollutants [60].

Carbon emissions from ships have increased gradually over time, and are currently estimated at circa 2.7 percent of total CO<sub>2</sub> emissions [61] [62]. The United Nations estimates the annual CO<sub>2</sub> emissions from maritime transport to about 1000 million tonnes [63]. The intensive use of energy from primary sources has led to an increase in the level of carbon emissions. Consequently, there is a pressing need to transition towards clean, affordable and resilient energy systems to help mitigate carbon emissions and limit the effects of global warming [64].

Key milestones in this climate mitigation journey include the 2005 Kyoto protocol [65, 66] and the 2015 COP21 agreement in Paris, where 184 countries agreed to implement practical steps to limit and lower the global average temperature by reducing emissions, as well as increasing reliance on renewable energy [67].

### 1.3. THE CASE OF SEAPORTS

---

As a result of this global agreement, several countries began to establish regulations, legislation and policies to promote the uptake Renewable Energy Sources (RES) [68]. The mitigation methods include: (a) integration of energy efficiency and renewable energy, (b) investments in energy savings, and (c) moving towards zero-energy buildings [10, 11].

The EU has set ambitious objectives to address the climate agenda by: (a) decreasing greenhouse gas emissions, (b) ensuring the security of supply chains, and (c) improving the EU's competitiveness [69]. The fishing industry is one of the main activities of seaports. Food and agriculture organisation studies have also reported that the global human consumption of fish increased dramatically from 1950 to 2012. The proportion of fish processed world-wide increased from 20 million tons to more than 136 million tons, which adds pressure for fish processing industries to use energy from different sources to meet the demand of fishing and for fish processing operations [70, 71].

Several parameters can influence energy usage by the fishing industries, such as: (i) seasonal variations can increase the fishing industry's demand for energy; (ii) the weather can have a significant effect on the total processed fish during a year; and (iii) the number of fisheries and boats can also effect total energy use. Energy use for fish processing industries can have two main operating modes: (i) direct use, such as lighting system, heating and washing machines; and (ii) indirect use, through converting the power to another form of energy, such as cooling cycle and freezing equipment. However, increased energy demand from the fishing industry increases the cost and CO<sub>2</sub> emissions.

Consequently, the fishing industry should move towards more secure, clean and sustainable energy solutions. In this thesis, it argue that the new smart energy systems and techniques that have recently emerged are able to meet the requirements of the fish processing industries and fishery ports through increased use of renewable energy and smart energy management. Seaports are facing increased pressures to reduce their carbon footprint, while increasing their energy efficiency and global competitiveness [72, 73]. Moreover, energy consumption in seaports must be continuously monitored to manage the increasing energy costs, which is reflected in the increased fuel demand [74].



### 1.4 Problem Statement

Fishery buildings at ports use energy-intensive equipment, such as refrigerators, air conditioners and ice making machines. This leads to high energy costs and, indirectly, to an increase of the carbon emissions. Because most fishery buildings are old, there is an urgent requirement to make them more sustainable and achieve economic competitiveness in the energy market. In 2011, fishery buildings consumed about 40 billion litres of fuel and produced 179 million tons of carbon emissions [75]. The traditional design of energy systems at fishery buildings leads to increased energy consumption and carbon emissions. because it lack to new updated of energy efficiency standards that effectively contribute to less energy consumption and produce minimum emissions. Furthermore, the percentage of carbon emissions resulting from fishery buildings is estimated to be 4 percent of the global greenhouse gas emission (GHGS) [10]. Meanwhile, the total human consumption of seafood has increased from 20 million tons in 1950 to more than 136 million tons in 2014 [12]. This rapid growth in seafood consumption has increased carbon emissions as result of intensive energy use by this industry. So, It is crucial to find a smart, sustainable and affordable energy that will help to reduce energy cost and limit carbon emission at fishery buildings.

### 1.5 Research Questions and Objectives

This study aims to reduce the costs and carbon footprint of fishery buildings by developing and testing a new 'smart grid' electricity network. Consequently, this thesis has three main research questions that aim to address this gap, as follows:

- Can a reliable simulation capability be developed that provides real-time accounts of energy demand and use for fishery buildings?
- Can the concept of a smart grid be adopted and applied to energy systems in fishery buildings at multi-levels?
- Can the energy sharing and trading approach be simulated to promote decision-making that reflects the efficiency in fishery buildings?

This thesis aims to reduce carbon emissions from energy networks in fishery buildings by implementing smart energy system technologies.

The first research question is translated to the following objectives:

- Develop an energy model and simulation capability to provide real-time accounts of energy flows in seaports.
- Investigate the potential of local power supplies to meet total power demand in the fish processing industry using a co-simulation platform.

The second research question is translated to the following objective:

- Examine various scenarios for decarbonising seaports by leveraging renewable energy sources, including solar energy and energy storage.

The third research question is translated to the following objective:

- Investigate the role of seaports to address the energy demand of their local communities through energy sharing.

The following research hypothesis is posited: “The concept of Industry 4.0 has the potential to deliver net zero carbon fishery ports by leveraging smart and clean energy generation, use, and storage, while promoting the formation of energy communities within the local ecosystem.” This thesis will apply three different case studies, as follows: fish processing industry, fishery port site and warehouse refrigeration.

## 1.6 Contributions

The main contribution of this study is its focus on minimising the cost and emissions related to energy use by the fishery industries using smart energy systems. The contributions that have been derived from this study include:

1. A thorough and authoritative review of the state-of-the-art research, including past and ongoing initiatives, with the objective to reduce the carbon footprint of seaports. The literature review reveals that existing research leverages recent advances in digital technologies, while focusing on one or several of the following themes: carbon reduction, use of renewable energy resources, cost performance optimisation, deployment of smart control

technologies, regulatory landscape for greening seaports, and implementing green port practices guidelines. As such, this thesis provides a critical review of existing technologies and concepts that promote and contribute to the decarbonisation of seaports, including smart grids and virtual power plants.

2. A reliable simulation capability that provides real-time accounts of energy demand and use, as well as short to medium-term energy projections to understand the complex ecosystem around seaports, including energy systems in use, fish processing activities, local stakeholders, including communities by utilising tools such as DesignBuilder [76], EnergyPlus [77] and Building Control Virtual Test Bed (BCVTB) [78].
3. A simulation model of integration of local solar farm energy in a local energy cluster using a multi-building energy coordination model developed in EnergyPlus and simulate in BCVTB.
4. A smart grid model to explore various scenarios for decarbonising seaports by leveraging renewable energy sources, including solar energy and energy storage, through a smart monitoring control strategy.
5. A smart energy community model around seaports by integrating the smart grid with local community energy storage via developing a simulation-based optimisation strategy.
6. Real-time decision-making strategies that lead seaports and communities around seaports towards decarbonisation through energy sharing and trading.

## 1.7 Thesis Outline

This thesis is structured as follows:

Chapter One discusses the main drivers of applying a smart energy system for the industrial sector and it presents the main problem statement, hypothesis and objectives for the research study.

Chapter Two reviews the previous studies and related works of the application of smart energy systems in fishery ports and fish processing industries. It will

highlight the current status of global energy use in the industrial sectors and it will outline future energy use by industrial sector. This will be followed by a description of the fourth generation of smart energy systems, including the history of energy transition toward decentralisation, distributed generation (DG), renewable energy resources and energy storage systems.

Chapter Three describes the methodology that is used in this thesis, which involves case studies drawn from the EU INTERREG piSCES project (smart energy cluster for the fish processing industry).

Chapter Four discusses energy modeling and simulation at fishery ports. This chapter is based on the first research question, which aims to develop simulation capability at fishery processing industries. The first part will give a brief description of the modeling and simulation of energy systems, focusing on energy modelling for industrial applications. It will then present the follow-up methodology that has been used to answer the question. The next part will describe the simulation software that will be used to simulate fishery port sites. This chapter will then present a simulation of a container implementation for three different pilot sites.

Chapter Five will highlight the implementation of a smart micro grid at building level. A micro-grid system for the fish processing industries with a validation use-case at Milford Haven Port in South Wales, UK has been implemented. The system has been modelled using EnergyPlus and MATLAB with an infinite grid, renewable energy resource, battery and charge/discharge controllers to optimise energy consumption and production, and reduce carbon emissions. Also, this chapter will conduct an energy analysis and modelling for the fishing industries by exploring energy transition, from a building level to an energy community level. It aims to find the optimum balance between the battery storage system and the number of PVs that are required to meet the community's power demands.

Chapter Six investigates the energy usage of a case study fishery port and it evaluates a method to maximise the use of renewable energy sources in these energy clusters via a smart-grid approach, while applying price-based control and peer-to-peer (P2P) power sharing considering optimised trading of energy. It will then develop a roadmap to achieve a nearly zero carbon emission fishery port.

Chapter Seven will re-examine the main research questions and review the

## 1.7. THESIS OUTLINE

---

extent to which they are achieved, as well as discuss the contributions made by this research the field of knowledge. It will also present the most important challenges and obstacles that occurred during the research phase. The most important future trends in reducing carbon emissions in seaports will also be presented, including their impact on the global level.

# CHAPTER 2

## Literature Review

This chapter provides a review of the previous studies and related works for the application of smart energy systems in seaports and fish processing industries. It will highlight the current status of global energy use in the industrial sectors and it will outline future energy use by industrial sector. This will be followed by a description of the fourth generation of smart energy systems, including the history of energy transition toward decentralisation, distributed generation, renewable energy resources and energy storage system. The next section will focus on smart energy management systems including Smart Grid, Micro-Grid, Virtual power plants and Net Zero Energy systems. The following section will review the optimisation techniques of energy in fishery ports and fish processing industries. The next section will focus on energy auditing, modeling and simulation, scheduling appliances and artificial intelligent techniques. The final section will summarise the review and related works, and it will present the gap identification for this research.

### 2.1 Introduction

Seaports are important contributors to economic growth worldwide [56]. Since before the beginning of the Industrial Revolution, seaports have played an important role in facilitating import and export movements between countries. This has directly contributed to the formation of international trade and global supply chains [57]. However, because of the congestion of commercial activities from ships, and the operations of lifting and unloading containers, as well as the local presence of fish industries, seaports and their surrounding cities have become carbon intensive and have experienced substantial pollution levels [58].

The most polluted cities in the world are all coastal cities, which is exacerbated

## 2.2. KEY FINDINGS OF RELATED RESEARCH STUDIES ON DECARBONISING SEAPORTS

---

by the fact that 70 percent of emissions from ships worldwide occur within 400 km from coastal areas [59]. Based on a recent health board study (a) the emissions from seaports and ships lead to about 19,000 annual cases of lung cancer, while (b) approximately 60,000 die every year from conditions caused by pollutants [60]. Carbon emissions from ships have increased gradually over time, and are currently estimated at circa 2.7 percent of total CO<sub>2</sub> emissions [61][62]. The United Nations estimates the annual CO<sub>2</sub> emissions from maritime transport to be about 1000 million tonnes [63]. The intensive use of energy from primary sources has led to an increase in the level of carbon emissions. Consequently, there is a pressing need to transition towards clean, affordable and resilient energy systems to help mitigate carbon emissions and limit the effects of global warming [64].

Key milestones in this climate mitigation journey include the 2005 Kyoto protocol [65, 66] and the 2015 COP21 Paris agreement [79], where 184 countries agreed to implement practical steps to limit and lower the global average temperature by reducing emissions, as well as increasing reliance on renewable energy [67]. As a result of this global agreement, several countries have begun to establish regulations, legislation and policies to promote the uptake of Renewable Energy Sources (RES) [68]. In order to alleviate some of the burden of decarbonisation from the power sector and to reduce potential decarbonisation in end-use sectors, some mitigation methods can be implemented. Mitigation methods include: (a) integration of energy efficiency and renewable energy, (b) investments in energy savings, and (c) moving towards zero-energy buildings. These aim to increase renewable energy use in buildings and industry, encourage shifts to low carbon technologies and fuels, and reduce emissions by optimizing building volume, use, and processes. [10, 11].

## 2.2 Key findings of related research studies on decarbonising seaports

Many seaports are facing increased pressure to reduce their carbon footprint, while increasing their energy efficiency and global competitiveness [72, 73]. Moreover, energy consumption in seaports must be continuously monitored to manage in-

## 2.2. KEY FINDINGS OF RELATED RESEARCH STUDIES ON DECARBONISING SEAPORTS

---

creasing energy costs, as reflected by the increase in fuel demand [74]. This review aims to investigate the global efforts to decarbonise seaports, and it aims to answer the following research questions:

- What are the main drivers for seaports to transition towards becoming green seaports?
- What is the state of the art in delivering the vision of green seaports?
- What are the directions for future research in this seaport decarbonisation journey?

This review relied on leading search engines like Science Direct, Web of Science, Scopus, IEEE and google scholar, to identify related research using a set of keywords, while covering a period of several decades to factor in key evolutions in the decarbonization journey of seaports. An initial list of keywords was selected and then refined to provide a broad perspective to address the posited research questions. The following keywords were eventually retained as providing a comprehensive coverage of the related academic literature: “green seaport”, “marine energy sources”, “fish industries”, “smart energy system”, and “smart seaport”. In the context of this review paper, by “Smart” we refer to the capability of a system to learn and adapt to changing boundary conditions using digital technologies to address multi-objective scenarios, i.e., the capacity of a seaport to factor in environmental, occupancy, and process conditions to reduce energy demand and its carbon footprint. The research methodology involved five steps as illustrated in figure 2.1.

The first step started with the identification of related keywords and then the selection of authoritative research databases to direct the search for related research. This led to the identification of 428 research papers. Next, the authors have filtered the results by excluding dissertations, duplicate articles, patents, and non-English articles. 54 articles were retained as a result of this process. These themes are discussed in the next section.

These themes are discussed in the next section.

Based on the review analysis, six main themes have emerged from the analysis of the selected papers, as listed below:

- Carbon reduction



## 2.2. KEY FINDINGS OF RELATED RESEARCH STUDIES ON DECARBONISING SEAPORTS

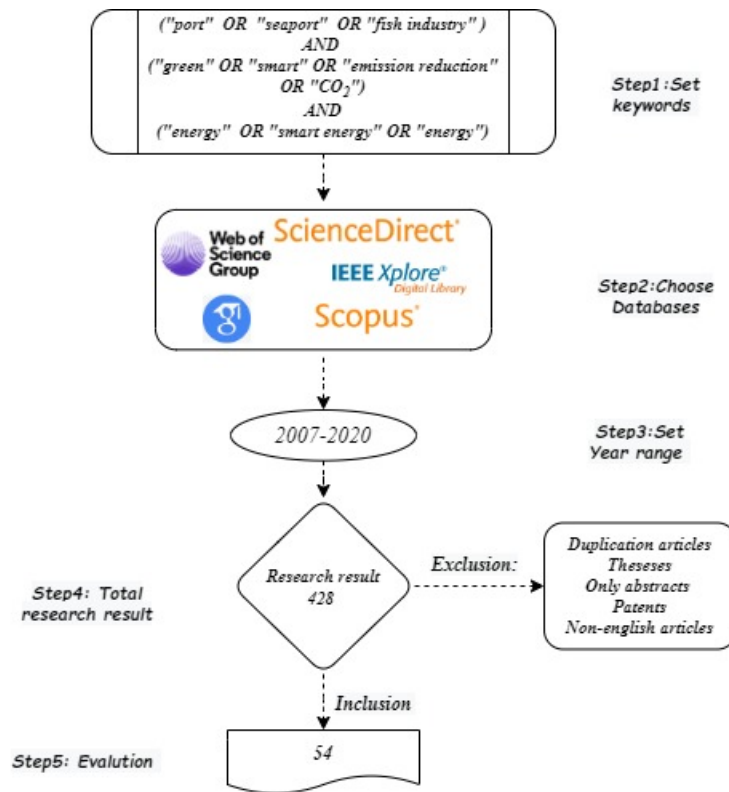

Figure 2.1: The phases of the review process

- Renewable energy adoption
- Cost optimisation
- Adoption of smart control technologies
- Regulatory landscape for greening seaports
- Best practice guidelines for smart green seaports

### 2.2.1 Carbon reduction

The literature search found 35 studies that focused on a reduction of carbon emissions in seaports. These studies can be divided into three categories; the first category focuses on the application and implementation of systems that directly assist in reducing carbon emissions in seaports, the second category focuses on the investigation and analysis of the extent to which some systems can be applied to reduce carbon emissions in seaports, and the third category proposes practices that may help reduce carbon emissions in seaports. Table 2.1 summarized previous studies based on three categories for carbon reduction factor.

## 2.2. KEY FINDINGS OF RELATED RESEARCH STUDIES ON DECARBONISING SEAPORTS

Table 2.1: Carbon reduction studies in Seaports

Category	Methodology		
	Case study	Modeling and simulation	Framework
Category 1	Stoll et al. [80]	Aarsaether and Karl [82]	Wang et al. [84]
	Wang et al. [81]	Yun et al. [83]	Molavi et al. [85]
	Case study	Analysis Approach	Proposed Method
Category 2	Manolis et al. [73]	Fahdi et al. [91]	
	Alzahrani et al. [86, 87]	Gutierrez-Romer et al. [92]	Haibo et al. [96]
	Lam et al. [88]	Piris et al. [93]	Lazaroiu et al. [97]
	Heng et al. [89]	Tovar and Wall [94]	Erdas et al. [98]
	Zhu et al. [90]	Ramos et al. [95]	
	Green Practices		
	Tsai et al. [99]		
Category 3	Twrdy et al. [100]		
	Villalba and Gemechu [101]		

In terms of the first category, Stoll et al. [80] developed an architecture for an active house for residential customers at the Stockholm Royal Seaport. This house can interact with the smart grid at the seaport, and reduce carbon emissions and manage the energy consumption in buildings. The study by Aarsaether [82] presented an initiative used in Norway to reduce carbon emissions by developing battery-based propulsion systems with electric power distribution for the shore-based power supplies of ships in seaports. Yun et al. [83] developed a carbon emission quantification simulation model to eliminate the impact of mitigation strategies on carbon emissions from seaport operations and shipping inside container terminals. The experimental results showed that reducing ship speed in waterway channels from 24 to 8 knots can reduce the carbon emissions of these ships by up to 48.4 percent and by about 32.9 percent for the whole container.

Another important study by Wang et al. [84] proposed a two-stage framework for an optimal design of a hybrid renewable energy system for seaports. This framework can achieve significant reductions in carbon emissions and can be used as a reference for green seaport container construction. The study by Molavi et al. [85] explored the impact of applying a smart grid to a seaport using a two-stage stochastic mixed integer programming model. The results showed that applying a smart

## 2.2. KEY FINDINGS OF RELATED RESEARCH STUDIES ON DECARBONISING SEAPORTS

---

grid at a seaport can have a significant impact by reducing energy consumption and carbon emissions. Meanwhile, the study by Wang et al. [81] applied a green seaport scheduling model for seaport construction to optimise economic and environmental efficiency. The results showed that such a seaport can reduce the use of coal by about 6527 tonnes, which will consequently reduce CO<sub>2</sub> emissions by about 40,875 tonnes.

The second category of research on carbon reduction focuses on the analysis and investigation of systems that will help reduce carbon emissions at seaports. Fahdi et al. [91] compared the performance of Rubber Tired Gantries (RTGs) and Electric Rubber Tired Gantries (E-RTGs). The results showed that using E-RTGs when applying green seaport policies can have a significant impact by reducing carbon emissions by about 67.79 percent and saving about 86.6 percent of energy usage. Gutierrez-Romero et al. [92] investigated the impact of applying an On-shore Power Supply (OPS) for ships at berths. The results showed that applying these technologies can save up to 10,000 tonnes of CO<sub>2</sub>. The study by Piris et al. [93] investigated the use of an Automatic Mooring System (AMS), which can result in a reduction of carbon emissions at seaport by about 76.78 percent.

The study by Lam et al. [88] investigated the feasibility of implementing an Energy Management System for seaports. This study used discrete event simulations for its investigations. The results show that an EnMS can reduce carbon emissions and provide greater benefits for seaport authorities. Meanwhile, Alzahrani et al. [87, 86] proposed a smart microgrid for fishery seaports that was validated using a case study of a local seaport. The result shows that the seaport authority and surrounding communities can meet the local power demands using local Photovoltaic (PV) power generation, which will reduce CO<sub>2</sub> emissions considerably. Heng et al. [89] proposed a twin seaport coordination optimisation model within the framework of vessel terminal coordination. The results showed that both time and fuel consumption can be minimised, which will impact the total amount of carbon emissions. Haibo et al. [96] investigated energy consumption and carbon emissions at seaports using consumption and emission inventories. This study proposed control measures for reducing both energy consumption and carbon emissions. Lazaroiu and Roscia [97] highlighted the concept of a zero emission seaport. This study

## 2.2. KEY FINDINGS OF RELATED RESEARCH STUDIES ON DECARBONISING SEAPORTS

---

proposed two scenarios for applying renewable energy resources at a seaport in Naples to reduce dependency on fossil fuels and reduce carbon emissions. Meanwhile, Zhu et al. [90] discussed the use of renewable energy resources to meet power demands in a seaport of Ningbo, Belgium. The results of this study proved that using clean energy in seaports can achieve energy savings and carbon reductions at seaports. Wang et al. [102] analysed the carbon emissions in 30 seaports in China. The authors proposed methods for calculating the carbon emissions from Seaport Container Distribution (PCD). The study by Erdas et al. [98] introduced a strategy for the environmental management of seaports to reduce environmental impacts. Furthermore, Tovar and Wall [94] estimated the environmental efficiency of 28 Spanish seaport authorities using an output directional distance frontier with poor output and high carbon emissions. This study proved that if the seaport authorities provided sufficient environmental efficiency, then the carbon emissions could be reduced by 63 percent .

Arena et al. [103] studied the feasibility of applying energy systems in seaports that can produce electricity from sea waves and use electric vehicles for mobility. The study by Johnson and Styhre [104] investigated the possibility of increasing energy efficiency in shipping at seaports by reducing the time spent in seaport. The results showed that an estimated 28 percent reduction in energy consumption can occur in seaports when the time is reduced. Meanwhile, Yang [105] investigated CO<sub>2</sub> emissions from two seaports using carbon footprint analysis and grey relational analysis. The results showed that a green container should be designed to harmonise container terminal operations with environmental impacts. Ramos et al. [95] investigated the capability of implementing a tidal energy farm to meet the power demands of the seaport of Ribadeo. The results showed that about 25 turbines are able to meet local power demands and reduce carbon emissions. The study by Hua and Wu [61] used historical data on the energy consumption of Taiwanese fishing vessels to analyse energy efficiency to find ways to reduce daily emissions. The authors suggested that fisheries should be encouraged via subsidies to use clean energy for their vessels and use informed energy practices for their appliances. Meanwhile, Acciaro et al. [72] urged seaport authorities to apply smart Energy Management System (EMS) to limit environmental impacts by en-

## 2.2. KEY FINDINGS OF RELATED RESEARCH STUDIES ON DECARBONISING SEAPORTS

---

hancing the energy efficiency of their systems. The author argued that increasing the energy efficiency of seaport authorities would reduce both carbon emissions and energy costs. This argument was supported through a comparison between two seaport authorities that applied smart energy management strategies. The study by Parise et al. [106] used statistical techno-economic analysis to investigate the impact of applying renewable energy and energy storage for boats to improve the energy network that can exchange power with the grid. The authors argued that applying a smart microgrid can have a significant impact on the energy used by the seaport authority. Furthermore, Manolis et al. [73] discussed the importance of a distributed demand response strategy using a Multi-Agent System (MAS) to improve voltage in the energy distribution networks at seaports. Misra et al. [62] estimated the carbon emissions from the seaport of Chennai using guidelines from the Intergovernmental Panel on Climate Change (IPCC) and the World Seaport Climate Initiative (WPCI). The total was found to be about 280,558 tonnes of CO<sub>2</sub>/year. The author suggested applying an AMS system and OPS to mitigate carbon emissions at the seaport site. In addition, Misra et al. [107] proposed that the seaport authority should apply renewable energy technology to help mitigate carbon emissions. The third category proposes some practices that might help reduce carbon emissions in seaports. Tsai et al. [99] developed self-management approaches that have the potential to help manage and control the total carbon emissions from seaport activities. This study proposed nine strategies and three actions that can help to control carbon emissions in seaports. Meanwhile, Twrdy and Zanne [100] investigated the sustainability of seaport logistics and the current status of the seaport in Koper. The authors suggested developing the planning of the seaport site and applying green activities to help reduce carbon emissions at the seaport. A study by Villalba and Gemechu [101] proposed indicator measures of Greenhouse Gas emissions (GHG) for seaport activities that will help monitor and control the carbon emissions in seaports. The author also argued that indicators can help decision makers prevent and control carbon emissions from seaport authorities over time.

### 2.2.2 Renewable energy adoption

The second most important finding in relevant studies was the increased role of applying renewable energy resources at seaports. The main types of renewable energy resources that are discussed in the literature are solar energy, wind energy and marine energy.

#### 2.2.2.1 Solar energy

Within the industrial sector, solar power has become an attractive source of energy because it is free, clean and abundant with no pollution [108]. In 2016, the proportion of the renewable share in the form of final energy consumption was about 10 percent [109]. Two types of solar energy applications are used: solar thermal and PV. Solar thermal industrial applications account for 10 percent of the total amount of global high temperature industrial processes [110]. The most common types of thermal applications are hot water, steam, drying and dehydration processes, pre-heating, concentration, pasteurisation, sterilisation, washing, cleaning, chemical reactions, industrial space heating, food, plastics, buildings, the textile industry and even business concerns [111]. PV refers to the process of “converting directly radiated light (solar or other) into electricity” [112]. In 2015, approximately 25 percent of PV solar cells were made of pure monocrystalline silicon. Monocrystalline solar cells are the most efficient of all PV panels, boasting efficiency rates of upwards of 15 to 20 percent [113]. Many manufacturers offer 25 year warranties on these types of PV systems. In general, solar PV cells involve a simple design component with very competitive maintenance costs [114]. PV panels can work effectively in different weather situations. It has also been suggested that the installation costs will gradually decrease, due to the increased demand and production of PV panels [115]. PV systems are incredibly versatile and they can be installed at different sized sites for different projects. There are two main groups of PV systems: stand-alone and grid-connected systems. A stand-alone system is not connected to the grid and the power production will be used locally to meet power demands. This system needs a storage system to meet power demand at night. Meanwhile, grid-connected systems are connected to the national grid [116] to feed the surplus power production to the grid and meet demand when the power from the PV

## 2.2. KEY FINDINGS OF RELATED RESEARCH STUDIES ON DECARBONISING SEAPORTS

---

system is not adequate. Solar energy in the industrial sector is not only used for heating, cooling and air conditioning but also to produce energy using PV systems. A PV system can be used directly by storing energy in rechargeable battery systems, which can then be used for different applications [117].

Only a few studies highlight the application of solar farms specifically at seaports. The study by Stoll et al. [80] discussed the application of an active house for sustainability of the Stockholm Royal seaport. This study discussed integrating solar PV systems with smart appliances and local energy storage to enable demand response integration to build automation systems. Furthermore, Brenna et al. [118] investigated the integration of a local PV system to charge electric vehicles for cities, airports and seaports. A study by Lam et al. [88] analysed the application of an EnMS for a seaport site to reduce costs and carbon emissions. This study suggested that solar energy systems could be used to integrate and meet the power demands of the seaport authority. The study by Alzahrani et al. [87] investigated the implementation of a smart microgrid for a fishery seaport site using a rooftop PV system to meet the power demands of the seaport authority. The same authors [35,66] investigated the integration of a local solar farm to meet the local power demands and those of the surrounding community using modelling and simulation analysis programs. In addition, a case study by Verma et al. [119] discussed the implementation of a 3.3 MWp PV system to help reduce instability in power distribution at the seaport of Jurong. Zhu et al. [90] investigated the application of multiple renewable energy resources, such as solar, wind and geothermal energy for Ningbo seaport Co. Ltd. Furthermore, Acciaro et al. [72] compared the application of energy management systems for seaports between two seaports: the Hamburg seaport and the seaport of Genoa. The seaport of Genoa applied the seaport Energy Environmental Plan (PEEP), which aims to develop the activities of energy production and consumption at the seaport. One of the main goals of the PEEP plan is to install three stations of solar energy, which will help reduce overall carbon emissions in the seaport by more than 20,000 tonnes/CO<sub>2</sub> emission.

The study by Misra et al. [62] proposed a microgrid system to meet the power demands of the port authority and applied different kinds of renewable energy resources. The study found that applying a 5 MWp solar PV system with differ-

## 2.2. KEY FINDINGS OF RELATED RESEARCH STUDIES ON DECARBONISING SEAPORTS

---

ent types of energy resources can help meet the power demands of the local port authority. Another case study by Balbaa et al. [120] developed smart electrical interconnection management between multiple ports in Egypt. This study proposed that applying a PV system can not only meet local power demands for the port site but can also feed surplus power to other ports, which will help in greening seaports and developing eco-friendly port sites. The case study [121] proposed installing a smart EnMS for a touristic harbour by applying renewable energy resources. This study applied a PV system to meet the power demands of the harbours at ports.

### 2.2.2.2 Wind energy

Wind energy is considered to be the most promising renewable energy source because it is clean, free and abundant. The concept of wind energy is based on the large scale movement of air mass due to differences in atmospheric pressure along with the rotation of the Earth [122]. There has been a large growth in installed wind energy at a global level. In 2018, the total installed wind capacity was 599 GW. It was projected that the installed wind energy would rise to 664.5 GW [123]. Wind turbines consist of a tower, a wind turbine, a yaw mechanism, a speed control unit, a drive train system and an electrical generator [124].

There are many benefits to using wind as an energy source which is simple, produces zero emissions and offers high efficiency. While wind is a popular energy source, wind turbines require further development to minimise their noise generation. Wind turbines are not considered to be aesthetically pleasing and they are also considered to be very expensive to install compared to other renewable energy sources [125]. While wind turbines can be installed both on and offshore, the authors in [126] suggested that using offshore wind energy could be more effective and stable compared to onshore wind energy. With the UK looking to increase its RES (Renewable Energy Systems) power generation by 35 percent by 2020, the UK sees offshore power as a solution to achieve this target and it aims to generate 22 GW from offshore power supplies [127].

Studies on using wind energy for seaports remain very limited because not all the seaport locations are suitable for the installation of either onshore or offshore wind turbines. Wind farms are large in size, and there is often not enough space



## 2.2. KEY FINDINGS OF RELATED RESEARCH STUDIES ON DECARBONISING SEAPORTS

---

close to port sites to install them. The study by Acciaro et al. [72] noted that the Hamburg port authority has invested in renewable energy since 1990 and has installed 58 turbines with a capacity of 52.75 MW. Furthermore, Wang et al. [81] proposed a framework to help find the optimum design capacity of a hybrid renewable energy system for seaports. This model proposed installing wind energy as a sub-system to meet the power demands of the port site. Meanwhile, Gutierrez-Romero et al. [92] investigated the capability of renewable energy resources to meet power demands for a port site. This study found that wind energy can be efficiently applied to the site to meet the power demands for the port authority.

### 2.2.2.3 Marine energy

Three quarters of the Earth's surface is occupied with oceans and seas, which offers the potential for energy generation. Marine renewable energy power generation occurs from tidal movement and ocean circulation. There are many types of marine renewable energy sources that can be utilised to generate electricity, including wind, tides and waves [128]. According to the World Offshore Renewable Energy Report 2002–2007, the world's potential tidal energy is estimated to be 3000 GW, with less than 3 percent being located in areas suitable for power generation [129].

A total of 16.2 GW of offshore wind capacity is expected to be installed in Europe, with the majority located in the North Sea. The United Kingdom alone is expected to install 18 GW of offshore wind by 2020. Tidal currents are very predictable, as high and low tides develop with well-known cycles, making marine renewable energy much easier to predict than renewable resources that rely on wind and sun exposure. Compared to other types of renewable energy sources, marine renewable energy is considered to be less complicated to connect to the national grid. The biggest challenge associated with marine renewable energy is its installation, which can be time consuming and expensive. Furthermore, Rourke et al. [130] argued that the installation costs of marine energy are much higher than those of any other renewable energy sources and marine renewable energy sources require regular maintenance by highly skilled labourers.

Only a few studies [86, 107] highlight the application of solar farm, specifically at seaports. Based on our search, only three studies mention the application of

## 2.2. KEY FINDINGS OF RELATED RESEARCH STUDIES ON DECARBONISING SEAPORTS

---

marine energy to meet the power demands of the port authority. First, the study by Ramos et al. [95] investigated the implementation of tidal energy to meet the power demands of the port authority and showed that about 25 turbines of tidal energy can fulfil the total power demands. Second, Alvarez et al. [131] designed a tidal energy turbine to investigate the capabilities of the proposed tidal turbine to meet the local power demands of the port site. Finally, Lazaroiu and Roscia [97] investigated the application of a sea wave energy converter to utilise power for port applications. This study investigated the application of Resonant Wave Energy Converter (Rewec3) and Inertial Sea Wave Energy Converter (ISWEC) devices to convert waves to energy, and showed that Rewec3 is the best system to apply from a theoretical and experimental point of view.

### 2.2.3 Cost optimisation

This review has identified that most studies focus on minimising the cost of energy used for seaport activities, while some research has discussed maximising the profit from installing green energy resources to help meet power demands locally.

Based on the analysis of the studies in table 2.2, the cost optimisation is divided into two main categories: profit maximisation and cost minimisation. The studies that optimise costs via profit maximisation focus on the ability to increase the income from investing in energy systems and their applications in seaports. In contrast, studies that optimise costs via cost minimisation focus on the ability to reduce the costs of energy use, lower the investments needed to apply smart systems and reduce impact of carbon emission taxation on seaport authorities and key workers.

The review shows that most existing literature discusses cost minimisation at seaports, while only three studies highlighted cost optimisation through profit maximisation [88, 97, 119]. Studies that discuss the minimisation of costs are divided into direct effect and indirect effect minimisation. “Direct effect” studies aim to reduce costs directly at the seaport via different techniques and optimisation strategies [82, 84, 87, 86, 120, 132, 133]. “Indirect effect” studies focus on reducing the costs of operations at seaports, such as energy costs and emission and operational costs, indirectly by applying a smart system, increasing energy efficiency [81, 91,

104, 105, 131, 134].

### 2.2.4 Adoption of smart control technologies

The search results show that studies on seaport energy applications are moving toward deploying smart technologies that will increase the efficiency of the operational system at port facilities. These studies discuss three main areas: introducing smart grid approaches, proposing energy management systems for seaports and using Internet Of Things (IoT) approaches for port activities.

For smart grid approaches for seaports, the Royal Port of Stockholm [80] developed a project that aims to reduce carbon emissions and enhance the concept of sustainability at the port district by developing smart house architecture that will provide interactions between consumers and their utilities to improve the energy usage in each house. The study by [87] developed a smart microgrid for a fishery port site that aims to increase the use of renewable energy resources and reduce both energy consumption and carbon emissions. Furthermore, Niglia [136] discussed the role of securing critical infrastructure with smart grids for seaport applications. This study argued that, due to the importance of applying smart grid technologies at seaports, security is crucial for the smart grid system to protect the port from disruptive cyber-attacks. Meanwhile, Verma et al. [119] developed a smart grid approach for the port site using renewable energy sources and an energy storage system to meet local power demand for the port site and to sell the surplus power to the grid. In addition, Molavi et al. [85] explored the benefits of applying a microgrid at a port site. This study developed a multi-stage stochastic mixed integer programming model to investigate the effectiveness of applying a microgrid to a port site based on different parameters. These authors argued that applying a microgrid can have an impact on the overall activities of the port site. Finally, Arena et al. [103] investigated the feasibility of producing energy from sea waves and using it to charge electric vehicles for seaports.

In their study, Gutierrez-Romero et al. [92] investigated the application of an onshore power supply at the port to meet the power demands of ships at their berths. This study argued that the proposed system will reduce carbon emissions and increase energy efficiency at the port site. Meanwhile, Ramos et al. [95] inves-

## 2.2. KEY FINDINGS OF RELATED RESEARCH STUDIES ON DECARBONISING SEAPORTS

Table 2.2: Previous studies on greening seaports

Author	Port Decarbonization Indicators								
	CR	RES	CO			ST		LP	GPP
			Max	Min	SG	EMS	IOT		
Fahdi et al. [91]	✓	✓		✓			✓		✓
Stoll et al. [80]	✓	✓				✓	✓		✓
Brenna et al. [118]	✓	✓				✓	✓		
Sarabia-Jácome et al. [135]	✓							✓	✓
Aarsaether [82]	✓			✓			✓		
Lam et al. [88]	✓	✓		✓			✓		
Alzahrani et al. [87]	✓	✓		✓			✓		✓
Heng et al. [89]	✓								
Alvarez et al. [131]		✓		✓			✓		
Niglia [136]		✓				✓			
Verma et al. [119]		✓	✓				✓		
Haibo et al. [96]	✓								✓
Lazaroiu and Roscia [97]	✓	✓	✓						✓
Parise et al. [106]							✓		
Zhu et al. [90]	✓	✓							✓
Li et al. [137]								✓	✓
Yun et al. [83]	✓								
Wang et al. [84]	✓	✓		✓				✓	✓
Azarkamand et al. [138]								✓	✓
Wang et al. [102]	✓							✓	✓
Yang et al. [139]								✓	✓
Boile et al. [140]							✓		✓
Zughbi and Zulli [141]	✓								
Gobbi et al. [142]	✓								
Erdas et al. [98]	✓					✓		✓	✓
Molavi et al. [85]	✓	✓				✓	✓	✓	✓
Hua and Wu [61]									✓
Moya et al. [11]	✓						✓		
Villalba and Gemechu [101]	✓							✓	✓
Tovar and Wall [94]	✓								
Arena et al. [103]	✓	✓				✓	✓		

\*CR: Carbon Reduction, \*CO: Cost Optimisation, \*ST: Smart Technologies, \*LP: Law & Policies,

\*GPP: Green Port Practices, \*RES: Renewable Energy Sources, \*SG: Smart Grid,

\*EMS: Energy Management System, \*IOT: Internet of Things

## 2.2. KEY FINDINGS OF RELATED RESEARCH STUDIES ON DECARBONISING SEAPORTS

Table 2.3: Previous studies on greening seaports

Author	Port Decarbonization Indicators								
	CR	RES	CO			ST		LP	GPP
			Max	Min	SG	EMS	IOT		
Lam et al. [88]								✓	
Dulebenets [143]				✓					
Trivyza et al. [132]	✓			✓					
Johnson and Styhre [104]	✓			✓	✓				
Gutierrez-Romero et al. [92]	✓	✓			✓	✓			
Twrdy and Zanne [100]	✓	✓						✓	
Song et al. [133]				✓					
Park and Kim [144]							✓		
Yang [105]	✓			✓					
Piris et al. [93]	✓						✓		
Tsai et al. [99]	✓								
Pavlic et al. [145]								✓	
Ramos et al. [95]	✓	✓			✓	✓			
Acciario et al. [72]		✓				✓			
Wang et al. [81]	✓	✓		✓				✓	
Misra et al. [107]	✓	✓			✓	✓			
Balbaa et al. [120]	✓	✓		✓			✓		
Misra et al. [62]	✓							✓	
Davarzani et al. [146]								✓	
Lamberti et al. [134]		✓		✓	✓	✓			
Manolis et al. [73]	✓					✓			

\*CR: Carbon Reduction, \*CO: Cost Optimisation, \*ST: Smart Technologies, \*LP: Law & Policies,

\*GPP: Green Port Practices, \*RES: Renewable Energy Sources, \*SG: Smart Grid,

\*EMS: Energy Management System, \*IOT: Internet of Things

## 2.2. KEY FINDINGS OF RELATED RESEARCH STUDIES ON DECARBONISING SEAPORTS

---

Investigated the implementation of a tidal farm to meet the power demands of a port site. The result of the study showed that 25 tidal turbines are capable of meeting the power demands of the port. Misra et al. [62] proposed a microgrid for a port site using renewable energy resources to meet power demands and reduce carbon emissions for seaport activities. The second criteria for applying smart technologies to seaports is the role of energy management systems for seaports in increasing energy efficiency. For example, Lam et al. [88] investigated the impact of using an EnMS for seaports. These authors argued that implementing a smart EnMS at seaports can have an economic and environmental impact on the port site and surrounding communities. Furthermore, Parise et al. [106] argued that an energy master plan at the port site can improve the efficiency of the operational systems at the port.

Applying a new smart EnMS will help to optimise the energy usage at seaports, such as by using a smart grid, microgrid and/or shore-to-ship power supply. Acciaro et al. [72] compared two port authorities applying Energy management systems for seaports, and showed that applying an EnMS to ports will help reduce energy cost and increase energy efficiency at the port site. Meanwhile, Lamberti et al. [134] analysed the impact of using smart Energy management systems for seaports for touristic harbours by utilising currently installed renewable energy generators and energy storage. This study showed that selling local energy production to the grid is the optimal solution to recoup the investment costs of the system. The third criteria for applying smart technologies to a seaport is applying new advanced technology. Sarabia-Jácome et al. [135] developed a seaport data space that will help avoid the interoperability of the stakeholder information system. These results show that the seaport data space improves the decision-making process between seaport departments. Furthermore, Piris et al. [93] investigated the use of an Automatic Mooring System [AMS] that allows vessels to be moored without a robe, which was found to reduce carbon emissions.

### 2.2.5 Regulatory landscape for greening seaports

With the increased global motivation to mitigate climate change, some countries have implemented new rules, policies and legislation to help to reduce the impact

## 2.2. KEY FINDINGS OF RELATED RESEARCH STUDIES ON DECARBONISING SEAPORTS

---

of climate change. The seaport industry is a crucial element of economic growth for cities and communities [147]. Some studies proposed various measures and strategies to help reduce carbon emissions from seaports. An exploratory study by Li et al. [137] on implementing low carbon port concepts at Chinese ports suggested several strategies to help apply the low carbon port concept, including promoting the awareness of green port activities, enacting rules and regulations of low carbon port emission, applying clean and smart energy technology, and supporting the implementation of low carbon ports through policy and financial aspects. Azarkamand et al. [138] developed a standardised tool to calculate the emissions from the seaports based on the WPCI and IPCC guidelines. Erdas et al. [98] introduced a methodology to help rationalise the environmental management strategies for seaports to minimise environmental impacts. Finally, Villalba and Gemechu [101] proposed indicators of carbon emissions for port activities, which could be used to develop practical policy measures based on the proportion of carbon emissions for each activity at the port site.

### 2.2.6 Best practice guidelines for smart green ports

The idea of greening ports has emerged after several initiatives to reduce the amount of emissions caused by seaport activities. The concept of a green port involves “the integration of environmentally friendly methods of port activities, operation and management” [148]. Several criteria can be used to define the measures for implementing the green port concept, such as policies to help reduce carbon emissions from the seaport. Likewise, the use of renewable energy for seaport operations should be increased. Previous studies on green ports can be divided into two main categories: first, applications that will lead to green ports, and second the methods and measures that will lead to greening ports.

Fahdi et al. [91] discussed the replacement of rubber tired gantries by an electric type to help reduce carbon emissions and energy consumption. Stoll et al. [80] demonstrated the application of active house architecture at a seaport, which will help to save energy, reduce carbon emissions and increase the use of green energy. Alzahrani et al. [87] developed a smart microgrid for fishery ports, which helped reduce carbon emissions, reduce energy consumption and increase the use

of renewable energy resources. Further research by Haibo et al. [96] proposed an inventory method for energy consumption at seaports, including some measures to help reduce carbon emissions and apply the green port concept. Zhu et al. [39] discussed the application of renewable energy technology that will lead to reduced carbon emissions from seaports. In addition, Wang et al. [81] proposed a framework using hybrid renewable energy technology for seaports. Molvi et al. [28] studied the impact of applying microgrids to seaports. Twrdy and Zanne [100] investigated sustainability in port logistics and the current status in the port of Koper. Misra et al. [107] developed a microgrid for a port authority in India, which led to reduced carbon emissions through the increased use of renewable energy.

The second category of research on green port practices includes studies that discuss the methodologies, measures and standards that will contribute to the application of green port concepts. Jian [149] developed practical guidelines for applying low carbon ports in China. [138] developed standardisation tools to calculate carbon emissions, which will help monitor and reduce carbon emissions from seaports. Meanwhile, Erdas et al. [98] proposed a methodology to analyse the ecological footprint based on the environmental objectives of ISO 14000. Hua et al. [150] proposed a green port indicator and used fuzzy importance performance analysis to assess the performance of green ports. In addition, Pavlic et al. [145] proposed approaches for the practical application of green port concepts. Finally, Misra et al. [62] demonstrated the role of smart technologies in helping reduce carbon emissions from port sites.

## 2.3 Evolution of the seaport environmental regulatory landscape

Climate change has led to the introduction of global policies aimed at decarbonising industries. According to an IPCC report, since 1950, the observations of atmosphere and ocean currents have gradually increased [151]. Climate is the term for “the typical average weather of a region or city”, while climate change is a “change in the Earth’s overall climate” [3]. In response to climate change, there is an international movement toward environmental sustainability and decarbonisation



away from fossil fuels [152].

These initiatives were started by the intergovernmental panel on climate change in 1988 [153]. They were followed by the United Nations Framework Convention on Climate Change (UNFCCC) in 1994 [65]. In 2005, the Kyoto protocol applied to more than 192 parties [66]. On 12 December 2015, 195 countries agreed to combat climate change in Paris, and important policy makers vowed to initiate practical steps to reduce the global average temperature and emissions by increasing the utility of renewable energy. Environmental legislation and policies on renewable energy at the international level aim to reduce CO<sub>2</sub> emissions and increase the use of renewable energy sources.

Annunziata et al. [10] highlighted the main three perspectives that governments focus on to reduce CO<sub>2</sub> emission, including the integration of energy efficiency and renewable energy, investments in energy savings, and the development of zero-energy buildings. Moya et al. [11] highlighted the importance for governments to focus on energy efficiency programs for developing countries to decrease GHG emissions and reduce energy consumption. In addition, the EU set targets for reducing CO<sub>2</sub> emissions and increasing the use of renewable energy resources [154]. The main objectives of the EU established in 1997 were to decrease GHG emissions, ensuring the security of the supply chain, and improving the EU's competitiveness [69]. Due to the increasing awareness of global warming and the importance to focus on decarbonisation plans at a global level, many countries have begun to move toward decarbonisation. United Kingdom was one of the first countries to start implementing a long-term plan to reduce its carbon emissions and increase its use of RES, as shown in Figure 2.2

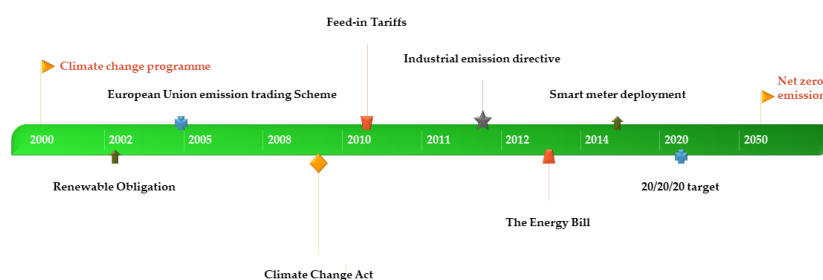

Figure 2.2: Timeline of the main motivations for decarbonisation in the UK

### 2.3. EVOLUTION OF THE SEAPORT ENVIRONMENTAL REGULATORY LANDSCAPE

---

The first initiative began in 1989, with the aim of replacing fossil fuels by nuclear energy to produce electricity under the Non-Fossil Fuel Obligation (NFFO) law. This initiative was followed by a global motivation program, known as the Climate Change Program, which aimed to reduce CO<sub>2</sub> by 15-18 percent in 2010. In 2002, the government established the Renewable Obligation (RO) law. This act makes it mandatory for the supplier to secure a specific share of electricity from renewable energy, or they must pay a penalty. One of these policies was enacted in 2003 (2003/87/EC). This policy is known as the emission trading scheme, which is considered to be the main tool for reducing GHG emissions in the EU

[18]. This scheme works via a cap and trade mechanism. The cap sets the total amount of GHGs that can be emitted by the installation, while the relevant companies receive or trade their emission allowances. In 2008, a new act, known as the Climate Change Act, was passed by the government. This act requires companies to cut their GHG emissions by about 34 percent by 2020 and by 80 percent by 2050. The government also developed a budget across several periods to achieve the target of decreasing its carbon emissions by 2050.

The Feed-In Tariff (FIT) is an important policy that was applied in Europe in 1980. This tariff was applied in Denmark, Germany and Italy in 1990 [155]. The concept of the FIT is “policy pricing, guaranteeing renewable energy generators a fixed price for the electricity they produce” [22]. The advantages of FIT include a guaranteed price, which will allow householders with solar panels to buy power through renewable energy markets. In 2011, a new law was established by the EU that requires all members to apply an industrial emissions directive. This law aims to increase the level of protection over human health and the environment by decreasing the level of industrial emissions in the EU. This law is based on five criteria: an integrated approach, the best available techniques, flexibility, environmental inspection and public participation.

In 2012, the UK established a new approach known as the “Green Deal”, which helps homeowners improve their energy savings and determine the best option to pay for their energy. This was followed in 2014 when the government announced a mega plan to install smart meters in homes between 2014 and 2019, with over 53 million smart meters for gas and electricity now being used. The EU established

## 2.4. PREVIOUS PROJECTS THAT FOCUSED ON DECARBONISING SEAPORTS AND TERMINALS

---

a new directive (2001/77/EC) to promote the use of electricity from renewable energy resources [66, 156]. To increase the deployment and development of RES, in 2009 the EU implemented a renewable energy directive (28/2009/EC) that promotes the use of renewable energy resources to provide 20 percent of the total power production by 2020 [15]. In 2011, the Europe Commission published a low carbon roadmap for EU members, aiming at reducing GHG emissions by 80–95 percent by 2050. To achieve this target, each EU member must increase its level of development and deployment of clean technologies [15].

### 2.4 Previous projects that focused on decarbonising seaports and terminals

In the last few decades, governments, global coalitions, and international organisations have moved towards finding more sustainable solutions based on innovative modern technologies to minimise carbon emissions in the industrial sectors. This was primarily undertaken by announcing financial grants for to study, analyse and implement projects to reduce carbon emissions. The seaport industries have entered into an digital transformation as part of this global warming agenda with the key objective to reduce carbon emissions around the value chain.

Several projects have been implemented to improve operations at seaports and terminals. These projects were developed to combat climate change by reducing carbon emissions while reducing energy consumption. Some projects developed and built smart energy technologies in an attempt to maximise the utilisation of renewable energy resources and to reduce carbon emissions. However, several projects have had different contributions ranging from rules design and implementation towards definition of standards for the installation of sustainable strategies for port activities [157, 158, 159]. One of the biggest projects attempting to address digital transformation of seaports is the Stockholm Royal seaport project, which aims to implement and develop a fuel free seaport district with a budget of around euro 2.2 billion[160]. This initiative also includes the development of the largest urban area in Sweden, aiming to construct more than 12000 new houses and more than 35000 workplaces.

## 2.4. PREVIOUS PROJECTS THAT FOCUSED ON DECARBONISING SEAPORTS AND TERMINALS

---

The Green EFFORTS means "Green and Effective Operations at Terminals and in Ports" [161] is a research project that is co-funded by the European Commission aiming to reduce energy consumption and improve clean energy in ports. This project provides strategic planning instruments for ports and terminal to reduce carbon emissions and deliver smarter energy management in seaports.

The APICE project [162] is financed by the European program and it aims to establish a knowledge-based approach for air pollution mitigation and sustainable development of ports activities driven by spatial planning policies at local level, which includes the territory around the seaports. This project aims to help policy makers to integrate a port master plan and associated investments in seaports.

The Enerfish project [163] develops an integrated renewable energy solutions for seafood processing stations using a new polygeneration application with renewable energy sources for the fishery industry. The research project improves energy use at fishery industry through developing optimisation, simulation, validation and planning of pilot case studies. The research outcomes of this project are based on developing a distributed energy system that uses the cleaning waste of fish processing industries to produce bio-diesel, which can be used to produce energy for the fish processing industries.

Recently, the Smart Cluster Energy System (piSCES) project [164] has aimed to reduce the costs and carbon footprint for the fish processing industry by developing and testing a new 'smart grid' electricity network. The smart cluster energy system aims to reduce the costs and carbon footprint of energy networks in the fish processing value chain by implementing smart grid technologies through modelling the usage profile of their energy networks, and optimising that against the wholesale energy market and any available onsite generation.

In the selected group of projects that have been reviewed, different sustainability objectives have been addressed in relation with the life cycle of seaports, all involving different sets of variables and objectives for reducing energy consumption, reducing carbon emissions and applying renewable energy systems. Table 2.4 provides a comprehensive list of the previous projects that have focused on improving the environmental quality in seaports and terminals.

### 2.5 Smart port approach

The three features of the 2020 strategy for Europe are: Smart, sustainable and inclusive [165]. One of these initiatives involves transforming ports into smart ports . The smart port project will involve installing and deploying a new energy model and value proposition based on smart and innovative technologies with low operational and environmental impacts. Buiza et al. [74] summarised the holistic concept of a smart port as follows: “emphasizing particularly operational and energy efficiency, competitiveness and the environmental impact aspect”.

The smart port approach can impact the overall ecosystem of the seaport by continuously harvesting information on seaport activities using the IoT, and making decisions using AI and big data technologies. This approach can provide a data storage system that is resilient and which allows different entities to obtain access to relevant data, based on an agreed governance model, that will help optimise operational systems and increase efficiency.

Seaports play an important role in the increasing development of new technologies that will increase their level of effectiveness given that seaports are a multidimensional system combining economic functions, infrastructure systems and geographical space and trade [166]. The development of seaports from 1950 to 1990 followed the traditional paradigm of seaports, with some progress in logistics operations and infrastructure but limited improvements to information and communication systems.

Advanced technology for port operations can also have a robust impact on both the port authority and the surrounding communities, as well as increasing the level of competitiveness between different port authorities. This could lead to the implementation of smart port activities using leading edge technology [85].

Table 2.4: List of projects investigating green seaports and port activities

Project	Date	Aim	Fund	Coordinated by
The Stockholm Royal Seaport [160]	2010-2030	To develop a fuel free seaport district	2.2 Bn	The Stockholm City Council
GREEN EFFORTS [161]	2007-2013	Reduce energy consumption and improve clean energy	3.1 M	Jacobs University Bremen
Greencranes [167]	2012-2014	Demonstrate the feasibility of new technologies and alternative fuels	3.6 M	Ministero delle Infrastrutture e dei Trasporti (MIT)
PRISM [159]	2010-2012	Identify a set of relevant and feasible performance indicators for the EU ports	-	European Sea Ports Organization (ESPO)
CLIMEPORT [168]	2009-2012	Encourages Mediterranean Ports to reducing greenhouse emissions	1.6 M	Port Authority of Valencia
ECOPORT [157]	2009-2012	Improve the quality of ports	2.1 M	Autoridad Portuaria de Valencia
piSCES [164]	2017-2020	Reduce the costs and carbon for fish industries by implementing smart grid	2.2 M	Waterford Institute of Technology
APICE [162]	2007-2013	Develop a knowledge-based approach for air pollution mitigation and sustainable development of port activities	2.2 M	Regional Environmental Agency of Veneto
Enerfish [163]	2008-2013	A new polygeneration application with renewable energy sources	5.4 M	TEKNOLOGIAN TUTKIMUSKESKUS VTT
E-harbour [169]	2010-2013	Create a more sustainable energy model in harbour regions on the basis of innovative intelligent energy networks (smart grids)	-	Municipality of Zaanstad
EFICONT [158]	2009-2011	To incorporate a set of significant energy efficiency improvements for seaports	-	Ministry of Development
Greenberth [170]	2013-2015	Study in detail the improvement opportunities of energy efficiency in six mediterranean ports	1.6 M	Port Authority of Valencia

From 2000 to present, seaports began to enhance their operational systems to become smart ports using advanced technology systems [171]. The study by Siror et al. [172] noted that smart ports are “a system of port transportation and operation based on modern information technology, that provide multifarious information services for port participants based on the collection, processing, release, exchange, analysis and usage of the relevant information”. Another definition by [173] described a smart port as an integration of all elements of terminal operations, warehousing, logistics, yards and port transportation through a special network that provides different types of information for daily operations at the port.

Another explanation of the smart port concept was provided by Ferretti et al. [174], who described smart ports as a convergence between new smart technologies, such as the IoT, Big Data, automation and environmentally friendly technology, which combine to form a smart infrastructure that connects wired and wireless networks to surrounding objects, such as sensors, to allow the exchange of data between entities. This will help to improve the logistics and transportation industries. Buiza et al. [74] highlighted the concept of a smart port based on a project known as the “action plan towards the smart port concept in the Mediterranean area”. The definition of the smart port concept focuses on three main areas: operation, energy consumption and the environment [175].

The importance of the energy consumption at seaports relates to the high energy demands of port operations. Using energy in an efficient way is a challenge for port authorities because greater energy consumption means greater carbon emission production. This will lead to an increase in the operational costs for such energy [176]. Consequently, most port organisations urge the port authorities to set port regulations that will reduce energy consumption and increase the use of green energy resources. This will also help reduce carbon emissions and energy costs for port operation systems. The second element of the smart port definition is the environmental aspect. Initiatives such as ECOPORT, PRISM and GREEN Efforts aim to define and set the environmental performance indicators of port authorities to help them reduce and eliminate the impact of environmental effects from the port authority.

## 2.5. SMART PORT APPROACH

European seaport authorities consider air quality to be the most important of the 10 environmental priorities for seaports because air quality effects both port operations and shipping activities. Consequently, the environmental element is a crucial area that needs to be considered to transform ports into smart ports [177]. The third area of the smart seaport concept is operations. The main operations at sea are loading and unloading the cargo and containers from ships, boats and vessels into warehouses. In the supply chain of the operational systems at seaports, there are several areas that could be optimised to increase the efficiency and effectiveness of port operations, which will help to reduce cost, time, labour and the lifespan of the machinery. Figure 2.3 presents comparison between traditional and smart port. It can clearly seen how new smart technologies such as IoT, ICT, Industry 4.0 and smart energy reflects on the new smart port approach.

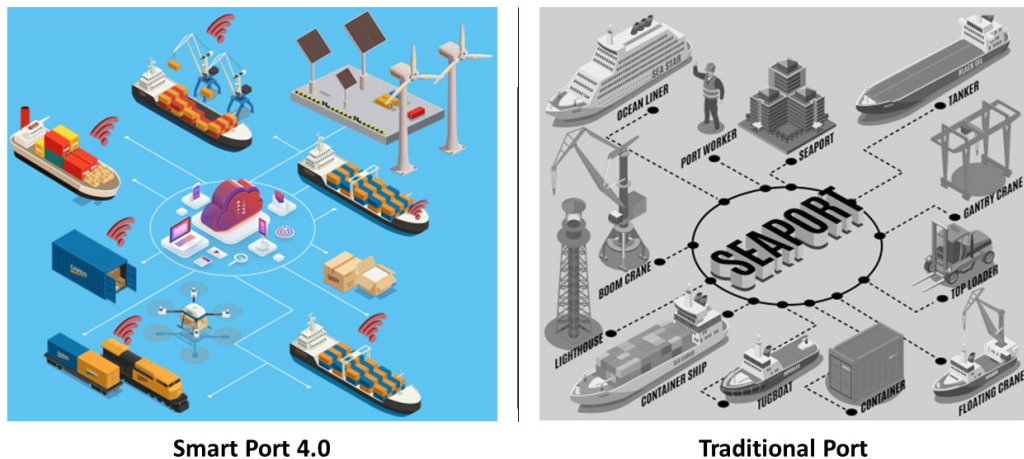

Figure 2.3: A comparison between traditional seaports and smart ports

Molavi et al. [178] added another domain to the smart port index domains, which is safety and security. Safety and security in seaports are part of the port's critical infrastructure. In the last few years, calls have been made to increase the level of safety and security in seaports by increasing digitisation and automation [179]. However, seaport operations have recently experienced an increase in the level of cyber attacks [180]. This issue increases the urgency to consider safety and security at the seaport as one of four main domains of the smart port index.



### 2.6 The impact of energy systems in decarbonisation of seaports

In 600 BC, Thales of Miletus noticed that amber has an attractive power when rubbed with animal fur, which is the first observation of static electricity and magnetism [181]. In the sixteenth century, William Gilbert was the first scientist to use the terms “Electricity, electric force, magnetic pole and electric attraction” [182]. In 1663, Otto von Guericke built the first electricity generation machine. Dutch scientist van Musschenbroek then discovered the first capacitor. In the late seventeenth century, Italian physician Alessandro Volta invented the first battery [183]. In 1820, French physicist Andre-Marie Ampere discovered electromagnetism and the unit of current—the “Ampere”. Perhaps the greatest contribution to our understanding and use of electricity was made by Michael Faraday in the early nineteenth century. For example, he concluded that if magnetic force is generated circularly and the current wire is suspended within an effective radius, then the wire will rotate in a constant circle at a constant rate around emitter of the force. This led to the invention of the electric motor [184]. In 1878, Thomas Edison started the Edison electric light company when he bought some patents related to electric lighting [185].

#### 2.6.1 Centralised energy system

Electrification started at the end of the nineteenth century when distributed electrical power was introduced when Thomas Edison opened the first central power station in Manhattan’s city in 1882. This plant was called the Pearl Street power station and its capacity was about 600kW, which was capable of powering 5000 lights. However, Edison used a direct current (DC) power system [186]. The first high-voltage alternative current (AC) power station opened in London in 1890, which was the beginning of AC central power stations after a period of long experimental controversial debate between the benefits of DC and AC [187]. The United States started to emerge as a leader of electric networks at the beginning of the 20th century to meet the fast growing demand of its Industrial Revolution. One of the main drivers of the market was the demand for power from technological systems.

The government regulated the electric network in the United States. The system was built on a centralised model and was regulated between states. In contrast, the electrical network system in Europe was built for different reasons, such as political issues and legislation systems. However, the first and second world wars affected the development of the electric network in Europe [188].

The progress of local, national electric grids was gradually increased due to the availability and low prices of non-renewable fuels. However, post-war electrification at the global level reached 82 percent by 2010 [189]. In 1947, electricity was placed under public ownership in the UK. This system consisted of four grids. Two of the grids were in Scotland, one for Northern Ireland, and one for England and Wales. There were about 560 generation plants. Following integration, the grid was placed under 14 electricity boards: 12 for England and Wales, and two for Southern Scotland [41].

In 1989, the government privatised the electricity industry in the United Kingdom, which was the first country in Europe union to privatise electricity industry. However, the action plan to start privatisation of the electricity industry began in 1990 [38]. Wholesale electricity competition was introduced in 1998 and the retail market was deregulated by National Power, which means that all consumers have the freedom to choose their power supply. The number of electricity customers was about 22 million end-users [39]. Privatising the power market led to an open the market for stakeholders and investors. This increased the competitiveness between power providers, which will drop-off the power prices. The deregulated power market also increased innovation in the power technology system. This helped the users to manage electricity consumption in general [190].

Fossil fuel is still one of the main sources of fuel for power plants in many countries due to reliability and inexpensive, it is also able to produce electricity for large scale areas. In contrast, countries have avoided producing energy from renewable energy due to a lack of expertise in the field, and the high cost to install and operate such a system. Hydroelectricity is one of the most popular types of renewable energy resource thanks to its reliability, controllability and dispatch to the grid [189]. Nevertheless, the global attitude toward transition from traditional energy resources to renewable energy resources has improved dramatically, due to global

warming and increased carbon emissions. This transition will reduce the use of fossil fuels, encourage the use of green energy, and set new laws and regulations for decarbonisation at the global level.

### 2.6.1.1 Traditional paradigm of a centralised energy system

At the beginning, power generator units supplied electricity only to the closest neighbourhoods because they used a DC-based power grid and power voltage was limited. AC grids provided power electricity over long distances, which is known as a centralised energy system[32]. The term “centralisation” refers to large scale generation of electricity, usually located remotely from the end customers. The power is transmitted through high voltage transmission lines to the end-users [191]. A huge amount of power will be transmitted through transmission lines through cities to points, it will then pass to medium capacity lines and is then distributed to neighbourhoods, small and medium enterprises(SME) and so on; as shown in figure 2.4 [192].

In contrast, there has long been controversy about the capability of the old paradigm of a centralised energy system to meet the fast growth of industrialisation, economics and population. For example, authors have mentioned some of the drawbacks of traditional architecture of electric system [193]. The International Energy Agency (IEA) has reported that a one direction power supply, transmission and distribution will be costly and have negative impacts. For example, from a technical perspective, a one direction power system leads to increased losses in transmission and distribution networks. In addition, the ability to increase reliability and flexibility of the power network will be less. Consequently, rural areas might be affected by frequent power cuts [194]. Furthermore, power producers do not consider consumers as active entities. However, activate electricity users have great ambitions in increase energy efficiency and may become prosumers of power energy [33]. However, population growth, the economic maturity of developed and developing countries, and increased the public awareness toward clean and sustainable energy resources have led to a major transition in the design of electric energy systems. The transition focus of smart, green, controllable and predictable electric system design. McDonald in 2008 mentioned stated that:

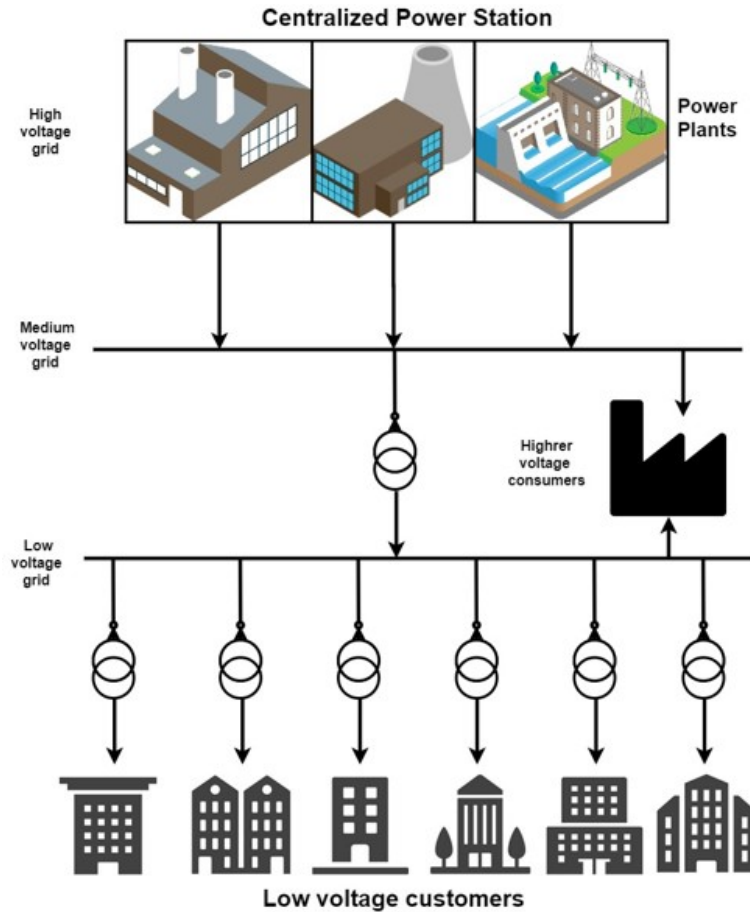

Figure 2.4: Centralised power system paradigm [192]

“Traditional electrical power system architectures reflect historical strategic policy drivers for building large-scale, centralised, thermal- (hydro-carbon- and nuclear-) based power stations providing bulk energy supplies to load centres through integrated electricity transmission (high-voltage: 400, 275 and 132 kV) and distribution (medium-, low-voltage: 33 kV, 11 kV, 3.3 kV and 440V) three-phase systems” [195].

## 2.6.2 Decentralised energy system (DES)

### 2.6.2.1 Background

The earliest days of power generator units supplied electricity only to the closest neighbourhoods due to direct current-based power grid and the limited units of power voltage. A later update of power grid system appeared which give an accessibility to provide power electricity to long distances between power units and buildings using technical tools, such as the emergence of AC grids. This system is

known as centralised energy system [32]. However, the last decade has witnessed a significant transition of energy policy because of global warming with an increase in the population growth rate. Consequently, some countries have started to deploy small power generation units to increase the security of supply and meet the power demand. This system is known as a decentralised energy system (DES) or Distributed Generation [DG]. The role of DG is to provide the flexibility and reliability to the grid through small size plants and the efficient generation [33]. In addition, distributed energy generation is able to exploit local energy generation resources and install energy storage at local sites [34]. The main energy policies to deploy DES are a deregulated energy market and tackling climate change. This will deploy DESs and increase the competitiveness between entities [35].

Paliwal et al. [36] mentioned that there is a fast transition from centralised power generation to decentralised power generation. Furthermore, RES integration with DEC leads to a decreased reliance on depleting fossil fuel, increase security of power supply and reduced carbon emission. The concept of DG has many definitions. The first definition of DG was published by [196], who referred the meaning of DG to the location prospective. He defined DG as “electric power generation within distribution networks or on the customer side of the meter”. Based on the authors review, many different terms have been used for DG. In Anglo-American countries it is known as “Embedded generation” and it called “Dispersed generation in Northern America. Meanwhile, the common term for DG in Europe and Asia is “decentralised generation”. In addition, IEEE has defined DG based on DG capacity which is “ the generation of electricity by facilities that are sufficiently smaller than central generating plants so as to allow interconnection at nearly any point in a power system” [197]. Mehigan et al. define DG according to three core elements: a) connected to the distribution network (b) the customer side of the meter and (c) isolated from the grid and local to the demand it supplies [198].

Many types of DG and main technologies have been used. Basically, a DG consists of traditional generation and non-traditional generation. Traditional generation can include micro-turbines, while non-traditional generation can include RES, storage devices and electrochemical devices (fuel cell). The authors mentioned several applications of DG, such as a standby to supply required power in peak

time or critical situation. It can also produce a combined heat and power supply with high efficiency at the district level [199]. The following figure 2.5 presents the DG technologies.

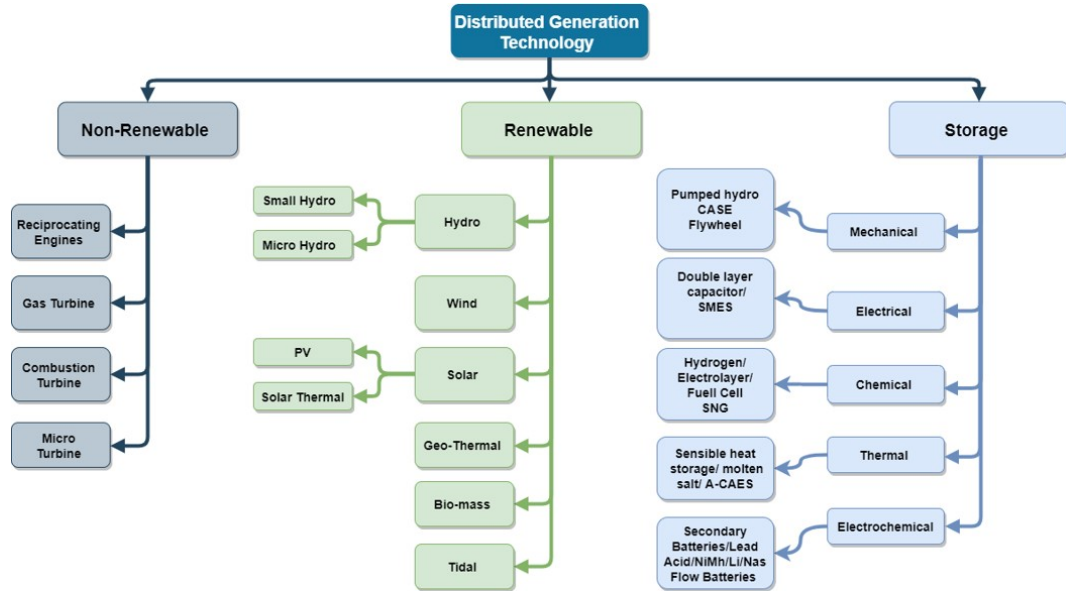

Figure 2.5: Main Distributed Generation Technologies [198]

Labis et al. [200] investigated and compared the cost of line losses, transmission and distribution in the case of laying additional transmission lines, and the cost of carbon emission in case of fossil fuel based on DG, and then calculated the cost of using renewable DG in providing additional power to a small rural electric utility. The result showed that renewable DG is economic in the long term, taking in account fuel and emission cost. Alanne and Saari [34] highlights the major barriers of deploying DG, which is institutional, uncertainty and consumer attitude and social acceptance. The institutional obstacles of applying DG can include grid access, regulation, licensing and planning of system. and uncertainty refers to technology performance and certainty of policy support. The limit of social acceptance refers to inconvenience and the value of housing assets. A report by Ofgem and the UK government lists four key barriers to installing and deploying DG:

1. DG is less attractive commercially due to high capital cost, long payback period and unfair price of export surplus electricity to the grid.
2. Potential users cannot easily find access to a DG data centre, and the incentives are misunderstood.

3. The traditional design of electricity industry structure in UK does not support DG technology to connect and operate within it.
4. The current design of housing policy and planning may find it difficult to interact with DG system.

The cost of power generation from DG is more than cost of power generation from centralised power generation considering the cost of transmission and distribution, and the cost of generation. However, Strbac et al. [201] analysed the cost of power generation from DG and centralised energy system. The result showed that cost of power generation from centralised energy cost 2-3p/kWh, while the cost of power generation from DG is from 4-10p/kWh. An important role can be achieved from DG to environment through CHP with DG technologies and the nature of renewable energy resources. This will lead to a significant reduction of emission and will help to find an optimal energy consumption for communities. Gulli [202] investigated the social-cost benefit of DG in the residential and services sectors. The result shows that DG system is not competitive in the residential and service sector applications. Cao et al. [203] evaluated the carbon emission and energy consumption of DG in a distributed grid in a local city at Chinese city life cycle assessment. The carbon intensity of provincial power grid is evaluated using a grey prediction model. The result showed that integration of DG to the power grid can significantly reduce the carbon emission and carbon intensity, and the author suggested based on this result to integrate DG to power grid wide area. He mentioned some factors that can have an impact on the deployment of DG in future, which are: the location and the availability of natural resources based on the weather conditions; the current infrastructure of power plants, and their reliability; electrification in heat and transportation and storage; social acceptance and customer behaviour; rules, legislation and policies; and high cost of DG technologies [198].

### 2.6.3 Energy storage system

Due to high exploitation of renewable energy sources and depletion on fossil fuel resources, there demand to increase attention given to energy storage systems (ESS). Power production from traditional centralised power generation needs to

## 2.6. THE IMPACT OF ENERGY SYSTEMS IN DECARBONISATION OF SEAPORTS

consumed power instantaneously based on the load requirement. Otherwise, the power production will be wasted, which will have negative effect from economic and operation perspectives. In addition, the intermittent supply of renewable energy sources such as solar, wind and hydro may affect the overall system. Therefore, contingency measures need to be in the system if there is no energy storage system [204]. An energy storage system converts electrical energy from the power network into a form that can be stored to be converted back to electrical energy when needed. This system can reproduce electricity based on status at time of low demand or high power price from the grid. It can also be used at a critical time of peak load or contingency [205]. The figure 2.6 that follows illustrates the concept of an energy storage system.

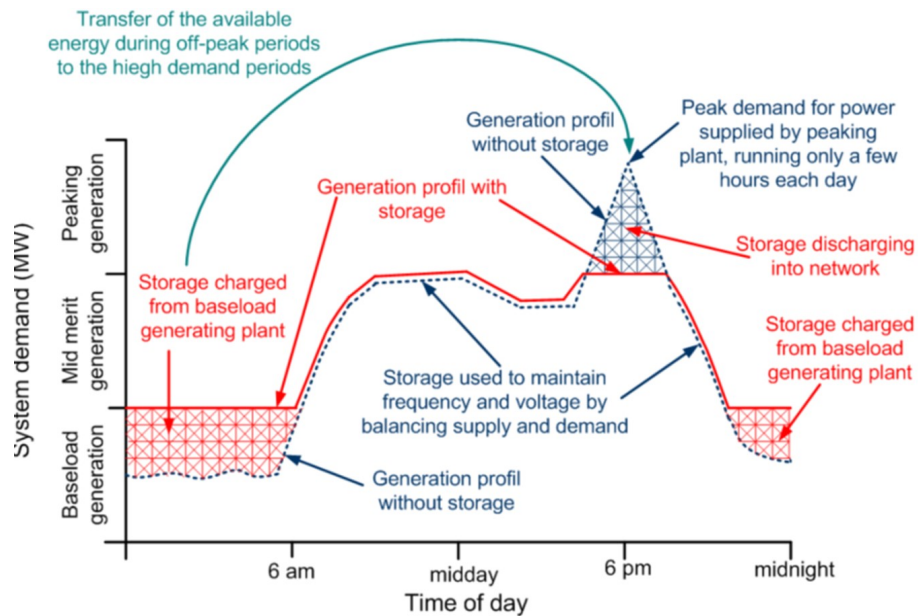

Figure 2.6: The Fundamental Concept of Energy Storage [205]

An energy storage system will help to protect the environment and reduce carbon emissions by reduce burning fuel to generate power and reproduce it from storage system [206]. Therefore, it will conserve fossil fuel; increase the use of different renewable sources; and maintain clean, efficient and affordable energy [207]. There are several types of energy storage technologies and each type of storage technology depends on the purpose of the store. There are two main type of energy stores: electrical energy storage and thermal energy storage. If the energy is stored thermally and then reused in the same form of energy then it is classified



as thermal energy storage. However, when the energy is stored thermally and then released in the form of electrical energy it is classified as electrical energy [208]. Energy can be stored in different forms based on the various types of energy storage technology, such as chemical, electrochemical, mechanical and thermal systems [209]. The use of energy storage is also based on the application type. However, it is crucial for energy storage technology to become more energy efficient [210]. However, some types of energy storage is considered to be viable to apply, due to increase DG and DESs. The main viable types for DG and DES are pumped hydroelectric, battery storage and superconducting magnetic energy storage systems. Energy storage can play vital role in micro-grid applications and it will help to deal with the intermittent supply of renewable energy. It also has a smart impact when interacting with the peak load and regulating the power system in the grid. There are many factors that can help us to identify efficient choice of energy storage, including the practicality of the location from environmental perspectives, cost, reliability, Depth of Discharge [DOD], amount of energy required, life expectancy and efficiency [205]. The figure 2.7 shows the applicable power range and discharge power duration of different energy storage technologies.

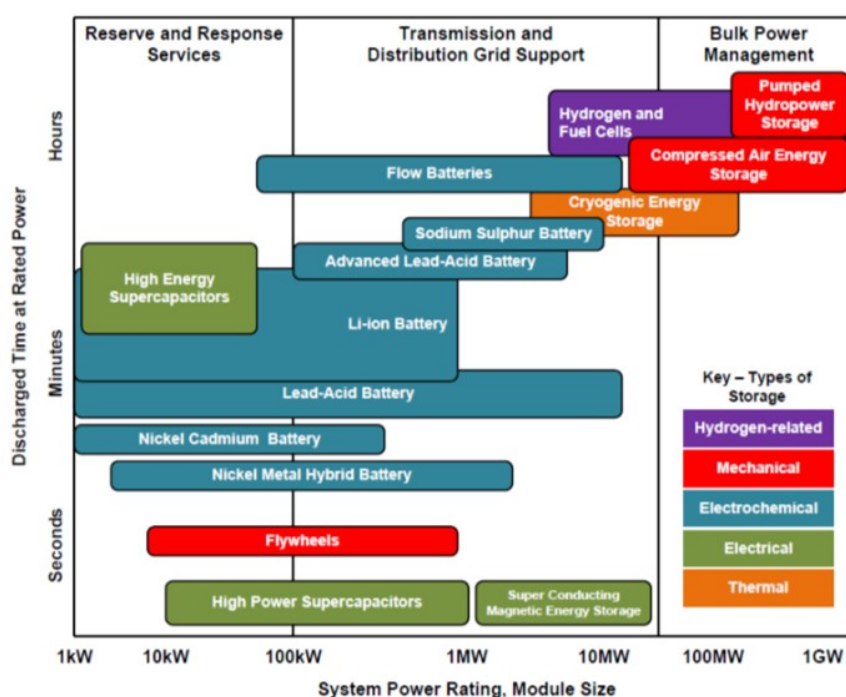

Figure 2.7: Applicable power range and discharge power duration of different energy storage type [205]

## 2.6. THE IMPACT OF ENERGY SYSTEMS IN DECARBONISATION OF SEAPORTS

Energy storage can maintain the energy system's stability and it can play significant role in energy system planning, operation, and frequency. In addition, it will help to improve power quality and meet power demand and supply [211]. However, it is important for micro-grids to use energy storage systems because it gives them a fast response, makes them more controllable and gives them geographical independence. Battery energy storage systems (BESSs) can be integrated into a microgrid. BESSs can not only increase the power quality from short term to long term but can also enhance reliability and continuous power supply[212].The cost of an energy storage system depends on the application of the system, based on variables such as location, construction methods, and system size. Figure 2.8 shows a comparison between cost and capacity between different energy storage technologies.

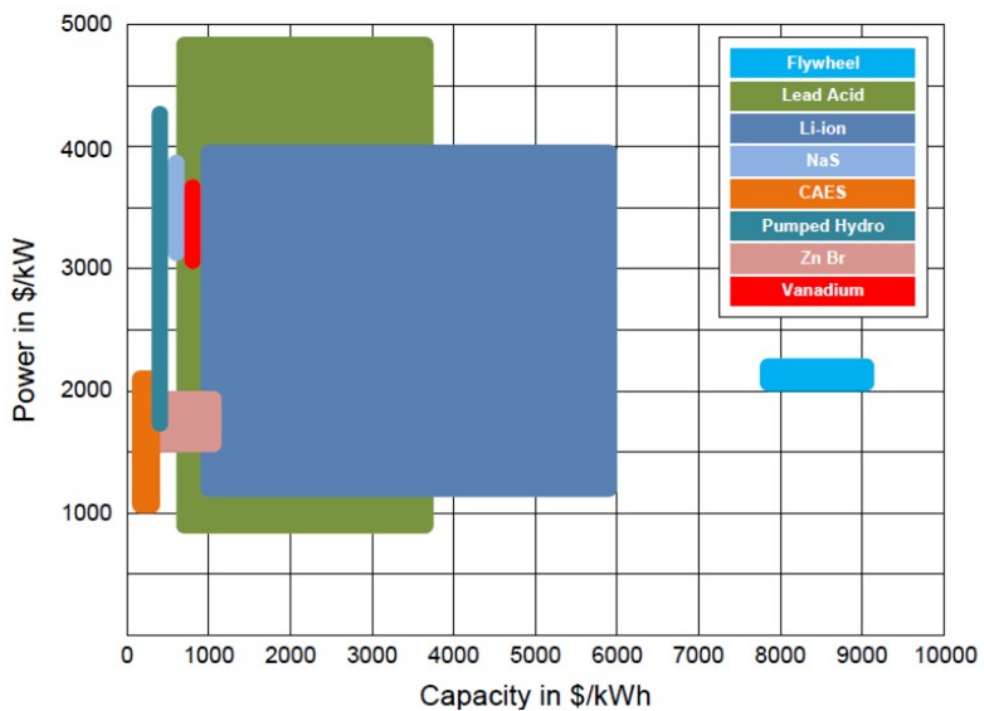

Figure 2.8: A comparison between cost and capacity between different energy storage technologies [212]

A BESS is an energy storage device that is designed to convert its stored chemical energy into electrical energy, while during the charging process energy is stored in the form of electrochemical energy [212]. A BESS consists of a set of cells and it is connected either in parallel or in series to provide the amount of voltage and

capacity. The cell consists of two conductor electrodes and one electrolyte, which are placed together in sealed container and connected to external sources or load.

The electrolyte enables the exchange of ions between the two electrodes, while the electrons flow through the external circuit. BESS is a solution based on low-voltage power battery modules connected in series or parallel to achieve the desired electrical characteristics. A BESS contains batteries, the Control and Power Conditioning System (C-PCS) and the rest of the plant, which provides good protection for the entire system.

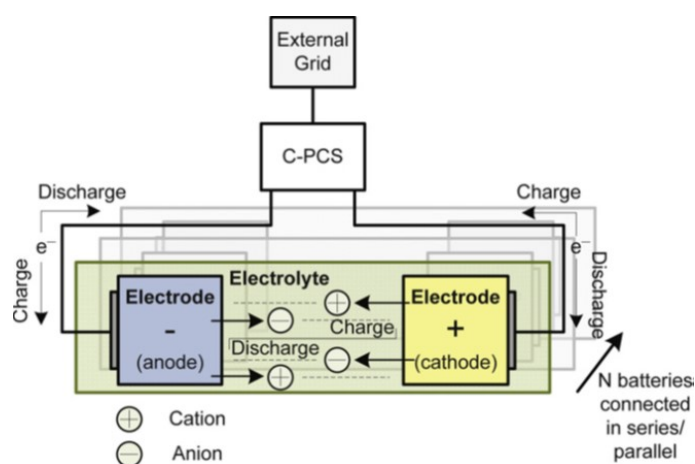

Figure 2.9: Battery storage system [213]

The figure 2.9 illustrates the main parts of battery storage [213]. BESSs are mature storage devices with high energy densities and high voltages. The battery storage can include lithium ion (Li-ion), sodium-sulphur (NaS), nickel-cadmium (NiCd), lead acid (Pb-acid), lead-carbon batteries, as well as zebra batteries (Na-NiCl<sub>2</sub>) and flow batteries [214]. Lithium ions play a crucial role in electrical energy storage due to their high specific energy (energy per unit weight) and energy density (energy per unit volume). One of the greatest concerns of applying a Lithium ion battery is that it can be a considerable safety hazard thanks to its large capacity [21]. The principle operation of a Lithium ion battery is that positive Li ions migrate from the negative plate to the positive plate during discharging and in reversed direction during charging. The electrolyte permits ion circulation but not electron condition. The electrolyte is either aprotic or nonaqueous, due to the high reactivity of the lithium with water[215].

### 2.6.4 Summary

This section highlights power systems and it focus on the centralised energy system era. It has also outlined the revolution of electricity supply in the United Kingdom since privatisation in 1986 until 2016. It then discussed the current paradigm of centralised energy system, and examined the main advantages and disadvantages of the system in light of new updates in energy policies. It then shed light on global motivation toward decarbonisation, with a focus on the United Kingdom and its approach to energy regulation and legislation.

## 2.7 The key components to greening seaports

### 2.7.1 Background

The new approach of introducing information and communication technology (ICT) applications into homes and buildings via automation networks has increased the feasibility of applying a smart energy system in residential and commercial buildings to reduce the environmental impact of energy generation and its usage [216]. However, global energy demand is projected to increase in the next few decades due to population growth and increased industrial activities. The industrial sector is predicted to increase energy consumption by 40 percent by 2040 [118]. The global energy demand forecast shows that there is an urgent need to take further steps to manage energy use to minimise energy consumption and its environmental impacts.

An energy management system (EMS) can help to optimise energy use in buildings and industries [217]. Energy management began in 1970 as a result of increased energy prices and the lack of primary resources [218]. The main objective of an energy management system is to reduce energy cost without affecting production and quality, while minimising environmental impacts [71]. The new approach of energy management systems is smart, efficient, secure and affordable. The new smart energy management system comes under the umbrella of distributed energy resources (DERs), which refers to electric power generation resources that are directly connected to medium voltage (MV) or low voltage (LV)

distribution systems, rather than to the bulk power transmission systems [219]. The new approaches that manage energy use in a DER are a smart grid, microgrid and VPP, which will be discussed in more detail in the following sections.

### 2.7.2 Smart grid

#### 2.7.2.1 Background

The first power generator units only supplied electricity to the closest neighbourhoods because they used DC-based power grids and also because of the limited units of power voltage. Later power grids were able to provide power electricity over long distances using AC-based grids, which is known as a centralised energy system [46]. In addition, the predicted growth of power demand in the coming decades needs a vast response. A smart grid is able to identify quality and cooperate generation and storage options. The objective of a smart grid is to enable the participants and decision makers to find an operation environment that is suitable for both utilities and power consumers. In addition, the residents can adopt a more positive role by adding PV cells or through a storage system [220].

Population growth and the mature economies in developed and developing countries, and increased public awareness toward clean and sustainable energy resources, have led to a major transition in the design of electric energy systems. The transition focuses on smart, green, controllable and predictable electric system design [195]. Smart grid technologies can provide a solution for many power system problems and will provide more sustainable, reliable, safe and quality electricity. A smart grid defined as an electricity network that can efficiently integrate the behaviour and actions of all users connected to it (suppliers, consumers and those that do both) to ensure economic efficiency, and to provide sustainable power systems with low losses and high levels of quality, security of supply and safety [221]. The benefit of using smart grids is that they allow renewable energy sources to integrate with local energy sources to increase the reliability and quality of the power supply across the system. Consumers play a vital role in smart grid technology because they can use energy systems to prevent energy waste or loss, reduce power consumption during peak times, and improve energy efficiency. Cost oper-

ations can also be reduced through the smart use of energy in smart grid organisations [222].

The concept of the smart grid was developed in 2006 by the European Technology Platform, as follows: A Smart Grid is an electricity network that can intelligently integrate the actions of all users connected to it—generators, consumers and those that do both—in order to efficiently deliver sustainable, economic and secure electricity supplies. According to The European Regulators Group for Electricity and Gas (ERGEG), developed based on the definition from the European Technology Platform Smart Grids (ETPS), a smart grid is an electricity network that can cost efficiently integrate the behaviour and actions of all users connected to it generators, consumers and those that do both to ensure economically efficient, sustainable power system with low losses, and high levels of quality and security of supply and safety [221]. According to the US Department of Energy: "A smart grid uses digital technology to improve reliability, security, and efficiency (both economic and energy) of the electric system from large generation, through the delivery systems to electricity consumers and a growing number of distributed-generation and storage resources"[79].

And European technology platform defines a smart grid as "smart grid is an electricity network that can intelligently integrate the actions of all users connected to it generators, consumers and those that do both to efficiently deliver sustainable, economic and secure electricity supplies"[223]. The Department of Energy and climate change in the UK defined a smart grid as "a modernised electricity grid that uses information and communications technology to monitor and actively control generation and demand in near real-time, which provides a more reliable and cost-effective system for transporting electricity from generators to homes, businesses and industry"[224]. The Electric Power Research Institute defined a smart grid as: "The overlaying of a unified communications and control system on the existing power delivery infrastructure to provide the right information to the right entity" [225].

The definition provided by the Energy Networks Association (ENA) states that the Smart Grid is everything from generation through to home automation with a smart meter being an important element, with every piece of network equip-

## 2.7. THE KEY COMPONENTS TO GREENING SEAPORTS

ment, communications technology and processes in between contributing to an efficient and smart grid [226]. In addition, smart grid technology can include the transmission of electricity from suppliers to consumers with the aid of computer systems (through control automation, continuous monitoring and optimisation of a distribution system). This approach aims to save energy, reduce costs and increase reliability [227].

### 2.7.2.2 Smart grid technologies

The National Institute of Standards and Technology divided a smart grid into seven main domains, as shown in Figure 2.10, as follows:

1. Advanced metering infrastructure (AMI),
2. Customer side system (CSS),
3. Electric Vehicle Charging System (EV),
4. Transmission enhancement application (TEA),
5. Distributed energy resources (DER),
6. Information and communication technologies (ICT),
7. Wide-area monitoring, measurement and control.

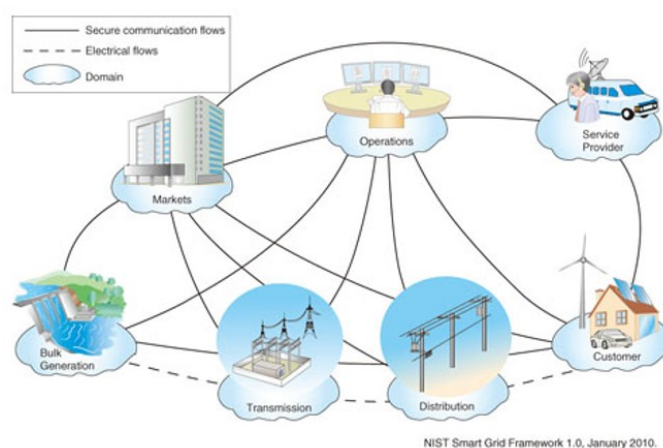
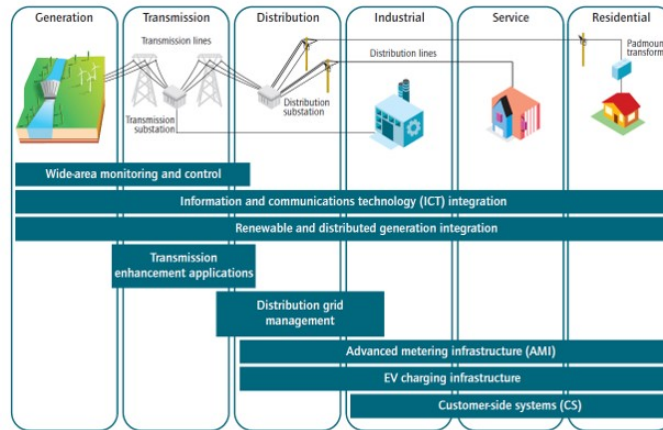

Figure 2.10: The seven domains of smart grid component based on NIST [228]

The figure that follows 2.11 illustrates the interaction between smart grid technologies in the power system, from the generation stage to the consumer stage.

## 2.7. THE KEY COMPONENTS TO GREENING SEAPORTS



Source: Technology categories and descriptions adapted from NETL, 2010 and NIST, 2010.

Figure 2.11: The interaction between smart grid technologies in a power system [228]

### 2.7.3 Microgrid

To limit human made greenhouse gas emissions, new ways of using energy efficiently and generating electricity from clean resources must be found [229]. Microgrids are a promising option for the energy transition era [230]. A microgrid is basically a small-scale localised energy network, which includes loads, network control system and number of distributed energy resources (DER) such as generators and energy storage systems. A microgrid can be integrated with smart elements that been adopted in smart grids to enable DERs and demand response to interact in distribution systems [231]. Based on the US Department of Energy, a microgrid is "a group of interconnected loads and distributed energy resources within clearly defined electrical boundaries that acts as a single controllable entity with respect to the grid". A microgrid can connect and disconnect from the grid to enable it to operate in both grid-connected or island mode [223].

Microgrids consist of distributed energy resources, power conversion equipment, communication system, controllers, energy management system to maintains flexible energy management between entities and consumers [232, 233] There are three different types of microgrid, as follows:

1. Urban (grid tied) microgrids, which has different types of loads and distributed energy resources, and is able to operate in islanded mode. An urban microgrid needs to meet all of the requirements to be fully integrated with a large



grid to rely on overall power quality. This type of microgrid is applicable for campuses, compounds and mall centres [234, 235]

2. Remote microgrids, which are designed for off grid use. It relies on its own systems and does not need to meet requirement to fit with other grids. It requires remote control features to be applicable in different remote areas and serve different communities. However, there is a lack of investment in this type of microgrid due to economic, political and technological reasons [236, 234].
3. Agile microgrids, which are developed to be a temporary solution to meet specific operations in different sites based on the commission. Agile microgrids could be used by the military in a field hospital or for disaster recovery [237].

A microgrid can be combined with renewable energy resources, energy storage, controllers, consumers, grid connected and multigeneration systems. The RES depends on the climate conditions and PV, wind and tidal are intermittent resources [238]. A microgrid needs to be reliable, meet power demand and avoid contingency [239] However, energy storage systems can be used for microgrids to help to solve the problem of intermittency of RES [212]. The operation, control and coordination inside a microgrid could have an impact of the overall performance of the system. Several studies have used optimisation techniques to minimise faults and waste, and maximise performance and profits for the system and users [143]. Furthermore, several researchers focused on minimisation the cost of microgrid operation problems and they used different metaheuristic optimisation techniques [240]. Figure 2.12 illustrates the structure of a microgrid with distributed energy resources [241].

### 2.7.3.1 Review of micro-grids setting in a fishery ports

In the previous chapter, the nature of the energy consumption in the seaport buildings has been analysed , and the amount of energy generated by PV solar system installed on the roof of the building was calculated, which at that time was working in a primitive way by connecting the energy generated in the period of sun rise

## 2.7. THE KEY COMPONENTS TO GREENING SEAPORTS

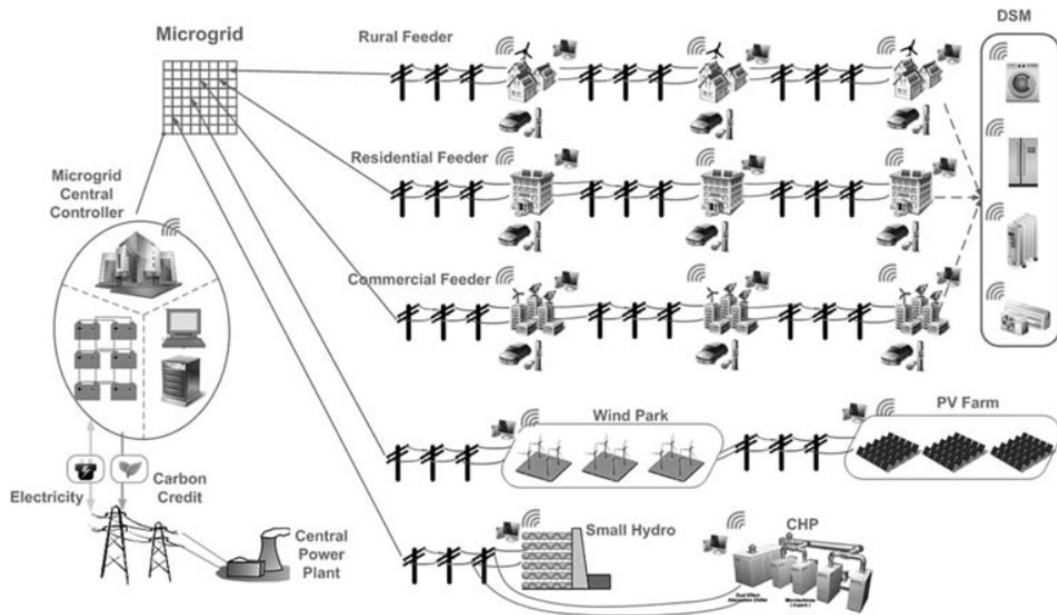

Figure 2.12: The structure of a microgrid with DER [231]

to meet the demand in the building and in case no power demand in the building it is sold directly to the national grid without benefiting or storing it. However, it was important to study the feasibility of implementing a micro-grid proposal at the seaport and to measure its impact at the level of one building.

The implementation and development of a micro-grid in seaports is new and modern, and studies and research in this topic are very few, and focus mostly on the establishment and induction of renewable energy systems of all kinds, which contribute significantly to reducing carbon emissions, as well as replacing the energy used and reducing the prices of spent fuel[242]. The micro-grid is a modern technology that was described in the literature review in Chapter Two. It is currently one of the most promising solutions for the future industries, in which multiple types of renewable energy sources can be combined and implemented via a smart energy management system through automated control systems and AI tools to understand the nature of electricity consumption and generation, as well as to predict the times of need and power generation, which will greatly help to achieve a more efficient network performance and ensure that power is not interrupted during a period of work time [233]. It will also contribute significantly to improving the performance of electric power systems and reducing the waste of electricity in the building, as well as reducing the reliance on electricity from the national grid.

This will help to achieve the green port concept, which focuses heavily on the use of clean energy to meet the need for electricity and to reduce the cost of electricity consumed.

Few studies have discussed the application of a micro-grid for a seaport. The study by Fang et al. [243] discussed the future of micro-grid in seaports. This study proved that a micro-grid for a seaport could play vital role and can have economical and environmental impacts. This study listed the future challenges that stand in the way of deployment micro-grid for a seaport, which are: adaptation of energy management methods, the functionality of energy storage systems and distribution control road map. Meanwhile, the study by [244] highlighted the strategies and technologies that can be used to reduce emissions from ports activities and they supported the deployment of micro-grid as sustainable technology that can help to reduce carbon emission and achieve future green ports. The same author in [245] used HOMER simulation to analyse the feasibility of applying a micro-grid for a seaport, which show that about three quarters of the power can be met from local renewable power sources.

### 2.7.4 Virtual power plant

Due to the increased penetration of DG units and their ability to exchange the energy produced from conventional power plants, high technology is required to meet power demand from the consumer considering economic and security perspectives [246]. In addition, increased deployment of DGs with an absence of a passive approach can reflect the total investment of running DGs in the long term. However, there is a need to start assimilating an active approach, which will help DGs to participate in energy markets [247]. A VPP can be defined as "a single power plant that connects, control and envisions dispersed generators via an information and communication technologies (ICT)" [248]. A VPP is able to manage and control power flow between units [249]. It will also help to optimise energy use and increase the performance of the system [250]. The three main functions of a VPP are dispatch and optimisation, management and control, and integration of DGs and renewable energy resources [251].

The functionality of VPP is to exchange energy with grid network, and control

power supply and demand flow between entities [249]. There are two main types of VPP: a technical virtual power plant (TVPP) and a commercial virtual power plant (CVPP). The role of a TVPP is to help the distribution system operator (DSO) avoid any problems from the local energy system. In addition, it monitors and controls the units, loads, control strategy and battery energy storage in the DG [252]. The role of a CVPP is to optimise and schedule power production based on the forecasted power demand. It also integrates the energy market to maximise revenues chances for the consumers and producers [253]. Therefore, the impact of aggregates TVPP and CVPP will reflect on the stakeholder, DSO, TSO and policy makers in the long run, and it will help to mitigate carbon emission and reduce energy consumption in the long term [254].

### 2.7.5 Net zero energy building (NZEB)

In the last few decades, population growth has increased the need for indoor comfort, which has turned buildings into one of the main causes of global energy consumption and carbon emission [203]. Buildings account about 40 percent of total primary energy consumption [255]. With increased risks of climate change and global warming, there is a global motivation towards reducing energy consumption and carbon emissions of commercial, residential and industrial sectors [9]. Consequently, new initiatives have been introduced to more efficiently use energy in buildings, aiming to become net zero energy buildings. In addition, an increased share of renewable energy sources which will help to limit the use of fossil fuels in buildings through a decentralised approach[256]. The concept of a NZEB aims to reduce dependency on fossil fuels in the building by implementing energy efficient measures and producing clean energy to meet local energy demand [257]. The Energy Performance Building Directive (EPBD, 2010/31/EC) defined a NZEB as “a building with very high energy performance where the nearly zero or very low amount of energy required should be extensively covered by renewable sources produced on-site or nearby” [258].

There are four principles to design a NZEB [259]: first, reduce the energy demand for all new buildings, including internal heat, envelop loads and HVAC equipment energy consumption. Second, improve indoor environmental quality through

set up minimum fresh air, accessing daylighting and set up maximum capacity density. Third, provide a renewable energy share by producing energy from renewable sources on-site and meeting power demand from renewable energy sources. Finally, reduce energy consumption and carbon emission. Figure 2.12 presents the fundamentals of a NZEB design.

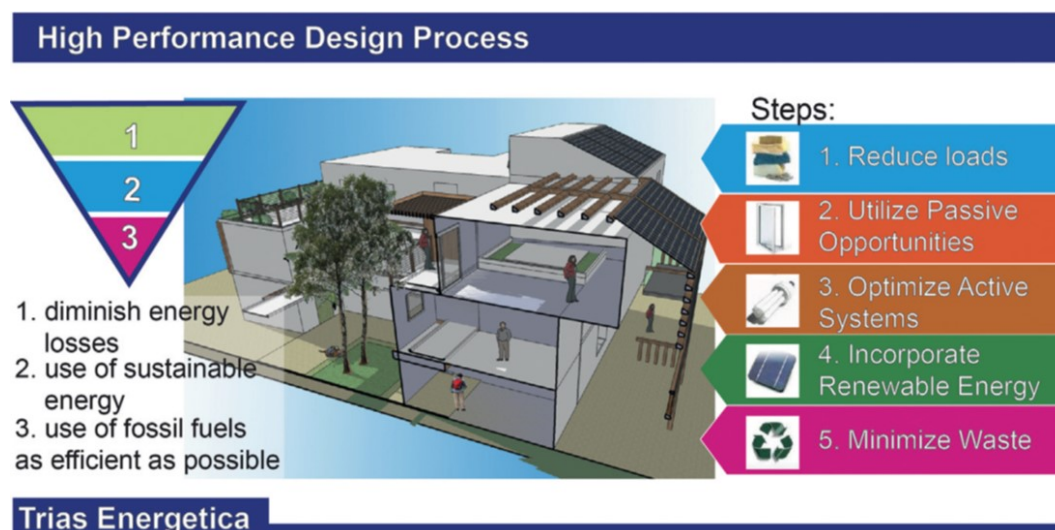

Figure 2.13: The fundamentals of a NZEB design [259]

### 2.7.6 Artificial intelligence

AI applications for environmental modelling are increasingly being used due to their ability to solve complex problems [260]. AI mimics human perception, learning and reasoning to solve complicated problems [260]. An AI is defined as the science and engineering of making intelligent machines, especially intelligent computer programs. Furthermore, AI techniques can be divided into four areas: expert systems (ESs), fuzzy logic (FL), artificial neural networks (ANN) and the genetic algorithm (GA). ESs, which are also known as knowledge-based systems, can be defined as computer programs that incorporate knowledge from experts in specific disciplines to analyse problems for users [261].

Yager and Zadeh [262] describes vagueness as a linguistic expression instead of a mathematical description. Meanwhile, an ANN [263] is a mathematical simulation of human neural networks for processing information and consists of layers of artificial neurons linked by weighted connections. The GA [264] is a search engine

technique used to find the best or approximately best solutions for optimisation problems [265]. AI techniques are applied for the prediction, optimisation, modelling, and simulation and control of complex systems such as adaptive control, scheduling, optimisation and complex mapping [266]. AI has been used in many disciplines, such as engineering, medicine, economics, military, and so on [267].

In the energy sector, AI plays a crucial role in every stage of the supply chain of energy systems; from power generation, to transmission, to distribution, to the end user [268, 269, 270, 271]. AI can increase the energy efficiency of power systems via intelligent energy management systems for seaports [272, 273, 274]. AI can also increase the security of the power supply and help reduce the cost of power [275].

### 2.7.7 Information and communication technology

Information and communication technology (ICT) is one of the basic elements in modern society. ICT is also the core element of the industrial sector. UNESCO defines ICT as the combination of informatics technology with other related technologies, specifically communication technology [276]. The role of ICT in a smart grid is to build highly flexible and reliable communication infrastructure that allow protocols to enable real time interactions between producers and consumers in a smart grid [277]. There are three types of communication technology in a smart grid:

- Communication based on the electrical grid.
- Communication based on cable infrastructure and telephone lines.
- Wireless communication.

The most commonly used communication strategy is a combination of a smart meter and a data concentrator, via a Power Line Communications (PLC). The second strategy involves a combination of a data concentrator and a meter data management system; GPS-GPRS is the most commonly used system [278]. In the power grid, there are three layers of the power system: generation, transmission and distribution. The current system for collecting data and exchanging it with the power grid system consists of three ICT network layers:

- Wide Area Network (WAN).

- Neighbourhood Area Network (NAN).
- Home Area Network (HAN).

The WAN is responsible for collecting and routing the data for generation transmission and distribution. However, NAN and HAN are responsible for covering the data in the second stage of distribution and delivering energy to customer's homes

### 2.7.8 Internet of Things

The IoT is a new paradigm of information technology [279]. The Internet is a worldwide system that interconnects computer networks based on a standard Internet protocol suite, which serves hundreds of millions of users worldwide. The Internet consists of millions of private, public, academic, business and government networks connected by a broad array of electronic, wireless and optical networking technologies [280].

The IoT aims to allow the trusted exchange of useful data between unseen, embedded and uniquely identifiable devices through Radio Frequency Identification (RFID) and Wireless Sensor Networks (WSNs) using sensor devices and multiple processors for decision making to facilitate automation [281]. The use of IoT for port activities was described by Sarabia-Jácome et al. [135], who developed a seaport data space that will help avoid the interoperability of the stakeholder information system as shown in Figure 2.14. The results show that the seaport data space improves the decision-making process between seaport departments. Another study investigated the use of an Automatic Mooring Systems (AMS) that allows vessels to be moored without a robe, showing that such a system can reduce carbon emissions [93].

### 2.7.9 Summary

This section has discussed smart energy management approaches including smart grid and its technologies, and an integration approach with a power system. It has discussed a microgrid system, including the three main types of MG. This is followed by VPP technology and its role in the new paradigm of energy system. Furthermore, NZEBs have been described. There are some previous studies in the

application of a smart energy management system for fish processing industries and Fishery ports. One of the best solutions that can optimise energy usage is numerical simulation modelling with direct impact on energy savings, time optimisation, and costs. This simulation analysis can detect and predict failures, and provide real-time energy optimisation in various use-cases. A related study proposes a framework that applies a microgrid approach with integration of renewable energy sources to operate an Indian port [282]. Another study proposed a smart grid approach for the port site and considered using renewable energy sources and cold ironing technologies [283]. For an energy system that aims to meet local power demand at fishery port sites, there is a need to balance the energy storage against the energy usage to ensure an uninterrupted supply. Therefore, it is essential to select the correct number of PVs and batteries [284], which has attracted extensive research. Other research studies [285] have applied techno-economic benefit optimisation for community energy systems to identify the optimum energy storage size for community houses. This study found that the use of Li-ion battery storage is the best choice for energy community with large PV generation. Related studies [286] used Genetic Algorithms to find the optimum size of a PV and battery storage for a local community to reduce energy cost.

## 2.8 Energy analysis and simulation techniques

### 2.8.1 Overview

In last few decades, there has been a noticeable increase in energy use in the industrial sector, which is predicted to double in the next decades due to fast growth

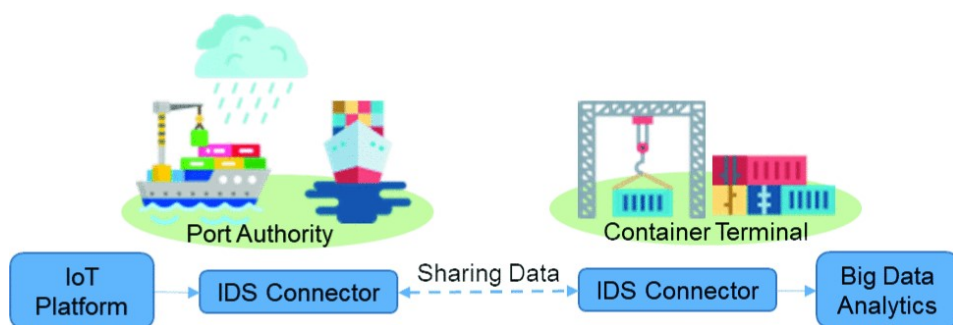

Figure 2.14: The proposed seaport data space architecture [93]



of smart technologies, such as Industry 4.0 , IoT and cyber physical systems [287]. However, there is great motivation toward optimising energy use in the industrial sector via techniques that can reduce energy consumption, and therefore reduce cost of energy and decrease an intensive amount of carbon emission [288]. This section will review the most recent smart techniques that will help to optimise energy use in the industrial sector.

### 2.8.2 Energy auditing

One of the most effective techniques of optimising energy use in industrial is energy auditing. Energy auditing is a comprehensive assessment of a building's layout and its appliances. This will identify the energy consumption requirements of the building and provide an opportunity to explore ways to reduce energy consumption without impacting negatively on energy bills or the occupants. Doty and Turner recommend that a detailed report should be implemented to demonstrate the current energy requirement and layout of the building [289]. Based on ASHRAE, energy auditing can be defined as follows: "Preliminary Energy Use Analysis. This involves analysis of historic utility use and cost and development of the energy utilisation index (EUI) of the building. Compare the building's EUI to similar buildings to determine if further engineering study and analysis are likely to produce significant energy savings" [290]. The process of energy auditing can be divided into three phases [291].

1. Pre-audit phase, which covers a walk through visit of the site, and a questionnaire and interview with energy related staff at the site. This stage will help to understand the process of the site and the energy use, which will help to identify sensitive areas of energy consumption that can be optimised.
2. Audit phases, which are the main core of the energy auditing process. This starts by analysing interviewing and questionnaire from energy related staff in the site and also analysing utility bills for 12 months. Moreover, data of local energy appliances is collected, and the efficiency and operation time of the appliances is investigated. The following step is to use energy simulation software to model the energy site and identify the opportunity areas

## 2.8. ENERGY ANALYSIS AND SIMULATION TECHNIQUES

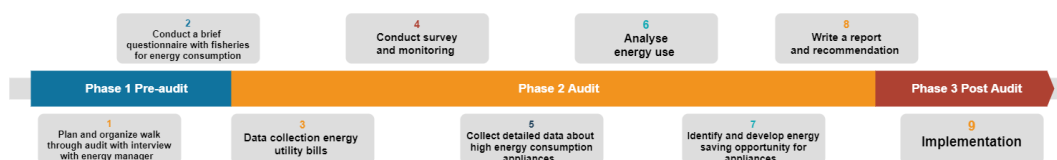

Figure 2.15: Energy auditing phases [291]

of optimisation energy use. The final step is to write an energy proposal report about the site, which contains recommendations to reduce energy consumption and energy efficiency.

3. Post-audit phase, which refers to the practical steps at the site to install or change the recommended appliances to improve energy efficiency.

An energy audit can be an effective tool where data is lacking at the site and it can help to identify the optimum recommendations of energy use at the site using energy auditing process [292]. However, an energy audit does not directly reflect on energy savings but it will help to shed the light on the areas of energy optimisation at the site [293]. Several studies have mentioned the impact of an energy auditing on energy systems. Energy savings are the most obvious result of an energy audit. And as result of energy saving, the cost of energy use will be reduced. In addition, carbon emissions will be reduced because waste of energy is minimised [291, 294, 295]. In addition, some studies have shown that an energy audit could improve processes in organisations [296] by reducing energy intensity and reducing carbon emissions, which will reflect on the energy efficiency of the manufacturing process. The emission trading scheme is one of the first major markets for trading greenhouse gas emission at an international level. The directive has been enacted in 2010 under the number of 2010/75/EU. The ETS aims to minimise emissions from the industrial sector by more than 11,500 installations. The energy auditing process will help to increase energy efficiency in the industrial sector [297], which will benefit the sites, and the community and environment.

### 2.8.3 Modeling and simulation of an energy system

The role of energy simulation software is to minimise energy consumption, which will reflect directly in the energy cost. It will also help to optimise energy use by identifying the sensitive parameters that effect the overall energy use in the properties[298]. In addition, energy simulation programs can be used to evaluate the impact of new policies and regulations for energy systems, which will help decision makers to develop business strategies and evaluate business opportunities based on the evolution of the energy system. A simulation of the energy system helps to monitor and analyze the actual energy use in the property, and therefore compare it with measured energy use to detect and diagnose faults in the system. Furthermore, a simulation can be used to test and implement new products for the property, such as new types of window (e.g. double glazing, smart cooling system, led lighting, fans etc.). It can also help to estimate the capital cost and energy consumption [299].

#### 2.8.3.1 Energy system: Definitions

Modernisation has harnessed different forms of energy to extend human capabilities and ingenuity. Energy plays a vital role in daily life and is fundamental for modern life [300]. An energy system comprises energy supply sector and the end use technology needed to provide energy services [301]. In addition, energy systems are based on converted primary energy resources to energy carriers, such as electricity that is used by end users for cooling, heating and lighting [302]. The [IPPC] defined energy supply sector as follows: “ Comprises all energy extraction, conversion, storage, transmission, and distribution processes with the exception of those that use final energy to provide energy services in the end-use sectors (industry, transport, and building, as well as agriculture and forestry” [303].

#### 2.8.3.2 Energy models

Modeling can be defined as “ the act of interpreting a set of physical phenomena and of devising a reasonably complete, closed and comprehensive phenomenological and mathematical formulation for its description” [304]. Energy models

aim to represent and simplify real systems to perform test and experiments, which might be impractical and costly [305]. The modeling process through computerisation can have a positive impact, due to the computational modellers' assumptions through logical consequences. It also able to interrelate many factors instantaneously. There are six types of energy models, as follows: optimisation models, decentralised energy models, energy supply/demand driven models, energy and environmental planning models, resource energy planning models and energy models based on neural networks [306]. decneterlization and optimiztion energy model are between the most popular energy models. The decentralised energy model seeks to meet energy demand from different resources. Its objective is to minimise total annual energy cost, carbon emissions and maximise overall system energy efficiency [307]. In addition, the decentralised energy model will help to predict total energy supply/demand and estimate the overall cost of the system before execution. It will also help to assess the attitude of social and technical parameter, and their impact on real life. Consequently, it will to implement the overall system and give a clear understanding of the system. an optimisation model will is to find an input of function to minimise or maximise its value, which could be subjected to constraint [308, 309].

### 2.8.3.3 Energy simulation

The Cambridge Dictionary defines simulation as "a situation or event that seems real but is not real, used especially in order to help people deal with such situations or events [310]. According to Schriber: "Simulation involves the modeling of a process or system in such a way that the model mimics the response of the actual systems to events that take place over time" [311]. The simulation process occurs by using energy simulation programs that are designed to calculate the amount of energy use per unit considering several parameters. This allow simulation users to identify the behaviour of energy system in the unit [312]. The role of energy simulation software is to minimise energy consumption, which will reflect directly on the energy cost. It will also help to optimise energy use in properties by identifying the sensitive parameters that effect the overall energy use [298]. In addition, energy simulation programs are used to evaluate the impact of new policies

and regulations of energy systems, which will help the decision makers to develop business strategies and evaluate business opportunities based on the evolution in energy systems [313]. The simulation of energy system helps to monitor and analyse the actual energy use in the property, and therefore compare it with measured energy use to detect and diagnose faults in the system. Furthermore, simulations can be used to test and implement new products for the property, such as new types of window, smart cooling system, led lighting, fans and so on. This will help to estimate the capital cost and energy consumption [299]. Furthermore, computerised based-simulation can be categorised into discrete event simulation (DES) and continuous event simulation (CES) [314]. The DES approach solves problems with changing variables in discrete time by discrete steps. Meanwhile, CES can be used for systems with continuously changing variables [315]. DES is more practical to use for analyze the dynamics of production systems [316]. However, CES is better to use for analyze energy flow of loads in production processes, due to the continuous variation of loads through time periods [317].

### 2.8.3.4 Energy simulation tools

In the last few years, the number of energy simulation tools (i.e., commercial, open source and academic) has increased and they have become available for different types of energy applications. The capability of new smart systems has helped computer engineers to develop new dynamic simulation models that can show remarkable outcomes thanks to accurate results. The graphical user interface (GUI) of energy simulation tools made by the operating system (i.e., Microsoft Windows, Mac, and Linux) has helped design engineers to get more accessibility to the system [318]. One study has shown that the most complete energy simulation software tools are the EnergyPlus, the ESP-r (Energy Simulation Software tool), the IDA ICE (Indoor ClimateEnergy), IES-VE (Integrated Environmental Solutions - Virtual Environment) and TRNSYS[189]. Furthermore, energy system simulation tools can be formalised in equations based on block flow diagram tools, such as MATLAB/SIMULINK. “MATLAB is a high-performance language for technical computing. It integrates computation, visualisation, and programming in an easy-to-use environment where problems and solutions are expressed in familiar mathemat-

ical notation” [319]. SIMULINK “is a block diagram environment for multidomain simulation and Model-Based Design. It supports system-level design, simulation, automatic code generation, and continuous test and verification of embedded systems. It provides a graphical editor, customisable block libraries, and solvers for modeling and simulating dynamic systems. It is integrated with MATLAB, enabling you to incorporate MATLAB algorithms into models and export simulation results to MATLAB for further analysis” [320]. One of most efficient uses for modeling techniques for energy systems is co-simulation, which “is an emerging enabling technique, where global simulation of a coupled system can be achieved by composing the simulations of its parts” [321] Building Control Virtual Test Bed (BCVTB) is one of the most efficient platforms for co-simulation between energy simulation tools. It allows users to couple different simulation programs for co-simulation, and to couple simulation programs with actual hardware. For example, the BCVTB allows us to simulate a building in EnergyPlus, and the HVAC and control system in Modelica, while exchanging data between the software as they simulate [78].

### 2.8.4 Scheduling appliances technique

Due to high electrical energy consumption in buildings, and commercial and industrial sectors, some countries have introduced a practical method to help to reduce energy consumption. For example, Australia has applied energy conservation measures to reduce energy consumption from electrical appliances (e.g., lighting, heating, ventilation and air-conditioning systems) [322]. However, ECM must not effect the comfort of the occupant. The ECM can be divided into two basic methods. The first method contains physical changes or adds to the exist system in the building, such as replacement of lighting system or adding sensors to the lighting system. This first method changes the process of operation of the system, such as scheduling appliances [323]. A strategy of building energy management system proposed to control energy flows in the building and reduce the total cost of energy. Framework consists of three modules which is prediction, long term scheduling and real time control. Long term scheduling can tan take an optimal decision based on some input variables such as (load consumption, available solar power and power price) [324]. Another study used an optimisation model to

reduce power cost for residential demand response through scheduling home appliances. A mixed integer nonlinear optimisation model has been applied in this study using time of use electricity tariff. The authors found that electricity cost can be saved up to 25 percent [325]. Another study examined a new development of home scheduling appliances to reduce total load curve. Appliances have been categorised based on flexible, non-flexible deferrable loads. A dynamic algorithm has been applied to solve two multi-objective optimisation problems [326]. The first to flattening power consumption of non-flexible load and the second to strength power of flexible loads. Lu et al. [327] developed an optimal scheduling model for home appliances for smart home consider demand response to reduce power cost. The problem solved as mixed integer nonlinear programming. The result of this study showed that power cost reduction with about 34.71 percent considering incentives as effective variable to shift the load. The types of HVAC scheduling are shown in the figure 2.16 that follows.

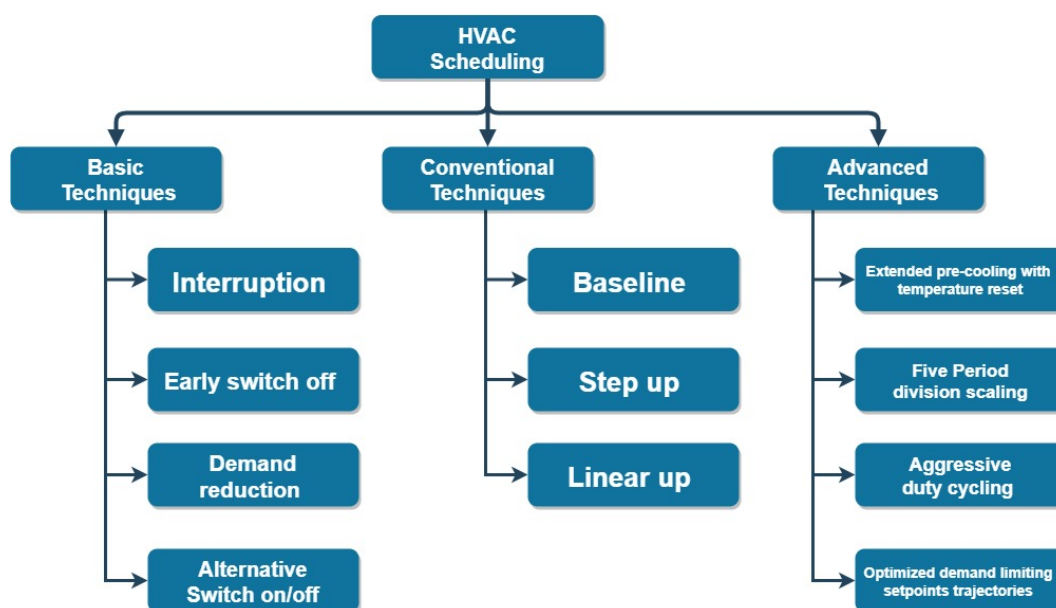

Figure 2.16: HVAC scheduling teypes [322]

AlSkaif et al. [328] created a framework for a household micro-grid aiming to increase the self-consumption of their on-site RES through a storage system. Their framework used an optimisation problem by EMS linking with schedule appliances power consumption and the energy that each home-owner can get from the storage unit. The mixed integer linear programming used to solve scheduling prob-

lem and simulation result showed that cost saving of 68 percent through sharing only different classes of home-owner that exist in the micro-grid. Setlhaolo et al. [325] developed scheduling appliances with battery storage system under a time-of-use electricity tariff. A mixed integer nonlinear programming model used with practical operation constraints to solve the problem. The simulation result showed that about 22 percent cost saving, and 1.96 kW peak reduction could be achieved without battery and coordination. A study created energy management model for scheduling home appliances to reduce electricity bills, peak to average ratio and increase consumer comfort in a micro-grid. Heuristic techniques have been used to optimise scheduling appliances to reduce electricity bills Hussain et al. [329]. Another research suggested a green methodology that will help to increase use of green energy sources. In addition, a greedy algorithm has been proposed to order different energy sources based on their estimated price forecast. An artificial neural network has been used to schedule appliances to reduce total energy cost [330]. A group of researchers used an optimisation algorithm for the problem of scheduling appliances in smart homes in order to reduce electricity cost and reduce peak load. Mixed integer linear programming has been used to solve this problem. PV systems have been added to a home energy system to reduce electricity cost [331].

### 2.8.5 Applied Real decision-making systems for Energy Management systems

Fishery ports include all of the operations that are required to catch and prepare fish and other seafood to create the final product that is delivered to customers [332]. This activity requires intensive on-site energy [86] throughout the fish production lifecycle from the fishing stage to the freezing and packaging process, which is mainly derived from electricity and liquid fuels [333]. Electricity is typically used to power processing equipment, lighting, cooling, and freezing [334]. A wide range of variables impact energy consumption in the fish processing industry, including the age of the plant, level of automation, and type of production process. Furthermore, a seafood product production line can involve heating, cooling, and other types of equipment [335]. According to the Irish seafood development agency,



Bord Iascaigh Mhara, about 15 percent of global fishery port energy consumption is related to refrigeration and air conditioning [336]. Considering the intensive energy use of such cooling systems, any inefficiency can result in sizeable quantities of emissions from refrigerant gases such as ammonia [337]. P2P energy trading has recently been presented as a next generation energy management system that can enable prosumers in a smart energy community to share their extra energy with others. To accomplish this energy trading, the P2P mechanism needs a robust decision making process and a reliable mathematical model that will ensure shared interest and optimal motivation between prosumers [338, 339]. Various studies have applied game theory approaches to P2P energy trading due to their feasible and effective means of modelling the energy management system. They have done so using different types of algorithms: the Stackelberg equilibrium game was used in [340, 341, 342, 343] to optimise the energy cost and social benefit in P2P energy trading; a game theory approach was developed in [344, 345, 346, 345, 347] to optimise energy use and maximise energy incomes for P2P energy prosumers; Harish et al. [348] proposed a nonlinear optimisation problem to minimise energy cost and energy losses during transmission; Long et al. [349] developed a linear programming problem to maximise the local balance between participants; and Zhong Zhang [350] and Nguyen et al. [351] applied mixed-integer linear programming P2P energy trading.

## 2.9 The current status of Energy use at fishery Ports

The fishing industry is one of the most important traded products in the world, due to the growing demand and enlarging supply of fishery and aquaculture products. Based on the Food and Agriculture Organization (FAO), the total world fish production in 2016 is about 171 million tonnes compared to 19.3 million tonnes in 1950 [148]. The sea food trade includes a diverse range of products, from high value species such as shrimp, salmon, tuna, groundfish, flatfish, sea bass and sea bream to low value species such as small Pelagic, which has been traded in high quantity and exported to low income countries [352]. The global investment in fish products increased significantly during the last 40 years, from € 8 billion to about € 133

billion in 2017 [353]. In addition, the fish processing industries include operations to prepare fish and other seafood in such a way to create the final product that will be delivered to the end user customer [332]. There are two stages for fish processing: the primary processing stage, which includes cutting, filleting, picking, peeling, washing, chilling, packing, heading, and gutting; and the secondary processing stage, which includes brining, smoking, cooking, freezing, canning, deboning, breasting, vacuum and controlled packaging, production of ready meals [354].

One of the key environmental impacts of fish processing industries is energy consumption, which is an essential part of most processes on site [333]. For the fish processing industry, energy consumption is dependent on the type of activity. The main sources of energy are electricity and liquids fuels. These two sources share in different operations in the processes, from the fishing stage to the frozen or canned products [355]. Electricity is used in the fish industry for powering processing equipment, lighting, cooling and freezing [334]. Meanwhile, energy consumption in the fish industries is based on many different variables, such as the age of plant, level of automation, and level of processes for production, while the production of seafood products includes heating, cooling and different kind of equipment [335]. Cooling and freezing in the fish industry are responsible for an intensive amount of electricity consumption. Based on Ireland's Seafood Development Agency (BIM), about 15 percent of energy consumption in fish industries globally is related to refrigeration and air conditioning systems [336]. With the continuous energy use for cooling systems in the fish industries, the inefficient use of cooling systems can result in a huge amount of emissions from refrigerant gases, such as ammonia [337, 356].

### 2.9.1 Energy cost

In the last few decades, the cost of fuel and energy has increased, which has had a direct effect on the food processing industries at a global level [357]. The use of fuel and energy depends on the type of process. The amount of energy use and fuel consumption reflects on the amount of fish production. However, the cost of energy and fuel are sensitive variables based on the revenue of fish trading from the processes. For the fishery industries, the energy cost can be high. Fuel equivalent

Table 2.5: The estimated energy usage and expenses at fish industries - UK

Component	Estimated energy (GWh)/yearly	Equivalent cost at \$ 0.15/kWh(Million)
Blast freezers	10.9-20.7	1.7-3.2
Blast chillers	12.5-30	2-4.5
Cold stores	45	6.8
Refrigerated transport	241	36.2
Catering fridges	200-238	30-45.7
Retail displays	288-635	43.2-95.2
Total	797-1210	119.5-181.5

levels are associated with the direct consumption of fuel and electricity, considering the direct fuel and electricity involved in production and the fuel involved in harvesting raw materials, processing them, and distributing the manufactured feed to production. Globally, the total energy cost of the fishery industries is about (€ 9.85 billion) [70]. It has been estimated that the energy consumption of blast freezers varies from 10.9 to about 20.7 GWh, at the equivalent cost of 1.7 to 3.2 million at USD 0.15/kWh. About 45 GWh is used for cold stores, with a total cost of 6.8 Million at USD 0.15/kWh [358]. The United Nation Environmental Programme (UNEP) estimate for the global energy consumption and cost of aquaculture processing is given in the following table 2.5 [359].

### 2.9.2 The challenges of energy use for fish industries

The fish processing industries consume an intensive amount of energy and they are responsible for a huge amount of carbon emissions. Fish processing has many different stages, starting from catching the fish to delivered product to the end users. However, cooling and freezing in the fish industries are responsible for a huge amount of electricity consumption. Based on Ireland's Seafood Development Agency (BIM), about 15 percent of global energy consumption is related to refrigeration and air conditioning [336]. With such an intensive energy use for cooling systems in the fish industries, the inefficient use of cooling system can result in a huge

amount of emissions from refrigerant gases, such as ammonia, or different kind of gases [337]. Cold storage in the fish industries works for 24 hours and consumes about 80 percent of total energy consumption of energy use in the fish industries. In addition, processing equipment can consume a considerable amount of energy in hot seasons, which can increase the amount of energy consumed [360]. So, the continuous operation of cold storage and other equipment in the fish industries is a main challenge, followed by the increased cost of energy, which might not meet the revenue of catch land fish. Therefore, it will reflect on the overall system. Furthermore, the global motivation toward decarbonisation, especially in the industrial sector, might need to meet the local obligation policy of minimising carbon emission, minimising energy consumption and increasing the use of renewable energy sources at local sites [361].

## 2.10 Gap identification

Seaports are the main arteries to transport materials and goods between countries, through shipping, and import and export operations. They are important in commercial dealings and purchases of consumer goods such as food, medicine, and others. Maritime transport operations are considered to be vital and strategic pillars on which many of our modern economies are based. However, the world faces a critical challenge from increased carbon emissions, which has prompted Western economies to initiate actions to reduce carbon emissions through a number of international agreements and alliances.

Maritime activities can play an effective role in contributing to the reduction of carbon emissions, which will be directly reflected in the level of performance, quality and competitiveness of seaports, as well as enhancing the level of sustainability in their local ecosystem. The previous sections have elaborated on the increasing volume of research aimed at decarbonising seaports, including the development and design of applied methodologies to quantify carbon emissions produced from port activities [362], study and analysis of renewable energy sources systems deployment [245], and also improving the efficiency of maritime transport [363].

One of the major issues that faces the fishing industry is the continuous rise of

energy prices. This poses a major challenge as the pace of work increases and the demand for fish products increases significantly. This comes at a time of increasing international pressure and global motivation to address climate change and reduce carbon emissions in many sectors.

However, very few research studies were found to highlight the optimal use of power energy in ports and fishery buildings while some studies proposed certain measures that contribute to some extent to reducing energy consumption and carbon emissions. However, there is an absence of a study discussing the possibility of developing a holistic energy analysis and management that can be scaled from a site to a community level to achieve economically and environmentally viable benefits to the community.

In addition, from the analysis of previous research studies, six themes have been identified that play a role in decarbonising seaports and fishery industry, which are: reducing carbon emissions, adopting renewable energy resources, optimising the cost of energy, adopting smart control strategies, developing the regulatory landscape for greening seaports, and applying best practice guidelines to greening seaports and fishery industries.

Moreover, decarbonising seaports can have a profound transformation on port activities, as elaborated in the following sub-sections.

### 2.10.1 The lack of total lifecycle approach to seaports decarbonisation

Most of the previous studies focus on developing strategies that contribute to reducing carbon emissions in seaports by optimising the energy mix [364], improving the energy efficiency of the equipment and machinery used in ports [365], and mitigating the environmental impact of ships by reducing their speed and scheduling their arrival and departure from seaports [104]. These actions have the potential to contribute significantly to reducing the carbon footprint of modern seaports. In this context, Lifecycle Assessment (LCA) helps to quantify the environmental pressures, the trade-offs, and areas to achieve improvements considering the full lifecycle of seaports, from design to recycling. However, current approaches to LCA do not factor in consistently (both in the foreground and background inventory sys-

tems) lifecycle variations in: (a) seaport building use, (b) energy supply (including from renewable sources), and (c) building and environmental regulations, as well as changes over the building/seaport and the local neighborhood lifetime. These include: (a) change in the energy mix of a seaports or upgrading and retrofitting the energy system(s) in place; and (b) time-increase of energy demand during the lifetime of a seaport, due to a wide range of reasons such as changes in activity patterns. Seaports present the highest complexity within LCA, which precludes the use of linear and static approaches but instead requires the use of scalable approaches that factor in dynamic and non-linear considerations. Seaport processes involve longer time scales than in other industries, and therefore they face very different operational and environmental conditions. Consequently, consideration of the time dimension in port activities modelling is essential to understand the resulting pollutant emissions and resource consumption. This time dimension is currently missing in Life Cycle Inventory databases. A further combination of Life Cycle Impact Assessment (LCIA) models using time-dependent characterisation factors can, therefore, lead to more comprehensive and reliable LCA results. Consequently, real-time LCA approaches that address temporal and spatial variations in the local seaport ecosystem are required because they would more effectively promote a ‘cradle-to-grave’ environmental sustainability capability” [366].

### 2.10.2 The lack of semantic-based modelling, forecasting and optimisation of seaports energy systems

In the complex seaport digital energy landscape, energy software services that address the needs of a wide variety of stakeholders (including prosumers) are required. These include forecasting and simulation services, as well as the responsive day-ahead and intra-day management services that are necessary to effectively integrate distributed energy resources in seaports, including renewables. This includes the ability to predict behaviours, and adapt to changing weather and technological environments. It is argued that as the density of local renewables increases, this importance extends beyond the unit level to intelligence at the system level, where the impact of uncertainty at each node can be mitigated through the emergent behaviour of adjacent distributed energy resources.

An optimal management of energy systems should be considered by systematically analysing the decision space of management topologies, schemes, and operating parameters, which are best conveyed by semantic models, such as ontologies. Energy system optimisation is far from novel, but most approaches consider the system as a static entity and they only consider a single system rather than the holistic perspective of emerging system of systems landscape. This thesis advocates the previously described systems approach of energy management, which is best conveyed through semantic models that provide a holistic conceptualisation of energy systems and their socio-technical constituents.

This is essential to address a wide range of scenarios, such as local energy balancing, islanding, and blackout prevention, adapted to a changing environment of high distributed energy resources penetration. A semantic framework has the potential to meet the requirements of flexibility, scalability, resilience, openness, and practicality.

Furthermore, it is important to combine the advantages of distributed control (e.g., scalability, privacy and adaptability) and centralised control (e.g., feasibility, optimality and responsibility), while mitigating their specific drawbacks. The benefits of a semantic and AI-based architecture are particularly evident when the grid needs to be restored and healed after a disruption in service. The grid should be able to restore, re-organise and heal itself via alternative topologies without affecting the system as a whole, which is informed by the holistic understanding of the wider energy systems.

There is a need for a new body of research with a view of ensuring the optimisation and resilience of energy management systems through self-healing capabilities: that i) promote autonomy, belonging, connectivity, diversity and emergence, ii) balance the importance of global and local objectives, iii) dynamically reconfigure to optimise the overall energy system's performance across energy carriers and scales, and iv) enable demand responsive energy management with bidirectional flow of energy, information and dynamic pricing schemes [367].

Optimisation based grid planning and longer-term operational control are common approaches in power system management. But increasing stochastics on the supply and demand side, and the coupling of different sectors and markets in-

creates the complexity of power grid operation and requires multi-objective, time-series based optimisation under increasing uncertainty. Meanwhile, increasing data availability and computational power gives us an opportunity to optimise short-term and close to real-time operation.

### 2.10.3 The lack of secure and reliable seaport energy services

Seaports are responsible for shipping circa 90 percent of the global supply chain of goods. They are, as such, critical infrastructures and are potentially subject to a wide range of threats [368]. Consequently, there is an urgent need to increase awareness on cyber threats faced by ports worldwide [369] to ensure secure shipping and operations [370].

This is now exacerbated by the digitisation of seaport infrastructures, including energy systems, as well as the involvement of a complex value chain. Potential risks to energy systems include: blackout or service interruption, malicious command injection, delayed measurements, Denial-of-Service attack, dynamic pricing information altered, and user accounts alteration. The consequences of such cyber security threats can be dramatic. Conversely, the reliability and Quality of supply (QoS) of energy related services in seaports are becoming pressing issues as a result of the increasing need for smart integration of distributed energy resources. A gradual transition is already occurring towards demand responsive energy management, which is enabled by smart metering infrastructures with a bidirectional flow of energy and dynamic pricing schemes.

Therefore, there is a requirement for secure authentication of users, agents, and transactions at each interface between energy devices. The number of processes is also exacerbated by the increasingly distributed nature of grids and their underpinning communication requirements. Three interesting avenues for further research include: (a) research to identify and quantify the risk of a breach of privacy and security to the systemic reliability and Quality of service (QoS) caused by insecure authentication occurring in a heterogeneous environment, where legacy standards and applications need to remain in operation alongside advanced standards; (b) research to identify and quantify the loss of data, breach of privacy and vulnerability due to the heterogeneous communication infrastructure (wireless, wired,



PLC), and the impact on grid reliability and QoS; and (c) research to develop guidelines for information security management, and inform related legislation and standardisation in the energy domain in seaports.

### 2.10.4 The lack of a transition towards prosumer-driven seaport energy communities

Seaports are an important ecosystem, including their local communities. We are gradually experiencing the emergence of sharing economies, with a corresponding change in consumption models. These can motivate energy prosumers (local communities around seaports) to participate in a leasing energy market where services are used for a shorter period and are more accessible via community sharing. Blockchain can incentivise the participation in such a sharing economy by providing greater choice for both energy consumers and providers, while enabling a much greater flexibility in being able to switch between multiple market offerings. This sharing economy has the potential to decentralise energy production and it can also balance consumption from consumers by not being restricted to energy services or price constraints from a single energy provider [371].

The energy market is currently transforming towards a large number of suppliers and buyers, and therefore it is important to enable participants in a seaport ecosystem to exchange an increased amount of traded energy. The interaction between these actors and the associated processes requires a high degree of standardisation, which can be facilitated by a Blockchain model. The utilisation of Blockchain for energy trading can lead to the eradication of brokers, monetisation of energy excess and development of energy communities. These brokers and intermediary parties are usually required for validation or to ensure the trustworthiness of information across parties, but can be replaced by a more automated Blockchain process. Third-party verification can be eliminated because Blockchain delivers a high level of security and data protection for different applications supported by a transparent ledger that records all transactions. In a Blockchain system, any user can become a trader and offer an energy product or service to a group of consumers. Blockchain technology has, therefore, the potential to leverage the benefits of decentralised energy systems and enable an environment where every-

one can trade, pay, and even deliver energy to others. Blockchain can support the creation of economically attractive energy communities utilising the power of the Internet and implement the vision of a perfect energy market. Blockchain identifies an online distributed database that aggregates a collection of blocks connected to each other. It is also a public and decentralised ledger that stores a set of records, structured as a chain and blocks. From multiple Blockchain solutions, smart contracts are instruments that can extend Blockchain's capabilities and have been used in a variety of industries. Smart contracts have often been used to convert business rules into codes, based on which a contract code/script is stored in a Blockchain. Future research will explore the adoption of energy sharing and trading practices within and around seaports, using blockchain technology [372].

## 2.11 Summary

Based on the literature survey, it is found that although the existing studies explore energy management strategies for ports, they are very limited in terms of the capability to provide a holistic energy analysis that can be scaled from a site level to a community level. At a wider scale, the review of the literature has evidenced that there is a lack of research that delivers a "demand-response" capability within a fishery port, while optimising the use of battery storage, and at the same time promoting the formation of sustainable energy communities. Seaports are considered to be one of the main drivers of the global economy and are a core element of the transportation, shipping and tourism and fishing industries. However, increased activities in seaports have undoubtedly affected the environment, including a high level of carbon emissions, noise resulting from activities at the seaports, high energy consumption and high health impacts among the populations of coastal cities near the seaports. This chapter has reviewed the published and applied research that has contributed significantly to transforming and promoting the concept of green and smart seaports in various countries. The findings demonstrate that the key factors contributing to decarbonising seaports are applying renewable resources, cost optimisation, deploying intelligent technologies, establishing rules and regulations for greening seaports, and/or implementing green

seaport practices guidelines to help seaport authorities move towards applying a green seaport approach.

An analysis of the research shows that there are three main factors that contribute directly and indirectly to the environment: the consumption of fossil fuels, the high energy consumption of power systems and the lack of professional management of resources at seaports. Importantly, the current status of seaports at the global level shows a lack of experience in smart seaport approaches. It is argued that the intelligent port approach will increase competitiveness between seaport authorities, which may ultimately lead to the seaport authority's inability to deal with climate challenges. There must be a useful role for business people and investors in modern technologies that reduce carbon emissions, such as renewable energy systems, smart metering devices and other modern technologies. While it is not easy to achieve a green and sustainable seaport without investors' presence, incentives and initiatives must be put in place to convince investors of the feasibility of investing in modern seaports, both in financial gain, avoidance of environmental legislation penalties, and sustainability of the port and the global climate.

As part of the plan to make seaports sustainable, overall decarbonisation of life cycle must be provided. This will have a tremendous impact on the overall system, and will contribute to the comprehensive efficacy of seaports and enhance the level of greening, sustainability and competitiveness between seaports. LCA can help quantify the trade-offs and gains to achieve improvements. However, due to the complexity of seaports within LCA, scalable approaches that factor in dynamic and non-linear considerations should be used. Similarly, the longer time-scales of seaport operation make the time dimension another condition to consider in modeling seaport activity. To achieve environmental sustainability, this chapter finds that there is a need for the development of real-time LCA approaches for seaports which combine LCIA models with time-dependent characterisation.

It is essential to optimise the operation of energy at seaports. This chapter finds success in projects that consider many variables that influence the total energy management in ports and the importance of using a semantic representation of the seaport's environment as a pre-processing step of smart energy system op-

eration. It is therefore recommended that seaport energy systems should utilise a grey-box approach to energy systems management that factors in both white box (simulation-based) and black-box (data-driven based) approaches. The grey box approach will be underpinned by semantics but informed by real-time feedback. While longer-term operational control approaches are commonly used, the combination of different sectors and markets, and acute fluctuations in supply and demand increase the complexity of power-grid operations. Consequently, time-series based optimisation with a multi-objective approach can accommodate for short-term or real-time operation given the appropriate data and computing power.

Although many seaports are pledging land to invest in smart energy systems, they can make further efforts by reducing their environmental impact and creating more jobs for the local communities around seaport sites. Consequently, stakeholders, policymakers and seaport authorities must develop policies and legislation to enhance the role of investment in clean energy at seaports and facilitate all capabilities to achieve this aim, which includes building expansion at the seaport sites and also their operation.

It is recommended that future works should use AI applications for energy systems in seaports to help predict energy consumption and meet the required power demand through local clean energy resources. AI can also help to optimise energy cost by avoiding selling power in hot seasons and managing power in the seaports to achieve maximum profit for seaport authorities. This may be achieved through real-time changes in power usage to match the grid's price to maximise income from selling power or minimise costs in buying power. While energy system optimisation is not a new concept, most implementations have only considered the system as a singularity. In contrast, we recommend a holistic approach to energy system optimisation through the use of semantic models.

# CHAPTER 3

## Methodology

This chapter describes the methodology used in this thesis, which involves case studies drawn from the EU INTERREG piSCES project (smart energy cluster for the fish processing industry).

### 3.1 Introduction

The concept of research methodology involves many different interpretations across disciplines [373]. Based on the Cambridge Dictionary, research is defined as “a detailed study of subject, especially in order to discover (new) information or reach a (new) understanding [310]. Meanwhile, the word methodology defined as “a system of ways of doing, teaching, or studying something”. The methodology is the theory of organisation [374]. Based on the Merriam-Webster dictionary, organisation has four meanings, which are: the condition or manner of being organised, the act or process of organising or of being organised, an administrative and functional structure (e.g., a business or a political party), and the personnel of such a structure [375]. Consequently, this methodology considers the organisation of an activity, which has an integral system with an accurate definition of the characteristics, logical structure and accompanying process of realisation [374].

#### 3.1.1 Research methodology approach

The research methodology, also known as strategy, outlines the direction in which the study should be carried out. It is a set of beliefs and philosophical assumptions that govern the formulation of research questions and the selection of research methods [376, 377]. The research methodology serves as a road map for the thesis,

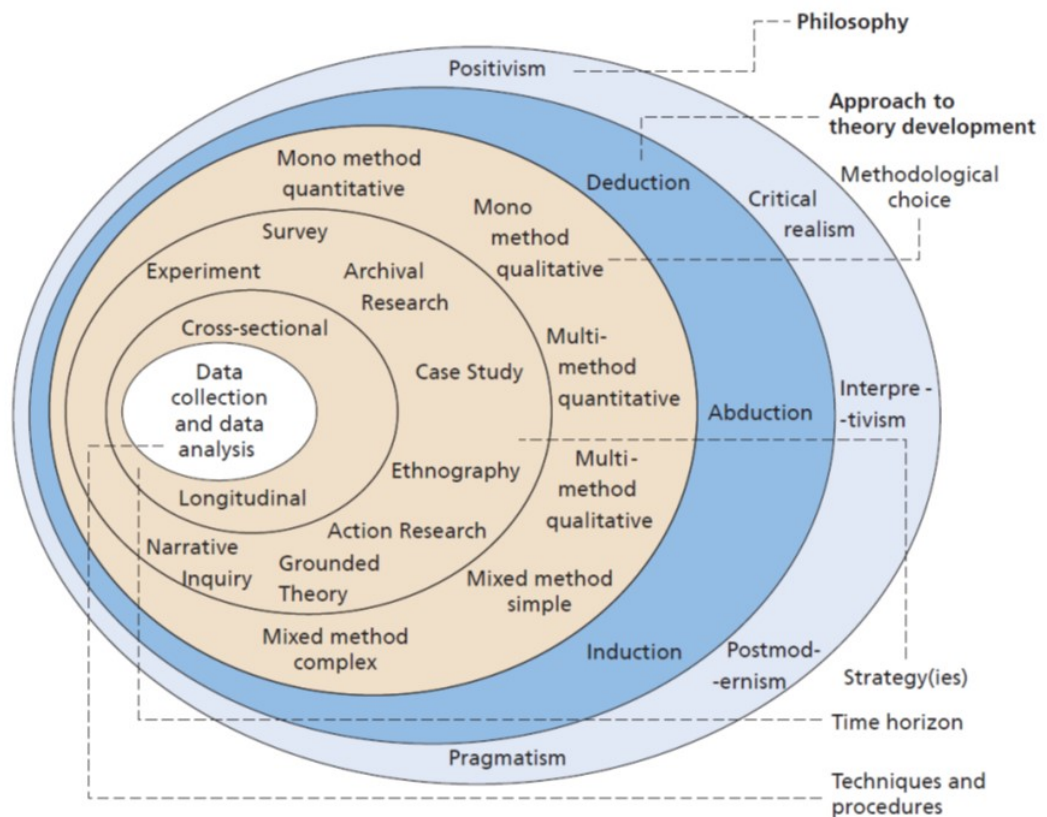

Figure 3.1: The Research Onion [378]

ensuring that the approaches, tools, and philosophy are all in harmony. Research Onion, proposed by [378], is one of the most prominent approaches for formulating research technique. It describes the major layers or steps that must be completed to build an effective research methodology. The primary layers of research Onion are depicted in Figure 3.1.

It is divided into six levels, which are read from outer to inner, beginning with the definition of the main philosophy and progressing to the selection of approaches, methods, and strategies. The main research philosophy draws ontology, epistemology, sources of knowledge, and axiology to help build the foundation of research. The second layer will concentrate on the development of approach theories, such as deduction, induction, and abduction. Theories in deductive research are tested through observation, but inductive research builds a hypothesis by observation [379]. Abduction is followed by research, which results in a best guess or conclusion based on the evidence available. The third layer focuses on methodological selection, which might be quantitative, qualitative, or mixed. Quantitative

research relies on data and surveys, whereas qualitative research relies on description and observation with in-depth analysis [380, 381, 382]. The fourth layer of the research onion is the data collection and analysis approach, which could be an experiment, a survey, archival research, a case study, ethnography, or action research. The fifth layer concerns the research timeline. The final layer discusses the methods and procedures used to collect and analyse data. This thesis is based on an industrial research study, which can be defined as action research, but the simulation model was developed to make a prediction of the future based on historical data [383]

This thesis is based on an industrial case study, which can be defined as qualitative research that relies on description and observation with in-depth analysis. The data that has been collected from the port site is used to develop simulation models and analyse the results.

#### 3.1.2 Refined scope of the research

This study aims to reduce the costs and carbon footprint for the fishery buildings by developing and testing a new 'smart grid' electricity network. Based on the literature survey, it found that the existing studies, although exploring energy management strategies for ports are very limited in terms of the capability to provide a holistic energy analysis that can be scaled from a site level to a community level. Such limitations can also be identified for the three criteria used for conducting analysis which are as follows: applying renewable energy, minimizing carbon emission, and the proposed smart grid. Table 3.1 presents a summary of the analysis. At a wider scale, the review of the literature has evidenced a research gap in that there is a lack of research that delivers a "demand–response" capability within a fishery port, while optimizing the use of battery storage, and at the same time promoting the formation of sustainable energy communities. The research hypothesis is posited: "The concept of Industry 4.0 has the potential to deliver net zero carbon fishery ports by leveraging smart and clean energy generation, use, and storage, while promoting the formation of energy communities within the local ecosystem."

Consequently, this thesis has three main research questions that aim to address this gap, as follows:

1. Can a reliable simulation capability be developed that provides real-time accounts of energy demand and use for fishery buildings?
2. Can the concept of a smart grid be adopted and applied to energy systems in fishery buildings at multi-levels?
3. Can the energy sharing and trading approach be simulated to promote decision-making that reflects the efficiency in fishery buildings?

This thesis aims to reduce carbon emissions from energy networks in fishery buildings by implementing smart energy system technologies.

The first research question is translated to the following objectives:

- Develop an energy model and simulation capability to provide real-time accounts of energy flows in seaports.
- Investigate the potential of local power supplies to meet total power demand in the fish processing industry using a Co-simulation platform.

The second research question is translated to the following objective:

- Explore various scenarios for decarbonising seaports by leveraging renewable energy sources, including solar energy and energy storage.

The third research question is translated to the following objective:

- Explore the role of seaports to address the energy demand of their local communities through energy sharing.

## 3.2 Case study design and implementation

### 3.2.1 Problem based industrial case

Fish processing industries use energy-intensive equipment, such as refrigerators, air conditioners and ice making machines. This leads to high energy costs and, indirectly, to an increase of carbon emissions. Given that most fish industry sites are old, they need to be made more sustainable and achieve economic competitiveness in the energy market. In 2011, fishery industries consumed about 40 billion litres of fuel and they produced 179 million tons of carbon emissions. Fisheries



### 3.2. CASE STUDY DESIGN AND IMPLEMENTATION

Table 3.1: Related Studies

Author	Applying Renewable Resources	Minimize Carbon Emission	Propose Smart Grid
Buiza et al. [384]			✓
Hua and Wu [61]		✓	
Misra et al. [62]		✓	
Acciaro et al. [361]		✓	
Parise et al. [385]			✓
Lamberti et al. [134]	✓		
Prousalidis et al. [283]			
Ramos et al. [95]	✓		
Alvarez et al. [131]	✓		
Misra et al. [107]	✓	✓	✓
Manolis et al. [73]		✓	
Balbaa et al. [120]			✓
Kotrikla et al. [282]			✓

use many energy-intensive processes. The traditional design of energy systems at fishery ports leads to increased energy consumption and carbon emissions. The percentage of carbon emissions resulting from fishery industries is estimated to be 4 percent of the global greenhouse gas emission (GHGS). Meanwhile, the total human consumption of seafood has increased from 20 million in 1950 to more than 136 million tons in 2014. This rapid growth in seafood consumption has led to increased demands being placed on the fishery industries, and therefore has increased the carbon emissions in the past few years.

The Smart Cluster Energy System (piSCES) project aims to reduce the costs and carbon footprint of the fish processing industry by developing and testing a new smart grid electricity network. The smart cluster energy system for the fish pro-

cessing industry (piSCES) operation will ultimately reduce the costs and carbon footprint of energy networks in the fish processing industry by implementing smart grid technologies. This will be done through modelling the use profile of these energy networks, which will then be optimised against the wholesale energy market and any available onsite generation. This addresses the cross-border innovation theme of the Ireland-Wales programme of strengthening research, technological development and innovation. It will focus on the specific objective, which is: To increase the intensity of knowledge transfer collaborations involving research organisations and SMEs in line with the shared priorities of the smart specialisation strategies. The aim of this thesis is to reduce the carbon emission of energy networks in the fish processing industry by implementing smart energy system technologies. This thesis will focus on applying this project via three sites located in the United Kingdom and the Republic of Ireland. The next sections will describe these sites in more detail.

Milford Haven port is one the largest energy ports in the United Kingdom and it is considered to be the largest handler of oil and gas, with the capability of delivering about 30 percent of UK gas demand. One of the core functions of the port is to take responsibility for the safe movement of vessels on the Milford Haven Waterway, which is a deep-water site on the western coast of the UK. Furthermore, the MHPA has a strategic plan to diversify its functions, including transportation, energy, renewable, engineering, leisure and tourism fishing, food processing and aquaculture. In addition, the MHPA continues to improve the process of its operations, which will help to create new jobs for people who live in Wales and increase security of supply.

One of the key strategic plans for the UK is to increase the capacity of the gas and oil pipelines, and electricity connections to the centre of the UK and increase the level of trade conducted via the Atlantic. Milford Haven is a leading UK port, handling over 30 million tons of cargo annually. It is located in the western region of Wales and it provides expertise in many different marine operations, such as cargo handling, renewable, freight, passenger ferry services, fisheries, commercial property management, leisure and retail [386]. Milford Haven's fish docks are illustrated in Figure 3.2. It can be seen from this figure that Milford Haven is an ideal

### 3.2. CASE STUDY DESIGN AND IMPLEMENTATION

place for vessels transitioning in the Irish Sea, Bristol Channel and the Celtic Sea. In the last few years, the port has started to develop fish-processing units containing cold storage, ice-making machines and box washing machines.

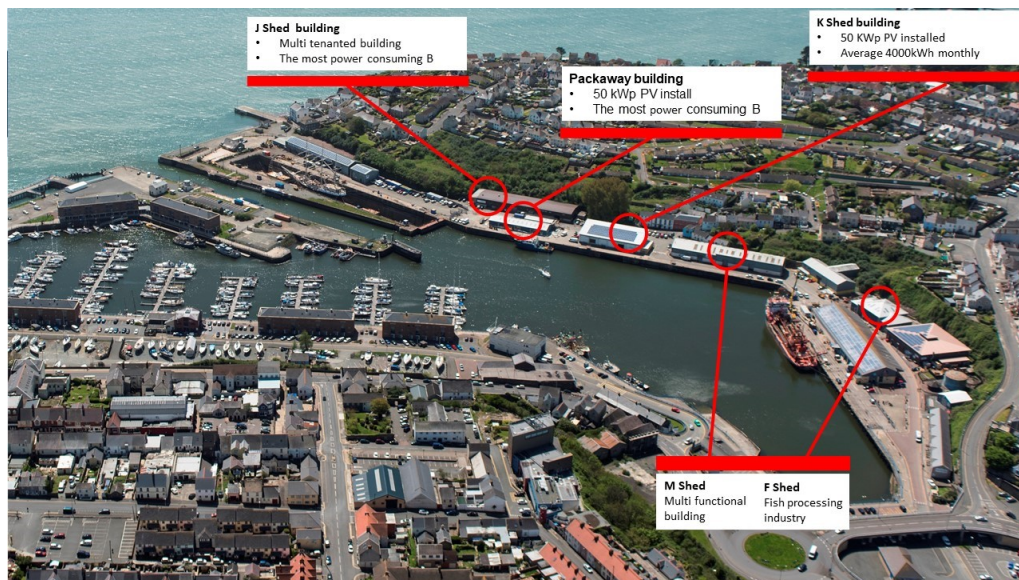

Figure 3.2: Milford Haven Port Authority [386]

Milford fish docks is part of Milford Haven port. It is the largest fishing port in Wales, with average of 3000 tones landed every year. The fish docks are an ideal place for vessels working in transition to the Irish sea, Bristol Channel and Celtic Sea. In the last few years. the port has started to develop fish processing units that contain cold storage, ice making machines and box washing machines. Fish processing at Milford Haven port faces a real problem with increased energy consumption, due to operational time at different seasons of the year. Based on the environmental report for the Milford Haven port, the total power consumption of electricity in 2012 was about 1600 Mwh and the production of carbon emissions was about 790 tonnes CO<sub>2</sub>. The port authority has started to deploy PV panels across its facilities to meet power demand and eliminate carbon emission. This will help the port to meet the UK 2050 plan of energy use. The port installed 2500 panels across 25 buildings in its premises. In addition, port authorities completed a solar farm at Liddeston Ridge, with more than 20000 panels and a power capacity of 5 MW. Figure 3.2 present the location of fish processing industries in Milford Haven port, including the solar farm.

## 3.3 Case study design and implementation

### 3.3.1 Simulation-based energy analysis at the district level

#### 3.3.1.1 Using DesignBuilder and EnergyPlus simulation tools

One of the main challenges during data collection in this study was the lack of essential data related to energy consumption in the clusters. Therefore, there it is necessary to understand the behaviour of energy consumption in the clusters using simulation techniques that will help to understand the behaviour of energy consumption in the buildings and identify opportunities to optimise energy use in industrial sectors. Two energy simulation software will be used to understand the behaviour of energy consumption. DesignBuilder is a user-friendly modelling environment where you can work (and play) with virtual building models. It provides a range of environmental performance data, such as annual energy consumption, maximum summertime temperatures and HVAC component sizes [76]. The second software is known EnergyPlus which is a new version and combination of two programs: BLAST and DOE-2. This new version of the program features sub-hourly time steps, user configuration modular HVAC systems that are integrated with a heat and mass balance-based zone simulation, and input and output data structures that can facilitate third party module and interface development. Figure 3.3 illustrates the process of modeling and simulation of DesignBuilder and EnergyPlus. The input data for the simulation are site location, weather data, building geometry, HVAC system, lighting and electric appliances.

#### 3.3.1.2 Using the Building Control Virtual Test Bed (BCVTB) platform

BCVTB is a software environment that allows users to run several simulation programs for co-simulation. It also couples' simulation programs with actual hardware. For example, the BCVTB allows us to simulate a building in EnergyPlus, and simulate the HVAC and control system in Modelica, while exchanging data between the software as they simulate. The BCVTB is based on the Ptolemy II software environment. In addition, BCVTB allows expert users of the simulation to expand the capabilities of individual programs by linking them to other programs. The main ob-

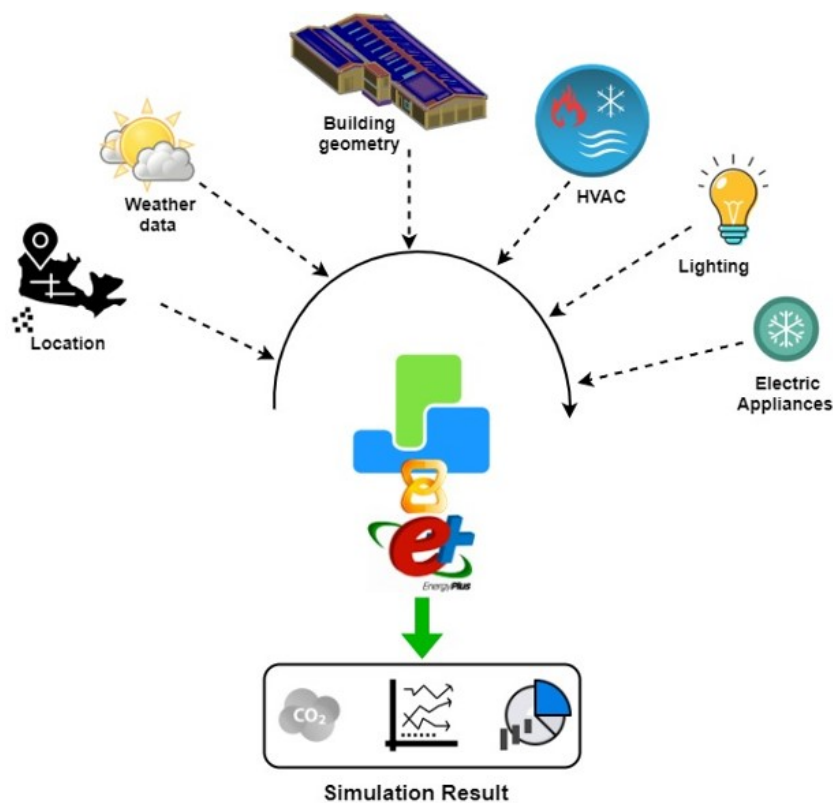

Figure 3.3: The process of modeling and simulation using DesignBuilder and EnergyPlus

jective of BCVTB is to integrate the cluster of buildings with the solar farm through simulation to identify the capability of the solar farm to meet the total power demand of the entire site of buildings with their associated operations. This thesis also aims to find the optimum management of the energy system in the port by investigating power supply and demand as a first step in the overall optimisation process in the port. Co-simulation software has been used, such as BCVTB software to connect different types of simulation engines to facilitate the exchange of data between various simulations. The solar farm has been modelled using SIMULINK and EnergyPlus linked together with BCVTB.

### 3.3.2 Simulation-based energy optimisation at district level

#### 3.3.2.1 Developing a smart grid

A multi-stage approach adopted with five stages of the proposed methodology, namely: building simulation stage, energy generation simulation, energy storage

simulation, grid model and integration of agents in MATLAB/SIMULINK.

“MATLAB” is a high-performance language for technical computing. It integrates computation, visualisation, and programming in an easy-to-use environment where problems and solutions are expressed in familiar mathematical notation”[319].

“SIMULINK” is a block diagram environment for multi-domain simulation and Model-Based Design. It supports system-level design, simulation, automatic code generation, and continuous test and verification of embedded systems. It provides a graphical editor, customisable block libraries, and solvers for modeling and simulating dynamic systems. It is integrated with MATLAB, enabling you to incorporate MATLAB algorithms into models and export simulation results to MATLAB for further analysis.

The smart grid model consists of a building simulation model, energy generation model, grid model and energy storage system model. The graph that follows in 3.4 shows the input-output variables for a smart grid model using MATLAB/SIMULINK. It contains a control strategy algorithm of the charge/discharge controller, and is based upon a set of rules to distribute and manage the power system between the four agents.

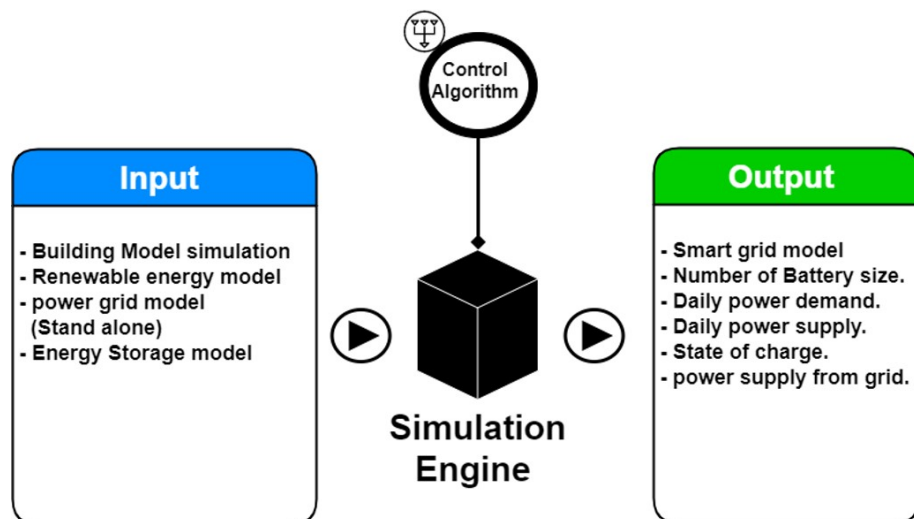

Figure 3.4: Input Output variables for a smart grid model using simulink

#### 3.3.2.2 Developing a smart energy community around a fishery port

After developing the smart grid, a smart energy community has been developed by including local domestic power demand involving 200 houses around the fishery

port and five processing industrial workflows. However, this experiment was challenging because of the complexity of the model's size. The charge controller will manage power flow among loads, solar farm, grid, and battery while allowing the model to run sufficiently without any disruption. The model will keep an activity interconnectivity with the grid in case there is not enough power from the battery system to meet the power demand from the community, especially at night. The model is run several times to identify the optimum number of battery storage systems when the model does not supply power from the grid. The model will present the behavior of the system in separate graph files to see how the entire industry system is run for 24 hours. The model runs instantaneously (per second) with different scenarios and input parameters in an attempt to identify the optimum capacity of the battery storage system to support more optimal use of energy and reduce capital costs at the site.

#### 3.3.2.3 Developing real-time decision strategies toward decarbonisation seaports

This study has developed and implemented two control strategies. First, a control-based price algorithm has been developed for the smart grid fishery industry that is based on total power production received from the PV panels and the power storage in electric boats. The price of electricity was also considered, to decide when to buy or sell power. The system has been built based on constraints of price during times of selling or buying. In addition, the system considers the state of charge (SOC) for two different batteries. The condition of battery status is crucial to the overall system, and the decision will be made based on the SOC of batteries and the price of power. The control system works instantaneously and will send signals to the battery charge controller. The flow chart in the figure below illustrates the several steps used for flow among power supply and power demand in the fishery industry. Figure 3.5 shows the input-output variables for the smart grid model using MATLAB/SIMULINK. It also contains the control strategy algorithm of the charge/discharge controller, and is based upon a set of rules to distribute and manage the power system between the four agents.

Second, peer-to-peer energy sharing and trading will be used, which is a new generation energy management strategy in the smart grid that enables prosumers

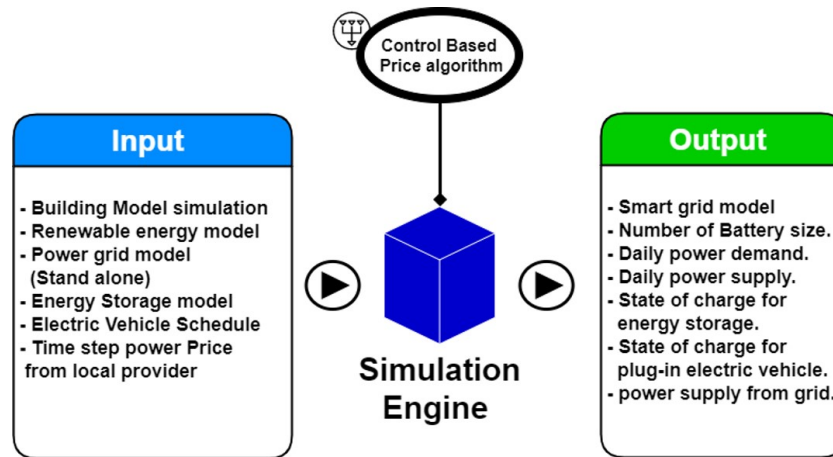

Figure 3.5: Input output variables for a smart grid model based on control price

in smart energy communities to share their energy surplus with other participants. There is a motivation towards sharing power with neighbourhoods inside the energy community. The aim of power sharing is to increase the local power generation from renewable energy resources and encourage local energy providers to share their positive power with the neighbourhood instead of selling power to the grid, which will minimise the dependency on power from the grid and also minimise the proportion of carbon emissions that are released from burning fuel or gas in traditional power plants. Figure 3.6 shows the proposed control system scheme for a smart grid for fishery industries based on peer-to-peer power sharing. It contains a control strategy algorithm of the charge/discharge controller, and is based upon a set of rules to distribute and manage the power system between the four agents.

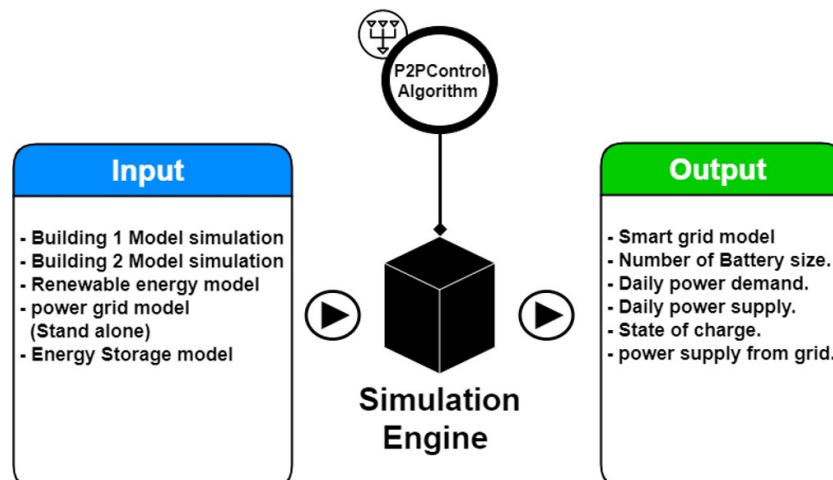

Figure 3.6: Input output variables for a smart grid model based P2P power sharing



### 3.4 Research structure

This section will discuss the overall structure of the research study to answer the three main questions. The research structure consists of three stages as shown in figure 3.7, each stage has different processes. This section will present the overall idea of each stage and the details will be given in the next section.

#### 3.4.1 Phase one

First, the literature review has found a research gap based on the piSCES project, as described in Chapter 2. Finding the research gap will help to find the main objectives of the research study, and it will help to identify the main challenges and opportunities to solve the main research problem. Second, data is collected from Milford Haven port site: one of the key challenges is to ensure that any solution developed is generalisable, to enable the maximum possible exploitation of the results of the applied case study. Within the context of the project, this means the restrictions of the case studies. To ensure this challenge is met, it is important that a common methodology is adopted at each of the pilot sites to undertake the process of capturing the technical and business requirements. This methodology is “Data Requirements Capture” and consists of four stages, which are: interview with district stakeholders; collecting data from sites through a walk through site visit; an energy audit and data analysis to extract detailed information on the energy systems and pilot site; and the identification of a series of scenarios that are relevant and applicable to the pilot to which the solution can be targeted. One of the main challenges during the data collection is the lack of essential data related to energy consumption in the clusters. Therefore, there is an urgent necessity to understand the behaviour of energy consumption in the clusters using simulation techniques that will help to understand the behaviour of energy consumption in the buildings and identify opportunities of optimise energy use in the industrial sectors. After the data has been collected from sites, and the questionnaires and interviews have been analysed, the next step is to develop a simulation model for the building using DesignBuilder, EnergyPlus, and Building control Virtual test bed (BCVTB) software. The first element of the simulation model is create the building’s geometry using

DesignBuilder. Once the geometry has been built, use the data collected from site as input data for each geometry building (e.g., site location, weather data, operation time, equipment specification etc.). The DesignBuilder interacts with the simulation engine EnergyPlus to calculate the annual energy consumption of the building, and calculate the total operation cost and the amount of emission has been produced during one-year period.

#### 3.4.2 Phase two

The next step after developing simulation model of each building is to investigate the capability of the local solar farm to meet the power demand of the five cluster buildings at the fishery port. To solve this question, the BCVTB integration platform has been used, which allows users to run a couple of different simulation programs for co-simulation and couple simulation programs with actual hardware. The Co-simulation platform was built in BCVTB contains five cluster building and solar farm. The optimisation process is based on the simulation of the smart energy cluster system. The optimisation uses simulated energy consumption to determine optimised schedules of the appliances. These optimised schedules represent the time intervals based on which appliances can operate in direct relation with the energy production of the PV system. The optimisation stage is directly integrated with the simulation framework developed with DesignBuilder, EnergyPlus and BCVTB. The simulation-based optimisation will inform of the optimal use of appliances in the different time intervals based on specific simulation parameters and values. Chapter Four will discuss the modeling and simulation in detail. After develop simulation model of the building, the next step is to investigate the capability of modelling and simulation of energy use at fishery port to inform sizable energy use and reduce carbon emission to nearly zero carbon emission. To answer this question, a developing of smart grid for fishery industry using MATLAB/SIMULINK platform. The smart grid consists of load pattern, grid model, energy storage system, renewable energy generation and control strategy. The result of integrating the components will identify several parameters, such as number of battery storage, the behavior of energy consumption and energy generation, and the power used from the national grid. Chapter six will conduct an energy analysis and modelling for the fishery

### 3.5. CONCLUSION

---

industries by exploring energy transition from a building level to an energy community level. It will also adapt modelling principles to deliver a simulation analysis framework that uses energy modelling software tools to increase energy efficiency for the industrial fish port in Milford Haven, South Wales.

#### 3.4.3 Phase three

The next step after developing the smart grid is to optimise surplus power from the grid by developing a control-based price strategy that will consider the cost of buying and selling power. Chapter Seven will discuss the modeling and simulation of the smart grid in detail. Another important technique is to integrate power sharing in the fishery energy community with a peer-to-peer energy sharing strategy, which enable to share energy to local community energy sharing instead of selling the power to the grid. This will help to build a smart energy community at the fishery port. This study has been implemented and tested in the MATLAB/SIMULINK platform. Chapter Seven will also discuss peer-to-peer energy sharing strategy in detail and present the proposed Roadmap for achieving nearly zero carbon fishery port.

### 3.5 Conclusion

This chapter has discussed the main methodology that will be used to answer the research question. First, this chapter began with a brief description of the research methodology and the research type that been chosen for this research project. It next refined the research scope and objective. Second, it discussed the piSCES project and the site location in more detail. It presented the research structure, which consists of three stages. The first stage is the process of finding a research gap and capturing data from the site locations. The second stage is to develop a model and simulation for the cluster at the fishery port site. The third stage is to develop a methodology to develop a smart grid for industry, considering several parameters. In this stage, two techniques have been used to optimise the surplus power from the smart grid. The first technique is control-based price, which will help to find the optimum operation of the grid by considering power prices. The

### 3.5. CONCLUSION

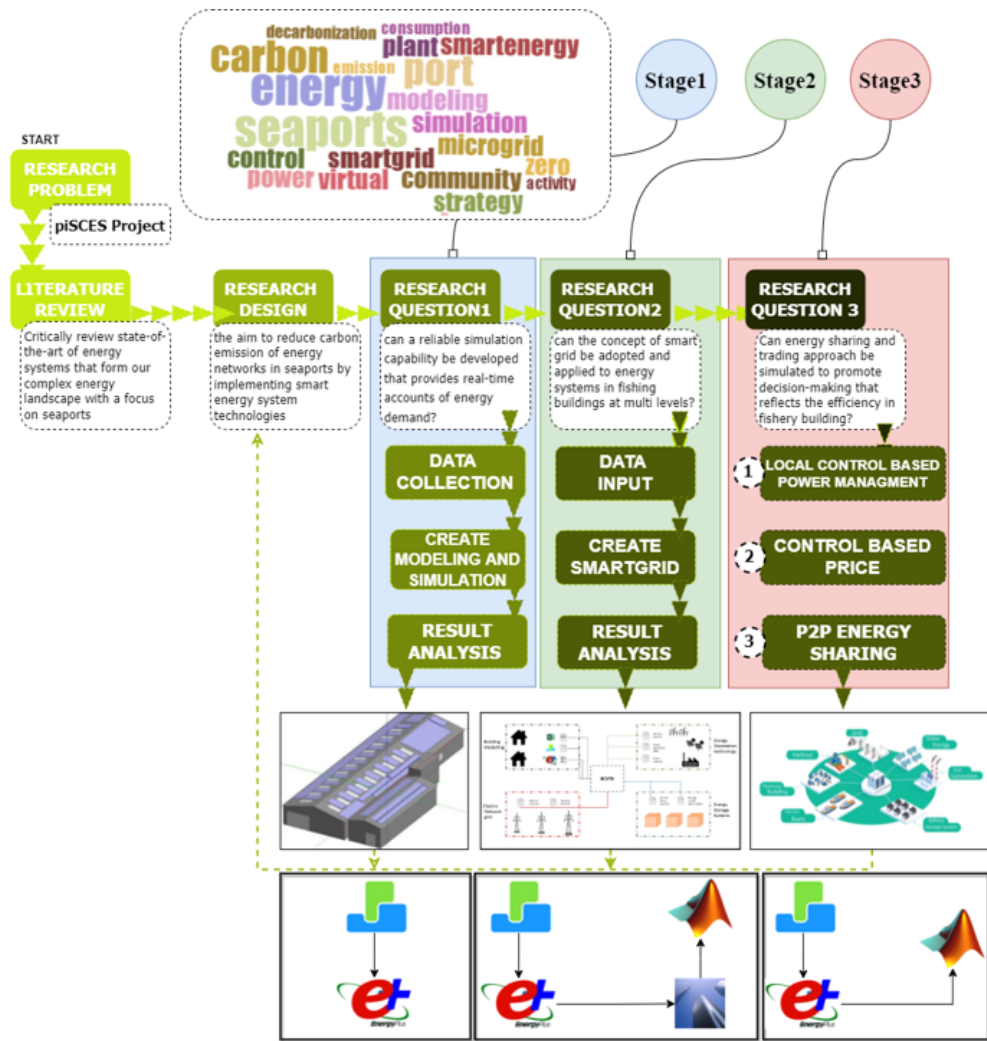

Figure 3.7: The Main Methodology of Research for the Scope of this Thesis

second techniques is a peer-to-peer control strategy, which will help to share the surplus power to the local neighbourhood instead of selling it the grid. The next chapter will discuss the use of energy modeling and simulation at fishery ports.

# CHAPTER 4

## Energy modeling and simulation of a Fishery Port

This chapter will discuss energy modeling and simulation at fishery ports. This is based on the first research question, which aims to develop a simulation capability for fish processing industries and fishery ports. The first part will give a brief description of the modeling and simulation of energy systems, focusing on energy modelling for industrial applications. It will then present the follow up methodology that has been used to answer the posited research question. The next part will describe the simulation software that will be used to simulate fishery port sites. This chapter will then present the simulation container implementation for three different pilot sites. It will also describe the process of co-simulation between the fishery cluster and solar farm using BCVTB. The last part will investigate optimisation-based simulation through scheduling appliances. Finally, the results of the simulation model will be discussed.

### 4.1 Modelling approach

In order to develop a energy simulation model for the selected case study at Milford haven; A data requirement captured process is required to develop an energy simulation model for the selected case study at Milford Haven. The data-capture process consists of four stages, which are: interview with district stakeholders; collecting data from sites through a walk-through site visit; an energy audit and data analysis to extract detailed information on the energy systems and the selected pilot study; and identifying a series of scenarios that are relevant and applicable to the pilot studies. The lack of essential data related to energy consumption in

## 4.1. MODELLING APPROACH

the clusters was one of the main challenges during the data collection. Therefore, there is an urgent need to understand the behaviour of energy consumption in the clusters using simulation techniques that will help to understand the behaviour of energy consumption in the buildings and identify opportunities to optimise energy use in the industrial sectors. After the data has been collected from the sites, and the questionnaires and interviews have been analysed, the next step is to develop a simulation model for the building using DesignBuilder, EnergyPlus, and Building control Virtual test bed (BCVTB) software. Figure 4.1 illustrate the data collection process from selected pilot site.

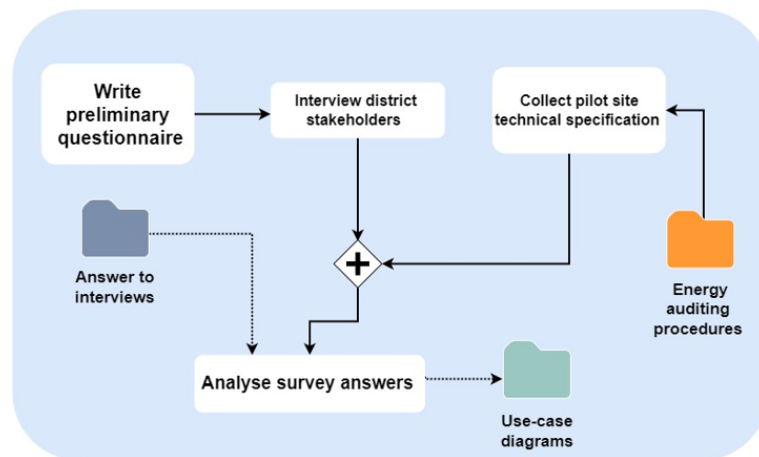

Figure 4.1: Modelling and simulation using DesignBuilder and EnergyPlus

The DesignBuilder, EnergyPlus and Building control Virtual test bed (BCVTB) software has been used to develop a simulation model for each of the buildings. The first element of the simulation model is create the building's geometry using DesignBuilder. Once the geometry has been built, the data collected from the site has been used as an input for each building's geometry (e.g., site location, weather data, operation time, equipment specification etc.). DesignBuilder interacts with the simulation engine EnergyPlus to calculate the annual energy consumption of the building, and to calculate the total operation cost and the amount of emissions produced during one-year period. The next step after developing the simulation model for each building is to investigate the capability of a local solar farm to meet the power demand of five cluster building at a fishery port As shown in figure 4.2.

To solve this question, The BCVTB integration platform allows users to run a couple of different simulation programs for co-simulation, and couple simulation

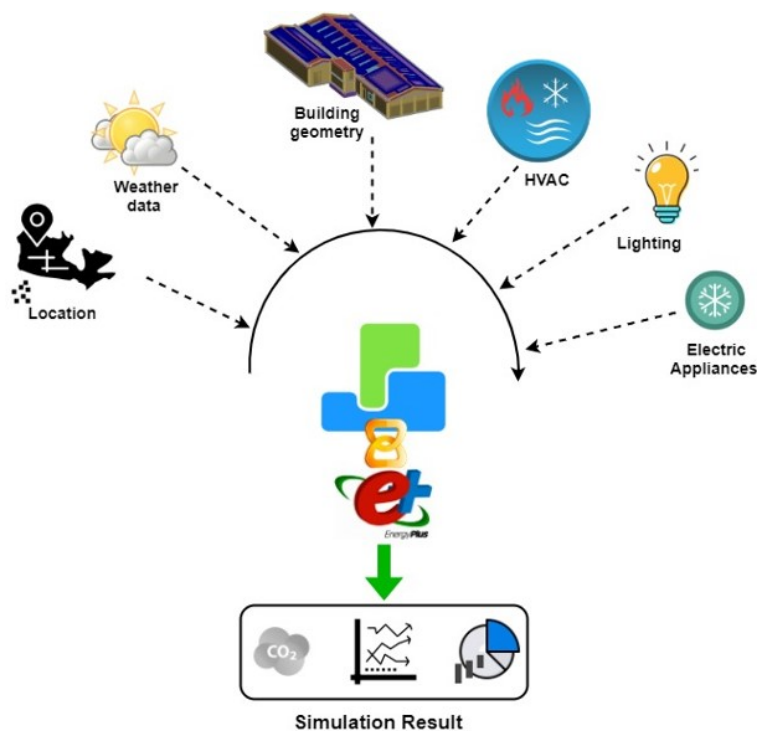

Figure 4.2: Modelling and simulation using DesignBuilder and EnergyPlus

programs with actual hardware. The Co-simulation platform was built in BCVTB, and contains five cluster buildings and solar farm. The result of Co-simulation between power supply and power demand will help to identify optimum scheduling of appliances through simulation-based optimisation. The optimisation process is based on the simulation of the smart energy cluster system.

Optimisation uses simulated energy consumption to determine the optimised schedules of the appliances. These optimised schedules represent the time intervals, based on which appliances can operate in direct relation with the energy production of the PV system. The optimisation stage is directly integrated with the simulation framework that was developed with DesignBuilder, EnergyPlus and BCVTB. The simulation-based optimisation will inform of the optimal use of appliances in the different time intervals based on specific simulation parameters and values. Modeling and simulation saves time and money, and provides a high level of optimisation before applying the system in real life. The term “process” indicates to everything that can be investigated and analysed in simulation, such as cars, planes, ships, transportation, buildings and so on.

The simulation tools are based on a mathematical model of the process being

investigated. Therefore, the simulation tools will allow a detailed analysis of the object before it is applied in real life. For the mathematical model, different parameters can be varied to test multiple aspects of the process. The settings can be adjusted and the repeated simulation increases the possibility of an accurate simulation result. Moreover, the simulation could have an impact on the future result through predicting and optimising the main parameters that will reflect the overall system. However, a more precise mathematical model will lead to a more realistic simulation and a more meaningful the result [387]. These days, when evaluating the level of sustainability in buildings, building simulation is considered to be the most important tool to help meet the requirement of nearly zero energy buildings.

The most important parameters to investigate in building simulation are energy use, carbon emissions, heating, ventilation and air conditioning systems. The following sections will discuss the most widely used simulation software, known as DesignBuilder and EnergyPlus. The following figure 4.3 illustrates the process of modeling and simulation of DesignBuilder and EnergyPlus. Input data for simulation is site location, weather data, building geometry, HVAC system, lighting and electric appliances.

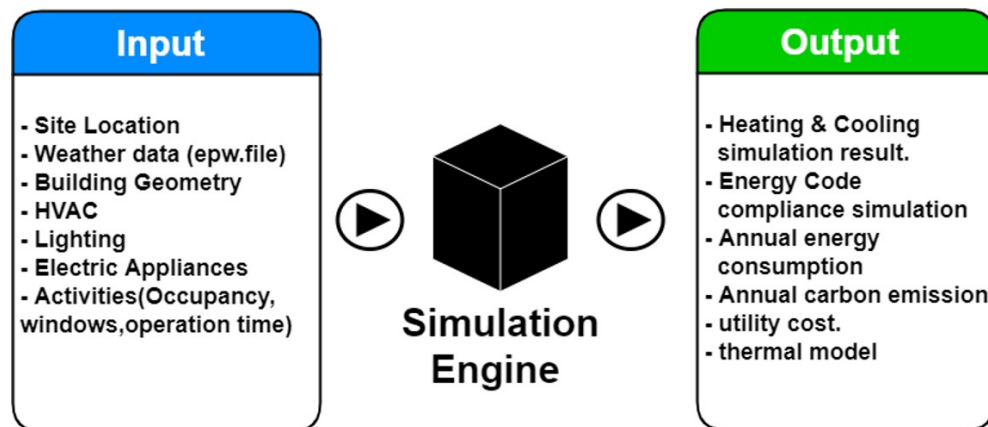

Figure 4.3: Input Output data for simulation container using DesignBuilder and EnergyPlus

The main objective is to integrate the cluster of buildings with the solar farm through simulation. To achieve this objective, an investigation will be conducted to identify the capability of the solar farm to meet the total power demand of the entire site of buildings with their associated operations. This thesis also aims to



## 4.1. MODELLING APPROACH

find the optimum management of the energy system in the port by investigating power supply and demand as a first step in the overall optimisation process in the port.

Co-simulation software has been used, such as BCVTB software, to connect different types of simulation engines and thus facilitates the exchange of data between various simulations. The solar farm has been modelled using Simulink and EnergyPlus linked together with BCVTB. The model shown in Figure 4.4 highlights the conceptual integration between power demand and supply within the energy cluster showing the input and output variables. The power generation source identified by the solar farm has been modelled using EnergyPlus, which enables simulation of the power generation during a year determining insights on how the solar power generation can meet the local power demand. There are several parameters required for modelling the solar farm, such as PV modules properties, number of modules, inverters, the location of the farm, weather data and the total number of panels based on the modelling and simulation. It is observed that the energy demand of the port is constant throughout the year, while energy production changes based on the seasons and weather specificities.

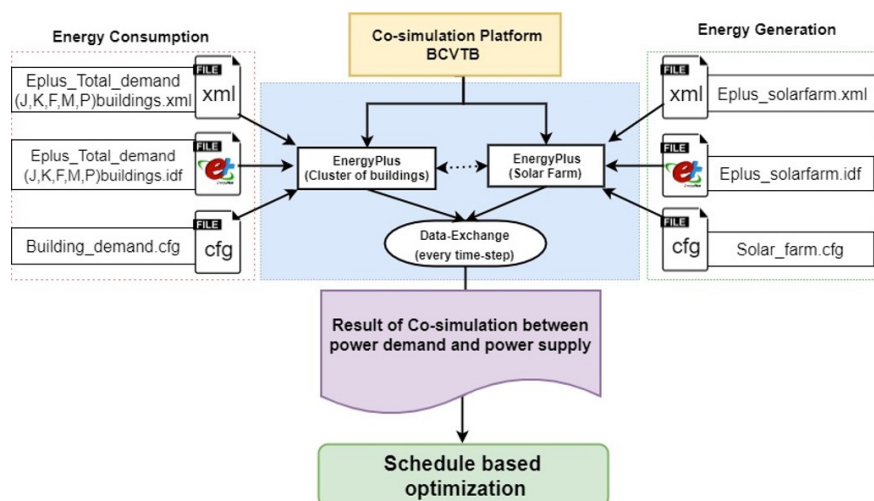

Figure 4.4: Interface between energy models and power generation sources using BCVTB

## 4.2 Energy simulation programs

### 4.2.1 DesignBuilder

DesignBuilder is a user-friendly modelling environment where you can work (and play) with virtual building models. It provides a range of environmental performance data, such as annual energy consumption, maximum summertime temperatures and HVAC component sizes [76]. Some typical uses are: calculating building energy consumption, evaluating façade options for overheating and visual appearance, developing a thermal simulation of the building, ventilation), calculate daylighting - models of lighting control systems and calculating savings in electrical lighting, ability to visualise site layouts, calculating heating and cooling equipment sizes, communication aid at design meetings, and an educational tool as shown in figure 4.5.

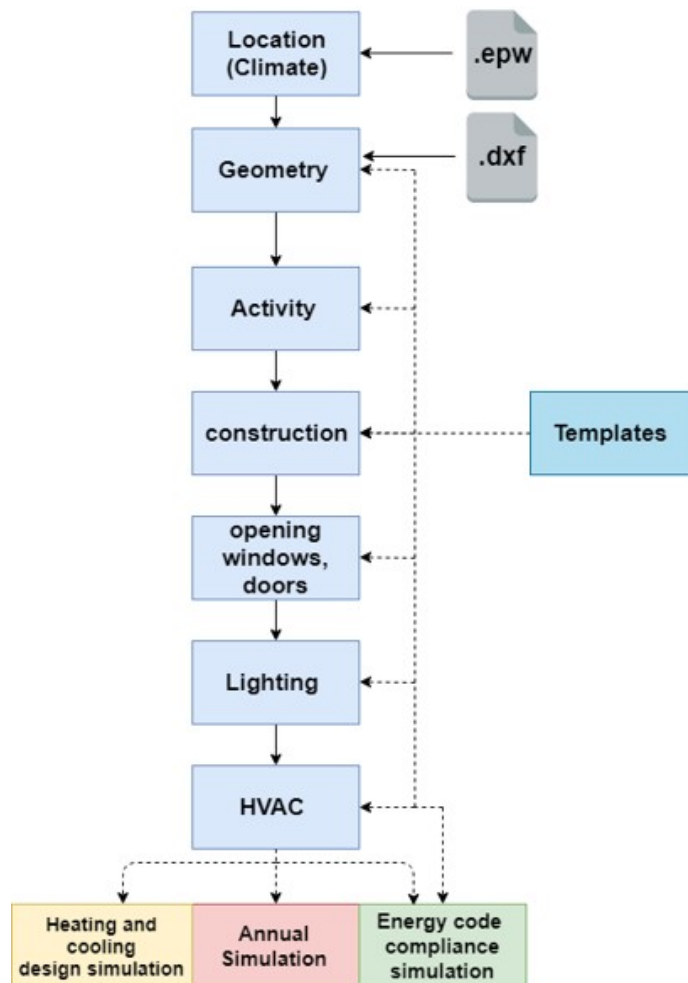

Figure 4.5: The Process of simulation in DesignBuilder [76]

### 4.2.2 EnergyPlus

EnergyPlus is a new version and combination of two programs: BLAST and DOE-2. The new version of the program features sub-hourly time steps, user configuration modular HVAC systems that are integrated with a heat and mass balance-based zone simulation, and input and output data structures that can facilitate third party module and interface development. The structure of EnergyPlus starts by calculating load using a heat balance engine at user-specified time steps, which is then passed to the building systems simulation module at the same time step. Figure 4.6 shows the process of EnergyPlus simulation software. Meanwhile, EnergyPlus's key capabilities as follow:

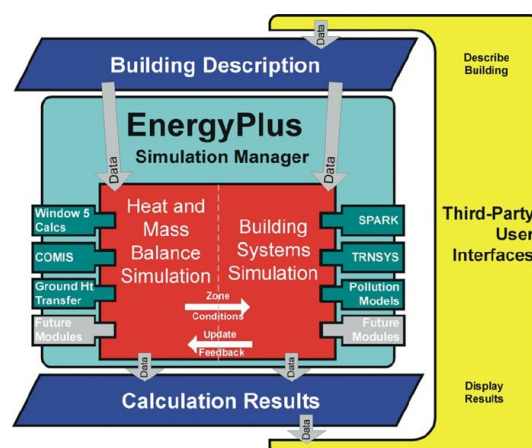

Figure 4.6: Energy simulation process of EnergyPlus software [77]

The variable time step module calculates the heating and cooling system of the plant, and also its electrical system response. This provides feedback from the building systems simulation module. However, the load does not reflect the next time step of load calculations in adjusted space temperatures (if necessary).

- Integrated, simultaneous solution.
- Sub-hourly, user-definable time steps.
- ASCII text-based weather, input, and output files.
- Heat balance-based solution technique.
- Improved ground heat transfer modeling.
- Daylighting controls and atmospheric pollution calculations.

### 4.2.3 Building Control Virtual Test Bed (BCVTB)

BCVTB is a software environment that allows users to run a couple of different simulation programs for co-simulation. It also couples simulation programs with actual hardware. For example, the BCVTB allows us to simulate a building in EnergyPlus, and can simulate the HVAC and control system in Modelica, while exchanging data between the software as they simulate. The BCVTB is based on the Ptolemy II software environment. In addition, BCVTB allows expert users of the simulation to expand the capabilities of individual programs by linking them to other programs. Due to the different programs that may be involved in distributed simulation, familiarity with configuring these programs is essential [78]. Figure 4.7 presents an example of integration multi simulation software in BCVTB. Some programs that are linked to the BCVTB follow:

- The EnergyPlus whole building energy simulation program.
- The Modelica modeling and simulation environment Dymola.
- Functional Mock-up Units (FMU) for co-simulation. model-exchange for the Functional Mock-up Interface (FMI) 1.0 and 2.0.
- The MATLAB and Simulink tools.
- The Radiance ray-tracing software.

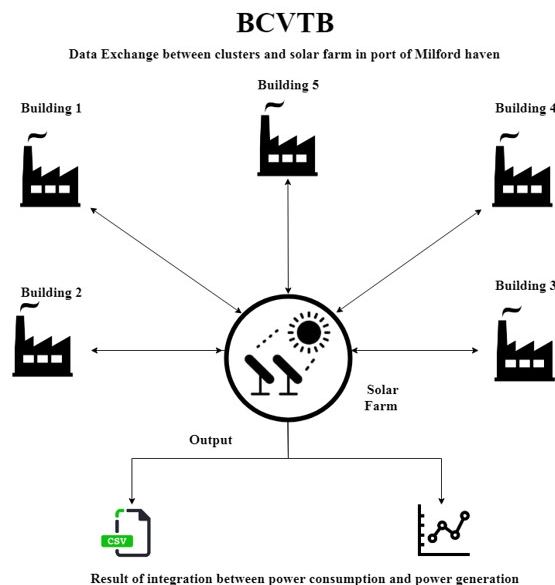

Figure 4.7: The process of integration multi software in BCVTB platform

### 4.3 Implementing the simulation model

One of the best solutions that can optimise energy use in energy consuming industries is the use of numerical simulation modelling, which has a direct impact on energy savings, time optimisation and costs. Such simulation analyses can detect and predict failures, and also provide real time energy optimisation in various use-case scenarios. Food and agriculture organisation studies have also reported that the global human consumption of fish increased dramatically from 1950 to 2012. The proportion of fish processed world-wide has increased from 20 million tons to more than 136 million tons, which adds a level of pressure for fish processing industries to use energy from different sources to meet the demand of fish and for fish processing operations [70].

#### 4.3.1 Energy modeling for fish processing industries

Several parameters can influence the energy usage for fish industries, including: (i) seasons when the amount of fishing can increase the demand of energy; (ii) weather, which can have a significant effect on the total processed fish during a year; and (iii) the number of fisheries and boats, which can also effect total energy use. Energy use for fish processing industries can have two main operating modes: (i) direct use, such as lighting systems, heating and box washing machines or (ii) indirect use through converting the power to another form of energy such as cooling cycle, freezing and equipment. However, due to an increase in the demand of energy in industries, an increase of the cost with energy use and the increase of CO<sub>2</sub> emissions, there is a need to move towards more secure, clean and sustainable energy solutions. The new smart energy systems and techniques that have recently emerged can meet the requirements of the fish processing industries through increased use of renewable energy and smart energy management. Adopting such modelling principles to deliver a simulation analysis framework utilising energy modelling software tools to increase energy efficiency for a realistic industrial fish port in Milford Haven, South Wales.

## 4.3. IMPLEMENTING THE SIMULATION MODEL

---

### 4.3.1.1 Energy simulation container of Milford Haven port

This section will present the simulation and modelling of energy use in fish processing industries using DesignBuilder [76], EnergyPlus [77] and BCVTB [78] to model a smart energy cluster and to propose optimised schedules for the site operation. The study aim to investigate the integration of local PV solar energy in a local energy cluster using a multi-building energy coordination model developed in EnergyPlus. This section demonstrates the benefits of smart cluster energy systems by leveraging demand and supply mechanisms with adequate optimisation strategies. Also, it aims to optimise energy using appliance scheduling techniques for the Packaway building and assess the impact within the overall energy cluster. The first step of the simulation phase is to develop an electrical energy consumption model for fish ports using DesignBuilder, a commercial 3D modeller and energy simulation software platform. The energy model includes geometrical information of the building enriched with occupancy information, material and envelope properties, overall intrinsic attributes (including thermal properties) of the building, and schedules for heating and cooling devices. The simulation model is generated based on a use-case scenario that minimises electrical energy consumption in the fish processing clusters, while maintaining acceptable CO<sub>2</sub> emissions. Initially, the thermal model is generated using DesignBuilder, which is then exported into EnergyPlus (an open-source and cross-platform energy simulation environment). The next section will present the simulation model for fish processing industries in MHPA.

#### 4.3.1.1.1 Packaway building

The Packaway building contains a flake ice machine, ice store freezer, box washing machine, lighting systems, smart meter and PV solar system. Before fishing, the fishers collect boxes and ice from this building, they take the amount of ice they need for fishing and fill each box with about 50 percent ice and 50 percent fish. Once they are done fishing, the fish is sold directly to fish traders who already have their boxes. Once the fish has been sold, the tables are taken back to the Packaway building and washed in the box washing machine. During the day, the PV panel produces power and feeds it directly to the national grid through an inverter, as shown in Figure 4.8.

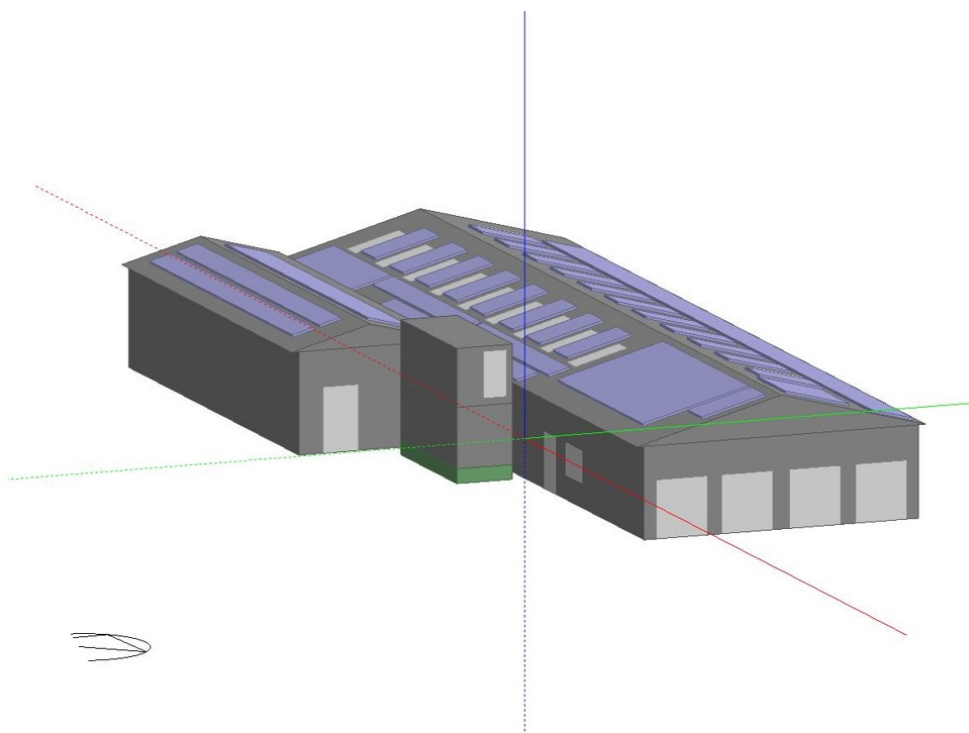

Figure 4.8: Packaway building model using DesignBuilder

However, when the fishers need to use electricity for the main appliances in the building, the system automatically applies the power from the central grid system. The electricity transmission company calculate how much energy Packaway building produces and how much is consumed during a known period based using smart meters. A smart meter is used to measure energy consumption or energy generation from a building, and the data is then stored or transferred to the central control server. The Packaway building has two smart meters, one for the flake ice machine and one for the ice store. According to electrical staff on-site, the smart meter data is logged at 30-minute intervals. However, the smart meter has not been calibrated since being installed. The lighting system in Packaway has 23 double tube lighting fixtures, each tube 25 W. Due to the natural light available in the building, fishers are reported not to use the lighting system very often, and may rarely use it in the evening for short periods. There are four storage rooms in the Packaway building, and each storage room has a double tube lighting system. The box washing machine has a 50-kW power capacity and is only in use when the fishers want to clean the boxes (usually towards the end of the day) and is then only in use for a short period. There is very little historical data for the box wash-

### 4.3. IMPLEMENTING THE SIMULATION MODEL

---

ing machine, particularly concerning usage time and power consumption. The ice storage system is in constant operation to meet the fishers demand for ice. Data from the ice storage machine is recorded every 30 minutes and has done so since being installed. The simulation of Packaway building has been generated using design builder software. The model includes building appliances, Milford Haven's weather data, PV system, operation time and load capacity of machines. To model the Packaway building, detailed data was required to obtain accurate results from the drawing of the building to the hourly power consumption in the building.

#### 4.3.1.1.2 K Shed

The K Shed is an open hall, which is used mainly for storage by MHPA with an area sectioned off for an external tenant who also uses it for storage, including a fridge/freezer. Within the property, there is also a cold room that benefits from solar panels. No heating is used within the premises because the office area is not in use. This building has a PV solar capacity of 50 kW. After the fish is processed, it is stored in the chiller storage room for up to 12 hours on average. The chiller storage consists of a lighting system and cooling system, and the cooling system specification was captured from the system. However, there is a lack of data about the operation times during the day. The main hall area of the K Shed is multi-functional and is used to store boxes, boats and tools. According to staff, the chiller has been out of order for an extended period. The main area of K Shed has an estimated 62 double tube lighting system. The building contains only one smart meter, which records all of the data related to the PV system, and three inverters. Within the K Shed, there is a device to measure temperature and a plot that contains data that could be used about power consumption. The geometry of the K Shed as shown in figure 4.9 is approximately 30 m in length and 15 m in width and 6 m in height. It contains chiller units, an extensive repair and storage area and offices. It is occupied for 8 hours a day.

#### 4.3.1.1.3 M Shed

The M Shed building is currently occupied by multiple tenants, as can be seen in Figure 4.10. The building includes lighting systems and various appliances. The project partners in MHPA will liaise with the building's tenants to acquire the data



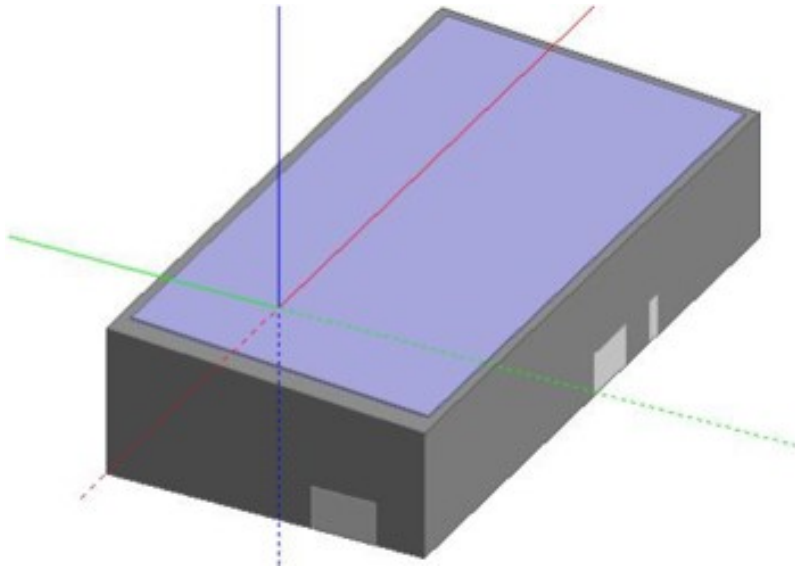

Figure 4.9: K Shed model

needed for simulation. Unit A is used as a boat repair workshop for non-commercial boats, While units B and C are used as storage facilities. At the other end of the building, the Marine Pollution Salvage Centre (MPSC) has an office and workshop area. The following figure 4.10 shows the simulation result for the M Shed building, generated using design builder software. The model includes building appliances, Milford Haven weather data, PV system, operation times and appliances load capacity. To calibrate the data, further data is required on the M Shed. Although MHPA's project partners have kindly offered to provide utility bills for the building, M Shed will need an energy audit if it needs to be modelled during the project.

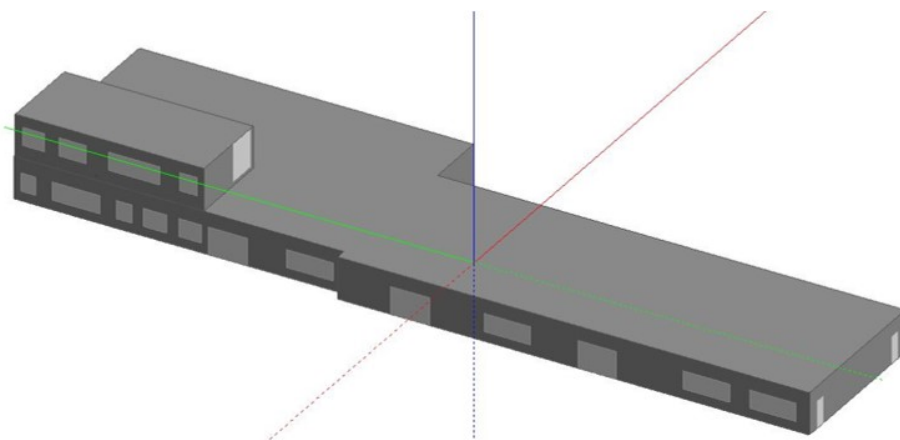

Figure 4.10: M Shed model

## 4.3. IMPLEMENTING THE SIMULATION MODEL

---

### 4.3.1.1.4 F Shed

F Shed is a new build that has been divided into six units: Unit 1, Unit 2 Ground Floor, Unit 2 First Floor, Unit 3 Ground Floor, Unit 3 First Floor and Unit 4. The ground floor units offer facilities for fish processing, and the two first floor units are for light storage such as fish boxes. The building is currently unoccupied except for group 4, which is occupied by a tenant. Unit 4 contains multiple appliances for the fish food processing industry. Unit 4 is currently occupied with a tenant that specialises in crab processing. The unit contains seven electrical appliances used as part of the production line. Each appliance has a specific power capacity. However, the company only moved into F Shed in March 2018, which means that there is very limited and accurate data on their total power consumption at this stage. Nevertheless, Milford Haven has provided data on F Shed, which has made it feasible to create a model as shown in figure 4.11 to understand the annual power consumption of the building based on the operation schedule times.

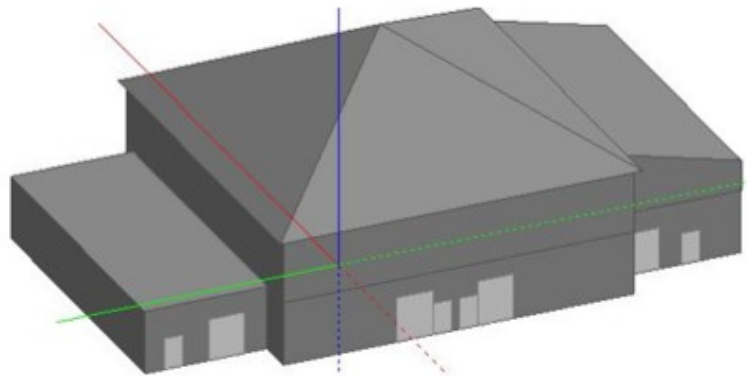

Figure 4.11: F Shed model

### 4.3.1.1.5 J Shed

J Shed is considered to be the most significant building on the site and is currently occupied by different tenants. It looks to be a very complex building and has many electrical systems. The building itself is split into three occupied units: one of the units has a retail shop with an area for fish processing and upstairs office space, the second unit is used for fish processing and storage, the third unit is a fish hawkers hall that is used by individuals for small processing and storage. The building has been modelled using DesignBuilder, and the simulation has been developed

#### 4.3. IMPLEMENTING THE SIMULATION MODEL

---

for unit 1 only. This unit consists of a retail shop, an area for fish processing and office space, as shown in the following figure 4.12.

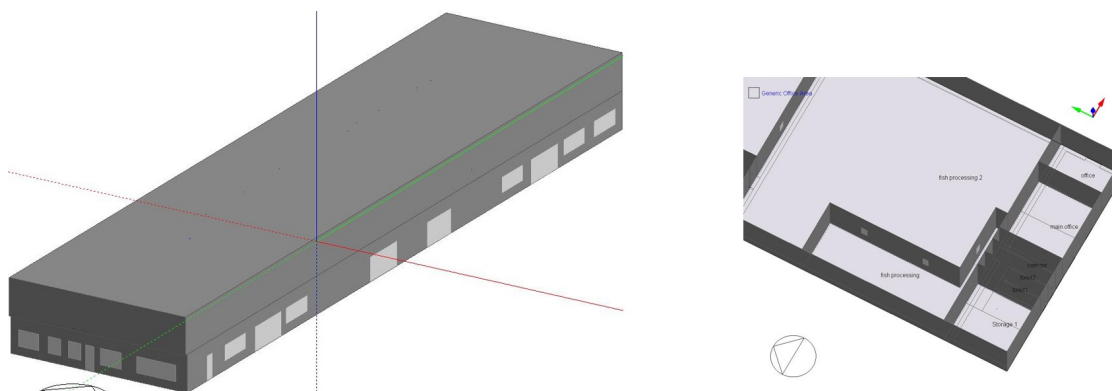

Figure 4.12: J Shed model

##### 4.3.1.1.6 Solar Farm

The first solar farm was built in California in 1980, with limited development taking place until the beginning of 2004. From 2004, developed countries began to show more interest in solar farms, which encouraged the development and deployment of solar farms around the world. Solar farms, also known as solar parks or a solar field, are large scale systems of solar photovoltaic panels that generate clean electricity, which usually feeds into the grid. Solar farms typically cover areas between 1 to 200 acres and are most commonly developed in rural, agricultural areas. According to Burke, the average life expectancy of solar farms range from 20 to 25 years. The power production from solar farms along with its zero CO<sub>2</sub> emissions and minimal noise production make solar farms an increasingly popular choice. The main environmental disadvantage to solar farms is the need for acres of rural space. Jones has identified that solar farms generating 5-megawatt peak (MWp) have the capacity to supply electricity to approximately 1200 houses, saving up to 500 grams per kilowatt-hour (g/kWh) or 2150 tonnes of CO. A 5MW solar farm requires 15 hectares of land, with roughly one-third of the total area being covered by 22,000 solar panels. The output can be utilised on-site but is usually fed into the national grid.

A report from the department of energy and climate change states that the deployment of solar farms has increased from 2011 to 2015, and there are now

### 4.3. IMPLEMENTING THE SIMULATION MODEL

---

23 solar farms in Wales with a capacity of 198.6 MW [388]. According to Government [388] report, the increase in solar farms has been driven by concerns that the electrical grid has limited capacity for renewable energy. Consequently, there has been a recent race to guarantee grid connection. MHPA generates a lot of its own energy, all of the port authority buildings roofs have been installed with PV systems with various capacities. The port also has a five-megawatt PV capacity after more than 1997 panels were installed on the premises. As shown in Figure 4.13, there are five cabins on site which are responsible for inverting DC to AC (32000 kV) and to link it directly to the national grid, as shown in Figure 4.13. Milford Haven's solar farm is directly linked with a website that provides instantaneous readings of the solar farm's power production.



Figure 4.13: Solar Farm

#### 4.3.2 Co-Simulation of energy systems at fish processing industries in MHPA

##### 4.3.2.1 Overview

The previous section highlighted the energy simulation for several fish industries and a local power generation system, which is a solar farm. The energy simulation process is individual, which describes the details of energy use during a period of

time for each building. In this case, there are five fish industries and a local power generation unit. The current status in the port is that power production from the solar farm feeds directly to the national grid and the power demand of industries is then met from the national grid. However, some industries have installed PV systems in the roof. This can meet power demand when the sun is shining but power is required from the grid at night.

The first step to optimise energy systems in the fishery industries is to find the optimum management of the energy in the port by investigating power supply and demand as the first stage in the overall optimisation process in the port. To investigate utilisation of local power generation from solar farm and meet power demand of fish activities, it must integrate total power demand with total power supply via the co-simulation platform. The role of co-simulation platform is to integrate various simulation tools by exchanging data between the programs at each time step. The co-simulation will help to measure the performance of integrated power supply and demand between the fishery industries and the local solar farm in one year. It will also help to estimate the surplus power from the solar farm or power demand from the fishery industries. For this study, The BCVTB integration platform use to allow users to run a couple of different simulation programs for co-simulation, and couple simulation programs with actual hardware. For example, the BCVTB allows us to simulate a building in EnergyPlus, and the HVAC and control system in Modelica, while exchanging data between the software as they simulate. The BCVTB is based on the Ptolemy II software environment.

#### 4.3.2.2 Coupling between EnergyPlus and BCVTB

The actor in BCVTB connects to the external interface in the EnergyPlus. The input/output signals in external interface are exchanged between BCVTB and EnergyPlus. Then the energy plus map to EnergyPlus objects. The external interface are design to take three types of inputs from the BCVTB which is Schedule, Actuator and Variable [389]. The Energy Management System (EMS) is a supervisory control capability that can read data from different sensors and then use that data to direct different types of control actions. The EMS:actuator is used to overwrite different parameters as an input. However, the Output:Variable from any EnergyPlus or EMS

### 4.3. IMPLEMENTING THE SIMULATION MODEL

---

can send to the BCVTB at each time step [390]. The External interface:variable is a global variable that can be used within the EMS:Program or as EMS:Global Variable and EMS:Sensor. The External interface:variable must have an initial value is required to run the systems.

#### 4.3.2.3 The interface between the solar farm and the fishery industries

The main objective of integrating the cluster of buildings with the solar farm through simulation is to investigate the capability of the solar farm to meet the total power demand of the entire site of buildings with their associated operations. It also aims to find the optimum management of the energy system in the port by investigating power supply and demand as a first step in the overall optimisation process in the port. Co-simulation software has been used, such as BCVTB software, to connect different types of simulation engines to facilitate the exchange of data between various simulations. The solar farm has been modelled using Simulink and EnergyPlus, which are linked together with BCVTB. Figure 4.14 presents the BCVTB models and the main components for the integration. It highlights the conceptual integration between power demand and supply within the energy cluster. To analyse the power supply and demand, two different simulation engines were used which: (i) the first to evaluate total power demand in the fish industry and (ii) the second to simulate solar farm energy generation.

Three main items are required to interface with EnergyPlus using an external interface:

- (i) An object to instruct EnergyPlus to activate the external interface.
  - (ii) Energy plus objects then write data from the external interface to the EMS.
  - (iii) A configuration file for exchanging data is then produced.
- (A) Creating EnergyPlus idf file To write data from the external interface to EnergyPlus, an EMS variable is used via an EnergyPlus object of the following data:
- (B) Using xml syntax to configure the file To map the data between EnergyPlus and an external interface, it must defined as an XML file called variable.cfg.

## 4.3. IMPLEMENTING THE SIMULATION MODEL

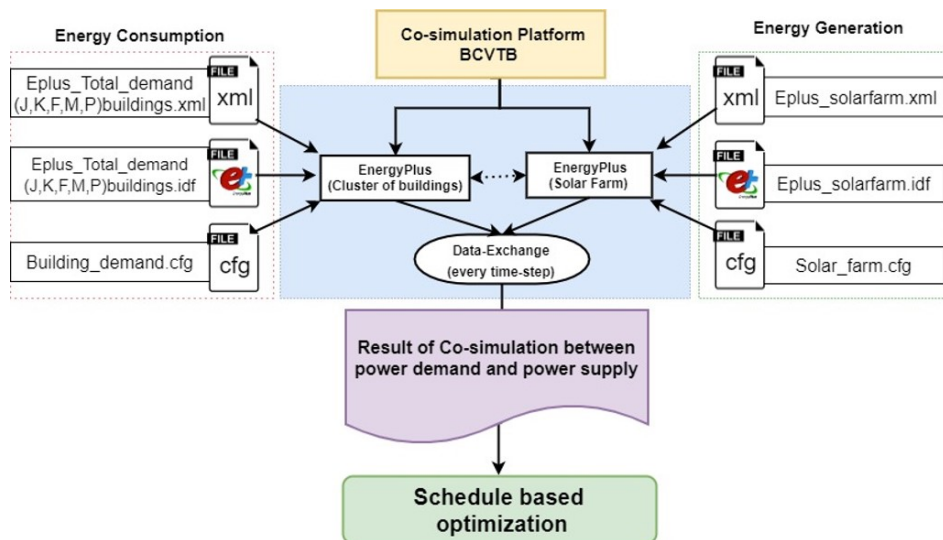

Figure 4.14: The conceptual integration between power demand and supply within the energy cluster

This file needs to be located in the same directory as the EnergyPlus idf file.

The code of the xml syntax for this simulation follows:

```

LoadModelV1 - Notepad
File Edit Format View Help
FacilityElec,          !- Name
BuildingElec,         !- EMS Variable Name
Summed,               !- Type of Data in Variable
ZoneTimestep,         !- Update Frequency
,                     !- EMS Program or Subroutine Name
Joules;               !- Units

!- ===== ALL OBJECTS IN CLASS: EXTERNALINTERFACE =====
ExternalInterface,
PtolemyServer;       !- Name of External Interface

!- ===== ALL OBJECTS IN CLASS: EXTERNALINTERFACE:VARIABLE =====
ExternalInterface:Variable,
Input,                !- Name
1;                    !- Initial Value

```

The next step is to activate the external interface and declare the variable name as Input, which can be used in the energy management run-time language to actuate the control between power supply and demand in port, as follows:

### 4.3.2.4 Configuring the BCVTB platform components

The following figure 4.15 presents the BCVTB models and the main components for the integrations. This model highlights the conceptual integration between power



### 4.3. IMPLEMENTING THE SIMULATION MODEL

```

*LoadModelV1 - Notepad
File Edit Format View Help
!- ===== ALL OBJECTS IN CLASS: ENERGYMANAGEMENTSYSTEM:SENSOR =====
|
EnergyManagementSystem:Sensor,
  Electricity,          !- Name
  ,                    !- Output:Variable or Output:Meter Index Key Name
  Electricity:Facility; !- Output:Variable or Output:Meter Name

!- ===== ALL OBJECTS IN CLASS: ENERGYMANAGEMENTSYSTEM:PROGRAMCALLINGMANAGER =====
EnergyManagementSystem:ProgramCallingManager,
  MyProg,              !- Name
  AfterPredictorBeforeHVACManagers, !- EnergyPlus Model Calling Point
  Program;             !- Program Name 1

!- ===== ALL OBJECTS IN CLASS: ENERGYMANAGEMENTSYSTEM:PROGRAM =====
EnergyManagementSystem:Program,
  Program,             !- Name

  SET BuildingElec = Electricity ; !- A4

!- ===== ALL OBJECTS IN CLASS: ENERGYMANAGEMENTSYSTEM:GLOBALVARIABLE =====
EnergyManagementSystem:GlobalVariable,
  BuildingElec;        !- Er1 Variable 1 Name

!- ===== ALL OBJECTS IN CLASS: ENERGYMANAGEMENTSYSTEM:OUTPUTVARIABLE =====
EnergyManagementSystem:OutputVariable,
  FacilityElec,        !- Name
  BuildingElec,        !- EMS Variable Name
  Summed,              !- Type of Data in Variable
  ZoneTimestep,        !- Update Frequency
  ,                    !- EMS Program or Subroutine Name
  Joules;              !- Units
  
```

demand and supply within the energy cluster. To analyze the power supply and demand, i have used two different simulation engines: (i) the first evaluates total power demand in the fishery industry and (ii) the second simulates the solar farm's energy generation.

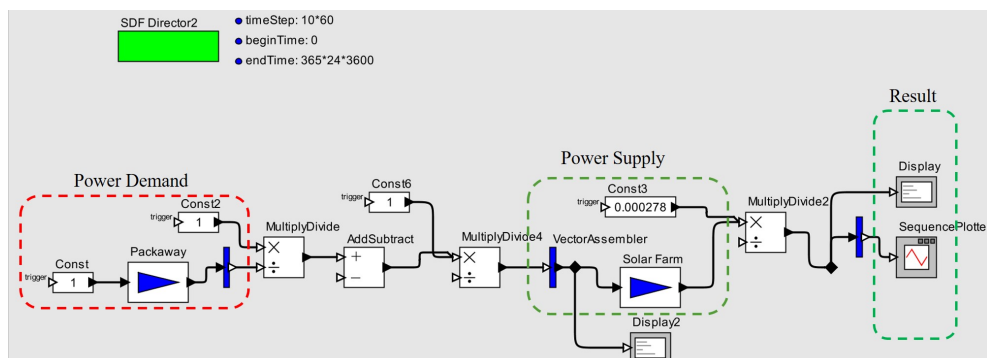

Figure 4.15: Integrating power supply and demand in BCVTB



### 4.4 Initial insights

This section will present the results of the simulation for Milford Haven port. The first section will highlight the simulation result of fishery industries in Milford Haven, and it will discuss the result and compare it with actual data. The next section will demonstrate the simulation result of two different operation sites in fish processing industries and it will discuss the result in detail. The last section will present the simulation result of integrating fishery industries with a solar farm using BCVTB.

#### 4.4.1 Simulation results

The main objective of this study is to model and analyze energy use in the Milford Haven port in a smart energy cluster model, and to understand energy demand and supply with their associated constraints. An inventory of the consumption and production units is performed, also considering the carbon emission and potential of making the port a self-operation energy business.

DesignBuilder software produced different variables of the building energy modelling, such as temperature, fuel consumption, and heat balance system loads ventilation. In the Packaway building, the focus was on annual power consumption and annual power generation. DesignBuilder plotted a chart for the energy consumption for specific appliance, such as the lighting system, cooling, heating and other appliances. After analysing the simulation result, the next step is to calibrate the data with actual data from the site. The calibration process compares the daily power consumption from the port utility bills with the data from the simulation result. During the calibration process, many challenges were encountered. One such problem was that not all utility bills from Packaway building were accurate and were estimated from the power provider. The data that was received from the MHPA partner has been analysed and compared with the model result.

The power generation source identified by the solar farm has been modelled using EnergyPlus, which enables simulation of the power generation during a year. This gives insights into how solar power generation can meet local power demand.

Several parameters are required to model the solar farm, such as PV modules properties, number of modules, inverters, the location of the farm, weather data

#### 4.4. INITIAL INSIGHTS

and the total number of panels. Based on the modelling and simulation, figure 4.16 presents the energy consumption of the individual buildings. It is observed that the energy demand of the port is constant throughout the year.

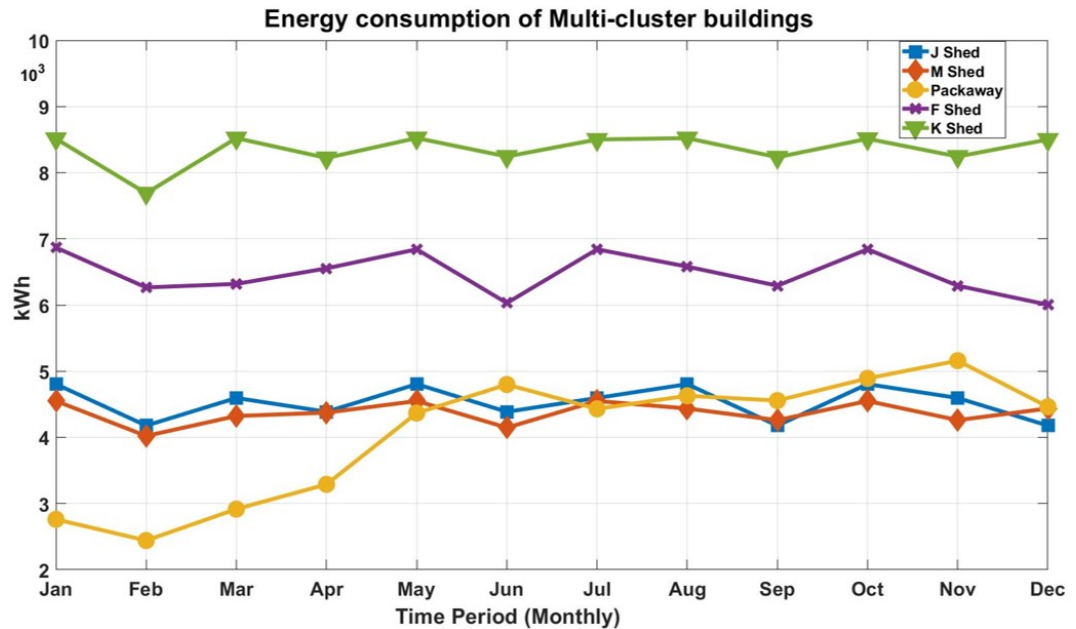

Figure 4.16: Total power consumption of the buildings in the Milford Haven port

The table 4.1 that follows illustrates the total comparison between actual and simulated data for the entire energy system in the Packaway building. The difference between the real and simulation results are minimal, which is due to the detailed data provided by the port authority during the first stages of the methodology, including the surveys and questionnaires.

#### 4.4.2 Integrating buildings with the solar farm using BCVTB

The main objective of integrating the cluster of buildings with the solar farm through simulation is to investigate the capability of the solar farm to meet the total power demand of the entire site of buildings, together with their associated operations. Also, to find the optimum management of the energy system in the port by investigating power supply and demand as a first step in the overall optimisation process in the port. Co-simulation software has been used, such as BCVTB software to connect different types of simulation engines for facilitating the exchange of data between various simulations. The solar farm has been modelled using Simulink

#### 4.4. INITIAL INSIGHTS

---

Table 4.1: The comparison between the actual and simulation result of Packaway

Month	Total power consumption	Total power consumption
	(kWh) Actual	(kWh) Simulation
January	1240.7	1100.132
February	1225.4	1000.12
March	1564.3	2300.276
April	2196.5	2000.24
May	1929.8	2300.276
June	2844.7	3162.8795
July	3132	3019.11225
August	3810	3737.9485
September	2948.7	3150.378
October	1854.7	2200.264
November	1530.9	1100.132
December	1741.4	1050.126
Total	26019.1	26121.88425

and EnergyPlus linked together with BCVTB. The following figure 4.17 presents the BCVTB models and the main components for the integrations.

The optimisation process is based on the simulation of the smart energy cluster system. The optimisation is using simulated energy consumption to determine optimised schedules for the appliances. The optimised schedules represent the time intervals based on which appliances can operate in direct relation with the energy production of the PV system. The optimisation stage is directly integrated with the simulation framework developed with DesignBuilder, EnergyPlus and BCVTB. The simulation-based optimisation will inform of the optimal use of appliances in the different time intervals based on specific simulation parameters and values.

#### 4.4.3 Result of optimising schedules in Packaway

The core aim of optimisation in this study is to schedule the appliances to holistically approach the energy consumption and production in the port. However, to understand the impact of energy consumption, first it apply analysis on the Pack-

#### 4.4. INITIAL INSIGHTS

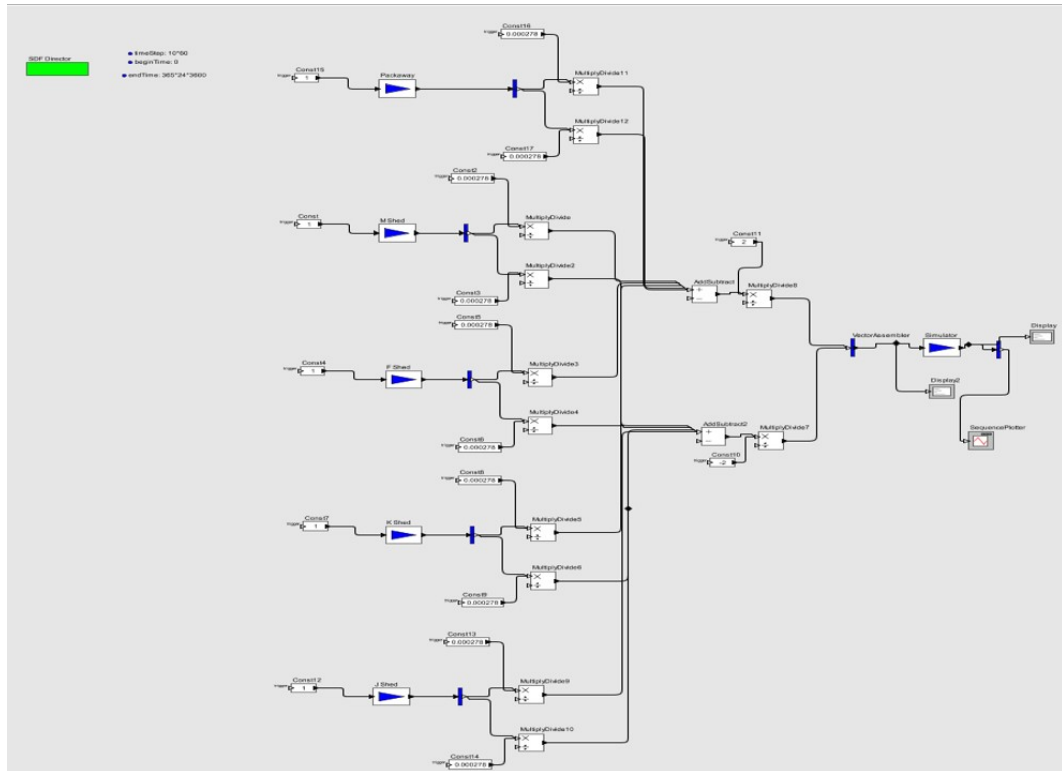

Figure 4.17: Simulation based optimisation BCVTB

away building and propose an energy-based scheduling method for smarter energy management. The results presented below are obtained based on the simulation-based optimisation process and they show the optimised time of operation of appliances by considering different parameters that impact the total power consumption and operation time of each appliance. The following figure 4.18 represents the result of the combination of the electric energy of the five buildings with the energy produced from the solar farm. It is clear through the form that the energy produced from the solar farm is intensive and meets the energy need in the five buildings, and is even enough for a large number of houses, which will be discussed extensively in Chapter Five.

These optimised schedules can orchestrate energy management at the port level and they provide a more efficient use of resources within the port.

The following table 4.2 presents the optimised time of operation per appliance as resulted from the optimisation. It presents the total amount of energy that must be consumed, and the total amount of energy needed, either from the local power generation or from the grid.

#### 4.4. INITIAL INSIGHTS

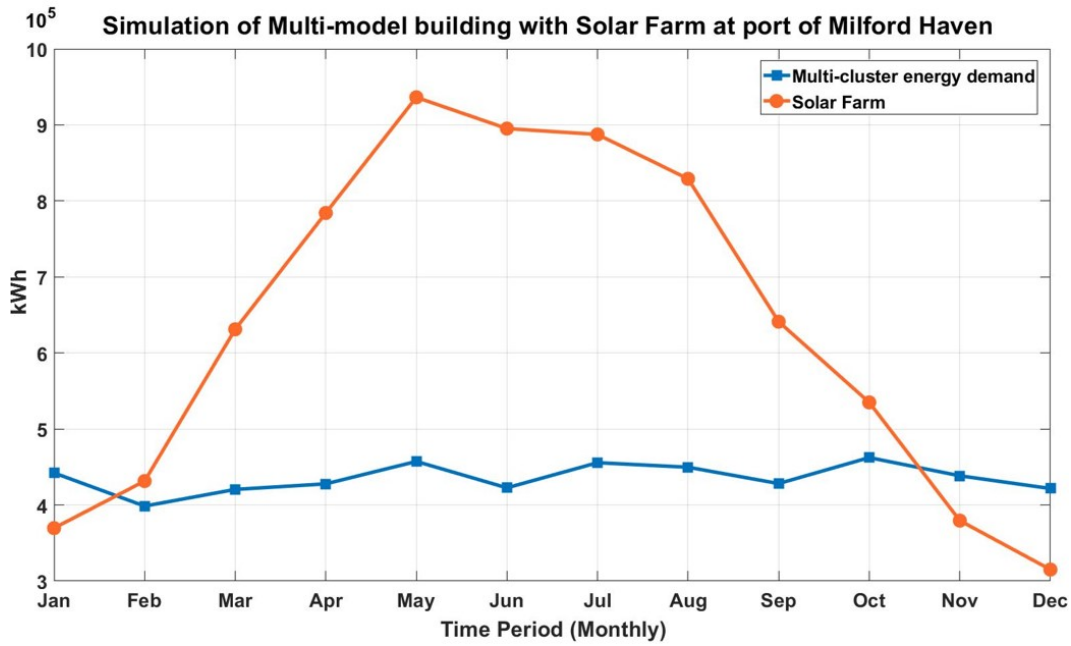

Figure 4.18: Result of integrating buildings with the solar farm in BCVTB

Table 4.2: Impact of energy consumption per appliance

Appliance	Total power consumption per day (kWh)			
	24 hr	12 hr	8 hr	4 hr
Cold room	720	360	240	120
Flake ice	720	360	240	120
Box washing	120	60	40	20
Lighting	66.15	33.075	22.05	11.025

The following table 4.3 shows the trends of energy consumption per appliance at four intervals in the Packaway building, as identified in the simulation.

Table 4.3: The appliance usage list in the Packaway building

Appliance	Total power consumption per day (kWh)					
	Period	Power rating	Minimum running time (minutes)	Interruption of appliance	Required usage frequency	Required start time
Cold room		30 kW	30	NP*	120	0:00-23:45
Flake ice		30 kW	60	P*	120	6:00-16:00
Box washing		50 kW	180	P	20	6:00-16:00
Lighting		25 W/ per tube	60	P	11.025	0:00-23:45

\* NP: Not Possible, P: Possible

The following table 4.5 presents the input constraints of the appliances that must be considered for the energy optimisation process and integration with renewable energy sources. It considers power capacity, the minimum running time of each appliance, the ability to interrupt appliance and the required start time.

Table 4.4: Optimized appliances schedules for the Packaway Building

Appliance	Total power consumption	Operational interval
Cold room	240 kWh	8 hr/day
Flake ice	120 kWh	4 hr/day
Box washing	5 kWh	1 hr/day
Lighting	5 kWh	2 hr/day

## 4.5 Discussion and Conclusion

To develop a simulation model for the energy system in ports, it was important to take an initial step to visit the port and know the nature of the work related to port activities. This step is called a site visit in the energy auditing methodology. The purpose of the visit was to collect data about energy systems, as well as to collect the geographical location, weather data, building drawings, electric appliances, and operating systems at the port. In addition, the energy managers in the port, were met and interviewed, and they discussed the nature of the energy systems and the challenges that they face. During the visit, a questionnaire for port workers that assessed the nature of their work has been conducted, their use of energy systems and the challenges they face during their work in terms of energy systems. This provided the port's energy manager with a list of data required to simulate the port's energy systems, including important details on the equipment, working hours, working nature, peak times, and so on.

One of the challenges that was faced during the visit and during communication with the port energy manager was the difficulty of obtaining data on energy systems in the five buildings targeted for development because they were rented by companies for various offshore activities and some of them did not have sufficient cooperation to obtain the required information. Unfortunately, not enough information was gathered for the J Shed and M Shed building, whose tenants refused to cooperate with us and provide us with the statement that is needed to do the modeling work. There was, however, cooperation from some of the tenants of the buildings, such as K Shed and the Packaway building. These tenants provided us

with the data that is required to produce the energy models, which helped to reach the realistic of the actual consumption that existed. After collecting and analysing the data, the DesignBuilder program was used to make the simulation model in the five buildings. DesignBuilder is one of the most important and popular simulation software programs for energy systems globally. The introduction of data necessary for modeling work such as maps, equipment, the nature of the building, the metal used in the building, the capacity of the devices, the nature of the activity used and the timing of the riots during the week days was easy. In addition, locating the building geographically for the sun helped us to calculate the amount of light inside the building from all sides. DesignBuilder relies on the EnergyPlus simulation engine to calculate and analyze the energy use, as well as show the results regarding the nature of the energy consumption in the building during the year. One of the most difficult problems that was encountered during the use of DesignBuilder during the modeling work was the expiry of the program's subscription period, which needed a large fee to activate the program continuously and permanently. This delayed the work for a period of time before the necessary approvals could be obtained from the university to activate the program.

Another of the challenges that was faced during modelling was the lack of weather and climate data for the port city. Consequently, the port administration was contacted to see if they could provide the city's weather data. An epw. weather file was then created through the SQL program, which took more than 8 weeks. Another problem arose during the work of the model because of the limited capacity of the device that was used, which was a Windows 7 PC, Intel (R) Core (TM) i76700K CPU @ 4 GHz with 16 GB RAM. This device took a very long time to do the modeling. Consequently, long evenings were spent working on the model and to show the results in a way that mimics the nature of consumption in the port.

After the simulations of the five buildings were made, the results of the simulation of energy systems in some buildings were compared with actual consumption readings obtained through electricity bills. The result of the convergence between the results of the simulation and actual readings was very close. The approach in the building of Packaway building almost reached more than 98 percent because the main devices operating in the building were reproduced. The following table



#### 4.5. DISCUSSION AND CONCLUSION

---

4.5 shows the results of the comparison.

Table 4.5: Comparison between model and actual data for the Packaway building

Appliance	Comparison	Power	accuracy %
Main Building	Actual	43528.1	92.82
	Simulation	46894.35	
Flake ice	Actual	17509	98.36
	Simulation	17800	
Cold room	Actual	26019.1	99.9
	Simulation	26109.13	

The aim of the energy modelling for the five buildings in this seaport was to understand the nature of energy consumption, which will contribute significantly to identifying opportunities to reduce electricity consumption and also save costs. Simulation models will also contribute significantly to determining the high energy consumption of buildings and will help to make direct recommendations to the port administration to deal with this problem by reducing electricity waste and increasing energy efficiency. Although, simulation models of those buildings whose tenants refused to provide data were developed, it was impossible to match the simulated results with the actual consumption results due to the lack of data.

After developing the simulation models of the energy systems for the five buildings in the port, a simulation model was made for the solar farm to calculate the amount of electricity generated per hour during the day. The goal is to find the extent to which the demand of the five buildings of the solar farm can be met within one hour because the solar energy generated was sold in full and directly to the national grid, and nothing was used in the port. The BCVTB platform has been used to carry out this experiment, which aims to connect simulation models of the five buildings in the port and the solar farm model to see if the energy demand of the five buildings can be met per hour from the solar farm. This platform aims to create a link between different programs, and measure the impact of energy use and generation during one year. It can also be linked to improvement systems that aim to optimise the efficiency of systems, as well as reduce emissions or any other variables. One of the challenges that was found during the process of linking programs

in the platform was the way in which input orders and also output orders are executed within the platform, which requires commands to be written in the Xml file and simulation files to be added to either the five buildings or the solar farm. This process was largely complex, and the platform required high skill and accuracy in the data entered from the building files for comparison with data from the solar farm.

Due to increased energy consumption in the fish processing industries, it has become necessary to find a smarter way to manage energy and to reduce energy consumption. Renewable energy sources and optimised energy strategies for industry play a vital role in the overall energy management landscape. Applying smart energy management tools can prove to be an efficient and feasible method from an economic perspective, but such solutions can also have an associated modelling complexity.

This chapter focuses on answering the research question of how can a reliable simulation capability be developed that provides real-time accounts of energy demand and use for fishery buildings? And during the modelling and simulation of energy systems in fishery buildings; some challenges was faced during this stage such as the difficulty of obtaining an accurate data for some fishery buildings were dealt with and took more time to complete the process of developing all the simulation models of buildings. However, one of the exceptional results in the Energy modeling and simulation phase can be said to be the ability to understand the nature of energy consumption in fishery buildings, which greatly helps to formulate a strategy to improve consumption and use available and clean energy at a lower cost. What distinguishes the results of modeling and simulation of some fishery buildings is that the accuracy of the results was verified by comparing them with real energy consumption, in which the convergence rate was higher than 90 percent. In addition to that, Through the simulation stage, the capability of a solar farm owned by the port authority, which sells the entire energy produced to the national grid without benefiting from it locally was investigated to meet the energy need of fishery buildings within a year through interconnected the five buildings with solar farm in Co-simulation platform. The process of connecting five building models with the solar farm model is very complex and requires effort and time, and the results have

been encouraging and have given a deep analysis of how long consumption can be met through the solar farm within a year.

It can be said that the use of the modeling and simulation process to analyze and understand the nature of energy consumption as well as the extent of renewable energy capacity available locally to meet the energy demand will contribute significantly to drawing a future strategy at the level of the target port in this study to benefit from renewable energy as well as understanding the nature of consumption comprehensively and accurately within a year or more. The originality of this study is in the quality of simulation programs used for analysis and investigation, which is considered one of the first studies that contributed to the understanding and analysis of energy systems in fishing buildings.

## CHAPTER 5

# Developing a micro-grid for a Fishery Port at multi-level

This chapter will highlight the implementation of a micro-grid for the fish processing industries. Fish processing industries use of energy-intensive equipment, such as refrigerators, air conditioners and ice making machines, which leads to high energy costs and, indirectly, to an increase of the carbon emissions. Given that most fish industries sites are old, there is an urgent requirement to make them more sustainable and achieve economic competitiveness in the energy market. Micro-grids have been utilised as efficient solutions in energy-intensive industries to balance energy consumption and production at different scales. Micro-grids can also reduce carbon emissions by using renewable energy resources and applying energy management techniques. In this chapter, a micro-grid system for the fish processing industries has been proposed at multi-level with a validation use-case at Milford Haven Port in South Wales, UK. The system has been modelled using EnergyPlus and MATLAB with an infinite grid, renewable energy resource, battery and charge/discharge controllers to optimise energy consumption and production, and reduce carbon emissions

### 5.1 Introduction

This chapter will conduct an energy analysis and modelling for a fishery port by exploring energy transition from a building level to an energy community level. Modelling principles to deliver a simulation analysis framework were adopted utilising energy modelling software tools to increase energy efficiency for the industrial fish port in Milford Haven, South Wales. This is achieved by investigating the energy us-

age for fish processing and maximising the use of renewable energy sources in energy clusters. The modelling informs how to minimise carbon emissions and store the power surplus in energy storage systems. Next, a smart-energy community model has been developed using multiple software applications, which allows the simulation of energy usage at the local site and integration of different consumer agents. In addition, a mathematical model for the integration of five industries with a local domestic community of 200 houses was developed. This scenario investigates the capability of the local solar farm to meet the power demand of the local energy community. It aims to find the optimum balance between the battery storage system and the number of PVs that are required to meet the community power demand, followed by a stand-alone, off-grid system. At a wider scale, the review of the literature has found that there is a lack of research that delivers a “demand-response” capability within a fishery port, while optimising the use of battery storage, and at the same time promoting the formation of sustainable energy communities. The novelty of this study is that it delivers a co-simulation environment that leverages calibrated energy simulation models to deliver an optimisation capability that (a) manages electrical storage within a district environment, and (b) promotes the formation of energy communities in a fishery port ecosystem. A methodology to address these objectives has been developed, which ensures that rigour and significance criteria are met. By rigour, it ensured that the methodology is scalable, in that the techniques and methods used are independent in the context of the research as provided by the selected fishery port. Conversely, the significance criteria are met by ensuring that the proposed methodology generates an impact within the selected demonstration environment through substantial energy and carbon reductions, as well as energy autonomy through the concept of energy communities that rely on renewables.

## 5.2 Methodological approach to modelling and simulating a micro-grid in a fishery port

After develop a simulation model of the building, the next step is to investigate the capability of modelling and simulation of energy use at a fishery port to inform

## 5.2. METHODOLOGICAL APPROACH TO MODELLING AND SIMULATING A MICRO-GRID IN A FISHERY PORT

the energy use and reduce carbon emission to nearly zero. Consequently, a micro-grid for the fishery industry was developed using the MATLAB/SIMULINK platform. The micro-grid consists of load pattern, grid model, energy storage system, renewable energy generation and control strategy. The result of the integrated components will identify several parameters, such as amount of battery systems, the behaviour of energy consumption and energy generation, and the power use from the national grid. Simulink is a block diagram environment for multidomain simulation and model-based design. It supports system-level design, simulation, automatic code generation, and continuous test and verification of embedded systems. Simulink provides a graphical editor, customisable block libraries, and solvers for modeling and simulating dynamic systems. It is integrated with MATLAB, which enables MATLAB algorithms to be incorporated into models and export simulation results to be sent to MATLAB for further analysis. A multi-stage approach with a five stage methodology (i.e., building simulation stage, energy generation simulation, energy storage simulation, grid model and integration of agents) has been adopted in MATLAB/SIMULINK as shown in Figure 5.1.

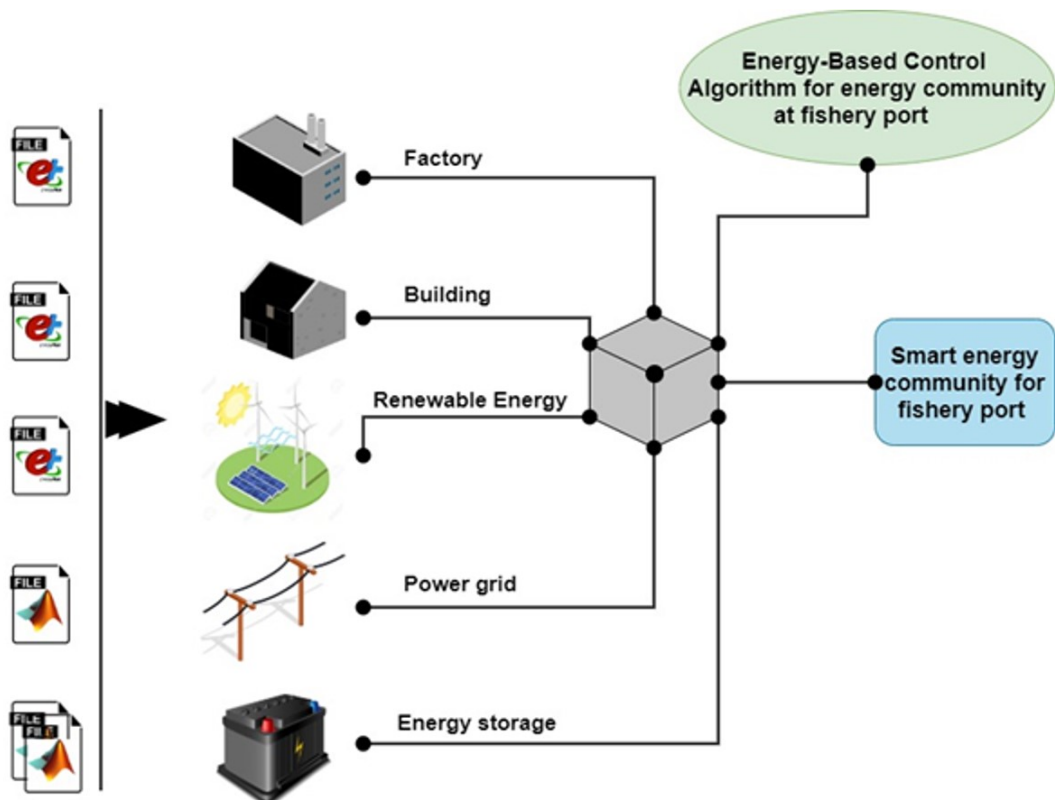

Figure 5.1: Grid component for the fishery industry

### 5.3. MODELING AND IMPLEMENTING A MICRO-GRID IN THE SELECTED CASE STUDY (BUILDING LEVEL)

---

This study uses a multi-stage approach with five stages in the proposed methodology, namely: building simulation stage, energy generation simulation, energy storage simulation, grid model and integration of agents in MATLAB/SIMULINK.

Step 1: The first step of the methodology is to develop a model of electrical energy consumption for fishery ports using a software known as DesignBuilder. The thermal energy model includes geometrical information of the building enriched with occupancy information, material and envelope properties, overall intrinsic (including thermal properties) of the building, scheduled for heating and cooling devices. The simulation model was generated based on a use-case scenario that involves minimising electrical energy consumption in the Packaway building while maintaining acceptable CO<sub>2</sub> emissions.

Step 2: The next step is to simulate the system based on the different combinations of control variables. Initially, the thermal model will be generated using DesignBuilder and exported to EnergyPlus (an open-source and cross-platform energy simulation environment). The Packaway building is the main building and it contains several appliances consuming energy: a flake ice machine, an ice store freezer, box washing machine, lighting systems and a smart meter. There are also four storage rooms in the Packaway building, and each storage room has a double tube lighting system. The box washing machine has a power capacity of 50 kW, and it only works when the fisheries clean boxes during the day. Ice storage is under operation constantly to meet the demand for fish storage according to the quantity required. The figure 5.2 below shows the input-output variables for smart grid model using MATLAB/SIMULINK. It contains control strategy algorithms of the charge/discharge controller, and is based upon a set of rules to distribute and manage the power system between the four agents.

### 5.3 Modeling and implementing a micro-grid in the selected case study (Building level)

Micro-grid systems provide the opportunity for the fish-processing industry to become more sustainable. Introducing smart energy systems to the fish-processing industry will help to reduce the operation costs by reducing energy losses and ef-

### 5.3. MODELING AND IMPLEMENTING A MICRO-GRID IN THE SELECTED CASE STUDY (BUILDING LEVEL)

---

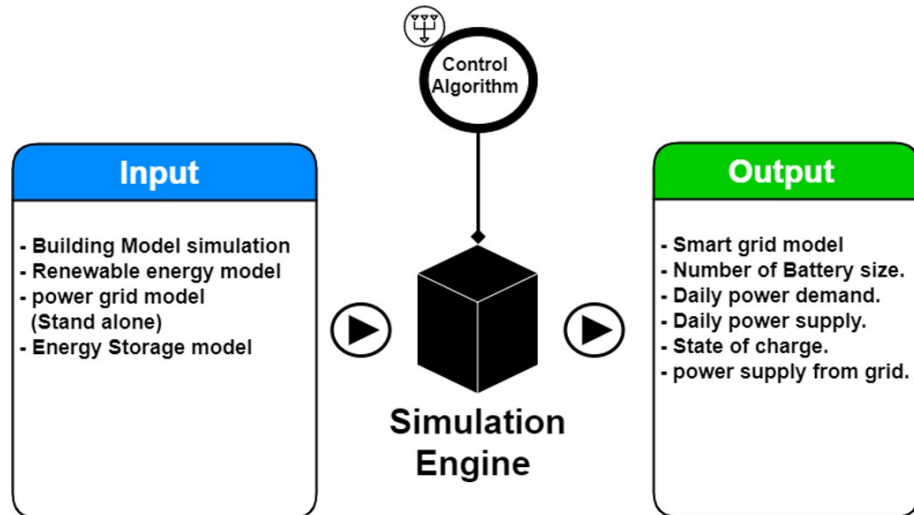

Figure 5.2: Input Output variables for a smart-grid model using Simulink

ficiently use locally generated power. Howell et al. [152] suggests that applying smart-grid technologies can be beneficial to an industry as a commitment to reduce carbon emissions and can portray this industry in a positive light with the public and within the industrial sector. For the Milford Haven site, an integration between load model, PV model, battery and grid was proposed to achieve a better understanding of the overall operation of the system. The signals generated during simulation are used to assess the load, power generation, grid and the battery's state of charge. presents the main components of the integration model for the Packaway building battery storage system. The building has a rooftop PV system with a capacity of 50 kW, including a DC-DC converter and a DC-AC inverter. For the proposed smart grid model, the power generation relates to the main appliances in the building and energy excess is configured to charge the battery system. The system has different priority levels, whereby the energy produced is utilised for operating the appliances. When there is no demand from the building, the battery system is charged at a second priority level. When there is no demand and the battery is charged, the excess will be sent to the national grid. When there is no power generation from the PV system, the battery system connects with Packaway building to meet the power demand. Similarly, if the battery system discharges when there is power demand from the Packaway building, then the model will allow for the provision of power from the national grid. The system has been tested with different battery capacities as a means to identify the required number of battery



### 5.3. MODELING AND IMPLEMENTING A MICRO-GRID IN THE SELECTED CASE STUDY (BUILDING LEVEL)

---

systems that are required for the local power demand of the Packaway building for 12 months. The following sections will discuss with more details the main components of micro-grid for the fish processing industries.

#### 5.3.1 Load profile (building Level)

The first main component for the micro-grid is the Packaway building and to develop a model of electrical energy consumption for fishery ports using a software known as DesignBuilder (a commercial 3D modeller and energy simulation software platform). The thermal energy model includes geometrical information of the building enriched with occupancy information, material and envelope properties, overall intrinsic (including thermal properties) of the building, scheduled for heating and cooling devices. The simulation model was generated based on a use-case scenario which involves minimising electrical energy consumption in the Packaway building while maintaining acceptable CO<sub>2</sub> emissions as shown in figure 5.3.

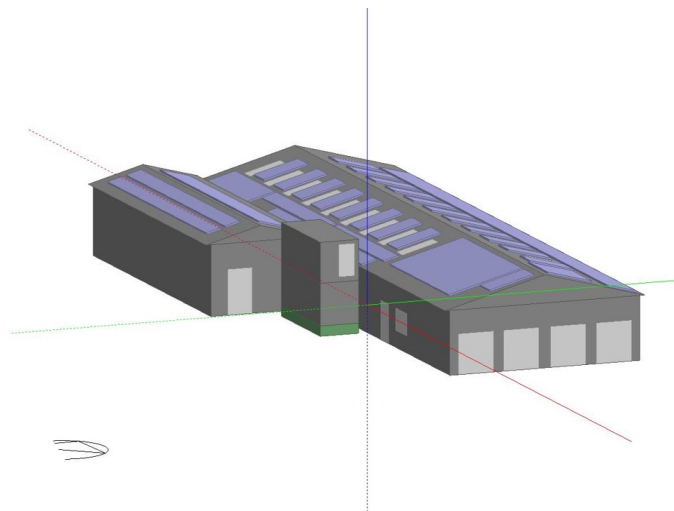

Figure 5.3: 3D-model of Packaway building in Milford Haven

A description of the scenario is given in Table 5.1. The Packaway building has installed a PV system on the roof of the building with 50 kW panels that feed the building at daytime. They have a total power output of 275 W per panel with two DC-AC inverters. The building has been modelled using DesignBuilder simulation software. The model uses weather data, appliances, PV system, operation time and load of appliances with capacity units. The Packaway building is the most power

### 5.3. MODELING AND IMPLEMENTING A MICRO-GRID IN THE SELECTED CASE STUDY (BUILDING LEVEL)

---

consuming building of the site, with an annual power consumption of about 60000 kWh. Modelling and simulating the Packaway building will help to understand the total power consumption and generation, and to determine the periods of the year that have the highest consumption. In addition, this energy modelling will help to identify the areas of energy optimisation and will provide a more informed calculation of the total amount of carbon emissions.

Table 5.1: List of the main appliances in Packaway building

Appliances	Quantity	Power (kW)	Use (hr/day)
Cold Storage	1	30	24
Washing machine	1	50	5 minutes
Lighting	24	11W/per lamb	5
Flake Ice	1	0	4
Plug-in	5	5	1

For the SIMULINK Platform, a three-phase dynamic load model was created to receive power from a grid connection and to meet power demand. A three-phase dynamic load implemented as a Simulink block that acts as a dynamic load for active power  $P$  and reactive power  $Q$ , in the form of a function with positive-sequence voltage, was considered [391]. Because the load does not simulate the negative and zero-sequence currents, the load currents remains balanced with no dependency of the voltages. The active and reactive load values can be specified as a time series, which provides an optimal environment for simulating realistic load data. In the model, the block has a constant impedance that is triggered when the applied voltage is lower than a specified value  $V_{min}$ . The load pattern changes when the voltage is higher than  $V_{min}$ , while the active and reactive power of load varies based on the following equations:

#### 5.3.2 PV power supply

EnergyPlus software was used to generate hourly power production for one year considering a 50-kW solar plant and associated inverters. EnergyPlus also uses the weather data of the fish industry site based on the latitude, longitude of the location. The EnergyPlus engine gives an output of solar energy on an annual basis and

### 5.3. MODELING AND IMPLEMENTING A MICRO-GRID IN THE SELECTED CASE STUDY (BUILDING LEVEL)

---

$$P(s) = P_0 \left( \frac{V}{V_0} \right)^{n_p} \frac{1 + T_{p1}s}{1 + T_{p2}s}$$

$$Q(s) = P_0 \left( \frac{V}{V_0} \right)^{n_q} \frac{1 + T_{q1}s}{1 + T_{q2}s}$$

Where

- $V_0$  is the initial positive sequence voltage.
- $P_0$  and  $Q_0$  are the initial active and reactive powers at the initial voltage  $V_0$ .
- $V$  is the positive-sequence voltage.
- $n_p$  and  $n_q$  are exponents (usually between 1 and 3) controlling the nature of the load.
- $T_{p1}$  and  $T_{p2}$  are time constants controlling the dynamics of the active power  $P$ .
- $T_{q1}$  and  $T_{q2}$  are time constants controlling the dynamics of the reactive power  $Q$ .
- For a constant current load, for example, set  $n_p$  to 1 and  $n_q$  to 1, and for constant impedance load set  $n_p$  to 2 and  $n_q$  to 2.

shows the hourly power generation and solar radiation. The purpose of the grid is to supply any power demand to the property/building and take any surplus or positive power. The solar PV model has a capacity of 50 kW and the power output from PV is modelled as DC. However, this needs to be converted to AC, which can be used to run different equipment in the buildings. A DC-DC converter produces a regulated output three-phase voltages at 50Hz and is used to feed generated power to grid at standard three-phase voltages.

The schematic figure that follows 5.4 presents the solar PV model that has been developed in SIMULINK. An instantaneous active and reactive power is used for this model. When the power generation data receives signals from the PV system, then it need to be converted from DC to AC. To convert to AC, control current sources (CCS) should be used to convert DC input signal to an equivalent current source. The output of CCS will be measured to identify current (Amp) and voltage (V). and then calculate the real and reactive power instantaneously based on equation. When calculating the power, the model may use instantaneous power, which refers to instantaneous current and voltage. This transformed from three phase to  $\alpha\beta 0$  coordinates by using Clarke transformation. The transformation produces a stationary reference frame, where coordinates  $\alpha$  and  $\beta$  are orthogonal and the coordinate 0 corresponds to the zero-sequence component [392].

### 5.3. MODELING AND IMPLEMENTING A MICRO-GRID IN THE SELECTED CASE STUDY (BUILDING LEVEL)

$$P = V_a * I_b + V_b * I_a + V_c * I_c$$

*P: Power  
V: Volt  
C: Current  
a,b,c: three phase*

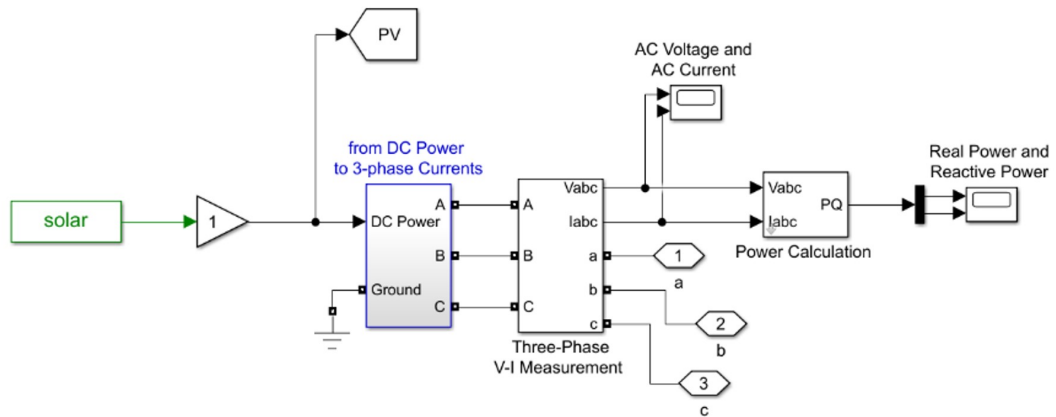

Figure 5.4: PV generation model in SIMULINK platform

#### 5.3.3 Grid connection

The purpose of the grid is to balance the system and take care of spikes in the system. The grid supplies any excessive power demand to the property/building and absorbs the surplus of power. An infinite grid is used because of its flexibility when feeding power demand and generation to the system. For the Packaway building, the grid is connected with the PV system, load model and battery system with a frequency of 50 Hz, which is based on the European standard. Because grids are used for their flexibility of feeding power, the proposed grid was modelled at a frequency of 50 Hz, based on the European standard using MATLAB/SIMULINK [393] as shown in figure 5.5.

#### 5.3.4 Energy storage (battery system)

The concept of "energy storage" depends on how much and how long a quantity of energy can be stored in relation to chemical, mechanical, thermal or electromagnetic techniques. Energy storage applications have developed with the radical transitions that have occurred within the energy systems of many nations. There are several reasons for these changes, such as climate change and mitigation poli-

### 5.3. MODELING AND IMPLEMENTING A MICRO-GRID IN THE SELECTED CASE STUDY (BUILDING LEVEL)

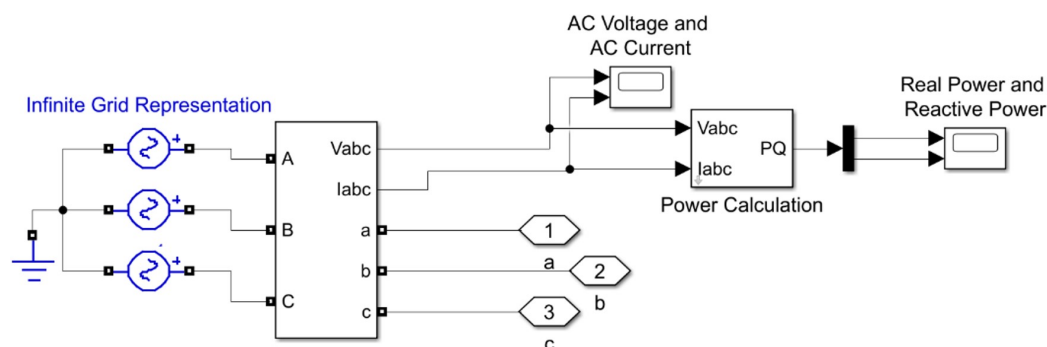

Figure 5.5: Infinity grid model in SIMULINK platform

cies, which have led to the extensive use of renewables, particularly in Europe. At the shortest time scales, the most advanced form of electricity storage is when the quality of power supply is maintained within strict frequency standards.

Electrochemical batteries are the most efficient solutions from the available options. They store and emit energy via electrochemical reactions, which are extremely stable through a variety of operating conditions. These batteries can operate on short periods of time and have greater energy storage efficiency. New battery chemicals, such as Li-ion, are far more effective than previous battery chemicals, and are therefore widely used in electric cars. For the Packaway building, a lithium-ion battery system has been used to cover the overall system with 12 volts and 100 A for each battery. The battery model is controlled by an (Input-P) signal.

From the controller, the signal is generated and sent to the model in the form of a command. The signal represents the difference between power generation from PV and power demand from the Packaway building. The signal indicates the need to charge or discharge the battery system. A positive signal means that the battery system is in a charging state and a negative signal that means it is discharging. The total amount of power is divided based on a battery voltage to find the current input for controlling current sources. The overall output power signal is determined by multiplying the voltage and the current. The state of battery charge signal is generated and sent by a command to the main control block. In this model, a Li-ion battery has been used with a nominal voltage of 12 Volt and rated capacity of 1000 Ah, and with an initial state of charge of 50 percent. Li-Ion batteries are chosen based on their electrochemical potential to provide energy density for weight as shown in figure 5.6. Furthermore, Li-Ion batteries are commonly used in portable



### 5.3. MODELING AND IMPLEMENTING A MICRO-GRID IN THE SELECTED CASE STUDY (BUILDING LEVEL)

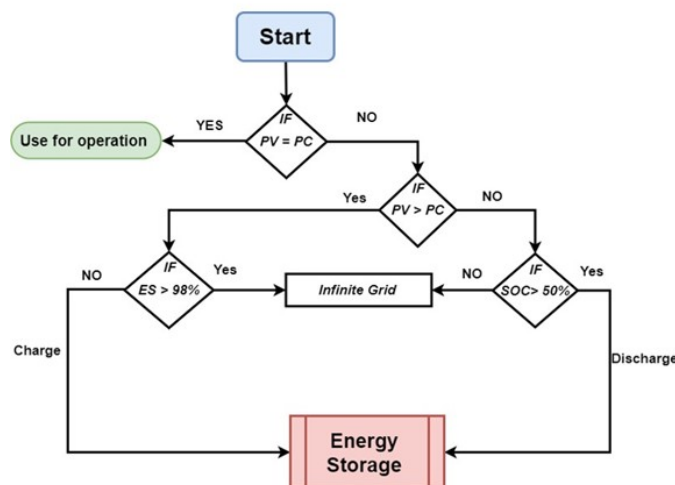

#### Control Charge algorithm 1

##### Initialization

- 1: if  $\sum_{i=0}^n PV = \sum_{i=0}^n PC$
- 2: yes; feed all  $\sum_{i=0}^n P$  to  $\sum_{i=0}^n C$
- 3: no; go to stage 1

##### Stage 1

- 4: if  $\sum_{i=0}^n PV > \sum_{i=0}^n PC$
- 5: then check ES
- 6: if  $SOC \geq 98\%$
- 7: then check ES\_2
- 8: otherwise go to stage 2

##### Stage 2

- 9: if  $SOC\_2 \geq 98\%$
- 10: then sell power to grid
- 11: otherwise charge ES

##### Stage 3

- 9: if  $50\% < SOC\_1 < 98$
- 10: then discharge from ES
- 11: otherwise go to stage 4
- 15: end

Figure 5.7: Control charge algorithm using main storage system

#### 5.3.5.2 Scenario (b): Control algorithm considering main storage system and backup storage

The algorithm of the charge/discharge controller is based upon a set of rules to distribute and manage the power system between the four agents. The scenario has two different models: when power consumption (PC) = power generation (PV), then all of the power generation should feed the power consumption. Is power generation greater than power consumption? If no, then charge battery-1. If yes, then check if the battery storage-1 is full or not. If the battery is full, then check whether backup battery storage. If it is full, then sell the surplus power production to the national grid. Otherwise, charge the backup battery. If no, then check the state of charge of the battery system. Is the SOC greater than 50 and less than 20? If no, then check the state of charge of the backup battery system. Is the SOC greater than 50. If yes, then discharge power demand from the battery system. Otherwise, meet the power demand from the national grid. Figure 5.8 gives a flow chart describing the charge and discharge controller processes considering main

### 5.3. MODELING AND IMPLEMENTING A MICRO-GRID IN THE SELECTED CASE STUDY (BUILDING LEVEL)

storage system.

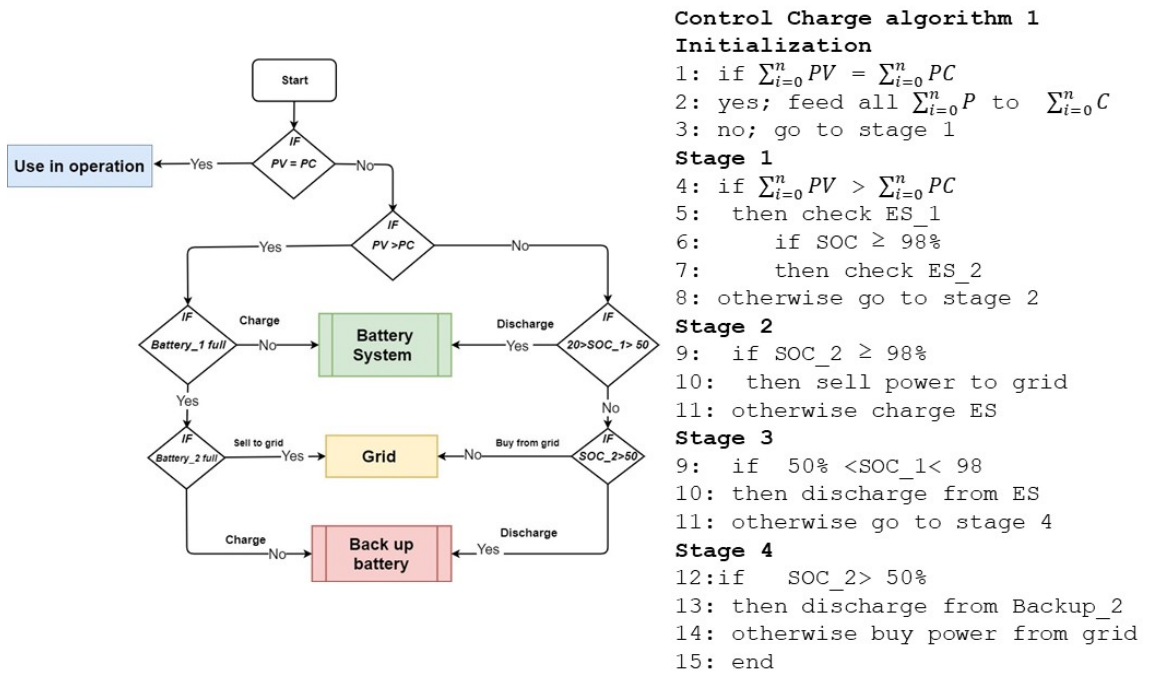

Figure 5.8: Control charge algorithm using main storage system and backup storage

#### 5.3.6 Implementation of a micro-grid in the selected case study

As presented in this section, there are five steps to develop a micro-grid for the fish processing industry. The first step is to produce a simulation model for the fish industry. Before producing this model, it is necessary to collect data on site. This step is known as the walk-through auditing site, and it aims to provide data of all power consumption appliances and time of operation. The audit can help to understand the overall system and the design of the industrial site, with a clear idea of the operation. One of the biggest challenges encountered during the modeling process was the absence of actual reading of power consumption and generation. Moreover, the electricity consumption is usually estimated by the power provider or utility company, which impacts the accuracy of the overall modelling. After collecting data from the site, an EnergyPlus simulation model was developed to provide detailed data and patterns of energy use in the fishery site. This was followed by modelling the energy generation of the industrial site. Solar energy



generation has been modelled with Matlab/Simulink based on the specification of PV panels and the location of site and weather data. The power consumption and power generation data were used for modelling a micro-grid to determine the optimum operation of the system for the industry operations. The system consists of multiple agents such as solar panels with inverter, industry (load pattern), battery system and the grid. A charge and discharge controller is required to control the battery system and the different agents. The simulation model has also been configured to identify the optimum number of batteries required to meet the power demand of the Packaway building. These batteries have the potential to motivate stakeholders to install power systems that will aid in reducing carbon emissions in the fishery industries, while pursuing further research into whether fishery ports have the capability to produce positive energy and become zero carbon advocates. The modelling and implementation of a micro-grid for fish industries represents a step forward and contributes to the development of energy consumption and production projections to promote more efficient operation within the industry. In this chapter, I report on the energy use in fish processing industries by proposing a micro-grid for increasing the efficiency of the overall processing operation and energy management. The simulation model of the grid has been modelled based on four seasons. The model has been simulated based on random intervals in the seasons to observe the behaviour of the system under different situations. In addition, it enables the investigation of the optimum battery storage capacity based on the state of charge per day. The results of the micro-grid simulation reflect the flow of charge and discharge with a curve of differential power generation and power consumption for the Packaway building for each season.

## 5.4 Scaling up the micro-grid at a fishery port

There are five fish processing businesses in Milford Haven port. Each building houses a fish processing business and has its own energy consumption. Each building has been modelled as a separate load using DesignBuilder as shown in figure 5.9, which calculates energy consumption using the EnergyPlus simulation engine. The simulation result data will be used in MATLAB/SIMULINK for integration with

different agents. Three-phase dynamic load models are connected by default to ensure integration of each building entity with the smart-energy community model as a part of requirements. The process will be replicated for each building, with the objective of achieving a community of individual industries, each running different fish processing businesses.

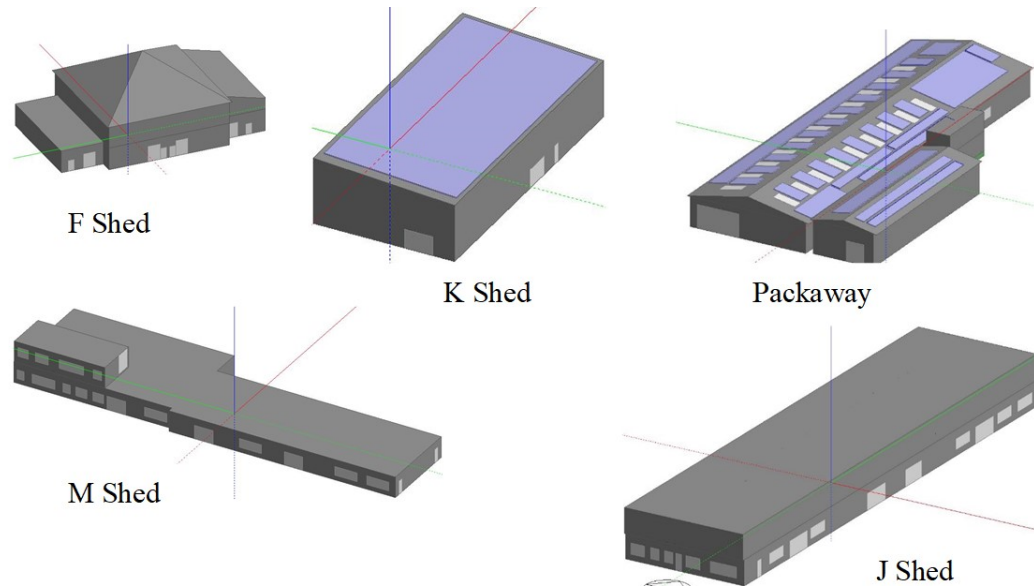

Figure 5.9: Simulation models of the buildings in the port of Milford Haven

The analyses has focused on the Milford Haven Port, with five buildings and a solar farm, based on which the entire fish processing workflow is conducted. The Packaway building is the main building in the port and it contains several appliances consuming energy: a flake ice machine, ice store freezer, box washing machine, lighting systems, and smart meter. Also, there are four storage units in the Packaway building, and each storage has an installed LED lighting system. A 50-kW box-washing machine is used by the fisheries when they need to clean fish containers. The cold storage room is on for 24 hours per day to store fish or other products before sending to the market. The Packaway has installed a solar panel system on the roof of the building, with 50 kW capacity, which is interconnected with a local inverter to use it directly based on weather factors. The models have been created based on a 2-D drawing, and the internal appliances have been modelled and calibrated based on data collected from the port.

The M Shed building is currently occupied by several tenants, and has an inter-

nal lighting system and several appliances. Units B and C of the building are used as storage facilities, while Unit A is used as a boat repair workshop for an incident response provider. The F shed is a new building that is divided into six units: unit one, unit two at ground floor, unit two at first floor, unit three is also on the ground floor. The ground floor units are used for fish processing, while first-floor units are used for storage such as fish containers. The building is still unoccupied, except for unit four, which is occupied with some appliances for fish food processing at the fishery ports. The J Shed is the largest building at the port site and is currently occupied by several stakeholders. It is a complex building and has many electrical systems. The building is split into three occupied units: unit A contains a retail shop and an office space, fish processing appliances, and storage boxes used by individuals as fish deposits. The K Shed is a warehouse. It contains a fridge/freezer used by a stakeholder, with a cold room fed mainly from solar PV panels on the roof, with a power capacity of 50 kW. There is a chiller storage room used to store fish, although the chiller is out of service due to technical issues. The main hall has a 62-double-tube lighting system. The chiller storage consists of a lighting system and cooling system. The solar farm is installed with about a 5-megawatt PV power capacity, containing about 20,000 panels. There are four main cabins in the site, which convert DC to AC (32,000 kV) and then link the solar farm to the national grid. For the Milford Haven site, a model of an integration between load model, PV model, battery, and grid has been proposed to achieve a better understanding of the overall operation of the port. The signals generated during simulation are used to assess the load, power generation, grid, and the battery's state of charge. The building has a rooftop PV system with a capacity of 50 kW, including a DC-DC converter and a DC-AC inverter. For the proposed micro-grid model, the power generation is connected with the main appliances in the building and the energy excess is configured to charge the battery system. The system has different priority levels whereby the energy produced is utilised to operate the appliances. When there is no demand from the building, the battery system is charged at a second priority level. When there is no demand and the battery is charged, the excess will be sent to the national grid. When there is no power generation from the PV system, the battery system is used to meet the power demand. Similarly, if the

battery system discharges when there is power demand from a building, then the model will be interconnected to the national grid to avoid disruption. The system has been tested with several battery capacities as a means to identify the required number of battery systems for the local power demand of the main building for 12 months. A multi-stage approach with five iterations has been adopted to develop the proposed smart-energy community for the port, namely building simulation stage, energy generation model, energy storage model, grid model, and integration of agents. The strategy of the charge/discharge controller is based upon a set of rules to distribute and manage the power among the four agents. Figure 5.10 presents a flow chart describing the charge and discharge controller processes considering the main storage system. The scenario has two different operation modes:

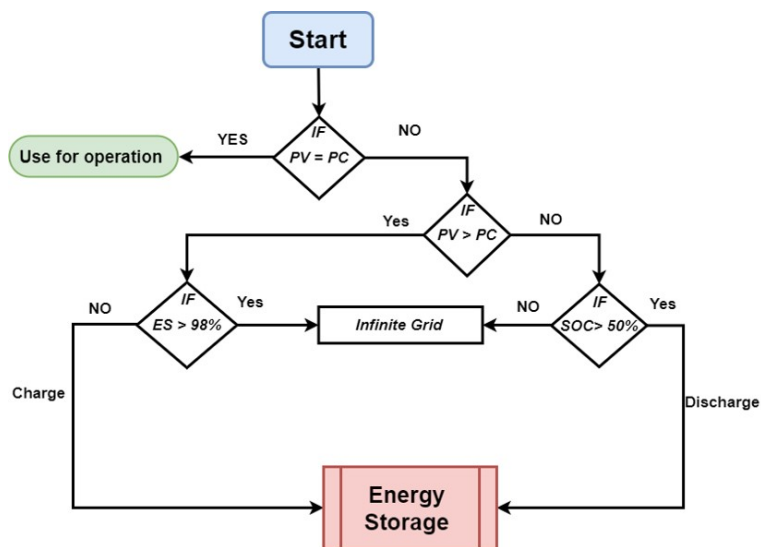

Figure 5.10: Control charge strategy for industries and the local community

when industries demand (ID) = farm production (FP), then all the power generation should feed the power consumption. If FP is greater than ID, then check if the battery is full or not. If the battery is full, then send the power generation to the national grid. Otherwise, charge the battery system. If FP is less than ID, check the state of charge of the battery system. Is the SOC greater than 98 percent or less than 20 percent? If yes, then discharge ID from the battery system. Otherwise, the power demand is met by the national grid.

### 5.5 Scaling up a micro-grid to promote energy community sharing

A smart-energy community provides an opportunity for the fishery port to become more sustainable. Introducing smart-energy systems to the fishery port will help to minimise the operation costs by reducing energy losses and it will make the fishery port more efficient by using locally generated power. Howell et al. [189] suggests that applying a smart-energy community model can be beneficial to an industry as a reliable strategy for reducing carbon emissions, and it can portray this industry in a positive light with the public and within the industrial sector. In Milford Haven port, there is a small community of houses around the marina that serve as living areas for the staff working in the port. Adding domestic buildings is a key element to the overall modelling because it enables the formation of the smart-energy community. In total, 200 houses are used with different loads as a mean to establish the emerging fish port community. In the simulation, all of the buildings are simulated under one load to achieve integration with other community entities. As mentioned earlier in the discussion of the chapter modeling and simulation, it was difficult to obtain energy consumption data of some fish industries in the port campus, which made us strive and investigate the consumption of different appliances in industries to help determine the amount of energy consumption for the entire building. Another challenge has been faced in obtaining the data of energy consumption for the buildings around the port, which is that one of the most significant challenges when trying to create a larger smart-network model around the port to build a more realistic model that simulates the reality of energy usage in the houses surrounding the fishery port. After several attempts were made with the port authority to communicate with some houses around the fishery port to provide important data for the energy simulation models in adjacent homes, the only other option was to make a simulation model for one real house with four bedrooms and then do a repeated calculation for 200 houses. The simulation work was conducted on this basis and then linked inside the micro-grid model with the solar farm and other systems. The strategy of the charge/discharge controller is based upon a set of rules to control and manage the power system among the four

agents. The scenario has two operation modes: when community demand (CD) = farm production (FP), then all the power generation should feed the power consumption. If FP is greater than CD: If no, then charge battery-1. If yes, then check if battery storage-1 is full. If the battery is full, then check backup battery storage. If it is full, then sell the surplus power production to the national grid. Otherwise, charge the backup battery. If no, then check the state of charge (SOC) of the battery system. Is the SOC is greater than 98 percent and less than 20 percent ? If no, then check the SOC of the backup battery system. Is the SOC greater than 98 percent? If yes, then discharge CD from the battery system. Otherwise, the power demand is met by the national grid. Figure 5.11 gives a flow chart describing the charge and discharge controller processes considering the main storage system.

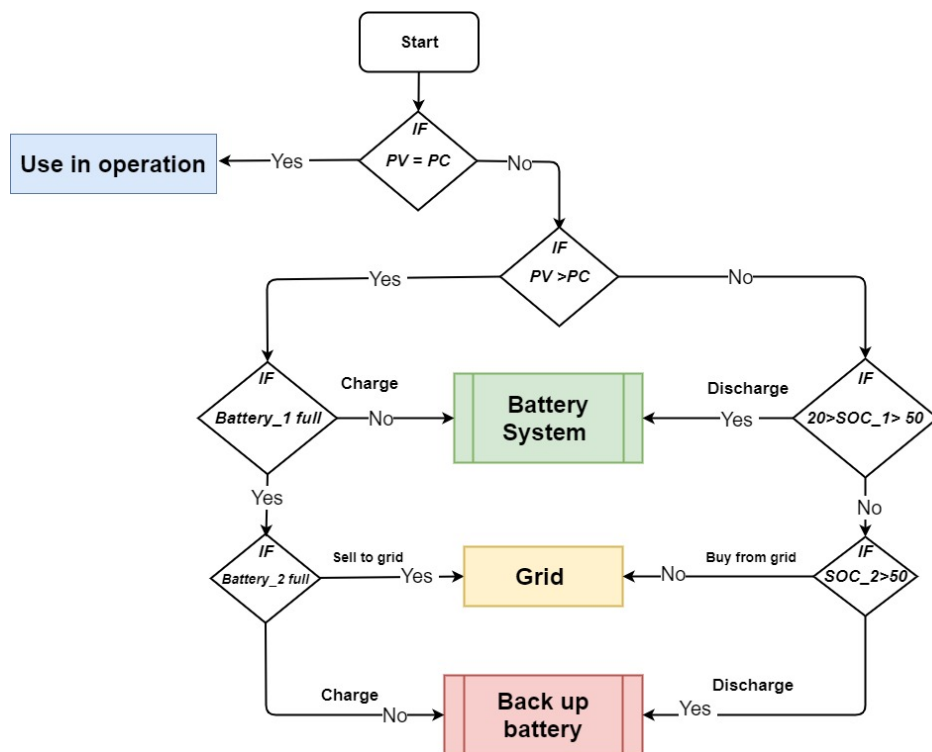

Figure 5.11: Control charge algorithm using main storage system

## 5.6 Results and Discussion

### 5.6.1 Micro-grid at building level

The modelling and implementation of a micro-grid for the fishery industries represents a step forward, and contributes to the development of energy consumption and production projections to promote more efficient operation within the industry. This chapter reports on the energy use in the fish processing industries by proposing a micro-grid to increase the efficiency of the overall processing operation and energy management. A simulation model of the smart-grid has been modelled based on four seasons. The model has been simulated based on random intervals in the seasons to observe the behaviour of the system under different situations. In addition, it enables the investigation of the optimum battery storage capacity based on the state of charge per day. The results of the micro-grid simulation reflect the flow of charge and discharge with a curve of differential power generation and power consumption for the Packaway building for each season.

The smart-grid model utilises an algorithm, based on which energy is exchanged within system components. When the power generation equals the power demand, then all of the power generation should be used for power consumption. Consequently, it is important to determine the state of the power supply and demand, and to identify variability in the consumption intervals. Moreover, a granular data modelling process is implemented, which improves the accuracy and determines the exact response from the battery charge and discharge controller. Figure 5.14 demonstrates the charge and discharge controller during the evaluated period.

The BESS was configured with two lithium-ion batteries, a main battery and a backup battery, to provide flexibility in energy use and support the energy demand. The main battery had a capacity of 7000 Ah and the backup battery had a capacity of 5000 Ah. Two battery systems are used to utilise the surplus energy generated by the PV system during daytime to meet the energy demand within 24 hours at critical times. This BESS provides a certain stability to the site while maintaining an equilibrium when required to feed energy to consuming applications. The resulting consumption and production state of the BESS when the excess electricity is utilised

## 5.6. RESULTS AND DISCUSSION

to operate the equipment and other power consuming units rather than sold to the grid at a lower price can be observed in Figure 5.12, which shows the state of power consumption, generation, and grid exchange over a 24-hour interval. The results show the quick response of the BESS during charging and discharging operations as well as reduced energy consumption from the national grid.

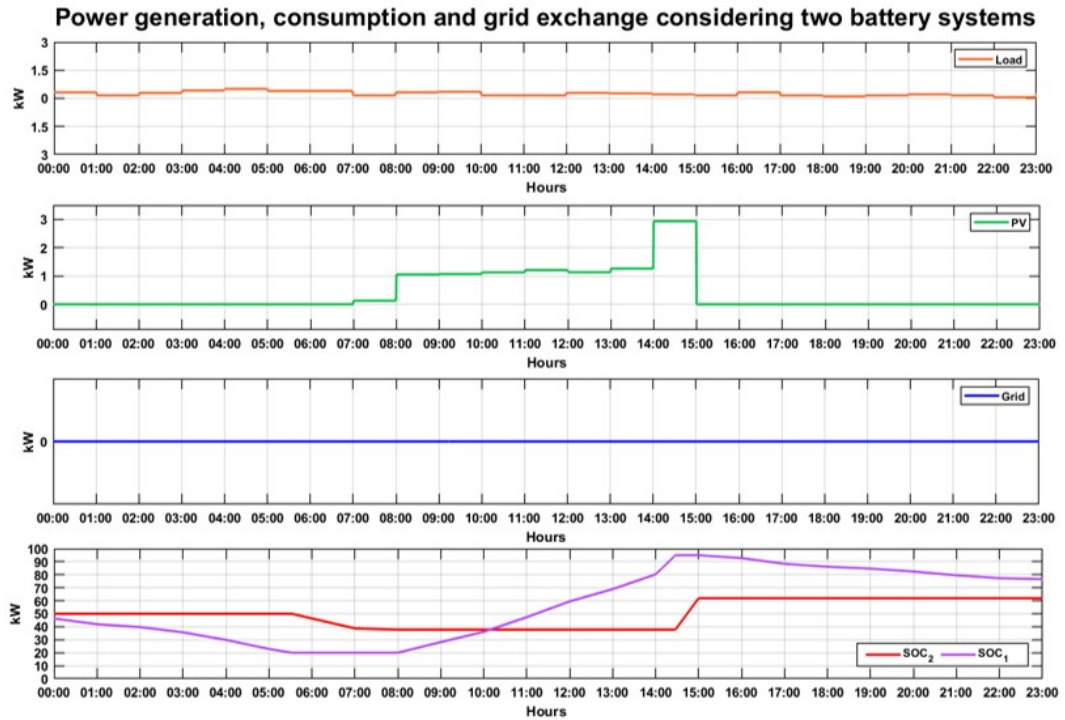

Figure 5.12: Optimising energy use with the micro-grid model

Based on the smart grid modelling as shown in figure 5.13, the power generation is scheduled to operate the appliances in the building, whereas the power generation excess will go to the battery system (charging mode). Conversely, if the battery system is full, then it will send the power to the national grid.



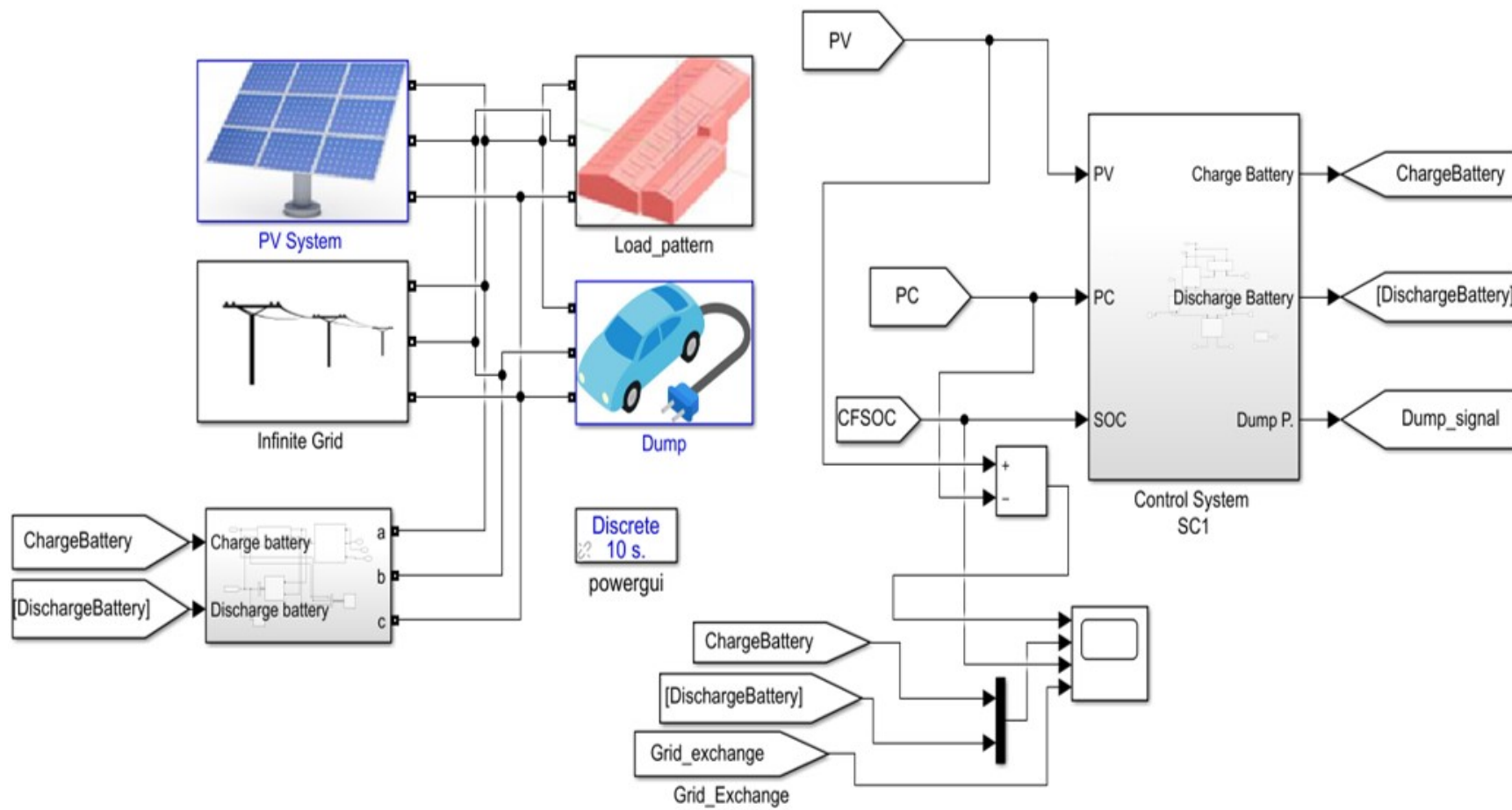

Figure 5.13: Micro-grid system

During night-time, when there is no power generation from the solar system, the power demand can be met from the local battery system (discharging mode). If the power in the battery system does not have enough capacity to meet the demand, then energy from the national grid will be used. Figure 5.14 shows the state of charge of the battery system for four seasons.: (a) state of charge (SOC) for winter, (b) SOC for spring (c) SOC for summer and (d) SOC for autumn. The system has been tested in a random period within the four seasons to identify the behaviour of the operation system and the optimum number of battery systems. For example, during the winter the solar radiation is lower during the day, which will reflect on the optimum number of battery systems required to store the energy excess. Based on this analysis, it has been found that the optimum number of battery storage is about 2000 A per hour, which is about 20 LI-IO battery capacity. However, the size of the battery has been calculated based on a random period in winter. To get the optimum number of battery modules, it is necessary to run the model for four months, which requires the utilisation of a high-performance-computing infrastructure. The result of the simulation was produced from a computer using Windows 7, Intel (R) Core (TM) i7-6700K CPU @ 4 GHz, with 16 GB RAM. Therefore, to get an optimum result, it is necessary to run the model for a longer period in winter, a modelling process that took between 5 to 6 hours. The values in Figure 5.14 show that the system in spring needs more battery. However, discussions with the staff on the site revealed that spring and summer are the main seasons for the fisheries, which means that the industry should be in operation mode at least from 12 to 18 hours on a daily basis. This indicates the need to increase the number of battery systems in spring, which led to the determination of an optimum number of battery charge during the summer of about 7500 A. There are many reasons to increase the number of battery systems in the summer. The daytime in summer in Milford Haven averages from 15 to 19 hours per day. This will lead to an increased number of batteries to augment the charge s to meet the local power demand and utilise the solar energy system during this season.

The results in Figure 5.14, show that the system initially identified a typical stable state with no high-power consumption, which was followed suddenly by an increase to a full charge after sunrise. The battery model as presented in the overall smart-grid model facilitates the understanding of power management in the fishery industries.

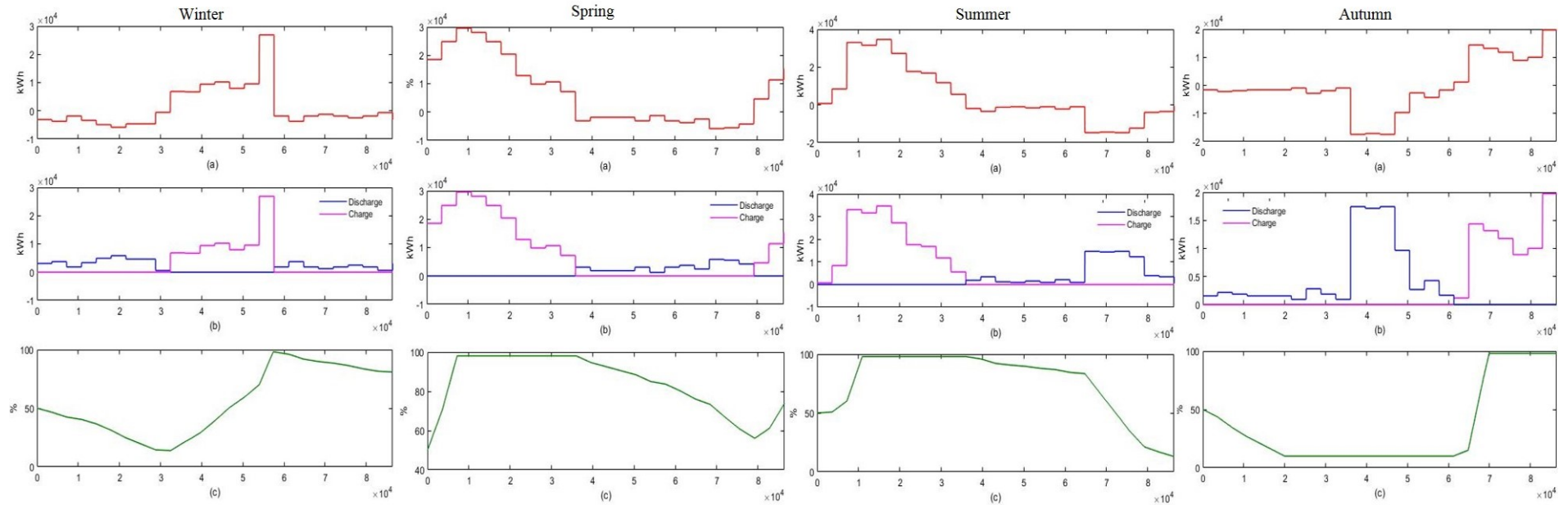

Figure 5.14: State of charge for four seasons [ a- winter, b-spring, c-summer, d-autumn]

### 5.6.2 Scale-up Micro-grid at Fishery port level

This section will provide the results of the analysis of the community simulation. In this scenario, the capability to meet the local power demand of a community using a local solar farm by developing a smart-grid model will be investigated to understand how local power generation can satisfy the load demand for a 24-hour period.

As explained in Section 5.4, a simulation model of power management of energy supply and demand for five fish processing industries and their associated operation at Milford Haven port has been developed. The simulation results showed that a stand-alone smart-grid model can meet the local power demand for 24 hours without the need for power from the grid. The power produced from 5 MW solar from 6 AM to 4 PM can charge a 600 kW Li-Io battery storage to meet the power demand at night. The simulation result from Figure 5.15 shows that a 50 kWh battery storage is the optimum capacity to meet the local power demand of five industries during the night. However, the power load of industries will be met directly from the solar farm in the daytime period, which will also recharge the battery system to meet the local power demand at night. In addition, the simulation results show that the system will dump the surplus power from the solar farm to the grid. The battery charge state shows that the battery system discharges from 12 AM until 8 AM.

As presented in Figure 5.15, more power supply is needed from 5 AM to 8 AM because at this time the fish industries run ice making machines required to store fish before sending it to market. Most of the power demand in the night is used for lighting, cleaning, and for the cold storage system. Each industry has installed a cold room to store fish, which is considered to be the most energy consuming appliances in the industry. The proposed storage integration will help to reduce a considerable amount of carbon emission and also to reduce energy cost with the local energy grid. In addition, the installed solar farm can have a significant impact on the port by increasing income and reducing energy cost because it provides a cost-efficient alternative to the main grid. The results prove that a smart-energy community for fishery ports can not only reduce carbon emissions but can also help to reduce energy consumption, thus facilitating a transition towards clean and

sustainable energy. In addition, these community models supply greener energy to the national grid by using renewable resources available at the site. Furthermore, the solar farm can have a significant impact on the port by increasing the income by selling power to the grid, as well as minimising the impact on the energy cost when buying from the national grid.

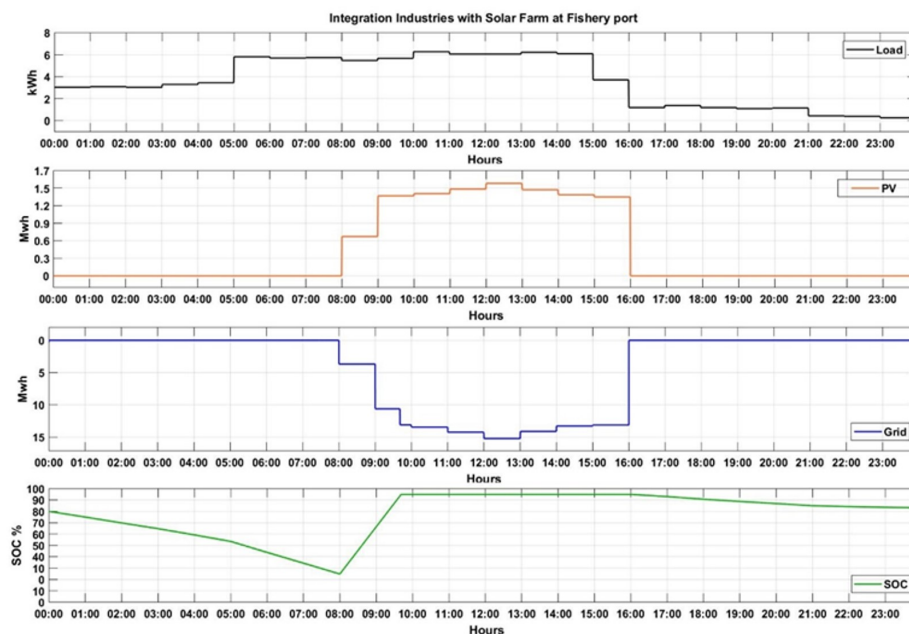

Figure 5.15: The simulation results when integrating industries in the fishery port with the solar farm

### 5.6.3 Scale-up Micro-grid to promote energy community sharing

In this experiment, a smart-energy community around the port using the multi-model simulation platform has been developed. The aim of this scenario is to investigate the capability of the solar farm to meet the power demand of the port and a local community of 200 houses. One of the challenges that arose while collecting data for the simulation of the energy community around the fishery port was the inability to obtain many of the designs of the buildings around the port. This made it difficult to obtain accurate data on the topography of the buildings around the port because it could not be obtained directly from the owners of the buildings. Consequently, a model of a three-bedroom house with different facilities was made. The model building was then repeated to equal the required number of buildings

around the port. This technique was able to achieve a large percentage of convergence between the buildings on the ground and the buildings on which the energy simulation would be made. As a result, the available option was to make a model of a three-bedroom house with different facilities and the building would be repeated to equal the required number of buildings around the port, thus achieving a large percentage of convergence between the buildings on the ground and the buildings on which the energy simulation would be made. The current load is identified by the five buildings at Milford Haven port. This experiment incorporates a load consumption of 200 community houses around the port for 24 hours. In addition, a charge controller strategy containing two battery storage systems is proposed. The main battery storage system and a backup battery system are adopted due to variant loads in the community. To conduct the simulation, an Intel® Core i7TM @ 4.00 GHz with 16 GB RAM is used for the modelling. This computational environment supported the complexity of running an optimisation problem to identify the required amount of battery storage for the energy community. The proposed smart-control strategy contains two battery systems: (i) one battery as a main battery for the whole model and, (ii) a backup battery system to meet the variation of energy demand from the local energy community in the night, as well as to avoid buying power from the grid. During the experiments, I repeated the simulation several times with the same input parameters, while changing the battery system capacity to get the optimum number of batteries (as shown in Table 6.1).

Figure 5.16 presents the simulation result of developing a smart-energy community at the fishery port. The simulation results show that a 1000 battery storage is the optimum amount of battery storage for a community of five industries and 200 community houses.

The simulation results presented in show that smart-energy communities can identify high fluctuations in power demand from both fishery port buildings and the local surrounding community. The results also demonstrate that battery storage can avoid or delay the process of purchasing power from the grid because the state of charge of the main battery reacts adequately to meet the power demand during the night. When the battery system capability is finished, the back-up battery can be used to satisfy the power demand in the buildings. As a consequence

## 5.7. CONCLUSION

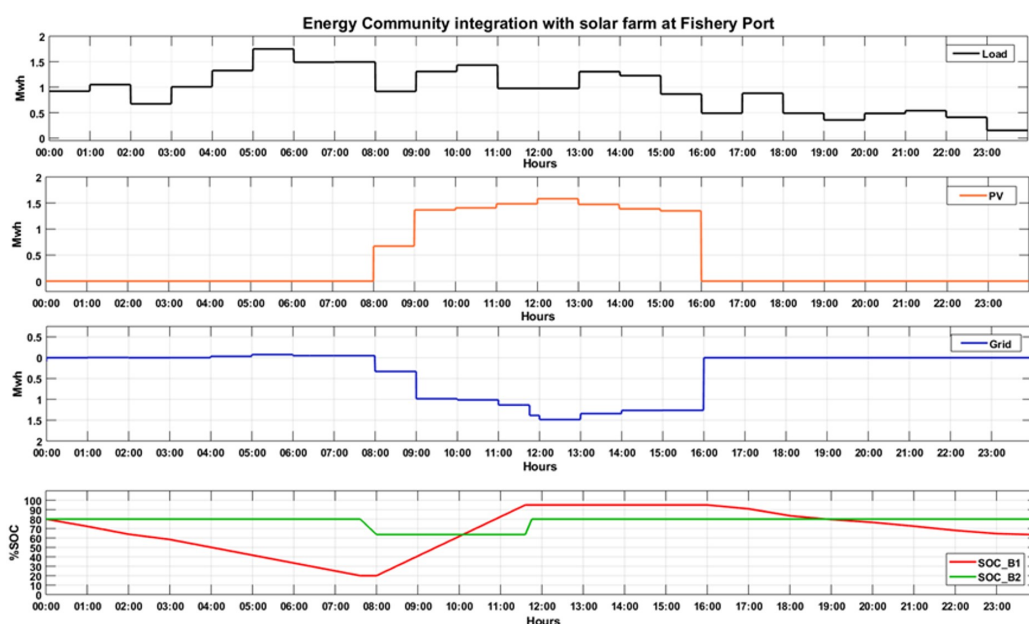

Figure 5.16: Simulation results for the expanded energy community around fishery port

of the complexity of the community simulation, a slight use of power from the grid between 4 and 6 AM was identified, which is an expected fault in the model and is determined by the increased number of energy models included in the simulation.

Table 5.2 shows the simulation trials with an optimum amount of battery storage. The simulation results show that about 1.2 MW capacity of Li-Io battery storage is the optimum capacity for the main battery and about 250 kW is the optimum capacity of back-up battery storage.

## 5.7 Conclusion

This chapter as answering second research question which investigate the capability to adopting smart grid concept for fishery port at multi levels. This study investigates energy use by fishery industries proposing a smart, novel and efficient energy model to manage consumption and production. The micro-grid model has been proposed at multi level to reduce the dependence on fossil fuel and to reduce carbon emission by integrating renewable energy resources and adopting smart energy management systems. The smart energy grid model has been implemented for the Milford Haven port in South Wales, UK. The system has been modelled us-

## 5.7. CONCLUSION

Table 5.2: Optimum battery size trials for smart energy community

Trial	Main Capacity (Ah)	Second Capacity (Ah)	Storage Capacity (Ah)	No. of Main Battery	No. of Second Battery	Grid Supply
1	20840	5000	250	200	50	Yes
2	25000		300	250		
3	30000		360	300		
4	35000		420	350		
5	40000		480	400		
6	45000	10000	540	450	100	
7	50000		600	500		
8	60000		720	600		
9	65000		780	650		
10	70000	15000	840	700	150	
11	75000		900	750		
12	80000		960	800		
13	85000	20000	1020	850	200	
14	100000		1200	1000		No

ing EnergyPlus and MATLAB/Simulink. The results demonstrate that local power demand could be met by local power generation using micro-grids. It has been demonstrated that for Building level that 50 kW capacity of a PV system can meet the local power demand with the integration of LI-IO battery system of 12 Volt, and has the capability to manage power flow for different periods. By presenting this real trial project, It aim to observe what mechanisms from the simulation module are applicable to the real smart-grid project, and find new ways to optimise energy consumption and production for industrial sites.the result showed that main battery had a capacity of 7000 Ah and the backup battery had a capacity of 5000 Ah. Two battery systems are used to utilise the surplus energy generated by the PV system during daytime to meet the energy demand within 24 hours at critical times. For fishery port level, The power produced from 5 MW solar from 6 AM to 4 PM can charge a 600 kW Li-Io battery storage to meet the power demand at night. The



simulation result showed that a 50 kAh battery storage is the optimum capacity to meet the local power demand of five industries during the night. At community level, The simulation results showed that about 1.2 MW capacity of Li-Io battery storage is the optimum capacity for the main battery and about 250 kW is the optimum capacity of back-up battery storage. The future work will explore energy sharing models as a means for optimising energy and resources at the community level. The formation and use of a community energy sharing market with corresponding discovery mechanisms will be given focus, whereby energy agents such as prosumers can satisfy individual demands from consumers [394]. These sharing models will assess the level of trust that can be placed in an energy provider with regards to an advertised energy capability. This approach will unlock energy exchanges within a community [395] and will allow prosumers to monetise their energy excess in a more secure and flexible local market environment.

## CHAPTER 6

# Optimal control strategies for Fishery ports micro-grids

This study investigates the energy usage of a case study fishery port and it evaluates a method to maximise the use of renewable energy sources in these energy clusters via a smart grid approach, while applying price-based control and peer-to-peer (P2P) power sharing considering optimised trading of energy. The new smart control systems aim to reduce gain power from the national grid and they try instead to utilise local energy sources to meet power demand. In addition, it will help the consumers to become local power prosumers who sell, share and trade power within the local community based on the optimised decision making algorithms. The results of the simulation prove that optimised decision making algorithms are able to provide smart, reliable, green and efficient control for a local fishery port and can help to deliver a nearly zero carbon fishery port.

This chapter investigates the implementation of smart micro-grid systems in the fish processing industry with the applicability of battery storage technology from a technical and economic perspective for the Port of Milford Haven that employs price-based control and peer-to-peer (P2P) energy sharing strategies.

### 6.1 Energy community entities at fishery port

The smart grid concept presents a significant opportunity to upgrade the fish processing industry to use smart, sustainable, and clean dispatchable energy sources, which can also deliver long-term economic benefits [134, 396]. The use of smart grids promotes the integration of renewable energy with other local energy sources to increase the reliability and quality of the energy available throughout the grid

[226]. Consumers play a vital role in smart grid technology because they use energy in an informed way to prevent energy waste or loss by optimising their energy consumption during peak times, leading to reduced operation costs and improved energy efficiency [228]. However, there are currently several clear shortcomings in energy management in fishery ports [134, 107, 62, 72, 146, 95, 283, 73, 282, 397, 398, 360, 61, 74, 131, 106]. Consequently, this chapter investigates the implementation of smart micro-grid systems in the fish-processing industry. To do so, we consider the applicability of battery storage technology from a technical and economic perspective for the Port of Milford Haven, which employs price-based control and peer-to-peer (P2P) energy sharing strategies.

The proposed smart micro-grid was simulated and tested using Matlab/Simulink. Simulink is a block diagram environment for multidomain simulation and model-based design that supports system-level design, simulation, automatic code generation, and continuous testing and verification of embedded systems. For the Milford Haven site, a model was defined and developed to integrate the load, PV system, battery system, and grid to simulate the overall operation of the system. Figure 6.1 presents the main components of the grid. The outputs of the simulation were used to assess the status of load, energy generation by the PV system, exchange with the grid, and the State Of Charge (SOC) of the battery system. Each building in the Port of Milford Haven has a rooftop PV system with a capacity of 50 kW that includes a direct current DC–DC converter and a DC–AC inverter. The proposed smart grid model includes different priority levels whereby the energy produced the PV system is first utilised to operate the equipment in each building. When the energy consumption of the building is satisfied, the excess PV-generated power is used to charge the battery system.

Once the batteries are fully charged, the excess energy is sold to the national grid or to peer buildings of the micro-grid. When the PV system is not generating energy, the battery system provides the required energy to the building. The model also allows for the provision of energy from the national grid if the SOC of the battery system falls below critical levels. The system was evaluated using different battery capacities to identify the required number of batteries to meet the energy consumption of the Packaway building over a 12-month period. The fishing boats

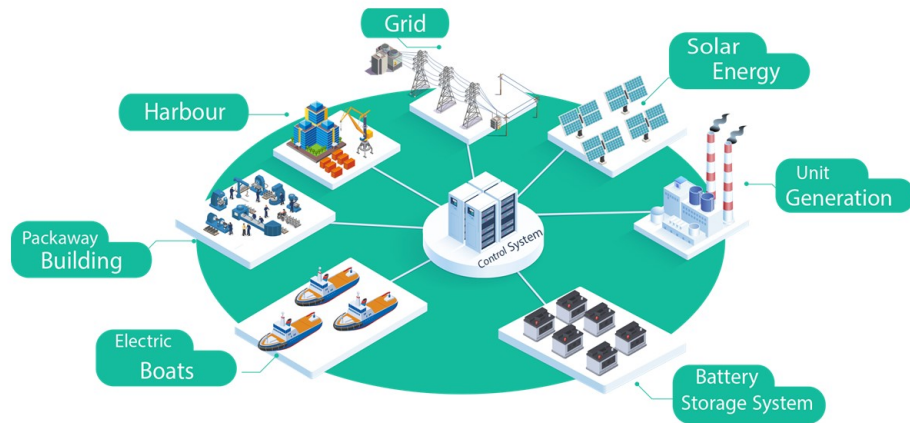

Figure 6.1: The grid energy community at fish industry

are another important entity for fishery ports. Traditionally, fishing boats use fossil fuels to generate power, which has negative impacts on the environment and leads to carbon emissions, noise, and pollution of seawater [399]. However, the continued advance of electric road vehicle technology, similar concepts could also be used to produce efficient electric boats [400], helping to make fishing activities more environmentally friendly. Minami et al. [401] detailed the main features of electric boats, including quietness, low vibration, and zero carbon emissions. By replacing the use of fuel with batteries, not only can the environmental impact of the boats themselves be reduced but their batteries can also be integrated into the micro-grid using bi-directional chargers that can charge and discharge based on the employed micro-grid control strategy [402]. Chapter Six discussed the micro-grid community entities in a fishery port in more detail.

## 6.2 Developing real-time decision making to promote nearly zero carbon fishery port

Two different control algorithms were considered to manage the power distribution of the proposed fishery port micro-grid: a price-based control algorithm and a P2P energy sharing control algorithm, which will be described in the following subsections.

### 6.2.1 Smart control based pricing

The price-based smart grid control algorithm for the fishery port was developed based on the total energy production of the PV panels, the BESS capacity, and/or the electric boats to consider the price of electricity to decide between buying or selling energy. As detailed in Algorithm 1, the system checks for constraints to determine the optimum instantaneous price at the time of selling or buying. These constraints include the SOC of the main and backup batteries because the battery status is crucial to the overall system. The control system works instantaneously and sends signals to the BESS charge controller to store or release energy according to the results of the control algorithm. In this decision-making process, the total power production ( $T_{production}$ ) is the sum of the power produced from PV panels ( $P_{PV}$ ) and the amount of power available in  $n$  batteries of the BESS and/or electric boats, as follows:

$$T_{Production} = P_{PV} + n * P_{EPstorage}$$

The total power consumption ( $T_{Consumption}$ ) is the aggregate consumption of power from the fish processing facilities in the port ( $P_{demand}$ ) and the power required to charge  $n$  batteries of the BESS and electric boats ( $EB_{demand}$ ), as follows:

$$T_{Consumption} = P_{demand} + n * P_{EPdemand}$$

### 6.2.2 Smart control of P2P energy sharing

P2P energy trading represents the latest generation of energy management systems. It enables prosumers in the smart energy community to sell their surplus energy to other participants. The resulting monetary benefits and efficient use of resources provides an excellent motivation to increase local energy generation from RESs and encourage domestic energy providers to share their surplus energy to the closest neighbour instead of selling it to the grid. This helps prosumers to generate revenue and reduce their dependence on energy from the larger grid. This change, in turn, is reflected in a decrease in the total proportion of carbon emissions released by burning fuel or gas in traditional energy plants. Figure 6.2

**Algorithm 1: Price-based control algorithm**

```

Initialisation
1: if  $\sum_{i=0}^n P = \sum_{i=0}^n C$ 
2: yes; feed all  $\sum_{i=0}^n P$  to  $\sum_{i=0}^n P$ 
3: no; go to stage 1
Stage 1
4:   if  $\sum_{i=0}^n P > \sum_{i=0}^n C$ 
5:     then check BESS_1
6:   if  $20 < SOC1 < 95$ 
7:     then charge BESS_1
8:   otherwise go to stage 2
Stage 2
9:   if  $SOC1 > 95$ 
10:    then check  $P_E^{price}$ 
11:   if  $P_{preference} < P_E^{price}$ 
12:    then sell  $P$  to the grid
13:    else check BESS_2
13:   otherwise go to stage 3
Stage 3
14:   if  $SOC2 > 98$ 
15:    then sell energy to grid
16:    else charge BESS_2
17:   otherwise go to stage 4
Stage 4
17:   if  $SOC2 > 20$ 
18:    then discharge BESS_2
19:   else buy energy from grid
20:   end

```

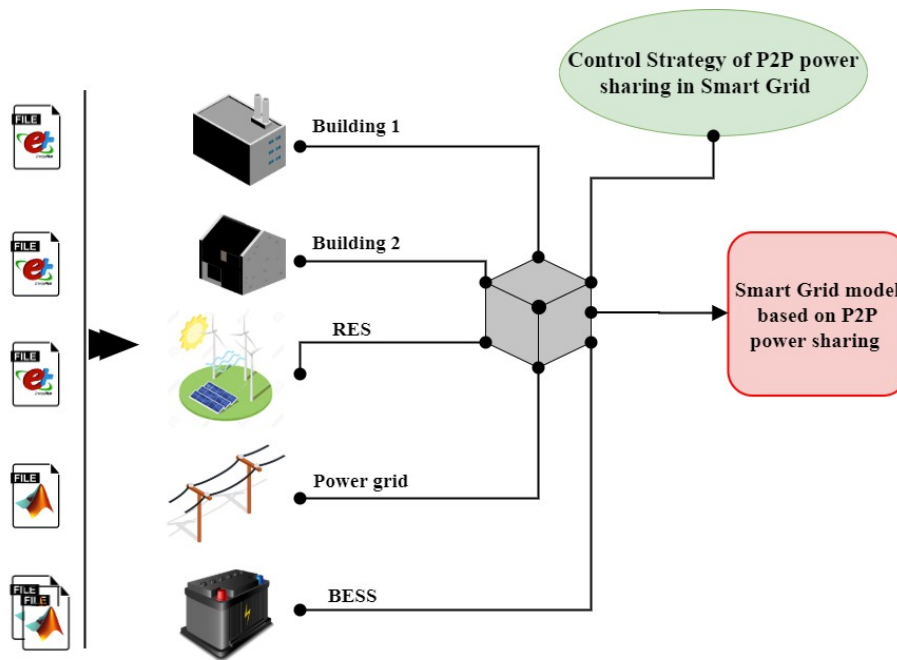

Figure 6.2: P2P energy sharing architecture and components

shows the proposed control system scheme for the smart grid of the fishery port at the Port of Milford Haven based on P2P energy sharing.

The flow chart below describes the steps used to regulate energy production and energy consumption in the fish processing industry. At any instant, the total power production of the smart grid ( $T_{\text{production}}$ ) and its total power consumption ( $T_{\text{Consumption}}$ ) are determined as per Equations (3) and (4), respectively. The associated algorithm for determining the P2P energy sharing is shown in Algorithm 2.

### 6.3 Results and discussion

This section will discuss the evaluation of the proposed smart grid model using four scenarios to understand the impact of the price-based and P2P energy sharing control strategies. These scenarios and their results are described in the following subsections.

**Algorithm 2: P2P energy sharing control algorithm**

Initialisation:

```

1: if  $\sum_{i=0}^n P = \sum_{i=0}^n C$ 
2: yes; feed all  $\sum_{i=0}^n P$  to  $\sum_{i=0}^n C$ 
3: no; go to stage 1
Stage 1
4:   if  $\sum_{i=0}^n P > \sum_{i=0}^n C$ 
5:     then check BESS_1
6:     if  $20 < SOC1 < 95$ 
7:       then charge BESS_1
8:     otherwise go to stage 2
Stage 2
9:   if  $SOC1 > 95$ 
10:    then check  $P_{c2}$ 
11:    if  $P_{c2} < SOC1$ 
12:      then feed all energy to  $P_{c2}$ 
13:    otherwise go to stage 3
Stage 3
14:  if  $SOC1 < 95$ 
15:    then check  $P_E^{price}$ 
16:    if  $P_{preference} < P_E^{price}$ 
17:      then sell  $P$  to the grid
18:    else check BESS_2
19:    otherwise go to stage 3
Stage 4
20:  if  $SOC2 > 98$ 
21:    then sell energy to grid
22:    else charge BESS_2
23:    otherwise go to stage 5
Stage 5
24:  if  $SOC2 > 20$ 
25:    then discharge BESS_2
26:    else buy energy from grid
27: end

```



### 6.3.1 Optimise energy use by applying the price-based control strategy

The objective of this scenario was to optimise energy use and associated costs by minimising the capacity of the BESS and increasing income from trading energy with the grid. The controller is connected to the local energy market to continuously retrieve the energy price, based on which a set of rules are triggered to distribute energy between the local site and the main grid. For this control strategy, we set a minimum selling price of 4.2 £p/kWh and maximum buying price of 2.6 £p/kWh to enable a sell/buy decision at the site. The main grid price was based on the average European electricity market price. In this scenario, the BESS included a main and backup battery with lower capacities of 6000 Ah and 4000 Ah, respectively.

Figure 6.3 presents the impact of the price-based control strategy for the overall energy distribution within the site. As it can see the first figure demonstrate the energy generation. The second chart simulate the actual power consumption and it can be seen that it fluctuated during the 24 hr. Grid exchange as shown in the third figure demonstrate the principle Price based control strategy. It feed the surplus power to the grid and buy from grid from 5:00 AM until 7:00 AM when the power price is in the conditioned ranged of buy from grid which is less than 2.6 £p/kWh. As can be observed from the results, if the grid energy price is too low, then the local system will use energy from the main grid to meet the energy demands of the fish processing site. However, if the grid energy price is too high and there is an energy surplus in the local site, then the system will sell surplus energy to the main grid. The results also reflect the fluctuation of energy price in the European energy market. Finally, it can be observed that the SOC of the main battery system discharges at night to meet the incoming energy demand of the fish processing equipment, whereas the SOC of the backup battery is stable at night because once the energy stored in the main battery is consumed, the energy demand is covered by energy from the main grid due its low energy price.

### 6.3. RESULTS AND DISCUSSION

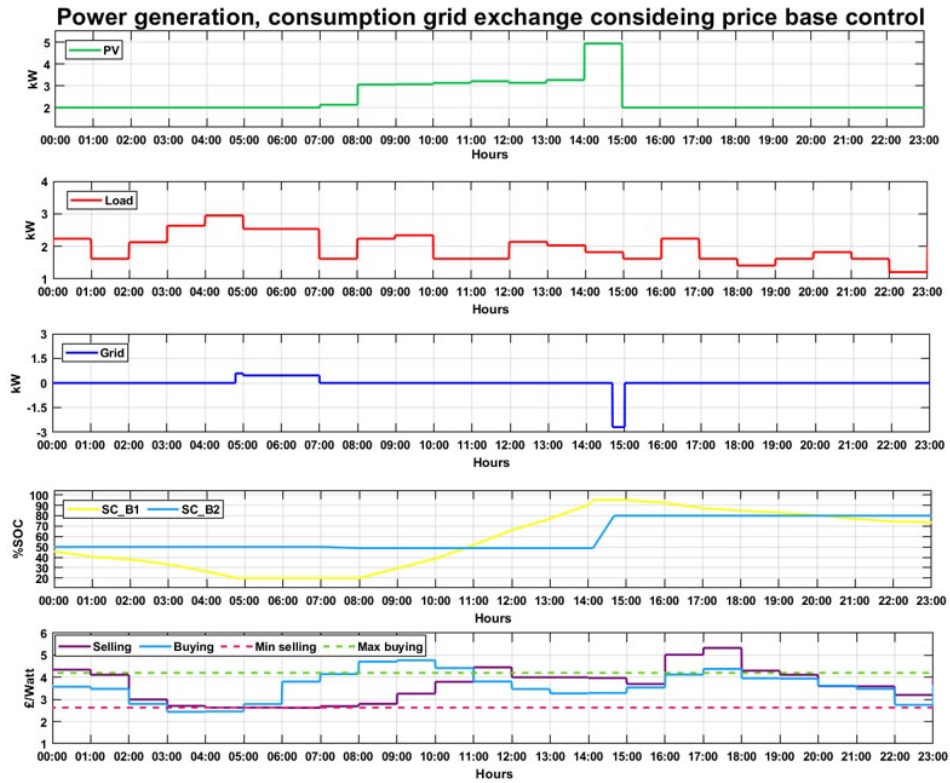

Figure 6.3: Optimising energy cost using the price-based control strategy

#### 6.3.2 Optimise energy use by integrating the energy storage capacity of electric boats

The objective of this scenario was to optimise energy use by utilising the local electric fishing boat fleet as an alternative energy storage system to minimise the main battery storage capacity on site. The use of alternative energy storage solutions, such as the electric boats, is expected to result in a decrease in the capital cost for energy storage equipment, and considerably reduces long-term operation and maintenance costs. The figure consists of five charts; the first chart presents the power consumption of the building in 24 hours and the second chart shows the activity of PV power generation. The proposed scenario investigates the capability of local electrical energy storage in boats to take part of overall system through meeting energy demand when the system needs energy instead of getting power from the grid. This will help to calculate the optimum number of energy storage systems. It can be seen that in the yellow line that the system doesn't take any power from the grid in 24-hour discharge power from battery boats between 12:00 AM and 4:00 AM. The algorithm for this scenario was configured to work with several of the electric boats that were identified

### 6.3. RESULTS AND DISCUSSION

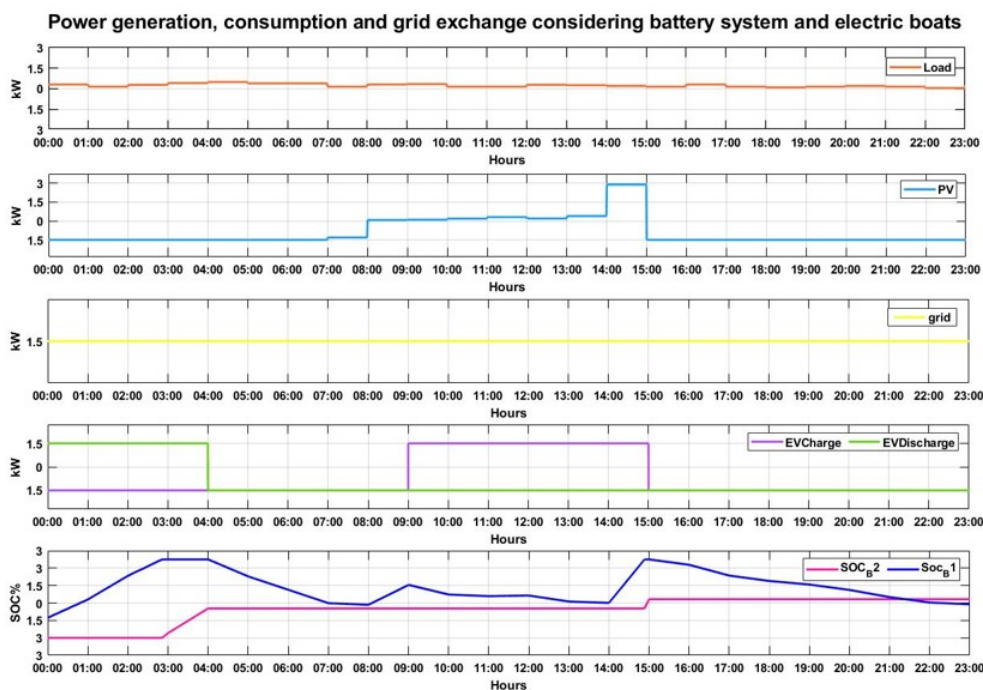

Figure 6.4: Optimising energy use when using electric boat battery storage

in the port and use their storage capacities to manage the peaks in energy demand or store surplus energy once the site batteries are charged to capacity. The algorithm also ensures that at any point in time, the batteries of the electric boats will not be discharged below a threshold of 50 percent, to ensure that the boats can always be used for fishing. In this scenario, the site energy storage capacity was set to approximately 5000 Ah for the main battery and about 3000 Ah for the backup battery. Figure 6.4 presents the interactions between the different consumption and production units at the fish processing site and the impact of using electric boats or alternative energy storage. The results show how the electric boat-based storage system discharges and interacts with the local battery system at night and charges during the day when PV energy production is available. The results also show that the SOC of the main battery interacts with the storage systems on the electric boats by charging at night and discharging during the day.

#### 6.3.3 Optimise energy use with P2P energy sharing control strategy

The objective of this scenario was to investigate the energy use when the site identifies high energy production from local generation sources by exploring the possi-

### 6.3. RESULTS AND DISCUSSION

bility to share or trade this energy surplus within the community of neighbouring buildings. This scenario was evaluated to identify new methods for reducing dependency on the national energy grid and encourage utilisation of clean energy resources while incentivising energy community members to become prosumers. This scenario includes the main battery and backup battery systems with capacities of 7000 Ah and 3000 Ah, respectively.

Figure 6.5 presents the energy impact when applying the P2P control strategy, showing trends related to the energy storage system to support a more optimal energy use at the site by charging and discharging the BESS within a 24-hour interval. As presented in the figure, when energy generation is high and the SOC of the BESS is greater than 95 percent, the control system will check the energy demand of the neighbourhood buildings, based on which the controller will then feed the surplus energy to the neighbouring buildings. The results also show a reduction in the quantity of energy consumed from the national grid.

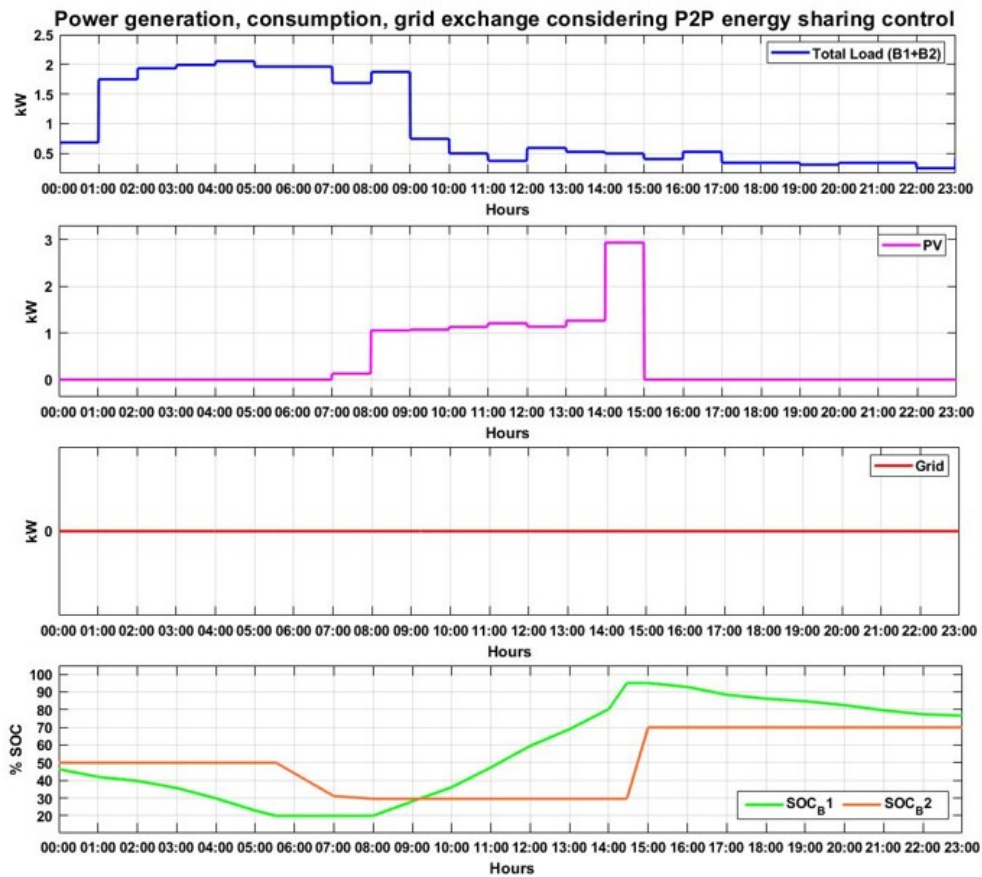

Figure 6.5: Optimising energy use based on a P2P energy sharing control strategy

### 6.4 Conclusions

This chapter answering the third research question which investigating the capability of energy sharing and trading approach to be simulated to promote decision making that reflects the efficiency in fishery buildings? This research question aims to develop smart decision making systems to minimise carbon emissions and provide a more informed energy management strategy in relation to the surplus energy and available energy storage systems generated from dispatchable energy sources. and the answer is formed by developing two control scenarios to demonstrate how micro-grid solutions can be implemented in the fishery port. The research question reflect the third stage of the methodology that developed for the thesis. The price-based control scenario was developed in relation to the price of electricity and a decision model was implemented to determine when to buy or sell energy to the grid [403].The peer-to-peer control strategy was developed to prioritise the energy demand of neighbouring buildings in the micro-grid over selling to the national grid [340]. The results of simulations using these control strategies demonstrated how peer-to-peer energy sharing enables prosumers to participate in smart energy communities by sharing their surplus energy with other participants and provides monetary benefits and efficient use of resources. The results indicated improvements in the overall operation between agents in the smart grid when adopting either the price-based control or peer-to-peer scenarios. In the price-based control scenario, the control algorithm reduced energy losses and maintained energy in the system using an energy storage system [404]. In the peer-to-peer scenario, the control algorithm showed that the surplus energy generated by prosumers can also be used to feed any neighbourhood energy demand before selling to the grid. These techniques can also help to incentive the deployment of local, renewable energy generation within the smart energy community. Furthermore, the results of this study demonstrated that applying the price-based control and peer-to-peer methods can have a significant impact on the amount of reducing carbon emissions associated with the consumption of energy produced using traditional fossil fuels which can contribute to decarbonize seaports [405]

# CHAPTER 7

## Conclusion and Future works

This thesis focused on the development of a road map for the creation of zero carbon fishery ports and included the application of this to one of the marine ports, and this chapter aims to present and deduce the most important outputs and discuss the obligation that was presented in chapter 3. This chapter will re-examine the main research questions of research and review the extent to which they are achieved, as well as discuss the research contributions in the field of knowledge, and will also present the most important challenges and obstacles that occurred during the research phase. The most important future trends in reducing carbon emissions in seaports will also be presented and its impact on the global level.

### 7.1 Research findings

During the PhD journey, it was found that there is a good opportunity to develop seaports and fishing industries through the development of their energy systems. This can be done by taking advantage of modelling and simulations to understand the nature of energy consumption. In addition, smart energy management through the establishment of smart grid approach can help us to understand, manage and optimise energy performance. This will be reflected in the energy performance and will reduce the cost of energy in the long-term. The concept of new smart energy systems in seaports will enhance the transformation of fisheries at ports and fishing industries into active members by raising the awareness of the importance of energy systems and raising efficiency, as well as adopting energy automation and utilizing available energy resources.

The direct impact of upgrading and implementing smart energy systems at fishing ports will be reflected in the following areas: enhances the concept of quality

and liability in workplace and competitiveness among port managers by increasing the number of fisheries and fishing boats that serve the green port, and will contribute to raising the efficiency of operation and achieving optimal incomes for the port authorities. In addition, this development of port energy systems will drive a clear vision among decision makers by supporting, encouraging and promoting the conversion of seaports and fishing ports to become more efficient and less expensive ports. It will also contribute to the development of policies that limit the use of fossil fuels in seaports and their contents. In addition, seaports will attract investment by energy companies and investors through participation in investment deals and tenders to update energy systems, by applying a new generation of energy technology, and will therefore achieve long-term profits. Furthermore, seaports will be a new direction for researchers and developers because so far there has been very little research in this area. This will help to bring smart, innovative minds and researchers to build a new innovative vision for seaports and fishing industries by adopting a new digital technology for port systems and operations.

This section aims to answer the main research questions which was outlined in chapter one. each research question will be restated and discussed in specific sections. and it will followed by final discussion on the research hypothesis.

### 7.1.1 Developing simulation capability at fishery port

The first research question was:

Can a reliable simulation capability be developed that provides real-time accounts of energy demand and use for fishery buildings?

This thesis established that a calibrated simulation model taking into account port complexity using a combination of software environments (e.g., DesignBuilder, EnergyPlus, building control virtual test bed and MATLAB/SIMULINK) may help to pave the way to the development of a zero-carbon port using new smart energy technologies (e.g., smart grids, virtual power plant and distribution generation). This question constitutes the first phase of the methodology that is used in this thesis and it focuses on verifying the extent to which a simulation capability model of energy systems in seaports can be developed over varying periods of time, between short-term and long-term. This question was answered through a series of

steps that began with a review of the port's energy systems using an energy auditing methodology [406] which will be used to determine and understand the nature of energy consumption and what complex, most energy-consuming systems are used by the operators of fishing systems, which make up a large proportion of the total consumption in the port (e.g., the flake ice, cold storage units, loading equipment, storage in the port, etc.). The energy review process aims to collect data that are necessary and important for the development of the energy system simulation model. Simulation models of energy systems for a number of buildings were developed using DesignBuilder and EnergyPlus programmes at the target port of study, the port of The City of Milford Haven in Wales [407]. One of the exceptional results in the Energy modeling and simulation phase is the ability to understand the nature of energy consumption in fishery buildings, which greatly helps to formulate a strategy to improve consumption, and use available and clean energy at a lower cost. What distinguishes the results of modeling and simulation of some of the fishery buildings is that the accuracy of the results was verified by comparing them with real energy consumption, in which the convergence rate was higher than 90 percent. In addition, through the simulation stage, the capability of a solar farm owned by the port authority, which sells the entire energy produced to the national grid without benefiting from it locally, was investigated to meet the energy requirements of the fishery buildings within a year through interconnecting the five buildings with a solar farm in a co-simulation platform [408]. The simulation models that are developed contributed to determining the times consumed during the year and what devices most consumed the energy. The developed simulation models of the buildings at the port will help to determine the opportunity to reduce consumption, as well as the possibility of meeting existing consumption in buildings through renewable energy systems and also smart electrical grids.

### 7.1.2 Deploy and implement micro-grid at fishery port

The second research question was:

Can the concept of smart grid be adopted and applied to energy systems in fishery buildings at multi-levels?

The answer to this question is largely linked to the answer to the first question



because it aims to study and measure the extent to which marine ports can be converted into smarter ports by spreading and promoting the concept of smart grids. The second phase of the methodology in this thesis aimed to develop a microgrid in seaports, and measuring the potential to meet the need for electricity locally without the need to buy electricity from the public grid [107]. A micro-grid model was developed on a building level, and the simulation model for energy systems was used in the Packaway building, which was developed in the first phase of the research for this purpose. The network consists of a range of systems (e.g., solar system, storage system, smart control power management and real-time distribution system) within 24 hours and it simulates what is going on in real life. The results of this model were promising because the micro-grid was developed using the program MATLAB/SIMULINK, where all of the systems were connected together in one platform and controlled through proposed smart power management system. A series of experiments were conducted during the four seasons to ensure the effectiveness of the microgrid in dealing with different loads within 24 hours simultaneously. This aims to achieve self-sufficiency without the need to take power from national grid[283]. The extent to which the micro-grid is expanded and enlarged to include all buildings at the fishery port level has also been studied, as well as the extent to which the micro-grid is expanded to include a total of 200 houses from the community adjacent to the port to form a smart energy community. All of the loads have been attached to the pre-developed platform in the micro-grid, together with a solar farm from the port property, and two power management systems have been developed: the first at the port level and the second at the community level.

The proposed model was developed based on a trade-off criterion related to the cost of implementation and efficiency with a view to: (a) reduce to a minimum investment in the implementation of the proposed model, and (b) demonstrate clear benefits in terms of costs and energy savings [409].

### 7.1.3 Promote real-time decision making toward decarbonizing seaports

The third research question was:

Can the energy sharing and trading approach be simulated to promote decision making that reflects the efficiency in fishery buildings? This research question aims to develop smart decision-making systems to minimise carbon emissions and provide a more informed energy management strategy in relation to the surplus energy and available energy storage systems generated from dispatchable energy sources. The answer is formed by developing two control scenarios to demonstrate how micro-grid solutions can be implemented in the fishery port. This research question reflects the third stage of the methodology that was developed for this thesis. The price-based control scenario was developed in relation to the price of electricity and a decision model was implemented to determine when to buy or sell energy to the grid [403]. The peer-to-peer control strategy was developed to prioritise the energy demand of neighbouring buildings in the micro-grid over selling to the national grid [340]. The results of simulations using these control strategies demonstrated how peer-to-peer energy sharing enables prosumers to participate in smart energy communities by sharing their surplus energy with other participants, and provides monetary benefits and efficient use of resources. The results indicated improvements in the overall operation between agents in the smart grid when adopting either the price-based control or peer-to-peer scenarios. In the price-based control scenario, the control algorithm reduced energy losses and maintained energy in the system using an energy storage system [404]. In the peer-to-peer scenario, the control algorithm showed that the surplus energy generated by prosumers can also be used to feed any neighbourhood energy demand before selling to the grid. These techniques can also help to incentivise the deployment of local, renewable energy generation within the smart energy community. Furthermore, the results of this study demonstrated that applying the price-based control and peer-to-peer methods can have a significant impact on the amount of carbon emissions reduction associated with the consumption of energy produced using traditional fossil fuels, which can contribute to decarbonise seaports [405].

### 7.1.4 Revisiting the Hypothesis

Based on the the above answered to research questions, the following Hypothesis can now be confirmed;

“The concept of Industry 4.0 has the potential to deliver net zero carbon fishery ports by leveraging smart and clean energy generation, use, and storage, while promoting the formation of energy communities within the local ecosystem [410].”

## 7.2 Contribution to the Body of Knowledge

The main contribution of this study is its focus on minimising the cost and emissions of energy use in the fishery buildings through developing a smart grid model and proposing real decision-making scenarios to reduce the cost and increase efficiency. The following contributions that have been obtained from this study are as follows:

1. Propose a reliable simulation capability that provides real-time accounts of energy demand and use, as well as short to medium-term energy projections to understand the complex ecosystem around seaports, including energy systems in use, fish processing activities, local stakeholders, including communities by utilising tools such as DesignBuilder [76], EnergyPlus [77] and Building Control Virtual Test Bed (BCVTB)[78].
2. Develop a simulation model of integration of local solar farm energy in a local energy cluster using a multi-building energy coordination model developed in EnergyPlus and simulate in BCVTB.
3. Develop a smart grid model to explore various scenarios for decarbonising seaports by leveraging renewable energy sources, including solar energy and energy storage, through a smart monitoring control strategy.
4. Develop a smart energy community model around seaports by integrating the smart grid with local community energy storage via developing a simulation-based optimisation strategy.
5. Promote real-time decision-making strategies that lead seaports and communities around seaports towards decarbonisation through energy sharing and trading.

### 7.3 Limitations and challenges

During the PhD research journey, there were a range of challenges that existed and were scientifically addressed in order to achieve the desired results and objectives of the research. And it will be displayed in the following points:

1. During the first phase of data collection in the Milford Haven Port, there was a unwillingness to support the researcher and provide the required data to make the simulation models, which led to the delay in the development of energy simulation models in port facilities, and also the lack of some important data such as drawings for buildings and others, which called for research and frequent visit to the port and take field measurements of some buildings as well as know some manufacturers of electric appliances in the port and communicate with them to get the information to develop the simulation model and get More accurate and real-life results.
2. Also, the lack of sensors and actuators to monitor and collect energy consumption in the buildings increased the complexity of the task to deliver accurate energy consumption models in the buildings.
3. It is crucial to provide a high specification computer with minimum 64 ram to develop simulation models, which was one of the main challenge during this research study. For example, at the time when design and implement micro-grid in SIMULINK platform; it spent one night to run the model for 24 hours and get result which took about three months to develop microgrid model with an accurate result. The result of the simulation was produced from a computer using Windows 7, Intel (R) Core (TM) i7-6700K CPU @ 4 GHz, with 16 GB RAM.

### 7.4 Future work

For future work, I argue that decarbonizing seaports can have a profound transformation on port activities, as elaborated in the next sub-sections.

### 7.4.1 Total life-cycle approach to seaports decarbonisation

Most of the studies focus on developing strategies that contribute to reducing carbon emissions in seaports by optimizing the energy mix [364] and improving the energy efficiency of the equipment and machinery used in ports [365], as well as mitigating the environmental impact of ships by reducing their speed and scheduling their arrival and departure from seaports [104]. These actions have the potential to contribute significantly to reducing seaports carbon footprint. In this context, Lifecycle Assessment (LCA) helps to quantify the environmental pressures, the trade-offs, and areas for achieving improvements considering the full lifecycle of seaports from design to recycling. However, current approaches to LCA do not factor in consistently (both in the foreground and background inventory systems) lifecycle variations in (a) seaports buildings usage, (b) energy supply (including from renewable sources), and (c) building and environmental regulations, as well as other, changes over the building/seaport, and local neighborhood lifetime. These include: (a) change in the energy mix of a seaports or upgrading / retrofitting the energy system(s) in place; and (b) time-increase of energy demand during the lifetime of a seaport due to a wide range of reasons, including changes in activity patterns. In fact, seaports present the highest complexity within LCA which preclude the use of linear and static approaches but instead require the use of salable approaches that factor in dynamic and non-linear considerations. Seaport processes involve longer time scales than in other industries, and therefore face very different operational and environmental conditions. Therefore, the consideration of the time dimension in port activities modelling is becoming essential to understand the resulting pollutant emissions and resource consumption. This time dimension is currently missing in Life Cycle Inventory databases. A further combination of Life Cycle Impact Assessment (LCIA) models using time-dependent characterization factors can, therefore, lead to more comprehensive and reliable LCA results. This is therefore a need to develop real-time LCA approaches for seaport which address temporal and spatial variations in the local seaport ecosystem, and thus promotes more effectively a 'cradle-to-grave' environmental sustainability capability".

### 7.4.2 Semantic-based modelling, forecasting and optimization of seaports energy systems

In the complex seaport digital energy landscape, energy software services which address various stakeholders' (including prosumers) needs are required. These include forecasting and simulation services, as well as responsive day-ahead and intra-day management services necessary to effectively integrate distributed energy resources, including renewables, in seaports. This includes the ability to predict behaviours and adapt to changing weather and technological environments. We argue that as local renewables density increases, this importance extends beyond the unit level to intelligence at the system level, where the impact of uncertainty at each node can be mitigated through the emergent behaviour of adjacent distributed energy resources. As such, an optimal management of energy systems should be considered by systematically considering the decision space of management topologies, schemes, and operating parameters, best conveyed by semantic models, such as ontologies. Energy system optimization is far from novel, but most approaches consider the system as a static entity, and only consider a single system rather than the holistic perspective of emerging system of systems landscape. We therefore advocate the previously described system of systems approach of energy management, best conveyed through semantic models that provide a holistic conceptualisation of energy systems and their socio-technical constituents. This is essential to address a wide range of scenarios, such as local energy balancing, islanding, and blackout prevention, adapted to a changing environment of high distributed energy resources penetration. A semantic framework has, therefore, the potential to meet the requirements of flexibility, scalability, resilience, openness, and practicality. Furthermore, it is important to combine the advantages of distributed control (such as scalability, privacy and adaptability) and centralized control (such as feasibility, optimality and responsibility) whilst mitigating their specific drawbacks. The benefits of a semantic and AI-based architecture are particularly evident when the grid needs to be restored and healed after a disruption in service. The grid should be able of restoring, re-organizing and healing itself via alternative topologies without affecting the system as a whole, informed by the holistic understanding of the wider energy systems. There is a need for a new body of

research with a view of ensuring the optimality and resilience of energy management systems through self-healing capabilities that i) promote autonomy, belonging, connectivity, diversity and emergence, ii) balance the importance of global and local objectives, iii) dynamically reconfigure to optimize the overall energy system's performance across energy carriers and scales, and iv) enable demand responsive energy management with bidirectional flow of energy, information and dynamic pricing schemes. Optimisation based grid planning and longer-term operational control are common approaches in power system management. But increasing stochastics on supply and demand side and the coupling of different sectors and markets increases the complexity of power grid operation and requires multi-objective, time-series based optimisation under increasing uncertainty. At the same time, increasing data availability and computational power give opportunity for optimisation based short-term and close to real time operation.

### 7.4.3 Secure and reliable seaports energy services

Seaports are responsible of shipping circa 90 percent of global supply chain of goods. They are, as such, critical infrastructures and are potentially subject to a wide range of threats [368]. There is an urgent need to increase awareness on cyber threats faced by ports worldwide [369] to ensure secure shipping and operations [370]. This is now exacerbated by the digitisation of seaport infrastructures, including energy systems, as well as the involvement of a complex value chain. Potential risks to energy systems include: blackout or service interruption, malicious command injection, delayed measurements, Denial-of-Service attack, dynamic pricing information altered, and user accounts alteration. The consequences of such cyber security threats can be dramatic. Conversely, the reliability and Quality of supply (QoS) of energy related services in seaports are becoming pressing issues as a result of the increasing need for smart integration of distributed energy resources. In fact, a gradual transition is occurring to demand responsive energy management enabled by smart metering infrastructures with a bidirectional flow of energy, and dynamic pricing schemes. There is a requirement for secure authentication of users, agents, and transactions at each interface between energy devices. The number of processes is also exacerbated by the increasingly distributed

nature of grids, and their underpinning communication requirements. Three interesting avenues for further research include (a) research to identify and quantify the risk of a breach of privacy and security to the systemic reliability and Quality of service (QoS) caused by insecure authentication occurring in a heterogeneous environment, where legacy standards and applications need to remain in operation alongside advanced standards; (b) research to identify and quantify loss of data, breach of privacy and vulnerability due to the heterogeneous communication infrastructure (wireless, wired, PLC), and the impact on grid reliability and QoS; and (c) research to develop guidelines for information security management and inform related legislation and standardization in the energy domain in seaports.

### 7.4.4 Transition towards Prosumer-driven seaport energy communities

Seaports involve an important ecosystem, including their local communities. We are gradually experiencing the emergence of sharing economies with the change in consumption models. These can motivate energy prosumers (local communities around seaports) to participate in a leasing energy market where services are used for a shorter period and more accessible via community sharing. Blockchain can incentivise the participation in such a sharing economy providing greater choice for both energy consumers and providers while enabling a much greater flexibility in being able to switch between multiple market offerings. Such sharing economy has the potential to decentralise energy production but can also balance consumption from consumers by not being restricted to energy services or price constraints from a single energy provider. As the energy market today is transforming towards a large number of suppliers and buyers, it is important to enable participants in a seaport ecosystem to exchange an increased amount of traded energy. The interaction between these actors and the associated processes require a high degree of standardisation which can be facilitated by a Blockchain model. The utilisation of Blockchain for energy trading can lead to the eradication of brokers, monetisation of energy excess and development of energy communities. Such brokers and intermediary parties, usually are required for validating or for ensuring trustworthiness of information across parties, can be replaced by a more automated Blockchain



process. As Blockchain delivers a high level of security and data protection for different applications supported by transparent ledger that records all transactions, third-party verification can be eliminated. In a Blockchain system, any user can become a trader and offer an energy product or service to a group of consumers. Blockchain technology has, therefore, the potential to leverage the benefits of decentralised energy systems and enable an environment where everyone can trade, pay, and even deliver energy to others. Blockchain can support the creation of economically attractive energy communities utilising the power of the Internet and implement the vision of a perfect energy market. Blockchain identifies an online distributed database that aggregates a collection of blocks connected to each other. It is a public and decentralised ledger that stores a set of records, structured as a chain and blocks. From the multiple Blockchain solutions, smart contracts are instruments that can extend the Blockchain capabilities and have been used in a variety of industries. Smart contracts have often been used to convert business rules into codes based on which a contract code/script is stored in a Blockchain. Future research will involve exploring the adoption of energy sharing and trading practices within and around seaports, using blockchain technology.

### 7.4.5 Propose roadmap for delivering a zero carbon fishery port with an energy community

The EU played an important role in the development of energy systems policies for EU countries, which directly reflects on a number of developed and developing countries, and even adopted a number of international policies at the United Nations towards the modernisation of energy systems, which are directly aimed at reducing dependence on fossil fuels and reducing carbon emissions. Through its three main objectives, which it aims to achieve by the year 2050, the EU aims to preserve the environment, create a fair and affordable energy market and finally ensure the viability, reliability and security of energy supply for all. The industrial sector is responsible of high percentage of carbon emissions from burning fuels. Despite the stimulus measures that have been put in place to reduce emissions from factories, there is still a long way to go to achieve a total reduction of carbon from the industrial sector. Some EU countries have begun extensive and qualita-

tive processes to convert energy systems to a cleaner, smarter and higher quality state. Seaports are vital centers that are highly focused on the development of transition energy systems that are in line with the EU's vision targets for energy systems. However, a number of studies in the field of energy systems in seaports have focused on more than one factor, including the calculating and measuring the amount of emissions from the port and commercial vessels through different proposed methodologies, while a number of studies have focused on studying the feasibility of converting energy systems in ports to be more environmentally friendly. A review of the previous studies has previously been presented and discussed in Chapter Two.

Through the PhD journey with the piSCES project, a road map to convert fishing ports into carbon-free ports has been developed and implemented using a number of techniques and methodologies. Figure 7.1 demonstrates the main stages of the proposed roadmap. This research began by understanding the nature of consumption in the port. It then built and developed a model to simulate the energy systems. A micro-grid was then developed and implemented. This network was expanded to include the local community. Finally, a smart decision-making system that contributes to reducing energy dependence from the national grid and takes advantage of the electricity produced locally from solar energy is developed. The next section will discuss this roadmap in more detail.

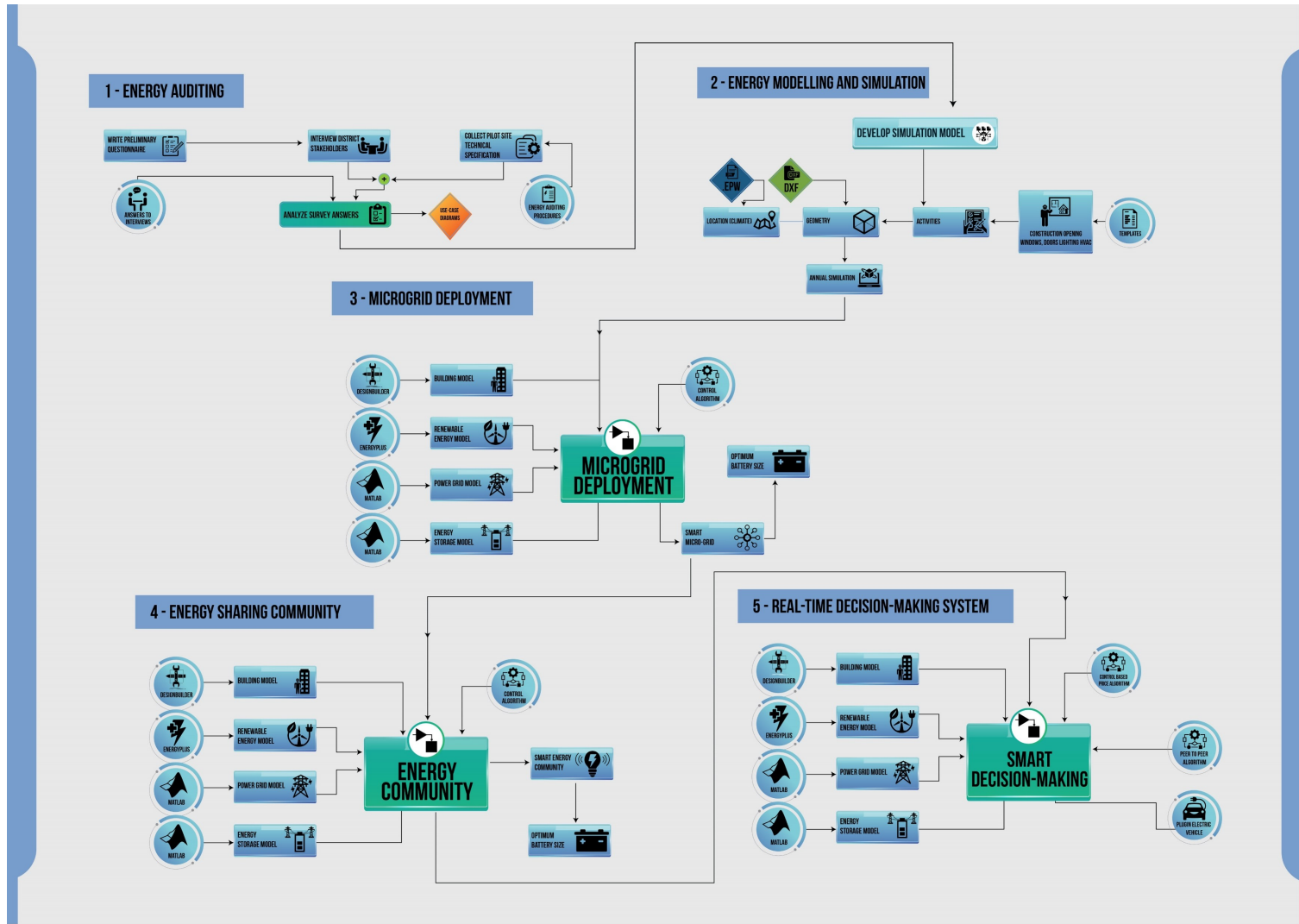

Figure 7.1: Roadmap for Delivering a Zero Carbon Fishery Port with Energy Community

### 7.4.5.1 Conducting an audit of the fishery port's energy systems

The first action to start the process of transitioning to a zero carbon fishery port is to visit the port and understand the nature of its operations. In addition, it is crucial to meet the energy manager and the staff who are working permanently at this location. This step is known as a site visit in the procedure of energy auditing methodology. This action will help to gather information about energy systems and understand the behaviour of energy consumption in these systems. Next, it is important to get access to the energy utility bills and analyze them in a 24 months period to understand the behaviour of energy consumption in different seasons. In addition, it will help to investigate the hot seasons that have high levels of energy consumption. Therefore, it is vital to get data for 2 to 3 years of energy consumption, which will help to build an accurate analysis for the ports premises.

The port authority should provide requirement data sheets for energy appliances and the operation times on a daily basis, which will help to analyse the energy use and compare it with utility bills to determine the high energy consumption appliances and the hot periods. The final stage in the energy auditing process is to analyse and recommend opportunities to save energy by replacing inefficient appliances, which will help to reduce energy consumption in the building.

It is crucial during an energy audit to investigate the awareness of carbon emission at the seaports and understand its impact in the total lifecycle. This will also help to identify the level of preparation to accept updates in the overall energy system at this seaport. In addition, will help to introduce key workers and port's members to the importance of the transition of energy systems.

### 7.4.5.2 Development of a simulation model for energy systems at a fishery port

The role of modeling and simulation of energy system is not only to understand the behaviour of energy in period of time but also to save the time and money that could be spent in real-life investigation of energy usage. The new energy simulation tools help us to identify the areas of high energy consumption at a specific time. In addition, it will help you to model the exact geometry of real life buildings, including their components. It will also build a similar environment for the target building.

Energy simulation tools offer a smart platform that will help to propose differ-

ent scenarios of energy saving without effect the overall system. It can also help to investigate different scenarios by changing the input variables to see the impact on the overall system. This will help to determine opportunities of promising areas to save energy and reduce cost and carbon emission. However, a simulation is a virtual environment and it cannot change energy consumption in real life. It can only help to understand the nature of energy consumption in the buildings and find the main parameters that effect the overall energy system. In addition, energy simulation will help to investigate the capability of local energy demand to be meet proposed local energy supply, such as solar, wind or tidal.

For this study, a simulation of energy systems at a fishery port was the core element to develop a smart energy system at a fishery port. The port consists of a group of buildings with different functions, some of which are used for commercial purposes and some have been leased to companies operating in the fish industry. Buildings leased by fish factories are considered to be among the most energy-consuming buildings, and the goal was to analyze and understand the amount of consumption per building. However, one of the challenges that was faced during data collection is the lack of sufficient data to build the simulation model, such as drawings of the building, as well as the nature of energy consumption during different time periods. The data needed have been collected to build a simulation model of the buildings used by the fish factories. The results were then analysed and compared with monthly utility bills. Some of the buildings that provided us with the data to compare with the simulation results have been verified and the ratio was very high in an approach to actual consumption on the ground. This will contribute significantly to the design of future scenarios to raise energy efficiency, as well as to study the possibility of meeting the need for energy locally through renewable energy systems.

### 7.4.5.3 Design and implementation of a micro-grid for a fishery port

After I had developed simulation model using DesignBuilder and EnergyPlus programs, the third stage investigated the deployment of a micro-grid at a fishery port. This will help to determine the capability of a micro-grid to meet local energy demand. The most robust simulation platform to develop a micro-grid is

MATLAB/SIMULINK. There are many requirements to develop a micro-grid model platform, including an energy generation system, energy demand system, energy storage, energy management control and grid system. Each system has to be built separately and then tested as standalone system.

After developing a model for each component, the next step is to integrate all items in one platform as a virtual micro-grid. Graphs are then added to see the operation of energy usage. This will help to determine how much power the system receives from the grid and how much power is generated in a 24 hour period. It will also help to identify the capacity of defined energy storage systems. The proposed control energy strategy will help to enhance the flow of energy, which gives a clear understanding of energy management in a 24 hour period. The grid model was considered as a finite grid model to maximise the power flow in the system and avoid blackout during operations. A finite grid is able to meet unlimited power demand and accept unlimited surplus power from the system,

Once the proposed micro-grid model has been developed, it is important to test the micro-grid under different scenarios for the system to identify the optimum amount of energy storage to build a standalone system. In addition, the system must be tested under different variables and conditions, such as seasons, maximum load and minimum power production. This will help to build a robust model that can be expanded under different conditions.

It is important to run the micro-grid model in a robust computer with a maximum amount of ram memory and smart specification to increase the model's reliability. This will lead to a model that is largely identical to the one that will be built on the ground.

### 7.4.5.4 Expanding the community's energy sharing around fishery port

The micro-grid in the port has been expanded to include the group of five buildings that work in the fish industry and also a number of residential buildings surrounding the seaport. This move enhances the potential of the micro-grid to meet the energy needs of the port and the surrounding homes by taking advantage of the port-owned solar farm, with an estimated capacity of about 5 MWp.

The expansion model was built on the prototype that had previously been built

for the port's micro-grid on the basis of only one expandable building. Electric-boats have also been introduced into the grid circle, and utilised as an energy storage system when needed and as a source of consumption when used.

More than one control model has been developed for the extended network to determine the extent to which the network can handle the demand and save locally generated electricity from solar energy, as well as to determine the required capacity of storage units, both for the port buildings and for the residential buildings surrounding the port.

The results of the expansion of the network have greatly enhanced the effective role that the smart grid approach will play in seaports and coastal cities, and even contribute significantly to enhancing the role of locally generated solar energy to meet the need for electric power. This will be directly felt by the local community and the marine activities at the port.

Here, the community surrounding the port can be called net-zero carbon, which is an ideal model that many countries seek to reach by reducing dependence on fossil fuels. The developed model is one of the first to use solar energy in fishing ports and to have developed a smart energy community around a fishery port.

### 7.4.6 Develop a smart decision making system to deliver a zero carbon fishery port

After completing the study and analysis of the micro-grid system, and knowing the extent of the ability of the network to achieve local energy sufficiency at the port level, the control systems within the network are developed and optimised. This will contribute significantly to raising the efficiency of the systems and make the most efficient utilisation of locally produced solar energy. This study developed a smart decision-making system that is based on control-based pricing and P2P control strategies. Both smart decision systems achieve a nearly zero carbon fishery port. Control-based pricing is based on the total energy production of the PV panels, the battery capacity, and/or the electric boats to consider the price of electricity to decide between buying or selling energy. This will contribute to the direct interaction with energy prices in the energy market, which benefits the port directly by taking advantage of the cost of selling electricity at a high price or indirectly by

supplying to clean, locally produced solar energy to the local community.

The P2P decision support system aims to share the surplus power that has been produced from Agent A to Agent B to meet local power demand from clean energy. P2P energy sharing could be implemented based on price or based on sharing, which will gain more benefits to the local consumers. It will also help consumers to become prosumers and trade surplus energy inside the community.

Smart decision making systems within the micro-grid aims to increase dependence on locally produced clean energy through an energy department that allows for the benefit of both the producer and the consumer. This will directly affect the energy markets and society by increasing the production of clean energy, activating the role of the customer, as well as facilitating the customer's access to the energy markets.



# Bibliography

- [1] Susan Solomon, Dahe Qin, Martin Manning, Kristen Averyt, Melinda Marquis, and Melinda MB Tignor. Climate change 2007-the physical science basis: Working group I contribution to the fourth assessment report of the IPCC, volume 4. Cambridge university press, 2007. ISBN 0521705967.
- [2] John FB Mitchell, TC Johns, Jonathan M Gregory, and SFB Tett. Climate response to increasing levels of greenhouse gases and sulphate aerosols. *Nature*, 376(6540):501, 1995. ISSN 1476-4687.
- [3] NASA. What are climate and climate change?, 2011. URL <https://www.nasa.gov/audience/forstudents/5-8/features/nasa-knows/what-is-climate-change-58.html>.
- [4] John P Holdren, Kirk R Smith, Tord Kjellstrom, David Streets, Xiaodong Wang, and S Fischer. *Energy, the environment and health*. New York: United Nations Development Programme, 2000.
- [5] EA Abdelaziz, R Saidur, and S Mekhilef. A review on energy saving strategies in industrial sector. *Renewable and sustainable energy reviews*, 15(1):150–168, 2011. ISSN 1364-0321.
- [6] International Renewable Energy Agency. *Future of wind deployment, investment, technology, grid integration and socio-economic aspects*. Report, 2019. URL [www.irena.org](http://www.irena.org).
- [7] Mike Hulme and Martin Mahony. Climate change: What do we know about the ipcc? *Progress in Physical Geography*, 34(5):705–718, 2010.
- [8] UNFCCC. *Background on the unfccc: The international response to climate change*, 2017. URL <http://www.un.org/en/sections/issues-depth/climate-change/>.

- [9] Joseph Dutton. Eu energy policy and the third package. Energy Policy Group/UKERC working paper, 2015.
- [10] Eleonora Annunziata, Marco Frey, and Francesco Rizzi. Towards nearly zero-energy buildings: The state-of-art of national regulations in europe. *Energy*, 57:125–133, 2013.
- [11] Diego Moya, Roberto Torres, and Sascha Stegen. Analysis of the ecuadorian energy audit practices: a review of energy efficiency promotion. *Renewable and Sustainable Energy Reviews*, 62:289–296, 2016.
- [12] Leen C Kuiper, Richard Sikkema, and Johan AN Stolp. Establishment needs for short rotation forestry in the eu to meet the goals of the commission’s white paper on renewable energy (november 1997). *Biomass and Bioenergy*, 15(6):451–456, 1998. ISSN 0961-9534.
- [13] Andrew Jordan, Dave Huitema, Harro Van Asselt, Tim Rayner, and Frans Berkhout. *Climate change policy in the European Union: confronting the dilemmas of mitigation and adaptation?* Cambridge University Press, 2010.
- [14] European Environmnet Agency. Total greenhouse gas emission trends and projections, 2018. URL <https://www.eea.europa.eu/data-and-maps/indicators/greenhouse-gas-emission-trends-6/assessment-2>.
- [15] Europese Commissie. *A roadmap for moving to a competitive low carbon economy in 2050*. Europese Commissie, Brussel, 2011.
- [16] Catherine Mitchell. The england and wales non-fossil fuel obligation: history and lessons. *Annual review of energy and the environment*, 25(1):285–312, 2000. ISSN 1056-3466.
- [17] David M Newberry. *Privatization, restructuring, and regulation of network utilities*, volume 2. MIT press, 2002. ISBN 0262640481.
- [18] EU Commission et al. Directive 2003/87/ec of the european parliament and of the council of 13 october 2003 establishing a scheme for greenhouse gas emission allowance trading within the community and amending council directive 96/61/ec. *Official Journal of the European Union*, 46:32–46, 2003.

- [19] Heidi Heinrichs, Patrick Jochem, and Wolf Fichtner. Including road transport in the eu ets (european emissions trading system): A model-based analysis of the german electricity and transport sector. *Energy*, 69:708–720, 2014.
- [20] Andrew J Weaver, Kirsten Zickfeld, Alvaro Montenegro, and Michael Eby. Long term climate implications of 2050 emission reduction targets. *Geophysical Research Letters*, 34(19), 2007. ISSN 1944-8007.
- [21] Jan Haase, Fares AlJuheshi, Hiroaki Nishi, Joern Ploennigs, Kim Fung Tsang, Nasser Aljuhaishi, and Mahmoud Alahmad. Analysis of batteries in the built environment an overview on types and applications. In *IECON 2017-43rd Annual Conference of the IEEE Industrial Electronics Society*, pages 8113–8118. IEEE. ISBN 1538611279.
- [22] Judith Lipp. Lessons for effective renewable electricity policy from denmark, germany and the united kingdom. *Energy policy*, 35(11):5481–5495, 2007. ISSN 0301-4215.
- [23] EU Directive. Directive 2001/77/ec of the european parliament and of the council of 27 september 2001 on the promotion of electricity produced from renewable energy sources in the internal electricity market. *Official Journal of the European Communities L*, 283, 2001.
- [24] Europäische Union. Directive 2009/28/ec of the european parliament and of the council of 23 april 2009 on the promotion of the use of energy from renewable sources and amending and subsequently repealing directives 2001/77/ec and 2003/30/ec. *Official Journal of the European Union*, 5:2009, 2009.
- [25] José M Cansino, Rocío Román, and Manuel Ordonez. Main drivers of changes in co2 emissions in the spanish economy: A structural decomposition analysis. *Energy Policy*, 89:150–159, 2016. ISSN 0301-4215.
- [26] Jan Rosenow and Nick Eyre. The green deal and the energy company obligation—will it work. In *9th BIEE Academic Conference*, Oxford.

- [27] Eduardo F Camacho, Tariq Samad, Mario Garcia-Sanz, and Ian Hiskens. Control for renewable energy and smart grids. *The Impact of Control Technology*, Control Systems Society, pages 69–88, 2011.
- [28] Bob Dudley. *Bp statistical review of world energy 2016*. London, UK, 2015.
- [29] Bob Dudley. *Bp statistical review of world energy*. *BP Statistical Review*, London, UK, accessed Aug, 6:2018, 2018.
- [30] IRENA. *Renewable Capacity Statistics 2018*. International Renewable Energy Agency (IRENA), Abu Dhabi, 2018. ISBN 978-92-9260-057-0.
- [31] Ehsanul Kabir, Pawan Kumar, Sandeep Kumar, Adedeji A Adelodun, and Ki-Hyun Kim. Solar energy: Potential and future prospects. *Renewable and Sustainable Energy Reviews*, 82:894–900, 2018. ISSN 1364-0321.
- [32] Angel A Bayod-Rújula. Future development of the electricity systems with distributed generation. *Energy*, 34(3):377–383, 2009. ISSN 0360-5442.
- [33] Guido Pepermans, Johan Driesen, Dries Haeseldonckx, Ronnie Belmans, and William D’haeseleer. Distributed generation: definition, benefits and issues. *Energy policy*, 33(6):787–798, 2005. ISSN 0301-4215.
- [34] Kari Alanne and Arto Saari. Distributed energy generation and sustainable development. *Renewable and sustainable energy reviews*, 10(6):539–558, 2006. ISSN 1364-0321.
- [35] Cornelia R Karger and Wilfried Hennings. Sustainability evaluation of decentralized electricity generation. *Renewable and Sustainable Energy Reviews*, 13(3):583–593, 2009. ISSN 1364-0321.
- [36] Priyanka Paliwal, NP Patidar, and RK Nema. Planning of grid integrated distributed generators: A review of technology, objectives and techniques. *Renewable and sustainable energy reviews*, 40:557–570, 2014. ISSN 1364-0321.
- [37] Klaus Mayer and Stefan Trück. Electricity markets around the world. *Journal of Commodity Markets*, 9:77–100, 2018. ISSN 2405-8513.

- [38] Fereidoon P Sioshansi. Evolution of Global Electricity Markets: New paradigms, new challenges, new approaches. Academic Press, 2013.
- [39] Davis W Edwards. Energy trading and investing: trading, risk management and structuring deals in the energy market. McGraw-Hill Education, 2009.
- [40] Stephen Littlechild. Promoting competition and protecting customers? regulation of the gb retail energy market 2008–2016. *Journal of Regulatory Economics*, 55(2):107–139, 2019.
- [41] Cathy Xin Cui. The uk electricity markets: its evolution, wholesale prices and challenge of wind energy. 2010.
- [42] Michael Pollitt. The future of electricity liberalisation in uk. 2010.
- [43] Michael Kattirtzi, Ioanna Ketsopoulou, and Jim Watson. Incumbents in transition? the role of the ‘big six’ energy companies in the uk. *Energy Policy*, 148:111927.
- [44] Tooraj Jamasb and Michael Pollitt. Electricity market reform in the european union: review of progress toward liberalization & integration. *The Energy Journal*, 26(Special Issue), 2005.
- [45] UK GOV. Energy act 2013, 2013.
- [46] Michael Grubb and David Newbery. Uk electricity market reform and the energy transition: Emerging lessons. *The Energy Journal*, 39(6), 2018.
- [47] AC Pereira and Fernando Romero. A review of the meanings and the implications of the industry 4.0 concept. *Procedia Manufacturing*, 13:1206–1214, 2017. ISSN 2351-9789.
- [48] Keliang Zhou, Taigang Liu, and Lifeng Zhou. Industry 4.0: Towards future industrial opportunities and challenges. In 2015 12th International conference on fuzzy systems and knowledge discovery (FSKD), pages 2147–2152. IEEE. ISBN 1467376825.

- [49] Stephan Weyer, Mathias Schmitt, Moritz Ohmer, and Dominic Gorecky. Towards industry 4.0-standardization as the crucial challenge for highly modular, multi-vendor production systems. *Ifac-Papersonline*, 48(3):579–584, 2015. ISSN 2405-8963.
- [50] Kagermann Henning. Recommendations for implementing the strategic initiative industrie 4.0. 2013.
- [51] E Hajrizi. Smart solution for smart factory. *IFAC-PapersOnLine*, 49(29):1–5, 2016. ISSN 2405-8963.
- [52] Elvis Hozdić. Smart factory for industry 4.0: A review. *International Journal of Modern Manufacturing Technologies*, 7(1):28–35, 2015. ISSN 2067-3604.
- [53] Fadi Shrouf, Joaquin Ordieres, and Giovanni Miragliotta. Smart factories in industry 4.0: A review of the concept and of energy management approached in production based on the internet of things paradigm. In 2014 IEEE international conference on industrial engineering and engineering management, pages 697–701. IEEE. ISBN 1479964107.
- [54] Sami Kara, Gerrit Bogdanski, and Wen Li. Electricity metering and monitoring in manufacturing systems, pages 1–10. Springer, 2011.
- [55] Stephan Haller, Stamatis Karnouskos, and Christoph Schroth. The internet of things in an enterprise context. In *Future Internet Symposium*, pages 14–28. Springer.
- [56] Elena G Efimova and Alexander A Gapochka. Seaports as drivers of regional economic development: The case of saint petersburg and leningrad province. *Case Studies on Transport Policy*, 8(2):383–393, 2020.
- [57] Jean-Paul Rodrigue. *The geography of transport systems*. Taylor & Francis, 2016.
- [58] Arianna Azzellino, Jens Peter Kofoed, Caterina Lanfredi, Lucia Margheritini, and Morten Lauge Pedersen. A marine spatial planning framework for the optimal siting of marine renewable energy installations: two danish case studies. *Journal of Coastal Research*, (65):1623–1628, 2013.

- [59] Yu-Chung Tsao and Vu Thuy Linh. Seaport-dry port network design considering multimodal transport and carbon emissions. *Journal of Cleaner Production*, 199:481–492, 2018.
- [60] Yalçın DURMUŞOĞLU, Selim AKSOY, and Cengiz DENİZ. A study of renewable energy in a port facility by using solar organic rankine cycle systems. 2016.
- [61] Jian Hua and Yihusan Wu. Implications of energy use for fishing fleet—taiwan example. *Energy Policy*, 39(5):2656–2668, 2011.
- [62] Atulya Misra, Karthik Panchabikesan, Senthil Kumar Gowrishankar, Elayaperumal Ayyasamy, and Velraj Ramalingam. Ghg emission accounting and mitigation strategies to reduce the carbon footprint in conventional port activities—a case of the port of chennai. *Carbon Management*, 8(1):45–56, 2017. ISSN 1758-3004.
- [63] UNCTAD. Review of maritime transportweea. *Carbon Management*, 1(1): 1–122, 2015.
- [64] Susan Solomon, Martin Manning, Melinda Marquis, Dahe Qin, et al. Climate change 2007-the physical science basis: Working group I contribution to the fourth assessment report of the IPCC, volume 4. Cambridge university press, 2007.
- [65] Anita Talberg, Simeon Hui, and Kate Loynes. Australian climate change policy: a chronology. Parliamentary Library, 2013.
- [66] Joseph Dutton. Eu energy policy and the third package. Energy Policy Group/UKERC working paper, 2015.
- [67] Sebastian Oberthür and Lisanne Groen. Explaining goal achievement in international negotiations: the eu and the paris agreement on climate change. *Journal of European Public Policy*, 25(5):708–727, 2018.
- [68] Jonathan Reynolds, Yacine Rezgui, and Jean-Laurent Hippolyte. Upscaling energy control from building to districts: Current limitations and future perspectives. *Sustainable cities and society*, 35:816–829, 2017. ISSN 2210-6707.

- [69] EU EWEA. Energy policy to 2050—achieving 80–95% emissions reductions. A report by the European Wind Energy Association, 2011.
- [70] JF Muir. Fuel and energy use in the fisheries sector. FAO Fisheries and Aquaculture Circular (FAO) eng no. 1080, 2015. ISSN 9251089345.
- [71] Ateyah Alzahrani, Ioan Petri, and Yacine Rezgui. Modelling and implementing smart micro-grids for fish-processing industry. In 2019 IEEE International Conference on Engineering, Technology and Innovation (ICE/ITMC), pages 1–8. IEEE. ISBN 1728134013.
- [72] Michele Acciaro, Hilda Ghiara, and Maria Inés Cusano. Energy management in seaports: A new role for port authorities. *Energy Policy*, 71:4–12, 2014.
- [73] Ntountounakis Manolis, Ishtiaq Ahmad, Kanellos Fotios, Peter Palensky, and Wolfgang Gawlik. Mas based demand response application in port city using reefers. In *International Conference on Practical Applications of Agents and Multi-Agent Systems*, pages 361–370. Springer, 2017.
- [74] Gracia Buiza, Sara Cepolina, Aleksandar Dobrijevic, M del Mar Cerbán, Olivera Djordjevic, and Cristina González. Current situation of the mediterranean container ports regarding the operational, energy and environment areas. In *2015 International Conference on Industrial Engineering and Systems Management (IESM)*, pages 530–536. IEEE, 2015.
- [75] Robert W. R. Parker, Julia L. Blanchard, Caleb Gardner, Bridget S. Green, Klaas Hartmann, Peter H. Tyedmers, and Reg A. Watson. Fuel use and greenhouse gas emissions of world fisheries. *Nature Climate Change*, 8(4): 333–337, 2018. ISSN 1758-6798. doi: 10.1038/s41558-018-0117-x. URL <https://doi.org/10.1038/s41558-018-0117-x>.
- [76] A Tindale. Designbuilder software. Stroud, Gloucestershire, Design-Builder Software Ltd, 2005.
- [77] Drury B Crawley, Linda K Lawrie, Curtis O Pedersen, and Frederick C Winkelmann. Energy plus: energy simulation program. *ASHRAE journal*, 42(4): 49–56, 2000. ISSN 0001-2491.



- [78] Michael Wetter, Philip Haves, and Brian Coffey. Building controls virtual test bed. Report, Lawrence Berkeley National Laboratory, 2008.
- [79] Paris Agreement. Paris agreement. In Report of the Conference of the Parties to the United Nations Framework Convention on Climate Change (21st Session, 2015: Paris). Retrived December, volume 4, page 2017. HeinOnline, 2015.
- [80] Pia Stoll, Larisa Rizvanovic, and Judith EY Rossebo. Active house deployment architecture for residential electricity customers' active interaction with the smart grid. 2013.
- [81] Wei Wang, Li Huang, Jian Gu, and Liupeng Jiang. Green port project scheduling with comprehensive efficiency consideration. *Maritime Policy & Management*, 46(8):967–981, 2019. ISSN 0308-8839.
- [82] Karl Gunnar Aarsaether. Energy savings in coastal fisheries: Use of a serial battery hybrid power system. *IEEE Electrification Magazine*, 5(3):74–79, 2017.
- [83] PENG Yun, LI Xiangda, WANG Wenyuan, LIU Ke, and LI Chuan. A simulation-based research on carbon emission mitigation strategies for green container terminals. *Ocean Engineering*, 163:288–298, 2018.
- [84] Wenyuan Wang, Yun Peng, Xiangda Li, Qiang Qi, Peng Feng, and Yuan Zhang. A two-stage framework for the optimal design of a hybrid renewable energy system for port application. *Ocean Engineering*, 191:106555, 2019.
- [85] Anahita Molavi, Jian Shi, Yiwei Wu, and Gino J Lim. Enabling smart ports through the integration of microgrids: A two-stage stochastic programming approach. *Applied Energy*, 258:114022, 2020.
- [86] Ateyah Alzahrani, Ioan Petri, Yacine Rezgui, and Ali Ghoroghi. Developing smart energy communities around fishery ports: Toward zero-carbon fishery ports. *Energies*, 13(11):2779, 2020.
- [87] Ateyah Alzahrani, Ioan Petri, and Yacine Rezgui. Modelling and implementing smart micro-grids for fish-processing industry. In 2019 IEEE International

- Conference on Engineering, Technology and Innovation (ICE/ITMC), pages 1–8. IEEE, 2019.
- [88] Jasmine Siu Lee Lam, Ming Jun Ko, Jing Rong Sim, and Yang Tee. Feasibility of implementing energy management system in ports. In 2017 IEEE International Conference on Industrial Engineering and Engineering Management (IEEM), pages 1621–1625. IEEE. ISBN 1538609487.
- [89] Zhang Heng, Chen Qiushuang, Quan Xiongwen, Jin Xiaochuang, and Xu Ya. Green shipping oriented coordinated berth allocation for port group. In 2015 34th Chinese Control Conference (CCC), pages 8466–8471. IEEE. ISBN 9881563895.
- [90] Li Zhu, Cuihong Qin, and Chuansheng Peng. Analysis on energy saving and emission reduction of clean energy technology in ports. In IOP Conference Series: Earth and Environmental Science, volume 121, 2018.
- [91] Soukaina Fahdi, Mariam ELKHECHAFI, and Hanaa HACHIMI. Green port in blue ocean: Optimization of energy in asian ports. In 2019 5th International Conference on Optimization and Applications (ICOA), pages 1–4. IEEE, 2019.
- [92] José E Gutierrez-Romero, Jerónimo Esteve-Pérez, and Blas Zamora. Implementing onshore power supply from renewable energy sources for requirements of ships at berth. *Applied Energy*, 255:113883, 2019.
- [93] Andrés Ortega Piris, Emma Díaz-Ruiz-Navamuel, Carlos A Pérez-Labajos, and Jesús Oria Chaveli. Reduction of co2 emissions with automatic mooring systems. the case of the port of santander. *Atmospheric Pollution Research*, 9(1):76–83, 2018. ISSN 1309-1042.
- [94] Beatriz Tovar and Alan Wall. Environmental efficiency for a cross-section of spanish port authorities. *Transportation Research Part D: Transport and Environment*, 75:170–178, 2019.
- [95] V Ramos, R Carballo, M Álvarez, M Sánchez, and G Iglesias. A port towards energy self-sufficiency using tidal stream power. *Energy*, 71:432–444, 2014.

- [96] LI Haibo, LI Wen, and SUN Xiaowei. Study on port energy consumption inventory and monitoring technology. In 2019 5th International Conference on Transportation Information and Safety (ICTIS), pages 298–302. IEEE, 2019.
- [97] Cristian Lazaroiu and Mariacristina Roscia. Sustainable port through sea wave energy converter. In 2017 IEEE 6th International Conference on Renewable Energy Research and Applications (ICRERA), pages 462–467. IEEE, 2017.
- [98] C Erdas, PA Fokaides, and C Charalambous. Ecological footprint analysis based awareness creation for energy efficiency and climate change mitigation measures enhancing the environmental management system of limassol port. *Journal of Cleaner Production*, 108:716–724, 2015.
- [99] Ying-Tsai Tsai, Chen-Jui Liang, Kuo-Hui Huang, Kuo-Hsin Hung, Ciao-Wun Jheng, and Jeng-Jong Liang. Self-management of greenhouse gas and air pollutant emissions in taichung port, taiwan. *Transportation Research Part D: Transport and Environment*, 63:576–587, 2018. ISSN 1361-9209.
- [100] Elen Twrdy and Marina Zanne. Improvement of the sustainability of ports logistics by the development of innovative green infrastructure solutions. *Transportation Research Procedia*, 45:539–546, 2020. ISSN 2352-1465.
- [101] Gara Villalba and Eskinder Demisse Gemechu. Estimating ghg emissions of marine ports—the case of barcelona. *Energy Policy*, 39(3):1363–1368, 2011.
- [102] Likun Wang, Chen Peng, Wenming Shi, and Mo Zhu. Carbon dioxide emissions from port container distribution: Spatial characteristics and driving factors. *Transportation Research Part D: Transport and Environment*, 82:102318, 2020. ISSN 1361-9209.
- [103] Felice Arena, Giovanni Malara, Giuseppe Musolino, Corrado Rindone, Alessandra Romolo, and Antonino Vitetta. From green-energy to green-logistics: A pilot study in an italian port area. *Transportation research procedia*, 30:111–118, 2018.

- [104] Hannes Johnson and Linda Styhre. Increased energy efficiency in short sea shipping through decreased time in port. *Transportation Research Part A: Policy and Practice*, 71:167–178, 2015.
- [105] Yi-Chih Yang. Operating strategies of co2 reduction for a container terminal based on carbon footprint perspective. *Journal of cleaner production*, 141: 472–480, 2017. ISSN 0959-6526.
- [106] Giuseppe Parise, Luigi Parise, Luigi Martirano, Peniamin Ben Chavdarian, Chun-Lien Su, and Andrea Ferrante. Wise port and business energy management: Port facilities, electrical power distribution. *IEEE Transactions on Industry Applications*, 52(1):18–24, 2015.
- [107] Atulya Misra, Gayathri Venkataramani, Senthilkumar Gowrishankar, Elayaperumal Ayyasam, and Velraj Ramalingam. Renewable energy based smart microgrids—a pathway to green port development. *Strategic Planning for Energy and the Environment*, 37(2):17–32, 2017. ISSN 1048-5236.
- [108] Saidur Mekhilef, Rahman Saidur, and Azadeh Safari. A review on solar energy use in industries. *Renewable and sustainable energy reviews*, 15(4):1777–1790, 2011.
- [109] John Conti, Paul Holtberg, Jim Diefenderfer, Angelina LaRose, James T Turnure, and Lynn Westfall. International energy outlook 2016 with projections to 2040. Technical report, USDOE Energy Information Administration (EIA), Washington, DC (United States ..., 2016.
- [110] Stefan Hess, Axel Oliva, Michael Hermann, Gerhard Stryi-Hipp, and Victor Hanby. Solar process heat–system design for selected lowtemperature applications in the industry. In *Solar World Congress*, 2011.
- [111] Emanuele Taibi, Dolf Gielen, and Morgan Bazilian. The potential for renewable energy in industrial applications. *Renewable and Sustainable Energy Reviews*, 16(1):735–744, 2012.
- [112] Anne Labouret and Michel Viloz. *Solar photovoltaic energy*, volume 9. IET, 2010.

- [113] Garabed P Hagopian, Nick Bebel, and Shane P Larson. Renewable energy with photovoltaic systems. 2007.
- [114] Kadra Branker, MJM Pathak, and Joshua M Pearce. A review of solar photovoltaic levelized cost of electricity. *Renewable and sustainable energy reviews*, 15(9):4470–4482, 2011.
- [115] Tin Tai Chow. A review on photovoltaic/thermal hybrid solar technology. *Applied energy*, 87(2):365–379, 2010.
- [116] Wu Libo, Zhao Zhengming, and Liu Jianzheng. A single-stage three-phase grid-connected photovoltaic system with modified mppt method and reactive power compensation. *IEEE Transactions on Energy Conversion*, 22(4):881–886, 2007.
- [117] Winfried Hoffmann. Pv solar electricity industry: Market growth and perspective. *Solar energy materials and solar cells*, 90(18-19):3285–3311, 2006.
- [118] Morris Brenna, Michela Longo, Dario Zaninelli, Rosario Miceli, and Fabio Viola. Co 2 reduction exploiting res for ev charging. In *2016 IEEE International Conference on Renewable Energy Research and Applications (ICRERA)*, pages 1191–1195. IEEE, 2016.
- [119] Jatin Verma, Shi Donghan, Koh Leong Hai, Ong Hueh Chuah, Dong Chaoyu, Xia Yang, and Xu Yan. Impact study for pv and ess integration in jurong port distribution grid. In *2018 Asian Conference on Energy, Power and Transportation Electrification (ACEPT)*, pages 1–7. IEEE.
- [120] Alsosy Balbaa, RA Swief, and Noha H El-Amary. Smart integration based on hybrid particle swarm optimization technique for carbon dioxide emission reduction in eco-ports. *Sustainability*, 11(8):2218, 2019.
- [121] 2013. URL <https://ses.jrc.ec.europa.eu/e-harbours-electric>.
- [122] Ibrahim Dincer. *Comprehensive energy systems*. Elsevier, 2018.
- [123] Yogesh Kumar, Jordan Ringenberg, Soma Shekara Depuru, Vijay K Devabhaktuni, Jin Woo Lee, Efstratios Nikolaidis, Brett Andersen, and Abdollah Afjeh.

- Wind energy: Trends and enabling technologies. *Renewable and Sustainable Energy Reviews*, 53:209–224, 2016.
- [124] Wei Tong. *Wind power generation and wind turbine design*. WIT press, 2010. ISBN 1845642058.
- [125] Stephen Peake et al. *Renewable energy-power for a sustainable future*. Number Ed. 4. Oxford university press, 2018.
- [126] S Cavazzi and AG Dutton. An offshore wind energy geographic information system (owe-gis) for assessment of the uk's offshore wind energy potential. *Renewable Energy*, 87:212–228, 2016.
- [127] Karim L Anaya and Michael G Pollitt. Integrating distributed generation: Regulation and trends in three leading countries. *Energy Policy*, 85:475–486, 2015. ISSN 0301-4215.
- [128] Fergal O Rourke, Fergal Boyle, and Anthony Reynolds. Marine current energy devices: Current status and possible future applications in ireland. *Renewable and Sustainable Energy Reviews*, 14(3):1026–1036, 2010. ISSN 1364-0321.
- [129] Shahrouz Abolhosseini, Almas Heshmati, and Jorn Altmann. A review of renewable energy supply and energy efficiency technologies. 2014.
- [130] Fergal O Rourke, Fergal Boyle, and Anthony Reynolds. Tidal energy update 2009. *Applied energy*, 87(2):398–409, 2010. ISSN 0306-2619.
- [131] E Alvarez Alvarez, Joaquin Fernández Francos, A Navarro Manso, M Rico Secades, and AJ Gutiérrez-Trashorras. Obtaining renewable energy from tidal currents in the aviles port: New services for citizens. In *New Concepts in Smart Cities: Fostering Public and Private Alliances (SmartMILE)*, 2013 International Conference on, pages 1–9. IEEE. ISBN 1479929115.
- [132] Nikoletta L Trivyza, Athanasios Rentizelas, and Gerasimos Theotokatos. Impact of carbon pricing on the cruise ship energy systems optimal configuration. *Energy*, 175:952–966, 2019. ISSN 0360-5442.

- [133] Tianli Song, Yang Li, Xiao-Ping Zhang, Cong Wu, Jianing Li, Yi Guo, and Haifei Gu. Integrated port energy system considering integrated demand response and energy interconnection. *International Journal of Electrical Power & Energy Systems*, 117:105654, 2020. ISSN 0142-0615.
- [134] Thomas Lamberti, Alessandro Sorce, Lorenzo Di Fresco, and Stefano Barberis. Smart port: exploiting renewable energy and storage potential of moored boats. In *OCEANS 2015-Genova*, pages 1–3. IEEE. ISBN 1479987360.
- [135] David Sarabia-Jácome, Ignacio Lacalle, Carlos E Palau, and Manuel Esteve. Enabling industrial data space architecture for seaport scenario. In *2019 IEEE 5th World Forum on Internet of Things (WF-IoT)*, pages 101–106. IEEE. ISBN 1538649802.
- [136] Alessandro Niglia. Securing critical infrastructure with smart grids. In *2017 5th IEEE International Conference on Models and Technologies for Intelligent Transportation Systems (MT-ITS)*, pages 223–225. IEEE. ISBN 1509064842.
- [137] Jian Li, Xiao Liu, and Bao Jiang. An exploratory study on low-carbon ports development strategy in china. *The Asian Journal of Shipping and Logistics*, 27(1):91–111, 2011. ISSN 2092-5212.
- [138] Sahar Azarkamand, Guillem Ferré, and Rosa Mari Darbra. Calculating the carbon footprint in ports by using a standardized tool. *Science of The Total Environment*, page 139407, 2020. ISSN 0048-9697.
- [139] Lei Yang, Yiji Cai, Yunlei Wei, and Shuo Huang. Choice of technology for emission control in port areas: A supply chain perspective. *Journal of Cleaner Production*, 240:118105, 2019. ISSN 0959-6526.
- [140] Maria Boile, Sotirios Theofanis, Eleftherios Sdoukopoulos, and Nikiforos Plytas. Developing a port energy management plan: Issues, challenges, and prospects. *Transportation Research Record*, 2549(1):19–28, 2016. ISSN 0361-1981.
- [141] Habib Zughbi and Paul Zulli. Energy consumption and co2 emissions benchmarking and modelling in port kembla steelworks. *Chemeca 2011: Engineer-*

- ing a Better World: Sydney Hilton Hotel, NSW, Australia, 18-21 September 2011, page 1053, 2011.
- [142] Gian Paolo Gobbi, Luca Di Liberto, and Francesca Barnaba. Impact of port emissions on eu-regulated and non-regulated air quality indicators: The case of civitavecchia (italy). *Science of The Total Environment*, page 134984, 2019. ISSN 0048-9697.
- [143] Maxim A Dulebenets. Green vessel scheduling in liner shipping: Modeling carbon dioxide emission costs in sea and at ports of call. *International Journal of Transportation Science and Technology*, 7(1):26–44, 2018. ISSN 2046-0430.
- [144] Jeong-Il Park and Taeyun Kim. Institutional improvement measures for environmental assessment in the pursuit of eco-friendly ocean renewable energy development in south korea. *Renewable and Sustainable Energy Reviews*, 58:526–536, 2016. ISSN 1364-0321.
- [145] Bostjan Pavlic, Franka Cepak, Boris Sucic, Marko Peckaj, and Bogomil Kandus. Sustainable port infrastructure, practical implementation of the green port concept. *Thermal Science*, 18(3):935–948, 2014.
- [146] Hoda Davarzani, Behnam Fahimnia, Michael Bell, and Joseph Sarkis. Greening ports and maritime logistics: A review. *Transportation Research Part D: Transport and Environment*, 48:473–487, 2016. ISSN 1361-9209.
- [147] Izabela Kotowska. Policies applied by seaport authorities to create sustainable development in port cities. *Transportation Research Procedia*, 16:236–243, 2016. ISSN 2352-1465.
- [148] FAO2018. The state of world fisheries and aquaculture 2018-meeting the sustainable development goals, 2018.
- [149] HOU Jian. Sustainable development of port economics based on system dynamics [j]. *Systems Engineering-Theory & Practice*, 1, 2010.
- [150] Chengying Hua, Jihong Chen, Zheng Wan, Lang Xu, Yun Bai, Tianxiao Zheng, and Yijie Fei. Evaluation and governance of green development practice of



- port: A sea port case of china. *Journal of Cleaner Production*, 249:119434, 2020. ISSN 0959-6526.
- [151] Intergovernmental Panel On Climate Change. *Ippc. Climate change*, 2017.
- [152] Shaun Howell, Yacine Rezgui, Jean-Laurent Hippolyte, Bejay Jayan, and Hai-jiang Li. Towards the next generation of smart grids: Semantic and holonic multi-agent management of distributed energy resources. *Renewable and Sustainable Energy Reviews*, 77:193–214, 2017. ISSN 1364-0321.
- [153] Climate Change Mitigation. *Ippc special report on renewable energy sources and climate change mitigation. Renewable Energy*, 20(11), 2011.
- [154] Leen C Kuiper, Richard Sikkema, and Johan AN Stolp. Establishment needs for short rotation forestry in the eu to meet the goals of the commission's white paper on renewable energy (november 1997). *Biomass and Bioenergy*, 15(6):451–456, 1998.
- [155] Reinhard Haas, Christian Panzer, Gustav Resch, Mario Ragwitz, Gemma Reece, and Anne Held. A historical review of promotion strategies for electricity from renewable energy sources in eu countries. *Renewable and sustainable energy reviews*, 15(2):1003–1034, 2011.
- [156] European Union. Directive 2009/28/ec of the european parliament and of the council of 23 april 2009 on the promotion of the use of energy from renewable sources and amending and subsequently repealing directives 2001/77/ec and 2003/30/ec. *Official Journal of the European Union*, 5:2009, 2009.
- [157] Burak Akgul. Green port/eco port project-applications and procedures in turkey. 95(4):042063, 2017.
- [158] Mart Puig and Rosa M Darbra. The role of ports in a global economy, issues of relevance and environmental initiatives. pages 593–611, 2019.
- [159] Lea Fobbe, Rodrigo Lozano, and Angela Carpenter. Assessing the coverage of sustainability reports: An analysis of sustainability in seaports. *SPONSORS*, page 609, 2019.

- [160] Anna Kramers, Josefin Wangel, and Mattias Höjer. Governing the smart sustainable city: the case of stockholm royal seaport. In *ICT for Sustainability 2016*. Atlantis Press, 2016.
- [161] JHR Van Duin, H Geerlings, Jens Froese, and RR Negenborn. Towards a method for benchmarking energy consumption at terminals: in search of performance improvement in yard lighting. *International Journal of Transport Development and Integration*, 1(2):212–224, 2017.
- [162] Noemí Pérez, Jorge Pey, Cristina Reche, Joaquim Cortés, Andrés Alastuey, and Xavier Querol. Impact of harbour emissions on ambient pm10 and pm2.5 in barcelona (spain): Evidences of secondary aerosol formation within the urban area. *Science of the Total Environment*, 571:237–250, 2016.
- [163] Bing Xu, Amar Nayak, David Gray, and Jamal Ouenniche. Assessing energy business cases implemented in the north sea region and strategy recommendations. *Applied energy*, 172:360–371, 2016.
- [164] I. Petri, A. Alzahrani, J. Reynolds, and Y. Rezgui. Federating smart cluster energy grids for peer-to-peer energy sharing and trading. *IEEE Access*, 8: 102419–102435, 2020. doi: 10.1109/ACCESS.2020.2998747.
- [165] Wilfried Martens. *Europe 2020 and beyond*, 2010.
- [166] Arbia Hlali and Sami Hammami. Seaport concept and services characteristics: Theoretical test. *The Open Transportation Journal*, 11(1), 2017.
- [167] Green Cranes. Report on port container terminals energy profile. Version, 14(14):02, 2013.
- [168] Adolfo Carballo-Penela, Ingrid Mateo-Mantecón, Juan Luis Doménech, and Pablo Coto-Millán. From the motorways of the sea to the green corridors’ carbon footprint: the case of a port in spain. *Journal of Environmental Planning and Management*, 55(6):765–782, 2012.
- [169] Hidde Ronde, Aulis Ranne, Eric Peirano, Ian Byrne, and Huy Le Duc. Integrated renewable energy solutions for aquaculture processing; enerfish. In

- 2011 International Conference & Utility Exhibition on Power and Energy Systems: Issues and Prospects for Asia (ICUE), pages 1–4. IEEE, 2011.
- [170] Eleftherios Sdoukopoulos, Maria Boile, Alkiviadis Tromaras, and Nikolaos Anastasiadis. Energy efficiency in european ports: State-of-practice and insights on the way forward. *Sustainability*, 11(18):4952, 2019.
- [171] Quanyuan Jiang, Meidong Xue, and Guangchao Geng. Energy management of microgrid in grid-connected and stand-alone modes. *IEEE transactions on power systems*, 28(3):3380–3389, 2013. ISSN 0885-8950.
- [172] Joseph K Siror, Sheng Huanye, and Wang Dong. Rfid based model for an intelligent port. *Computers in industry*, 62(8-9):795–810, 2011. ISSN 0166-3615.
- [173] Suying Li, Zhenzhou Ma, Peitao Han, Siyang Zhao, Peiying Guo, and Hepeng Dai. Bring intelligence to ports based on internet of things. In *International Conference on Cloud Computing and Security*, pages 128–137. Springer.
- [174] Marco Ferretti, Francesco Schiavone, Majed Al-Mashari, and Manlio Del Giudice. Internet of things and business processes redesign in seaports. the case of hamburg. *Business Process Management Journal*, 2016.
- [175] M Abaie, H.R.; Rastegary. The emergence of smart ports and their impactful implications. In *Proceedings of 14th Trans Middle East Conference*, pages 128–137. Springer.
- [176] Gordon Wilmsmeier, Jens Froese, A Zotz, and Andreas Meyer. Energy consumption and efficiency: emerging challenges from reefer trade in south american container terminals. 2014.
- [177] Michael Oppenheimer and Annie Petsonk. Article 2 of the unfccc: historical origins, recent interpretations. *Climatic change*, 73(3):195–226, 2005.
- [178] Anahita Molavi, Gino J Lim, and Bruce Race. A framework for building a smart port and smart port index. *International Journal of Sustainable Transportation*, 14(9):686–700, 2020.

- [179] IMO. Third imo greenhouse gas study 2014, 2014.
- [180] Hugh Boyes, Roy Isbell, and Alexandra Luck. Code of practice: cyber security for ports and port systems. Department for Transport, London, 2016.
- [181] Alexander G Mikerov. From the history of electrical engineering: Electricity and magnetism in old, middle ages and renaissance. Proceedings of the Russia North West Section, 3, 2012.
- [182] Stephen Pumfrey. William gilbert. Cambridge scientific minds, pages 6–20, 2002.
- [183] Michael Fowler. Historical beginnings of theories of electricity and magnetism. Physics Department, University of Virginia, 1997.
- [184] Ryan D Tweney. 2 inventing the field: Michael faraday and the creative of electromagnetic field theory. Inventive minds: Creativity in technology, page 31, 1992. ISSN 0195071700.
- [185] Patrick McGuire and Mark Granovetter. Construction of the early electricity industry in america. Explorations in economic sociology, page 213, 1993. ISSN 0871548402.
- [186] Chris Marnay and Giri Venkataramanan. Microgrids in the evolving electricity generation and delivery infrastructure. In 2006 IEEE power engineering society general meeting, pages 5–pp. IEEE, 2006.
- [187] Paul A David and Julie Ann Bunn. Gateway technologies and the evolution-dynamics of network industries: Lessons from electricity supply history. Evolutionary Technology and Market Structure: Studies in Schumpeterian Economics. University of Michigan Press, Ann Arbor, pages 121–156, 1990.
- [188] MA Ponce-Jara, E Ruiz, R Gil, E Sancristóbal, C Pérez-Molina, and M Castro. Smart grid: Assessment of the past and present in developed and developing countries. Energy strategy reviews, 18:38–52, 2017. ISSN 2211-467X.
- [189] Shaun Howell, Yacine Rezgui, Jean-Laurent Hippolyte, Bejay Jayan, and Hai-jiang Li. Towards the next generation of smart grids: Semantic and holonic

- multi-agent management of distributed energy resources. *Renewable and Sustainable Energy Reviews*, 77:193–214, 2017. ISSN 1364-0321.
- [190] AR Abhyankar and SA Khaparde. Introduction to deregulation in power industry. Report by Indian Institute of Technology, Mumbai, 2013.
- [191] EPA. Centralized generation of electricity and its impacts on the environment, 2019.
- [192] Ziad Melhem. Electricity transmission, distribution and storage systems. Elsevier, 2013. ISBN 0857097377.
- [193] Jeremi Martin. Distributed vs. centralized electricity generation: are we witnessing a change of paradigm. An introduction to distributed generation, 2009.
- [194] Thierry Dujardin. Projected costs of generating electricity 2005 update. 2005.
- [195] Jim McDonald. Adaptive intelligent power systems: Active distribution networks. *Energy Policy*, 36(12):4346–4351, 2008. ISSN 0301-4215.
- [196] Thomas Ackermann, Göran Andersson, and Lennart Söder. Distributed generation: a definition1. *Electric power systems research*, 57(3):195–204, 2001. ISSN 0378-7796.
- [197] Frank Jay and JA Goetz. Ieee standard dictionary of electrical and electronics terms. Institute of Electrical and Electronics Engineers. ISBN 1559370009.
- [198] L Mehigan, JP Deane, BP Ó Gallachóir, and V Bertsch. A review of the role of distributed generation (dg) in future electricity systems. *Energy*, 2018. ISSN 0360-5442.
- [199] Walid El-Khattam and Magdy MA Salama. Distributed generation technologies, definitions and benefits. *Electric power systems research*, 71(2):119–128, 2004.

- [200] Paulino E Labis, Rey G Visande, Reuel C Pallugna, and Nolan D Caliao. The contribution of renewable distributed generation in mitigating carbon dioxide emissions. *Renewable and Sustainable Energy Reviews*, 15(9):4891–4896, 2011. ISSN 1364-0321.
- [201] Goran Strbac, Charlotte Ramsay, and Danny Pudjianto. Integration of distributed generation into the uk power system. DTI Centre for Distributed Generation and Sustainable Electrical Energy, 2007.
- [202] Francesco Gulli. Small distributed generation versus centralised supply: a social cost–benefit analysis in the residential and service sectors. *Energy Policy*, 34(7):804–832, 2006. ISSN 0301-4215.
- [203] Xiaodong Cao, Xilei Dai, and Junjie Liu. Building energy-consumption status worldwide and the state-of-the-art technologies for zero-energy buildings during the past decade. *Energy and buildings*, 128:198–213, 2016. ISSN 0378-7788.
- [204] Mohammed Yekini Suberu, Mohd Wazir Mustafa, and Nouruddeen Bashir. Energy storage systems for renewable energy power sector integration and mitigation of intermittency. *Renewable and Sustainable Energy Reviews*, 35: 499–514, 2014.
- [205] Ahmed F Zobaa. *Energy Storage: Technologies and Applications*. BoD–Books on Demand, 2013. ISBN 9535109510.
- [206] Tarik Kousksou, Pascal Bruel, Abdelmajid Jamil, T El Rhafiki, and Youssef Zeraouli. Energy storage: Applications and challenges. *Solar Energy Materials and Solar Cells*, 120:59–80, 2014. ISSN 0927-0248.
- [207] TMI Mahlia, TJ Saktisahdan, A Jannifar, MH Hasan, and HSC Matseelar. A review of available methods and development on energy storage; technology update. *Renewable and Sustainable Energy Reviews*, 33:532–545, 2014. ISSN 1364-0321.
- [208] Mathew Aneke and Meihong Wang. Energy storage technologies and real

- life applications—a state of the art review. *Applied Energy*, 179:350–377, 2016. ISSN 0306-2619.
- [209] Mehmet Esen. Thermal performance of a solar-aided latent heat store used for space heating by heat pump. *Solar energy*, 69(1):15–25, 2000. ISSN 0038-092X.
- [210] Mukrimin Sevket Guney and Yalcin Tepe. Classification and assessment of energy storage systems. *Renewable and Sustainable Energy Reviews*, 75: 1187–1197, 2017. ISSN 1364-0321.
- [211] Xingguo Tan, Qingmin Li, and Hui Wang. Advances and trends of energy storage technology in microgrid. *International Journal of Electrical Power & Energy Systems*, 44(1):179–191, 2013. ISSN 0142-0615.
- [212] Yuqing Yang, Stephen Bremner, Chris Menictas, and Merlinde Kay. Battery energy storage system size determination in renewable energy systems: A review. *Renewable and Sustainable Energy Reviews*, 91:109–125, 2018. ISSN 1364-0321.
- [213] Francisco Díaz-González, Andreas Sumper, Oriol Gomis-Bellmunt, and Roberto Villafáfila-Robles. A review of energy storage technologies for wind power applications. *Renewable and sustainable energy reviews*, 16 (4):2154–2171, 2012. ISSN 1364-0321.
- [214] S Koochi-Fayegh and MA Rosen. A review of energy storage types, applications and recent developments. *Journal of Energy Storage*, 27:101047, 2020. ISSN 2352-152X.
- [215] Valentin A Boicea. Energy storage technologies: The past and the present. *Proceedings of the IEEE*, 102(11):1777–1794, 2014. ISSN 0018-9219.
- [216] Giridhar Kini. Energy management systems. *BoD—Books on Demand*, 2011. ISBN 9533075791.
- [217] Rahul Chaturvedi, Sandeep Guide Kumar, and Praveen Guide Joshi. Efficiency Improvement By Energy Optimization Program In Energy Intensive Industries A Case Study of Satia Industries Limited, Muktsar (Punjab). Thesis, 2016.

- [218] Giovanni Petrecca. *Industrial Energy Management: Principles and Applications: Principles and Applications*. Springer Science & Business Media, 2012. ISBN 1461531608.
- [219] Mudathir Funsho Akorede, Hashim Hizam, and Edris Pouresmaeil. Distributed energy resources and benefits to the environment. *Renewable and sustainable energy reviews*, 14(2):724–734, 2010. ISSN 1364-0321.
- [220] Maria Lorena Tuballa and Michael Lochinvar Abundo. A review of the development of smart grid technologies. *Renewable and Sustainable Energy Reviews*, 59:710–725, 2016. ISSN 1364-0321.
- [221] Yeliz Yoldaş, Ahmet Önen, SM Muyeen, Athanasios V Vasilakos, and İrfan Alan. Enhancing smart grid with microgrids: Challenges and opportunities. *Renewable and Sustainable Energy Reviews*, 72:205–214, 2017. ISSN 1364-0321.
- [222] Napaporn Phuangpornpitak and Suvit Tia. Opportunities and challenges of integrating renewable energy in smart grid system. *Energy Procedia*, 34: 282–290, 2013. ISSN 1876-6102.
- [223] Dan T Ton and Merrill A Smith. The us department of energy’s microgrid initiative. *The Electricity Journal*, 25(8):84–94, 2012. ISSN 1040-6190.
- [224] Nick Jenkins, Chao Long, and Jianzhong Wu. An overview of the smart grid in great britain. *Engineering*, 1(4):413–421, 2015. ISSN 2095-8099.
- [225] Luis M Camarinha-Matos. Collaborative smart grids—a survey on trends. *Renewable and Sustainable Energy Reviews*, 65:283–294, 2016. ISSN 1364-0321.
- [226] Ataul Bari, Jin Jiang, Walid Saad, and Arunita Jaekel. Challenges in the smart grid applications: an overview. *International Journal of Distributed Sensor Networks*, 10(2):974682, 2014. ISSN 1550-1477.
- [227] Vehbi C Gungor, Dilan Sahin, Taskin Kocak, Salih Ergut, Concettina Buccella, Carlo Cecati, and Gerhard P Hancke. *Smart grid technologies: Communica-*



- tion technologies and standards. *IEEE transactions on Industrial informatics*, 7(4):529–539, 2011. ISSN 1551-3203.
- [228] Yeliz Yoldaş, Ahmet Önen, SM Muyeen, Athanasios V Vasilakos, and İrfan Alan. Enhancing smart grid with microgrids: Challenges and opportunities. *Renewable and Sustainable Energy Reviews*, 72:205–214, 2017. ISSN 1364-0321.
- [229] Abdeen Mustafa Omer. Energy, environment and sustainable development. *Renewable and sustainable energy reviews*, 12(9):2265–2300, 2008. ISSN 1364-0321.
- [230] Di Zhang. Optimal design and planning of energy microgrids. Thesis, 2014.
- [231] Di Zhang, Nouri J Samsatli, Adam D Hawkes, Dan JL Brett, Nilay Shah, and Lazaros G Papageorgiou. Fair electricity transfer price and unit capacity selection for microgrids. *Energy Economics*, 36:581–593, 2013. ISSN 0140-9883.
- [232] Zuo Sun and Xun-you Zhang. Advances on distributed generation technology. *Energy Procedia*, 17:32–38, 2012. ISSN 1876-6102.
- [233] Suleiman Abu-Sharkh, RJ Arnold, J Kohler, R Li, T Markvart, JN Ross, Koen Steemers, P Wilson, and Runming Yao. Can microgrids make a major contribution to uk energy supply? *Renewable and Sustainable Energy Reviews*, 10(2):78–127, 2006.
- [234] Md Alamgir Hossain, Hemanshu Roy Pota, Md Jahangir Hossain, and Frede Blaabjerg. Evolution of microgrids with converter-interfaced generations: Challenges and opportunities. *International Journal of Electrical Power & Energy Systems*, 109:160–186, 2019. ISSN 0142-0615.
- [235] Quanyuan Jiang, Meidong Xue, and Guangchao Geng. Energy management of microgrid in grid-connected and stand-alone modes. *IEEE transactions on power systems*, 28(3):3380–3389, 2013. ISSN 0885-8950.
- [236] Arangarajan Vinayagam, Ahmad Abu Alqumsan, KSV Swarna, Sui Yang Khoo, and Alex Stojcevski. Intelligent control strategy in the islanded network of

- a solar pv microgrid. *Electric Power Systems Research*, 155:93–103, 2018. ISSN 0378-7796.
- [237] Hassan Farhangi. *Smart Microgrids: Lessons from Campus Microgrid Design and Implementation*. CRC Press, 2016. ISBN 131535537X.
- [238] Omar Ellabban, Haitham Abu-Rub, and Frede Blaabjerg. Renewable energy resources: Current status, future prospects and their enabling technology. *Renewable and Sustainable Energy Reviews*, 39:748–764, 2014. ISSN 1364-0321.
- [239] Ran Wang, Ping Wang, and Gaoxi Xiao. A robust optimization approach for energy generation scheduling in microgrids. *Energy Conversion and Management*, 106:597–607, 2015. ISSN 0196-8904.
- [240] Baseem Khan and Pawan Singh. Selecting a meta-heuristic technique for smart micro-grid optimization problem: A comprehensive analysis. *IEEE Access*, 5:13951–13977, 2017. ISSN 2169-3536.
- [241] Nikos Hatziargyriou. *Microgrids: architectures and control*. John Wiley & Sons, 2014. ISBN 1118720687.
- [242] Josep M Guerrero, Zheming Jin, Wenzhao Liu, Muzaidi B Othman, Mehdi Savaghebi, Amjad Anvari-Moghaddam, Lexuan Meng, and Juan C Vasquez. Shipboard microgrids: Maritime islanded power systems technologies. In *PCIM Asia 2016; International Exhibition and Conference for Power Electronics, Intelligent Motion, Renewable Energy and Energy Management*, pages 1–8. VDE, 2016.
- [243] Sidun Fang, Yu Wang, Bin Gou, and Yan Xu. Toward future green maritime transportation: An overview of seaport microgrids and all-electric ships. *IEEE Transactions on Vehicular Technology*, 69(1):207–219, 2019.
- [244] Shakir D Ahmed, Fahad SM Al-Ismael, Md Shafiullah, Fahad A Al-Sulaiman, and Ibrahim M El-Amin. Grid integration challenges of wind energy: A review. *IEEE Access*, 8:10857–10878, 2020.

- [245] Nor Baizura Ahamad, Muzaidi Othman, Juan C Vasquez, Josep M Guerrero, and Chun-Lien Su. Optimal sizing and performance evaluation of a renewable energy based microgrid in future seaports. pages 1043–1048, 2018.
- [246] Elaheh Mashhour and Seyed Masoud Moghaddas-Tafreshi. Bidding strategy of virtual power plant for participating in energy and spinning reserve markets—part i: Problem formulation. *IEEE Transactions on Power Systems*, 26(2):949–956, 2010. ISSN 0885-8950.
- [247] Predrag Djapic, Charlotte Ramsay, Danny Pudjianto, Goran Strbac, Joseph Mutale, Nick Jenkins, and Ron Allan. Taking an active approach. *IEEE Power and Energy Magazine*, 5(4):68–77, 2007. ISSN 1540-7977.
- [248] Madina Kenzhina, Ileskhan Kalysh, Ikechi Ukaegbu, and Sivanand K Nunna. Virtual power plant in industry 4.0: The strategic planning of emerging virtual power plant in kazakhstan. In *2019 21st International Conference on Advanced Communication Technology (ICACT)*, pages 600–605. IEEE. ISBN 9791188428021.
- [249] Oliver Nwauka, Arnesh Telukdarie, and Johan Enslin. Virtual power plant basic requirements for integration of distributed energy resources driven by industry 4.0. *IEOM*, pages 511–523, 2018.
- [250] Lucian Ioan Dulau, Mihail Abrudean, and Dorin Bica. Applications of virtual power plants approaches. In *2014 International Conference and Exposition on Electrical and Power Engineering (EPE)*, pages 1060–1064. IEEE. ISBN 1479958492.
- [251] Lucian Ioan Dulău, Mihail Abrudean, and Dorin Bică. Distributed generation and virtual power plants. In *2014 49th International Universities Power Engineering Conference (UPEC)*, pages 1–5. IEEE. ISBN 147996557X.
- [252] Hedayat Saboori, M Mohammadi, and R Taghe. Virtual power plant (vpp), definition, concept, components and types. In *2011 Asia-Pacific Power and Energy Engineering Conference*, pages 1–4. IEEE. ISBN 142446255X.

- [253] Amanpreet Kaur, Lukas Nonnenmacher, and Carlos FM Coimbra. Net load forecasting for high renewable energy penetration grids. *Energy*, 114:1073–1084, 2016. ISSN 0360-5442.
- [254] AY Abdelaziz, YG Hegazy, Walid El-Khattam, and MM Othman. Virtual power plant: The future of power delivery systems. In *European Workshop on Renewable Energy Systems*, pages 1–2.
- [255] Muhammad Waseem Ahmad, Monjur Mourshed, David Mundow, Mario Sisinni, and Yacine Rezgui. Building energy metering and environmental monitoring—a state-of-the-art review and directions for future research. *Energy and Buildings*, 120:85–102, 2016.
- [256] F Bandejas, M Gomes, P Coelho, and J Fernandes. Towards net zero energy in industrial and commercial buildings in portugal. *Renewable and Sustainable Energy Reviews*, 119:109580, 2020. ISSN 1364-0321.
- [257] Kent Peterson, P Torcellini, Roger Grant, C Taylor, S Punjabi, and R Diamond. A common definition for zero energy buildings. Prepared for the US Department of Energy by The National Institute of Building Sciences, US Department of Energy, 2015.
- [258] EPBD Recast. Directive 2010/31/eu of the european parliament and of the council of 19 may 2010 on the energy performance of buildings (recast). *Official Journal of the European Union*, 18(06):2010, 2010.
- [259] Shady Attia. *Net Zero Energy Buildings (NZEB): Concepts, frameworks and roadmap for project analysis and implementation*. Butterworth-Heinemann, 2018. ISBN 0128124628.
- [260] Serena H Chen, Anthony J Jakeman, and John P Norton. Artificial intelligence techniques: an introduction to their use for modelling environmental systems. *Mathematics and computers in simulation*, 78(2-3):379–400, 2008. ISSN 0378-4754.
- [261] I Gupta and G Nagpal. *Artificial Intelligence and Expert Systems*. Stylus Publishing, LLC, 2020. ISBN 1683925068.

- [262] Ronald R Yager and Lotfi A Zadeh. An introduction to fuzzy logic applications in intelligent systems, volume 165. Springer Science & Business Media, 2012. ISBN 1461536405.
- [263] Andrej Krenker, Janez Bešter, and Andrej Kos. Introduction to the artificial neural networks. *Artificial Neural Networks: Methodological Advances and Biomedical Applications*. InTech, pages 1–18, 2011.
- [264] Scott M Thede. An introduction to genetic algorithms. *Journal of Computing Sciences in Colleges*, 20(1):115–123, 2004. ISSN 1937-4771.
- [265] Weerakorn Ongsakul and Vo Ngoc Dieu. *Artificial intelligence in power system optimization*. Crc Press, 2013. ISBN 1578088054.
- [266] Aqeel Ahmed Bazmi and Gholamreza Zahedi. Sustainable energy systems: Role of optimization modeling techniques in power generation and supply—a review. *Renewable and sustainable energy reviews*, 15(8):3480–3500, 2011. ISSN 1364-0321.
- [267] Ralf T Kreutzer and Marie Sirrenberg. *Fields of Application of Artificial Intelligence—Customer Service, Marketing and Sales*, pages 105–154. Springer, 2020.
- [268] Ralf T Kreutzer and Marie Sirrenberg. *Fields of Application of Artificial Intelligence—Energy Sector, Smart Home, Mobility and Transport*, pages 195–210. Springer, 2020.
- [269] Muhammad Waseem Ahmad, Jonathan Reynolds, and Yacine Rezgui. Predictive modelling for solar thermal energy systems: A comparison of support vector regression, random forest, extra trees and regression trees. *Journal of cleaner production*, 203:810–821, 2018. ISSN 0959-6526.
- [270] Muhammad Waseem Ahmad, Monjur Mourshed, and Yacine Rezgui. Tree-based ensemble methods for predicting pv power generation and their comparison with support vector regression. *Energy*, 164:465–474, 2018. ISSN 0360-5442.

- [271] Muhammad Waseem Ahmad, Anthony Mouraud, Yacine Rezgui, and Monjur Mourshed. Deep highway networks and tree-based ensemble for predicting short-term building energy consumption. *Energies*, 11(12):3408, 2018.
- [272] Christos D Korkas, Simone Baldi, Iakovos Michailidis, and Elias B Kosmatopoulos. Intelligent energy and thermal comfort management in grid-connected microgrids with heterogeneous occupancy schedule. *Applied Energy*, 149:194–203, 2015. ISSN 0306-2619.
- [273] Anastasios I Dounis. Artificial intelligence for energy conservation in buildings. *Advances in Building Energy Research*, 4(1):267–299, 2010. ISSN 1751-2549.
- [274] Zhu Wang, Rui Yang, and Lingfeng Wang. Intelligent multi-agent control for integrated building and micro-grid systems. In *ISGT 2011*, pages 1–7. IEEE. ISBN 1612842208.
- [275] Linfei Yin, Qi Gao, Lulin Zhao, Bin Zhang, Tao Wang, Shengyuan Li, and Hui Liu. A review of machine learning for new generation smart dispatch in power systems. *Engineering Applications of Artificial Intelligence*, 88: 103372, 2020. ISSN 0952-1976.
- [276] Jonathan Anderson, Tom van Weert, and Charles Duchâteau. *Information and communication technology in education: A curriculum for schools and programme of teacher development*. 2002.
- [277] Muhammad Faheem, Syed Bilal Hussain Shah, Rizwan Aslam Butt, Basit Raza, Muhammad Anwar, M Waqar Ashraf, Md A Ngadi, and Vehbi C Gungor. Smart grid communication and information technologies in the perspective of industry 4.0: Opportunities and challenges. *Computer Science Review*, 30:1–30, 2018. ISSN 1574-0137.
- [278] Terézia Kazičková and Barbora Buhnova. Ict architecture for the smart grid: Concept overview. In *2016 Smart Cities Symposium Prague (SCSP)*, pages 1–4. IEEE. ISBN 1509011161.

- [279] Glover T Ferguson. Have your objects call my objects. *Harvard business review*, 80(6):138–144, 2002. ISSN 0017-8012.
- [280] Somayya Madakam, Vihar Lake, Vihar Lake, and Vihar Lake. Internet of things (iot): A literature review. *Journal of Computer and Communications*, 3(05):164, 2015.
- [281] Muhamed Umar Farooq, Muhammad Waseem, Sadia Mazhar, Anjum Khairi, and Talha Kamal. A review on internet of things (iot). *International Journal of Computer Applications*, 113(1):1–7, 2015. ISSN 0975-8887.
- [282] Anna Maria Kotrikla, Theodoros Lilas, and Nikitas Nikitakos. Abatement of air pollution at an aegean island port utilizing shore side electricity and renewable energy. *Marine Policy*, 75:238–248, 2017. ISSN 0308-597X.
- [283] J Prousalidis, DV Lyridis, S Dallas, C Papaleonidas, P Mitrou, E Vergetis, E Vaimaki, S Aggelopoulos, T Kourmpelis, and V Georgiou. The ports as smart micro-grids: development perspectives. *Proceedings of HAEE*, pages 12–16, 2017.
- [284] Ben Jemaa Abdelhak, Essounbouli Najib, Hamzaoui Abdelaziz, Faicel Hnaien, and Farouk Yalaoui. Optimum sizing of hybrid pv/wind/battery using fuzzy-adaptive genetic algorithm in real and average battery service life. In *2014 International symposium on power electronics, electrical drives, automation and motion*, pages 871–876. IEEE. ISBN 1479947490.
- [285] David Parra, Stuart A Norman, Gavin S Walker, and Mark Gillott. Optimum community energy storage for renewable energy and demand load management. *Applied energy*, 200:358–369, 2017. ISSN 0306-2619.
- [286] Jiaming Li. Optimal sizing of grid-connected photovoltaic battery systems for residential houses in australia. *Renewable energy*, 136:1245–1254, 2019. ISSN 0960-1481.
- [287] Wina Crijns-Graus, Hui Yue, Shaohui Zhang, Katerina Kermeli, and Ernst Worrell. Energy efficiency improvement opportunities in the global industrial sector. 2019.

- [288] Zeineb Abdmouleh, Adel Gastli, Lazhar Ben-Brahim, Mohamed Haouari, and Nasser Ahmed Al-Emadi. Review of optimization techniques applied for the integration of distributed generation from renewable energy sources. *Renewable Energy*, 113:266–280, 2017. ISSN 0960-1481.
- [289] Steve Doty and Wayne C Turner. *Energy management handbook*. Crc Press, 2004. ISBN 0824748123.
- [290] Albert Thumann and William J Younger. *Handbook of energy audits*. The Fairmont Press, Inc., 2008. ISBN 0881735787.
- [291] Aldona Kluczek and Paweł Olszewski. Energy audits in industrial processes. *Journal of cleaner production*, 142:3437–3453, 2017. ISSN 0959-6526.
- [292] L Price and H Lu. *Industrial energy auditing and assessments: a survey of programs around the world: Eceee summer study 2011*, 2011.
- [293] Svetlana Paramonova and Patrik Thollander. Energy-efficiency networks for smes: Learning from the swedish experience. *Renewable and Sustainable Energy Reviews*, 65:295–307, 2016. ISSN 1364-0321.
- [294] Kenneth Gillingham and Tsvetan Tsvetanov. Nudging energy efficiency audits: Evidence from a field experiment. *Journal of Environmental Economics and Management*, 90:303–316, 2018. ISSN 0095-0696.
- [295] F Kalantzis and D Revoltella. Do energy audits help smes to realize energy-efficiency opportunities? *Energy Economics*, 83:229–239, 2019. ISSN 0140-9883.
- [296] Costel Mironeasa and Georgiana Gabriela Codină. A new approach of audit functions and principles. *Journal of cleaner production*, 43:27–36, 2013. ISSN 0959-6526.
- [297] Kaixuan Chen, Jin Lin, and Yonghua Song. Trading strategy optimization for a prosumer in continuous double auction-based peer-to-peer market: A prediction-integration model. *Applied energy*, 242:1121–1133, 2019. ISSN 0306-2619.



- [298] Joana Sousa. Energy simulation software for buildings: review and comparison. In International Workshop on Information Technology for Energy Applications-IT4Energy, Lisbon.
- [299] Philip Haves. Energy simulation tools for buildings: An overview. In AIP Conference Proceedings, volume 1401, pages 313–327. American Institute of Physics, 2011.
- [300] UNDESA UNDP. *Wec,(2000): World energy assessment: Energy and the challenge of sustainability*. United Nations Development Programme, New York, 2000.
- [301] Hannes Johnson and Linda Styhre. Increased energy efficiency in short sea shipping through decreased time in port. *Transportation Research Part A: Policy and Practice*, 71:167–178, 2015. ISSN 0965-8564.
- [302] Nebojsa Nakicenovic, A Grubler, H Ishitani, TB Johansson, G Marland, JR Moreira, and H-H Rogner. *Energy primer*. Climate Change 1995, 1996.
- [303] Thomas Bruckner, Igor Alexeyevich Bashmakov, Yacob Mulugetta, Helen Chum, Angel De la Vega Navarro, James Edmonds, A Faaij, B Fungtammasan, A Garg, E Hertwich, et al. *Energy systems*. 2014.
- [304] Christos A Frangopoulos. *Exergy, Energy System Analysis and Optimization- Volume III: Artificial Intelligence and Expert Systems in Energy Systems Analysis Sustainability Considerations in the Modeling of Energy Systems*, volume 3. EOLSS Publications, 2009.
- [305] L Suganthi and Anand A Samuel. Energy models for demand forecasting—a review. *Renewable and sustainable energy reviews*, 16(2):1223–1240, 2012.
- [306] RB Hiremath, S Shikha, and NH Ravindranath. Decentralized energy planning; modeling and application—a review. *Renewable and Sustainable Energy Reviews*, 11(5):729–752, 2007.
- [307] Deepak Paramashivan Kaundinya, Palit Balachandra, and Nijavalli H Ravindranath. Grid-connected versus stand-alone energy systems for decentral-

- ized power—a review of literature. *Renewable and sustainable energy reviews*, 13(8):2041–2050, 2009.
- [308] Raul Banos, Francisco Manzano-Agugliaro, FG Montoya, Consolacion Gil, Alfredo Alcayde, and Julio Gómez. Optimization methods applied to renewable and sustainable energy: A review. *Renewable and sustainable energy reviews*, 15(4):1753–1766, 2011.
- [309] Ali M Adil and Yekang Ko. Socio-technical evolution of decentralized energy systems: A critical review and implications for urban planning and policy. *Renewable and Sustainable Energy Reviews*, 57:1025–1037, 2016.
- [310] Cambridge University Press. Cambridge online dictionary, 2019. URL <https://dictionary.cambridge.org/dictionary/english/methodology>.
- [311] Th J Schriber. The nature and role of simulation in the design of manufacturing systems. *Simulation in CIM and Artificial Intelligence Techniques*, 25: 5–18, 1987.
- [312] IA Jarvis. Building energy targeting. In *Energy Developments: New Forms, Renewables, Conservation*, pages 735–739. Elsevier, 1984.
- [313] Ibrahim Dincer. *Comprehensive energy systems*. Elsevier, 2018. ISBN 0128149256.
- [314] Faouzi Bouchhima, Gabriela Nicolescu, M Aboulhamid, and Mohamed Abid. Discrete-continuous simulation model for accurate validation in component-based heterogeneous soc design. In *16th IEEE International Workshop on Rapid System Prototyping (RSP’05)*, pages 181–187. IEEE. ISBN 0769523617.
- [315] Onur Özgün and Yaman Barlas. Discrete vs. continuous simulation: When does it matter. In *Proceedings of the 27th international conference of the system dynamics society*, volume 6, pages 1–22, 2009.
- [316] Jerry Banks. *Discrete event system simulation*. Pearson Education India, 2005. ISBN 8131758966.

- [317] Anders Skoogh, Björn Johansson, and L Hansson. Data requirements and representation for simulation of energy consumption in production systems. In Proceedings of the 44th CIRP Conference on Manufacturing Systems, pages 1–3.
- [318] Michael Oates. A new approach to modelling process and building energy flows in manufacturing industry. 2013.
- [319] Desmond J Higham and Nicholas J Higham. MATLAB guide. SIAM, 2016. ISBN 1611974658.
- [320] MathWorks. Simulink, 2020. URL <https://uk.mathworks.com/help/simulink/>.
- [321] Cláudio Gomes, Casper Thule, David Broman, Peter Gorm Larsen, and Hans Vangheluwe. Co-simulation: a survey. ACM Computing Surveys (CSUR), 51(3):1–33, 2018. ISSN 0360-0300.
- [322] Nayeemur Rahman, Maria Islam, and Md Ziaur Rahman Khan. Power sharing between solar home systems by smart control of power flow. In 2018 10th International Conference on Electrical and Computer Engineering (ICECE), pages 193–196. IEEE. ISBN 1538674823.
- [323] Mohamad Fadzli Haniff, Hazlina Selamat, Rubiyah Yusof, Salinda Buyamin, and Fatimah Sham Ismail. Review of hvac scheduling techniques for buildings towards energy-efficient and cost-effective operations. Renewable and Sustainable Energy Reviews, 27:94–103, 2013. ISSN 1364-0321.
- [324] Shin Jae Kang, Jungsung Park, Ki-Yong Oh, Jae Gu Noh, and Hyunggon Park. Scheduling-based real time energy flow control strategy for building energy management system. Energy and Buildings, 75:239–248, 2014.
- [325] Ditiro Setlhaolo, Xiaohua Xia, and Jiangfeng Zhang. Optimal scheduling of household appliances for demand response. Electric Power Systems Research, 116:24–28, 2014.

- [326] Hasnae Bilil, Ghassane Aniba, and Hamid Gharavi. Dynamic appliances scheduling in collaborative microgrids system. *IEEE Transactions on Power Systems*, 32(3):2276–2287, 2016.
- [327] Xinhui Lu, Kaile Zhou, Felix TS Chan, and Shanlin Yang. Optimal scheduling of household appliances for smart home energy management considering demand response. *Natural Hazards*, 88(3):1639–1653, 2017.
- [328] Tarek AlSkaif, Adriana C Luna, Manel Guerrero Zapata, Josep M Guerrero, and Boris Bellalta. Reputation-based joint scheduling of households appliances and storage in a microgrid with a shared battery. *Energy and Buildings*, 138:228–239, 2017.
- [329] Sardar Mehboob Hussain, Ayesha Zafar, Rabiya Khalid, Samia Abid, Umar Qasim, Zahoor Ali Khan, and Nadeem Javaid. An efficient scheduling of electrical appliance in micro grid based on heuristic techniques. In *Conference on Complex, Intelligent, and Software Intensive Systems*, pages 164–173. Springer, 2017.
- [330] Raj Mani Shukla, Prasanna Kansakar, and Arslan Munir. A neural network-based appliance scheduling methodology for smart homes and buildings with multiple power sources. In *2016 IEEE International Symposium on Nanoelectronic and Information Systems (iNIS)*, pages 166–171. IEEE. ISBN 1509061703.
- [331] FA Qayyum, Muhammad Naeem, Ahmed Shaharyar Khwaja, Alagan Anpalagan, Ling Guan, and Bala Venkatesh. Appliance scheduling optimization in smart home networks. *IEEE Access*, 3:2176–2190, 2015. ISSN 2169-3536.
- [332] Ministry of Environmnet Strategy and Climate Change. Fish processing facilities compliance audit report. Report, 2018.
- [333] Anca I. Nicolau Daniela Borda and Peter Raspor. *Trends in Fish Processing Technologies*. Taylor Francis Group, 2017.
- [334] Sunday Olayinka Oyedepo. *Energy Use and Energy Saving Potentials in Food*

- Processing and Packaging: Case Study of Nigerian Industries, pages 423–452. Elsevier, 2019.
- [335] COWI Consulting Engineers, Industry Planners AS, Denmark for United Nations Environment Programme Division of Technology, and Economics. Cleaner production assessment in fish processing. Report, 2019.
- [336] Bord Lascaigh Mahara (BIM). Resource efficiency guide for seafood processors. Report, 2016.
- [337] Nihar Shah, Max Wei, Virginie Letschert, and Amol Phadke. Benefits of energy efficient and low-global warming potential refrigerant cooling equipment. 2019.
- [338] Wayes Tushar, Bo Chai, Chau Yuen, Shisheng Huang, David B Smith, H Vincent Poor, and Zaiyue Yang. Energy storage sharing in smart grid: A modified auction-based approach. *IEEE Transactions on Smart Grid*, 7(3):1462–1475, 2016. ISSN 1949-3053.
- [339] Wayes Tushar, Chau Yuen, Hamed Mohsenian-Rad, Tapan Saha, H Vincent Poor, and Kristin L Wood. Transforming energy networks via peer to peer energy trading: Potential of game theoretic approaches. arXiv preprint arXiv:1804.00962, 2018.
- [340] Wayes Tushar, Tapan Kumar Saha, Chau Yuen, Thomas Morstyn, Malcolm D McCulloch, H Vincent Poor, and Kristin L Wood. A motivational game-theoretic approach for peer-to-peer energy trading in the smart grid. *Applied energy*, 243:10–20, 2019.
- [341] Nian Liu, Xinghuo Yu, Cheng Wang, Chaojie Li, Li Ma, and Jinyong Lei. Energy-sharing model with price-based demand response for microgrids of peer-to-peer prosumers. *IEEE Transactions on Power Systems*, 32(5):3569–3583, 2017. ISSN 0885-8950.
- [342] Nian Liu, Minyang Cheng, Xinghuo Yu, Jiangxia Zhong, and Jinyong Lei. Energy-sharing provider for pv prosumer clusters: A hybrid approach using

- stochastic programming and stackelberg game. *IEEE Transactions on Industrial Electronics*, 65(8):6740–6750, 2018. ISSN 0278-0046.
- [343] Augustine Ikpehai Bamidele Adebisi Kelvin Anoh, Sabita Maharjan. Energy peer-to-peer trading in virtual microgrids in smart grids: A game-theoretic approach. *IEEE Transactions on Smart Grid*, pages PP(99):1–1, 2019. doi: 10.1109/TSG.2019.2934830.
- [344] Chenghua Zhang, Jianzhong Wu, Yue Zhou, Meng Cheng, and Chao Long. Peer-to-peer energy trading in a microgrid. *Applied Energy*, 220:1–12, 2018. ISSN 0306-2619.
- [345] Chou Hon Leong, Chenghong Gu, and Furong Li. Auction mechanism for p2p local energy trading considering physical constraints. *Energy Procedia*, 158: 6613–6618, 2019. ISSN 1876-6102.
- [346] Jema Sharin PankiRaj, Abdulsalam Yassine, and Salimur Choudhury. An auction mechanism for profit maximization of peer-to-peer energy trading in smart grids. *Procedia Computer Science*, 151:361–368, 2019. ISSN 1877-0509.
- [347] Zhenyuan Zhang, Haoyue Tang, and Qi Huang. Risk implemented simultaneous game-theoretic approach for energy trading in residential microgrids. *Energy Procedia*, 158:6679–6686, 2019. ISSN 1876-6102.
- [348] VSKV Harish, Naqui Anwer, and Amit Kumar. *Optimal Energy Sharing Within a Solar-Based DC Microgrid*, pages 635–644. Springer, 2019.
- [349] Chao Long, Jianzhong Wu, Chenghua Zhang, Meng Cheng, and Ali Al-Wakeel. Feasibility of peer-to-peer energy trading in low voltage electrical distribution networks. *Energy Procedia*, 105:2227–2232, 2017. ISSN 1876-6102.
- [350] Furong Li Zhong Zhang, Ran Li. A novel peer-to-peer local electricity market for joint trading of energy and uncertainty. *IEEE Transactions on Smart Grid*, 2019. doi: 10.1109/TSG.2019.2933574.
- [351] Su Nguyen, Wei Peng, Peter Sokolowski, Damminda Alahakoon, and Xinghuo Yu. Optimizing rooftop photovoltaic distributed generation with battery

- storage for peer-to-peer energy trading. *Applied energy*, 228:2567–2580, 2018. ISSN 0306-2619.
- [352] Jason Holland. Global seafood trade to increase, but growth rates will slow, 1 May 2019 2019. URL <https://www.seafoodsource.com/news/supply-trade/global-seafood-trade-to-increase-but-growth-rates-will-slow>.
- [353] Food FAO. Agriculture organization, 2014. Livestock Primary. Food and Agriculture Organization of the United Nations, 2016.
- [354] Seafish Processing. Survey of the uk seafood processing industry. Seafish Report, Edinburgh, 2016.
- [355] Kati Koponen Miika Rämä. Energy solutions for namibian fishing industry. Report VTT-R-1990-16, 2016.
- [356] SJ James, MJ Swain, and T Brown. Improving the energy efficiency of foods refrigeration operations. 2008.
- [357] Sayyed Mohammad Sanaei, Takaaki Furubayashi, and Toshihiko Nakata. Assessment of energy utilization in iran’s industrial sector using energy and exergy analysis method. *Applied Thermal Engineering*, 36:472–481, 2012. ISSN 1359-4311.
- [358] Swain M.J. Brown T. Evans J.A. Tassou S.A. & Ge Y.T James, S.J. Improving the energy efficiency of food refrigeration operations. *Proceedings of the Institute of Refrigeration*, 2008-09:5–1–5–8, 2009.
- [359] S Naresh Kumar and Bidisha Chakabarti. Energy and Carbon Footprint of Food Industry, pages 19–44. Springer, 2019.
- [360] Jihoon Lee, Taeho Kim, Harald Ellingsen, Erik Skontorp Hognes, and Bokyu Hwang. Energy consumption and greenhouse gas emission of korean off-shore fisheries. *Journal of Ocean University of China*, 17(3):675–682, 2018. ISSN 1672-5182.

- [361] Michele Acciaro, Hilda Ghiara, and Maria Inés Cusano. Energy management in seaports: A new role for port authorities. *Energy Policy*, 71:4–12, 2014. ISSN 0301-4215.
- [362] Sahar Azarkamand, Chris Wooldridge, and RM Darbra. Review of initiatives and methodologies to reduce co2 emissions and climate change effects in ports. *International Journal of Environmental Research and Public Health*, 17(11):3858, 2020.
- [363] Sukhjit Singh and Bhaskar Sengupta. Sustainable maritime transport and maritime informatics. pages 81–95, 2020.
- [364] Yusuf Bicer and Ibrahim Dincer. Clean fuel options with hydrogen for sea transportation: a life cycle approach. *International Journal of Hydrogen Energy*, 43(2):1179–1193, 2018.
- [365] Maryam Mohamed Kidere. Analytical assessment of port energy efficiency and management.: a case study of the kenya ports authority. 2017.
- [366] Ralph K Rosenbaum, Michael Z Hauschild, Anne-Marie Boulay, Peter Fantke, Alexis Laurent, Montserrat Núñez, and Marisa Vieira. Life cycle impact assessment. In *Life cycle assessment*, pages 167–270. Springer, 2018.
- [367] Thomas H Beach, Yacine Rezgui, Haijiang Li, and Tala Kasim. A rule-based semantic approach for automated regulatory compliance in the construction sector. *Expert Systems with Applications*, 42(12):5219–5231, 2015.
- [368] Peter Beaumont. Cybersecurity risks and automated maritime container terminals in the age of 4ir. In *Handbook of Research on Information and Cyber Security in the Fourth Industrial Revolution*, pages 497–516. IGI Global, 2018.
- [369] S Jones. Addressing cyber security risks at ports and terminals. *Port Technology International Journal*, 62, 2015.
- [370] Gregory C Wilshusen. Maritime critical infrastructure protection: Dhs needs to enhance efforts to address port cybersecurity. Technical report, 2015.



- [371] Berk Celik, Robin Roche, David Bouquain, and Abdellatif Miraoui. Decentralized neighborhood energy management with coordinated smart home energy sharing. *IEEE Transactions on Smart Grid*, 9(6):6387–6397, 2017. ISSN 1949-3053.
- [372] Ateyah Alzahrani, Ioan Petri, Yacine Rezgui, and Ali Ghoroghi. Decarbonisation of seaports: A review and directions for future research. *Energy Strategy Reviews*, 38:100727, 2021.
- [373] B. A. Lehaney. “methodology”: An analysis of its meaning and use. *Work Study*, 43(3):5–8, 1994. ISSN 0043-8022. doi: 10.1108/00438029410058268. URL <https://doi.org/10.1108/00438029410058268>.
- [374] Alexander M Novikov and Dmitry A Novikov. *Research methodology: From philosophy of science to research design*. CRC Press, 2013. ISBN 042921264X.
- [375] Merriam-Webster Dictionary. Merriam-webster. On-line at <http://www.mw.com/home.htm>, 2002.
- [376] Aleksandras Melnikovas. Towards an explicit research methodology: Adapting research onion model for futures studies. *Journal of Futures Studies*, 23(2):29–44, 2018.
- [377] Arunaditya Sahay. Peeling saunder’s research onion. *Research Gate, Art*, pages 1–5, 2016.
- [378] Mark Saunders, PHILIP Lewis, and ADRIAN Thornhill. *Research methods. Business Students 4th edition* Pearson Education Limited, England, 2007.
- [379] Alice Goodenough and Sue Waite. *Real world research: a resource for users of social research methods in applied settings*, 2012.
- [380] Alan Bryman. Paradigm peace and the implications for quality. *International journal of social research methodology*, 9(2):111–126, 2006. ISSN 1364-5579.

- [381] Alan Bryman. Barriers to integrating quantitative and qualitative research. *Journal of mixed methods research*, 1(1):8–22, 2007. ISSN 1558-6898.
- [382] Dilanthi Amaratunga, David Baldry, Marjan Sarshar, and Rita Newton. Quantitative and qualitative research in the built environment: application of “mixed” research approach. *Work study*, 51(1):17–31, 2002. ISSN 0043-8022.
- [383] Petter Solding. Increased energy efficiency in manufacturing systems using discrete event simulation. 2008.
- [384] Gracia Buiza, Sara Cepolina, Aleksandar Dobrijevic, M del Mar Cerbán, Olivera Djordjevic, and Cristina González. Current situation of the mediterranean container ports regarding the operational, energy and environment areas. In *Industrial Engineering and Systems Management (IESM), 2015 International Conference on*, pages 530–536. IEEE. ISBN 2960053265.
- [385] Giuseppe Parise, Luigi Parise, Luigi Martirano, Peniamin Ben Chavdarian, Chun-Lien Su, and Andrea Ferrante. Wise port and business energy management: port facilities, electrical power distribution. *IEEE Transactions on Industry Applications*, 52(1):18–24, 2016. ISSN 0093-9994.
- [386] Port of Milford Haven. Energy, renewables & engineering, 2019. URL <https://www.mhpa.co.uk/>.
- [387] Peter G Hamel. *In-Flight Simulators and Fly-by-Wire/Light Demonstrators: A Historical Account of International Aeronautical Research*. Springer, 2017. ISBN 3319539973.
- [388] Welsh Government. Energy generation in wales. Report, 2019 2018.
- [389] Xiufeng Pang, Prajesh Bhattacharya, Zheng O’Neill, Philip Haves, Michael Wetter, and Trevor Bailey. Real-time building energy simulation using energyplus and the building controls virtual test bed. In *Proceeding of the 12th IBPSA Conference*, pages 2890–2896, 2011.
- [390] Application Guide. Guide for using energyplus with external interface (s). US Department of Energy, 2011.

- [391] KL Shi, TF Chan, YK Wong, and Siu Lau Ho. Modelling and simulation of the three-phase induction motor using simulink. *International journal of electrical engineering education*, 36(2):163–172, 1999.
- [392] G Bhuvaneswari and R Annamalai. Development of a solar cell model in matlab for pv based generation system. In *2011 Annual IEEE India Conference*, pages 1–5. IEEE, 2011.
- [393] Ali Keyhani. *Design of smart power grid renewable energy systems*. John Wiley & Sons, 2016.
- [394]
- [395] Yacine Rezgui and John Miles. Exploring the potential of sme alliances in the construction sector. *Journal of Construction Engineering and Management*, 136(5):558–567, 2010.
- [396] Jim McDonald. Adaptive intelligent power systems: Active distribution networks. *Energy Policy*, 36(12):4346–4351, 2008. ISSN 0301-4215.
- [397] ALSNOSY Balbaa and NOHA H El-Amari. Green energy seaport suggestion for sustainable development in damietta port, egypt. *WIT Trans. Ecol. Environ*, 214:67–77, 2017.
- [398] Pablo Fernández, José Miguel Santana, Sebastián Ortega, Agustín Trujillo, José Pablo Suárez, Conrado Domínguez, Jaisiel Santana, and Alejandro Sánchez. Smartport: a platform for sensor data monitoring in a seaport based on fiware. *Sensors*, 16(3):417, 2016.
- [399] M Ferry. Comparative study of hybrid catamaran versus diesel monohull boat as ferry for short distance routes. *The Indonesian Journal of Naval Architecture*, 1(1), 2013. ISSN 2301-847X.
- [400] NAS Salleh and WMW Muda. Techno-economic and sensitivity analysis for grid-connected renewable energy electric boat charging station in terengganu. In *MATEC Web of Conferences*, volume 90, page 01016. EDP Sciences. ISBN 2261-236X.

- [401] Shigeyuki Minami, Toshiki Hanada, Nakaba Matsuda, Kyoji Ishizu, Junya Nishi, and Takuma Fujiwara. Performance of a newly developed plug-in hybrid boat. *Journal of Asian Electric Vehicles*, 11(2):1653–1657, 2013. ISSN 1348-3927.
- [402] Vítor Duarte Fernandes Monteiro, João C Ferreira, and João L Afonso. Smart battery charger for electric mobility in smart grids. In *1st International Conference on Smart Grids and Green IT Systems*, pages 1–6. ISBN 9898565098.
- [403] ZiChong Zhang, HongBin Wang, Yu Qin, ChunHui Gu, DaPeng Chen, and Kuang Yin. A optimization strategy of microgrid energy market based on scenario method. In *2019 IEEE 3rd Information Technology, Networking, Electronic and Automation Control Conference (ITNEC)*, pages 1335–1338. IEEE, 2019.
- [404] Xin Song and Jiayu Qu. An improved real-time pricing algorithm based on utility maximization for smart grid. In *Proceeding of the 11th World Congress on Intelligent Control and Automation*, pages 2509–2513. IEEE, 2014.
- [405] Hadis Pourasghar Khomami and Mohammad Hossein Javidi. Energy management of smart microgrid in presence of renewable energy sources based on real-time pricing. In *2014 Smart Grid Conference (SGC)*, pages 1–6. IEEE, 2014.
- [406] Nilesh R Kumbhar and Rahul R Joshi. An industrial energy auditing: basic approach. *International Journal of Modern Engineering Research*, 2(1):313–315, 2012.
- [407] Ateyah Alzahrani, Ioan Petri, and Yacine Rezgui. Analysis and simulation of smart energy clusters and energy value chain for fish processing industries. *Energy Reports*, 6:534–540, 2020.
- [408] G Allesina, E Mussatti, F Ferrari, and A Muscio. A calibration methodology for building dynamic models based on data collected through survey and billings. *Energy and Buildings*, 158:406–416, 2018.

- [409] Yuan Hong, Sanjay Goel, Haibing Lu, and Shengbin Wang. Discovering energy communities for microgrids on the power grid. In Smart Grid Communications (SmartGridComm), 2017 IEEE International Conference on, pages 64–70. IEEE. ISBN 1538609436.
- [410] Abiodun E Onile, Ram Machlev, Eduard Petlenkov, Yoash Levron, and Juri Belikov. Uses of the digital twins concept for energy services, intelligent recommendation systems, and demand side management: A review. *Energy Reports*, 7:997–1015, 2021.

# APPENDIX A

## Appendix

---

Questions for the staff in Milford haven port related to pack way building in MHP

➤ Questions for fishers and the staff

1. When do fishers start use pack way building every day?
2. What type of equipment's that fisher use daily in Pack way building?
3. How long that fishers stay in pack way building every day? Why?
4. Does fishers come to the building in two separate shifts?
5. What is the hot season for fishers to work annually?
6. To what extend fishers are aware of power conservation in the building?
7. Do the fishers has the ability to contribute for energy saving approach in MHP?
8. How fishers can be an effective to reduce power consumption in the building?
9. What fisher's ideas to optimize power consumption in the building?

➤ Questions for the electrician staff

1. What is the most power consumption equipment in the pack way building?
2. What is the department plan maintenance for equipment? Is it regularly?
3. How do you calculate the power efficiency for the equipment?
4. Do you think that power produced from PV panel can meet the demand of power consumption in pack way building?
5. From your technical experience how could optimise power consumption in the building?
6. To what extend that decarbonisation of the building will protect environment?
7. How could we reduce power consumption for cold storage unit?
8. How could we reduce power consumption for flake ice unit?
9. Do you usually check the calibration of smart meter in the Pack way building?

➤ Questions related to the equipment in Pack way building

- flake Ice
  - 1- How long flake ice machine work on every day?
  - 2- How much the power capacity of flake ice?
  - 3- Is there an accurate reading of the daily quantity of ice that produce?
- Cold Storage
  - 1- Does cold storage operation (on) for 24 hours a day?
  - 2- Which period in day fishers use cold storage continuously? (morning / afternoon/ night)  
What was the total power consumption of cold storage in 2016?
  - 3- What is the most power consumption part in cold storage?
  - 4- Is there an accurate reading of the daily quantity of ice that fishers use from cold storage?
  - 5- Is it possible to make cold storage works as (work based order)?
- Box washing machine
  - 1- How usually fishers use box washing machine? ( daily- weekly- monthly)
  - 2- What is the most power consumption part in box washing machine?
- Lighting system
  - 1- Which period of day that fishers use lighting system?
  - 2- How much the total power consumption of lighting system?

Data available from Savenergy online related to packaway building

Type of data available	Units
Annual profile of electricity consumption by daylight in two shifts ( daylight/ night)	kWh/ month/year
Annual profile of electricity generation from PV and solar irradiance	$w/m^2$
Monthly heating degree days	°C
Monthly cooling degree days	°C
Multi utility summary ( electricity – gas – water )	kWh – kWh - $m^3$
Annual energy consumption	kWh
Annual CO2 emissions	Kg CO2

Data available from Savenergy online related to Flake Ice PV generation

Type of data available	Units
Annual profile of electricity consumption by daylight in two shifts ( daylight/ night)	kWh/ month/year
Daily power consumption ( every 30 min )	$w/m^2$
Daily power generation ( every 30 min )	$w/m^2$
Monthly data of power consumption and generation	kWh/ month

Data available from Savenergy online related to cold room PV generation

Type of data available	Units
Annual profile of electricity consumption by daylight in two shifts ( daylight/ night)	kWh/ month/year
Daily power consumption ( every 30 min )	$w/m^2$
Daily power generation ( every 30 min )	$w/m^2$
Monthly data of power consumption and generation	kWh/ month



*The main appliances in Pack way building in Milford haven port*

<i>Appliance</i>	<i>How it is works</i>	<i>Optimization solution</i>
1- Box washing machine	The box washing machine has the power capacity 50 Kw. And it works only when the fishers want to clean the boxes after use it which is very short time a day.	<ul style="list-style-type: none"> <li>- Scheduling is the useful solution in order to optimize the power consumption in pack way.</li> </ul>
2- Lighting system	Lighting system in this building is about 17 double tubes lighting which is 25 W each. And according to staff that fishers doesn't use it in day time due to day light accessibility to the building from the ceiling and the might use it in the night which is very short period based on the system	<ul style="list-style-type: none"> <li>- Change double tube lambs by LED which is more efficient.</li> <li>- Install sensors in the main hall which will help to save energy.</li> </ul>
3- Flake ice	Flake ice consumed about 32 Kw of power and it produce the ice for fishing purposes, it produces the ice as small pieces and then move it to the cold storage.	<ul style="list-style-type: none"> <li>- Based on the scheme of flake ice, we might add a special device known as variable speed drive (VSD) which will help to reduce power consumption for the machine.*</li> <li>- Scheduling could be effective based on an accurate data of fisher's period to collect the ice.</li> </ul>
4- Cold storage	Cold storage is under the operation all the time to meet the demand for fishers with the quantity they need. Also, it consider the most power consumed device in the building that is because of cold temperature need to be -5 degree.	<ul style="list-style-type: none"> <li>- Based on cold storage cycle, an optimization could be done based on the type of device such as (air flow pattern, variable speed drive, minimizing heat transmission load and create control system). **</li> <li>- Scheduling could be effective based on an accurate data of fisher's period to collect the ice</li> </ul>

Data available from Savenergy online related to packaway building

Type of data available	Units
Annual profile of electricity consumption by daylight in two shifts ( daylight/ night)	kWh/ month/year
Annual profile of electricity generation from PV and solar irradiance	$w/m^2$
Monthly heating degree days	°C
Monthly cooling degree days	°C
Multi utility summary ( electricity – gas – water )	kWh – kWh - $m^3$
Annual energy consumption	kWh
Annual CO2 emissions	Kg CO2

Data available from Savenergy online related to Flake Ice PV generation

Type of data available	Units
Annual profile of electricity consumption by daylight in two shifts ( daylight/ night)	kWh/ month/year
Daily power consumption ( every 30 min )	$w/m^2$
Daily power generation ( every 30 min )	$w/m^2$
Monthly data of power consumption and generation	kWh/ month

Data available from Savenergy online related to cold room PV generation

Type of data available	Units
Annual profile of electricity consumption by daylight in two shifts ( daylight/ night)	kWh/ month/year
Daily power consumption ( every 30 min )	$w/m^2$
Daily power generation ( every 30 min )	$w/m^2$
Monthly data of power consumption and generation	kWh/ month

---

```

1
2 %% Initialize Data %%
3 clear
4 load("V2G");
5 load('PC_1.mat')
6 load('PC_7.mat')
7 load('PG_1.mat')
8 load('Date_Jan_30.mat')
9 load('Price_Buying.mat')
10 load('Price_Selling.mat')
11 %date = cell2mat(Date_Sec )
12 %x= datetime(date,'InputFormat','yyyy-mm-dd HH:MM:SS')
13 To_seconds = 3600;
14 solar_generation = PG_1*1000;
15 consumption_total = PC_1*1000;
16 consumption_total_2 = PC_7*1000;
17 solar = timeseries(solar_generation);
18 consumption = timeseries(consumption_total);
19 consumption_2 = timeseries(consumption_total_2);
20 price_buying = timeseries(Price_Buying);
21 price_selling= timeseries(Price_Selling);
22 load_pattern.time=consumption.Time; % Correcting data time
23 load_pattern.signals.values=[consumption_total , 0*consumption_total];
24 load_pattern.signals.dimensions=2;
25 isOC = 50;
26 sec_per_step = 1;
27 steps_per_hr = 3600;
28 price_max_buying =1;% Above this price secondary battery will discharge
29 price_min_selling=7; % below this price secondary battery will charge
30 hold on;
31 plot(PC_1);
32 plot(PC_7);

```

