

An Efficient and Resilient Digital-twin Communication Framework for Smart Bridge Structural Survey and Maintenance

Gao Y., Li H.*; Xiong G.
Cardiff University, UK
lih@cardiff.ac.uk

Abstract. A bridge digital twin (DT) is expected to be updated in near real time during inspection and monitoring but is usually subject to massive heterogeneous data and communication constraints. This work proposes an efficient framework for a bridge DT with decreased communication complexity to achieve updates synchronously and provide feedback to the physical bridge in time. The integrated edge computing and non-cellular long-distance wireless communication enable DT resilience when cloud servers become unresponsive due to the loss of internet connection. This framework is validated by different scenarios for DTs in support of bridge inspection and monitoring. It is demonstrated that the framework can enable dynamic interaction between on-site inspection and online bridge DT during the survey as well as knowledge transfer among different sectors in time. It can also support local decision-making on a single bridge as well as regional dynamic coordination for multiple bridges without cloud-server involvement.

1. Introduction

Bridges serve a critical role in transport systems, and their failure will result in traffic disruption, economic loss, and even severe casualties. According to the ASCE report in 2021, 6154 or 7.5% of the nation's bridges are considered structurally deficient in the US, and unfortunately 178 million trips are taken across these bridges every day (ASCE, 2021). Therefore, regular inspections and effective monitoring of bridges are mandatory in many countries. A bridge digital twin (DT) is a promising tool for bridge management and predictive maintenance (PdM), which is expected to be updated in near real time as new data is collected, as well as provide feedback to the physical bridge for assessment and prediction in time (Ye *et al.*, 2019). For example, bridge DTs can release early warnings (load restriction, closure, etc.) for bridge capability based on real-time simulation, can provide dynamic responses based on monitoring and prediction with real-time data, and can enhance the efficiency of collaboration among different stakeholders. However, data transmission in real time (or near real time) has not been well addressed under situations with massive heterogeneous data and various communication constraints (low data rates, small payload size, limited duty cycle, etc.), especially for the bridges in remote areas without a stable cellular network. Moreover, the cloud-based DT services will become unavailable when the cloud server is unresponsive, e.g., the internet connection is lost. This brings in potential risks for both physical bridges and people on the site when an emergency has been predicted to take place.

This paper aims to propose an efficient and resilient framework for a bridge DT via edge computing and non-cellular long-distance wireless communication to tackle the issues stated above. In this framework, massive heterogeneous data generated from drone inspection and real-time structural health monitoring (SHM) are interpreted into the information required for relevant DT services (e.g., visualization, structural analysis, prediction) in reduced forms (e.g., semantic information, geometric coordinates, binary profiles), thus decreasing communication complexity and cloud-processing burden significantly and achieving DT updates in near real time. Then by fusing the transmitted information with multi-source data, information and knowledge (e.g., life-cycle information, inventory, traffic, weather), the DT can provide holistic feedback (e.g., early warnings, inspection advice, optimized maintenance planning) to the

physical bridge in time based on AI and big-data analysis. Hence, this framework can enable dynamic interaction between on-site inspection and online bridge DT services, information exchange across different stakeholders, as well as knowledge transfer among different sectors, e.g., the knowledge gap between local inspectors and remote structural specialists (or drone inspection suppliers and bridge maintenance contractors). In terms of resilience, this framework can support local decision-making on a single bridge based on SHM, e.g., load restriction, as well as regional dynamic coordination for multiple bridges through non-cellular long-distance wireless communication without cloud-server involvement, e.g., decentralized dynamic evacuation.

This framework is validated with different scenarios for DTs in support of bridge inspection and monitoring. It is demonstrated that the framework can enable effective updating and feedback between a physical bridge and its DT in near real time. The framework is suitable for long-distance wireless communication with low data rates (e.g., LoRa), and exhibits fault tolerance by operating autonomously at a local and regional level when the cloud server is unresponsive due to the loss of internet connection.

2. Related Work

2.1 Bridge Digital Twin

A bridge DT is defined as a virtual representation of a physical bridge, which updates in near real time as new data is collected, provides feedback to the physical bridge and performs ‘what-if’ scenarios for assessing asset risks and predicting asset performance (Ye *et al.*, 2019). Bridge DT models can be created by building information modelling (BIM), physics-based approach (finite element modelling), data-driven approach (statistical modelling) and data-centric engineering approach (hybrid modelling), with the key features, including digital replica (geometry and others); data composition; bidirectional connection (update and feedback) in near real time; the life-cycle span of a physical bridge; common data environment (CDE); visualization; simulation; learning from real measurement data (Ye *et al.*, 2019). Dang and Shim *et al.* (Dang *et al.*, 2018) developed a bridge maintenance system based on digital-twin models, including 3D geometry models and structural analysis models. The structural monitoring data (strain, displacement, loading, etc.) and the environmental data (temperature, wind, etc.) during operation are collected to provide essential information for bridge condition assessment and prediction. Structure deterioration is linked to the elements of the bridge, changing the structural parameters for analysis. Then, the bridge DT can be updated with each inspection and online monitoring to support decision-making for bridge maintenance. Dang *et al.* (Dang, Tatipamula and Nguyen, 2021) proposed a cloud-based DT framework (cDTSHM) for real-time SHM and proactive maintenance of bridges, which was demonstrated via both model and real bridges using deep learning for damage detection with high accuracy, but it requires advanced communication such as 5G, which brings in high service costs (infrastructure building, data charges, etc.) and is not suitable for bridges in remote areas without stable cellular networks. Meanwhile, when cloud servers are unresponsive, e.g., the internet connection breaks down, the cloud-based DT services such as early warnings will become unavailable. Moreover, from the practitioners’ view in the UK, a major gap between academic research and industrial practice towards applications of the digital twin supporting bridge O&M is the difficulty to keep the bridge DT updated in routine practice (Ye *et al.*, 2021).

2.2 IoT Wireless Communication

Although wired networks are generally faster than wireless, the latter enables monitoring of remote bridges which used to be inaccessible by cables. The capability of different IoT wireless communication technologies is indicated in Figure 1 (Mekki *et al.*, 2019; Foubert and Mitton, 2020). Short-range wireless communication (e.g., WIFI, Zigbee) is suitable for data acquisition on site. Commercial cellular networks work at a medium range with higher service costs such as data charges. Meanwhile, with the rise of frequency bands, bandwidth and data rates increase, while ratio wavelength and coverage range decrease, i.e., distance $3G > 4G > 5G$. For long-range wireless communication, NB-IoT and LTE-M rely on existing cellular networks, while the others are non-cellular networks working on unlicensed ISM bands, which are suitable for remote areas where cellular communication is not available. However, long-range wireless communication technologies usually have limited data rates, e.g., NB-IoT (up to 158.5kbps), LoRa (sub-GHz, up to 50kbps), as well as limited payload size and a constrained duty cycle, e.g., LoRa has up to 250-byte payload size and 1% duty cycle. This results in the difficulty to update the bridge DT synchronously with massive heterogeneous data through long-range wireless communication.

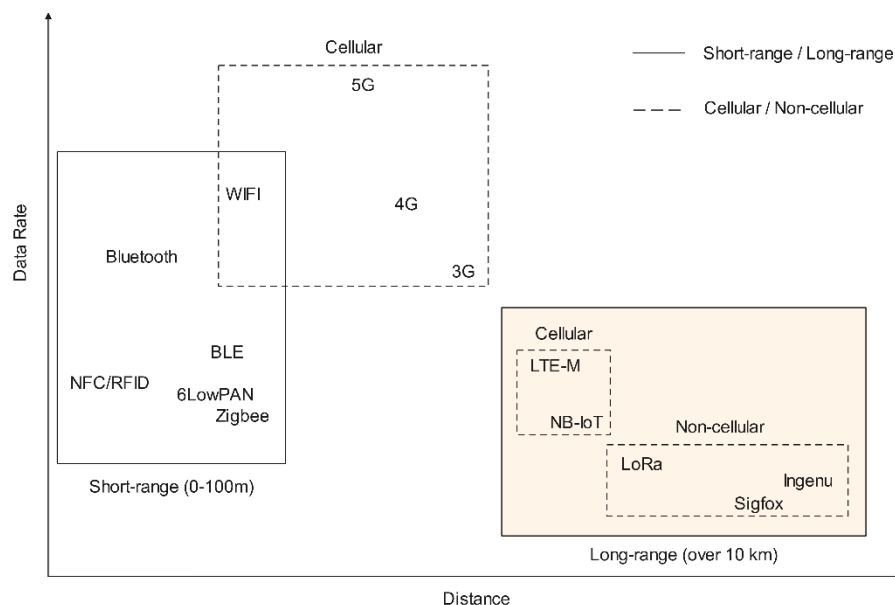

Figure 1: Capability of IoT wireless communication technologies (data rate vs distance).

2.3 Bridge Inspection and Monitoring

Drones are taken as a game-changer in bridge inspection, which can get less limited access as well as better angles to the areas difficult or dangerous for people to reach. Drone inspection for bridges is taken by payloads with fast data collection, e.g., thousands of points per hour for photogrammetry, and millions of points per hour for Lidar. Many approaches have been developed for drone inspection to detect surface deficiency automatically (e.g., cracking). Xu *et al.* proposed an end-to-end crack detection model for bridges based on a convolutional neural network (CNN), achieving a detection accuracy of 96.37% without pre-training (Xu *et al.*, 2019); Dorafshan *et al.* proposed an automatic crack identification and segmentation on a concrete surface with Otsu's thresholding and morphological operations (Dorafshan and Qi, 2016). Furthermore, Kim *et al.* developed a system for crack identification and measurement, equipped with a pre-calibrated camera and an ultrasonic distance sensor to obtain crack images and the distance from the camera to the target surface, achieving successful measurement for the cracks (thicker than 0.1mm) with the maximum length estimation error of 7.3% (Kim *et al.*,

2017). Moreover, drones can be located with geo-coordinates (latitude, longitude and height) through differential positioning at centimetre-level accuracy (Bisnath, 2020), e.g., real-time kinematic (RTK), post-processing kinematic (PPK).

Bridge SHM uses a sensor network attached to the bridge to acquire measurements in real time, including structural response (acceleration, strain, displacement, inclination, etc.) and ambient parameters (loading, temperature, wind, flood, etc.), and then employ data-driven approaches to assess bridge structural integrity, e.g., damage detection, remaining-useful-life prediction. The approaches can be indicator-based (e.g., natural frequencies, mode shapes) or direct use of data in the time and/or frequency domain. Kim et al. proposed a damage indicator with the vehicle-induced vibration from a set of multivariate autoregressive models in the case study of the ADA bridge with different artificial damages (Kim *et al.*, 2021). Neves et al. employed an artificial neural network (ANN) with the train-induced acceleration data to identify the structure health conditions of the KW51 railway bridge (Neves, González and Karoumi, 2021). Sajedi and Liang proposed a framework for structural damage diagnosis based on a fully convolutional encoder-decoder architecture using the vibration signals from a grid sensor network, which can localize damages and distinguish multiple damage mechanisms with reliable generalization capacities (Sajedi and Liang, 2020).

3. Methodology

Drone inspection and real-time SHM have been accepted as effective approaches to indicate structural defects before maintenance. Current drone inspection for bridges is usually project-based and updated asynchronously, which heavily depends on the expertise of inspectors in situ. Meanwhile, the huge amount of data from real-time SHM is also arduous for transmission, especially when wireless networks are required. Although pre-processing (e.g., downsampling, feature extraction) can decrease communication complexity to a degree, it will result in a loss of high-frequency information, and local services will become unavailable when the cloud server is unresponsive. Moreover, it is difficult to employ the approaches with direct use of data on the cloud, e.g., deep learning, which requires massive data transferred to the cloud. Advanced communication such as 5G/6G is supposed to solve these problems, but it also brings in high infrastructure investment and service costs. Therefore, as communication time is calculated with equation 1, instead of increasing transmission capability, if the massive heterogeneous data can be interpreted into critical information in reduced forms via edge computing, it can decrease communication complexity and cloud-processing burden significantly. The derived transmittable information depends on domain knowledge and DT services, e.g., damage mechanism, location and extent for structural assessment and prediction. Many technologies can play a significant role in this procedure, e.g., machine learning, knowledge representation, computer vision and SLAM (simultaneous localization and mapping). Meanwhile, the information in transmission should be as precise as possible, such as the damage profile, which means the loss before and during transmission should be minimized, e.g., the compression loss. Then the derived information can be updated in the bridge DT in near real time, and fused with multi-source data and information, e.g., life-cycle information, inventory, traffic, as well as domain-specialist knowledge, such as maintenance knowledge from similar bridges, to provide holistic feedback to the physical bridge in time.

$$\text{Communication Time} = \text{Complexity}/\text{Bandwidth} + \text{Latency} \quad (1)$$

This strategy becomes available with the development of edge devices, e.g., MCU (microcontroller unit), SBC (single-board computer), FPGA (field-programmable gate array), as well as AI and deep learning development at the edge, such as edge AI and tinyML. The

edge-based processing in the strategy does not only generate the required transmittable information with low complexity but also supports decision-making locally and triggers autonomous responses on the bridge site via the control system such as actuators. The bidirectional data flow is shown in Figure 2. Furthermore, with non-cellular long-distance wireless communication such as LoRa, the strategy can enable regional dynamic coordination for multiple bridges (as well as other infrastructures such as tunnels) without cloud-server involvement via data transmission between adjacent edge devices such as sensor nodes and gateways. This is suitable for decentralized dynamic evacuation.

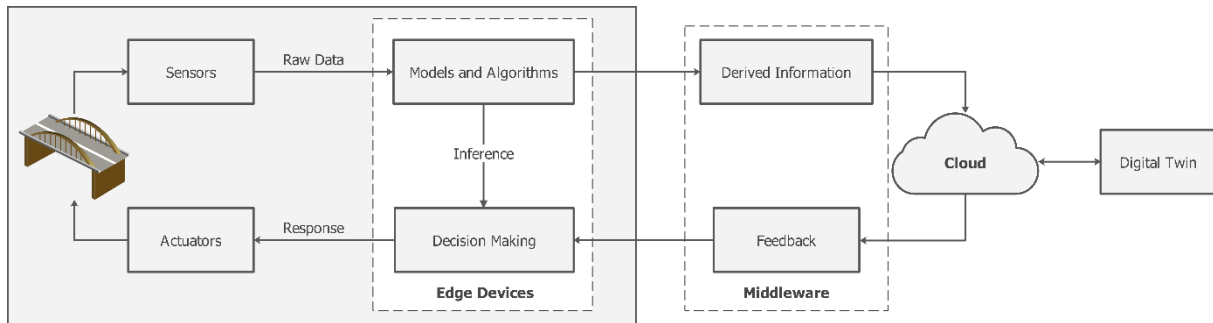

Figure 2: Proposed strategy and data flow for a bridge DT.

4. Framework Development

The framework is developed for a bridge DT in support of both drone-enabled inspection and real-time SHM. It aims to use the derived information with low communication complexity from edge computing to overcome communication constraints in bandwidth, achieving synchronous updates in the bridge DT, as well as provide feedback to the physical bridge based on DT services in near real time. In the drone inspection, defect detection, localization and quantification can be taken on board or a control station and then transmitted in reduced forms to gateways via long-distance communication. The detection of defects (e.g., cracking) can be carried out by object detection such as YOLO. Defect quantification including dimensions, areas, etc., can be taken based on semantic segmentation by image processing or deep learning (e.g., DeepLab). An approach based on PPK is developed to provide defect localization in the bridge coordinate system, as indicated in Figure 3 and equation 2. The coordinates can be further linked to bridge elements based on geometric information. The crack direction (such as latitudinal or longitudinal) can be determined by drone position and camera angle. Given situations without stable GNSS signals, e.g., underneath a bridge, SLAM based on IMUs (inertial measurement units), and cameras (or laser scanners) can help to improve accuracy.

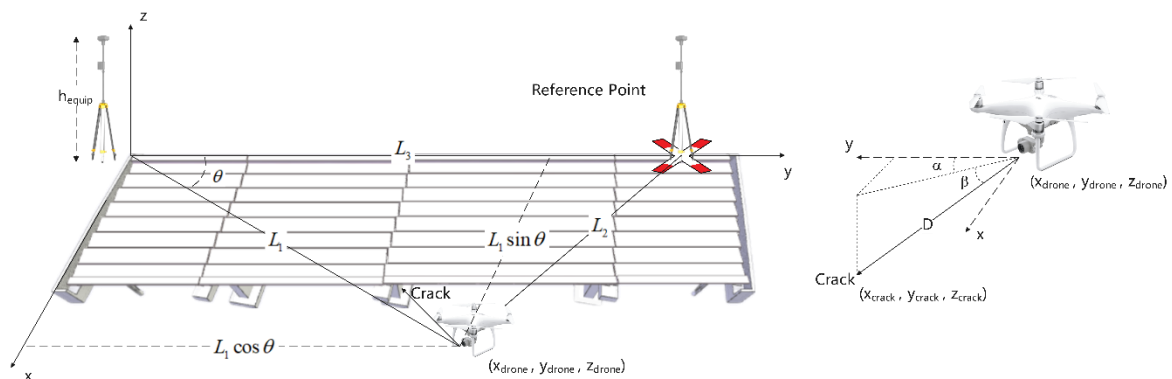

Figure 3: Defect localisation in the bridge coordinate system.

$$\begin{aligned}
 L_1 &= R\sqrt{(\phi_2 - \phi_1)^2 + (\lambda_2 - \lambda_1)^2} \\
 x_{crack} &= L_1 \sin \theta - D \cos \beta \cos \alpha \\
 y_{crack} &= L_1 \cos \theta - D \cos \beta \sin \alpha \\
 z_{crack} &= H_{drone} - H_{base} + h_{equip} - D \sin \beta
 \end{aligned} \tag{2}$$

Note: ϕ_1, ϕ_2 – base and drone latitude; λ_1, λ_2 – base and drone longitude; R is earth's radius; H_{drone} – drone height; H_{base} – top receiver height; h_{equip} – equipment height.

In the real-time SHM, data collection to embedded systems on the site can be wired (e.g., fieldbus) or wireless (e.g., WIFI). Data transmission from embedded systems to gateways is based on a long-distance wireless network such as NB-IoT or LoRa. The algorithms and AI models are deployed on embedded systems in the framework, which can also support local decision-making. In addition, there is non-cellular long-distance wireless communication (e.g., LoRa) between adjacent gateways (or embedded systems), which can enable autonomous coordination for multiple bridges. This non-cellular network is designed as a supplementary approach to cloud-based communication, starting to work when the cloud server becomes unavailable, e.g., the internet connection is lost. Then the interpreted information required for DT services from both scenarios with low complexity can be transmitted via the internet to the cloud server (MQTT broker) and published to the DT applications (MQTT client) through the MQTT protocol, while the feedback based on DT services can be published to the broker and transmitted to the physical bridge and local inspectors in time, as shown in Figure 4.

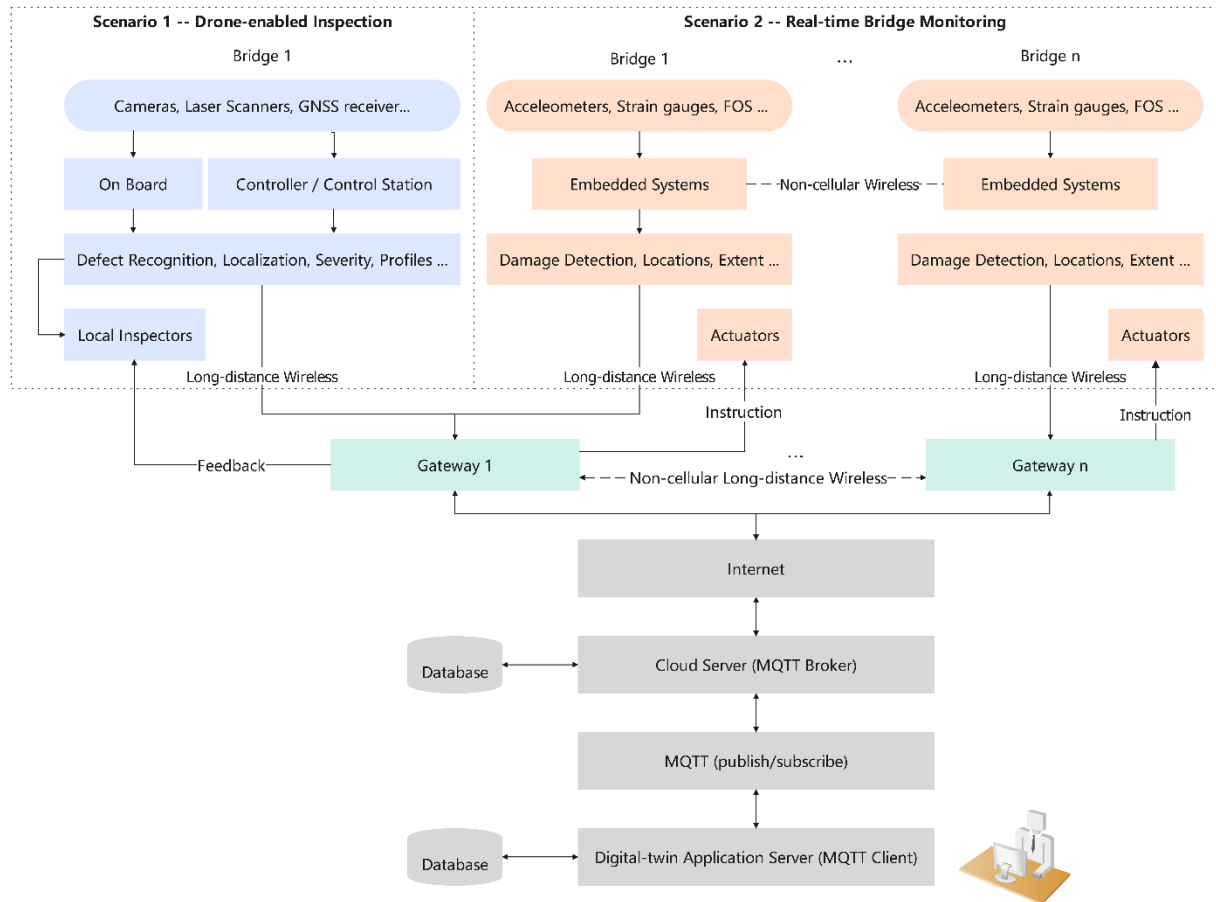

Figure 4: Proposed data transmission framework for a bridge DT.

5. Framework Validation

Three scenarios for DTs in support of bridge inspection and monitoring are adopted for framework validation: 1) drone-enabled crack inspection; 2) vibration-based damage detection; 3) decentralized dynamic evacuation. A LoRa module (embedded in Arduino MKR WAN 1310) is used for data transmitting (TX) and receiving (RX). The Things Network (TTN) is used as the LoRaWAN network server and MQTT broker. The MQTT clients are created with Eclipse Paho to publish/subscribe messages.

5.1 Scenario 1 – Drone-enabled Crack Inspection

During drone inspection, the images of potential deficiency areas of a bridge are taken by the onboard camera. Here, the images are from the dataset created for automatic bridge crack detection (Xu *et al.*, 2019). A laptop is taken as the control station. Firstly, the crack image is identified with a pre-trained CNN model with an accuracy of 96.05%. Then crack images are segmented with Otsu's thresholding and morphological operations. Moreover, the dimensions (width and length) can be obtained with the spanned pixel number and pixel length (predetermined before the inspection by distances from the camera to a target surface). The crack location and direction can be determined by drone position, camera angle, and the distance from the camera to the surface with the developed approach (as indicated in Figure 3 and equation 2). The crack coordinates can be linked to the bridge element based on geometric information. Moreover, the extracted binary profile is suitable for lossless compression (e.g., PNG) with the run-length encoding (RLE) to minimize image bytes, as shown in Figure 5. Compared to previous image transmission through LoRa (Pham, 2018), this method has less communication complexity with a lossless profile for cracking.

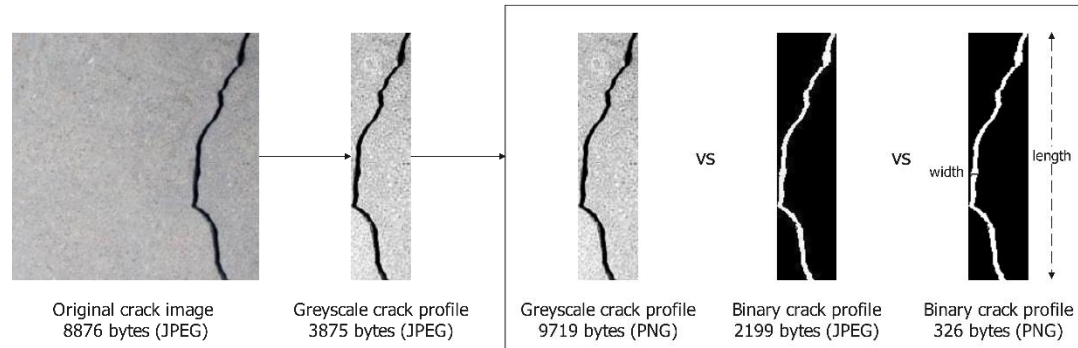

Figure 5: Crack profile segmentation and compression.

The derived defect information can be transmitted through LoRa and MQTT to a web-based bridge DT application. Then the DT can provide feedback based on domain knowledge to local inspectors in time, e.g., more in-depth inspection or even closure, as shown in Figure 6.

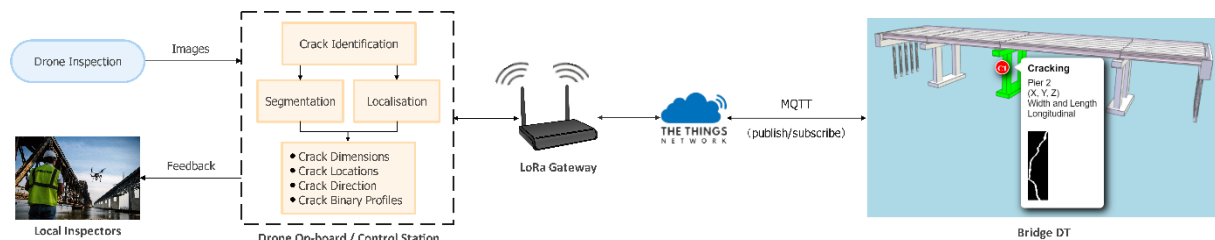

Figure 6: Bridge DT in support of drone inspection with the proposed framework.

5.2 Scenario 2 – Vibration-based Bridge Monitoring

The real-time vibration signals are collected in an embedded system on the bridge. Here, the acceleration data is from a VBM project of the KM51 bridge (Maes and Lombaert, 2021) generated by 6 uniaxial accelerometers before and after maintenance (damaged and healthy conditions respectively). Raspberry Pi 4 (Model B, 8G RAM) is taken as the SBC of the embedded system. The SVM models with statistical features (root mean square, shape factor, kurtosis, skewness, peak, impulse factor, crest factor, clearance factor) and wavelet-packet energy (at level-3 decomposition with sym4 wavelet) respectively are trained on the SBC for pattern recognition, achieving the accuracy of 91.45% and 96.58%. A 1D-CNN with input data (50176×6) from 6 accelerometers is trained on the Google Codelabs with the accuracy of 95.73% and deployed on the SBC. Therefore, both SVM with feature extraction and CNN with direct use of data can make the inference for damage detection based on the embedded system, thus supporting decision-making (such as load restriction) on the bridge site without cloud-server intervention. Then the derived structural health information (e.g., healthy or damaged) is transmitted to a web-based bridge DT application through LoRa and MQTT in near real time (as shown in Figure 7). Moreover, with a grid sensor network and specific algorithms for semantic damage segmentation (Sajedi and Liang, 2020), the derived information including damage mechanisms, locations, extent, etc., can also be transferred to the bridge DT in the same way. Finally, the feedback based on DT services (e.g., structural assessment and prediction) can be provided to the physical bridge reversely in near real time.

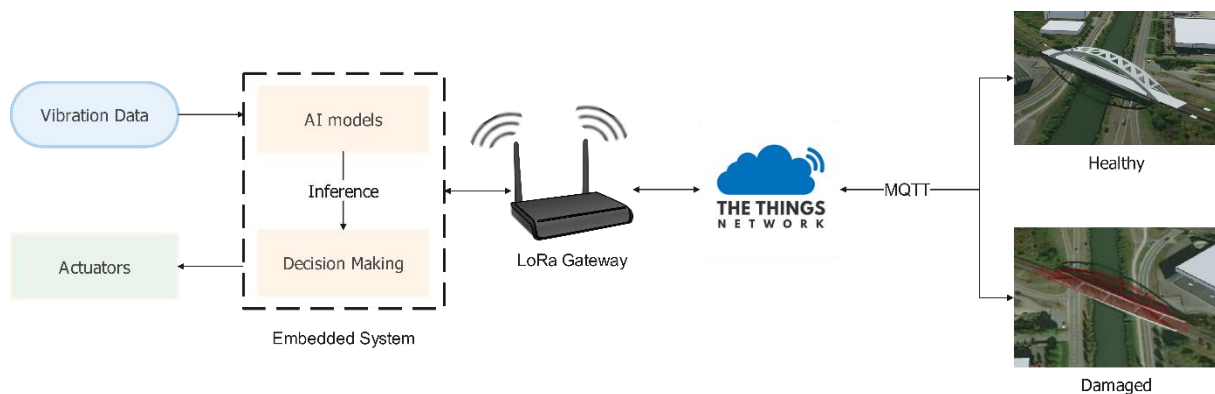

Figure 7: Bridge DT in support of VBM through the proposed framework.

5.3 Scenario 3 – Decentralized Dynamic Evacuation

When the cloud server becomes unresponsive, e.g., the internet connection is lost, the framework will start autonomous coordination for multiple bridges based on a non-cellular long-distance network in response to emergencies, e.g., dynamic evacuation. Here in assumption, an area with 6 bridges is under the threat of flooding and the internet connection is lost. The LoRa sensor node for flood monitoring on each bridge is supposed to be Class B or C and activated by its adjacent LoRa gateway, which is built on a Raspberry Pi. Both gateways have multiple channels, allowing sufficient opportunities to uplink and downlink messages, and can also transmit data between each other through LoRa. The communication topology (left) and bridge network (right) are shown in Figure 8. The dash lines represent the LoRa network; the stars represent the gateways; the squares stand for the bridges; the full lines and the weights are for roads and distances between bridges. People need to transfer from the flooding area (left side of the dashed line) to the safety area (right side).

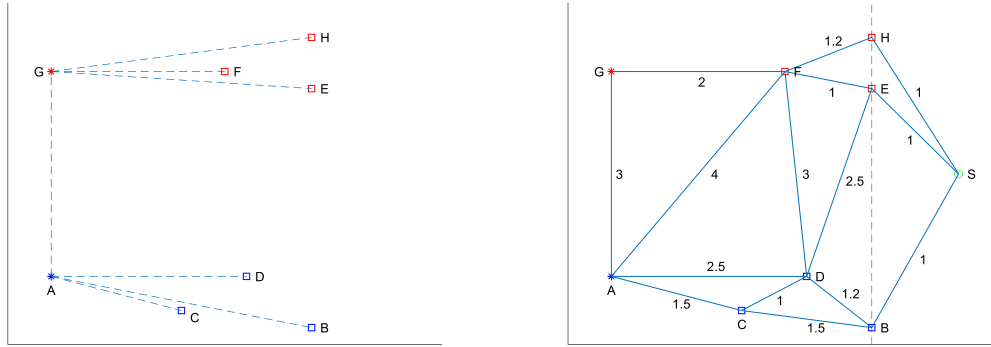

Figure 7: Communication topology (left) and bridge network (right) diagrams for simulation

An open-source LoRa emulator (Al Homssi *et al.*, 2021) is adopted here simulating TX and RX. To simplify the simulation, there are only two bridge conditions (Y – open, N – closed). The evacuation route is only updated as a gateway receives a message that a bridge becomes unavailable (closed), and the affected weights become infinitely great. Therefore, when a bridge is closed, the evacuation routes will be updated via edge computing on the gateways using the Floyd algorithm without cloud-server involvement, and then the results (as shown in Table 1) are downlinked to each node through LoRa.

Table 1: Evacuation routes updated for each node

Nodes	Status / Shrotest Route and Distance	Status / Shrotest Route and Distance
A	Initial / A C B S and 4	BN and EN / A F H S and 6.2
B	Initial / B S and 1	BN and EN / B D F H S and 6.4
C	Initial / C B S and 2.5	BN and EN / C D F H S and 6.2
D	Initial / D B S and 2.2	BN and EN / D F H S and 5.2
E	Initial / E S and 1	BN and EN / E F H S and 3.2
F	Initial / F E S and 2	BN and EN / F H S and 2.2
G	Initial / G F E S and 4	BN and EN / G F H S and 4.2
H	Initial / H S and 1	BN and EN / H S and 1

6. Discussion and Conclusion

This work proposed an efficient and resilient digital-twin communication framework to support smart bridge survey and maintenance. Thanks to decreased communication complexity, the framework can update the bridge DT synchronously during drone inspection and real-time SHM, as well as provide feedback based on DT services to the physical bridge in time. It enables dynamic interaction between on-site inspection and online bridge DT, as well as knowledge transfer among different sectors during the survey. The framework can support decision-making locally for a single bridge as well as dynamic coordination for multiple bridges via a non-cellular long-distance wireless network without cloud-server involvement. It has the potential for automated drone-enabled bridge inspection in remote areas, which can be taken as an alternative to in-person regular inspection. Furthermore, ultra-low-power MCUs (e.g., Arduinos, STM32 microcontrollers) with limited memory and optimised algorithms for tinyML

are expected to be applied in this framework to provide bridge DTs with long-term performance based on batteries under the situation without cable-based power supply.

Acknowledgement

This research is funded by the Cardiff University – China Scholarship Council joint programme.

Reference

- ASCE (2021) Structurally Deficient Bridges | Bridge Infrastructure | ASCE's 2021 Infrastructure Report Card. Available at: <https://infrastructurereportcard.org/cat-item/bridges/>.
- Bisnath, S. (2020) Relative Positioning and Real-Time Kinematic (RTK), Position, Navigation, and Timing Technologies in the 21st Century, 1, pp. 481–502. doi:10.1002/9781119458449.ch19.
- Dang, H.V., Tatipamula, M. and Nguyen, H.X. (2021) Cloud-based Digital Twinning for Structural Health Monitoring Using Deep Learning, *IEEE Transactions on Industrial Informatics*, 18(6), pp. 3820–3830. doi:10.1109/TII.2021.3115119.
- Dang, N., Kang, H., Lon, S. and Shim, C. (2018) 3D digital twin models for bridge maintenance, in *Proceedings of 10th International Conference on Short and Medium Span Bridges*, Quebec city, Quebec, Canada.
- Dorafshan, S. and Qi, X. (2016) Automatic Surface Crack Detection in Concrete Structures Using OTSU Thresholding and Morphological Operations, (August). doi:10.13140/RG.2.2.34024.47363.
- Foubert, B. and Mitton, N. (2020) Long-range wireless radio technologies: A survey, *Future Internet*, 12(1). doi:10.3390/fi12010013.
- Al Homssi, B., Dakic, K., Maselli, S., Wolf, H., Kandeepan, S. and Al-Hourani, A. (2021) IoT Network Design Using Open-Source LoRa Coverage Emulator, *IEEE Access*, 9, pp. 53636–53646. doi:10.1109/ACCESS.2021.3070976.
- Kim, C.-W., Zhang, F.-L., Chang, K.-C., McGetrick, P.J. and Goi, Y. (2021) Ambient and Vehicle-Induced Vibration Data of a Steel Truss Bridge Subject to Artificial Damage, *Journal of Bridge Engineering*, 26(7), pp. 1–9. doi:10.1061/(asce)be.1943-5592.0001730.
- Kim, H., Lee, J., Ahn, E., Cho, S., Shin, M. and Sim, S.H. (2017) Concrete crack identification using a UAV incorporating hybrid image processing, *Sensors (Switzerland)*, 17(9), pp. 1–14. doi:10.3390/s17092052.
- Maes, K. and Lombaert, G. (2021) Monitoring Railway Bridge KW51 Before, During, and After Retrofitting, *Journal of Bridge Engineering*, 26(3), p. 04721001. doi:10.1061/(asce)be.1943-5592.0001668.
- Mekki, K., Bajic, E., Chaxel, F. and Meyer, F. (2019) A comparative study of LPWAN technologies for large-scale IoT deployment, *ICT Express*, 5(1), pp. 1–7. doi:10.1016/j.ict.2017.12.005.
- Neves, A.C., González, I. and Karoumi, R. (2021) A combined model-free Artificial Neural Network-based method with clustering for novelty detection: The case study of the KW51 railway bridge, in *IABSE Conference, Seoul 2020: Risk Intelligence of Infrastructures - Report*, pp. 181–188. doi:10.2749/seoul.2020.181.
- Pham, C. (2018) Robust CSMA for long-range LoRa transmissions with image sensing devices, *IFIP Wireless Days*, 2018-April, pp. 116–122. doi:10.1109/WD.2018.8361706.
- Sajedi, S.O. and Liang, X. (2020) Vibration-based semantic damage segmentation for large-scale structural health monitoring, *Computer-Aided Civil and Infrastructure Engineering*, 35(6), pp. 579–596. doi:10.1111/mice.12523.
- Xu, H., Su, X., Wang, Y., Cai, H., Cui, K. and Chen, X. (2019) Automatic bridge crack detection using a convolutional neural network, *Applied Sciences (Switzerland)*, 9(14). doi:10.3390/app9142867.
- Ye, C., Butler, L., Calka, B., Iangurazov, M., Lu, Q., Gregory, A., Girolami, M. and Middleton, C.

(2019) A digital twin of bridges for structural health monitoring, in Structural Health Monitoring 2019: Enabling Intelligent Life-Cycle Health Management for Industry Internet of Things (IIOT) - Proceedings of the 12th International Workshop on Structural Health Monitoring, pp. 1619–1626. doi:10.12783/shm2019/32287.

Ye, C., Kuok, S.C., Butler, L.J. and Middleton, C.R. (2021) Implementing bridge model updating for operation and maintenance purposes: examination based on UK practitioners' views, Structure and Infrastructure Engineering, 0(0), pp. 1–20. doi:10.1080/15732479.2021.1914115.