

Welsh School of Architecture
Cardiff University

**Assessing the Potential Wind Resource Available for Standalone
Renewable Street Lighting in the Urban Environment
- Cardiff a Case Study.**

Michael Rhodes

Dissertation submitted for the degree of Doctor of Philosophy,
Department of Architecture, Cardiff University.

2009

UMI Number: U556869

All rights reserved

INFORMATION TO ALL USERS

The quality of this reproduction is dependent upon the quality of the copy submitted.

In the unlikely event that the author did not send a complete manuscript and there are missing pages, these will be noted. Also, if material had to be removed, a note will indicate the deletion.



UMI U556869

Published by ProQuest LLC 2013. Copyright in the Dissertation held by the Author.
Microform Edition © ProQuest LLC.

All rights reserved. This work is protected against
unauthorized copying under Title 17, United States Code.



ProQuest LLC
789 East Eisenhower Parkway
P.O. Box 1346
Ann Arbor, MI 48106-1346

DECLARATION

This work has not previously been accepted in substance for any degree and is not being concurrently submitted in candidature for any degree.

Signed.....*M. Llanos*.....(candidate)

Date.....*31/08/09*.....

STATEMENT 1

This dissertation is being submitted in partial fulfillment of the requirements for the degree of PhD.

Signed.....*M. Llanos*.....(candidate)

Date.....*31/08/09*.....

STATEMENT 2

This dissertation is the result of my own independent work/ investigation, except where otherwise stated.

Other resources are acknowledged by footnotes giving explicit references. A bibliography is appended.

Signed.....*M. Llanos*.....(candidate)

Date.....*31/08/09*.....

STATEMENT 3

I hereby give consent for my dissertation, if accepted, to be available for photocopying and for inter-library loan, and or the title and summary to be available to outside organisations.

Signed.....*M. Llanos*.....(candidate)

Date.....*31/08/09*.....

SUMMARY

Street lighting is a significant energy load for local authorities in the UK (currently 16% of the annual energy load for Cardiff City Council) and standalone hybrid renewable street lighting systems, powered by small wind turbines and / or PV panels, may help to reduce the associated carbon emissions. This thesis considers the potential wind resource available for these novel systems when deployed in urban settings.

A literature review of street lighting standards, urban wind regime, siting guidance and modelling methods has been undertaken, together with a review of current policy development that may promote the wider use of such systems in urban locations.

A case study location in Cardiff was selected based on its urban nature and close proximity to an existing weather monitoring station. Here 3 no. monitoring stations were sited for 9 months and the resulting wind data was used to calculate energy yields for 12 small wind turbines which were also compared with the results from an existing energy yield estimator tool. While the tool predicted no or very little energy yield, the monitored data suggested that the available wind resource has the potential to allow small wind turbines to contribute a proportion of the power required by street lighting systems at these locations (between 24% and 60% for the best performing turbine, dependant on the load).

In order to identify the potential maximum wind energy yield, physical modelling (boundary layer wind tunnel) was employed. This method was found to enable the differentiation of sites but cannot be seen as a substitute for physical monitoring. Limitations to the deployment of these lighting systems in the urban environment include: regulation, practical and physical factors, together with the poor performance (characterised by low capacity factors) of the wind turbines studied. These factors lead to the recommendation of this study that hybrid street lighting systems are not located in dense urban areas without further research and development.

Further work should focus on the advances made in CFD modelling and low energy lighting since this study was undertaken.

CONTENTS

	Page:
DECLARATION	ii
SUMMARY	iii
CONTENTS	iv
LIST OF ILLUSTRATIONS	x
LIST OF TABLES	xvi
PREFACE	xviii

CHAPTER 1 – INTRODUCTION

1.0 Aims and Objectives	1
1.1 Context	3
1.2 The Adoption of Renewable Energy Technology	4
1.2.1 International and European Level	4
1.2.2 National Level – UK	5
1.2.3 Devolved Level – Wales	6
1.2.4 Local Level – Cardiff	7
1.3 Renewable Energy and Street Lighting	8
1.3.1 PV Technology	8
1.3.2 Wind Turbine Technology	11
1.3.3 Standalone Hybrid Renewable Street Lighting System	14
1.4 Summary	15
1.5 Overview of Chapters	17

CHAPTER 2 – STREET LIGHTING

2.0 Introduction	18
2.1 The Performance and Practical Requirements of Urban Street Lighting	19
2.1.1 British Standards	19
2.1.2 Planning Issues & Aesthetic Design	22
2.2 Photometric Data	25
2.3 Lamp Types and Associated Loads	26
2.4 Colour Rendering Index	27
2.5 Street Lighting Design Software	29
2.6 Development of a Hybrid Wind and PV Street Light	30
2.6.1 Prototype Unit	31
2.6.2 First Commercial Unit	32
2.7 Summary	34

CHAPTER 3 – THE URBAN WIND REGIME

3.0 Introduction	35
3.1 Climate Scales	35
3.1.1 Macro-scale Wind Regime	36
3.1.2 Meso-scale Wind Regime	38
3.1.3 Micro-scale Wind Regime	44
3.2 Existing Modelling Methods	53
3.2.1 Analytical Methods	54
3.2.2 Measure-Correlate-Predict (MCP)	55
3.2.4 Linear Flow Models	57
3.2.3 Computational Wind Engineering (CWE)	58
3.2.5 Boundary Layer Wind Tunnel (BLWT) Modelling	61
3.2.6 Other Models	65
3.2.7 Summary of Modelling Methods	66
3.3 Sources of Wind Data	67
3.3.1 The British Meteorological Office	67
3.3.2 The European Wind Atlas	68
3.3.3 The NOABL Database	69
3.3.4 Other Sources	71
3.3.5 Summary of Data Sources	71
3.4 Implications of Predicted Changes in Wind Regime	72
3.5 Summary	73

CHAPTER 4 – CAPTURING THE WIND RESOURCE

4.0 Introduction	75
4.1 Wind Resource and Power Generation	76
4.1.1 Swept Area and Power Output	77
4.1.2 Power Coefficient	78
4.1.3 Capacity Factor	79
4.1.4 Power Curve	80
4.1.5 Average Wind Speed as an Indicator of Power Output	82
4.1.6 Wind Speed Distributions	83
4.1.7 Turbulence	85
4.2 Existing Guidance for the Location of Wind Turbines	86
4.2.1 BWEA Guidance	90
4.2.2 AWEA Guidance	91
4.2.3 European Commission Guidance	92
4.2.4 Met Office and Carbon Trust Guidance	93
4.2.5 Other Sources of Guidance	94
4.2.6 Summary of Guidance	96
4.3 Resource Yield Estimation	97
4.3.1 μ Wind	98
4.3.2 Carbon Trust Wind Yield Estimator	102
4.3.3 Energy Savings Trust Wind Yield Tool	104
4.3.4 Other Methods of Estimating Yield	105
4.3.5 Summary of Resource / Yield Estimation	106
4.4 Small Turbines Currently Available in the UK	107
4.5 Wind Trial Results	109
4.5.1 Warwick Wind Trials Study	111
4.5.2 Energy Savings Trust Study	112
4.5.3 Summary of Field Trial Results	113
4.6 Methods to Increase the Energy Yield from Wind Turbines	114
4.8 Summary	116

CHAPTER 5 – CASE STUDY

5.0 Introduction	117
5.1 Definition of 'Urban Area'	118
5.2 Topography of Cardiff	119
5.2 Selection of the Case Study Location	123
5.2.1 Site Survey	124
5.2.2 Site Roughness Characteristics	128
5.2.3 Street Lighting at the Case Study Location	129
5.2.4 Hours of Darkness – Cardiff	130
5.3 Comparison of Wind Data Available for the Case Study Location	131
5.3.1 WSA Weather Station	132
5.3.2 Met Office	135
5.3.3 NOABL Database	135
5.3.4 Windfinder (Cardiff Airport)	136
5.3.5 Data from Cardiff University Monitoring at Tal-y-bont	137
5.3.6 Energy Savings Trust - Wind Yield Estimation Tool	137
5.3.7 Carbon Trust Wind Yield Estimation Tool	138
5.3.8 Summary of Wind Data Sources	139
5.4 Site Potential According to Existing Guidance	141
5.5 Monitoring Equipment	142
5.5.1 Data Parameters	145
5.5.2 Physical Model (1:200 Scale)	146
5.6 Wind Tunnel Tests	147
5.6.1 Scouring Tests	149
5.6.2 Hot-wire tests	151
5.7 Summary	153

CHAPTER 6 – RESULTS & DISCUSSION

6.0 Introduction	154
6.1 Estimating Energy Yields Using the Carbon Trust Tool	155
6.1.1 Sensitivity Analysis 1 – Canopy and Hub Height	156
6.1.2 Sensitivity Analysis 2 – Turbine Yield	157
6.1.3 Estimated Yields Using Carbon Trust Tool	158
6.2 Results of Wind Data Monitoring for Case Study Location	160
6.2.1 Analysis and Comparison of Mean Wind Speed Data	161
6.2.2 Determining the Weibull Shape Factor (k)	166
6.2.3 Summary of Wind Speed Data Analysis	171
6.2.4 Analysis and Comparison of Mean Wind Direction Data	173
6.2.5 Summary of Wind Direction Data Analysis	184
6.3 Estimating Energy Yields Using the Measured Data	185
6.3.1 Monitoring Period Energy Yield Totals	186
6.3.2 Analysis of Yields Predicted During Monitoring Period	187
6.3.3 Summary of Energy Yield Analysis	206
6.4 Results from Wind Tunnel Testing	207
6.4.1 Hot-Wire Test Results for the 3 Column Locations	207
6.4.2 Use of BLWT to Identify Locations of > Wind Resource at 10m	210
6.4.3 Scouring Test Results	211
6.5 Results of Scouring and Hot-Wire Tests for Prevailing Wind Directions	213
6.5.1 Comparison of Results for Wind Direction: West	214
6.5.2 Summary for Wind Direction: West	218
6.5.3 Comparison of Results for Wind Direction: North East	219
6.5.4 Summary for Wind Direction: North East	223
6.5.5 Comparison of Results for Wind Direction: South	224
6.5.6 Summary for Wind Direction: South	228
6.6 Comparison with Current Small Turbine Siting Guidance	229
6.7 Further Results and Considerations	230
6.7.1 Heliodon Tests	230
6.7.2 Changes to the Urban Environment	230
6.8 Summary	234

CHAPTER 7 – CONCLUSIONS

7.1 Introduction - Review of Work Undertaken	239
7.2 Conclusions	241
7.2.1 Response to Objective 1	242
7.2.2 Response to Objective 2	242
7.2.3 Response to Objective 3	243
7.2.4 Response to Objective 4	243
7.2.5 Response to Objective 5	244
7.2.6 Response to Objective 6	245
7.2.7 Response to Objective 7	246
7.2.8 Response to Main Aim	248
7.3 Limitations and Recommendations for Further Study	249
7.3.1 Limitations	249
7.3.2 Opportunities for Further Study	250

GLOSSARY & ABBREVIATIONS	251
-------------------------------------	-----

BIBLIOGRAPHY	253
---------------------	-----

WEBSITES	266
-----------------	-----

APPENDICES (SUPPLIED ON CD)

APPENDIX A – Wind Classification Table

APPENDIX B – Met Office Climate Data Sets

APPENDIX C - Review of Software Tools

APPENDIX D – Web Links for Micro- and Mini-Turbine Power Curves

APPENDIX E - Data Monitoring

E1 – Programme for Campbell 21X Loggers

E2 – Specification for Vector Instruments A100R Anemometer

E3 – Specification for Vector Instruments W200P Wind Vane

E4 – Specification for Kipp and Zonen CMP 6 Pyranometer

E5 – Procedure for Setting Logger and Collecting Data

E6 – Data Logging Information

APPENDIX F - Wind Tunnel Testing

F1 - Wind Tunnel Settings for Scouring Test

F2 - Specification for TSI 8460 Air Velocity Transducer

Pull-out Site Location Plan

NOTES

LIST OF ILLUSTRATIONS

Unless stated otherwise the photographs and diagrams presented in this thesis were produced by the author.

	Page:
<i>Figure 1: UK Energy Trends June 2009 and DECC internal analysis</i> DECC (2009)	5
<i>Figure 2: Main components and terminology of an off-grid PV system</i>	10
<i>Figure 3: PV - Percentage power output for different orientation and inclinations</i> Adapted from Jardine & Lane (2003)	10
<i>Figure 4: Typical small wind turbine configurations</i> Photograph credits from top left: Hirvelwinden, Vergnet, Michael Pierrot, Michael Pierrot, Southwest Wind Power, Proven, 3G Energy, MatroW, Michael Perrot, EMAT, Quiet Revolution, Gilbert Gal & Marc Menager.	11
<i>Figure 5: Common wind turbine components and terminology</i>	12
<i>Figure 6: Policy development for the adoption of renewable energy</i>	15
<i>Figure 7: Terminology (left) and sample illuminance cone diagram (right)</i>	25
<i>Figure 8: Sample isolux diagram</i>	26
<i>Figure 9: Lamp spectra for various lamp types including SOX, SON and HPI</i> Adapted from Lamptech (2009)	28
<i>Figure 10: Results summary from Lighting REALity design software</i> Adapted from Pribyl (2007)	29
<i>Figure 11: Prototype at the test location (left) and first commercial system (right)</i>	31
<i>Figure 12: Turbine options: 100W VAWT (left) and 400W HAWT (right)</i>	32
<i>Figure 13: Schematic diagram of the system components</i>	33
<i>Figure 14: Main factors influencing the climate system</i> Adapted from Asimakopoulos (2001)	36
<i>Figure 15: The distribution of wind resources in Europe (at 50m level)</i> Troen & Petersen (2000)	37
<i>Figure 16: Annual frequency of wind direction, Europe</i> Goulding, Lewis, Steemers (1993)	37
<i>Figure 17: PBL showing the effect of aerodynamic drag or surface roughness</i> Goulding, Lewis, Steemers (1993)	38

<i>Figure 18: Wind flow over a hill</i>	38
After Jackson & Hunt (1975)	
<i>Figure 19: Roughness class and landscape classifications</i>	39
Troen & Petersen (2000)	
<i>Figure 20: UK wind resources for different topographic conditions</i>	40
Troen & Petersen (2000)	
<i>Figure 21: Monthly mean wind speed data for UK 1971 - 2000</i>	41
British Meteorological Office (2009)	
<i>Figure 22: Seasonal averages of mean wind speed data 1971 - 2000</i>	42
British Meteorological Office (2009)	
<i>Figure 23: Planetary Boundary Layer wind flow visualised in a BLWT</i>	44
St. Anthony Falls Laboratory, University of Minnesota (2009)	
<i>Figure 24: Effect of solid obstructions on wind flow</i>	45
Adapted from Goulding, Lewis, Steemers (1993)	
<i>Figure 25: Effect of permeable obstructions on wind flow</i>	45
Adapted from Goulding, Lewis, Steemers, (1993)	
<i>Figure 26: Vertical displacement of wind speed at different roughness classes</i>	47
Adapted from Piggot (2006)	
<i>Figure 27: The urban canopy and urban boundary layer</i>	48
Santamouris, after Oke (2001)	
<i>Figure 28: Wind flow layers in the urban boundary layer</i>	49
Adapted from Ricciardelli & Polimeno (2006)	
<i>Figure 29: Typical wind flow regimes over urban areas</i>	50
After Oke (1988)	
<i>Figure 30: Characteristics of Urban Canyon Effect</i>	51
Adapted from Oke (1988)	
<i>Figure 31: Reduction in wind speed (%) after shelter by a 2 dimensional obstacle</i>	54
Perera (1981)	
<i>Figure 32: Downdraft and vortex effects experienced near tall buildings</i>	63
<i>Figure 33: Wind roses for Bala and Valley</i>	68
Troen & Petersen (2000)	
<i>Figure 34: Percentage change in average annual and seasonal wind speed</i>	72
Tyndall & Hadley Centres (2001)	
<i>Figure 35: Relationship between wind speed and power available</i>	77

<i>Figure 36: Power curve for a 900W wind turbine with a rated wind speed of 9m/s</i> Adapted from Gipe (1999)	80
<i>Figure 37: Weibull distributions for different k-values</i> Adapted from Troen & Petersen (2000)	83
<i>Figure 38: Estimating energy yield with distribution and power curve</i> Adapted from Phillips (2007)	84
<i>Figure 39: Met Office guidance for locating turbines</i> Adapted from Best (2008)	92
<i>Figure 40: Suggested avoidance zone for turbines in the lee of an obstacle (Gipe)</i> Adapted from Gipe (1999)	96
<i>Figure 41: Suggested avoidance zone for turbines in the lee of an obstacle (BWEA)</i> Adapted from BWEA (2009)	96
<i>Figure 42: Carbon Trust Wind Yield Estimation Tool – main input screen</i> Carbon Trust Website (2009)	99
<i>Figure 43: Carbon Trust Wind Yield Estimation Tool – main input screen</i> Carbon Trust Website (2009)	100
<i>Figure 44: Input variables and calculation method for Carbon Trust tool</i>	101
<i>Figure 45: EST Wind Speed Prediction Tool – main screen</i> Energy Savings Trust Website (2009)	103
<i>Figure 46: Visual size comparison of listed wind turbines</i>	108
<i>Figure 47: Comparison of power curves for listed wind turbines</i>	109
<i>Figure 48: Wind concentrator designs assessed by the WEB project at ERU</i> Photos: Energy Research Unit, Rutherford Appleton Laboratory (2009)	114
<i>Figure 49: Cardiff urban area in the context of south Wales</i> The Research Centre, Cardiff Council (2005)	119
<i>Figure 50: Cardiff Map – Contours</i> Ordnance Survey (Edina Digimap, 2009)	120
<i>Figure 51: Cardiff Map – Urban Area</i> Ordnance Survey (Edina Digimap, 2009)	121
<i>Figure 52: Cardiff Map – Road Network</i> Ordnance Survey (Edina Digimap, 2009)	122
<i>Figure 53: Case study location in the wider context of the city</i> Photograph: Cardiff City Council (2004)	123
<i>Figure 54: Site plan of case study location</i>	124

<i>Figure 55: Aerial photograph of site showing perimeter of case study area</i>	124
Photograph: Cardiff City Council (2004)	
<i>Figure 56: Site photographs from various orientations</i>	125
<i>Figure 57: Views of Greyfriars Road looking East and West</i>	125
<i>Figure 58: Building heights and street elevations (Greyfriars Road)</i>	127
<i>Figure 59: Street light column types and locations for case study site</i>	128
<i>Figure 60: Hours of darkness over a year for Cardiff</i>	129
<i>Figure 61: Post code and grid references for locations from OS data</i>	131
Ordnance Survey Website (2009)	
<i>Figure 62: The WSA weather station</i>	132
Photograph: Janice Coyle (2008)	
<i>Figure 63: Location of WSA weather station in relation to the case study location</i>	132
<i>Figure 64: Monthly mean wind roses for WSA weather station</i>	133
<i>Figure 65: Monthly mean wind roses for Cardiff Airport</i>	136
<i>Figure 66: Comparison of annual mean wind speed data</i>	140
<i>Figure 67: Monitoring station schematic</i>	143
<i>Figure 68: Data monitoring station in lab and in-situ at case study location</i>	143
<i>Figure 69: Street lights selected for monitoring</i>	144
<i>Figure 70: 1:200 scale site model (the author is shown for scale)</i>	146
Photograph: Ian Knight (2003)	
<i>Figure 71: Top views of 1:200 scale site model</i>	146
<i>Figure 72: Schematic section of BLWT at the WSA</i>	147
<i>Figure 73: Wind tunnel dimensions at model turntable</i>	147
<i>Figure 74: Interior view of the roughness field (looking towards the test section)</i>	148
Photograph: Dylan Dixon (2008)	
<i>Figure 75: Exterior view of the BLWT and the BLWT control station</i>	147
<i>Figure 76: Scale used for scouring tests</i>	149
<i>Figure 77: Scouring test in progress for wind direction: South</i>	150
<i>Figure 78: Normalising the hot-wire probes</i>	151
Photographs: Ian Knight (2003)	
<i>Figure 79: Hot-wire test for 1m height, wind direction: South</i>	152

<i>Figure 80: Monthly mean wind speeds as a percentage of total monitoring period</i>	162
<i>Figure 81: Wind speed distribution and cumulative frequency for WSA Location</i>	164
<i>Figure 82: Wind speed distribution and cumulative frequency for Location 1</i>	164
<i>Figure 83: Wind speed distribution and cumulative frequency for Location 2</i>	165
<i>Figure 84: Wind speed distribution and cumulative frequency for Location 3</i>	165
<i>Figure 85: Fitted Weibull for WSA location</i>	167
<i>Figure 86: Fitted Weibull for column location 1</i>	167
<i>Figure 87: Fitted Weibull for column location 2</i>	168
<i>Figure 88: Fitted Weibull for column location 3</i>	178
<i>Figure 89: Comparison of monitored and estimated wind speeds</i>	172
<i>Figure 90: Comparison of Wind Roses for Locations for March</i>	173
<i>Figure 91: Comparison of Wind Roses for Locations for April</i>	174
<i>Figure 92: Comparison of Wind Roses for Locations for May</i>	175
<i>Figure 93: Comparison of Wind Roses for Locations for June</i>	176
<i>Figure 94: Comparison of Wind Roses for Locations for July</i>	177
<i>Figure 95: Comparison of Wind Roses for Locations for August</i>	178
<i>Figure 96: Comparison of Wind Roses for Locations for September</i>	179
<i>Figure 97: Comparison of Wind Roses for Locations for October</i>	180
<i>Figure 98: Comparison of Wind Roses for Locations for November</i>	181
<i>Figure 99: Comparison of Wind Roses for Locations for December</i>	182
<i>Figure 100: Annual wind direction roses from measured data</i>	183
<i>Figure 101: Qualitative comparison of wind roses for column locations</i>	184
<i>Figure 102: Relationship between energy yield rank and capacity factor</i>	195
<i>Figure 103: Percentage load met for 3 day periods – WSA (150W Lamp)</i>	196
<i>Figure 104: Percentage load met for 3 day periods – Location 1 (150W Lamp)</i>	197
<i>Figure 105: Percentage load met for 3 day periods – Location 2 (150W Lamp)</i>	197
<i>Figure 106: Percentage load met for 3 day periods – Location 3 (150W Lamp)</i>	198
<i>Figure 107: Percentage load met for 3 day periods – WSA (60W Lamp)</i>	199
<i>Figure 108: Percentage load met for 3 day periods – Location 1 (60W Lamp)</i>	199

<i>Figure 109: Percentage load met for 3 day periods – Location 2 (60W Lamp)</i>	200
<i>Figure 110: Percentage load met for 3 day periods – Location 3 (60W Lamp)</i>	200
<i>Figure 111: 3 day energy yield totals – WSA Location</i>	202
<i>Figure 112: 3 day energy yield totals – Location 1</i>	203
<i>Figure 113: 3 day energy yield totals – Location 2</i>	204
<i>Figure 114: 3 day energy yield totals – Location 3</i>	205
<i>Figure 115: Wind Shelter Roses from WT hot-wire results</i>	209
<i>Figure 116: Areas of the public realm appropriate for street lighting columns</i>	210
<i>Figure 117: Scale used for scouring tests</i>	211
<i>Figure 118: Scouring test results for 8 wind directions</i>	212
<i>Figure 119: Hot-wire measurement points</i>	213
<i>Figure 120: Scouring test results – Wind direction: W</i>	214
<i>Figure 121: Hot-wire test results – Wind direction: W, Height 1m</i>	215
<i>Figure 122: Hot-wire test results – Wind direction: W, Height 5m</i>	216
<i>Figure 123: Hot-wire test results – Wind direction: W, Height 10m</i>	217
<i>Figure 124: Scouring test results – Wind direction: NE</i>	219
<i>Figure 125: Hot-wire test results – Wind direction: NE, Height 1m</i>	220
<i>Figure 126: Hot-wire test results – Wind direction: NE, Height 5m</i>	221
<i>Figure 127: Hot-wire test results – Wind direction: NE, Height 10m</i>	222
<i>Figure 128: Scouring test results – Wind direction: S</i>	224
<i>Figure 129: Hot-wire test results – Wind direction: S, Height 1m</i>	225
<i>Figure 130: Hot-wire test results – Wind direction: S, Height 5m</i>	226
<i>Figure 131: Hot-wire test results – Wind direction: S, Height 10m</i>	227
<i>Figure 132: Heliodon analysis for December</i>	231
<i>Figure 133: Heliodon analysis for March</i>	232
<i>Figure 134: Heliodon analysis for June</i>	234
<i>Figure 135: Qualitative comparison of shelter roses for column locations</i>	235
<i>Figure 136: Points identified by hot-wire tests for future study</i>	238

LIST OF TABLES

	Page:
<i>Table 1: Types of PV and their efficiency ranges</i>	8
<i>Table 2: Size classification of small wind turbines</i>	12
<i>Table 3: The technical & aesthetic specification of street lighting – key documents</i>	19
<i>Table 4: Street Lighting Classes</i>	20
<i>Table 5: Suggested lamp heights for different road types</i>	21
<i>Table 6: Column horizontal clearances for different road speeds</i>	21
<i>Table 7: Key statements from the MfS relevant to urban street lighting</i>	23
<i>Table 8: Typical performance of the 3 main lamp types in Cardiff</i>	27
<i>Table 9: Comparison – Wind / PV and Fuel Cell / PV Street Lights</i>	33
<i>Table 10: The layers of the atmosphere</i>	36
<i>Table 11: Roughness lengths and classes for different landscape types</i>	46
<i>Table 12: The effect of roughness on wind speed</i>	47
<i>Table 13: Summary of modelling methods and their applicable scales</i>	73
<i>Table 14: Theoretical wind resource for 2 scenarios showing effect of distribution</i>	82
<i>Table 15: Classes of wind power density at 10m and 50m (AWEA guidance)</i>	89
<i>Table 16: Comparison of siting guidance for wind turbines in urban areas</i>	95
<i>Table 17: Small HAWT & VAWT wind turbines <2.1m Ø rotor</i>	107
<i>Table 18: Monthly mean wind speeds for WSA weather station</i>	133
<i>Table 19: NOABL results for case study location and WSA location at 10m height</i>	135
<i>Table 20: Monthly mean wind speed data for Cardiff Airport</i>	136
<i>Table 21: Monthly mean wind speeds for Tal-y-bont, Cardiff</i>	137
<i>Table 22: EST wind yield tool results for locations at 10m</i>	137
<i>Table 23: Carbon Trust Estimator results for locations at 10m</i>	138
<i>Table 24: Comparison of available mean wind speed data for Cardiff</i>	138
<i>Table 25: Relevance of current siting guidance for case study location</i>	141
<i>Table 26: Sensitivity analysis including calculated average canopy layer height</i>	156
<i>Table 27: Sensitivity analysis – estimated energy yield from selected wind turbine</i>	157
<i>Table 28: Estimated energy yield for 12 no. wind turbine types at the 2 locations</i>	158

<i>Table 29: Comparison of measured wind speed data for the monitoring period</i>	161
<i>Table 30: Number of data measurements and missing data for each location</i>	163
<i>Table 31: Calculated Weibull k values for monthly data sets for all locations</i>	169
<i>Table 32: Distribution and range of Weibull shape & scale factors for all locations</i>	169
<i>Table 33: Comparison of measured data with other data sources</i>	171
<i>Table 34: Comparison of annual energy yield estimations (kWh)</i>	186
<i>Table 35: Energy yield totals for monitoring period – WSA Location</i>	187
<i>Table 36: Comparison of energy yield from measured data with CT Tool prediction</i>	188
<i>Table 37: Energy yield totals for monitoring period – Location 1</i>	189
<i>Table 38: Energy yield totals for monitoring period – Location 2</i>	190
<i>Table 39: Energy yield totals for monitoring period – Location 3</i>	191
<i>Table 40: Turbine ranking by energy yield for each location</i>	192
<i>Table 41: Contribution of turbines to load for monitoring period (150W lamp)</i>	193
<i>Table 42: Turbine ranking by capacity factor for each location</i>	194
<i>Table 43: Comparison of optimal column location with other column locations</i>	206
<i>Table 44: % Shelter predicted for column locations from hot-wire tests</i>	207
<i>Table 45: Mean wind speed summary</i>	234
<i>Table 46: Proportion of wind power by direction</i>	235
<i>Table 47: % Shelter predicted from hot-wire prevailing wind averages</i>	236
<i>Table 48: Comparison of values from tables 46 and 47 normalised to Location 2</i>	236
<i>Table 49: Points identified by hot-wire tests for future study</i>	238

PREFACE

The use of small renewable energy systems to power public street lighting systems and other street furniture items has become increasingly common in the UK over the last decade. Indeed nowadays it is rarely possible to make a road or rail journey in the UK without encountering at least one example of a renewable energy powered street furniture item, be it a sign, a parking meter, a bus shelter, a weather monitoring station or a street light.

I first became involved in the problem around 10 years ago when I entered a design competition to design an off-grid wind and PV powered street light for the UK market (then innovative in the UK). A DTI funded research and development project followed, through which an SME manufacturer rationalised the design and built and tested a prototype system in a semi-rural location. Following a broadly successful test period, during which the system components and energy balance were monitored, a commercial design was produced and marketed.

From the beginning of the project it was assumed that the hybrid street light would be used in rural locations, canal paths or parks where specific sites could be chosen that benefited from minimal wind and solar shadowing. Furthermore, these locations were the most likely to benefit from an off-grid system, such as the proposed design, that would not require any cable trenching, representing an attractive cost saving to customers (e.g. local authorities) over grid-connected alternatives.

Since the hybrid street light was developed there has been increasing concern about the carbon emissions associated with energy use and a mixture of voluntary targets and international legislation has compelled local authorities to reduce their emissions. Street lighting can constitute a significant part of the annual energy use of a local authority, particularly in urban areas where, typically, there is a higher density of street lights than in rural areas. As a result, demand for such systems has increased and local authorities are now looking to install these systems in urban environments. In order to offset the embodied energy associated with these systems and to ensure that they work effectively, it is necessary to identify sites where they can operate autonomously, based on the renewable resources available.

An urban environment provides a challenge in terms of predicting wind resource, with the density of buildings creating a complex pattern of shadowing effects. Hybrid renewable street lighting is critically dependant on the local wind and solar resource to meet the electrical load of the lamp. While a good indication of the solar resource can be achieved relatively simply through current modelling software, this study presents the results of monitoring and modelling an urban environment to assess the wind resource.

This study was undertaken to provide specifiers (local authorities, lighting designers and architects) with an understanding of the potential for renewable powered wind hybrid street lighting systems located in an urban environment and combines technical results from monitoring and laboratory work, together with statutory guidance on the design of street lighting schemes. As such, the use of jargon or complex mathematics has been avoided where possible.

There are many people I wish to thank. Those who have contributed most in terms of the technical development of the street lighting system (and my understanding of it) are my former colleagues Dr Daniel Nuh and Bruce Cross from the Energy Equipment Testing Service. I would also like to thank staff of the Welsh School of Architecture, notably my supervisors Dr Ian Knight and Dr Mike Fedeski, as well as Huw Jenkins, Don Alexander, Simon Lannon and Dylan Dixon for their technical assistance in preparing laboratory experiments and monitoring equipment. I am grateful to the Technology Transfer Initiative (TTI) for partially funding this work, particularly Dr Ted Jones and Howard Nicholls for their input. I am also grateful to Philip Marques of CU Phosco for his technical input on street lighting. Finally, I express my thanks to Cardiff Council for providing access to street lighting in the city centre throughout the monitoring period and for the guidance of Bryan Geeves and Bryan Thompson on the technical and legal matters regarding the local authority lighting strategy.

Thank-you also to my partner Dr Julie Gwilliam.

Michael Rhodes, Cardiff University, September 2009

"The sources of renewable energy are inexhaustible, indigenous and abundant, and their exploitation, properly managed, has the potential to enhance the long-term security of the United Kingdom's energy supplies and to help us cut carbon dioxide emissions"¹

House of Lords Science and Technology Committee, July 2004

CHAPTER 1 - INTRODUCTION

1.0 Aims and Objectives

The use of small renewable energy systems (micro-generation) to power public street lighting systems and other street furniture items has become increasingly common in the UK over the last decade as concerns about the impacts of climate change and peak oil become evidenced in government and local authority policy. Indeed nowadays it is rarely possible to make a road or rail journey in the UK without encountering at least one example of a renewable energy powered street furniture item, be it a sign, a parking meter, a bus shelter, a weather monitoring station or a street light. However, while there appears to be current enthusiasm for installing such items, the question of how well these perform in an urban environment remains largely unanswered.

An urban environment provides a particular challenge in terms of predicting wind and solar resource, with the density of buildings creating a complex pattern of shadowing effects. While selecting a location for photovoltaic (PV) only systems is largely a matter of geometric calculation, the effectiveness of hybrid renewable street lighting (wind and photovoltaic) is also dependant on the local wind resource, the prediction of which, in an urban location, is less well understood.

The main aim of this study is to establish to what extent the wind component of a hybrid renewable energy street lighting system can be effective in an urban environment.

¹ ODPM, *Companion Guide to Planning Policy Statement 22: Renewable Energy*, HMSO, 2004, Page 5

This thesis presents the results of monitoring and modelling an urban environment to assess the wind resource available. Further objectives of the study are as follows:

- To identify the demand for renewable energy in the context of street lighting.
- To establish an understanding of the technical and practical performance requirements of urban street lighting.
- To establish from existing literature factors influencing the urban wind regime.
- To describe the relationship between wind resource and power generation.
- To critically review current literature relating to the siting and energy output of small wind turbines.
- To undertake a case study analysis of an urban environment to characterise the available wind resource.
- To evaluate the potential power contribution for locations in the case study urban environment for a range of commercially available small wind turbines.

From the above objectives it will be possible to address the main aim of the study. Additionally this study will indicate areas of further work to establish more detailed guidance for the deployment of hybrid renewable street lighting in the wider urban environment.

1.1 Context:

Street lighting performs several important roles in the public realm including safety, security and amenity. As such, it must meet prescribed technical requirements and aesthetic standards in order to best serve road users and pedestrians. The energy used by street lighting can contribute significantly to the annual energy requirements of a local authority. For example, in Cardiff (the case study location for this thesis), there are currently approximately 35,000 street lighting columns and a further 9,000 illuminated traffic signs². Whilst there is a financial cost associated with this demand, another factor of increasing importance is the associated environmental impact. With growing scientific and political emphasis concerning the effect of carbon emissions on global climate, there is increasing pressure on local authorities to reduce the emissions associated with their various energy needs.

One method of achieving a reduction in the carbon emissions associated with energy use is to use energy from a renewable source. Renewable energy is energy derived from an inexhaustible source that is rapidly replenished by a natural process. The main renewable energy sources currently available are: solar (electricity and heat), wind, hydro (water, tidal and wave), geothermal and biomass. A hybrid renewable energy system is one that combines two or more of the above sources in a single application. 'Renewables' may refer to the energy source (e.g. wind or wave) or the energy collector (e.g. turbine or solar panel). 'Renewable resource' refers to the sum of the different sources available at a specific site. Renewable systems may be grid connected (connected to the national mains electricity grid) or standalone (off-grid, either directly connected to the load or charging a battery store).

² Figures from Cardiff City Council Street Lighting Office, July 2009

1.2 The Adoption of Renewable Energy Technology

Over the past decade the increased adoption of renewable energy technology has become a political aim that has informed policy across the spectrum of administrative levels. The bureaucratic systems are complex and often overlapping, with numerous targets, interim aspirations and policy statements at a variety of levels of governance. The common aim is to decrease the emissions of carbon dioxide (CO₂) and other greenhouse gases and to increase the provision of energy from renewable sources. This section offers a brief outline of the recent progress of such policy and highlights the key policy documents at each administrative level, from international to local level.

1.2.1 International and European Level

The UK government signed the Kyoto Protocol³ in 1998 following the United Nations Framework Convention on Climate Change (UNFCCC) Conference in 1997. This committed the UK to reducing its emissions of greenhouse gases by 12.5% by 2008 – 2012 (compared with 1990 levels). The protocol was ratified by all EU members in May 2002 and its original commitments have formed the basis of subsequent EU legislation, such as the 2001/77/EC: Renewables Directive⁴ and the 2002/91/EC: Energy Performance of Buildings Directive⁵. At this time some EU member states also agreed to voluntary targets to reduce CO₂ emissions by 20% by 2010 (compared with 1990 levels) and to increase primary energy generation from renewables to 10% by 2010⁶. These targets were later changed to a 30% reduction in CO₂ emissions by 2020 together with 20% of primary energy generation to be from renewable sources by 2020 across the EU, both binding and in line with the commitments formally adopted by the European Parliament in March 2007. These targets, published on the European Commission Climate Action website⁷, indicate the potential international relevance of this study.

³ UNFCCC, *Kyoto Protocol*, United Nations, 1998 (http://unfccc.int/kyoto_protocol)

⁴ European Commission, *2001/77/EC: Renewables Directive*, 27th September 2001

⁵ European Commission, *2002/91/EC: Energy Performance of Buildings*, 16th December 2002

⁶ DTI, *Energy White Paper, Our Energy Future*, The Stationery Office, 2003, page 25

⁷ http://ec.europa.eu/climateaction/index_en.htm - last accessed July 2009

1.2.2 National Level - UK

The UK Government published a strategy to meet the obligations that it had agreed in the Energy White Paper: *Our Energy Future* in 2003. This prioritised targets for reducing CO₂ emissions and increasing the deployment of renewable energy in the UK, citing both environmental and energy security as key 'challenges'⁸. In the intervening time EU policy had continued to develop, culminating in the publication of the Renewable Energy Road Map in 2007 that set out 'the way forward' for renewables⁹. This, together with other factors such as increasing energy prices and concerns over supply, also influenced UK Government policy. The 2007 Energy White Paper: *Meeting the Energy Challenge* placed more emphasis on renewable electricity and offered increased financial support for this¹⁰. These targets and policy obligations were formalised in the Climate Act, 2008.

The Department of Energy and Climate Change (DECC) now has responsibility for the UK Renewable Energy Strategy¹¹ (RES), having combined the previous roles of the Department for Business Innovation and Skills (BIS) and the Department for the Environment Food and Rural Affairs (DEFRA)¹². The DECC carried out an analysis of trends in renewable energy in the UK and has predicted the breakdown of renewable energy share by sector by 2020 based on costs, benefits and potential (figure 1). This predicts that electricity generation from renewables will be the largest growth sector and therefore energy use associated with street lighting could be part of this target.

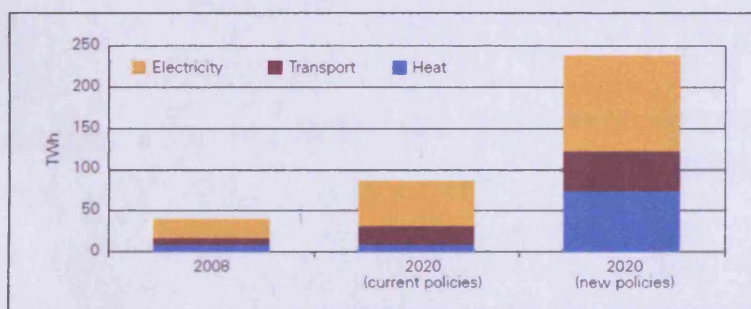

Figure 1: Renewable Energy Trends June 2009 and DECC internal analysis¹³

⁸ DTI, *Energy White Paper: Our Energy Future*, The Stationery Office, 2003, page 6

⁹ European Commission, *Renewable Energy Road Map*, 10th January 2007, page 9

¹⁰ DTI, *Energy White Paper: Meeting the Energy Challenge*, The Stationery Office, 2007, page 14

¹¹ DECC, *The UK Renewable Energy Strategy*, The Stationery Office, 2009

¹² <http://www.decc.gov.uk> – last accessed July 2009

¹³ DECC, *The UK Renewable Energy Strategy*, The Stationery Office, 2009, page 11

1.2.3 Devolved Level - Wales

As well as informing the UK Government policy on renewable energy, the commitments made through international agreements have also filtered down to the devolved level (Wales) and to a local level (local authority). The Welsh Assembly Government (WAG) set up the National Assembly Sustainable Energy Group (NASEG Ltd) in August 2001 as a cross party group intended to be *'Wales's leading forum for sustainable energy issues'*¹⁴. NASEG is made up of Assembly Members (AMs), civil servants, industry stakeholders, academia, non-governmental organisations (NGOs) and statutory bodies. The principal aims of NASEG are to:

- *"Raise awareness of sustainable and renewable energy issues, opportunities and innovations amongst National Assembly Members and staff, and to all Welsh sectors".*
- *"Assist the development of a Sustainable Energy Policy and Strategy for Wales through the National Assembly".*
- *"Maximise the potential for sustainable energy in Wales, in terms of jobs, greenhouse gas abatement, and putting Wales at the forefront of the world sustainable energy industry"*¹⁵.

NASEG has advised the WAG on the development of policy to remove perceived barriers to the adoption of renewable energy identified in the devolved planning and regulatory systems in Wales.

The Department for the Environment, Sustainability and Housing (DESH) produces the devolved strategy for renewable energy in Wales. As a part of its strategy, the WAG published a document entitled 'One Wales: A Progressive Agenda for the Government of Wales' in 2007, that sets out a requirement that carbon emissions from the principality are reduced by 3% year on year beginning in 2011¹⁶. A further consultation document entitled 'One Wales: One Planet'¹⁷, published in 2008, sets out a proposed strategy for achieving this target across all sectors.

¹⁴ <http://www.naseg.co.uk> – last accessed July 2009

¹⁵ <http://www.naseg.co.uk> – last accessed July 2009

¹⁶ WAG, *One Wales: A Progressive Agenda for the Government of Wales*, June 2007, page 31.

¹⁷ WAG, *One Wales: One Planet*, November 2008 (<http://wales.gov.uk/docs/desh/consultation>)

To help to remove barriers to the adoption of renewable energy technology in Wales, changes have been made to planning policy and guidance. Planning policy is set out in Planning Policy Wales¹⁸ (PPW) and a series of Technical Advice Notes (TANs) provide supplementary guidance on various different elements of planning. In addition to providing a context for renewable energy and planning in Wales, TAN8: Renewable Energy specifically identifies the potential for wind power generation in urban sites and recommends that this is encouraged¹⁹. This document also demands that *'local planning authorities should seek to maximise the potential of renewable energy'*²⁰. Further changes to planning policy were announced in a recent WAG statement indicating that planning charges for some micro-generation technologies would no longer apply in Wales specifically to help encourage the growth of these technologies²¹.

The Renewable Energy Route Map for Wales (in consultation at the time of writing – expected 2009) will be the key policy document to 'enable transition to a low carbon economy'²² and will formalise the aspiration of the WAG that Wales will become 'self-sufficient in renewable electricity generation within 20 years'²³.

1.2.4 Local Level - Cardiff

At a local level, renewable energy deployment is largely influenced by local authority planning policy, specifically by the Local Development Plans (LDPs) that all authorities in Wales are required to publish. In addition to its LDP (2006 - 2021), Cardiff Council published a Sustainability Appraisal in March 2009 that sets out policy aims for sustainable development, including encouraging the use of renewable energy technology in the city. Strategic Policy SP1 in this document states that:

*"Cardiff will be developed in a way that is consistent with principles of sustainable development including promoting energy efficiency and increasing the supply of renewable energy"*²⁴.

¹⁸ WAG, *Planning Policy Wales*, National Assembly for Wales, March 2002

¹⁹ WAG, *Technical Advice Note 8: Renewable Energy*, National Assembly for Wales, July 2005, page 7

²⁰ WAG, *Technical Advice Note 8: Renewable Energy*, National Assembly for Wales, July 2005, page 13

²¹ Jane Davidson (Environment Minister), 6th August 2009 – reported by BBC News 07/08/09

²² Jane Davidson (Environment Minister), 19th May 2008 – speaking at the launch of the consultation

²³ Jane Davidson (Environment Minister), 22nd May 2009 – speaking at the 2009 Hay Festival

²⁴ *Sustainability Appraisal*, Cardiff Council, March 2009, page 28

1.3 Renewable Energy and Street Lighting

By definition electric lighting requires a source of electrical energy. The most appropriate renewables for a small standalone (off-grid) system, such as a street lighting column, are therefore those that directly generate electricity and are sufficiently compact to allow mounting on a lighting column. Wind turbines convert the power of the wind into electricity while photovoltaics (PV) panels convert solar radiation into electricity. The benefit of a hybrid system comprising wind and PV is therefore that more of the renewable resource at a site can be exploited at a given time. As is evidenced in section 1.2, there is a particular political demand for renewable energy systems that provide electrical generation.

1.3.1 PV Technology

There are several different types of PV available that are suitable for a variety of applications (table 1). They are produced using a range of raw materials and manufacturing processes and vary in efficiency from around 3% to around 17% solar radiation converted to electricity in external conditions for the types commonly used in commercial applications.

Material Type:	Abbreviation:	Typical Efficiency:
Mono-crystalline Silicon	Mono c-Si	15%
Poly-crystalline Silicon	Poly c-Si	8% -12%
Amorphous Silicon	A-Si	6%
Cadmium Telluride	CdTe or CadTel	7%
Copper Indium (di)Selenide	CIS	9%
Copper Indium Gallium (di)Selenide	CIGS	5% - 11% ⁺
Gallium Arsenide	GaAs	25% - 30% ⁺⁺

Table 1: Types of PV and their efficiency ranges²⁵

Gallium arsenide cells currently provide higher efficiencies than the other cell types shown in the table, although these are relatively expensive and are therefore mostly restricted to space or military applications.

²⁵ Jardine, C., Lane, K., *Photovoltaics in the UK*, ECI, University of Oxford, Feb. 2003, page 12

⁺ Roedem et al, *National Energy Road Map: CIGS PV*, US Department of Energy, June 2007, page 2

⁺⁺ http://www1.eere.energy.gov/solar/tf_single_crystalline.html - last accessed July 2009

Laboratory tests have demonstrated that efficiencies of >31% (i.e. greater than the theoretical maximum - Shockley-Queisser limit)²⁶, are possible with 'multi-junction' cells²⁷, although novel 'third generation' polymer (PCBM) and organic cells have yet to demonstrate their full potential²⁸. Of the current silicon based PV types, mono-crystalline silicon provides the most efficient conversion of solar radiation to electricity²⁹. This means that for a given load requirement (e.g. 200W) a smaller area of mono-crystalline PV would be required compared with poly-crystalline or amorphous. Therefore when a compact system is required (such as a lighting column where both imposed wind loading and appearance must be considered) mono-crystalline PV is currently the most suitable type. A typical commercial mono-crystalline module has a rated energy output of 90Wp (watts peak) at 1000W/m² and a surface area of 0.63m²³⁰.

There are a range of different mono-crystalline silicon PV module types available although the manufacturing process and associated terminology is largely similar in each case. Typically the individual prepared silicon 'cells' are arranged in rows that are electrically connected together to form a circuit (or 'string' of cells). These are then laminated with a front surface of high transmissivity glass and a backing of opaque polyvinyl fluoride (thermoplastic) to form a 'laminated'. An electrical connection box is attached to the rear surface with adhesive and the 'laminated' is mounted in a protective aluminium frame to form a framed 'module'. Modules can be arranged in groups or 'module strings' (usually connected in series) with a group of strings forming an 'array'. In order to supply alternating current (AC) loads (such as most commercial types of luminaire), the direct current (DC) produced by the PV must pass through an electrical inverter. In an off-grid lighting system the electricity generated is typically stored in a battery (or series of batteries) that are specified for the solar charge / discharge cycle. Figure 2 illustrates the main components and terminology associated with a PV system.

²⁶ Shockley, W. & Queisser H.J., *Detailed Balance Limit of Efficiency of p-n Junction Solar Cells*, Journal of Applied Physics, Volume 32, March 1961, page 510-519

²⁷ King et al, *40% Efficient Metamorphic GaInP/GaInAs/Ge Multi-junction Solar Cells*, Applied Physics Letters, Vol. 90, Issue 18, May 2007

²⁸ Mayer et al, *Polymer Based Solar Cells*, Materials Today, Vol. 10, Issue. 11, Nov. 2007, pp 28-33

²⁹ Jardine, C., Lane, K., *Photovoltaics in the UK*, ECI, University of Oxford, Feb. 2003, page 6

³⁰ Little, A., *Potential Cost Reduction in PV Systems (ETSU S/P2/00320/REP)*, TSO, 2002, page 88

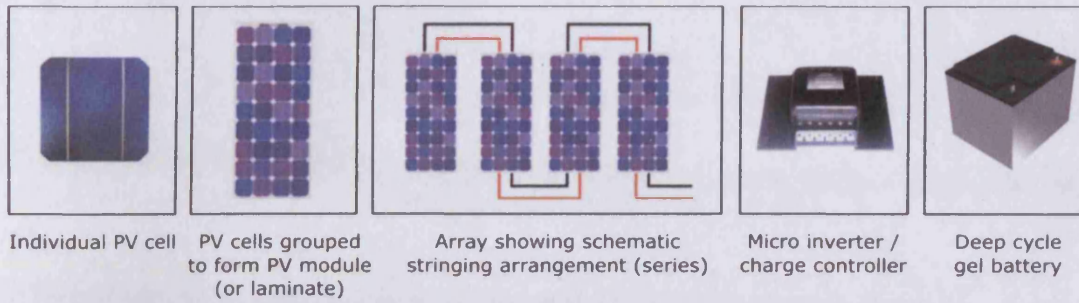

Figure 2: Main components and terminology of an off-grid PV system

The energy output from PV varies with a number of factors including the type of technology, the amount of solar radiation falling on the array, the orientation and inclination of the array and the ambient temperature. Figure 3 shows the variation for orientation and inclination in the UK.

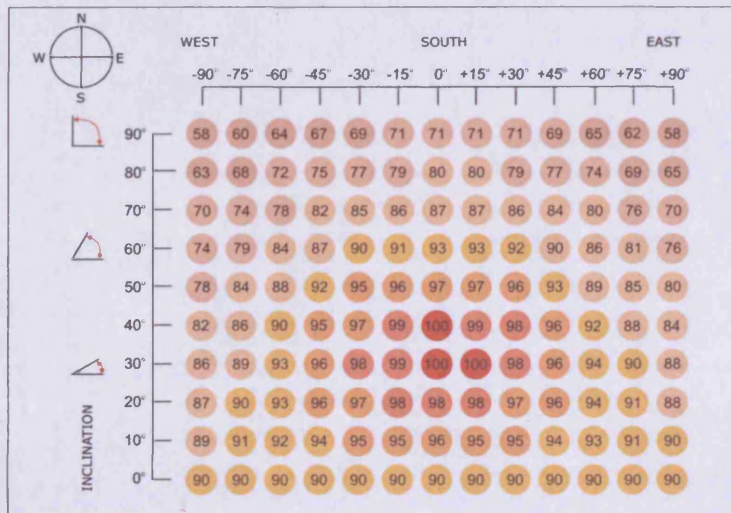

Figure 3: PV: Percentage energy output for different orientation and inclinations³¹

Among the advantages of PV are reliability and low maintenance. The main disadvantage of PV is that it produces the greatest energy output when exposed to direct solar radiation. Therefore, in cloudy conditions, when only diffuse radiation is available, the electrical output is greatly reduced and at night, when street lighting is switched on and requires power, no electricity is produced. Estimating the energy output from a PV system is now relatively straight forward as validated tools are available that allow local geometry and climate data to be modelled (such as PV Syst)³².

³¹ Jardine, C., Lane, K., *Photovoltaics in the UK*, ECI, University of Oxford, Feb. 2003, page 4

³² See Appendix C - Review of Software Tools

1.3.2 Wind Turbine Technology

Wind turbines can generate electricity whenever the local wind speed is within their operational range. This range is usually expressed as a 'cut-in' wind speed, at which the turbine begins generating, and a 'cut-out' wind speed, above which the turbine stops generating to prevent damage³³. There are 2 basic types of wind turbine, those that rotate about a horizontal axis (HAWT) and those that rotate about a vertical axis (VAWT). A number of subtypes exist in each group based on different aerodynamic designs (figure 4). Small wind turbines for the urban environment are a relatively new product³⁴.

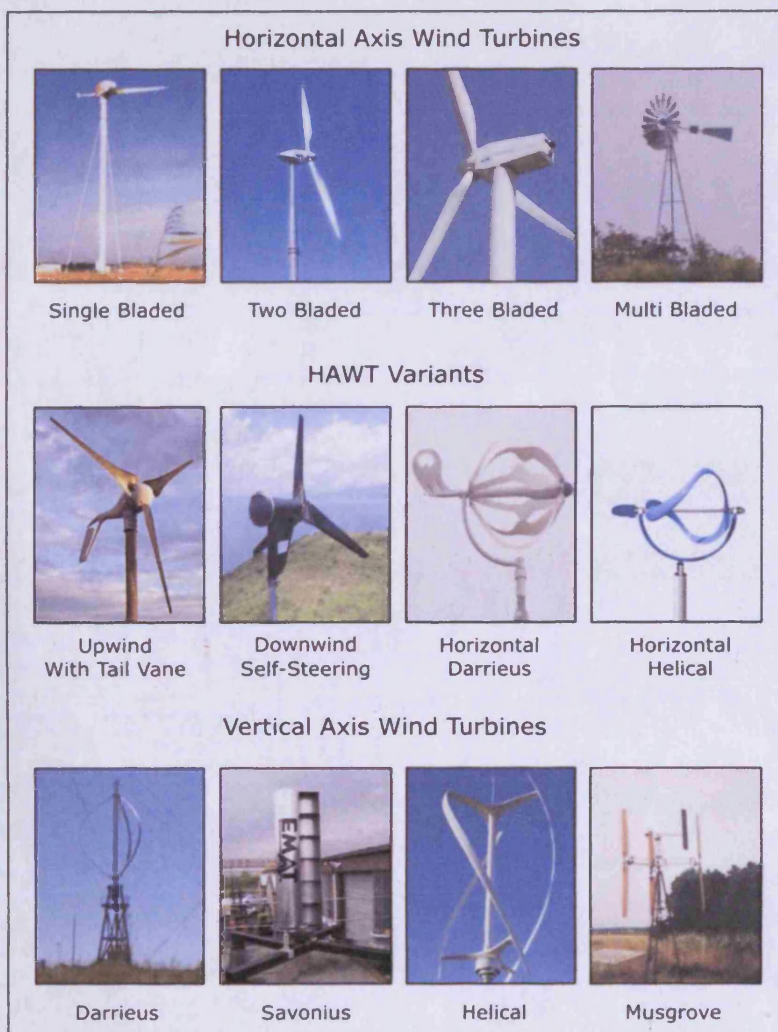

Figure 4: Typical small wind turbine configurations (adapted from Twidell & Wier³⁵)

³³ Twidell, J. A., Wier, A.D., *Renewable Energy Resources (2nd edition)*, Taylor & Francis, 2006, p. 307

³⁴ Syngellakis K., Traylor, H., *Urban Wind Resource Assessment in the UK*, European Commission, February 2007, page 5

³⁵ Twidell, J. A., Wier, A.D., *Renewable Energy Resources (2nd edition)*, Taylor & Francis, 2006, p. 270

Typical wind turbine components and terminology are illustrated in figure 5 using a HAWT as an example.

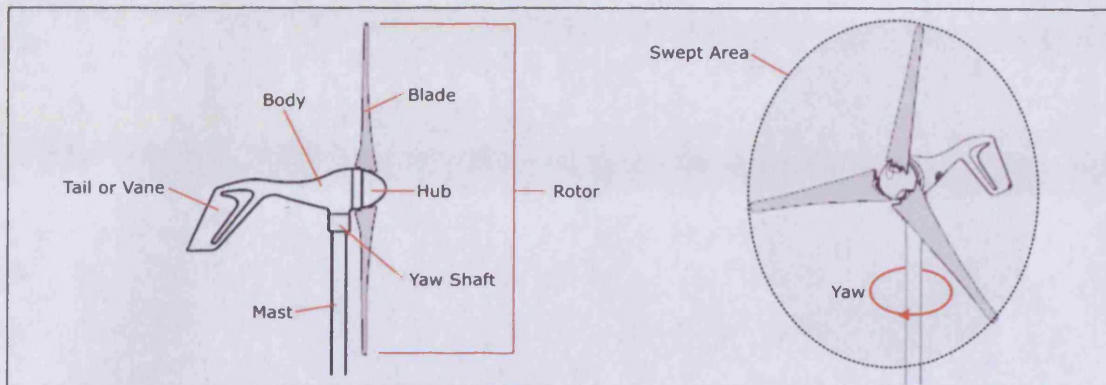

Figure 5: Common wind turbine components and terminology

Turbines can be grouped into size classes by rated energy output. 'Small' wind turbines are generally considered to be those with an electrical power generation capacity of $\leq 20\text{kW}$ ³⁶ and this is the smallest class in common usage. However turbines at the upper end of this range would be physically too large to mount on a street lighting column so an additional separation is required. Gipe, in his work on small wind turbines in the US, suggests a further differentiation based on rotor diameter that includes micro, mini and household size (table 2)³⁷. From this definition mini- and micro- scale would be the most appropriate for mounting on a lighting column (see Chapter 2).

Size Category (Small):	Rotor Diameter:
Micro	$\leq 1.4\text{m}$
Mini	1.5m – 2.6m
Household	2.7m – 8.8m

Table 2: Size classification of small wind turbines (after Gipe)

The physics of electricity generation from wind turbines is complex and this thesis will not describe this in exhaustive detail, but rather provide an overview of the main concepts relevant to the study. However, the factors affecting the urban wind regime will be discussed in detail in Chapter 3.

³⁶ Gipe, P., *Wind Energy Basics*, Chelsea Green Publishing, 1999, page 13

³⁷ Gipe, P., *Wind Energy Basics*, Chelsea Green Publishing, 1999, pages 106 - 109

Wind turbine manufacturers usually quote the maximum rated power capacity for a turbine for a specified 'rated' wind speed, typically around 12m/s. Power production at this speed would be expected to be around 0.3kW m⁻² of swept area with a power coefficient of between 35% - 45%³⁸. The Betz limit states that no wind turbine can capture more than 59.3% of the energy in the wind³⁹. These factors are described in more detail in Chapter 4.

Wind turbines work most effectively in 'free stream' or laminar flow conditions (i.e. clear of surrounding objects that cause turbulence)⁴⁰. Turbulence is best described as chaotic eddies caused by obstructions in the path of the free stream that are manifested as both changes in wind speed and direction. Flows can be characterised using a Reynolds number (Re), with laminar flow occurring at low Re and a turbulent flow occurring at high Re. Wind flows are generally characterised in terms of a wind speed profile (or wind shear) over a surface, that is in turn characterised in terms of its roughness length.

Small HAWTs typically use a vane to face into the wind stream (passive yaw) either in an upwind or a downwind configuration. Turbulent wind can cause the turbine to yaw rapidly, reducing the speed of the rotor. Additionally changes in the wind speed can disproportionately affect small HAWTs that typically have lightweight blades (e.g. carbon fibre) as the rotor does not have sufficient momentum to smooth out the changes and can stall, resulting in the loss of energy output⁴¹. Some manufacturers state that they have addressed this problem, the Marlec Rutland 504 Wind Charger being an example⁴². VAWTs do not yaw and so operate independently of wind direction⁴³. Some have been designed specifically for turbulent conditions, an example being the Windside product range⁴⁴. Clearly the wind regime in the urban environment is subject to turbulence as the wind passes over and around buildings. This thesis aims to explore to what extent a small wind turbine located in these conditions can be an effective component of a hybrid renewable street lighting system.

³⁸ Twidell, J. A., Wier, A.D., *Renewable Energy Resources (2nd edition)*, Taylor & Francis, 2006, p. 264

³⁹ Van Kuik, G., *The Lanchester-Betz-Joukowski Limit*, Wind Energy, Vol. 10, Issue 3, May/June 2007 pages 289-291

⁴⁰ Gipe, P., *Wind Energy Basics*, Chelsea Green Publishing, 1999, page 71

⁴¹ Twidell, J. A., Wier, A.D., *Renewable Energy Resources (2nd edition)*, Taylor & Francis, 2006, p. 304

⁴² <http://www.marlec.co.uk/products/windchargers/rutland-504-windcharger> - accessed July 2009

⁴³ Twidell, J. A., Wier, A.D., *Renewable Energy Resources (2nd edition)*, Taylor & Francis, 2006, p. 272

⁴⁴ <http://www.windside.com> - accessed July 2009

1.3.3 Standalone Hybrid Renewable Street Lighting System

A standalone (off-grid) wind and PV street lighting system was designed, with the intention of providing lighting to current street lighting standards for parks and rural / remote areas where grid connection was not available (see Chapter 2, section 2.5). The design process assumed that such areas would provide relatively good conditions for exploiting the renewable resources available as there would be few buildings to obstruct access to these resources. However, as has been suggested, there is now an increasing demand for renewable powered street lighting systems in the urban environment as local authorities implement ways to reduce their CO₂ emissions.

While the PV circuit provides an important contribution to the total electricity generated by the street lighting system it is considered to be more straightforward to calculate this contribution than that of the wind circuit, hence the focus of this study.

1.4 Summary

There is a clear political demand at all administrative levels for the increased use of renewable energy and this growth potential has been recognised by the UK energy industry⁴⁵. The policy developed at a devolved and at a local level in Wales should encourage the adoption of more renewable energy systems in the principality. The energy required by street lighting is potentially available as a renewable resource and the policies now in place suggest that an increase in demand for renewable powered street lighting systems should be expected over the next decade, particularly given the targets set in Wales for renewable electricity generation. An overview of the policy development for the adoption of renewable energy at different administrative levels is illustrated in figure 6 that highlights the key policy documents.

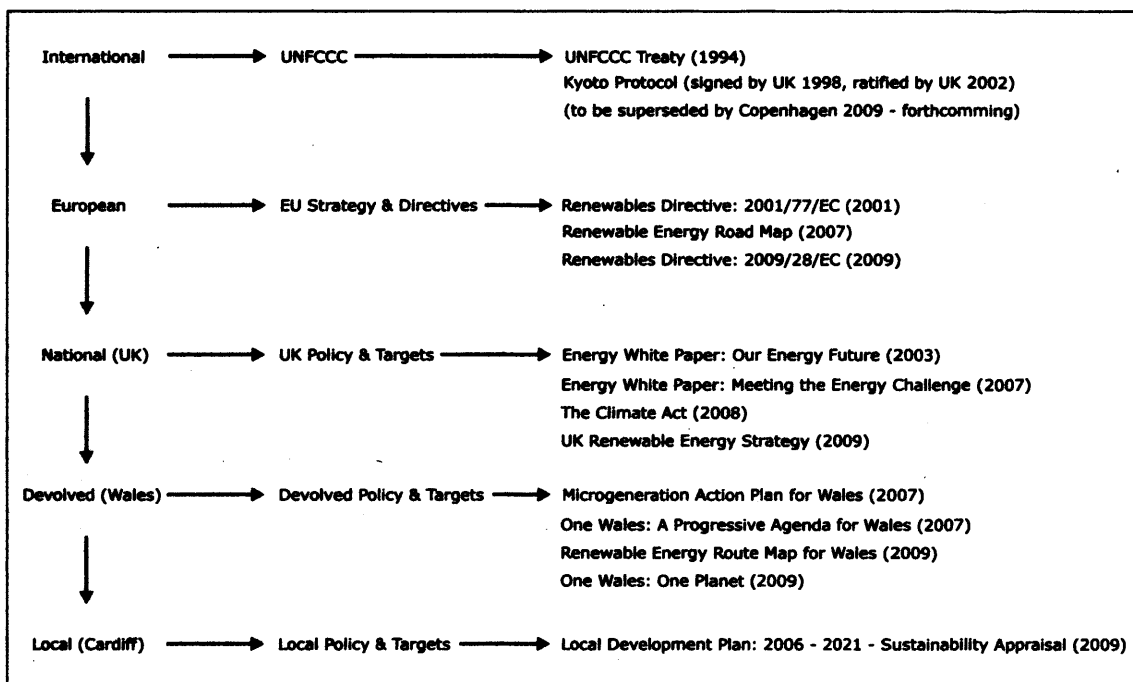

Figure 6: Policy development for the adoption of renewable energy

⁴⁵ Element Energy Ltd, *The growth potential for Micro-generation in England, Wales and Scotland*, BERR, June 2008 (www.berr.gov.uk/energy/microgenerationresearch)

Furthermore, the potential exists for the electrical load required for street lighting to be met from renewable sources. This chapter has identified that current policy objectives at all levels of governance promote the exploitation of renewable resources as a preferred method to reduce the emissions of carbon dioxide associated with electricity generation. Barriers to the deployment of renewable energy systems are being reduced through changes in planning policy and the technology exists to exploit renewable energy resources in the urban environment. The focus of this thesis is on the potential electricity that can be generated from an urban wind resource to provide power for a standalone renewable street lighting system. As such, other issues relating to small wind turbines such as cost, financial payback, noise, vibration and health and safety, are not discussed in detail. Where appropriate, sources of further information are referenced.

1.5 Overview of Chapters

- **CHAPTER 1 - INTRODUCTION**

The aims and objectives of this study are set out in this chapter together with a background to the study including the demand for renewable energy and an overview of the technologies and concepts involved.

- **CHAPTER 2 – STREET LIGHTING**

This chapter presents a review of the standards applicable to street lighting in the UK together with a description of the development of a hybrid renewable energy street lighting system.

- **CHAPTER 3 – URBAN WIND REGIME**

This chapter presents a review of the factors characterising the urban wind regime at different climatic scales, together with a description of data sources and a critical review of current prediction / modelling techniques.

- **CHAPTER 4 – CAPTURING THE WIND RESOURCE**

This chapter presents a review of the opportunities and limitations of small turbines to generate electricity from the wind, together with a technical and critical review of existing siting guidance and published field trial data.

- **CHAPTER 5 – CASE STUDY: SELECTION, MONITORING & MODELLING**

The case study methodology and site description are presented in this chapter together with a description of the equipment and techniques used in the study.

- **CHAPTER 6 – RESULTS & DISCUSSION**

The results of data monitoring and wind tunnel analysis are presented and discussed in this chapter.

- **CHAPTER 7 - CONCLUSIONS**

This chapter summarises the results of the research and presents conclusions drawn against the aims and objectives of the study. Possible further work is then discussed.

***"The EC is working to include street lighting in the carbon reduction commitment. This will provide an incentive for local authorities to improve the energy efficiency of street lights"*⁴⁶**

Joan Ruddock, Minister of State for Energy, House of Commons, June 2009

CHAPTER 2 – STREET LIGHTING

2.0 Introduction

This chapter identifies the standards applicable to street lighting in the UK, both in terms of technical performance and planning constraints. Sources of specific guidance are also discussed. The chapter goes on to describe the development of a hybrid wind and PV street lighting system that meets the requirements of UK standards and establishes the potential load demand to be met from renewable sources.

The standards are directly relevant to this study because they specify where lighting columns may be placed in an urban environment, as well as the technical performance and mounting height of luminaires. The effect of the standards is to limit the areas where street lighting may be located. Certain aesthetic considerations (both in the standards and in planning guidance) also restrict the range of locations and the physical appearance of lighting columns, according to what is deemed appropriate for particular urban situations. The implications of these constraints for hybrid renewable energy street lighting are very significant as they are likely to limit access to the potential renewable resource.

Early in the study a meeting was arranged with Cardiff Council street lighting department. The Council expressed interest in the project and agreed to provide information regarding the approach of the local authority to street lighting in the city. Where information was supplied by the Council either in meetings or by telephone contact, this is indicated.

⁴⁶ Joan Ruddock MP, *House of Commons Written Answers*, Vol. 494, Part 95, 19th June 2009

2.1 The Performance and Practical Requirements of Urban Street Lighting

Street lighting performs several important functions, including road safety (both vehicular and pedestrian) security and amenity, as well as having an aesthetic presence in the public realm. As such, street lighting must meet prescribed standards for performance.

2.1.1 British Standards

The technical design and performance specification for street lighting is set out in the British (and European) Standard BS EN 13201:2003 and the general principles and recommendations for aesthetic and technical aspects are set out in British Standard BS 5489:2003. Further lighting standards relating to working outdoors are set out in BS EN 12464:2007. The key documents, all published by BSI, are listed in table 3 below:

Part:	Title:
BS EN 13201-1	Selection of Lighting Classes
BS EN 13201-2	Performance Requirements
BS EN 13201-3	Calculation of Performance
BS EN 13201-4	Methods of Measuring Lighting Performance
BS 5489-1	Code of Practice for the Design of Road Lighting - Part 1
BS 5489-2	Code of Practice for the Design of Road Lighting - Part 2
BS EN 12464	Lighting of Work Places – Outdoor Work Places

Table 3: Key documents regarding the technical & aesthetic specification of street lighting

BS EN 13201-1:2003 defines types of road users including vehicle users, cyclists and pedestrians and categorises street lighting by 'situations' A1, A2, A3, B1, B2, C1, D1, D2, D3, D4, E1 and E2 based on 'main user speed' in km/h and included / excluded users. A series of 'parameters' is then used in conjunction with the above 'situations' to define the lighting classes. These 'parameters' are grouped into the following headings:

- Area (geometry)
- Traffic Use
- Environmental and External Influences

The following classes are then defined that correspond to the photometric requirements needed to meet the visual needs of road users in certain types of road area and environment (table 4):

Class:	Purpose:
ME	Intended for drivers of motorised vehicles for use on traffic routes, and in some countries also residential roads, allowing medium to high driving speeds.
CE	Intended for drivers of motorised vehicles, but for use on conflict areas such as shopping streets, road intersections of some complexity, roundabouts and queuing areas. These classes have applications also for pedestrians and pedal cyclists.
S & A	Intended for pedestrians and pedal cyclists for use on footways and cycleways, emergency lanes and other road areas lying separately or along the carriageway of a traffic route, residential roads, pedestrian streets, parking areas, schoolyards etc.
ES	Intended as an additional class in situations where public lighting is necessary for the identification of persons and objects and in road areas with a higher than normal crime risk.
EV	Intended as an additional class in situations where vertical surfaces need to be seen in such road areas as toll stations, interchange areas etc.

Table 4: Street Lighting Classes⁴⁷

BS EN 13201-1 also contains detailed performance specifications for the above classes and their associated sub-groups, as well as guidance on appearance and environmental impacts.

BS EN 13201-2 sets out the detailed performance requirements for each of the above lighting classes (table 4). These define the performance requirements of an individual luminaire (and by extension the spacing required for a series of luminaires) to achieve the specified average illuminance (lux) at ground level. In simple terms, for a CE1 class urban area (typical mixed use urban street), the average lux level required at ground level is 30 lux with a minimum illuminance of 10 lux⁴⁸.

BS EN 13201-3 defines and describes the conventions and mathematical procedures to be adopted in calculating the photometric performance of road lighting installations, while BS EN 13201-4:2003 specifies the procedures for making photometric and related measurements of road lighting installations.

⁴⁷ Adapted from BS EN 13201-1:2003

⁴⁸ BS EN 13201-2:2003, section 5, page 9

BS 5489-1 provides additional information to support the BS EN 13201 documents. This document contains a number of points relevant to the study, for example, suggested lamp mounting heights and column horizontal clearances (measured from the base of the column to road edge) are specified (tables 5 & 6).

Road Type:	Lamp Height:
Residential / Subsidiary Roads	5m, 6m
Traffic Routes (urban & other)	8m, 10m, 12m
Dual Carriageways / Motorways	12m, 15m

Table 5: Suggested lamp heights for different road types⁴⁹

Road Speed (km/h):	Horizontal Clearance (m):
50 (30mph)	0.8
80 (50mph)	1.0
100 (60mph)	1.5
120 (70mph)	1.5

Table 6: Column horizontal clearances for different road speeds⁵⁰

The document also specifies that the lamp should be on from 30 minutes after sunset to 30 minutes before sunrise, but that the light output may be varied using "dimming or switching techniques"⁵¹ provided that sufficient output is available for a minimum of 3 hours after sunset and 1 hour before sunrise. Furthermore, in terms of energy consumption, consideration "should be given to the efficiency of the complete lighting installation"⁵².

In addition to the standards discussed above, further guidance on specific issues relating to street lighting (such as minimising the light pollution caused by street lights) are published by the Institute of Lighting Engineers (ILE)⁵³. However, these are of less relevance to this study.

⁴⁹ BS 5489-1:2003, section 5.2.2, page 7

⁵⁰ BS 5489-1:2003, section 5.2.1.2, page 6

⁵¹ BS 5489-1:2003, section 5.4, page 10

⁵² BS 5489-1:2003, section 6.1, page 10

⁵³ <http://www.ile.org.uk> – last accessed June 2009

2.1.2 Planning Issues & Aesthetic Design

The UK Government Department for Transport published the 'Manual for Streets' (MfS) for England and Wales in 2007 that includes a chapter on 'street furniture and street lighting'⁵⁴. This document is based on research by York et al at the Transport Research Laboratory, the results of which were also published in 2007⁵⁵. The MfS is intended to provide guidance for all parties involved in the planning, design, approval or adoption of streets (including street lighting). Similar to the policy documents discussed in section 1.2, this document also stresses the issues associated with climate change and sustainability⁵⁶. The key aims regarding street lighting are to:

- *"describe how street furniture that offers amenity to pedestrians is to be encouraged, but clutter avoided"*
- *"comment on street furniture and lighting design relating to context"*
- *"explain that lighting should be planned as an integral part of the street layout"*
- *"recommend that where lighting is provided it should conform to European standards"*

Street lighting requires planning permission. This is usually an internal matter for local authority departments, as all local authorities have a department responsible for street lighting (whether this is a dedicated department in the case of larger authorities, such as Cardiff, or a combined transport division⁵⁷). Councils are also expected to adopt the street lighting installed by private developers provided that this meets the required standards⁵⁸. Local authorities refer to guidance in the MfS when making decisions and also use this guidance to develop their own local policies. The MfS comments on both the aesthetic appearance of street lighting and performance factors. Table 7 shows the statements that are of particular relevance to this study.

⁵⁴ Department for Transport, *Manual for Streets*, Thomas Telford Publishing, 2007, pages 120 - 126

⁵⁵ York et al, *Manual for Streets: Evidence and Research*, Transport Research Laboratory, 2007

⁵⁶ Department for Transport, *Manual for Streets*, Thomas Telford Publishing, 2007, page 6

⁵⁷ Interview with Bryan Geeves, Principal Engineer, Street Lighting, Cardiff Council, 5th March 2003

⁵⁸ Department for Transport, *Manual for Streets*, Thomas Telford Publishing, 2007, page 136

Section:	Statement:	Relevance:
10.1.1	<i>"Street furniture and lighting equipment have a major impact on the appearance of a street and should be planned as part of the overall design concept".</i>	Suggests that the aesthetic design of the lighting column is an important factor that will be considered in the acceptance of lighting schemes.
10.1.2	<i>"It is especially important that, in historic towns and conservation areas, particular attention is paid to the aesthetic quality of street furniture and lighting".</i>	Further reinforces the above point.
10.3.2	<i>"Lighting may not be appropriate in all locations or contexts. However, if it is to be provided it should be of high quality".</i>	Lighting must comply with the relevant performance standards.
10.3.3	<i>"The potential for planting to shade out lighting through growth should be considered when deciding what to plant".</i>	This statement could equally apply to the shading effect of planting on the renewable resource.
10.3.4	<i>"Lighting columns should be placed so that they do not impinge on available widths of footways in the interests of wheelchair users and people pushing prams, or pose a hazard for blind or partially-sighted people".</i>	Restricts where lighting columns can be placed on pavements – this may have an effect on the energy yield of the system.
10.3.7	<i>"A change of light source to provide whiter lighting can distinguish a residential or urban street from the high-pressure sodium (honey coloured) and the low-pressure sodium (orange coloured) lighting traditionally used on traffic routes".</i>	White lighting that meets the lux requirements for highways tends to have a higher power consumption than high pressure sodium or low pressure sodium. Therefore more power may be needed from the renewable resource.
10.3.11	<i>"Often, lighting suits highway illumination requirements but is not in keeping with the street environment or the range of uses of that street".</i>	Suggests that greater consideration should be made as to the uses of a street to inform the lighting design process.
10.3.15	<i>"Lighting levels do not have to be constant during the hours of darkness".</i>	Would allow the possibility of a lower energy (or power saving) light source to be used for a portion of the time, reducing the amount of energy required from the renewable resource.
10.3.16	<i>"Continuity of lighting levels is important to pedestrians".</i>	Suggests that the spacing of columns and the type of lamp should be uniform for pedestrian areas.
10.3.18	<i>"In street design, consideration should be given to the purpose of lighting, the scale of lighting relative to human users of the street, the width of the street and the height of surrounding buildings".</i>	Suggests that lighting design should be part of a holistic approach to street design.
10.3.20	<i>"While reducing the height of lighting can make the scale more human and intimate, it will also reduce the amount of coverage from any given luminaire. It is therefore a balance between shortening columns and increasing their number".</i>	Regarding the above - relates to aesthetic design vs technical performance.

Table 7: Key statements from the MfS relevant to urban street lighting⁵⁹

Cardiff Council is in the process of producing its own 'Public Realm Manual', a draft of which has been made available for consultation: This expands on the MfS, with various locale specific guidance, although there is minimal detail regarding street lighting in the draft document⁶⁰.

⁵⁹ Adapted from Department for Transport, *Manual for Streets*, Thomas Telford Publishing, 2007

⁶⁰ Department for Strategic Planning and Environment, *Public Realm Manual Consultation*, Cardiff Council, March 2009, pages 53 - 55

Aesthetic design is a subjective issue and it is beyond the scope of this study to comment on the physical appearance of lighting columns in detail. There are no specific standards for aesthetic design, rather recommendations such as in BS EN 13201-2, which demands that consideration be given to the following aspects of street lighting design:

"Day time appearance:

- *Choice of supporting method, for example columns with or without brackets, suspension wires, or direct mounting on buildings.*
- *Design and colour of lighting columns.*
- *Scale and height of lighting columns or other suspension elements in relation to the height of adjacent buildings, trees and other salient objects in the field of view.*
- *Location of lighting columns in relation to views of scenic value.*
- *Design, length and tilt of brackets on columns.*
- *Tilt of luminaire.*
- *Choice of luminaire.*

Night time appearance and comfort:

- *Colour appearance of the light.*
- *Colour rendering of the light.*
- *Mounting height of the luminaire.*
- *Lit appearance of the luminaire.*
- *Lit appearance of the complete installation.*
- *Optical guidance by direct light from the luminaire.*
- *Reduction of light levels in periods".⁶¹*

Mounting a wind turbine and PV modules on a street lighting column clearly has an effect on its aesthetic character. From the recommendations contained in the MfS and in BS EN 13201-2, it is likely that a hybrid renewable street light may be judged to be inappropriate for certain urban situations, such as in historically sensitive sites, on aesthetic grounds. However, there is nothing in the standards or guidance to suggest that such systems should not be deployed more generally in the urban environment. To assess the aesthetic appeal (or otherwise) of hybrid renewable street lighting systems is beyond the scope of this study and would require further research.

⁶¹ BS EN 13201-2:2003, section 7, page 11

2.2 Photometric Data

The following terminology and photometric data are often used by lighting designers and by manufacturers of street lighting equipment:

- Polar intensity curve and utilisation factor table
- Illuminance cone diagram
- Cartesian luminous intensity diagram
- Isolux diagram

The most commonly used⁶² when assessing the suitability of a lamp for use in street lighting are the illuminance cone diagram (figure 7) and the isolux diagram (figure 8). The illuminance cone diagram shows the maximum illuminance at different distances from the source, along with the beam angle and beam diameter relative to distance, as luminous intensity drops to 50%. The isolux diagram is a contour plot showing the distribution of points of equal illuminance on the ground plane for a lamp mounted at a specific height.

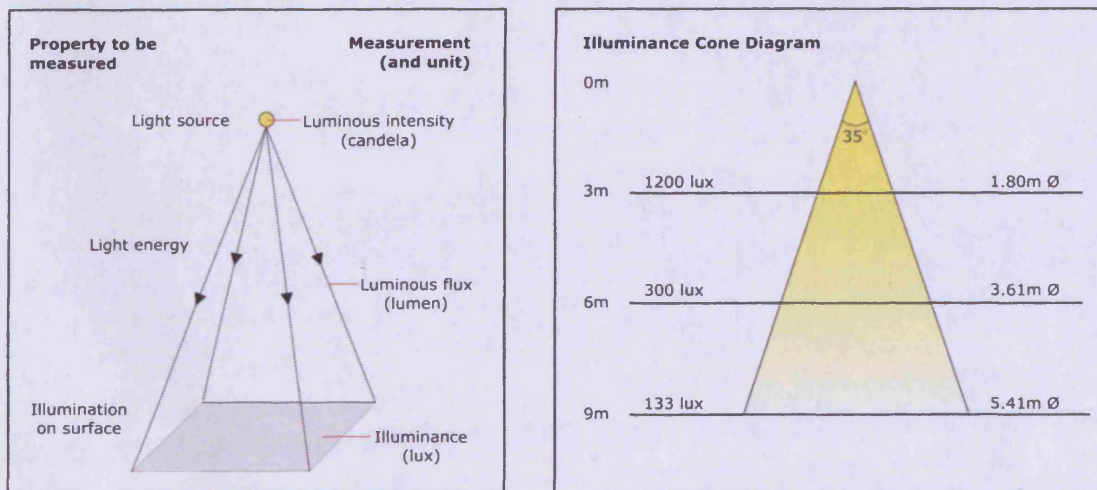

Figure 7: Terminology (left) and sample illuminance cone diagram (right)

⁶² Interview with Bryan Geeves, Principal Engineer, Street Lighting, Cardiff Council, 5th March 2003

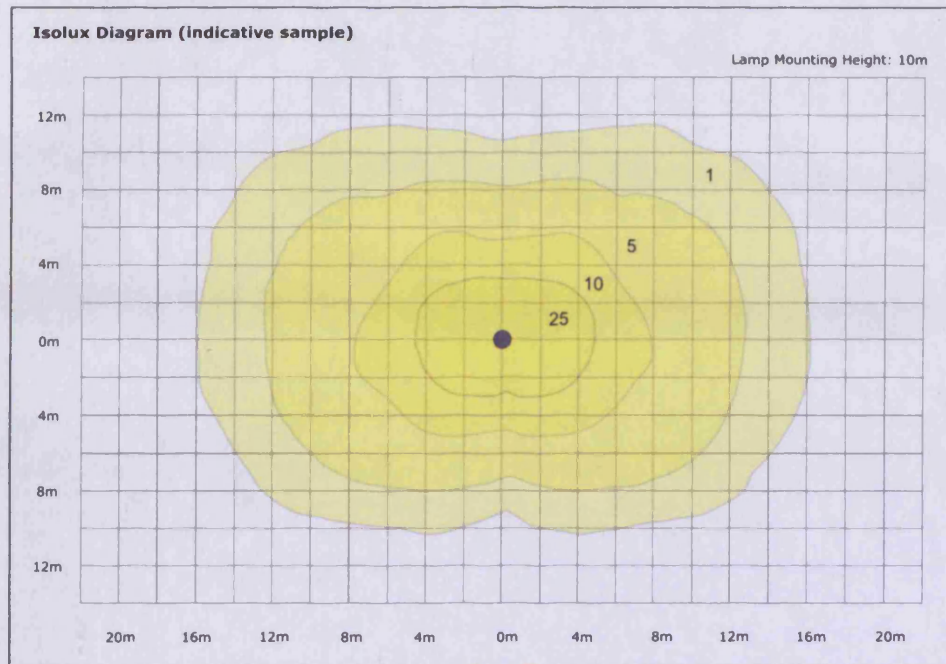

Figure 8: Sample isolux diagram

2.3 Lamp Types and Associated Loads

Information supplied by Bryan Geeves, Principal Engineer for Cardiff Council street lighting department, indicates that the main types of lamp used in Cardiff are low pressure sodium (SOX), high pressure sodium (SON) and metal halide (HPI). Cardiff Council has had an ongoing replacement programme for SOX type lamps as these are considered to have a poor colour rendering, giving a yellow light. SON is now the most common lamp used in the city, although these also give a yellowish light. HPI lamps are used for the main pedestrian and shopping areas, where older lighting columns have been replaced, because they give a white light that gives better colour rendering for both amenity purposes and to facilitate the use of CCTV⁶³ (used extensively in the city centre). A trial of low energy LED street lighting was conducted in the city in 2001 – 2002, using MoonCell⁶⁴ luminaires, although these were not considered to meet the necessary lighting standards and were not taken up by the Council. However, LED lighting has been adopted for traffic lights and some signage applications in the city and the Council is continually reviewing research in this area.

⁶³ As recommended in BS 5489-1:2003, section 5.1.3, page 5

⁶⁴ <http://www.savenergi.com/prodLED.shtml> - last accessed May 2009

Table 8 shows the typical performance of the different lamp types. The main advantage of the SOX type is that it has the highest lumen / watt output (efficacy) of the 3, meaning that it requires less electricity relative to the other types to achieve the same level of illuminance.

Lamp Type	Typical Load (W)	Lumen Output (lm)	Efficacy (lm/W)	Colour Rendering (Ra)
SOX	135W	23,000 lm	170	0
SON	150W	16,500 lm	110	25
HPI	150W	13,500 lm	90	65

Table 8: Typical performance of the 3 main lamp types in Cardiff

There are currently approximately 35,000 street lighting columns in Cardiff together with a further 9,000 illuminated traffic signs⁶⁵. The total energy consumption of these comprises approximately 16% of the total annual energy used by the Council⁶⁶. Table 8 illustrates that as the Council replace SOX lamps with SON lamps the total energy load from street lighting will increase. Therefore the application of renewable energy to help to reduce the carbon emissions associated with this load is of increasing importance, in the absence of lower energy lamps that can meet the required standards.

2.4 Colour Rendering Index

The Colour Rendering Index (CRI), developed by the Commission Internationale de l'Éclairage (CIE)⁶⁷, is a standard quantitative measure of the reproduction of colour that a light source can achieve compared with a natural source when shone on an object. The general colour index (Ra) is used for general applications, including street lighting. This is a scale from 0 to 100, where 0 is poorest and 100 is best compared with a reference source. The typical Ra value for each of the 3 no. light sources discussed is shown in table 8. A further barrier to the current uptake of LED street lighting is that it is difficult to assess the colour rendering of white LED sources using the CRI, as their output spectra differs from the lamp types shown below, although the CIE is hoping to address this with a revised method in 2010⁶⁸.

⁶⁵ Figures from Cardiff City Council Street Lighting Office, July 2009

⁶⁶ Figure from Cardiff City Council Street Lighting Office, July 2009

⁶⁷ <http://www.cie.co.at> – last accessed May 2009

⁶⁸ Luo et al, *CIE Activity Report - Division 1: Vision and Colour*, January 2008, page 21

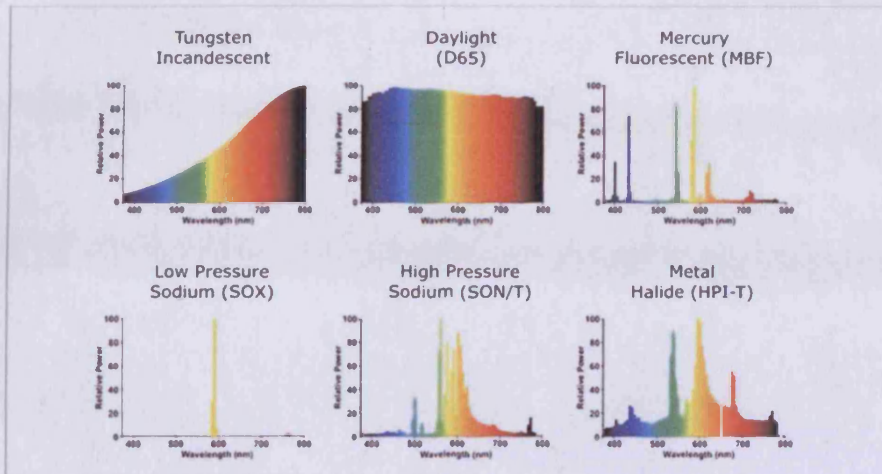

Figure 9: Lamp spectra for various lamp types including SOX, SON and HPI⁶⁹

In terms of colour rendering, SOX lamps give a light output that is monochromatic (very poor colour rendering) due to its very restricted spectral distribution (figure 9). SON lamps give a better colour rendering than SOX but are still relatively poor in the blue / green part of the spectrum compared with a natural source. HPI lamps provide a relatively good colour rendering compared with a natural source as they have a wider spectral range.

The problem (particularly in terms of renewable energy generation) is that the better quality light source, HPI, which is most commonly used in pedestrian areas, has greater energy consumption (lower efficacy) than the other types. Indeed, at peak pedestrian times some of the HPI lamps are ramped up from 150W to 400W to give higher lux levels for amenity and security reasons⁷⁰. Cardiff Council are monitoring developments in LED lighting (particularly Luxeon⁷¹) and also QL induction lighting, as potential future methods of reducing the energy consumption of street lighting in the city.

⁶⁹ Adapted from: <http://www.lamptech.co.uk/Images/Illustrations/SO%20SPD%27s.jpg>
– last accessed July 2009

⁷⁰ Information from Cardiff City Council Street Lighting Office, July 2009

⁷¹ *White Paper: Street Lighting*, Phillips, June 2007 (<http://www.philipslumileds.com/pdfs/WP14.pdf>)

2.5 Street Lighting Design Software

Software design tools used by UK local authority street lighting designers include Lighting REALity (v1.56.3)⁷² and TurboLIGHT (v2.2)⁷³. Both include a library of photometric data from luminaire manufacturers and allow lighting columns to be specified according to lamp height, lamp tilt, reflector type and column spacing. The Lighting REALity tool allows the user to select the lighting standard to be met (UK & Ireland (CEN / BS), Europe (EN) and North America (IESNA)) and can calculate the optimum column spacing required to meet the standard based on the photometric data selected. Sample results are shown in figure 10.

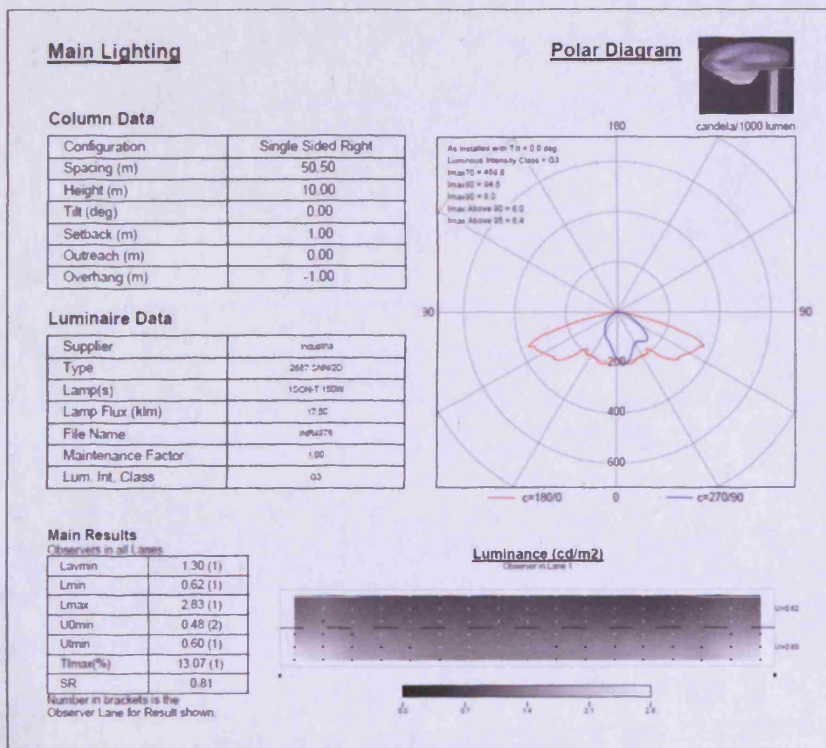

Figure 10: Results summary from Lighting REALity design software⁷⁴

It is possible that as demand grows for renewable powered street lighting a new software tool or add-on module could be developed that takes into account both the lighting standard required and the potential renewable resource available, however, this would require further research.

⁷² <http://www.lightingreality.co.uk/indexuk.htm> - last accessed March 2009

⁷³ <http://www.urbislighting.com> - last accessed March 2009

⁷⁴ Adapted from: Pribyl, J., *Roadway Lighting Report*, INDAL Group, 23rd December 2007

2.6 Development of a Hybrid Wind and PV Street Light

The author was involved in the development of a hybrid wind and PV powered standalone (off-grid) streetlight in 2001, as a member of the design team. The unit was designed to work in rural locations where a street lighting requirement had been identified by local authorities but the costs of cable trenching and grid connection were prohibitively high. As such the system was designed to meet the performance requirements of local authority street lighting (as previously discussed in this chapter). This system can be seen to have the potential to respond to the wider need to reduce carbon emissions associated with street lighting.

In order to build a functional standalone system that can operate with a minimum of maintenance, it is necessary to match the power sources and battery store accordingly to meet the load demand. As part of the development process a mathematical sizing tool was produced to allow battery / load requirements to be matched with the potential energy sources. Details of the development and testing of this model are published in the Energy Technology Support Unit report ETSU S/P2/00340/REP⁷⁵.

Lagorse et al have recently produced a similar model for a hybrid hydrogen fuel cell and PV standalone street light located in Geneva, Switzerland⁷⁶. The main difference between the models is that wind / PV model was primarily designed to size a system that would comply with standards (and could therefore be used in similar locations to existing street lighting), whereas the Lagorse fuel cell / PV model was designed to achieve low cost by balancing the unit cost and ongoing costs (fuel and maintenance) with the minimum area of PV required. The specifications of the hybrid wind / PV street light and the proposed fuel cell / PV street light are compared later in this chapter, based on the findings of the sizing models. Kolhe et al discussed similar concepts in their work on sizing a wind / PV standalone hybrid system with hydrogen production and storage⁷⁷, although in this instance a larger system was proposed that would be unlikely to be appropriate for UK streets.

⁷⁵ Nuh, D., *Hybrolight (ETSU S/P2/00340/REP)*, TSO, 2002

⁷⁶ Lagorse et al., *Sizing optimization of a stand-alone street lighting system powered by a hybrid system using fuel cell, PV and battery*, *Renewable Energy*, Volume 34, 2009, 683 – 691

⁷⁷ Kolhe, M. et al, *Analytical model for predicting the performance of photovoltaic array coupled with a wind turbine in a stand-alone renewable energy system based on hydrogen*, *Renewable Energy*, Volume 28, 2003, pages 727 – 742

2.6.1 Prototype Unit

The prototype unit (figure 11) consisted of an 8 metre steel column, supplied by Transmission and Lighting Ltd, with a battery compartment at the base and a moveable mounting assembly for the PV panels and lamps. The PV array comprised 4 no. BP585F 85W mono-crystalline PV panels, giving a maximum energy output of 340W, and the wind turbine was a Windside WS-0,30C VAWT with swept area of 0.3m² and a maximum rated energy output of 100W (at 10m/s). The battery store comprised 8 no. Yuasa NPC 38-12 12V 38Ah deep cycle gel batteries and the charge controller / timer unit was a Morningstar SunLight-20. Monitoring equipment installed on the prototype system included a calibrated PV reference cell (mounted in the same plane as the PV array) to measure solar radiation and a Vector Instruments A100L2 anemometer and W200P wind vane to measure wind speed and direction. The battery charge cycle was monitored for the 12 month testing period⁷⁸.

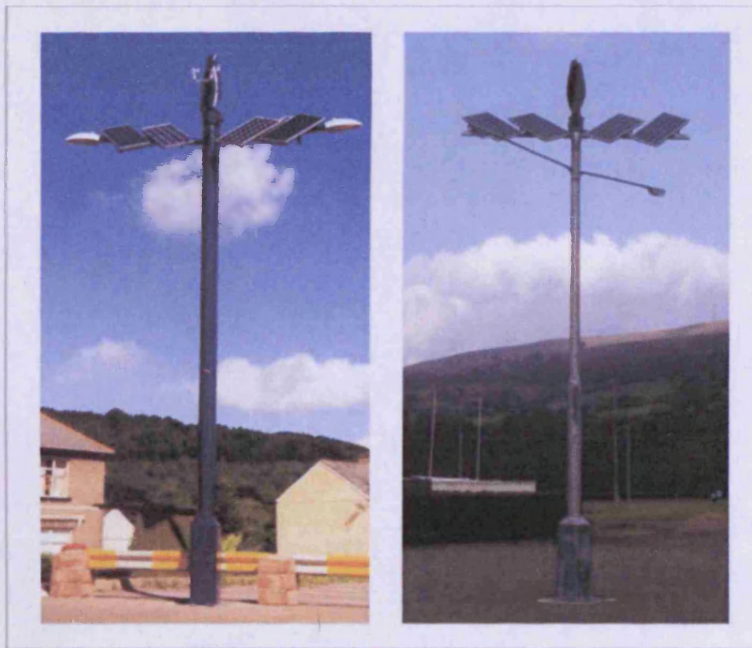

Figure 11: Prototype at the test location (left) and first commercial system (right)

⁷⁸ Nuh D., Rhodes, M., *Development of a Small Hybrid PV & Wind Street Lighting System Using a Specifically Designed Computational Sizing Tool*, Proceedings of the PV in Europe: From PV Technology to Energy Solutions Conference, Rome, WIP Renewable Energies, 2002

2.6.2 First Commercial Unit

A number of design changes were implemented as a result of the prototype test, mainly aesthetic changes to the column. The Windside turbine used for the prototype system was initially selected partly for aesthetic reasons (a VAWT was preferred to a HAWT by the design team) and partly because it was considered more robust than the available small HAWTs. However, more elegant small HAWTs subsequently became available that were considered to be potentially better in terms of energy output. Hence the first commercial system offered the 400W Air-X HAWT turbine, produced by SouthWest Wind Power, as an option (figure 12). For the commercial unit, the PV panels were upgraded to 4 no. BP590F, giving an increase in total PV energy output from 340W to 360W.

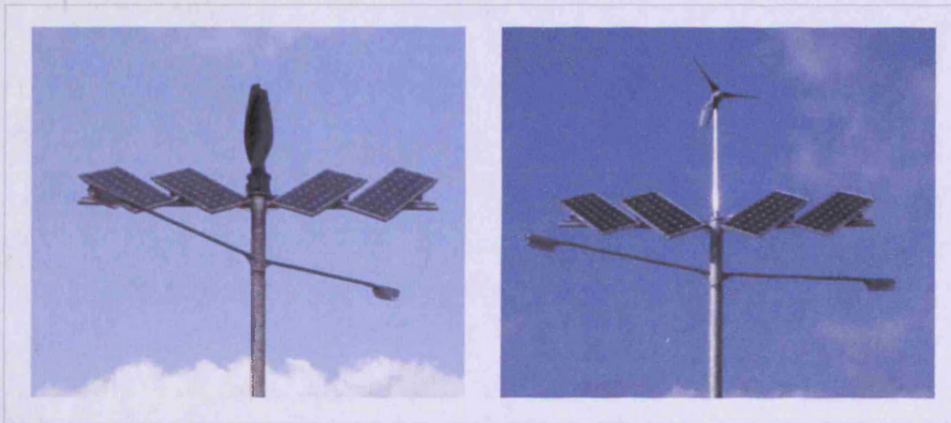

Figure 12: Turbine options: 100W VAWT (left) and 400W HAWT (right)

The commercial system was designed to operate for up to 3 nights without any power generation (i.e. no renewable resource available). The total battery store was 304Ah supplying 2 no. 12V 75W SOX lamps (figure 13). Therefore, assuming that the lamp is switched on for 8 hours per day (and excluding any losses in the system), the calculation is as follows:

- $75\text{W} / 12\text{V} = 6.25\text{A}$ (watts / volts = amps)
- $6.25\text{A} \times 8\text{h} = 50\text{Ah}$ (amps x time = amp hours)
- $50\text{Ah} \times 2 = 100\text{Ah}$ (total for 2 no. 75W lamps for 8 hours)
- $304\text{Ah} / 100\text{Ah} = 3.04 \times 8$ hour periods (sufficient capacity for 3 nights)

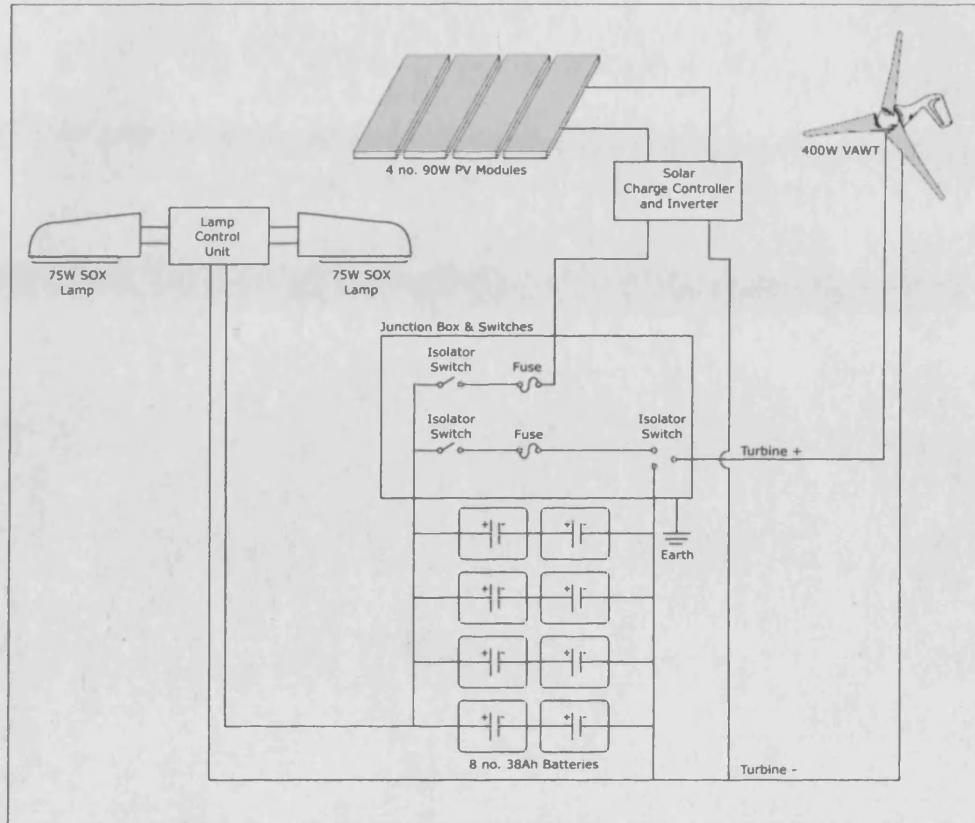

Figure 13: Schematic diagram of the system components

Two commercial units were monitored at their locations in rural areas and these were observed to operate correctly for a period of >12 months. A further system was developed using the same power sources and battery store as above, but with 1 no. 12V 150W HPI lamp to provide a white light source. It is anticipated that with advances in LED lighting the load requirements could in future be reduced. A comparison with the PV / fuel cell LED lighting system proposed by Lagorse et al is shown in table 9, although the latter is not designed to meet the same lighting standards⁷⁹.

Component	Wind / PV Street Light	Fuel Cell / PV Street Light
Wind	100W VAWT or 400W HAWT	N/A
Fuel Cell	N/A	128W Hydrogen PEM Cell
PV	360W Mono-crystalline	148W Poly-crystalline
Battery	304Ah (3.65kWh)	212Ah (2.54kWh)
Lamp	2 no. 75W SOX or 1 no. 150W HPI	1 no. 60W LED

Table 9: Comparison – Wind / PV and Fuel Cell / PV Street Lights

⁷⁹ Lagorse et al., *Sizing optimization of a stand-alone street lighting system powered by a hybrid system using fuel cell, PV and battery*, Renewable Energy, Volume 34, 2009, 683 – 691

2.7 Summary:

From the standards described in this chapter, there are no apparent statutory restrictions barring the deployment of hybrid renewable street lighting in urban environments, other than those limited constraints discussed. By following the standards it is possible to ascertain where such units may be located to meet technical and aesthetic requirements, in terms of light output, hours of use, safety, and to a lesser extent appearance. However, there is no guidance concerning where to locate these systems to take the best advantage of the renewable resource available in an urban environment.

This study will assess the urban wind resource in a case study urban environment and map the output of selected small wind turbines against the available resource. This will indicate to what extent the wind component of a hybrid renewable energy street lighting system can be effective in an urban environment.

"The UK has the best wind resource in Europe"⁸⁰

Maria McCaffery, BWEA Chief Executive, August 2007

CHAPTER 3 – THE URBAN WIND REGIME

3.0 Introduction

This chapter describes the wind at different climatic scales, examines the main factors affecting the urban wind regime and evaluates relevant sources of wind data. In addition, techniques for modelling the urban wind regime are critically reviewed, including analytical models, wind tunnel simulation and software-based modelling.

As has been described in Chapter 1, small wind turbines, of the types proposed for use in hybrid renewable energy street lighting systems, generate electricity from the kinetic energy of the wind. Therefore, a thorough understanding of the wind regime at the intended deployment site is necessary to ensure that the most advantageous location is selected.

3.1 Climate Scales

In meteorology, wind is typically classified in terms of wind speed. A standard wind speed classification table is presented in Appendix A. However, in order to understand the urban wind regime it is necessary to look at additional factors that influence wind movement. A useful way to consider the character of the wind regime is in terms of the following climatic scales⁸¹:

- Macro-scale – the general wind character of a country or region
- Meso-scale – the effect of local topography & vegetation on wind patterns
- Micro-scale – the wind flows at site scale as affected by buildings

⁸⁰ Maria McCaffery, Statement, 30th August 2007 (<http://www.bwea.com/media/news/070830.html>)

⁸¹ Goulding et al, *Energy Conscious Design*, Batsford, London, 1993

3.1.1 Macro-scale Wind Regime

The atmosphere of the Earth can be described as a series of layers (table 10).

Atmospheric Layer:	Height Above Ground:
Exosphere	> 320km – 380km
Thermosphere	80km – 85km to 320km – 380km
Mesosphere	50km – 55km to 80km – 85km
Stratosphere	7km – 17km to 50 – 55km
Troposphere	0km to between 7km – 17km

Table 10: The layers of the atmosphere⁸²

The majority of what we describe as 'weather' occurs in the troposphere, which is largely characterised by the vertical mixing of air⁸³. Weather systems are generated as solar radiation heats the surface of the planet causing temperature gradients, combined with gravitational effects such as tides and the Coriolis effect (figure 14). The complex interaction of heat energy, air pressure, evaporation (moisture) and wind, results in weather events. These events can be recorded over time to establish patterns. For example, the British Meteorological Office (Met Office) began recording mean wind speed data (and from this wind patterns) in parts of the UK from around 1850⁸⁴.

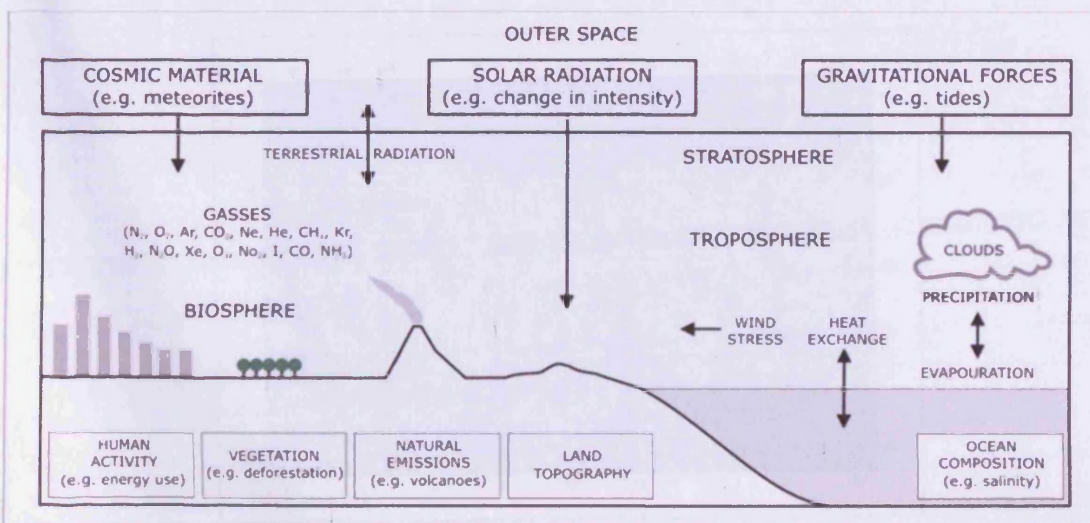

Figure 14: Main factors influencing the climate system (after Asimakopulos)

⁸² Adapted from NASA data sheet (<http://www.nasa.gov>) – last accessed June 2009

⁸³ Asimakopulos, D., *Energy & Climate in the Urban Built Environment*, James & James, 2001, p. 20

⁸⁴ <http://www.metoffice.gov.uk/climate/uk> - last accessed July 2009

Based on mean wind speeds over a 20 year period, the UK has the greatest potential wind resource of the western European countries (figure 15). This may also indicate that there is a good wind resource in UK cities.

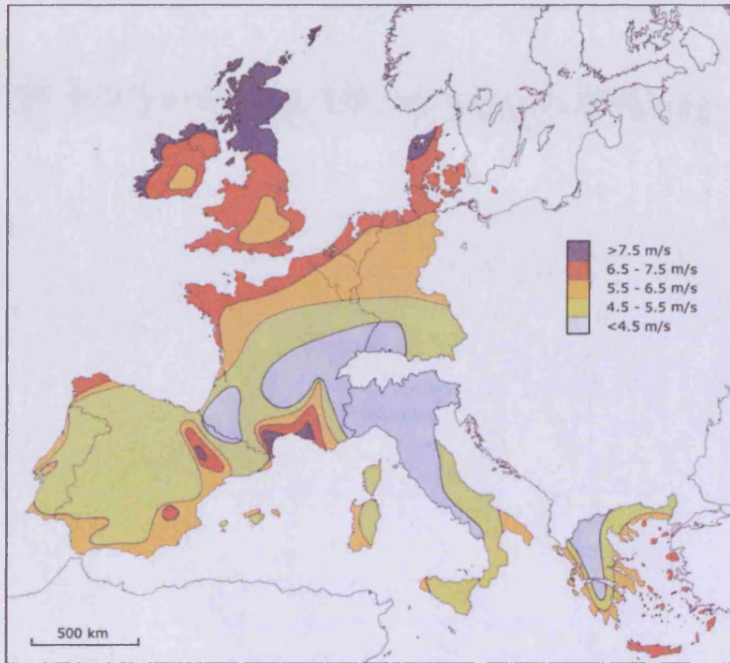

Figure 15: The distribution of wind resources in Europe (at 50m level)⁸⁵

The most frequent wind directions in the UK are west and southwest, with weather systems approaching from the Atlantic Ocean⁸⁶ (figure 16).

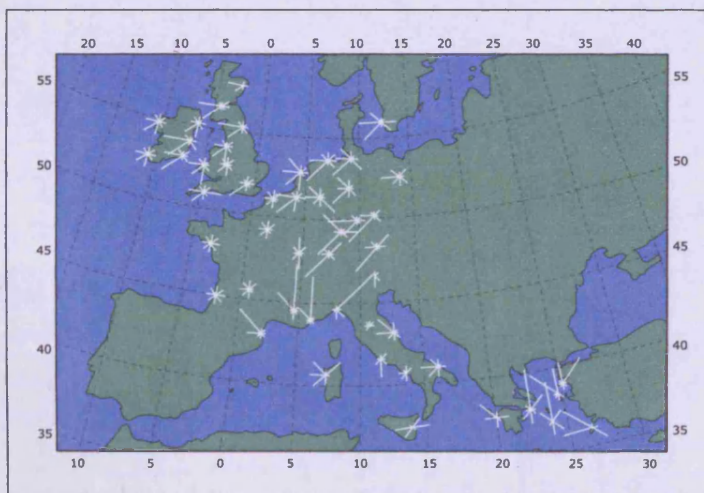

Figure 16: Annual frequency of wind direction, Europe⁸⁷

⁸⁵ Adapted from: Troen, I., Petersen, E.L., *European Wind Atlas*, Riso Laboratory, 2000, page 37

⁸⁶ Bahaj et al, *Urban energy generation: Influence of micro-wind turbine output on electricity consumption in buildings*, Energy and Buildings, volume 39, 2007, pages 154-165

⁸⁷ Goulding et al, *Energy Conscious Design*, Batsford, London, 1993, page 27

3.1.2 Meso-scale Wind Regime

The term 'meso-scale' covers a broad range of phenomena and is often subdivided into scales of 1000-100km, 100-10km and 10-1km, known as meso- α , $-\beta$ and $-\gamma$ respectively⁸⁸. The lowest level of the troposphere is usually referred to as the Planetary Boundary Layer (PBL). This extends to a height of approximately 3000m above ground level and is characterised by the turbulent effects of aerodynamic drag caused by surface roughness (figure 17). Meso- γ effects are usually restricted to the PBL⁸⁹.

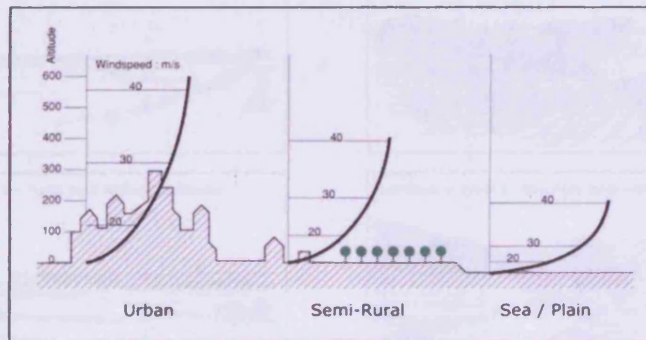

Figure 17: PBL showing the effect of surface roughness on the wind profile

Topography affects wind flows over land, with features such as hills and valleys leading to areas of relative wind shelter and areas of over-exposure. Typically the crests of hills experience accelerated wind flow as the air stream is compressed in flowing up the hill face⁹⁰. In this instance, the lee side of the hill typically experiences shelter or 'wind shadow' (figure 18).

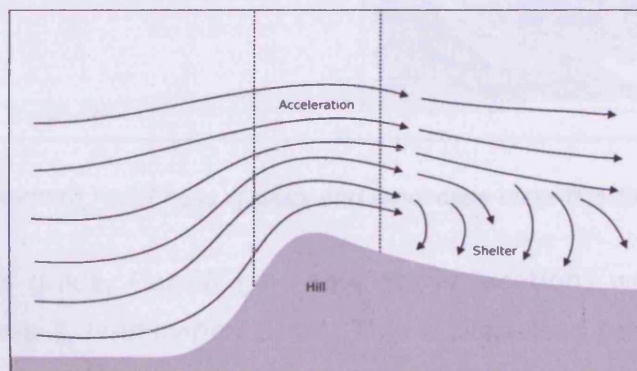

Figure 18: Wind flow over a hill

⁸⁸ Best, M. et al, *Small Scale Wind Technical Report*, Met Office, 2008, page 40

⁸⁹ Goulding et al, *Energy Conscious Design*, Batsford, London, 1993, page 43

⁹⁰ Jackson, P.S., Hunt J.C.R., *Turbulent Wind Flow Over a Low Hill*, Quarterly Journal of the Royal Meteorological Society, Vol. 101, Issue 430, October 1975, pages 929 - 955

The European Wind Atlas (EWA) provides a useful visual guide for assessing topography, based on roughness class and landscape type (figure 19).

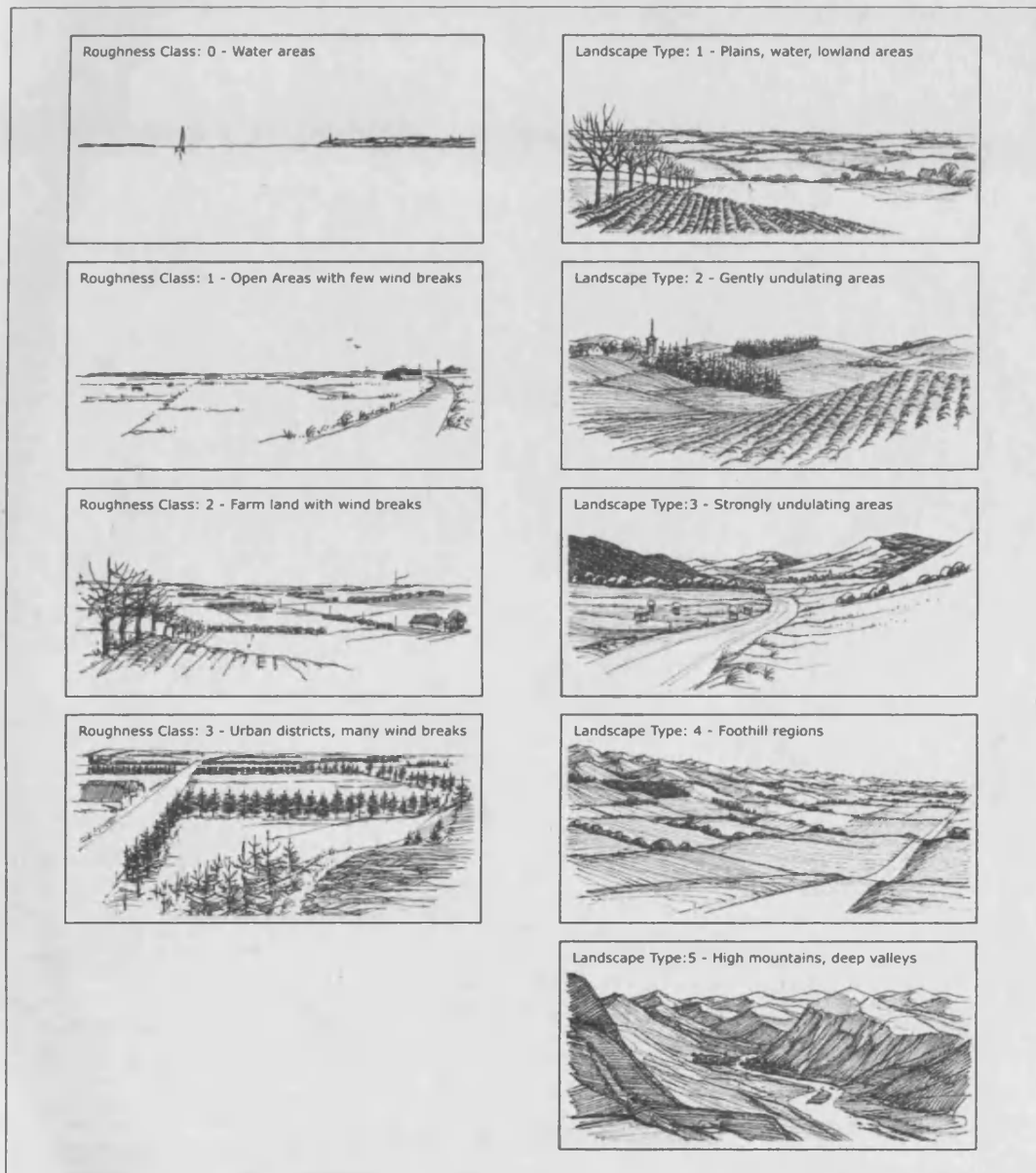

Figure 19: Visual guide to roughness classes and landscape classifications⁹¹

According to this guide, Cardiff (the case study location) would be classified as roughness class 3, landscape class 1. This is discussed further in Chapter 5 and the roughness classes are explained further in section 3.1.3. The EWA uses these categories as the basis to predict wind speeds for different topographic conditions from recorded data for stations around Europe.

⁹¹ Adapted from Troen, I., Petersen, E.L., *European Wind Atlas*, Riso Laboratory, 2000, pages 18 - 23

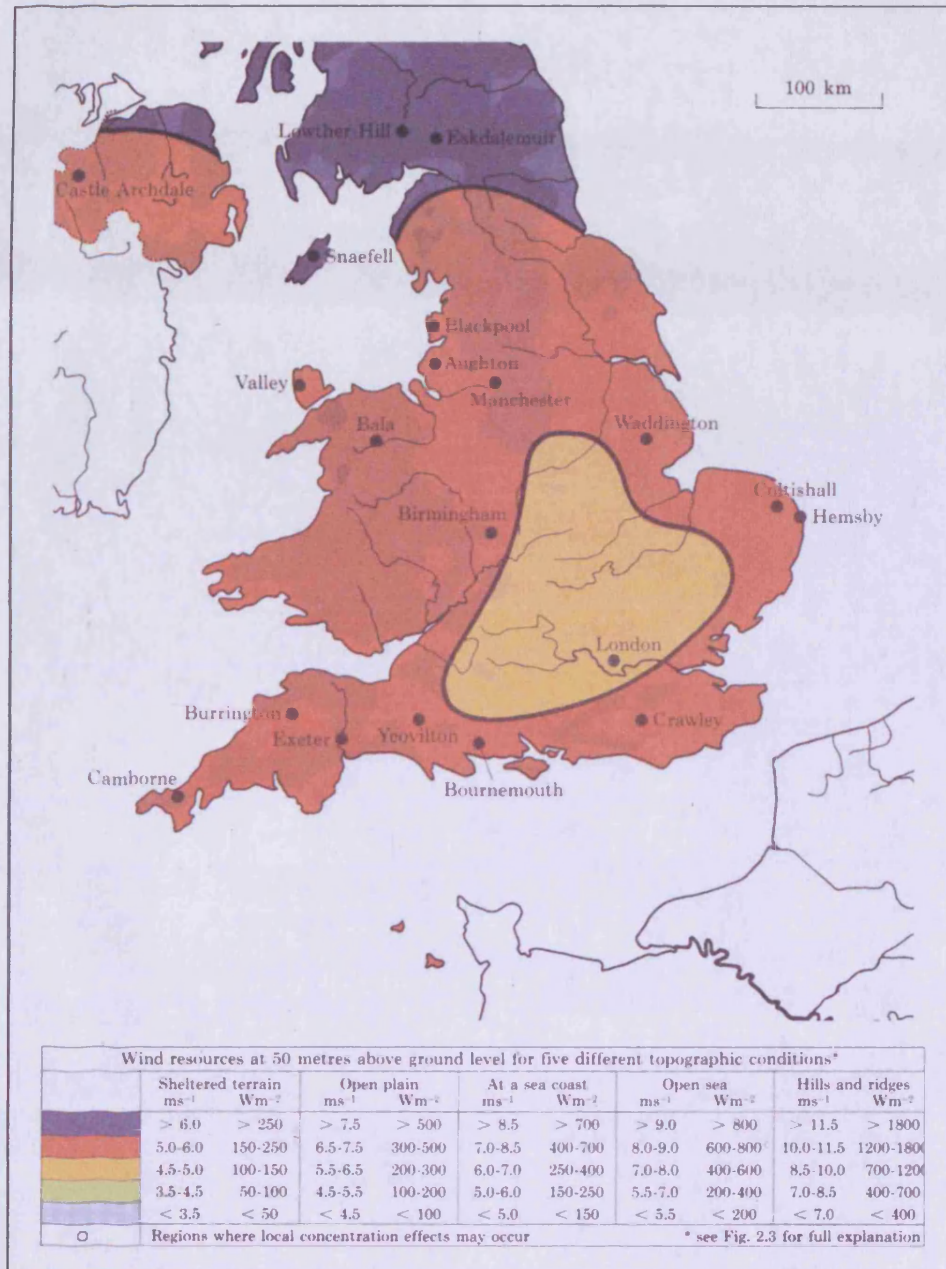

Figure 20: UK wind resources for different topographic conditions⁹²

EWA calculations suggest that the greatest wind resource (>6.0m/s for sheltered areas) is found in Scotland, while Wales has a greater resource than central England (figure 20). The Met Office has published actual monthly mean wind speed data for the UK for the period 1971 - 2000 that agrees with this analysis (figure 21). The data are presented graphically, based on 1 km grid-point data sets covering the 30 year averaging period⁹³.

⁹² Troen, I., Petersen, E.L., *European Wind Atlas*, Riso Laboratory, 2000, page 39

⁹³ <http://www.metoffice.gov.uk/climate/uk/averages/ukmapavge.html> - last accessed July 2009

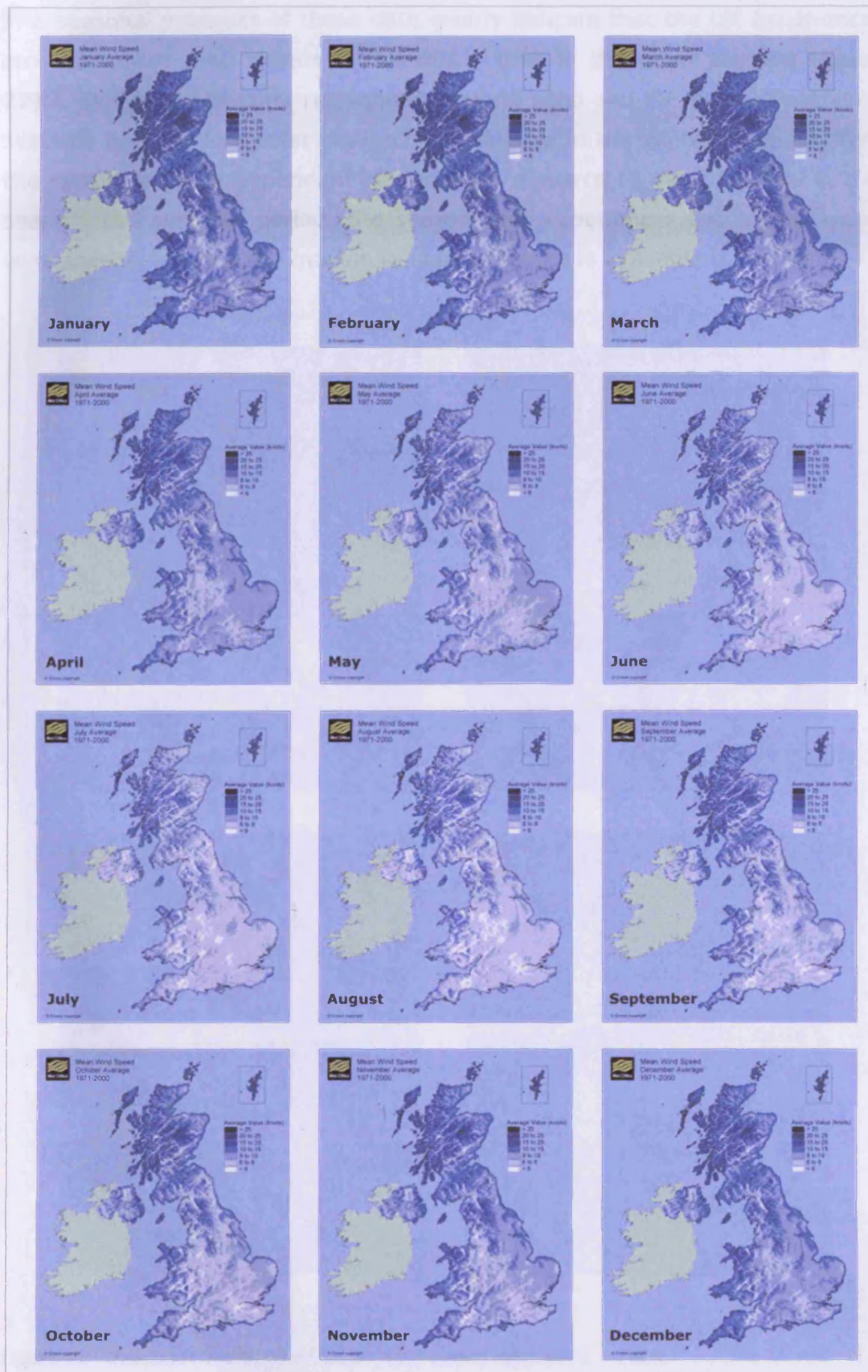

Figure 21: Monthly mean wind speed data for UK 1971 - 2000

The seasonal averages of these data clearly indicate that the UK experiences stronger mean wind speeds in the winter than in the other seasons (figure 22)⁹⁴. This is of particular relevance to hybrid wind and PV renewable energy systems because less solar resource is available in the winter, meaning that the system is more dependant on the wind resource to meet its load in this season. The summer period, the season that experiences the lowest mean wind speeds, is when the maximum solar resource is available to the PV.

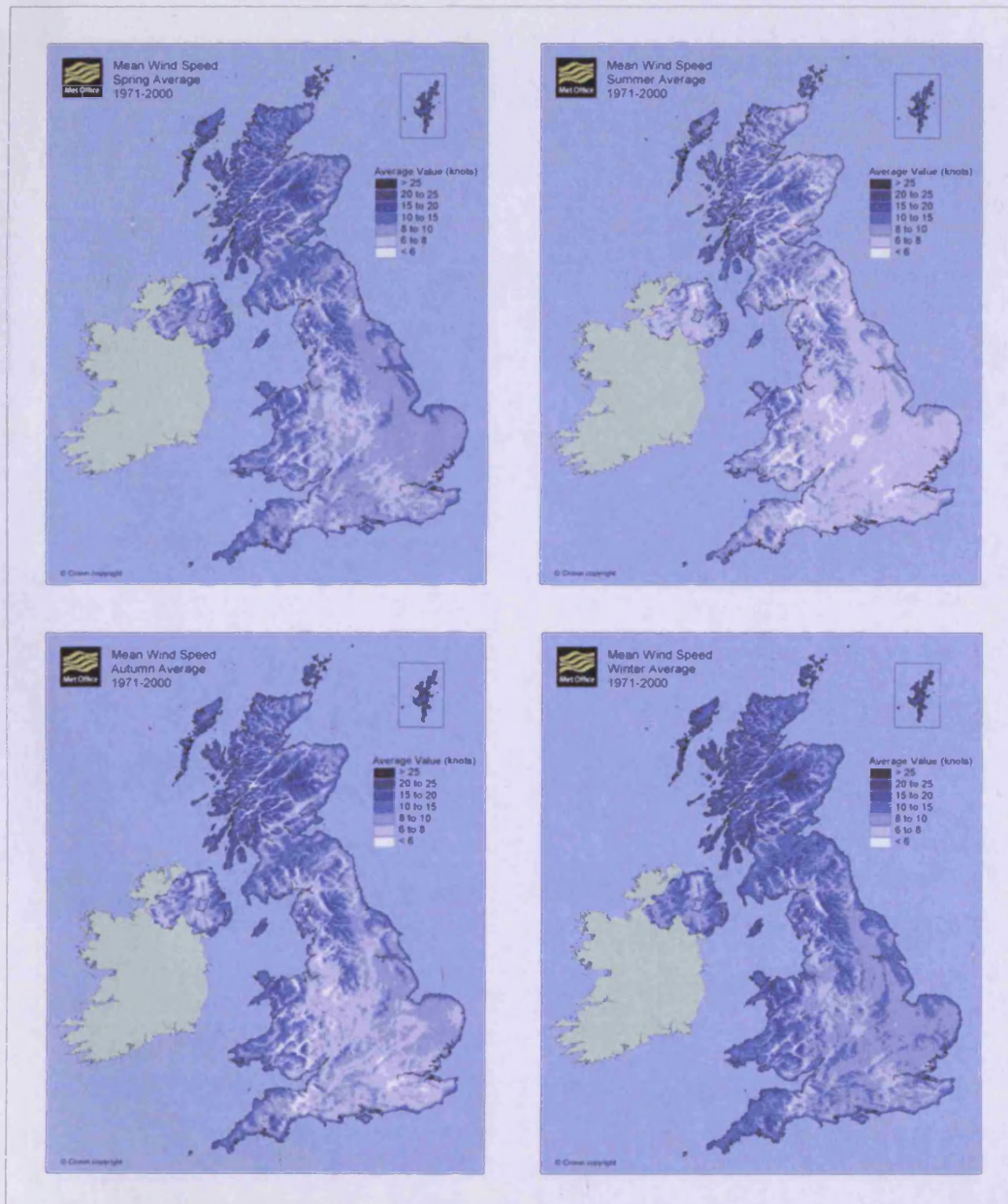

Figure 22: Seasonal averages of mean wind speed data 1971 – 2000

⁹⁴ <http://www.metoffice.gov.uk/climate/uk/averages/ukmapavge.html> - last accessed July 2009

Sinden defines wind speeds of <4m/s as low wind speeds⁹⁵. From an analysis of Met Office hourly wind speed data from several UK stations, Sinden reports that on average there is only one hour per year when 90% of the UK experiences wind speeds of <4m/s. These events are more likely to happen in summer when mean wind speeds are at their lowest (figure 22). The findings for winter suggest that these conditions occur for 90% of the UK for one hour in every 5 years. Sinden reports that there were no hours for which 100% of the UK experienced wind speeds <4m/s. High wind speeds are defined as those >25m/s. Wind speeds of this magnitude are very rare in the UK, occurring for only 0.1% of the total hours across all sites in the study. The windiest of the sites studied had speeds >25m/s for <2% of the total hours.

For comparison, the small wind turbines listed in this study begin to generate electricity at wind speeds from 2 m/s – 3.58 m/s (see section 4.6). Therefore, the reported analysis suggests that, based on wind speeds at a meso-γ scale (not taking into account surface obstructions), there should be a sufficient wind resource in most parts of the UK for small wind turbines to operate at some capacity for most of the time. As the Sinden study is based on Met Office data, it is not surprising that the results reflect the published mean wind speed data (figure 22), however, this study does provide useful additional detail of the wind regime at the meso-γ scale.

'Urban breeze' is a phenomenon of the meso-γ scale wind regime that may occur in light wind conditions as a result of the urban heat island effect. Lemonsu and Masson reported that in extreme conditions (i.e. mid-summer, no mean wind), *"this may reach as much as 5-7 m/s at 200m"*⁹⁶ (i.e. speeds well within the operational range of a small wind turbine). However, from the findings reported by Sinden (above), that light wind conditions occur very infrequently in the UK, it is reasonable to assume that the occurrence of this effect in the UK would also be very rare. Best et al state that, *"it is likely that conditions favourable for urban breezes strong enough to provide a significant wind power resource are quite rare over the UK (i.e. a few days per year at most), so it is likely to be a reasonable approximation to neglect this effect"*⁹⁷.

⁹⁵ Sinden, G., *Wind Power and the UK Wind Resource*, Environmental Change Institute, Oxford University, 2005, page 4

⁹⁶ Lemonsu, A., Masson, V., *Simulation Of A Summer Urban Breeze Over Paris*, Boundary-Layer Meteorology, Volume 104, 2002, pages 463-490

⁹⁷ Best, M. et al, *Small Scale Wind Technical Report*, Met Office, 2008, page 43

3.1.3 Micro-scale Wind Regime

The micro-scale wind regime can be described as the meso-γ scale wind regime as modified by surface features (obstructions). As has been described, wind flows in the planetary boundary layer (PBL) are characterised by a certain amount of turbulence, depending on the surface roughness⁹⁸. Figure 23 shows a visualisation of the PBL produced in a boundary layer wind tunnel (BLWT) by illuminating oil seeded particles with a green laser⁹⁹. However, the micro-scale wind regime in a city is characterised more by the effect of site features (such as building geometry, building spacing, street furniture and trees) on this turbulent wind flow¹⁰⁰.



Figure 23: Planetary Boundary Layer wind flow visualised in a BLWT

Open countryside can provide areas where a reasonably laminar wind flow is available to wind turbines, particularly when a turbine is mounted on a tall mast on high ground. However, in urban areas the sharp edges of buildings can cause flow separation¹⁰¹ leading to areas of high turbulence and velocity gradients that "can be problematic for small wind turbines"¹⁰². Hence, current micro-scale guidance for siting turbines is largely focussed on rural sites where conditions for power generation are potentially better (see Chapter 4).

⁹⁸ Plate, E.J., Kiefer, H., *Wind loads in urban areas*, Journal of Wind Engineering and Industrial Aerodynamics, Volume 89, 2001, pages 1233 – 1256

⁹⁹ SAFL BLWT (http://efd.safl.umn.edu/research/wind_tunnel) – last accessed July 2009

¹⁰⁰ Ricciardelli, F., Polimeno, S., *Some characteristics of the wind flow in the lower Urban Boundary Layer*, Journal of Wind Engineering and Industrial Aerodynamics, Vol. 94, 2006, pages 815 – 832

¹⁰¹ Castro, I.P., Cowan, I.R. and Robins, A.G., *Simulations of flow and dispersion around buildings*, Journal of Aerospace Engineering, 12, 1999, pages 145-160

¹⁰² Dutton, A.G, et al, *The Feasibility of Building Mounted / Integrated Wind Turbines*, Science & Technology Facilities Council, May 2005, page 17

Obstructions to the wind flow may either be solid (such as walls and glazing) or permeable (such as vegetation). The effect of isolated objects on wind flow is well understood¹⁰³. Solid obstructions with sharp edges typically cause wind flows to become separated, leading to areas of high turbulence and variable velocity, as well as areas of recirculation in the lee of the wind flow, characterised by low pressure, low velocity air movement (figure 24). Also typical is vertical flow (updrafts and downdrafts) on building facades.

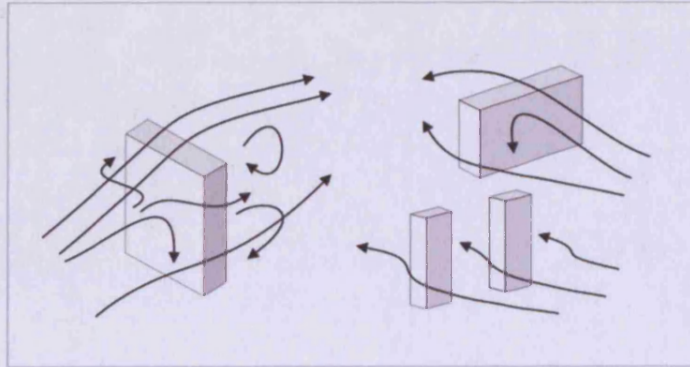

Figure 24: Effect of solid obstructions on wind flow¹⁰⁴

Permeable obstructions allow some of the wind flow to pass through them while some is deflected around the object. The intensity of this effect varies with the height of the object and its permeability to wind¹⁰⁵. The permeability of an object may itself vary, for example, deciduous trees deflect more of the wind flow when they are in leaf than in the winter months (figure 25). Typically, surface obstructions are referred to as roughness elements¹⁰⁶.

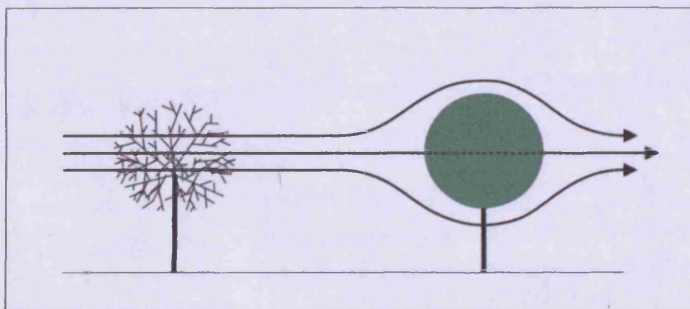

Figure 25: Effect of permeable obstructions on wind flow¹⁰⁷

¹⁰³ Santamouris, M. *Energy & Climate in the Urban Built Environment*, James & James, 2001, p. 75

¹⁰⁴ Adapted from Goulding et al, *Energy Conscious Design*, Batsford, London, 1993, page 43

¹⁰⁵ Wilson, J. D., *Numerical studies of flow through a windbreak*, Journal of Wind Engineering and Industrial Aerodynamics, Volume 21, 1985, pages 119 - 154

¹⁰⁶ Best, M. et al, *Small Scale Wind Technical Report*, Met Office, 2008, page 21

¹⁰⁷ Adapted from Goulding et al, *Energy Conscious Design*, Batsford, London, 1993, page 43

Surface roughness (discussed briefly in section 3.1.2) affects both the mean wind speed and its turbulent characteristics and is described by an effective aerodynamic roughness length¹⁰⁸. In simple terms, the wind speed is higher near the ground over a smooth surface than over a rougher surface. It is therefore possible to extrapolate the wind speed at different heights from the roughness length in situations where there is limited wind speed data. An urban environment typically includes buildings of a range of heights located within a network of roads and streets and interspersed with other features such as trees, parks and squares. Therefore, urban environments have a high roughness length compared with open rural areas (table 11)¹⁰⁹.

Roughness Length (m)	Roughness Class	Landscape Type
0.0002	0	Water surface
0.0024	0.5	Completely open terrain with a smooth surface (e.g. concrete runways in airports, mowed grass, etc)
0.03	1	Open agricultural area without fences and hedgerows and very scattered buildings, softly rounded hills
0.055	1.5	Agricultural land with some houses and 8m tall sheltering Hedgerows with a distance of approximately 1250m
0.1	2	Agricultural land with some houses and 8m tall sheltering Hedgerows with a distance of approximately 500m
0.2	2.5	Agricultural land with many houses, shrubs and plants, or 8m tall sheltering hedgerows with a distance of approximately 250m
0.4	3	Villages, small towns, agricultural land with many or tall sheltering hedgerows, forests and very rough and uneven terrain
0.8	3.5	Larger cities with tall buildings
1.6	4	Very large cities with tall buildings and skyscrapers

Table 11: Roughness lengths and classes for different landscape types

From table 11, Cardiff (the case study location) would be described as having a roughness length of around 0.8m (roughness class 3.5) suggesting that wind speeds at near ground level ($\leq 10\text{m}$) could be expected to be relatively low.

¹⁰⁸ BS6399-2:1997 Code of Practice for Wind Loads

¹⁰⁹ Syngellakis K., Traylor, H., *Urban Wind Resource Assessment in the UK*, European Commission, February 2007, page 9

Piggot provides a 'rule of thumb' table for the effect of roughness on wind speed at 10m and 20m heights (table 12)¹¹⁰. Piggot reports that these figures provide a reasonable estimate of wind speed for simple sites (i.e. where the roughness class is uniform for large distances in all directions and where there are no significant changes in topography).

Roughness Class	Height: 10m	Height: 20m
0	6.9 m/s	7.5 m/s
1	5.5 m/s	6.2 m/s
2	4.7 m/s	5.5 m/s
3	3.5 m/s	4.5 m/s

Table 12: The effect of roughness on wind speed

The effect of a high roughness length (r) is that the acceleration of wind speed as height increases is slower (i.e. the profile is vertically displaced)¹¹¹, resulting in lower energy yields for a given turbine hub height (figure 26).

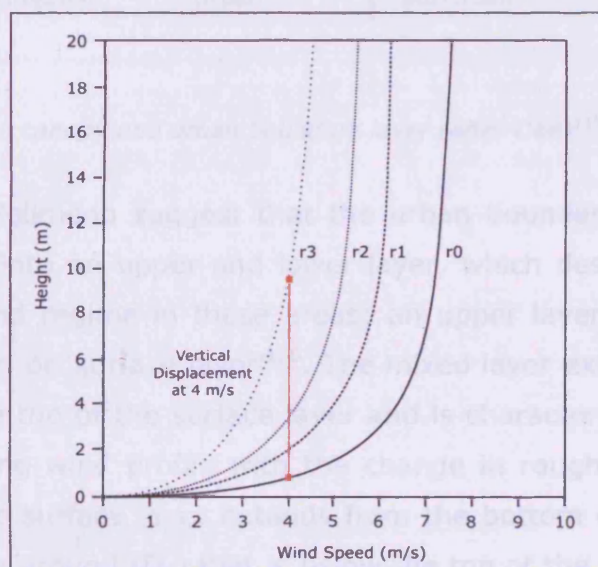

Figure 26: Vertical displacement of wind speed at different roughness classes

However, at high roughness lengths, wind speed at near ground level ($\leq 10\text{m}$) becomes highly dependant on local conditions (building geometry, etc). Heath et al report that it is not possible to extrapolate wind speed from the average surrounding roughness characteristics without applying further corrections¹¹².

¹¹⁰ Piggot, H., *Choosing Windpower*, Centre for Alternative Technology, 2006

¹¹¹ MacDonald, R.W., *Modelling the mean velocity profile in the urban canopy layer*, *Boundary-Layer Meteorology*, Volume 97, 2000, pages 25 – 45

¹¹² Heath et al., *Estimating the Potential Yield of Small Building-mounted Wind Turbines*, *Wind Energy*, Volume 10, 2007, pages 271 – 287

In a review of past research, Syngellakis and Traylor state that, "two features particularly characterise the urban wind regime: lower annual mean wind speeds compared to rural, open areas, and more turbulent flow"¹¹³. The changed nature of the PBL over urban areas has been described in terms of the urban canopy (profile of building heights) and the urban boundary layer (the PBL over urban areas as affected by the urban canopy). Figure 27 illustrates this concept, where the urban canopy is defined as the "space bounded by the urban buildings up to their roofs"¹¹⁴.

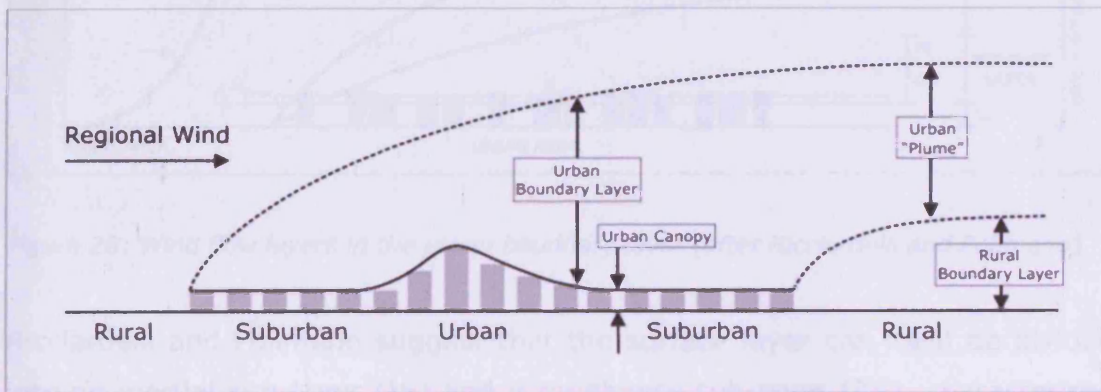

Figure 27: The urban canopy and urban boundary layer (after Oke)¹¹⁵

Ricciardelli and Polimeno suggest that the urban boundary layer (UBL) can itself be divided into an upper and lower layer, which describe the different influences on wind regime in these areas; an upper layer, or 'mixed layer', and a lower layer, or 'surface layer'¹¹⁶. The mixed layer extends from the top of the UBL to the top of the surface layer and is characterised by the mixing of the approaching wind profile with the change in roughness of the urban environment. The surface layer extends from the bottom of the mixed layer to a height above ground (D_u) that is below the top of the canopy layer (CL), considered to be between 2/3 to 9/10 of the average canopy height (H_{mean}). The surface layer is characterised by the effects of the urban geometry. Figure 28 illustrates these concepts.

¹¹³ Syngellakis K., Traylor, H., *Urban Wind Resource Assessment in the UK*, European Commission, February 2007, page 7

¹¹⁴ Santamouris, M. *Energy & Climate in the Urban Built Environment*, James & James, 2001, p. 69

¹¹⁵ Santamouris, M. *Energy & Climate in the Urban Built Environment*, James & James, 2001, p. 33

¹¹⁶ Ricciardelli, F., Polimeno, S., *Some characteristics of the wind flow in the lower Urban Boundary Layer*, *Journal of Wind Engineering and Industrial Aerodynamics*, Vol. 94, 2006, pages 815 – 832

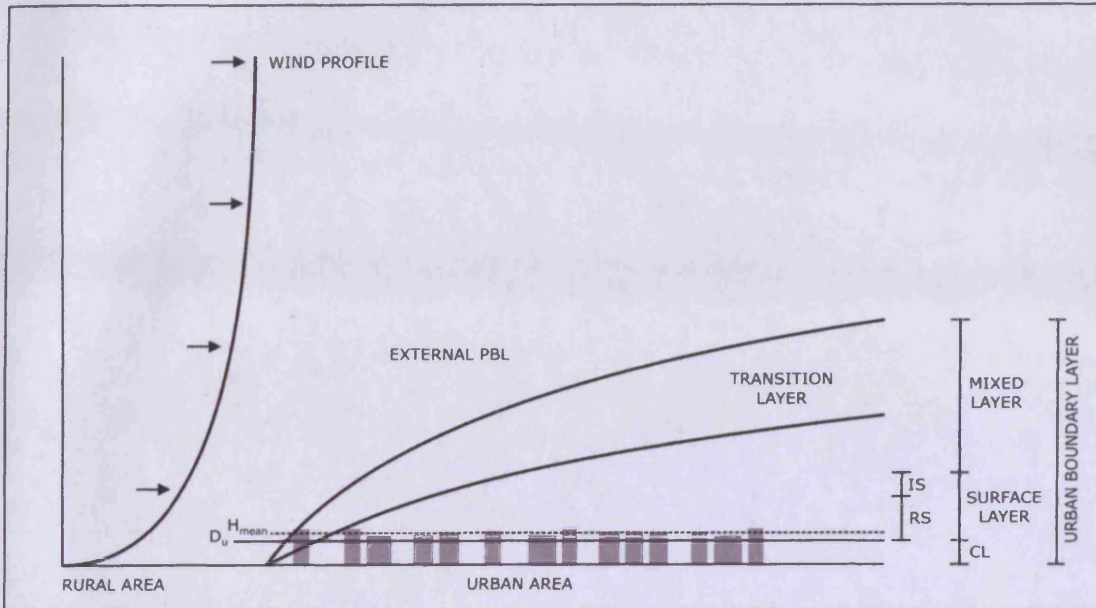

Figure 28: Wind flow layers in the urban boundary layer (after Ricciardelli and Polimeno)

Ricciardelli and Polimeno suggest that the surface layer can itself be divided into an inertial sub-layer (IS) and a roughness sub-layer (RS), characterised by the uniformity of building height and street width, with the separation "ranging between an elevation of twice to five times the height of the buildings"¹¹⁷. Meanwhile, Roth reports that this region extends to "about 2.5 to 3 times the height of the buildings"¹¹⁸ based on a review of 14 studies selected for their high quality and comparability. Plate and Kiefer suggest that the combined thickness of the CL and the RS (canopy and blending region) is usually of the order of 50m – 100m depending on the average height of the building complex¹¹⁹.

The aspect ratio (ratio of the average building height to the average street width, H/W) affects the type of flow regime experienced. Oke identified three main types of flow regime: isolated roughness flow, wake interference flow and skimming flow¹²⁰. These are represented schematically in figure 29.

¹¹⁷ Ricciardelli, F., Polimeno, S., *Some characteristics of the wind flow in the lower Urban Boundary Layer*, Journal of Wind Engineering and Industrial Aerodynamics, Vol. 94, 2006, pages 815 – 832

¹¹⁸ Roth, M., *Review of atmospheric turbulence over cities*, Quarterly Journal of the Royal Meteorological Society, Volume 126, 2000, pages 941– 990

¹¹⁹ Plate, E.J., Kiefer, H., *Wind loads in urban areas*, Journal of Wind Engineering and Industrial Aerodynamics, Volume 89, 2001, pages 1233 – 1256

¹²⁰ Oke, T.R., *Street design and urban canopy layer climate*, Energy and Buildings, Volume 11, 1988, pages 103-113

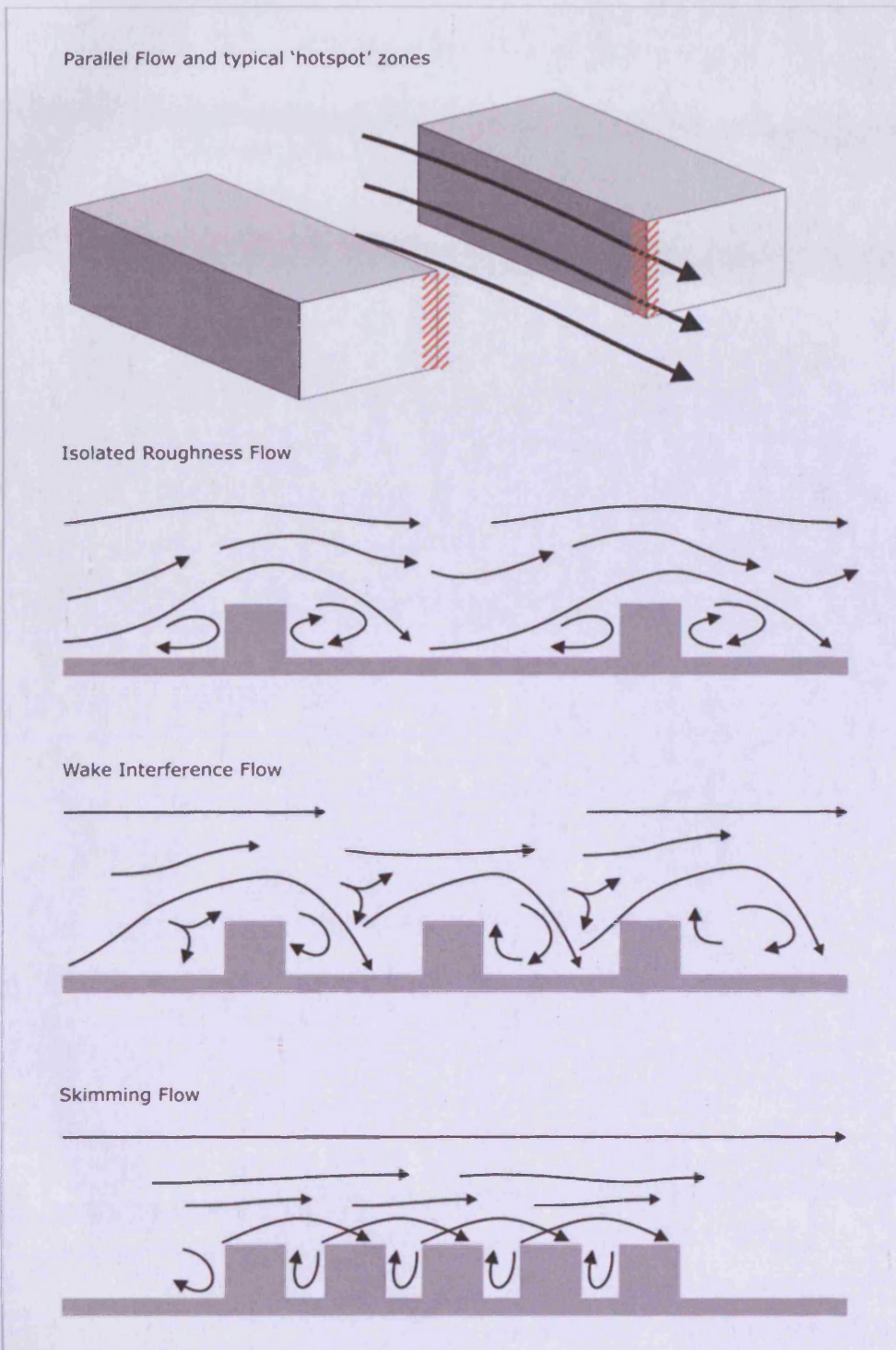

Figure 29: Typical wind flow regimes over urban areas (adapted from Oke)¹²¹

¹²¹ Oke, T.R., *Street design and urban canopy layer climate*, Energy and Buildings, Volume 11, 1988, pages 103-113

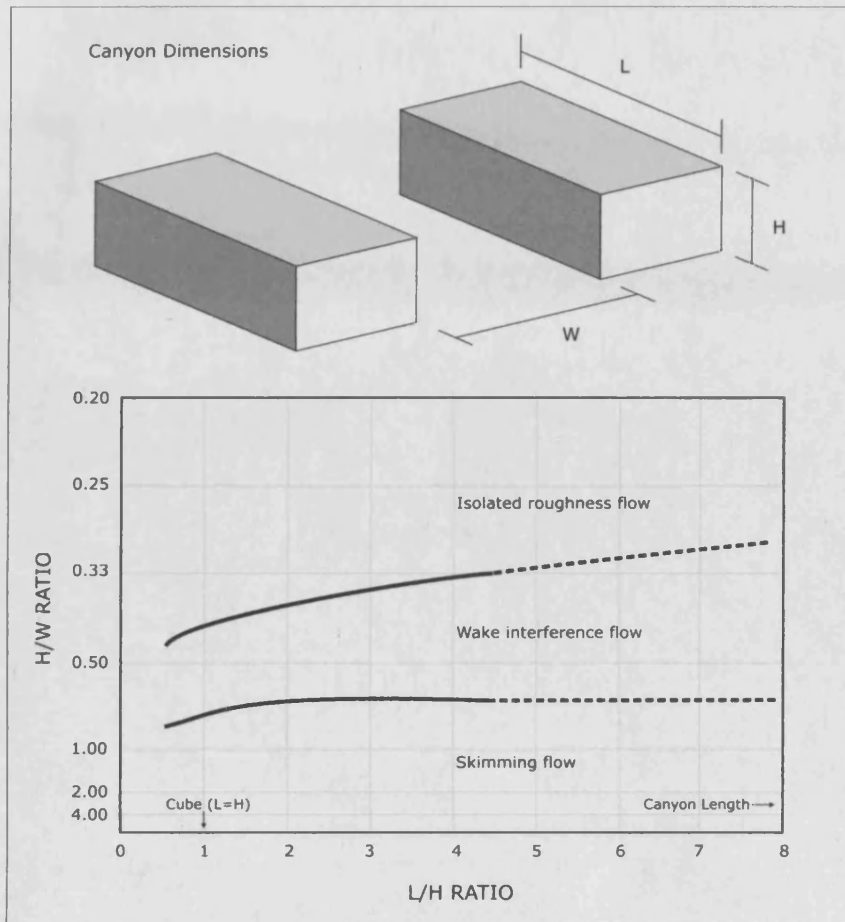

Figure 30: Characteristics of Urban Canyon Effect (adapted from Oke)¹²²

The flow regimes associated with urban canyons (figure 29) are illustrated mathematically in figure 30, which shows the main parameters: H (the mean height of buildings in the canyon), W (the width of the canyon) and L (the length of the canyon). The threshold lines for the 3 no. regimes, proposed by Oke¹²³, divide the flow as functions of L/H (building geometry) and H/W (canyon geometry). Isolated roughness flow typically occurs at ($H/W < 0.4$ at $L/H = 2$), where the geometry of an isolated building dominates. Wake interference flow occurs between ($0.4 < H/W < 0.65$ at $L/H = 2$), where aerodynamic interaction between the buildings occurs. Skimming flow occurs at ($H/W > 0.65$ at $L/H = 2$) where buildings of a similar height are densely distributed. The skimming flow regime has attracted the most attention due to the high H/W ratios of canyons typical in cities¹²⁴.

¹²² Adapted from Oke, T.R., *Street design and urban canopy layer climate*, Energy and Buildings, Volume 11, 1988, pages 103-113

¹²³ Oke, T.R., *Street design and urban canopy layer climate*, Energy and Buildings, Volume 11, 1988, pages 103-113

¹²⁴ Santamouris, M. *Energy & Climate in the Urban Built Environment*, James & James, 2001, p. 77

Urban 'canyons' are thus defined as the street area between opposite building facades within the urban canopy. Santamouris describes this zone as having an "unlimited number of microclimates generated by the various urban configurations"¹²⁵. Canyon studies to date have typically focussed on the energy balance in the canyon (thermal and flow characteristics) mainly to investigate the potential for natural ventilation, pedestrian comfort and pollutant dispersal.

Various studies looking at aspects of the wind regime in urban canyons have been reported, such as Kastner-Klien and Plate¹²⁶, Uehara et al.¹²⁷ and Ricciardelli and Polimeno¹²⁸. These studies have largely focussed on idealised symmetrical canyons where the height of the buildings (H) is equal on both sides of the canyon and the canyon spacing is also equal. While examples of symmetrical canyons can be found in the urban environment, from simple observations the majority of city centres in the UK have grown organically over time leading to greater variation in building heights (new towns such as Milton Keynes are the exceptions to this, having been built according to master plans in the 1960s and 1970s). The case study location (described in Chapter 5) does not represent a symmetrical canyon, as while the width (W) is relatively constant along the length, the height (H) varies considerably.

This study focuses on the potential wind resource in terms of energy output from small turbines and is not so concerned with the minutiae of microclimate factors such as surface albedo and associated temperature effects (e.g. heat island effect)¹²⁹. Nevertheless, urban canyon modelling, particularly that validated by wind tunnel testing and site measurements, presents a suitable methodology, elements of which can be usefully employed in this study. These will now be discussed in further detail.

¹²⁵ Santamouris, M. *Energy & Climate in the Urban Built Environment*, James & James, 2001, p. 69

¹²⁶ Kastner-Klein, P., Plate, E.J., *Wind-tunnel study of concentration fields in street canyons*, Atmospheric Environment, Volume 33, 1999, pages 3973 - 3979

¹²⁷ Uehara et al., *Wind tunnel experiments on how thermal stratification affects flow in and above urban street canyons*, Atmospheric Environment, Volume 34, 2000, pages 1553 - 1562

¹²⁸ Ricciardelli, F., Polimeno, S., *Some characteristics of the wind flow in the lower Urban Boundary Layer*, Journal of Wind Engineering and Industrial Aerodynamics, Vol. 94, 2006, pages 815 - 832

¹²⁹ Oke, T.R., *The distance between canopy and boundary layer urban heat island*, Atmosphere, Volume 14, No. 4, pages 268-277, 1976

3.2 Existing Modelling Methods

The urban wind regime has been studied for a variety of reasons. Past research topics have typically focussed on:

- The effect of wind loading and wind shear on tall structures
- The effect of urban wind flows on pedestrian comfort
- The design and assessment of natural ventilation strategies in buildings
- The dispersal of air-borne pollutants in the urban environment

Currently available modelling techniques include analytical methods, wind tunnel simulations and computational wind engineering (CWE). The data from these studies has resulted in a better understanding of certain wind effects in specific urban situations (such as those discussed in section 3.1.3). Known effects and implications of the urban wind regime are described by Grosso, thus:

"High wind speed can generate outdoor discomfort; wind velocity and direction affect outdoor and indoor natural ventilation cooling; cold wind protection in winter reduces energy consumption; urban wind characteristics influence the spread of air pollution from traffic, industrial, and heating systems sources as well as the exposure to noise-pollution"¹³⁰.

However, in terms of assessing the urban wind regime as a potential resource for small wind turbines, there is currently very little published material. Steemers et al, in the 'Assessing the Potential for Renewable Energy in Cities' (PRECis) project, found that *"available research in the field has mostly focussed either at immediate building scale or at the large atmospheric scale, leaving the immediate neighbourhood scale of a group of buildings relatively poorly explored"¹³¹*. Furthermore, Syngellakis and Traylor reported in 2007 that, *"models and methodologies for [the] assessment of wind speed and direction in urban environments are still in the early stages of development in research institutes and universities"¹³²*. Various methods of modelling the urban wind regime are now discussed.

¹³⁰ Grosso, M., *Urban Form And Renewable Energy Potential, Renewable Energy*, Vol. 15, 1998, p. 333

¹³¹ Steemers, K., *Assessing the Potential for Renewable Energy in Cities*, European Commission, July 2000, page 5

¹³² Syngellakis K., Traylor, H., *Urban Wind Resource Assessment in the UK*, European Commission, February 2007, page 9

3.2.1 Analytical Methods Project (ICP)

Analytical (or numerical) methods have been developed to estimate the wind resource at a site based on general area data, when no specific site data are available. In some cases, notably the Wind Atlas Model, the effect of obstructions on wind flow may be approximated via analytical methods (figure 31)¹³³. However, these usually take the obstruction in isolation and often assume that the approaching wind flow is itself laminar, in order to reduce uncertainty in the calculations. As is demonstrated by field measurements this is rarely (if ever) the case in urban areas, leading Ferziger to suggest that a discrepancy of $\geq 25\%$ between numerical simulations and wind tunnel experiments is acceptable, "since there are more uncertainties involved in the mathematical modelling of the turbulent winds"¹³⁴.

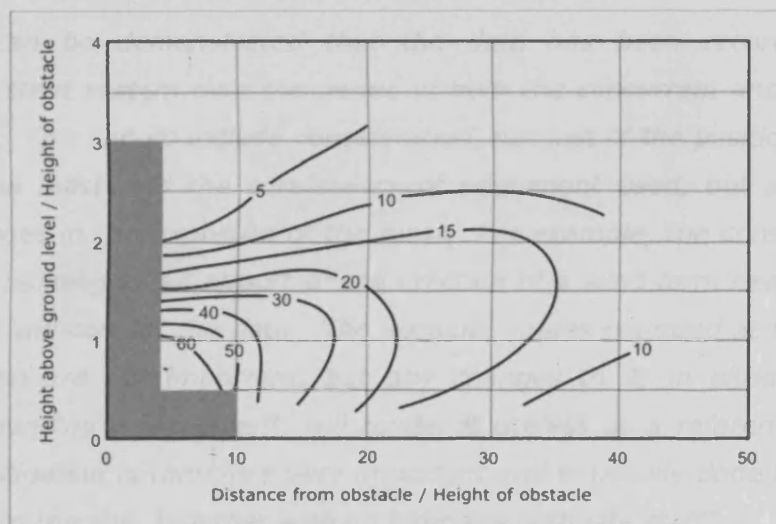

Figure 31: Reduction in wind speed (%) after shelter by a 2 dimensional obstacle

The shading effect of obstacles, as modelled in the Wind Atlas Model, is largely based on mathematical expressions developed by Perera¹³⁵. While the Wind Atlas data has been used in this chapter to provide an overview of the UK wind regime and as a comparison with other data sources, the Wind Atlas Model has not been applied in this work because more suitable sources of data and modelling techniques have been identified.

¹³³ Troen, I., Petersen, E.L., *European Wind Atlas*, Riso Laboratory, 2000, page 59

¹³⁴ Ferziger J.H., Approaches to turbulent flow computation: applications to flow over obstacles *Journal of Wind Engineering and Industrial Aerodynamics*, Volume 35, 1990 pages 1 - 19

¹³⁵ Perera, M.D., *Shelter behind two- dimensional solid and porous fences*, *Journal of Wind Engineering and Industrial Aerodynamics*, Volume 8, 1981, pages 93 - 104

3.2.2 Measure-Correlate-Predict (MCP)

The 'measure-correlate-predict' (MCP) method involves comparing the wind speeds on a site with wind speeds at a nearby reference station (i.e. the nearest Met Office weather station) and using the statistical relationship between concurrent observations to estimate the long-term wind speed on the site¹³⁶. Both wind speed and wind direction data are required for the analysis. This method has the advantage that site data only need be collected for a short period of time. The European Wind Energy Association (EWEA) suggests that the following conditions are necessary for the MCP to be considered valid¹³⁷:

- *"The reference data set includes data which overlaps with the data recorded on site".*
- *"It can be demonstrated that the data has been recorded using a consistent system over the period of both the concurrent and longer-term data. This should include consideration, not just of the position and height of the mast and the consistency of equipment used, but also potential changes in the exposure of the mast. For example, the construction of a new building at an airport or the erection of a wind farm near an existing mast will corrupt the data. The absolute values recorded at the reference station are not important, but any changes to it, in either process or surrounding environment, will render it useless as a reference site. This investigation is therefore very important and is usually done by a physical visit to the site, together with an interview with site staff".*
- *"The exposure of the reference station should be good. It is rare that data recorded by systems in town centres, or where the mean wind speed at the reference station is less than half that of the site, prove to be reliable long-term reference data sets".*
- *"The data is well correlated with that recorded at the site".*

However, the EWEA also state that, *"it is difficult to provide definitive guidance on how poor the quality of a correlation can be before the reference station may no longer be reliably used within an analysis"*¹³⁸.

¹³⁶ Best, M. et al, *Small-scale wind energy Technical Report*, Met Office, July 2008, page 110

¹³⁷ <http://www.wind-energy-the-facts.org> – last accessed August 2009

¹³⁸ <http://www.wind-energy-the-facts.org> – last accessed August 2009

This method is sometimes used by commercial wind farm developers¹³⁹ and is also an element of the WAsP tool (discussed in the next section)¹⁴⁰. However, while Best et al suggest that theoretically there is no reason why the MCP method can not be used for urban areas, there is currently very little published evidence to show that this method has been successfully employed at near ground level for a dense urban site¹⁴¹. For further guidance on the MCP method, the reader is referred to Appendix D of the EWEA publication 'Wind Facts'¹⁴² and to the comparison of different MCP methods reported by Best et al¹⁴³.

¹³⁹ For example, Garrad Hassan (<http://www.garradhassan.com> - last accessed July 2009)

¹⁴⁰ WAsP website: <http://www.wasp.dk/index.htm> - last accessed July 2009

¹⁴¹ Best, M. et al, *Small-scale wind energy Technical Report*, Met Office, July 2008, page 110

¹⁴² <http://www.wind-energy-the-facts.org/en/appendix/appendix-d.html> - last accessed August 2009

¹⁴³ WAsP website: <http://www.wasp.dk/index.htm> - last accessed July 2009

¹⁴³ Best, M. et al, *Small-scale wind energy Technical Report*, Met Office, July 2008, pages 81 - 83

3.2.3 Linear Flow Models

Large scale wind generation is now a major global industry and recent research has focussed on meso-γ scale wind effects such as turbulent flows over terrain. The main aim of turbine manufacturers has been to maximise the effectiveness (and financial return) of commercial wind farms. Risø DTU in Denmark (publishers of the European Wind Atlas) developed a computer model, Wind Atlas Analysis and Application Program (WASP)¹⁴⁴, to predict the wind resource available to wind farms. This is now an industry standard tool with 2600 users in over 100 countries¹⁴⁵. The fundamentals of this model are described in detail by Best et al, together with a review of published literature¹⁴⁶. However, this model is not designed for locating small wind turbines in urban environments as it does not allow for consideration of complex obstructions.

WASP, was identified as a potential modelling method early in the project and a brief review is included in Appendix C. The WASP model, designed for assessing open sites for commercial wind farms can consider complex terrain in some detail, however, the model for shading obstructions, such as buildings, is relatively simple and would not easily allow a complex urban site to be modelled. This is because the effects of urban areas on wind regime can only be modelled as regions of homogeneous surface roughness and obstructions can only be simply defined, with their effects only apparent at distances of at least five times the obstacle height¹⁴⁷. Therefore, the WASP tool is unable to model the details of the wind flow close to buildings and other obstacles as would be necessary for an urban location.

Strataridakis et al compared turbulence and velocity measurements from BLWT data and field data with a terrain model in WASP and found complimentary results, albeit with slight variations¹⁴⁸. However, the measurement height in this instance was 40m over clear terrain (i.e. potential hub height for a large scale turbine). Other similar models that have been developed for commercial wind farms include WindFarmer and Wind Pro.

¹⁴⁴ For further details see review in Appendix D

¹⁴⁵ Figures from WASP website: <http://www.wasp.dk/index.htm> - last accessed July 2009

¹⁴⁶ Best, M. et al, *Small-scale wind energy Technical Report*, Met Office, July 2008, page 89

¹⁴⁷ Best, M. et al, *Small-scale wind energy Technical Report*, Met Office, July 2008, page 110

¹⁴⁸ Strataridakis et al., *Cross-Correlation of Velocity Measurements for Wind Resource Assessment Over a Large Complex Terrain*. Proceedings of AIAA/ASME Wind Energy Symposium, NV, USA, 2000

3.2.4 Computational Wind Engineering (CWE)

Computational Wind Engineering (CWE) uses Computational Fluid Dynamics (CFD) as a tool to model the urban wind regime and has been used to model air movement in and around buildings for several years. Hu Hu and Wang suggest that, used in this way, CFD may have *"the potential to be an alternative that is less time-consuming and more cost-effective compared with traditional wind tunnel testing"*¹⁴⁹.

At a basic level CFD software works by dividing the geometric structure of a defined 3 dimensional model (for example an urban environment) into a series of cells. The wind flow volume is also described in terms of a series of cells. The higher the number of cells, the greater the potential accuracy of the model and the greater the computational power required. The interactions between the flow cells and the model cells are calculated, together with the influence of each individual cell on its neighbouring cells. Results can either be presented numerically, or as a plot of wind vectors, or as shaded contours.

Early comparisons with wind tunnel results, by Johnson and Hunter, examined dispersion effects in street canyons and found a *"reasonable agreement"* overall, but with some *"significant discrepancies"*¹⁵⁰. Stathopoulos and Baskaran suggested that a 30% discrepancy was typical in a CFD simulation of the wind environment around buildings compared with measured data¹⁵¹. Furthermore, for more complicated simulations such as atmospheric dispersion and diffusion effects (highly dependant on boundary layer flow conditions), Cowan et al. considered that a 50% discrepancy was acceptable¹⁵².

Meroney et al compared the results of 4 no. wind tunnel studies, using geometrically simple blocks or prisms arranged either in a canyon configuration or as isolated elements, with CFD modelling, using the commercially available CFD package FLUENT (version 4.4.8). The main

¹⁴⁹ Hu Hu, C., Wang, F., *Using a CFD approach for the study of street-level winds in a built-up area*, Building and Environment, Volume 40, 2005, pages 617 – 631

¹⁵⁰ Johnson, G.T., Hunter, L.J., *Urban wind flows: wind tunnel and numerical simulations - a preliminary comparison*, Environmental Modelling & Software, Volume 13, 1998, pages 279 – 286

¹⁵¹ Stathopoulos T., Baskaran, B.A., *Computer simulation of wind environmental conditions around Buildings*, Engineering Structures, Volume 18, Issue 11, 1996, pages 876 – 885

¹⁵² Cowan et al., *Numerical considerations for simulations of flow and dispersion around buildings*, Journal of Wind Engineering and Industrial Aerodynamics, Volume 67, 1997, pages 535–545

findings were that the velocity and turbulence fields produced by the CFD model were *"more convective and less diffusive than the wind-tunnel"*¹⁵³, while other inconsistencies included differences in wake and magnitude.

In wind tunnel studies, Kastner-Klein and Plate found that *"vortex dynamics are strongly dependent on the roof shape configuration"* and that *"small-scale features of building design and composition were found to be important factors"*¹⁵⁴. These factors are also important to achieve accuracy in CFD models, as Hu Hu and Wang concluded:

*"Using the simple CFD approach for the study of street level winds is adequate when the arrangement of buildings is simple and when there is no significant height difference between the buildings. However, it may be difficult to resolve the flow field adequately around buildings if there is a considerable height difference between them"*¹⁵⁵.

Heath et al modelled wind flow over pitched roof buildings, representative of a sub-urban area in the UK, using CFD techniques, to try to identify the potential for small wind turbines mounted on the building roofs¹⁵⁶. The model indicated that the flow regime over the roof of a pitched roof building in an isolated location (i.e. a single building) was significantly different from that over buildings arranged in an idealised array, where the skimming flow regime found to be present led to much less acceleration of flow over the ridge compared with the isolated case. This was considered to be primarily because the wind below the roof height was already slowed down by the upwind buildings. While this study produced some interesting results, Heath et al concluded that *"wind flow within the urban environment is far from fully understood"* and that the results should be *"considered as very approximate"* and *"only applicable to building arrangements similar to that modelled"*¹⁵⁷.

¹⁵³ Meroney et al, *Wind-tunnel and numerical modelling of flow and dispersion about several building shapes*, Journal of Wind Engineering and Industrial Aerodynamics, Vol. 81, 1999, pages 333 - 345

¹⁵⁴ Kastner-Klein, P., Plate, E.J., *Wind-tunnel study of concentration fields in street canyons*, Atmospheric Environment, Volume 33, 1999, pages 3973 - 3979

¹⁵⁵ Hu Hu, C., Wang, F., *Using a CFD approach for the study of street-level winds in a built-up area*, Building and Environment, Volume 40, 2005, pages 617 - 631

¹⁵⁶ Heath et al., *Estimating the Potential Yield of Small Building-mounted Wind Turbines*, Wind Energy, Volume 10, 2007, pages 271 - 287

¹⁵⁷ Heath et al., *Estimating the Potential Yield of Small Building-mounted Wind Turbines*, Wind Energy, Volume 10, 2007, page 285

A 'simple' or 'idealised' urban form model typically refers to an array of equally spaced, equally dimensioned blocks, which is not truly representative of a real urban environment (where building geometry and spacing are usually far more complex). An accurate model of the case study location for this study (Chapter 5) would therefore be considered a 'complex' urban form.

Mochida and Lun modelled an actual complex urban form (part of Niigata City, Japan) that included a range of building heights, albeit in geometrically simple block form. A comparison of 3 no. CFD models, one academic and two unidentified commercial models, was made with a wind tunnel model of the same location. Discrepancies apparent in the findings included that *"the scalar velocity predicted by all CFD codes was smaller in the wake region compared to the experimental value"*¹⁵⁸, thought to be because the CFD models could not accurately reproduce the vortex shedding from tall buildings. Mochida and Lun concluded that *"a lot of improvements and revisions are still required [to the CFD models] before the turbulent flow phenomena in urban areas can be accurately reproduced"*¹⁵⁹.

¹⁵⁸ Mochida, A., Lun, I.Y.F., *Prediction of wind environment and thermal comfort at pedestrian level in urban area*, Journal of Wind Engineering & Industrial Aerodynamics, Vol. 96, 2008, page 1510

¹⁵⁹ Mochida, A., Lun, I.Y.F., *Prediction of wind environment and thermal comfort at pedestrian level in urban area*, Journal of Wind Engineering & Industrial Aerodynamics, Vol. 96, 2008, page 1522

3.2.5 Boundary Layer Wind Tunnel (BLWT) Modelling

The development of BLWTs to model the effects of wind loading on buildings was originally carried out in the late 1950s and early 1960s. Prior to this, laminar flow tunnels had been used for this purpose. In pioneering work, Jenson and Franck found that by comparing the results from laminar WTs with measurements recorded in an urban environment, "*measurements on full-scale buildings in natural wind differed from smooth-flow wind tunnel results by up to 50%*"¹⁶⁰. Field measurements of the urban boundary layer were made in the 1960s, for example by Jones et al, who used instruments mounted below a captive balloon to measure wind velocity profiles up to 1000ft (304m) over Liverpool¹⁶¹. However, more recently Roth conducted a critical review of over fifty experiments observing turbulent wind effects over cities and concluded that, "*very few urban-turbulence studies are sufficiently documented and reliable to warrant further analysis*".¹⁶²

BLWTs are regarded by some researchers as the "*most well-established way to simulate the natural wind*"¹⁶³. They are commonly used to model the effects of wind loading on structures, natural ventilation strategies, wind effects at street level (pedestrian comfort) and particle dispersal in urban environments. However, much of the past research in these areas has focussed on idealised urban environments, where building geometry and urban forms are represented by simple rectangular shapes¹⁶⁴.

Modelling the wind loading on structures and modelling natural ventilation strategies for buildings typically involve measuring the surface pressure at points on a model building façade, often using an array of pitot tubes. Pressure coefficients can be calculated to identify areas of relative high pressure and areas of relative low pressure, important for both structural understanding and for the likely movement of air in a ventilation strategy.

¹⁶⁰ Jensen, M., Franck, N., *Model-scale tests in turbulent wind Part II—Wind loads on buildings*, The Danish Technical Press, Copenhagen, 1965, page 169

¹⁶¹ Jones, P.M., *The Urban Wind Velocity Profile*, Atmospheric Environment, Vol. 5, 1971, pp. 89-102

¹⁶² Roth, M., *Review of atmospheric turbulence over cities*, Quarterly Journal of the Royal Meteorological Society, Volume 126, 2000, pages 941– 990

¹⁶³ Hu Hu, C., Wang, F., *Using a CFD approach for the study of street-level winds in a built-up area*, Building and Environment, Volume 40, 2005, pages 617–631

¹⁶⁴ Plate, E.J., Kiefer, H., *Wind loads in urban areas*, Journal of Wind Engineering and Industrial Aerodynamics, Volume 89, 2001, pages 1233 – 1256

Modelling wind effects at street level is typically achieved through a scouring test, where the model is seeded with a particulate substrate and subjected to progressively higher WT flow speeds. This can identify areas of relative acceleration and areas of relative shelter. Various other aerodynamic effects can be modelled using smoke or bubbles to provide both an instantaneous visual assessment and for laser anemometry.

Work by Davenport in the 1960s and 1970s, comparing BLWT results with field data, established that BLWT models of urban environments could give a very good representation of the urban wind regime, as measured¹⁶⁵. Dalglish and Surry go on to suggest that a difference of 15% between observed measurements and wind tunnel results would be a "*reasonable target*"¹⁶⁶, based on a comparison of 4 studies. While this work is not directly relevant to this study, as the results are mainly concerned with pressure rather than speed and direction, it has established that the BLWT is a valid method of modelling wind flow in an urban environment.

A number of studies have used BLWT simulation to model the dispersal of pollutants in the urban environment. While the focus of these experiments was on pollutant concentrations, nevertheless these studies have yielded useful results for wider application. For example, Pavageau and Schatzmann used a tracer gas mixture of ethane and air, together with a fast flame ionisation detector, to measure pollutant concentration in an idealised urban street canyon. Importantly this work concluded that "*the blockage effect of any obstacle present in the canyon on concentration dispersion should perhaps deserve more attention in modelling*"¹⁶⁷, suggesting that attention should be paid not only to the building geometry but also to other site features. Pearce and Baker used a more realistic urban form, representative of part of a UK city, for a similar experiment using tracer gas and found that generally "*the higher pedestrian level wind speeds occurred at street corners and upstream of buildings with a relatively open approach*"¹⁶⁸.

¹⁶⁵ Davenport, A.G., *Wind loads on structures*, Technical paper no. 88 of the Division of Building Research, NRC 5575, Ottawa, March 1960

¹⁶⁶ Dalglish, W.A., Surry, D., *BLWT, CFD and HAM modelling vs. the real world: Bridging the gaps with full-scale measurements*, *Journal of Wind Engineering and Industrial Aerodynamics* 91, 2003, pages 1651-1669

¹⁶⁷ Pavageau, M., Schatzmann, M., *Wind tunnel measurements of concentration fluctuations in an urban street canyon*, *Atmospheric Environment*, Vol. 33, 1999, pages 3961 - 3971

¹⁶⁸ Pearce, Baker, *Wind tunnel tests on the dispersion of vehicular pollutants in an urban area*, *Journal of Wind Engineering and Industrial Aerodynamics*, Volume 80, 1999, pages 327 - 349

The characteristics of wind flow close to tall buildings have been widely explored through BLWT simulation. Particularly relevant are studies on pedestrian comfort, such as Melbourne and Joubert¹⁶⁹, or those concerning wind loading on buildings, such as Plate and Kiefer¹⁷⁰.

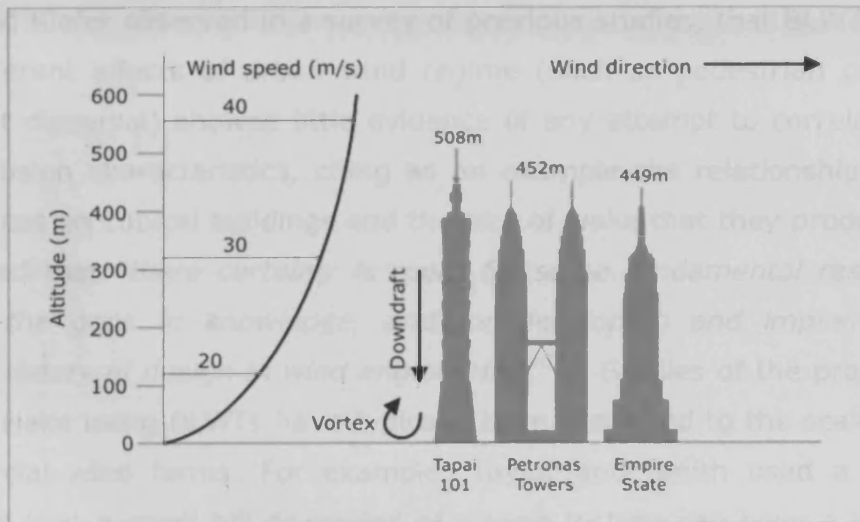

Figure 32: Schematic showing downdraft and vortex effects experienced near tall buildings

With reference to figure 32, Pearce and Baker, succinctly explain the main features of these phenomena in their work on pollutant dispersal:

*"The vertical velocity gradient of the approach flow induces a downward pressure gradient on the windward face of the building. The resultant down-flow beneath the front stagnation point rolls up to form a standing vortex system near the ground with associated high winds. The strength of the vortex system may be augmented depending on the size and location of smaller upstream buildings. In addition, the region of relatively high positive pressure at the base of [the] windward side of a building is adjacent to regions of relatively low pressure near separation points (such as corners) and in the lee of the building. These differences in pressure can also produce relatively high speed flows between different regions"*¹⁷¹.

¹⁶⁹ Melbourne, W.H., Joubert, P.N., *Problems of wind flow at the base of tall buildings, Proceedings of the 3rd International Conference on Wind Effects on Buildings and Structures, Tokyo, 6th - 9th September 1971, pages 105 - 113*

¹⁷⁰ Plate, E.J., Kiefer, H., *Wind loads in urban areas, Journal of Wind Engineering and Industrial Aerodynamics, Volume 89, 2001, pages 1233 - 1256*

¹⁷¹ Pearce, Baker, *Wind tunnel tests on the dispersion of vehicular pollutants in an urban area, Journal of Wind Engineering and Industrial Aerodynamics, Volume 80, 1999, page 333*

Energy output from wind turbines is greatly dependant on wind speed (Chapter 4). Therefore, this effect is highly significant for this study, as it may signify that tall buildings (relative to their surroundings) can be used as a potential indicator for good wind resource at 'near ground level' ($\leq 10\text{m}$).

Plate and Kiefer observed in a survey of previous studies, that BLWT research into different effects of urban wind regime (such as pedestrian comfort or pollutant dispersal) showed little evidence of any attempt to correlate forces and diffusion characteristics, citing as an example the relationship between drag forces on cubical buildings and the size of wake that they produce. They concluded that *"there certainly is room for some fundamental research for closing the gaps in knowledge, and for developing and implementing a general theory of design in wind engineering"*¹⁷². Studies of the properties of turbine wake using BLWTs have typically been restricted to the scale of large commercial wind farms. For example, Taylor and Smith used a BLWT to establish that a small hill downwind of a wind turbine can have a significant effect on the wake produced¹⁷³.

There appear to be few BLWT studies regarding locating small wind turbines. However, Blackmore recently reported such a study that aimed to identify the optimum mounting position for a small turbine above a domestic scale pitched roof. A range of scenerios were modelled in a BLWT, from an isolated house (country terrain) to a series of houses arranged in an idealised array (town terrain), as well as for a variety of roof pitches. Blackmore concluded that *"turbines should be mounted as high above the roof as practical"*¹⁷⁴.

The boundary layer wind tunnel (BLWT) has been used for many years to model the urban boundary layer for applications such as those discussed above. More recently, with advances in processing power, software-based computational wind engineering (CWE) has become more viable as an alternative. However, Dalgliesh and Surry state that, *"benchmarking with BLWT data is indispensable for CFD applications in wind engineering, and where available, full-scale experiments play a useful role too"*¹⁷⁵.

¹⁷² Plate, E.J., Kiefer, H., *Wind loads in urban areas*, Journal of Wind Engineering and Industrial Aerodynamics, Volume 89, 2001, pages 1233 – 1256

¹⁷³ Taylor, G. J., Smith, D. *Wake Measurements Over Complex Terrain*, Proceedings of the 13th BWEA Conference: Wind Energy Conversion 1991, Swansea, UK, April 10th – 12th, 1991

¹⁷⁴ Blackmore, P., *Micro-wind turbines on house roofs*, IP 4-08, BRE, May 2008, page

¹⁷⁵ Dalgliesh, W.A., Surry, D., *BLWT, CFD and HAM modelling vs. the real world: Bridging the gaps with full-scale measurements*, Journal of Wind Engineering and Industrial Aerodynamics 91, 2003, pages 1651–1669

3.2.6 Other Models

The Met Office Numerical Atmospheric-dispersion Modelling Environment (NAME) model is primarily used for pollution forecasts (air quality prediction) in cities. A new version, NAME III, is currently in development and the Met Office claims that this will provide *"improved modelling of short-range dispersion such as buildings effects"*¹⁷⁶. NAME is an in-house tool of the Met Office and is not available for wider use.

Steemers et al proposed a software based approach for the PRECis project, using a Digital Elevation Model (DEM), a 3 dimensional CAD model of an urban location, to enable both dispersal effects and natural ventilation to be considered. Cross-sectional models of case study urban environments were expressed as a 'variance plot' based on the average height variance across cross-sections of the DEM at a range of orientations. The variance plot resembles a wind rose that shows how directionality varies with orientation. The purpose of the plot was to highlight *"effects of street interconnectivity that might not be directly discernable on the DEM"*¹⁷⁷. The proposed model could be considered to be a hybrid numerical and CFD model as it used a numerical approach similar to the Wind Atlas model but could also produce output files for CFD analysis.

¹⁷⁶ http://www.metoffice.gov.uk/environment/name_iii.html - last accessed July 2009

¹⁷⁷ Steemers, K., *Assessing the Potential for Renewable Energy in Cities*, European Commission, July 2000, page 18

3.2.7 Summary of Modelling Methods

It has been established that none of the modelling methods discussed, when taken in isolation, is ideal for predicting the urban wind resource to the degree necessary to confidently estimate the energy output from a small wind turbine. Indeed, Peacock states from a review of available methods that "*no robust method exists for estimating urban wind speeds*"¹⁷⁸. However, BLWT modelling has been shown to be effective in modelling micro-scale wind effects and was therefore selected as the research method for this study. Furthermore, a suitable BLWT was available for use.

While some commercial CFD software was identified (notably FLUENT¹⁷⁹ and STREAM¹⁸⁰), this was not available to the project at the time. Furthermore, the reported discrepancies with wind tunnel results, while not considered to be of vital importance in understanding the general effects of wind flow over an urban environment, would be of concern when these were to be applied in the calculation of the energy output of wind turbines. In particular Dalglish and Surry suggest of CFD that, "*the most difficult regions for agreement with experimental results tend to be the extent of the recirculation zone behind the building, and the shear layers separating from sharp edges*"¹⁸¹, both of which are highly relevant to a wind turbine mounted at near ground level.

While a BLWT simulation is "*inherently of high resolution*"¹⁸² because the atmosphere is modelled using air and turbulent effects are physically produced, it may be difficult to approach this resolution using the discrete grid of cells that CFD requires. However, in the light of recent advances in CWE / CFD software and with the increased processing power now available, future work could involve modelling the case study location (Chapter 5) using CWE and comparing the results with the field data and BLWT results. Lubnitz suggests that it is probable that the combined use of both methods may "*yield additional insights in resource assessment*"¹⁸³.

¹⁷⁸ Peacock, A.D. et al, *Micro wind turbines in the UK domestic sector*, Energy and Buildings, Volume 40, 2008, pages 1324 – 1333

¹⁷⁹ <http://www.fluent.com> – last accessed June 2009 (FLUENT was acquired by ANSYS in 2006)

¹⁸⁰ <http://www.cradle-cfd.com/product/stream.html> – last accessed June 2009

¹⁸¹ Dalglish, W.A., Surry, D., *BLWT, CFD and HAM modelling vs. the real world: Bridging the gaps with full-scale measurements*, Journal of Wind Engineering and Industrial Aerodynamics 91, 2003, pages 1651–1669

¹⁸² Lubitz, W. D., White, B. R. *Atmospheric Boundary Layer Wind Tunnel Applications in Wind Turbine Siting*. Proceedings of World Wind Energy Conference, Beijing, China, Oct. 31 - Nov. 4, 2004.

¹⁸³ Lubitz, W. D., White, B. R. *Atmospheric Boundary Layer Wind Tunnel Applications in Wind Turbine Siting*. Proceedings of World Wind Energy Conference, Beijing, China, Oct. 31 - Nov. 4, 2004.

3.3 Sources of Wind Data

Wind data can also be described in terms of the scales (or resolutions) described in this chapter. Macro-scale and meso-scale data sets are readily available in the UK. Syngellakis and Traylor state that, while generalised sources of wind data are available in the UK, specific high resolution wind speed data for urban areas are "relatively rare"¹⁸⁴. This lack of micro-scale data influenced the selection of the case study location for this study (Chapter 5) as the location was selected partly because a reliable source of high resolution data was available close to the site. The following data sources have been identified that include mean wind speeds based on at least 10 year averages. The limitations of these sources are discussed below.

3.3.1 The British Meteorological Office

The British Meteorological Office, established in 1854¹⁸⁵, can provide standardised historical records of surface wind speed data going back many decades. Available data sets are presented in Appendix C. The Met Office publishes mean wind speed averages that are available free of charge, while complete datasets from specific weather stations are available at a cost. Typically wind data are collected from a 10m mast located in flat, open terrain, as per World Meteorological Organisation (WHO) best practice guidance¹⁸⁶. The Met Office has 16 city centre anemometer stations, including one in Cardiff, however the data available from this station (hourly values of mean speed, mean wind direction and maximum gust speed) were not considered to be of high enough resolution for this study (see section 5.4.1).

The Met Office National Climate Information Centre (NCIC) has a database of UK wind speed data. The NCIC dataset is based on 30 year averages, between 1971 and 2000 and collected from approximately 180 stations¹⁸⁷. The data are based on a resolution of 1km² and do not take into account local variations in roughness and ground features. Figures 21 and 22 are derived from this dataset, however, the source data is only available under commercial licence (not available to this study).

¹⁸⁴ Syngellakis K., Traylor, H., *Urban Wind Resource Assessment in the UK*, European Commission, February 2007, page 7

¹⁸⁵ <http://www.metoffice.gov.uk/corporate/history> - last accessed June 2009

¹⁸⁶ Best, M. et al, *Small Scale Wind Technical Report*, Met Office, 2008, page 7

¹⁸⁷ Best, M. et al, *Small Scale Wind Technical Report*, Met Office, 2008, page 6

3.3.2 The European Wind Atlas

The European Wind Atlas includes average mean wind speed data from actual measurements and derived data from roughness calculations. For a limited number of locations wind roses (direction and frequency) are presented, along with graphs of annual mean wind speed. The publishers describe the data tables in the atlas as, "high quality data sets from good measurements made at airports, synoptic and climatological stations and lightships all over Europe"¹⁸⁸. Stations are identified by grid reference and details such as the station altitude (m) and the measurement period (years) are provided. The atlas lists 22 no. meteorological stations in the UK of which 2 no. are in Wales. These stations are Bala (52°54'N, 03°35'W - approximately 170km north of the case study location) and Valley (53°15'N, 04°32'W - approximately 210km north of the case study location). Neither of these stations was considered to be close enough to the case study location for wind speed comparison, however, the wind roses for these locations (particularly the Bala station) showed a strong prevailing SW wind direction and a pronounced secondary NE wind direction (figure 33), as expected for Wales and similar to the case study location (Chapter 5). Also evident in the data from these stations is that mean wind speeds in winter are generally higher than those in summer, confirming the trend shown in the Met Office data (figure 22).

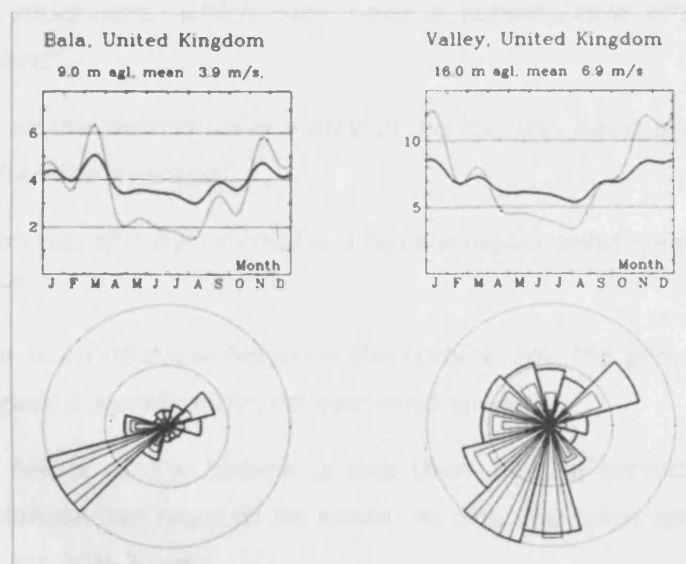

Figure 33: Wind roses for Bala (left) and Valley (right)

¹⁸⁸ Troen, I., Petersen, E.L., *European Wind Atlas*, Riso Laboratory, 2000, pages 526 and 530

3.3.3 The NOABL Database

The UK Government Department of Business Enterprise & Regulatory Reform (BERR) publishes the NOABL database, administered by the British Wind Energy Association (BWEA). NOABL is a mass-consistent model where the wind field is *"assumed to be in steady-state and the only other physical basis is the constraint of producing a non-divergent (in 3D) wind-field with zero flow through material surfaces (i.e. the ground, in practice) as well as an upper surface (usually taken to be the boundary layer depth)"*¹⁸⁹. Hence, the conservation of mass is guaranteed. In order to determine the wind flow, data from observations for the period 1975-1984 from 56 stations, are used. In its own description of the database, the BWEA states that, *"it is very unlikely to give an accurate idea of wind speed at a proposed site for a small wind system, particularly in urban or built up areas"*¹⁹⁰. The following statements made by the BWEA regarding NOABL are also highly relevant¹⁹¹:

- *"The data is more accurate for flat, open countryside, and less so for complicated, rough terrain".*
- *"NOABL makes no allowance for the effect of local thermally driven winds such as sea breezes or mountain/valley breezes, which can increase coastal sites by up to 0.5-1.0 m/s".*
- *"NOABL takes no account of topography on a small scale or local surface roughness, which may have a considerable effect on the wind speed".*
- *"A site at the bottom of a valley or hollow will have a lower wind speed than the average".*
- *"A site on top of a hill or knoll will have a higher wind speed than the average".*
- *"If there is an obstacle between the turbine and the prevailing wind then expect a significantly reduced wind-speed".*
- *"If the height of the turbine is less than 10m, a correction to the 10m estimate will need to be made. At 5m, the wind speed will be roughly 10-20% lower".*

¹⁸⁹ Best, M. et al, *Small Scale Wind Technical Report*, Met Office, 2008, page 49

¹⁹⁰ <http://www.bwea.com/noabl> - last accessed July 2009

¹⁹¹ <http://www.bwea.com/pdf/briefings/smallsystems.pdf> - last accessed July 2009

The NOABL database has been superseded to a certain extent by the Met Office NCIC database (described in section 3.3.1). Both datasets are accessed by entering an OS grid reference or postcode and are based on a resolution of 1km². However, manufacturers and installers of small wind turbines in the UK generally still use the NOABL database to predict the performance of turbines in specific locations, possibly because these data are available free of charge. However, a criticism of both databases is that they "*take no account of local surface obstructions such as buildings and woodland, or local topographical features such as ridges and valleys*"¹⁹². Indeed, recent studies have shown that using data from the NOABL database, the energy output from small turbines is over-estimated at many sites¹⁹³. Given the above statements and the BWEA's own disclaimer, the reliability of either database for estimating wind speeds in urban environments is highly uncertain, particularly in the absence of more evidence of statistical comparison with actual measured data at near ground level ($\leq 10\text{m}$).

¹⁹² Syngellakis K., Traylor, H., *Urban Wind Resource Assessment in the UK*, European Commission, February 2007, page 7

¹⁹³ Energy Savings Trust, *Location, Location, Location - Domestic small-scale wind field trial report*, EST, July 2009, page 10

3.3.4 Other Sources

In addition to the sources already described, there are now several sources of wind data available free on the internet. One of the more comprehensive sites is Windfinder.com, which includes historical monthly wind statistics for many locations, including Cardiff¹⁹⁴. The problem with many of these websites is that they do not provide details of exactly where or at what height their source data is collected. However, Windfinder does reference its sources and collects data from weather stations that are registered with the World Meteorological Organisation (WMO), allowing station information to be checked by reference number. Data for Cardiff is collected from the Cardiff Airport weather station (approximately 15km west of the Cardiff city centre). The station elevation here is 67m with data collected at a standard mast height of 10m¹⁹⁵. Historical data are averaged since the Windfinder website was launched in September 2000. However, using the Wind Atlas classification (Chapter 3, figure 19) Cardiff Airport would be in roughness class 1, landscape class 2, which are very different characteristics to those of Cardiff city centre (section 3.1.2), so these data can only be used to provide an overview of local conditions (Chapter 5).

3.3.5 Summary of Data Sources

Taken in isolation, it is unlikely that any of the above data sources would be adequate for predicting the energy output of small wind turbines in an urban environment. However, they may provide an indicator of local wind conditions sufficient to identify sites with a relatively good or a relatively poor resource. A comparison of data available for Cardiff will be discussed further in the case study (Chapter 5).

¹⁹⁴ http://www.windfinder.com/windstats/windstatistic_cardiff.htm - last accessed July 2009

¹⁹⁵ Information from World Meteorological Organisation - www.wmo.int - last accessed May 2009

3.4 Implications of Predicted Changes in Wind Regime due to Climate Change

Although the potential affects of climate change are not taken into account in this study, it is nevertheless important to note that the UK wind regime may change over the next century. The UK Climate Impacts Programme (UKCIP) published the results of simulations showing the potential impact of global climate change on various aspects of climate in the UK. According to the simulations for mean wind speed for the 4 no. emissions scenarios, the mean wind speed in some areas of the UK may increase by between 3% and 5% in winter by 2080, with annual mean wind speed in Wales showing an overall increase of between 0% and 3% (figure 34).

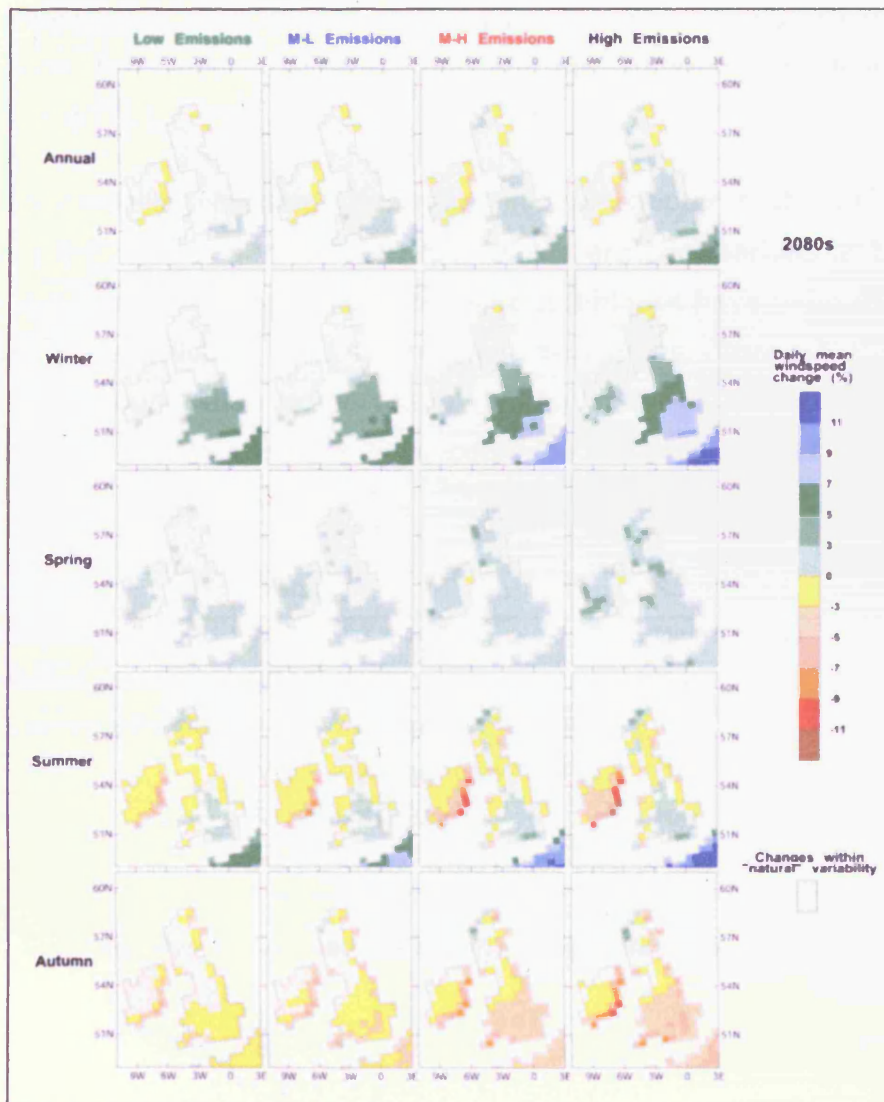

Figure 34: Percentage change in average annual and seasonal wind speed¹⁹⁶

¹⁹⁶ UKCIP02 Climate Change Scenarios, Tyndall & Hadley Centres for UKCIP, 2001

3.5 Summary

In order to establish to what extent the wind component of a hybrid renewable energy street lighting system can be effective in an urban environment, a need for micro-scale (high resolution) data has been identified. Macro-scale data may provide a general indication of local wind conditions although this too should be high quality and based on extensive records¹⁹⁷. While many official weather monitoring stations now exist in the UK, Twiddell and Wier, in their work regarding electricity generation from wind power, conclude that:

*"To predict wind power conditions at a specific site, standard meteorological wind data from the nearest station is only useful to provide first order estimates, but are not sufficient for detailed planning"*¹⁹⁸.

The main modelling methods described in this chapter that can assist in predicting the wind regime at different scales are summarised in table 13. Best et al suggest that, while none of these techniques have been specifically developed for predicting wind regime in urban areas, *"through the use of appropriate input data, combination of techniques, model tuning and calibration, any of these techniques could be used to predict urban wind conditions"*¹⁹⁹.

Type	Example	Scale
Simple analytical models	Wind Atlas Model	Macro, Meso
Mass consistent models	NOABL, NCIC	Macro, Meso
Measure-Correlate-Predict	WASP, WindFarmer, Wind Pro	Meso
Linear flow models	WASP, WindFarmer, Wind Pro	Meso, Micro (limited)
CFD	FLUENT, STREAM	Meso, Micro
BLWT	WSA Environmental Laboratory	Meso, Micro

Table 13: Summary of modelling methods and their applicable scales

¹⁹⁷ Sinden, G., *Characteristics of the UK wind resource: Long-term patterns and relationship to electricity demand*, Energy policy, Volume 35, Number 1, 2007, pages 112 - 127

¹⁹⁸ Twidell, J. A., Wier, A.D., *Renewable Energy Resources (2nd edition)*, Taylor & Francis, 2006, page 290

¹⁹⁹ Best, M. et al, *Small Scale Wind Technical Report*, Met Office, 2008, page 112

Elements of the micro-scale wind regime are now well understood through both site observations and laboratory experiments (whether wind tunnel or CWE), although there is still a certain degree of discrepancy between the various methods. Wind tunnel modelling appears to provide the most effective method of modelling the urban wind regime in terms of agreement with field measurements, although this is at the price of being potentially more time-consuming than CWE methods. Of the areas of research discussed in this chapter, the most applicable to this study are those that examine wind effects (notably wind velocity and turbulence) near to street level. As such, aspects of pedestrian comfort, wind loading and pollutant dispersal research are directly relevant. While it may be true that the UK has a higher potential wind resource than other European countries it does not necessarily follow that this is the case for near street level in urban environments because of the factors discussed. Should potential climate change impacts be realised then potentially more urban areas in the UK may provide a sufficient wind resource for small wind turbines in the future.

***"It is theoretically possible to obtain more than 1000TWh of electricity each year from wind in the UK"*²⁰⁰**

DTI Fact Sheet: The UK Wind Resource, 2001

CHAPTER 4 – CAPTURING THE WIND RESOURCE

4.0 Introduction

This chapter provides an overview of the fundamentals of how the energy output from a wind turbine is related to available wind resource and discusses the relevance of annual wind speed and wind speed distributions for locating small wind turbines. A critical review of existing guidance is presented that identifies the main published sources and discusses the implications of this guidance for siting small turbines in urban environments. Techniques for modelling the output of wind turbines in urban environments are then reviewed.

In a conventional grid connected turbine configuration, where there may be a financial incentive to export as much electricity as possible, identifying the optimal location for the turbine is of paramount importance. However, the hybrid street light is a standalone system and, therefore, only needs to generate sufficient power to charge the battery store. The concept of non-optimal siting has been discussed by Best et al who state that "*where the power requirement is low or where the wind is sufficiently strong, there is more scope for siting the turbine in a position which is non-optimal from a meteorological perspective*"²⁰¹. However, the low wind speeds (<4m/s) expected at near ground level ($\leq 10\text{m}$) in urban areas are likely to mean that it remains important to identify areas of relatively high wind resource, if the turbine is to make a significant contribution to the overall energy balance of the system.

This chapter identifies small wind turbines (micro and mini), considered to be suitable for mounting on a street lighting column and that are available in the UK. Furthermore, the results of recent small wind turbine trials are discussed together with methods to increase the energy output from small turbines.

²⁰⁰ DTI, *Fact Sheet 8: The UK Wind Resource*, 2001, page 1

²⁰¹ Best, M. et al, *Small-scale wind energy Technical Report Part 2*, Met Office, July 2008, page 103

4.1 Wind Resource and Power Generation

The wind power (P) available to a wind turbine is a function of air density (ρ), the area of the wind intercepted (A) and the instantaneous wind velocity (v):

$$P = \frac{1}{2}\rho Av^3$$

Air density (ρ) varies with temperature and elevation. The International Standard Atmosphere (ISA)²⁰² gives a value for (ρ) of 1.225 kg/m³ for a temperature of 15°C at 0m elevation (sea level). Although the energy output of a turbine is affected by changes in air density, by far the most significant factor is the wind velocity (v) as energy output varies with the cube of wind speed. For this reason substituting the above value for (ρ) in the equation gives a good approximation for the power in watts (W) where speed is in metres per second (m/s) and area is in square metres (m²), for low-lying temperate sites. Thus:

$$P = 0.6125 Av^3$$

The European Wind Atlas provides a table of air densities for a range of temperatures and elevations although none of the values give a closer approximation of the Cardiff case study location than the figure above²⁰³.

This cubic relationship is arguably the most important factor in locating wind turbines because a small change in the wind speed significantly changes the power available²⁰⁴. For example, if the wind speed increases by 25% then the power available in the wind increases by almost 100%, or if the wind speed increases by 100% then the power available in the wind increases eight-fold (figure 35).

²⁰² International Standard Atmosphere, ISO 2533:1975

²⁰³ Troen, I., Petersen, E.L., *European Wind Atlas*, Riso Laboratory, 2000, page 637

²⁰⁴ Phillips, R. et al, *Micro-wind turbines in urban environments*, HIS BRE Press, 2007

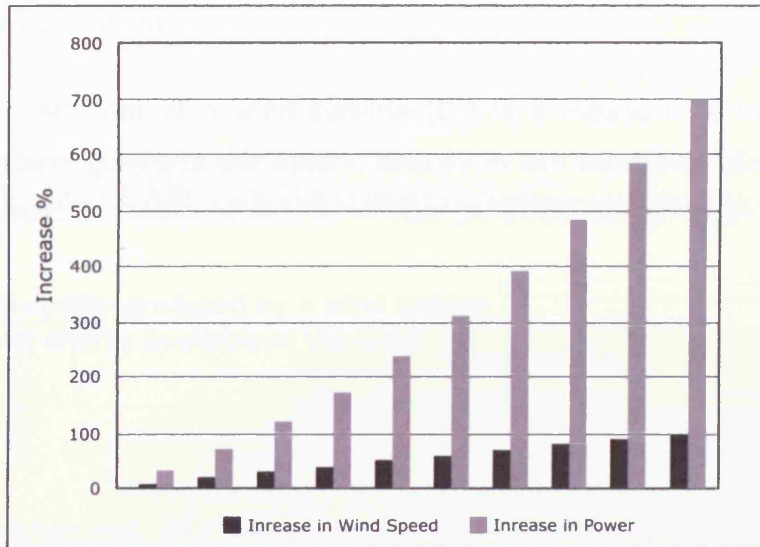

Figure 35: Relationship between wind speed and power available

4.1.1 Swept Area and Energy Output

For wind turbines, the area of wind intercepted (A) is also known as the swept area of the turbine (Chapter 1, figure 5). For typical HAWTs the swept area can be calculated as:

$$A = \pi(r+R)^2 - \pi r^2$$

where (R) is the blade radius (or the length of 1 no. blade) and (r) is the radius of the rotor hub. If the rotor diameter of a turbine is increased by 20%, the swept area is increased by 44%. Therefore, there is a proportional relationship between swept area and the power available. Indeed it has been stated that *"nothing tells you more about a wind turbine's potential than rotor diameter"²⁰⁵.*

Clearly, this relationship has implications in terms of the wind turbines suitable for mounting on street lighting columns that are, by necessity, limited in physical size. For the purposes of this study it has been assumed that a HAWT with a maximum rotor diameter of $\leq 2.1\text{m}^2$ and a VAWT of a maximum rotor height of $\leq 2\text{m}$ would be the largest permissible dimensions (see section 4.4).

²⁰⁵ Gipe, P., *Wind Energy Basics*, Chelsea Green Publishing, 1999, Page 9

4.1.2 Power Coefficient

The power coefficient of a wind turbine (C_p) is a measure of how efficiently the wind turbine converts the kinetic energy in the wind into electricity. C_p is expressed thus:

$$C_p = \frac{\text{Total electricity produced by a wind turbine}}{\text{Total energy available in the wind}}$$

$$C_p = \frac{P_T}{0.5\rho Av^3}$$

This relationship can also be described as of the amount of wind passing through the swept area of the turbine that is intercepted by the turbine. Therefore for a wind turbine to be 100% efficient it would need to intercept 100% of the wind passing through the swept area. Clearly this is impossible, because in order to intercept all of the wind would require a solid rotor (a disc) and this would not be aerodynamically effective. The Betz Limit states that no turbine can convert more than 59.3% of the kinetic energy of the wind into mechanical energy turning a rotor²⁰⁶. Therefore the theoretical maximum C_p of any wind turbine is 0.593. C_p varies with wind speed for individual turbines, so usually C_p is stated for the rated wind speed of a turbine. In reality maximum C_p values of between 0.35 – 0.45 are expected at wind speeds of around 12m/s²⁰⁷.

A HAWT typically has a higher C_p than a similar sized VAWT because, in the VAWT, the blades rotate parallel to the ground and consequently half the turbine is rotating in the wrong direction (i.e. out of the wind) at a given time. However, VAWTs have been observed to perform better than HAWTs in turbulent conditions because they can accept wind from any direction without adjustment (yaw)²⁰⁸. This study has identified both HAWTs and VAWTs that are potentially suitable for mounting on a street lighting column (section 4.4).

²⁰⁶ Van Kuik, G., *The Lanchester–Betz–Joukowski Limit*, Wind Energy, Vol. 10, Issue 3, May/June 2007, pages 289 - 291

²⁰⁷ Twidell, J. A., Wier, A.D., *Renewable Energy Resources (2nd edition)*, Taylor & Francis, 2006, page 264

²⁰⁸ Riegler, H., *HAWT versus VAWT*, REFocus, July / August 2003, pages 44 - 46

4.1.3 Capacity Factor (or Load Factor)

The capacity factor of a turbine is a relative measure of the output that expresses the output of a turbine over a period of time as a percentage of the theoretical maximum output of the turbine over the same period of time. For example, the theoretical maximum output of a small turbine with a rated power of 200W may be calculated as follows:

Total hours per year = $24 \times 365 = 8760$ hours

Theoretical maximum output = $200\text{W} \times 8760\text{h} = 1752000 \text{ Wh / year}$
 $= 175.2 \text{ kWh / year}$

Assuming that the turbine generates 350400Wh (35.04 kWh / year) over this period then its capacity factor is 20%. Capacity factor is therefore a measure of the utilisation of the turbine. However, it can equally be used to describe the resource potential of a site. Current guidance for siting wind turbines suggests that smooth open sites on high ground provide the best conditions for power generation (section 4.3). Therefore, from the review of research concerning the micro-scale wind regime, together with the published siting guidance, a turbine located in an urban environment would be expected to operate at a lower capacity factor than an equivalent turbine located in an open rural site.

Sinden reports that on-shore wind turbine capacity factor for the UK is 27% based on long term averages²⁰⁹. This is derived mainly from data for large wind farms and includes the time that turbines were not operational for maintenance reasons, therefore it is not directly relevant to this study. However, assuming that these turbines are mostly located in open rural sites (as is generally the case for commercial wind farms), this does provide an indication of what a typical capacity factor might be for a 'good' site. It is therefore reasonable to expect that capacity factors in the urban environment would be below 27%. Indeed, Best et al suggest that <10% should be expected in urban locations²¹⁰.

²⁰⁹ Sinden, G., *Wind Power and the UK Wind Resource*, Environmental Change Institute, Oxford University, 2005, page 5

²¹⁰ Best, M. et al, *Small-scale wind energy Technical Report Part 2*, Met Office, July 2008, page 29

4.1.4 The Power Curve Method of Characterising Wind Turbine Performance

The performance of a wind turbine can be represented as a power curve (figure 36). This is the typical method used by manufacturers (and in wind turbine research) to describe the characteristics of a turbine. The power curve indicates the cut-in speed of the turbine, the rated wind speed (wind speed at which the turbine generates its stated maximum energy output) and the furling speed (the limiting wind speed when the turbine begins to reduce output to avoid damage). By matching the power curve with the wind speed distribution over time (described in section 4.3), it is possible to calculate the sum of the energy produced by the turbine across the range of wind speeds. Therefore, the energy output for an average wind speed can be calculated.

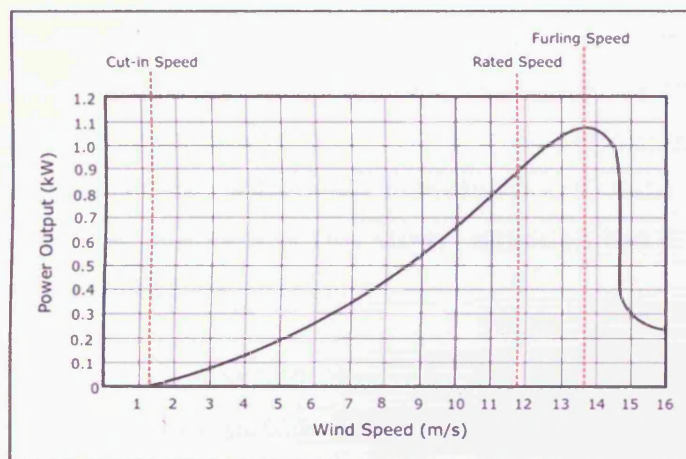

Figure 36: Example power curve for a 900W wind turbine with a rated wind speed of 9m/s

To produce a power curve requires energy data that are correlated to wind speed. Wind speed at the hub height and the amount of energy generated by the turbine are measured over a given period of time. Data are then averaged, typically for 10 minute periods²¹¹. The average energy (Wh) for each 10 minute period is multiplied by 6 to give the average hourly energy output (W) for a given wind speed and this is then plotted against the corresponding wind speed. The power curve is then produced by using a line of best fit.

²¹¹ Brown, H., Hailes, D., Rhodes, M., *Warwick Wind Trials – Final Report*, Encraft, 2009, page 29

There have been relatively few independent studies on micro- and mini-turbines²¹² and this has attracted some controversy, notably from Gipe, who describes the data published by some manufacturers as "*informed guesswork*"²¹³. Similarly, both Encraft in its 'Warwick Wind Trials' study and the EST in its 'Location, Location, Location' study found that, in addition to a lack of a standardised method for calculating power curves, "*a number of manufacturers' power curves were deemed inaccurate or incorrect*"²¹⁴. However, in the event that power curve data are reasonably accurate, this should provide the basis for a realistic estimation of energy output when combined with measured wind speed data over a period of time.

In the absence of published empirical evidence to the contrary, the manufacturers' power curve may be the only description of turbine performance available. Findings from this study confirm the previous statement that for many small wind turbines, especially for those new to the market, the manufacturers' power curve is the only performance information available. Therefore, whilst not ideal, manufacturers' data were used for calculations in the later chapters of this study, although the limitations of this data have been considered in the results.

In response to concern regarding the reliability of manufacturers' power curves, the BWEA has proposed a new standard, the Annual Energy Production (AEP)²¹⁵. This is intended to provide a consistent basis for calculating the annual yield of a small wind turbine at an average annual wind speed of 5m/s. It is thought likely that this standard will come into effect by early 2010²¹⁶.

²¹² Peacock, A.D. et al, *Micro wind turbines in the UK domestic sector*, *Energy and Buildings*, Volume 40, 2008, pages 1324 - 1333

²¹³ Gipe, P., *Wind Energy Basics*, Chelsea Green Publishing, 1999, page 20

²¹⁴ Energy Savings Trust, *Location, Location, Location - Domestic small-scale wind field trial report*, EST, July 2009, page 17

²¹⁵ *BWEA Small Wind Turbine Performance and Safety Standard*, BWEA, February 29th 2008

²¹⁶ Energy Savings Trust, *Location, Location, Location - Domestic small-scale wind field trial report*, EST, July 2009, page 17

4.1.5 Average Wind Speed as an Indicator of Energy Output

Wind resource at a site is often quoted in terms of average wind speed in m/s. This usually refers to the average annual wind speed, although it sometimes refers to the average monthly wind speed. This does not provide an effective measure of the potential wind resource unless the wind speed distribution is also taken into account, as described in section 4.3.

Table 14 shows theoretical data for two no. 8 time unit scenarios, Scenario A and Scenario B, both with an average wind speed of 4.5 m/s. In Scenario A the wind speed is assumed to be a constant 4.5 m/s for the 8 time unit periods. Therefore the average wind speed for this period is 4.5 m/s. In Scenario B the wind speed increases each hour from 1 m/s to 8 m/s in hourly steps. Here the average wind speed over the 8 time units is also 4.5 m/s, however the average wind power is significantly more because power is a cubic function of wind speed.

Site A		Site B	
Wind Speed (m/s)	V ³	Wind Speed (m/s)	V ³
4.5	91	1	1
4.5	91	2	8
4.5	91	3	27
4.5	91	4	64
4.5	91	5	125
4.5	91	6	216
4.5	91	7	343
4.5	91	8	512
Average (m/s)	Average V ³	Average (m/s)	Average V ³
4.5	91	4.5	162

Table 14: Theoretical wind resource for 2 scenarios showing effect of distribution

It is apparent from published data that wind speed varies with time and is rarely constant²¹⁷. Instead a frequency distribution of wind speeds can be plotted for a specific location. The most accurate way to achieve this is to record the wind speed and direction data at a site for a given period of time (commonly 12 months at 30 minute averages when assessing the resource potential for commercial wind farms). This can be an expensive and time consuming process as the wind speed distribution varies for different locations. Therefore, statistical expressions are often employed.

²¹⁷ Sinden, G., *Wind Power and the UK Wind Resource*, Environmental Change Institute, Oxford University, 2005, page 4

4.1.6 Wind Speed Distributions

The distribution of wind speed about an average can be represented by a statistical function. For many years the two-parameter version of the Weibull distribution²¹⁸ has been the de-facto industry standard for modelling wind speed distributions²¹⁹. The European Wind Atlas uses the following mathematical expression to describe a two-parameter Weibull distribution:

$$f(u) = \frac{k}{A} \left(\frac{u}{A}\right)^{k-1} \exp\left(-\left(\frac{u}{A}\right)^k\right)$$

where $f(u)$ is the frequency occurrence of wind speed (u), (A) is the scale parameter and (k) is the shape parameter (figure 37).

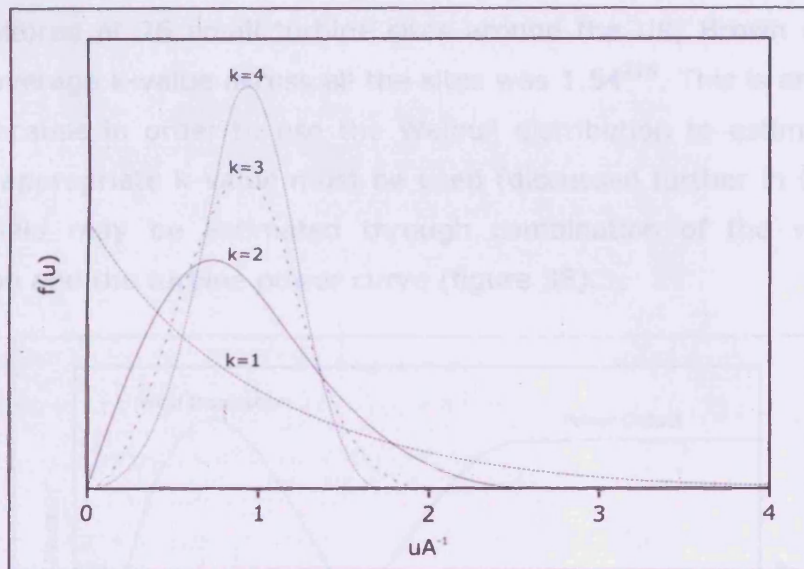

Figure 37: Weibull distributions for different k -values

Weibull-representative data were shown to be effective in representing monitored time-series data. Celik reported an overall error of 2.79% having compared analytically calculated Weibull function parameters with monitored wind speed data for a total of 96 months from 5 different locations²²⁰. Furthermore, Troen and Petersen have found that data errors common at low wind speeds, such as instrument limitations and data truncation, which can

²¹⁸ Weibull, W., *A statistical distribution function of wide applicability*, Journal of Applied Mechanics, Volume 18, 1951, pages 293 - 297

²¹⁹ Best, M. et al, *Small-scale wind energy Technical Report*, Met Office, July 2008, page 13

²²⁰ Celik, A.N., *Energy output estimation for small-scale wind power generators using Weibull-representative wind data*, Journal of Wind Engineering and Industrial Aerodynamics, Volume 91, 2003, page 706

over-report the frequency of calms (zero wind speed), do not significantly affect the fitting process²²¹. However, Troen and Peterson warn against using the Weibull distribution in situations where the surrounding wind speed is generally high but the site wind speed is <3m/s due to heavy local sheltering because the analysis becomes inaccurate²²².

Findings for k-values reported by Troen and Petersen, by fitting a Weibull distribution to hourly mean speed data from the wind stations used in the European Wind Atlas, suggests that the average k-value for northern European climates is close to 2²²³. In situations where k=2 then the distribution is equivalent to a one-parameter Rayleigh distribution, and this is sometimes used to represent wind data²²⁴. The Met Office suggests that a k-value of 1.8 is the most appropriate for the UK²²⁵. However, from wind speed data monitored at 26 small turbine sites around the UK, Brown et al found that the average k-value across all the sites was 1.54²²⁶. This is an important finding because in order to use the Weibull distribution to estimate energy yield the appropriate k-value must be used (discussed further in Chapter 6). Energy yield may be estimated through combination of the wind speed distribution and the turbine power curve (figure 38).

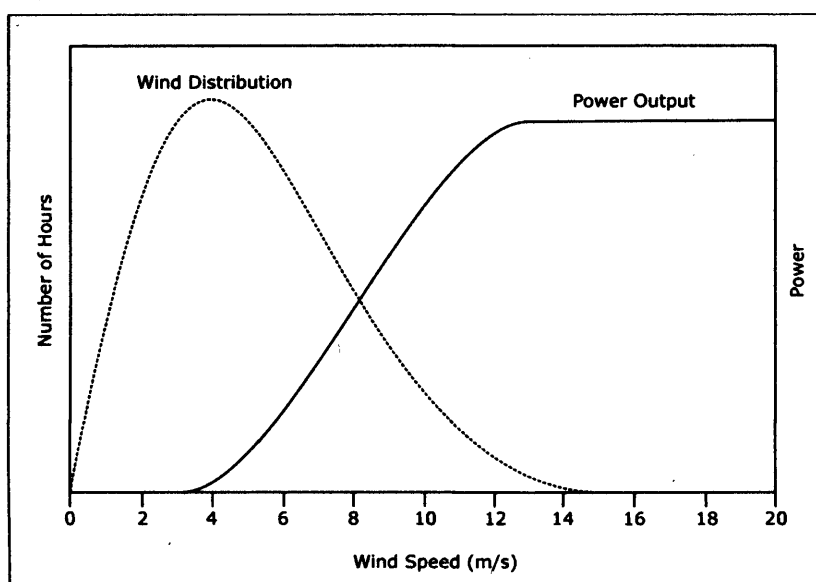

Figure 38: Estimating energy yield using wind speed distribution and turbine power curve

²²¹ Troen, I., Petersen, E.L., *European Wind Atlas*, Riso Laboratory, 2000, page 583

²²² Troen, I., Petersen, E.L., *European Wind Atlas*, Riso Laboratory, 2000, page 584

²²³ Troen, I., Petersen, E.L., *European Wind Atlas*, Riso Laboratory, 2000, page 581

²²⁴ Gipe, P., *Wind Energy Basics*, Chelsea Green Publishing, 1999, page 10

²²⁵ Best, M. et al, *Small-scale wind energy Technical Report Part 2*, Met Office, July 2008, page 27

²²⁶ Brown, H., Hailes, D., Rhodes, M., *Conclusions and empirical data from the first large scale public field trial of building-mounted micro-wind turbines*, EWEC, Marseilles, 16th - 19th March, 2009

4.1.7 Turbulence

The amount of wind turbulence experienced in an urban environment is dependent on many local characteristics, including building size, height and orientation²²⁷. Both Gipe²²⁸ and Piggot²²⁹ advise that turbulence may cause excessive wear to the blades and bearings of small wind turbines and that constant re-orientation (yaw) adversely affects energy yield. Syngellakis and Traylor agree stating that, "*light turbulence will decrease performance since a turbine cannot react to rapid changes in wind direction; while heavy turbulence may reduce the turbine's operational life*"²³⁰. As previously discussed, this is an area where VAWTs have an advantage over HAWTs as they can accept wind from any direction without having to re-orientate²³¹. However, to date there has been little published research into the effects of turbulence on the performance of small wind turbines in urban environments.

Faure et al analysed measured wind speed and direction data from an urban location and found that there was a "*very high fluctuation of the horizontal component*" that equated to a "*mean turbulence of 45%*"²³². This study found that it was possible to reproduce the levels of turbulence found in the measured data in a WT simulation. By testing a small turbine (rated 200W) in the WT under turbulent conditions (fluctuating wind speed), Faure et al found that increasing the turbulence intensity from 5% to 40% strongly decreased the measured energy yield from the turbine.

The effect of turbulence on small wind turbines in urban environments is an emerging area of research and consequently the parameters defining what constitutes excessive turbulence are currently uncertain. As such, while consideration is made that the urban environment, by nature of its higher roughness, will experience a more turbulent wind regime than an open rural site, the specific effects of turbulence on turbine performance has, by necessity, been disregarded in this study. It is, however, acknowledged that this should be viewed as a limitation of the results (Chapter 6).

²²⁷ Syngellakis K., Traylor, H., *Urban Wind Resource Assessment in the UK*, EC, February 2007, p. 10

²²⁸ Gipe, P., *Wind Energy Basics*, Chelsea Green Publishing, 1999, pages 73

²²⁹ Piggot, H., *Choosing Windpower*, Centre for Alternative Technology, 2006, page 63

²³⁰ Syngellakis K., Traylor, H., *Urban Wind Resource Assessment in the UK*, EC, February 2007, p. 19

²³¹ Riegler, H., *HAWT versus VAWT*, REFocus, July / August 2003, pages 44 – 46

²³² Faure, X., Sabre, M., Palier, P., *Small wind turbines in urban environment: Qualification steps*, Proceedings of EWEC, Marseilles, 16th - 19th March, 2009

4.2 Existing Guidance for the Location of Wind Turbines

While published guidance for locating wind turbines (both commercial large scale and small scale) has existed in the public domain for several years, specific guidance for small (micro and mini) turbines has only recently become available, probably due to the growth in the domestic wind power market. The scope of this guidance, even in the more detailed examples, is relatively simplistic.

The following sources of guidance for siting small wind turbines have been identified (this does not represent an exhaustive list of all published guidance):

- British Wind Energy Association (BWEA)²³³
- American Wind Energy Association (AWEA)²³⁴
- European Commission (EC)²³⁵
- British Meteorological Office and The Carbon Trust²³⁶
- Other published sources²³⁷

The following sections review the guidance published by each of the above organisations and a summary of findings from this guidance is presented. In each case, where quotations are included, these are from the stated guidance documents.

²³³ <http://www.bwea.com/you/siting.html> - last accessed August 2009

²³⁴ <http://www.awea.org/smallwind> - last accessed August 2009

²³⁵ Syngellakis K., Traylor, H., *Urban Wind Resource Assessment in the UK*, EC, February 2007

²³⁶ Best, M. et al, *Small-scale wind energy Technical Report*, Met Office, July 2008

²³⁷ For example: Gipe, P., *Wind Energy Basics*, Chelsea Green Publishing, 1999

4.2.1 BWEA Guidance

The BWEA publishes guidance entitled '*Siting a Small Wind Turbine*' which provides basic directions for "users of small turbines"²³⁸. The BWEA guide defines 'good' sites as those in a laminar wind flow situation and 'bad' sites as those where turbulent wind flow is present. The guide describes a 'good' location thus:

"It is generally agreed that the ideal position for a wind turbine generator is a smooth hill top, with a flat clear fetch, at least in the prevailing wind direction. The wind speeds up significantly near the top of the hill and the air flow should be reasonably smooth and free from excessive turbulence. Excessive turbulence causes fatigue damage and shortens a turbine's working life".

The guidance recommends that local obstructions (trees and houses) should be avoided if possible. If not possible then the turbine should be mounted on a tower higher than these obstructions.

In terms of assessing the local wind resource (which the guidance "*strongly recommends*" when wind strength at a site is in doubt) the BWEA suggests that the most reliable method is to "*take regular [wind speed] measurements over a period of several months, preferably a year*". The guidance warns against inferring the wind resources at a specific location from local data (met office or airfield data), stating that it is "*not straightforward to use data even from nearby sites*". Furthermore, the guidance recommends of CWE modelling that "*such predictions should be applied with care*". For an estimation of annual wind speed, the BWEA recommend using the NOABL database. However, this does not take into account local surface features or topography and is therefore of limited value for urban areas (as discussed in section 3.3).

Overall the BWEA guidance for siting small turbines is very limited. Furthermore, the description of what constitutes a 'bad' site would apply to most (if not all) urban near street level environments. It is therefore the recommendation of this guidance that small wind turbines should not be located thus unless data collected from the site can demonstrate otherwise.

²³⁸ <http://www.bwea.com/you/siting.html> - last accessed July 2009

The key relevant points of the BWEA guidance are summarised below²³⁹:

- *"Get a reliable estimate of the winds to be expected at the proposed site. There is no substitute for actual measurements. The turbine manufacturers should be prepared to help. You can get an estimate of the annual mean wind speed for a given location by entering the OS grid reference into the UK wind speed database".*
- *"Mount the turbine on as high a tower as possible and well clear of obstructions, but do not go to extremes. Easy access will be required for erection and foundations for the tower may be needed depending on the size and tower type. It is also important to ensure that the wind turbine can be easily lowered for inspection and maintenance".*
- *"Try to have a clear, smooth fetch to the prevailing wind, e.g. over open water or smooth ground. If possible site the turbine on a smooth hill".*
- *"Use cable of adequate current carrying capacity (check with the turbine supplier. This is particularly important for low voltage machines). Cable costs can be substantial".*
- *"Consult your local council as to whether you need planning permission. You should try to minimise the environmental impact of the turbine".*

Although this guidance does not specifically state that urban sites are unsuitable for small wind turbines, it clearly implies that this is the case. Furthermore, the guidance is not sufficiently detailed to allow urban sites to be compared, other than at a very basic level. The recommendation that wind data is collected from the proposed location has been adopted by this study, although the BWEA guidance makes no mention of comparing these data with modelling methods such as WT studies.

²³⁹ <http://www.bwea.com/you/siting.html> - last accessed July 2009

4.2.2 AWEA Guidance

The AWEA guidance for locating small wind turbines is broadly similar to the BWEA guidance and it is not necessary to repeat this here. However, in addition, the AWEA suggests that average annual wind speeds of 3 – 4 m/s "may be adequate for non-grid connected applications" and that most sites (in the US) should experience greater annual average wind speeds than this²⁴⁰. Also published in the AWEA guidance literature is a list of wind power classes based on wind power density calculations for hub heights of 10m (small wind turbines) and 50m (commercial wind farms). For example, wind power classes ≥ 4 are recommended for large scale wind farms. This is a useful method as it allows sites to be defined through simple classification. Table 15 illustrates the AWEA classes of wind power density.

Wind Power Class	Height 10m		Height 50m	
	Wind Power Density (W/m ²)	Wind Speed (m/s)	Wind Power Density (W/m ²)	Wind Speed (m/s)
1	<100	<4.4	<200	<5.6
2	100 - 150	4.4 - 5.1	200 - 300	5.6 - 6.4
3	150 - 200	5.1 - 5.6	300 - 400	6.4 - 7.0
4	200 - 250	5.6 - 6.0	400 - 500	7.0 - 7.5
5	250 - 300	6.0 - 6.4	500 - 600	7.5 - 8.0
6	300 - 400	6.4 - 7.0	600 - 800	8.0 - 8.8
7	>400	>7.0	>800	>8.8

Table 15: Classes of wind power density at 10m and 50m (AWEA guidance)

The AWEA also published a report for state and local government in 2008 that set out best practice guidance covering various aspects of small wind turbine siting, including planning issues (set back distances and height, aesthetics, noise) and financial issues (property values, insurance)²⁴¹. The technical siting guidance contained in this document gives a basic overview of factors likely to affect energy output and does not add to the BWEA guidance. However, there is a small section entitled "Rooftop Turbines and Urban Environments" that references the study by Heath et al (section 3.2.4) and recommends that in a dense urban environment "a turbine must be sited very precisely in order to gain access to wind of sufficient quality"²⁴².

²⁴⁰ <http://www.awea.org/faq/basicwr.html> - last accessed July 2009

²⁴¹ *In the Public Interest - How and Why to Permit for Small Wind Systems*, AWEA, September 2008

²⁴² *In the Public Interest - How and Why to Permit for Small Wind Systems*, AWEA, Sept 2008, p. 14

4.2.3 European Commission Guidance

The European Commission published the findings of a study of the UK urban wind resource in 2007²⁴³. This report examined methods of estimating the wind resource in urban areas and compared a small sample of measured data with estimates from the NOABL database. This comparison found that the NOABL database significantly over-estimated the wind speed at near ground level ($\leq 10\text{m}$) and also at building roof height. The report concluded that *"modelling and database methods need to be developed to improve the estimation of urban wind speeds"*²⁴⁴. Annexe 1 of the report contains some limited guidance for locating small turbines in urban environments. The main points are summarised as follows:

- Select sites with the highest average annual wind speed.
- Select sites with estimated wind speeds $>5.5\text{m/s}$ by the NOABL database.
- Identify the prevailing wind direction(s) and if possible select sites with only one prevailing wind direction.
- For mast mounted turbines on the ground, the hub height should be at least 9m.
- For roof mounted turbines, the hub height should be at least 6m above the roof.
- Avoid locations where there is an obstruction directly behind the turbine in the lee of the prevailing wind.
- The best locations for wind turbines are found at the top of smooth slopes.
- Coastal locations may provide a better wind resource if prevailing wind direction is from the sea.
- Higher wind speeds are more likely to be found at the edge of a settlement when the wind direction is from the surrounding rural land.
- A building located in the middle of a settlement or built up area is highly unlikely to have a good wind regime.

²⁴³ Syngellakis K., Traylor, H., *Urban Wind Resource Assessment in the UK*, European Commission, February 2007

²⁴⁴ Syngellakis K., Traylor, H., *Urban Wind Resource Assessment in the UK*, European Commission, February 2007, page 17

4.2.4 Met Office and Carbon Trust Guidance

The Met Office has worked with the Carbon Trust to develop guidance for locating small wind turbines. In addition to this guidance, the Carbon Trust has also published a wind yield prediction tool that is discussed further in section 4.3.2. The 'Small-scale Wind Energy Technical Report', published in 2008, includes guidelines for locating wind turbines that were developed from the modelling methodology described by Best et al²⁴⁵.

An interesting aspect of this methodology is that Best et al divide the roughness characteristics of an urban area into 2 categories, general surrounding roughness (a group of buildings of a similar height) and isolated obstructions (an isolated tall building that protrudes above the general roughness). This effectively combines current knowledge of wind flow over urban canyons (discussed in section 3.1.3) and wind flow around isolated obstructions. The latter could equally apply to an isolated building in flat countryside as this would also be classed as an isolated obstruction rather than changing the roughness class. In relation to isolated obstructions, Best et al state that:

"In some situations the wind speed can be enhanced by flow over buildings. However it is difficult to exploit this without a detailed site-specific study. The speed up is likely to be restricted to a certain range of wind directions and may be associated with significant vertical motions or increased turbulence which may reduce or eliminate the benefit, even for the directions which do yield a speed up"²⁴⁶.

Similar to the other guidance discussed in this section, the Met Office recommends that wind turbines are located in open rural sites, ideally close to the top of smooth hills, however, they do offer recommendations for sites that do not fall into this category. Specifically, that, if a turbine is to be located in an urban environment then it should be as close as possible to a smoother area that is between the site and the prevailing wind direction.

²⁴⁵ Best, M. et al, *Small-scale wind energy Technical Report*, Met Office, July 2008

²⁴⁶ Best, M. et al, *Small-scale wind energy Technical Report*, Met Office, July 2008, page 102

Elements of the Met Office guidance that are of particular relevance to this study are presented schematically in figure 39. In each case location (A) is preferred to (B), (B) to (C) and (P) is the prevailing wind direction.

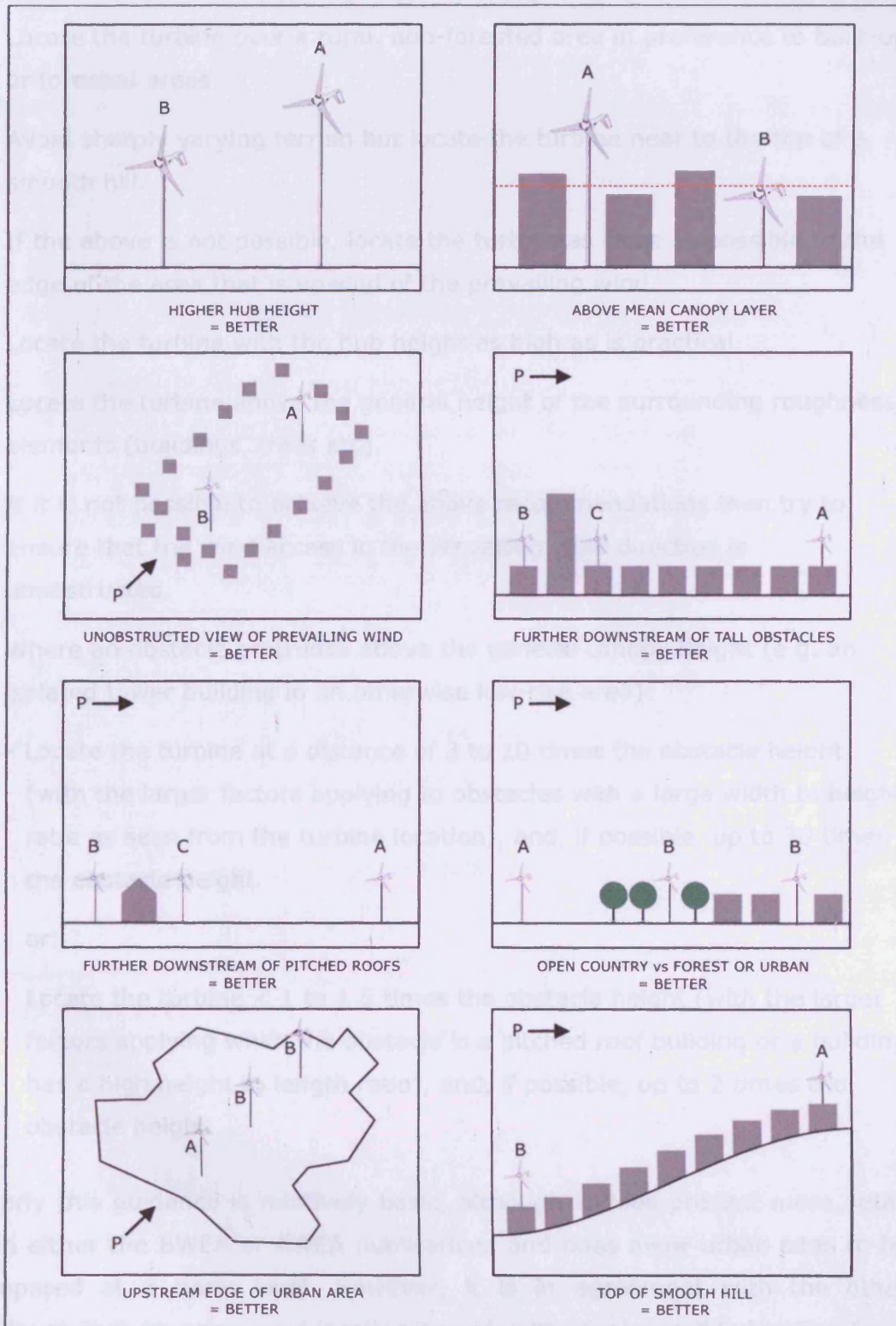

Figure 39: Schematic representation of the Met Office guidance for locating turbines

The key relevant points of the Met Office guidance for siting wind turbines can be summarised as follows:

- Consider prevailing wind direction when locating turbines.
- Locate the turbine over a rural, non-forested area in preference to built-up or forested areas.
- Avoid sharply varying terrain but locate the turbine near to the top of a smooth hill.
- If the above is not possible, locate the turbine as close as possible to the edge of the area that is upwind of the prevailing wind.
- Locate the turbine with the hub height as high as is practical.
- Locate the turbine above the general height of the surrounding roughness elements (buildings, trees etc).
- If it is not possible to achieve the above recommendations then try to ensure that the wind access in the prevailing wind direction is unobstructed.
- Where an obstacle protrudes above the general canopy height (e.g. an isolated tower building in an otherwise low-rise area):
 - Locate the turbine at a distance of 3 to 10 times the obstacle height (with the larger factors applying to obstacles with a large width to height ratio as seen from the turbine location), and, if possible, up to 30 times the obstacle height.

or:

Locate the turbine < 1 to 1.5 times the obstacle height (with the larger factors applying when the obstacle is a pitched roof building or a building has a high height to length ratio), and, if possible, up to 2 times the obstacle height.

Clearly this guidance is relatively basic, although it does present more detail than either the BWEA or AWEA publications and does allow urban sites to be compared at a basic level. However, it is in agreement with the other guidance that an open rural location provides the best possible location for a wind turbine.

4.2.5 Other Sources of Guidance

Various other sources of guidance exist, notably that published in books or by private individuals with an interest in wind energy. For example, Gipe has written extensively on wind turbines and also maintains the website 'wind-works.org' that provides an independent resource for wind energy. Additionally Gipe publishes the results of power performance monitoring from micro- and mini-turbines at a 10 ha test site in the Tehachapi Mountains, California.

Gipe describes a number of 'rules of thumb' for siting small wind turbines for best performance²⁴⁷. These are summarised as follows:

- 10m is the minimum mast height for mounting a small turbine.
- The zone of disturbed air created by an obstruction should be avoided.
- Turbines should not be mounted on building roofs or trees.
- Ideally the turbine mast should be located on the top of a hill.
- Open spaces in urban areas may provide appropriate sites.

²⁴⁷ Gipe, P., *Wind Energy Basics*, Chelsea Green Publishing, 1999, pages 71 - 76

4.2.6 Summary of Guidance

In general, current guidance for locating small wind turbines in an urban environment is quite limited and restricted largely to a series of 'rules of thumb'. Of the sources identified there is general agreement that the urban environment is likely to provide a worse wind resource than an open rural environment. There is also agreement that turbines should be mounted as high as possible to benefit from the increased wind speeds away from the ground. Table 16 compares the main points from the guidance reviewed.

	BWEA	AWEA	EC	Met Office	Gipe
Mount turbine as high as possible	Y	Y	Y	Y	Y
Guidance specifies minimum mast height	-	-	9m	-	10m
Mount turbine higher than surrounding obstacles	-	-	-	Y	Y
Use measured wind speeds rather than estimates	Y	Y	Y	Y	Y
Guidance specifies minimum wind speed (m/s)	-	3 - 4	-	-	5
Avoid lee side of protruding obstacles	Y	Y	-	Y	Y
Avoid areas of excessive turbulence	-	-	Y	-	Y
Locate turbine for the prevailing wind direction	-	-	Y	Y	-
Mount turbine at top of a smooth hill	Y	Y	Y	Y	Y
Edge of urban area is more likely to be good site	-	-	Y	Y	-
Open areas in cities may provide sufficient resource	-	-	-	Y	Y
Coastal locations may have a better wind resource	-	-	Y	-	-
Avoid sites with obstructions behind the turbine	-	-	Y	-	-
Roof tops may be a suitable mounting location	-	-	Y	Y	N

Table 16: Comparison of siting guidance for wind turbines in urban areas

The location of street lighting in the urban environment is governed by the constraints discussed in Chapter 2. Therefore, this must be taken into account in the application of turbine siting guidance to turbines mounted on street lighting columns. Clearly some of the guidance, such as that relating to mounting turbines on building roofs, is not directly relevant to the hybrid street light, however, there is sufficient relevant guidance to allow a simple site assessment to be made. An analysis of the case study location, based on this guidance, is presented in Chapter 5.



A potential concern is that there appears to be some discrepancy between the published guidance. For example, Gipe (figure 40) recommends that the horizontal avoidance zone in the lee of an obstruction should be $20H$ (where H is the height of the obstruction) and that the maximum height of this zone is $2H$. However, the BWEA recommend a horizontal avoidance zone of $10H$ with a height of $1H$ (figure 41).

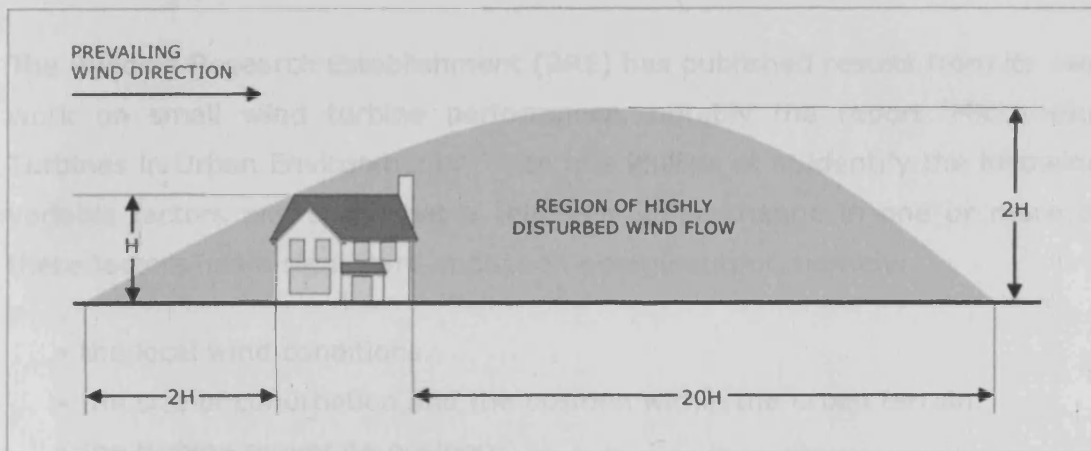

Figure 40: Suggested avoidance zone for turbines in the lee of an obstacle (Gipe)²⁴⁸

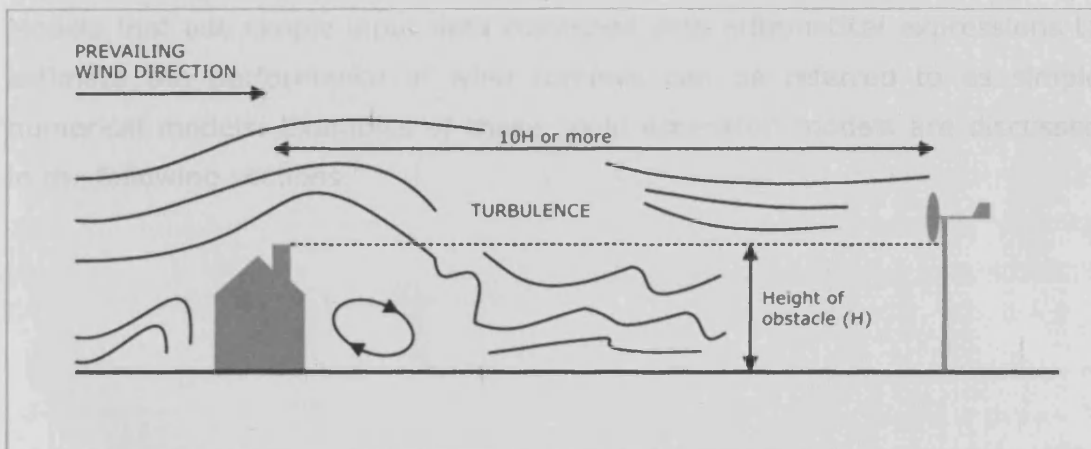

Figure 41: Suggested avoidance zone for turbines in the lee of an obstacle (BWEA)²⁴⁹

Overall, the published guidance is broadly in agreement. Whilst there are some inconsistencies, this may be expected given the simplistic scope of much of the guidance and the lack of quantitative definitions. Although a simple site analysis is possible with the existing guidance, more detailed tools are required to provide a quantitative indication of wind turbine performance.

²⁴⁸ Gipe, P., *Wind Energy Basics*, Chelsea Green Publishing, 1999, page 72

²⁴⁹ <http://www.bwea.com/you/siting.html> - last accessed July 2009

4.3 Resource / Yield Estimation

The existing guidance for siting small wind turbines is inadequate for predicting energy yield for the reasons described in the previous section. Perhaps the most important factor lacking from most of the current guidance is quantitative data such as minimum acceptable wind speeds, minimum distances from obstacles and minimum mounting heights.

The Building Research Establishment (BRE) has published results from its own work on small wind turbine performance, notably the report 'Micro-wind Turbines in Urban Environments'²⁵⁰. In this Phillips et al identify the following variable factors and state that a relatively small change in one or more of these factors has a significant impact on energy output, namely:

- the local wind conditions.
- the size of conurbation and the position within the urban terrain.
- the turbine mounting position.
- the proximity of the surrounding buildings.

Models that use simple input data combined with arithmetical expressions to estimate the performance of wind turbines can be referred to as simple numerical models. Examples of these 'yield estimator' models are discussed in the following sections.

²⁵⁰ Phillips, R. et al, *Micro-wind turbines in urban environments*, HIS BRE Press, 2007

4.3.1 μ Wind Tool

Bahaj et al developed a tool for building mounted micro turbines, ' μ Wind', designed to allow the user to "assess the suitability of micro-wind electrical generation in the built environment"²⁵¹. This tool comprises 4 no. modules, allowing the user to define a wind resource model, the turbine performance, the electricity demand and the financial and carbon savings.

The wind resource module has a library of 9 no. sites around the UK with yearly sets of wind data as either 30 minute or 60 minute averages. The turbine performance module allows the user to select a specific turbine from a turbine library that contains manufacturers' power curve data. This module also allows terrain roughness and turbine height to be defined as well as wind shadow. Wind speed data from module 1 is then corrected for roughness and height using boundary layer principles by module 2. Simple wind shadowing is then defined. Modules 3 and 4 are primarily concerned with domestic energy demand and potential carbon savings.

While the μ Wind model was not available to test for this study, from the published literature it is considered feasible that this tool could provide a basis for a more detailed model. However, Bahaj et al concede that "there is no substitute to real measured performance data obtained from quantifiable environments and devices"²⁵² and that "in the absence of real operational data full, constructive, and verifiable judgement on the appropriateness of the technology in the built environment will remain unfulfilled"²⁵³.

²⁵¹ Bahaj et al, *Urban energy generation: Influence of micro-wind turbine output on electricity consumption in buildings*, Energy and Buildings, volume 39, 2007, page 157

²⁵² Bahaj et al, *Urban energy generation: Influence of micro-wind turbine output on electricity consumption in buildings*, Energy and Buildings, volume 39, 2007, page 164

²⁵³ Bahaj et al, *Urban energy generation: Influence of micro-wind turbine output on electricity consumption in buildings*, Energy and Buildings, volume 39, 2007, page 164

4.3.2 Carbon Trust Wind Yield Estimator

The Carbon Trust published an internet based wind speed prediction tool for locating small wind turbines in March 2009²⁵⁴, developed in a joint project with the Met Office (section 4.4.3). The detailed methodology for the tool is described by Clarke et al²⁵⁵. In some respects this is effectively a more detailed version of the μ Wind model. The aim of the tool is that "by inputting a postcode, details about the surrounding landscape and the type of turbine, users will be able to calculate the annual mean wind speed and likely energy generation for their proposed site"²⁵⁶. Figure 42 shows the main input screen.

Wind Yield Estimation Tool

1. Site details

a. Location

Region Great Britain

Please enter a grid reference for more accurate results.

Postcode OR Grid reference **Find**

b. Character

The tool will automatically select a canopy height based on your chosen site type. If you prefer, you can choose another site type or enter your better estimate in the canopy height box.

Select site type

High height and density
Buildings and trees are closely spaced and four ...more

Canopy height 12 m

2. Turbine details

a. Rotor height

Enter the the mid-rotor height in metres relative to the ground or the canopy layer. Specify how you have made your measurement by selecting the appropriate image. For the best estimate, the mid-rotor height should be entered as either above or below the canopy rather than above the ground.

Ground upward Canopy upward Canopy downward

Mid rotor height m

b. Turbine specifications

If you do not know the details of the turbine you wish to install, you can still get an estimate of the long term average wind speed at your location by clicking 'Calculate' without filling in this section.

Turbine type **Add / Edit Power curve data**

3. Results

Annual mean wind speed m/s **Save settings** **View shear graphs**

Annual mean energy generation kWh/y **Clear results** **Advanced settings**

Carbon dioxide saving kgCO2/y **Back to introduction**

Calculate

Figure 42: Carbon Trust Wind Yield Estimation Tool – main screen

²⁵⁴ <http://www.carbontrust.co.uk/windpowerestimator> - Last accessed August 2009

²⁵⁵ Clarke, P. et al, *Estimating the Wind Energy Resource*, Met Office, 2008

²⁵⁶ Carbon Trust Press Release, 10th March, 2009 (www.carbontrust.co.uk)

The Carbon Trust tool uses a similar technique to the European Wind Atlas (section 3.1.2) to visually characterise surface roughness based on an image and a description of the site type (figure 43).

Site types
Please select a site type that best describes your location.









<input checked="" type="radio"/>		<p>Open Countryside Buildings and trees are widely spaced. Open countryside and large open spaces with little urban infringement on the natural landscape.</p>	<p>Example:</p> <ul style="list-style-type: none"> • Farms • Small Holdings • Isolated buildings
<input type="radio"/>		<p>Woodland Mature trees dominate the surrounding area.</p>	<p>Example:</p> <ul style="list-style-type: none"> • Isolated buildings surrounded by mature woodland
<input type="radio"/>		<p>Low height and density, residential Buildings and trees are small and not closely spaced and all of a similar height.</p>	<p>Example:</p> <ul style="list-style-type: none"> • One or two-storey detached houses with gardens
<input type="radio"/>		<p>Low height and density, industrial Buildings and trees are small and not closely spaced and all of a similar height.</p>	<p>Example:</p> <ul style="list-style-type: none"> • Light industrial units • Warehouses • Low-height retail parks
<input type="radio"/>		<p>Medium height and density, residential Buildings of mixed height (two to four storeys) and mature trees.</p>	<p>Example:</p> <ul style="list-style-type: none"> • Closely spaced detached and semi-detached houses • Terraced houses
<input type="radio"/>		<p>Medium height and density, industrial Buildings of mixed height (two to four storeys) and mature trees.</p>	<p>Example:</p> <ul style="list-style-type: none"> • Mixed houses with shops, churches and schools
<input type="radio"/>		<p>High height and density Buildings and trees are closely spaced and four to six storeys high.</p>	<p>Example:</p> <ul style="list-style-type: none"> • Tall terraced houses • Low level apartment blocks • Traditional town centres • Dense factory sites
<input type="radio"/>		<p>High height and density Buildings and trees are closely spaced and four to six storeys high.</p>	<p>Example:</p> <ul style="list-style-type: none"> • Tall terraced houses • Low level apartment blocks • Traditional town centres • Dense factory sites
<input type="radio"/>		<p>Very high density, cityscape Tall towers of different heights in dense urban surroundings.</p>	<p>Example:</p> <ul style="list-style-type: none"> • Multi-storey tower blocks • Modern city centres with high-rise office blocks

Figure 43: Carbon Trust Wind Yield Estimation Tool – site selection

The tool is essentially a simple numerical method for down-scaling large scale reference wind climatology to a near ground location through adaptation to local surface roughness and orography. After the average wind speed at the defined height has been calculated, a Weibull distribution is then applied to give the wind speed distribution and combined with turbine power curve data to estimate energy output. The calculation method is shown in figure 44.

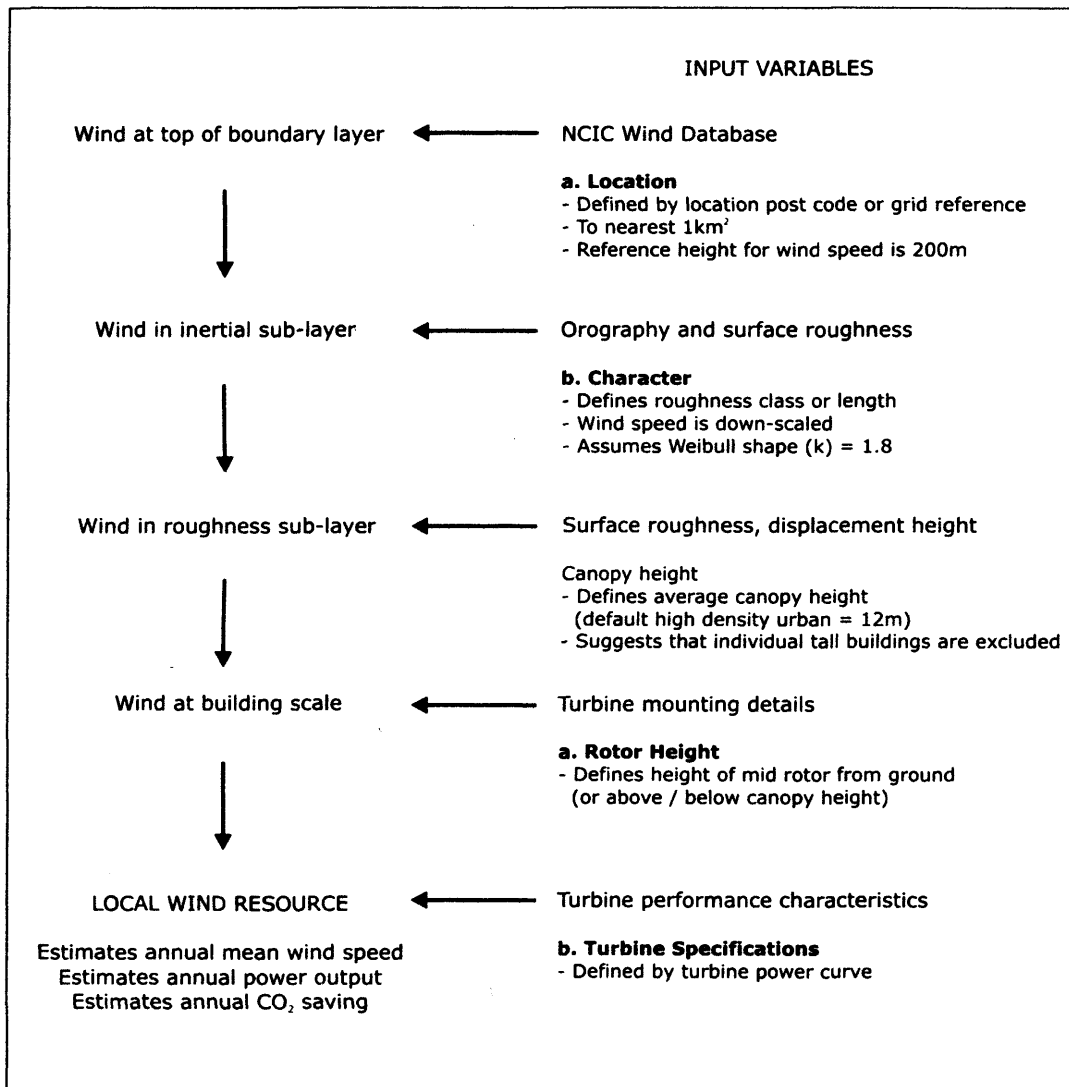

Figure 44: Input variables and calculation method for Carbon Trust tool

The Carbon Trust tool is relatively simple to use and allows a rapid comparison to be made between different turbine types. However, the tool is not sufficiently detailed to allow the comparison of 2 locations in close proximity in the same urban area.

Clarke et al made the following observations after the initial development of the model²⁵⁷:

- Turbine capacity factor is affected more by mounting height and environment than by individual power curve.
- In dense urban areas there is on average very low wind speed and therefore turbines mounted below roof height in these locations generate very little power.
- The more rural a location, the greater the potential for power generation. Areas at the edges of towns have a greater wind resource than town centres.
- The uncertainty in estimates of mean power generation arising from assumptions about meteorology is about a factor of two. The main cause of this uncertainty is the choice of wind climatology and the down-scaling methods used.
- Varying the Weibull shape parameter (k) from the default k=1.8 generally has an impact on the calculated energy output of <10% according to a sensitivity analysis of the tool.

The following improvements have been suggested to increase the accuracy of the results²⁵⁸:

- *"Use of a directionally dependent wind climatology, preferably taking into account spatial and directional variation in the shape of the wind speed distribution (as well as in the mean wind speed)".*
- *"Incorporation of edge and fetch effects and the influence of small scale orography (using directionally-dependent data)".*
- *"Incorporation of better knowledge of building characteristics (height, area, plan density)".*

²⁵⁷ Clarke, P. et al, *Estimating the Wind Energy Resource*, Met Office, 2008, pages 35 - 38

²⁵⁸ Clarke, P. et al, *Estimating the Wind Energy Resource*, Met Office, 2008, page 51

4.3.3 Energy Savings Trust – Wind Speed Prediction Tool

The Energy Savings Trust published an internet based wind speed prediction tool for locating small wind turbines in July 2009 (figure 45)²⁵⁹. Prior to the release of this tool the EST recommended using the NOABL database for selecting suitable locations for small wind turbines.

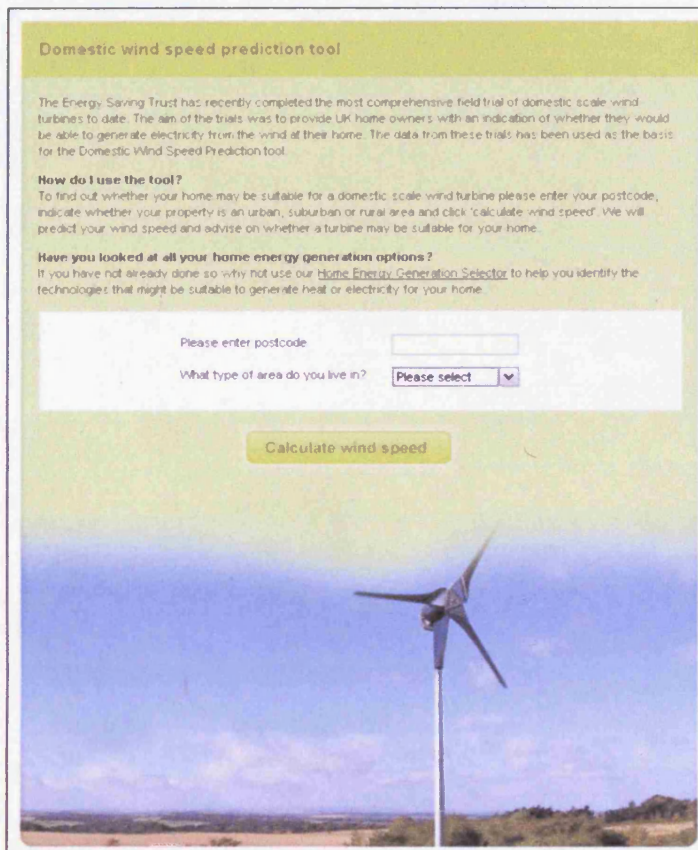

Figure 45: EST wind speed prediction tool – main screen

There is very little published information regarding the calculations used in this tool, however, it appears to use NOABL data together with an unspecified correction factor to account for surface roughness, classified by 'area type' as either urban, suburban or rural (see comparison of data in Chapter 5).

²⁵⁹ <http://www.energysavingtrust.org.uk/Generate-your-own-energy/Can-I-generate-electricity-from-the-wind-at-my-home> - last accessed August 2009

If the wind speed predicted by the tool is <5m/s then the EST does not recommend installing a turbine at this location. For a small sample of postcodes in the Cardiff region (CF) the predicted wind speed was significantly <5m/s for all of the urban and suburban area types. For rural area types where the predicted wind speed is >5m/s the advice states that a *"small scale wind turbine may be suitable", but goes on to state "however, wind speeds are dependent on the local topography and obstructions surrounding a property"*.

4.3.4 Other Methods of Estimating Yield

A potential alternative to the numerical models discussed in this section is energy output modelling using a BLWT. In addition to modelling wind flow in the urban boundary layer (discussed in section 3.2.1) BLWT studies have also been reported that employ scale models of wind turbines to estimate energy yield. For example, Neff et al simulated 5 no. 1:50 scale working model turbines (with working rotors and small generators) to assess their energy outputs in complex terrain, although compromises were made to accommodate the models in the tunnel²⁶⁰. While it has been shown that a BLWT is a suitable method for modelling the turbulent flow over terrain for resource assessment and turbine siting, experiments of this type are limited by the physical size of the BLWT²⁶¹. This is not the case with software tools, such as the WAsP tool, where the terrain and the wind turbines can effectively be modelled at 1:1 virtual scale.

²⁶⁰ Neff et al, *Upstream and Lateral Wind Turbine Wake Effects on Nearby Wind Turbine Performance*, Journal of Wind Engineering and Industrial Aerodynamics, Volume 36, 1990, pages 1405 – 1414

²⁶¹ Lubitz, W. D., White, B. R. *Atmospheric Boundary Layer Wind Tunnel Applications in Wind Turbine Siting*. Proceedings of World Wind Energy Conference, Beijing, China, Oct. 31 - Nov. 4, 2004.

4.3.5 Summary of Resource / Yield Estimation

Of the numerical prediction methods, the Carbon Trust Wind Yield Estimator tool provides the most user control of variables, allowing the site location to be selected (to the nearest 1km²) and both the canopy height, the turbine hub height and the turbine power curve to be defined. Furthermore, the EST report 'Location, Location, Location' that compared monitored turbine performance with predicted yields (section 4.5.2) found that this tool gave the most accurate predictions of the measured wind speeds of the methods tested. It was not considered appropriate to use a scale model wind turbine for this study because of the problems associated with this method identified by Neff et al. Therefore, of the methods discussed in this section, the Carbon Trust estimator tool could be considered the current 'state-of-the-art' for numerical methods of predicting wind yield in urban areas and was hence selected for comparison with the measured data.

4.4 Small Turbines Currently Available in the UK

Table 17 identifies the small wind turbines currently available in the UK that were considered to be suitable for mounting on a 10m street lighting column (listed alphabetically by manufacturer). Specifically, HAWTs with a rotor diameter $\leq 2.1\text{m}$ and VAWTs with a rotor height of $\leq 2\text{m}$ were judged to be an appropriate physical size, without a negative aesthetic impact on the column.

Horizontal Axis Wind Turbines						
Manufacturer	Model	Diameter (m)	Swept Area (m ²)	Rated Power (kW)	Rated Wind Speed (m/s)	Cut-in Speed (m/s)
Ampair	100	0.93	0.7	0.1	12.6	3.0
Ampair	300	1.2	1.1	0.3	12.6	3.0
Ampair	600	1.7	2.3	0.6	12.6	3.0
Eclectic	D400	1.1	1.0	0.4	16.0	2.55*
Marlec	Rutland 503 / 504	0.51	0.2	0.025	9.8	2.55
Marlec	Rutland 913	0.91	0.7	0.09	9.8	2.55
Marlec	Rutland 1803-2	1.8	2.5	0.34	10	3.0
Renewable Devices	Swift	2.1	3.5	1.5	12.5	3.4
SouthWest Windpower	Air X	1.15	1.04	0.4	12.5	3.58
SouthWest Windpower	Whisper 100	2.1	3.46	0.9	12.5	3.4
Windsave	WS1200	1.75	2.4	1.0	12.5	*

*Cut-in speed not stated – inferred value from manufacturer's power curve

*Manufacturer reportedly went into liquidation September 2009

Vertical Axis Wind Turbines						
Manufacturer	Model	Ø & H (m)	Swept Area (m ²)	Rated Power (kW)	Rated Wind Speed (m/s)	Cut-in Speed (m/s)
Ampair	Dolphin	0.265	0.14	0.005	15.0	1.5
Llumarlite	Easy Vertical	N/A	2.07	1.0	14.0	**
Llumarlite	Speedy Vertical	N/A	0.96	0.3	14.0	**
Windside	WS015	0.334x0.85	0.15	0.12	20	3.8
Windside	WS030B	0.3 x 1.0	0.3	0.12	15	2.8
Windside	WS2	1.02 x 2.0	2.0	0.24	20	2.0

**Models no longer available as of September 2009

Table 17: Small HAWT & VAWT wind turbines <2.1m Ø rotor currently available in the UK

A schematic visual comparison of the turbines listed in table 15 is shown in figure 46 and their respective power curves are shown in figure 47. For a more thorough understanding of the impact of turbine size on the aesthetic character of a street lighting column a questionnaire survey of designers, specifiers and the general public would be required and this is suggested in further work. Turbines with a energy output of <90W are not included as they were considered to be inappropriate in terms of energy output. As discussed in section 4.1.3 the capacity factor of a turbine in an urban environment is likely to be low (<27%) and therefore very small turbines are unlikely to produce sufficient electricity to be useful to the system.

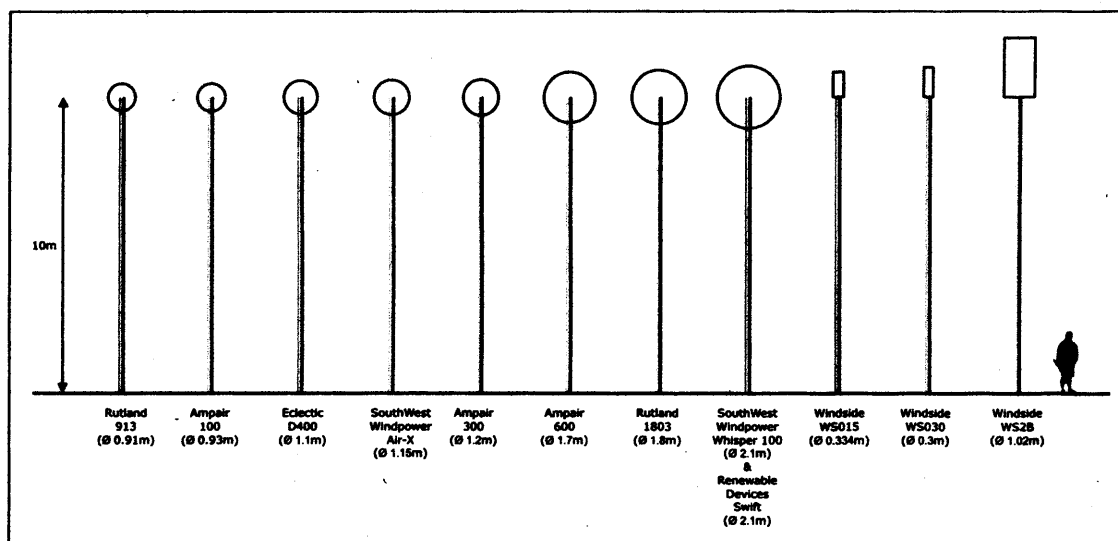

Figure 46: Visual size comparison of listed wind turbines

Power curves for these 12 no. wind turbines were compiled using Microsoft Excel from manufacturers' data. Web links to the original manufacturers' specifications and power curves are included in Appendix D. Figure 47 (overleaf) compares these power curves.

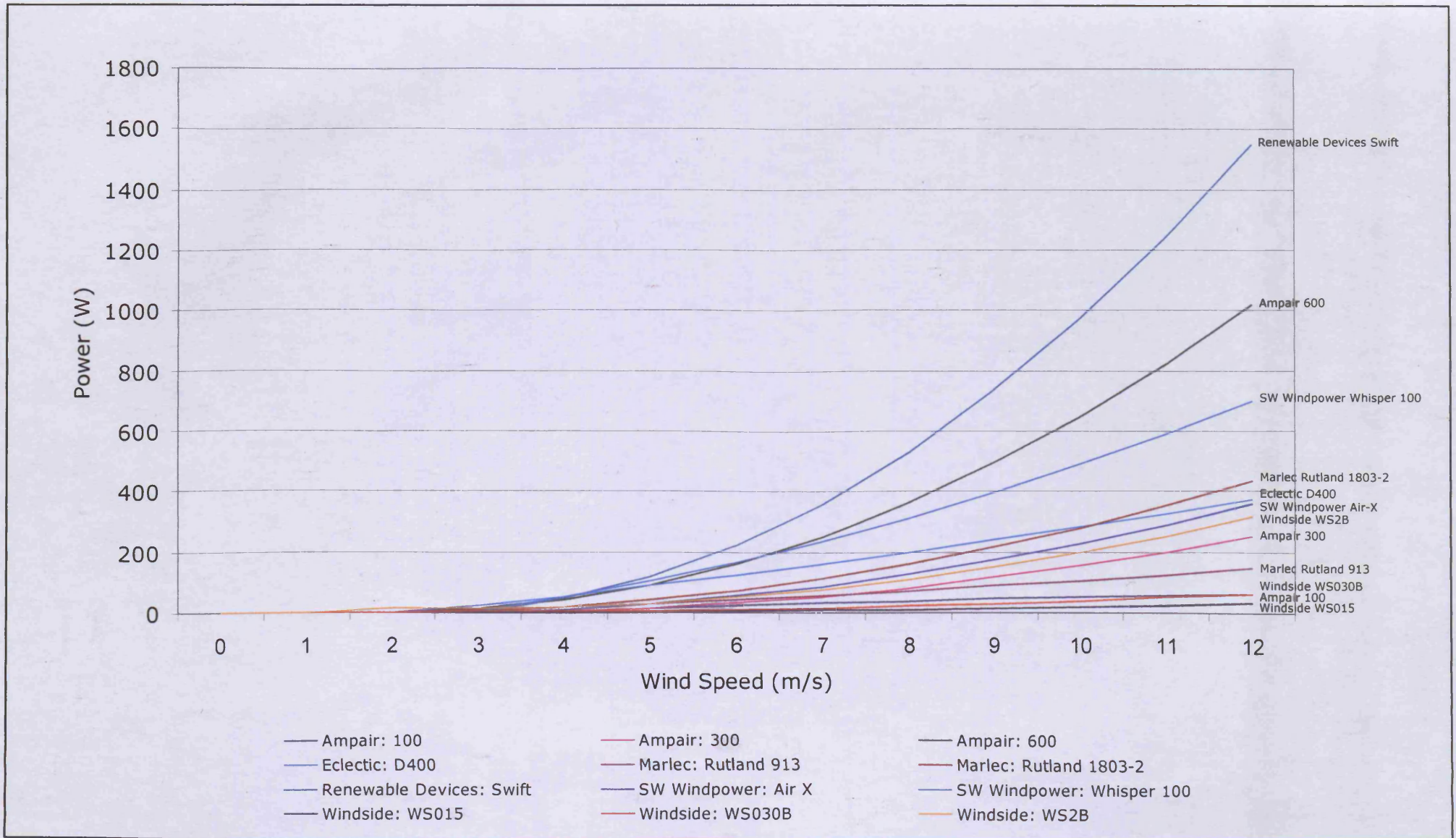

Figure 47: Power curves for 12 no. micro- and mini- wind turbines

4.5 Wind Trial Results

As has previously been stated, there is little empirical data from small wind turbines in the UK with which to compare turbines or to draw conclusions about locating them in urban environments. However, recently the results of 2 no. studies have been published that provide energy output data and some comparison with estimated yield. The studies and their outcomes are discussed in the following sections.

4.5.1 Warwick Wind Trials 2009

This study, conducted by Encraft, monitored the energy output from 26 no. building mounted small wind turbines at locations around the UK for the period 2007 - 2008²⁶². The turbine locations ranged from a low-rise building in an urban environment to a high-rise building on a hill top in a rural environment. A site located in a rural location, close to the sea on top of a hill with very little obstructions to air flow, was selected as a reference location for comparison with the other locations.

This report is of particular relevance as some of the turbines monitored by Encraft are the same models as those identified by this study to be appropriate for mounting on street lighting columns. Therefore the results may provide an indication of the energy outputs likely to be achieved. The key relevant findings are as follows:

- The average wind speed for each site was identified using the NOABL database and the percentage difference in output was calculated. Encraft reported that the wind speeds at 17 of the sites were >40% lower than those predicted by the NOABL database. From the NOABL data the yield was in some cases over-estimated by factors of 15 - 17.
- Using measured wind speed data the yield was over-estimated by a factor of between 1.7 and 3.4 because of inaccurate power curve data.
- While the Weibull k-value was close to 2 for the reference site, the derived k-values for 18 of the sites were <1.6 and the overall average across all the sites was 1.56.

²⁶² Brown, H., Hailes, D., Rhodes, M., *Warwick Wind Trials – Final Report*, Encraft, 2009

- The building mounted turbine that performed best in the trial generated an average of 2.382 kWh per day when in operation, equivalent to 869 kWh in a full year²⁶³. This turbine was an Ampair 600 mounted on a high-rise tower block.
- The poorest performing building mounted turbine generated an average of 41Wh per day when in operation or 15 kWh per year, (less than the energy it consumed to run the turbine's electronics)²⁶⁴. This turbine was also an Ampair 600, but located in an urban environment.
- The average capacity factor across all the sites was 0.85%. When adjusted for periods when the turbines were switched off due to failures or noise complaints the average capacity factor across all the sites was 4.15%. The range was 0.29% for an Ampair 600 turbine mounted on an industrial unit in an urban area to 16.54% for an Ampair 600 turbine mounted on a mast at the reference location²⁶⁵.

Of the turbines monitored in the Encraft study, both the Ampair 600 and the Eclectic D400 have been identified as potential turbines for the hybrid street light (section 4.4)²⁶⁶. The report found that the power curve data supplied by the manufacturers of these turbines was reasonably accurate at low wind speeds (≤ 6 m/s) but progressively less so at higher wind speeds (6 m/s – 12 m/s) and that this could lead to over-estimation of yield where higher wind speeds were present.

²⁶³ Brown, H., Hailes, D., Rhodes, M., *Warwick Wind Trials – Final Report*, Encraft, 2009, page 1

²⁶⁴ Brown, H., Hailes, D., Rhodes, M., *Warwick Wind Trials – Final Report*, Encraft, 2009, page 1

²⁶⁵ Brown, H., Hailes, D., Rhodes, M., *Warwick Wind Trials – Final Report*, Encraft, 2009, page 32

²⁶⁶ Windsave turbines are reportedly no longer available as of September 2009

4.5.2 EST - Location Location Location

This EST study, published in July 2009, monitored the energy output from 57 no. small wind turbines (38 no. building mounted and 19 no. mast mounted) located at sites around the UK²⁶⁷. Some of the turbines monitored were also monitored in the Warwick Wind Trials, so there is some overlap between the studies. Specific data from the EST study was withheld from publication and was not available to this study. However, from the report it can be seen that the mast mounted turbines produced about six times more electricity than those on rooftops. The key findings from this study were:

- The performance of building mounted turbines in urban and suburban locations was compromised by inadequate wind speeds.
- Mast mounted turbines located in an undisturbed wind resource (i.e. a rural location) performed well, some with capacity factors >30%.
- Turbines located in Scotland performed better than those in the rest of the UK, due to higher wind speeds and more elevated ground.
- The maximum capacity factor of any building mounted turbine in the trial was 7.4% for a turbine located in Scotland.
- Manufacturers' power curves have been calculated using different methods with some being inaccurate or incorrect. As such it was difficult to compare the performance of different turbines.
- The NOABL database significantly overestimated the wind speed in urban areas. Hence the EST now recommends that the NOABL is not used except for rural locations.
- The Carbon Trust tool (section 4.3.2) was found to give the best estimate of wind speeds at urban sites compared with monitored wind speed data at the same sites. Estimates were found to be "*broadly in agreement with in-situ measurements*"²⁶⁸.

However, given the results of the previous Encraft study and the lack of published data, the conclusions of this study may not be easily verifiable.

²⁶⁷ Energy Savings Trust, *Location, Location, Location - Domestic small-scale wind field trial report*, EST, July 2009

²⁶⁸ Energy Savings Trust, *Location, Location, Location - Domestic small-scale wind field trial report*, EST, July 2009, page 17

4.5.3 Summary of Field Trial Results

The published findings of the 2 small turbine field trials indicate that small turbines can operate well in favourable sites (i.e. open rural locations with few obstructions). However, in less favourable sites the performance can be so bad that the turbine itself becomes a net importer of electricity. Furthermore, the reports have indicated inadequacies in both wind speed estimation methods (i.e. the NOABL database) and in manufacturers' power curve data. The executive summary of the Encraft report draws the following conclusion from the results of the study:

"Overall the trial has painted a picture of an industry and technology that is still at development stage and is likely to make a tangible contribution to energy and carbon saving only on the most exposed sites and tallest buildings. The combination of this reality, aggressive and over-optimistic marketing by some suppliers, and the enthusiasm and credulity of the market (and regulators) has potentially led to an unfortunate outcome where the wind industry as a whole is in danger of suffering from a setback in credibility"²⁶⁹.

The reports have drawn criticism of the concept of small wind in urban areas, such as from Gipe, who responded to the results by stating that, "if further proof is needed that mounting wind turbines on rooftops is a bad idea, the final report on the Warwick Wind Trials is it"²⁷⁰ and described the results of the EST trial as "dismal"²⁷¹. Given the results of the studies, this criticism may be justified because the main aim of the turbines in each case was to export as much power as possible. However, in the case of a hybrid street lighting system it is only necessary for the turbine to achieve sufficient energy output to charge the battery store, as no power is exported. Therefore, provided that the turbine meets, or makes a significant contribution to charging the battery store, it is less important that it is working at its optimum performance.

²⁶⁹ Brown, H., Hailes, D. and Rhodes, M., *Warwick Wind Trials – Final Report*, Encraft, 2009, Page 2

²⁷⁰ Gipe, P., www.wind-works.org, 17th July, 2009 – Last accessed August 2009

²⁷¹ Paul Gipe, www.wind-works.org, 9th September, 2009 – Last accessed September 2009

4.6 Methods to Increase the Energy Yield from Wind Turbines

A method to potentially increase the energy output from wind turbines in urban locations, that has been the subject of some research interest in recent years, is ducting or concentrating the wind flow to increase the wind speed and hence the energy output. This involves placing an aerodynamic concentrator close to or around the turbine to increase the wind speed through the swept area²⁷². The Wind Energy for the Built environment (WEB) project primarily researched the potential for designing buildings to be more aerodynamically suited for wind turbine integration²⁷³. Some model designs were assessed through testing in outdoor conditions at the Energy Research Unit (ERU), Rutherford Appleton Laboratory. The main finding of this study was that the concentrators allowed the turbines tested to cut-in at wind speeds at least 1m/s less than their standalone cut-in speed. Furthermore, the "electrical power output of both turbines improved by a large ratio at low wind speeds and a lower ratio at high wind speeds"²⁷⁴. The concentrators were effective for both HAWTs and VAWTs. Figure 48 shows 2 no. concentrator designs under outdoor test conditions at ERU.



Figure 48: Wind concentrator designs assessed by the WEB project at ERU.

²⁷² Campbell et al, *Wind energy for the built environment (Project WEB)*, Proceedings of the European wind energy conference, Copenhagen, Denmark, July 2001

²⁷³ <http://www.eru.rl.ac.uk/web.htm> - last accessed June 2009

²⁷⁴ Campbell et al, *Wind energy for the built environment (Project WEB)*, Proceedings of the European wind energy conference, Copenhagen, Denmark, July 2001

²⁷⁵ <http://www.eru.rl.ac.uk/web.htm> - last accessed June 2009

Dannecker and Grant conducted wind tunnel tests of ducts (straight and curved, but without turbines) at incident angles of $\pm 60^\circ$. The findings were that speeds recorded in the duct were significantly more than that of the tunnel air stream over this range²⁷⁵. According to Grant, the main advantages of ducting are that it protects the turbine from extremes of building-generated turbulence and increases the available wind speed, while the main disadvantage is that the directional sensitivity of the turbine is reduced²⁷⁶. For building integrated wind turbines, Taylor developed the concept of 'aeolian concentrators'²⁷⁷, wing shaped structures that serve to modify the wind conditions at roof edges and provide accelerated flow to the turbine. Aguilo found, through CFD modelling that these devices may increase the wind speed available to the turbine by up to 60% compared with the undisturbed speed at the building height²⁷⁸.

Despite the fact that they are not commonly used in commercial applications²⁷⁹, there is clearly an advantage to be gained in terms of energy output from using aerodynamic ducting or concentrators to improve wind turbine performance in an urban environment, where low wind speeds may be prevalent. Importantly, by effectively modifying the micro-site of a turbine, these devices may allow a greater number of potential locations to be considered that would otherwise offer too poor a resource. In the light of this research, the potential of using ducts or concentrators with street light mounted wind turbines was discussed with both Bryan Geeves at Cardiff Council and with Philip Marques of CU Phosco (column manufacturer). However, they were not considered to be feasible on aesthetic and cost grounds at the present time, being considered to be both too physically bulky and potentially too costly for this application. Further work could examine the design of these devices to establish whether a smaller and more aesthetically acceptable solution would be viable.

²⁷⁵ Dannecker R.K.W., Grant, A.D., *Investigations of a building-integrated ducted wind turbine module*, Wind Energy, May 2002, pages 53-71

²⁷⁶ Grant et al, *Urban wind energy conversion: The potential of ducted turbines*, Renewable Energy, Volume 33, 2008, pages 1157 - 1163

²⁷⁷ Dayan, E., *Small scale, building integrated, wind power systems*, IP12/05, BRE, September 2005

²⁷⁸ Aguilo, A. et al, *Computational Fluid Dynamic Modelling of wind speed enhancement through a building augmented wind concentration system*, Proceedings of the European wind energy conference & exhibition, London, 22-25 November 2004

²⁷⁹ Twidell, J. A., Wier, A.D., *Renewable Energy Resources (2nd edition)*, Taylor & Francis, 2006, p.273

4.7 Summary

Research to date has demonstrated that small wind turbines can generate useful power and operate at a reasonable capacity factor given good site conditions (smooth, open rural areas with few obstructions). The urban environment is much less understood and what little empirical evidence exists for building mounted turbines suggests that the performance of small wind turbines is significantly compromised by the wind regime in urban areas. Energy output may be improved by employing ducting or concentrating devices, although these may not be acceptable for street lighting columns on aesthetic grounds.

9 no. HAWT and 3 no. VAWT small wind turbines have been identified that are available in the UK and are of a suitable physical size and power rating to be considered as components for the hybrid street lighting system. These turbines have cut-in speeds ranging from 2 m/s to 3.58 m/s, suggesting that they will generate some power in urban areas, based on mean wind speeds reported in existing research and from prediction tools. However, this assumes that the power curve data provided by turbine manufacturers is accurate, and studies have indicated that this may not always be the case.

There is general agreement between the existing siting guidance for small wind turbines. On the whole the guidance advises against locating small turbines in urban environments in preference to open rural locations. Where this is unavoidable, some of the guidance allows a simple analysis of urban areas by suggesting areas with a higher potential wind resource. Furthermore, some of the guidance may be relevant to hybrid street lighting, such as assessing the site for prevailing wind, however, some of the guidance relates to areas where street lighting would not be permitted under the lighting standards or would be impractical, such as on building roofs.

Simple numerical prediction tools exist that may allow a site assessment to be made, however, there is currently little comparison of these tools with measured site data. Furthermore, the most comprehensive of these tools is limited to a wind data resolution of 1km² and does not account for detailed urban geometry. Therefore a comparison between various locations in close proximity in an urban environment is not possible using these methods.

***"There are open spaces in every urban centre
where small wind turbines may be appropriate"***²⁸⁰

Paul Gipe, California, 1999

CHAPTER 5 - CASE STUDY

5.0 Introduction

In order to assess the wind resource available in an urban environment, monitoring wind speed and direction data at a site for proportion of the year was considered to be the most effective method based on the findings of the literature review. This would avoid the potential problems identified with using either average annual wind speed data or general area data, which may not accurately represent the site. As a city, Cardiff was considered to be an appropriate example of an urban location for this study. Reasons for selecting the specific case study location are discussed in this chapter.

This chapter defines the concept of 'urban area' and its applicability to Cardiff. The general topography of Cardiff is described, along with the case study location selection criteria, site survey results, physical model and street lighting requirements. Wind data from selected sources is compared for the case study location and the monitoring and modelling procedures used for the study are described.

The project funding allowed for the purchase of 3 no. sets of wind speed and direction sensors. Hence it was possible to collect data from 3 locations in the case study urban environment. In addition to the equipment funded by the Technology Transfer Initiative (TTI) programme, data loggers and pyranometers were provided by the Welsh School of Architecture. The equipment used is described in detail in this chapter. Wind tunnel modelling was selected as the modelling method for this study due both to the availability of a suitable BLWT and the greater potential accuracy associated with this method identified in the literature review.

²⁸⁰ Gipe, P., *Wind Energy Basics*, Chelsea Green Publishing, 1999, page 75

5.1 Definition of 'Urban Area' and Applicability to the Case Study Location

As this study concerns the urban wind regime, it is first necessary to define what constitutes an 'urban area'. The Government report 'Key Urban Statistics 2001', published by the Office for National Statistics (ONS), explains how an urban environment has traditionally been defined:

"The traditional concept of a town or city would be a free-standing built-up area with a sufficient number and variety of shops and services, including perhaps a market, to make it recognisably urban in character. It might have administrative, commercial, educational, entertainment and other social and civic functions, and, in many cases, have evidence of being historically well established. It would be a focus of a local network of transport, often a location for industries, and a place of employment for people from surrounding areas. It would be a place known beyond its immediate vicinity"²⁸¹.

The report notes that the situation in the UK is now more complex, with previously free-standing towns now linked by continuous development, the development of business and retail parks in the countryside, the decline of some historic towns with a loss of urban functions and the rise of new residential settlements lacking the traditional range of urban functions. The report also suggests that it is not possible to define the urban environment by administrative areas because the new unitary authorities introduced in Wales in the 1990's *"continued the mix of town and countryside"*²⁸².

Instead the report suggests that urbanisation may be better defined in terms of 'built up area' (bricks and mortar) or by 'density'. It goes on to define an urban area as follows:

*"An urban area is an extent of at least 20 hectares [0.2km²] and at least 1,500 residents at the time of the 2001 Census. Separate areas are linked if less than 200 metres apart"*²⁸³.

²⁸¹ Office for National Statistics, *Key Statistics for Urban Areas in England & Wales*, TSO, 2001, page 1

²⁸² Office for National Statistics, *Key Statistics for Urban Areas in England & Wales*, TSO, 2001, page 1

²⁸³ Office for National Statistics, *Key Statistics for Urban Areas in England & Wales*, TSO, 2001, page 2

Cardiff Council describes the city of Cardiff as having a 'city centre' element of approximately 7km², with a further surrounding urban area of approximately 140km². In recent years Cardiff has been one of fastest growing cities in the UK. The Research Centre of the Council published the report 'Cardiff Population Trends 1989 - 2004'²⁸⁴, which suggested that over this period the population of Cardiff had increased by 6.9% compared with 3.2% for Wales as a whole and 4.9% for the UK as a whole. The most recent estimate of the population (the 2007 mid-year estimate published by the Office for National Statistics) is 321,000. Therefore Cardiff can correctly be described as an urban area. Further implications of this growth are that the requirement of the city for street lighting will be increased and as new development occurs it is likely that new street lighting will be specified and installed.

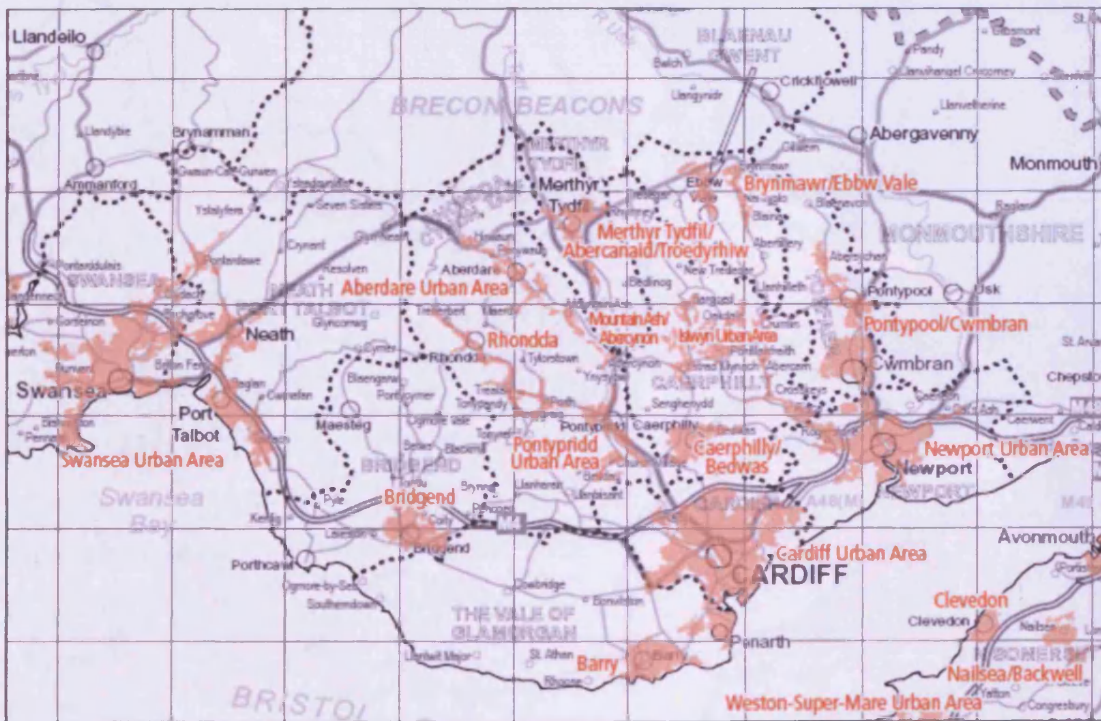

Figure 49: Cardiff urban area in the context of south Wales

5.2 Topography of Cardiff

The following 3 no. landscape pages (figures 50, 51 and 52) illustrate the topography, urban area and context of the case study location within the city.

²⁸⁴ The Research Centre, *Cardiff Population Trends 1989 - 2004*, Cardiff Council, page

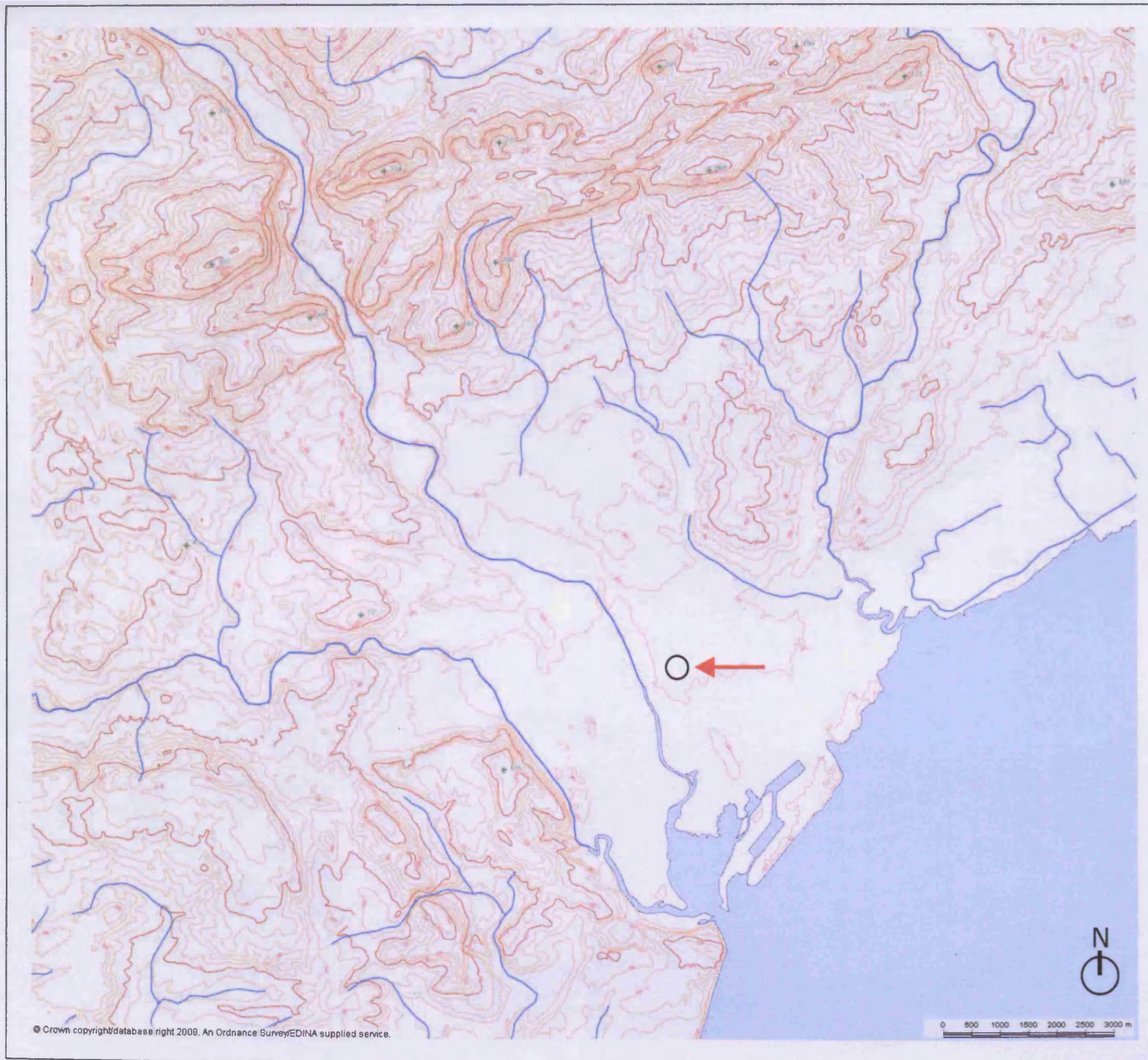

Figure 50: Cardiff Map - Contours

The case study location is indicated.

This contour map illustrates that the city centre is relatively flat, mostly between 0m and 10m above sea level. The case study location is 10m above sea level in a largely flat area of the city.

The city is bordered to the north by hills of a maximum height of 307m and to the west by hills of a maximum height of 115m. To the east is a largely flat floodplain area and to the south is the Bristol Channel (a tidal watercourse).

Map source: OS (Edina Digimap)

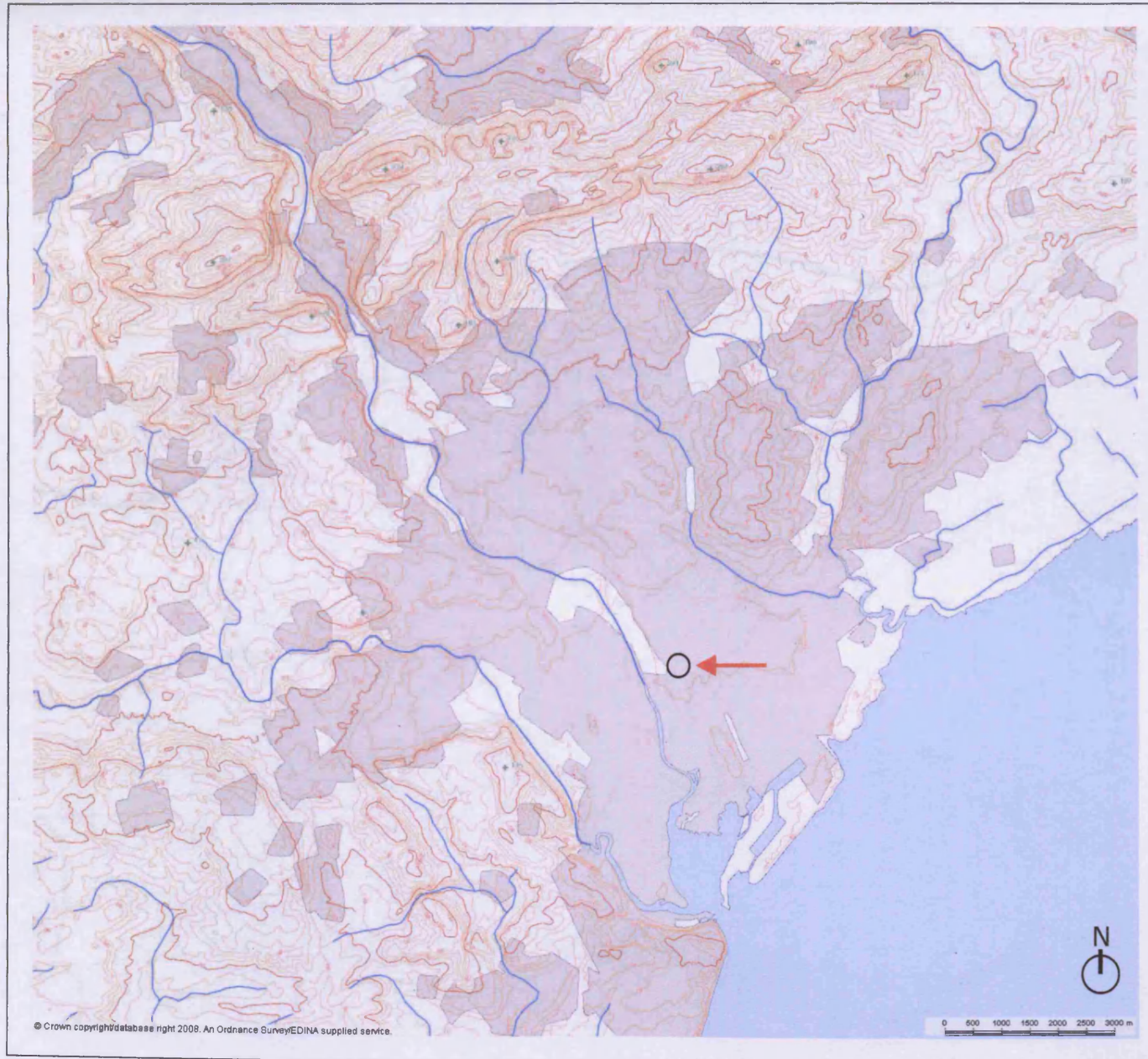

Figure 51: Cardiff Map - Urban Area

The case study location is indicated.

This map shows the extent of Cardiff urban area. The case study location is in a dense mixed use area in the centre of the city with mainly 2 - 3 storey suburbs extending to the north, east and west. The large open area directly to the west of the case study location is Bute Park.

Map source: OS (Edina Digimap)

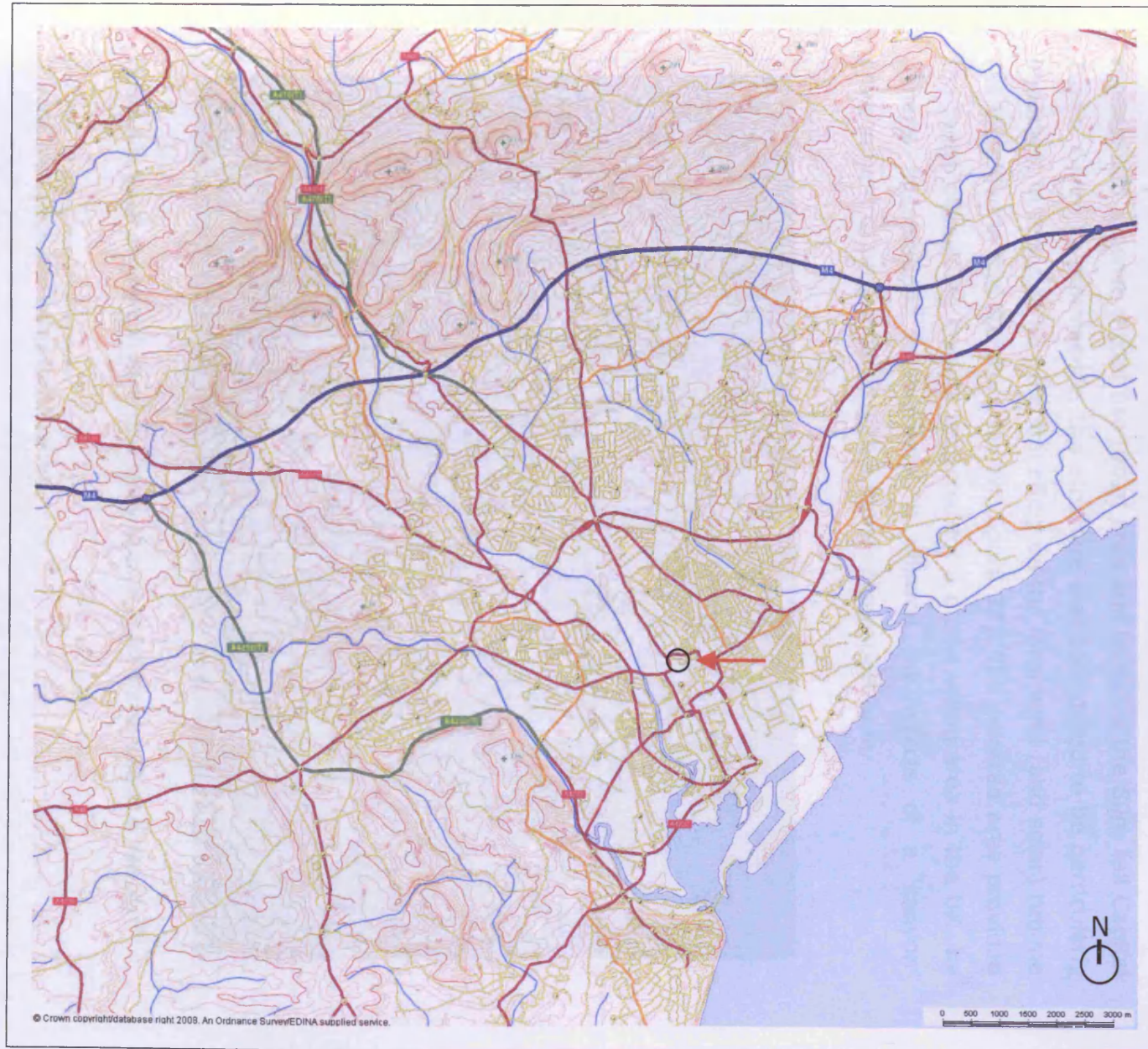

Figure 52: Cardiff Map - Roads

The case study location is indicated.

The purpose of this map is to illustrate where the case study location lies within the wider road network of the city.

Map source: OS (Edina Digimap)

5.2 Selection of the Case Study Location

The reasons for selecting Cardiff city centre as the case study location for this study can be summarised as follows:

- It was considered to be representative of other urban areas in the UK.
- A reliable source of climate data was available close to the site.
- Data monitoring was permitted by Cardiff Council.
- The local authority agreed to provide access and labour for data collection.

The specific area to be studied ($51^{\circ}28'N$, $03^{\circ}10'W$) was selected because it represented a dense mixed use urban area and included the 80m tall Capital Tower. Given its prominence, this structure was considered to be particularly important in terms of its potential effect on the local wind (and solar) regime (as identified in the literature review, figure 32). The selected area provided the range of building heights expected for a dense urban area in the UK, by general observation. Furthermore, it allowed the effects of a 'canyon' environment to be compared with a more open aspect area.



Figure 53: Aerial photograph show case study location in the wider context of the city²⁸⁵

²⁸⁵ Aerial photograph supplied by Cardiff Council

5.2.1 Site Survey

A site plan was obtained from Ordnance Survey (OS) data that shows the building footprints, street layout (including pavement areas) and other street features. Figure 54 shows a simplified site plan with irrelevant detail removed and figure 55 shows an aerial photograph of the site for comparison.

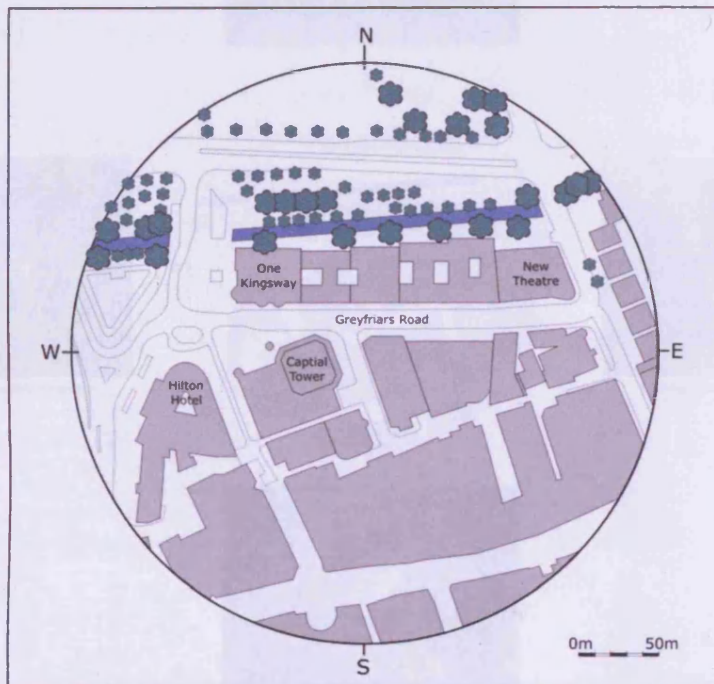

Figure 54: Site plan of case study location



Figure 55: Aerial photograph of site showing perimeter of case study area²⁸⁶

²⁸⁶ Aerial photograph supplied by Cardiff Council

Photographs of the site from different points are shown in figures 56 and 57.



Figure 56: Site photographs from various orientations



Figure 57: Views of Greyfriars Road looking East and West

Cardiff Council could not provide building height data at the time of the study, although a company was identified that could supply building heights based on aerial photography and LiDAR data (GeoInformation Group²⁸⁷). However, the cost of these data was prohibitively expensive for this study. Therefore, a detailed site survey was carried out whereby all the buildings within the site perimeter were photographed and externally surveyed.

An initial estimate of building heights was made by recording the number of storeys of each building and multiplying by the measured height of the first storey. These heights were then checked using a Leica Disto Classic 5 laser distance meter using the triangulation function (accurate to +/- 3mm in 200m). Street widths and point distances were also checked using this instrument. The height of trees was estimated by comparison with nearby objects (buildings and street lighting columns) and, where possible, the spread was measured using the rangefinder. The survey data were used to construct a 1:200 scale physical model of the site. Figure 58 (overleaf) shows the site plan with building heights and street elevations for the Greyfriars Road area and indicates the average canopy height for buildings on each side of the street.

With reference to figure 58, the overall average canopy height for both sides of the Greyfriars Road was determined to be 17.5m to the nearest 0.5m. The length of the 'canyon' zone of Greyfriars Road (from the eastern edge of One Kingsway to the eastern edge of the New Theatre) is 170m. For the majority of this length, the width, measured from the face of opposing building facades, varies between 20m and 25m giving an average width of 22.5m. Using the Oke method (figure 30, Chapter 3) this gives a H/W ratio of 0.78 and a L/H ratio of 9.7. Assuming the conditions described by Oke²⁸⁸ this would indicate that the flow regime in the case study location is on the boundary between a wake interference flow and a skimming flow.

²⁸⁷ <http://www.citiesrevealed.com> – last accessed July 2009

²⁸⁸ Oke, T.R., *Street design and urban canopy layer climate*, Energy and Buildings, Volume 11, 1988, pages 103-113

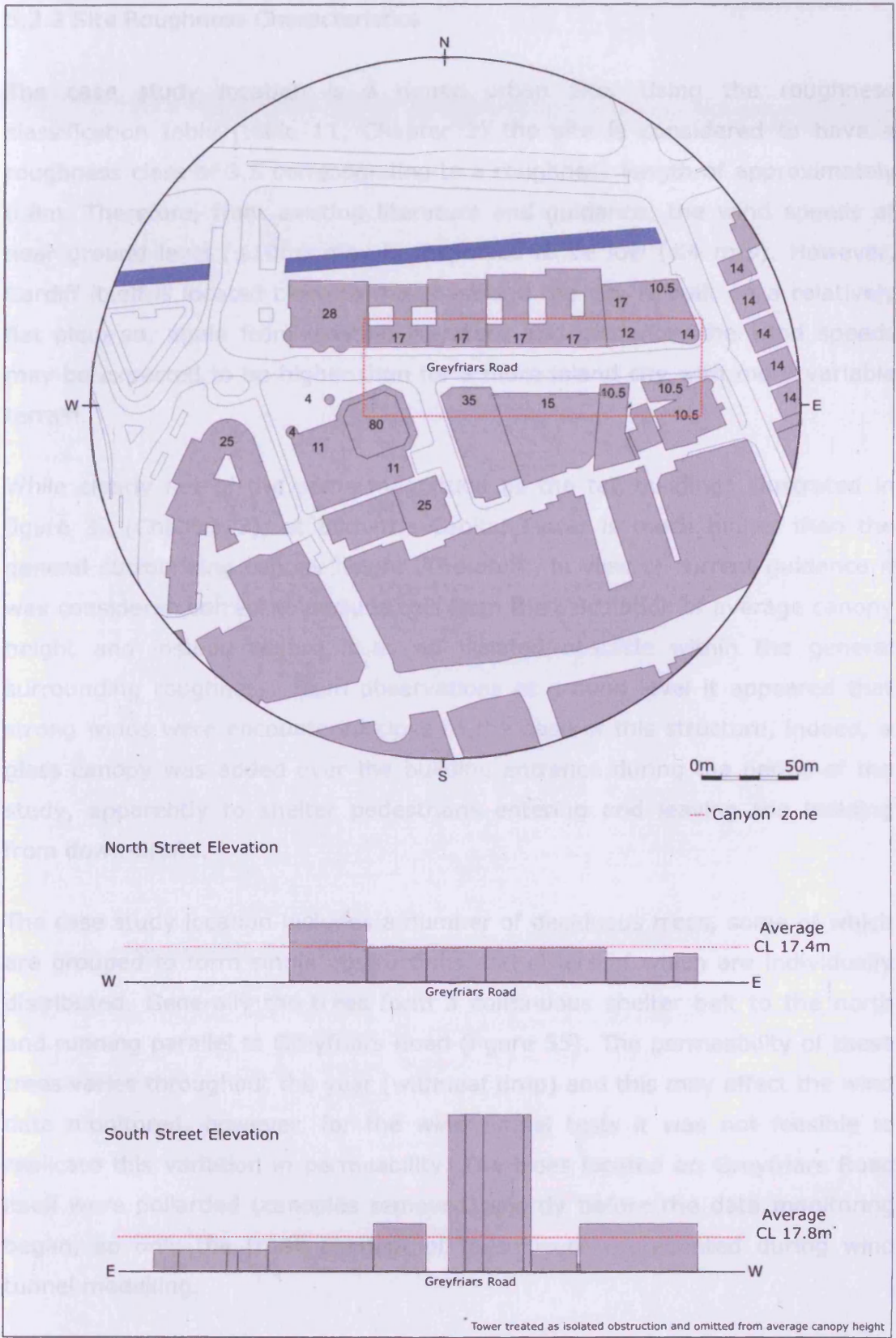

Figure 58: Building heights and street elevations (Greyfriars Road)

5.2.2 Site Roughness Characteristics

The case study location is a dense urban site. Using the roughness classification table (table 11, Chapter 3) the site is considered to have a roughness class of 3.5 corresponding to a roughness length of approximately 0.8m. Therefore, from existing literature and guidance, the wind speeds at near ground level ($\leq 10\text{m}$) may be expected to be low ($\leq 4\text{ m/s}$). However, Cardiff itself is located close to the coast and the city is built on a relatively flat plain so, again from existing literature and guidance, the wind speeds may be expected to be higher than for a more inland city with more variable terrain.

While clearly not of the same magnitude as the tall buildings illustrated in figure 32 (Chapter 3), at 80m the Capital Tower is much higher than the general surrounding canopy height. Therefore, in view of current guidance it was considered correct to exclude this from the calculation of average canopy height and instead regard it as an isolated obstacle within the general surrounding roughness. From observations at ground level it appeared that strong winds were encountered close to the base of this structure, indeed, a glass canopy was added over the building entrance during the period of the study, apparently to shelter pedestrians entering and leaving the building from down-drafts.

The case study location includes a number of deciduous trees, some of which are grouped to form single obstructions and others of which are individually distributed. Generally the trees form a continuous shelter belt to the north and running parallel to Greyfriars Road (figure 55). The permeability of these trees varies throughout the year (with leaf drop) and this may affect the wind data monitored, however, for the wind tunnel tests it was not feasible to replicate this variation in permeability. The trees located on Greyfriars Road itself were pollarded (canopies removed) shortly before the data monitoring began, so only the trunk element of these were represented during wind tunnel modelling.

5.2.3 Street Lighting at the Case Study Location

As stated in Chapter 2, there are currently approximately 35,000 street lighting columns in Cardiff. An on-going program of improvements has resulted in the replacement of approximately 800 columns per year in recent years²⁸⁹. There were 2 no. types of street lighting column present at the case study location at the time of the study, an older type of concrete column manufactured by CU Phosco and a newer (replacement) steel type manufactured by Urbis. Figure 59 shows these column types together with the actual street lighting column locations at the time of the study.

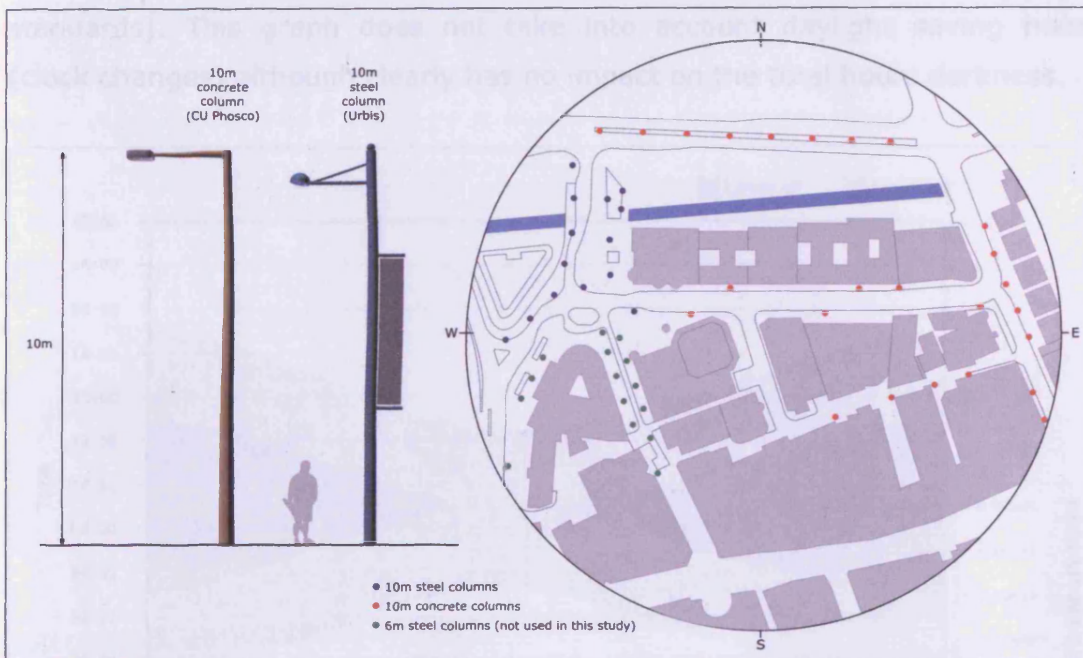

Figure 59: Street light column types and locations for case study site

The 10m steel street lighting columns had an integrated fabric banner attachment (shown as a vertical grey strip in figure 59). The effect of potential wind disturbance caused by the banner was not modelled and an assumption was made that this banner did not have any effect on the wind data collected at the top of the column.

²⁸⁹ Figures from Cardiff City Council Street Lighting Office, July 2009

5.2.4 Hours of Darkness - Cardiff

The day length (hours of daylight and hours of darkness) varies according to geographical location. The hours of darkness for Cardiff, based on sunset and sunrise times are shown in figure 60. From this graph it can be seen that the lowest number of hours of darkness occur on 21st June (7 hours, 22 minutes) while the highest number of hours of darkness occur on 21st December (16 hours, 10 minutes). The hybrid wind / PV street light described in Chapter 2 is designed to provide 8 hours lighting with 3 days autonomy. The hours when the lamps will be on are also indicated on the graph (assuming 4 hours after sunset and 4 hours before sunrise, to exceed the current minimum lighting standards). This graph does not take into account daylight saving hours (clock changes) although clearly has no impact on the total hours darkness.

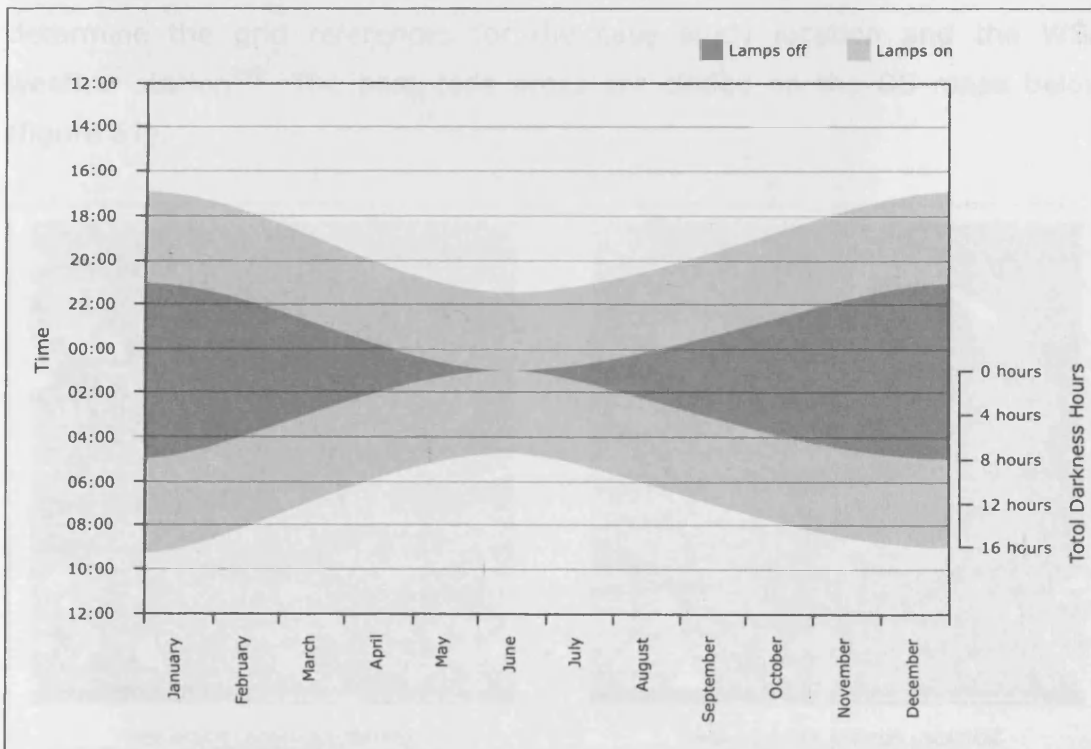

Figure 60: Hours of darkness over a year for Cardiff showing 8 hour lighting regime

5.3 Comparison of Wind Data Available for the Case Study Location

In this section, sources of published data for the case study location are compared together with the results from wind estimation tools that can provide a prediction of average annual wind speed. A number of data sources are available that can provide the minimum data required, i.e. an average annual wind speed, for the site or the general area of the site. The data available ranges from general area data based on long term averages to specific high resolution data close to the site.

The case study location ($51^{\circ}21'00''N$, $3^{\circ}10'42''W$) and the location of the WSA weather station ($51^{\circ}21'11''N$, $3^{\circ}10'56''W$) are within 500m of each other, although they are in different post code areas (relevant for the estimation tools discussed). The Ordnance Survey (OS) mapping service was used to determine the grid references for the case study location and the WSA weather station²⁹⁰. The post code areas are circled on the OS maps below (figure 61).

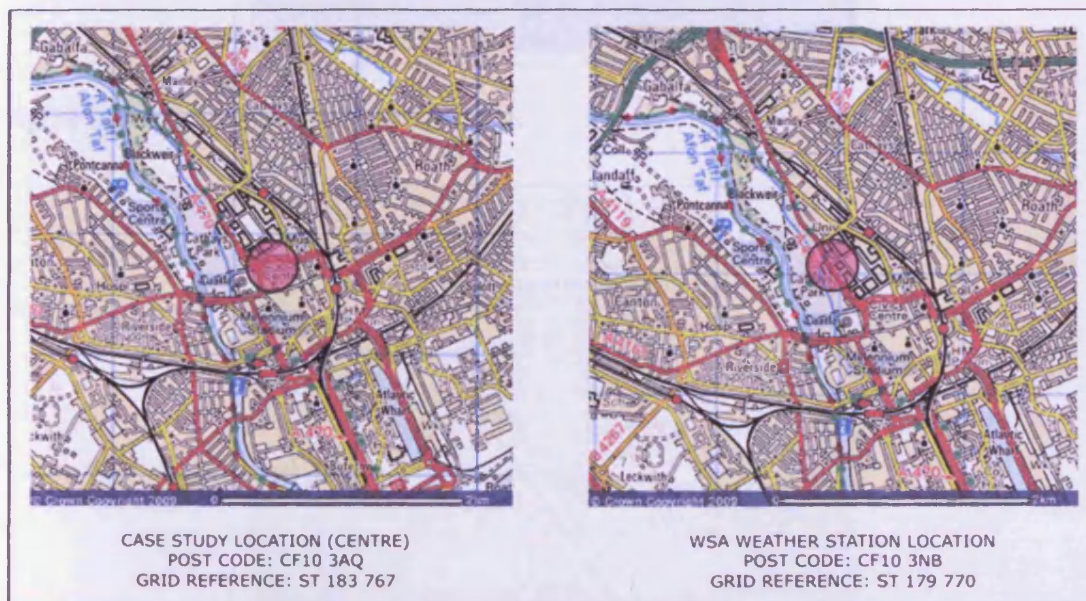

Figure 61: Post code and grid references for case study location and WSA from OS data

²⁹⁰ <http://www.ordnancesurvey.co.uk/oswebsite/getamap> - last accessed August 2009

5.3.1 WSA Weather Station

The WSA weather station (figure 62) is located approximately 500m from the case study location (figure 63) and records wind speed and direction data. The wind speed and direction sensors used by the station are of the same model used for monitoring the case study location (specifications provided in Appendix F2 & F3). The anemometer and wind vane are mounted on an 8m mast on the flat roof of the Bute building away from neighbouring obstructions. The total elevation of the sensors above ground level is 27m.



Figure 62: The WSA weather station²⁹¹

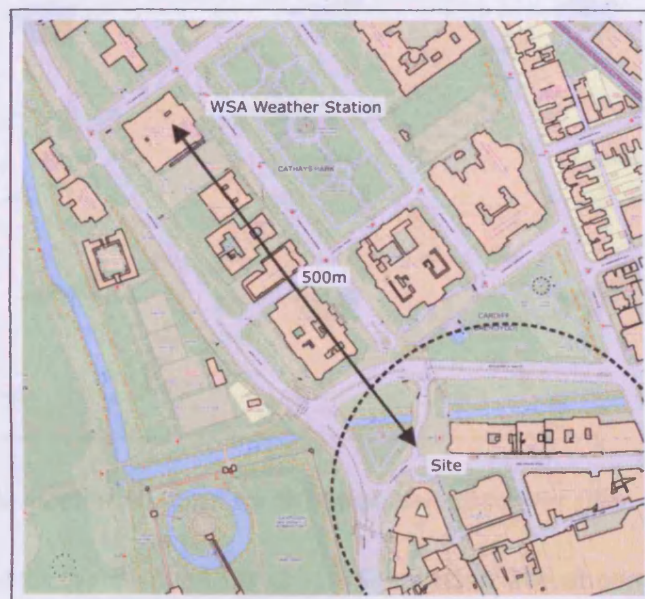

Figure 63: Location of WSA weather station in relation to the case study location

²⁹¹ Photograph provided by Janice Coyle, WSA.

The monthly mean wind speeds reported by the WSA weather station, concurrent with the monitoring period, are shown in table 18.

Jan	Feb	Mar	Apr	May	Jun	Jul	Aug	Sep	Oct	Nov	Dec	Mean
n/a	n/a	3.52	3.80	3.41	3.02	2.86	2.78	2.14	3.50	3.25	3.45	3.16

Table 18: Monthly mean wind speeds for WSA weather station

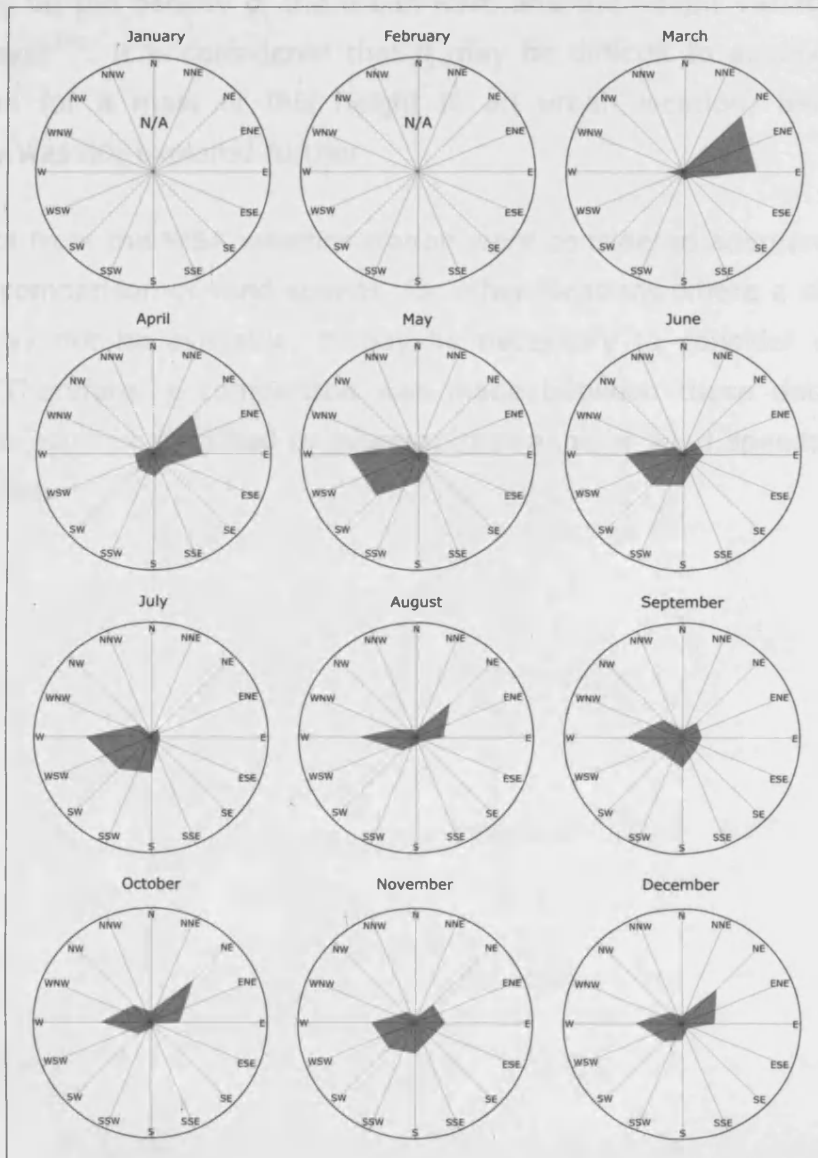

Figure 64: Monthly mean wind roses for WSA weather station for (Mar - Dec 2003)

The monthly mean wind roses for the WSA station are shown in figure 64 and display a prevailing W wind direction with a strong secondary NE direction.

This data source was selected for the case study because it was the closest source of data to the site and the data provided was both high quality and high resolution. However, for future work, Oke recommends that wind sensors in the urban environment should be mounted on a tall mast above the level at which individual buildings have an effect on the wind regime. This height is estimated to be between 1.5 and 5 times the mean building height, depending on the density of the urban form and the height variations of the canopy layer²⁹². It is considered that it may be difficult to achieve planning permission for a mast of this height in an urban location, although this possibility was not explored further.

While data from the WSA weather station were considered adequate to make a simple comparison of wind speeds, for other locations where a similar data source may not be available, it may be necessary to consider other data sources. Therefore, a comparison was made between these data and the other data sources identified to examine the range of wind speeds predicted at both sites.

²⁹² Oke, T.R., *Initial Guidance to Obtain Representative Meteorological Observations at Urban Sites*, IOM Report No.81, World Meteorological Organization, Geneva (2006)

5.3.2 Met Office

The Met Office has a weather station located in Bute Park, adjacent to the case study location. The station elevation is 9m and the mast height is 10m²⁹³. Whilst it may have been potentially useful to compare data from this station with the study data, unfortunately, specific wind speed and direction data from the Cardiff station were not available at the time of the study. Similarly the Met Office NCIC database described in section 3.3.1 (Chapter 3), that has wind speed data for the general Cardiff area, was not available to this study, however, it forms the basis of a wind speed estimation tool, developed by the Met Office in conjunction with the Carbon Trust. This tool was available to the study and is discussed further in section 5.3.7.

5.3.3 NOABL Database

The NOABL database can be accessed from the BWEA website²⁹⁴. Locations are defined by grid reference. The data for the relevant 1km² grid square for each location is shown in bold with the surrounding 1km² grid squares for comparison (table 19).

Annual Mean Wind Speed (m/s)					
Case Study Location: ST183767			WSA Location: ST179770		
5.7	4.7	4.6	4.4	4.4	4.7
5.7	5.2	4.5	4.4	4.2	4.7
6.0	5.3	4.7	4.6	4.3	4.3

Table 19: NOABL results for case study location and WSA location at 10m height

The results are curious because the distance between the locations is under 500m (0.5km). This should mean that the locations are either both in the same 1km grid square or in adjacent 1km grid squares. However, the data does not match either of these scenarios. Therefore, this may suggest an error in the way that grid squares are referenced in the database.

²⁹³ Information from World Meteorological Organisation - www.wmo.int - last accessed May 2009

²⁹⁴ <http://www.bwea.com/noabl/index.html> - last accessed August 2009

5.3.4 Windfinder (Cardiff Airport)

Windfinder published the following mean wind speed data, as well as wind direction data, from the Cardiff Airport weather station, concurrent with and overlapping the monitoring period. The Cardiff Airport weather station is described in section 3.3.4.

Jan	Feb	Mar	Apr	May	Jun	Jul	Aug	Sep	Oct	Nov	Dec	Mean
5.60	5.07	4.32	4.54	4.62	3.81	3.90	3.82	3.02	5.15	5.04	5.22	4.51

Table 20: Monthly mean wind speed data for Cardiff Airport

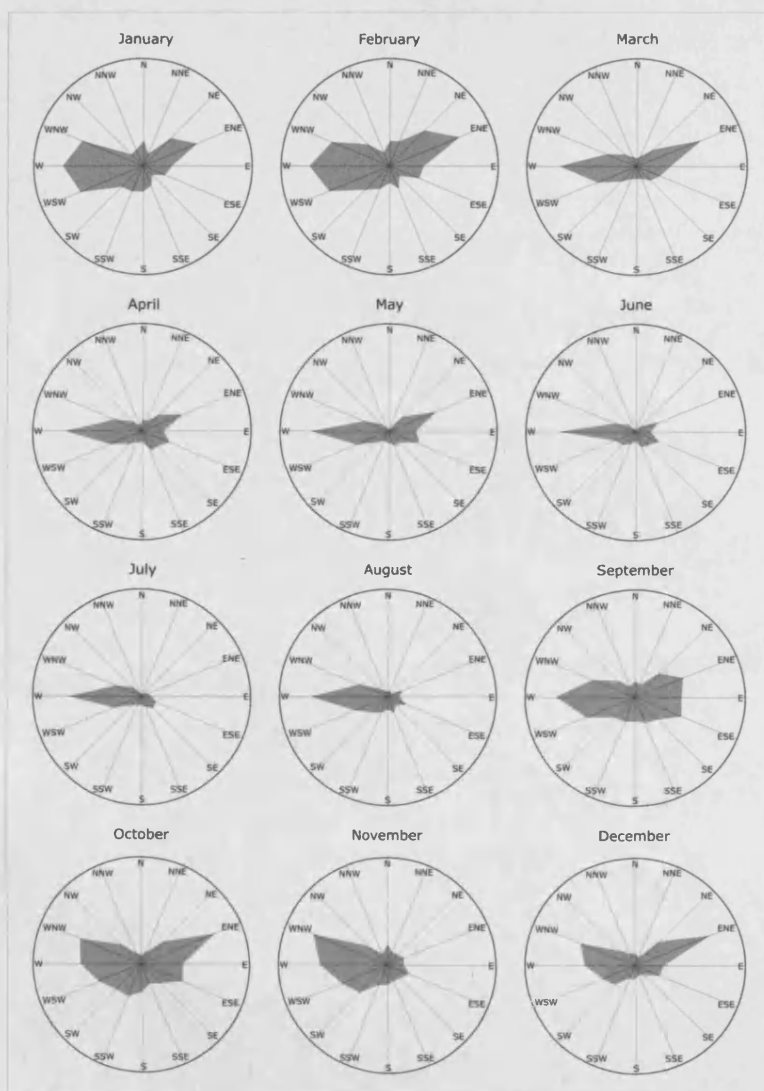

Figure 65: Mean wind direction frequency roses for Cardiff Airport

The mean wind direction roses for the Cardiff Airport location show a prevailing W wind direction with a strong secondary ENE wind direction.

5.3.5 Data from Cardiff University monitoring at Tal-y-bont

Celik reported monthly mean wind speed data for a 12 month period for 4 years, from a Cardiff University anemometer located on a 10m mast at Tal-y-bont (in park land approximately 2km NW of the case study location)²⁹⁵. The monthly averages are derived from hourly averages that are in turn based on values recorded every 10s and averaged over 5 minutes.

	Jan	Feb	Mar	Apr	May	Jun	Jul	Aug	Sep	Oct	Nov	Dec	Mean
1991	3.12	1.70	3.12	3.77	2.73	3.07	2.71	2.49	2.65	2.59	2.71	3.03	2.89
1994	3.36	2.47	4.07	3.29	2.45	3.24	2.26	2.41	1.94	2.17	1.99	4.10	2.81
1995	3.31	3.27	3.12	2.68	2.10	2.59	2.69	2.18	2.33	2.01	1.82	2.18	2.52
1996	3.29	2.68	2.31	2.22	2.42	2.33	2.48	1.92	2.18	2.36	2.48	2.39	2.42
4 year average:													2.66

Table 21: Monthly mean wind speeds reported by Celik for Tal-y-bont, Cardiff

5.3.6 Energy Savings Trust - Wind Yield Estimation Tool

The internet-based EST estimation tool applies an adjustment factor to data from the NOABL database to account for surface roughness variation²⁹⁶. However, the specifics of this method are not reported on the website or in related documentation²⁹⁷. The results of the EST estimation tool for the location postcodes (table 22) are similar to the NOABL data (table 19) in that they show a higher value for the case study location compared with the WSA location. However, overall the values are significantly lower.

Type of Area	Annual Mean Wind Speed (m/s)	
	Case Study - CF10 3AQ	WSA (Bute) – CF10 3NB
Urban	2.50	2.40
Sub-urban	2.99	2.87
Rural	4.61	4.42

Table 22: EST wind yield tool results for case study location and WSA location at 10m

²⁹⁵ Celik, A.N., *Energy output estimation for small-scale wind power generators using Weibull-representative wind data*, Journal of Wind Engineering and Industrial Aerodynamics, Volume 91, 2003, pages 693–707

²⁹⁶ <http://www.energysavingtrust.org.uk/Generate-your-own-energy/Can-I-generate-electricity-from-the-wind-at-my-home> – last accessed August 2009

²⁹⁷ Energy Savings Trust, *Location, Location, Location - Domestic small-scale wind field trial report*, EST, July 2009

5.3.7 Carbon Trust Wind Yield Estimation Tool

The Carbon Trust Wind Yield Estimator is intended to "help users estimate long-term annual mean wind speeds, energy yields of small wind turbines (below 50kW installed capacity) and carbon savings due to these yields"²⁹⁸. The tool allows the user to input the location (by post code), the site character and average canopy height, and the Weibull shape. Table 23 shows the results produced by the tool for the case study location and the WSA location for the default values. The Weibull shape (k) of 1.8 is that recommended for the UK by the Met Office (section 4.1.6).

Site Character	Default Canopy Height	Default Weibull Shape (k)	Annual Mean Wind Speed (m/s)			
			Case Study Location CF10 3AQ	Calculated Weibull Scale (A)	WSA Location CF10 3NB	Calculated Weibull Scale (A)
Open countryside	0m	1.8	3.5	3.8981	3.3	3.6667
Woodland	19.5m	1.8	0.2	0.2732	0.2	0.2497
Low height and density, residential	6m	1.8	2.9	3.2537	2.7	3.0908
Low height and density, industrial	6m	1.8	2.9	3.2537	2.7	3.0908
Medium height and density, residential	9m	1.8	2.3	2.6122	2.1	2.4115
Medium height and density, industrial	9m	1.8	2.3	2.6122	2.1	2.4115
High height and density	12m	1.8	1.2	1.4015	1.1	1.2216
Very high height and density, cityscape	25m	1.8	0.5	0.5110	0.4	0.4723

Table 23: Carbon Trust Estimator results for case study location and WSA location at 10m

The tool also allows the characteristics of a wind turbine (hub height and power curve) to be defined and provides an estimate of the annual energy yield based on the predicted wind regime. Of the estimation tools available, this was considered to be the most comprehensive and results from this tool provide the basis of the comparison with measured site data presented in Chapter 6.

²⁹⁸ <http://www.carbontrust.co.uk/windpowerestimator/WindPowerEstimator.aspx>
- last accessed August 2009

5.3.8 Summary of Wind Data Sources

The mean wind speed data identified for Cardiff area is shown in table 24.

Mean Wind Speed		
Data Source	<i>Measured Cardiff Area Data</i>	
Windfinder (Cardiff Airport)	4.51 m/s at 10m	
<i>Measured Locale Specific Data</i>		
WSA Weather Station	3.16 m/s at 27m	
Met Office (Cardiff)	N/A	
Celik Average (Tal-y-bont)	2.66 m/s at 10m	
<i>Estimated Annual Mean Wind Speed for Locations</i>		
Data Source	Case Study Location	WSA Location
NOABL Database	5.2 m/s for 10m	4.2 m/s for 10m
NCIC Database	N/A	N/A
EST	2.5 m/s for 10m	2.4 m/s for 10m
Carbon Trust (High H+D)	1.2 m/s for 10m	1.1 m/s for 10m
Carbon Trust (Very High H+D)	0.5 m/s for 10m	0.4 m/s for 10m

Table 24: Comparison of available mean wind speed data for Cardiff

The estimations of annual mean wind speed for the case study location and the WSA location all agree that the case study location has a higher annual mean wind speed than the WSA location. This may be because the source data is the same for the 3 no. models although this is speculation in the case of the EST model as the calculation method was not stated. A 10m height was selected for both locations for the estimated wind speeds to allow a direct comparison. For the results and data analysis presented in Chapter 6, the height selected for the WSA location is modified to reflect the height at which the data were measured (27m).

Figure 66 compares the range of annual mean wind speeds.

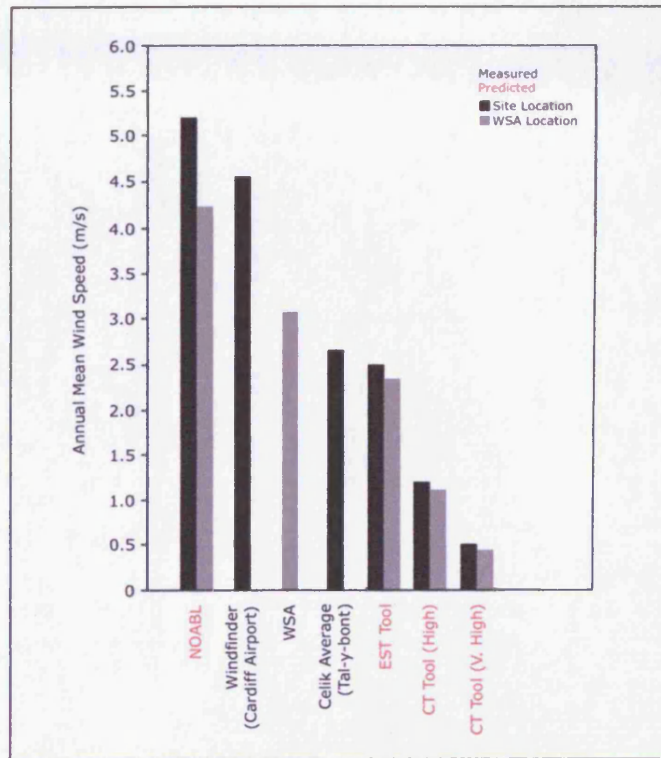

Figure 66: Comparison of annual mean wind speed data

The NOABL database predicted the highest wind speed for the case study location (5.2 m/s at 10m). This is comparable with measured data from Cardiff Airport reported by Windfinder (4.5 m/s at 10m), however, the character of the sites is very different with the former being a dense urban location with many obstructions and the latter being a smooth rural site with few obstructions. This apparent over-estimation by the NOABL data agrees with the findings of others (Chapter 4) and reflects the fact that this prediction method does not take into account site topography or local surface roughness. Measured data from the WSA weather station at 27m (3.2 m/s) is higher than the EST tool prediction for 10m (2.5 m/s) although this prediction is broadly in agreement with the data reported by Celik (2.66 m/s averaged for the 4 years reported). The CT tool prediction, CT Tool High, that is considered to be the most representative of the case study location in terms of surface roughness, gives the lowest predicted wind speed (1.2m/s), although this is using the default canopy height of 12m. When the canopy height is modified to 17.5m, the predicted wind speed drops to 0.7 m/s (refer to sensitivity analysis in Chapter 6).

5.4 Site Potential According to Existing Guidance

Table 25 compares the key points of the guidance discussed in Chapter 4 with the characteristics of the case study location and discusses their relevance.

Guidance	Case Study Location
Mount turbine as high as possible	Hub height is 10m (as defined by the height of the lighting column).
Mount turbine higher than surrounding obstacles	The average canopy layer height is approximately 17.5m. Therefore, mounting above this height is not possible / inappropriate for street lighting (see above).
Use measured wind speeds rather than estimates	Wind speed and direction will be monitored at 3 no. locations at the site at the proposed turbine hub height.
Select locations with higher mean wind speeds	Mean wind speed ranges from a minimum of 1.2 m/s estimated by the CT Tool to a maximum of 5.2 m/s estimated by the NOABL database. Measured data will indicate true highest wind speed for the monitoring period.
Avoid lee side of protruding obstacles	This is not possible for all wind directions for any of the points although the prevailing westerly wind direction has a relatively clear fetch compared with the other wind directions.
Avoid areas of excessive turbulence	All the locations are likely to experience turbulent conditions due to the surrounding urban built form.
Locate turbine for the prevailing wind direction	This is possible for the westerly wind direction but less so for the secondary north-easterly wind direction.
Mount turbine at top of a smooth hill	The site and surrounding area is a relatively flat plain.
Edge of urban area is more likely to be good site	The site is located approximately 5 km from the edge of the urban area in the prevailing wind direction (west) although there is a relatively open area of park land directly adjacent to the site in this direction.
Open areas in cities may provide sufficient resource	There is a relatively open area adjacent to the site (a park) in the direction of the prevailing wind (west).
Coastal locations may have a better wind resource	Cardiff is located close to the coast.
Avoid sites with obstructions behind the turbine	This cannot be avoided for all wind directions at any of the points, although there are no obstructions behind the points if the wind is from the east.

Table 25: Relevance of current siting guidance for case study location

5.5 Monitoring Equipment

The site is comprised of Greyfriars Road, a mixed urban street with vehicular and pedestrian users, and Kingsway, a pedestrian square. In terms of street lighting these would both be considered class CE1 areas (see Chapter 2, section 2.1.1). The project funding allowed for the purchase of 3 no. sets of wind and solar measuring equipment.

It was considered appropriate to mount monitoring equipment on existing lighting columns because the locations would then be realistic (i.e. positioned according to an actual lighting scheme) and the wind data would be collected from the turbine mounting height (10m). Furthermore, the practicality of erecting 3 no. temporary masts in a busy urban area for a period of 12 months was considered to be unfeasible by Cardiff Council.

As described in section 5.2.2, the street lights along the central to eastern section of Greyfriars Road were CU Phosco concrete columns that were scheduled for replacement. Cardiff Council would not permit the mounting of monitoring equipment on these columns on safety grounds. The columns on Kingsway and crossing the western end of Greyfriars Road were steel 'feature' columns manufactured by Urbis and installed in 1999. Cardiff Council permitted the installation of monitoring equipment on these columns and agreed to provide assistance in installing the equipment and access for data collection.

The 3 no. monitoring stations were designed, fabricated from steel and painted to BS 4800 (18C39 / 6126 - B08G) to match the existing column colour. A neoprene lining was used to prevent damage to the existing columns and the stations were held in place with 4 no. locating bolts. Figure 67 shows a schematic of the monitoring station and figure 68 shows a monitoring station in the lab and in-situ.

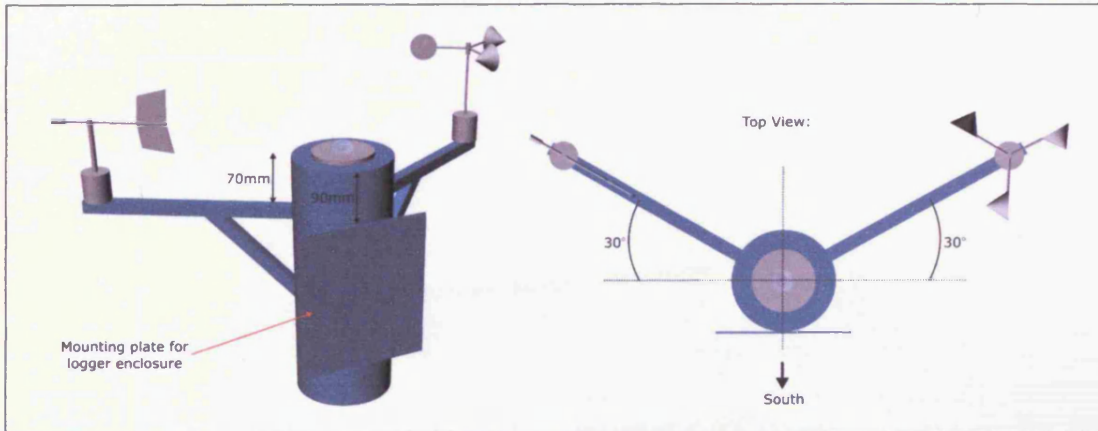

Figure 67: Monitoring station schematic

In each case the sensors used were a Vector Instruments A100R anemometer, a W200P wind vane and a Kipp and Zonen CMP6 pyranometer, all selected both for their accuracy and low power consumption (specifications of the sensors are provided in Appendix F). The wind sensors were horizontally offset north to avoid shading the pyranometer at low sun angles. The logger was a Campbell 21X mounted in an IP67 rated enclosure.



Figure 68: Data monitoring station in lab (left) and in-situ at case study location (right)

Of the street lights existing at the site, those shown in figure 69 were selected as monitoring locations because they were close together, allowing a comparison of wind variation over a short distance (19m – 33m), and also because they represented the change from a 'canyon' environment to a more open urban square²⁹⁹. Unfortunately it was not possible to collect data from a column located at a mid point in Greyfriars Road, for the reasons outlined in section 5.2.2, although this area was assessed using the BLWT.

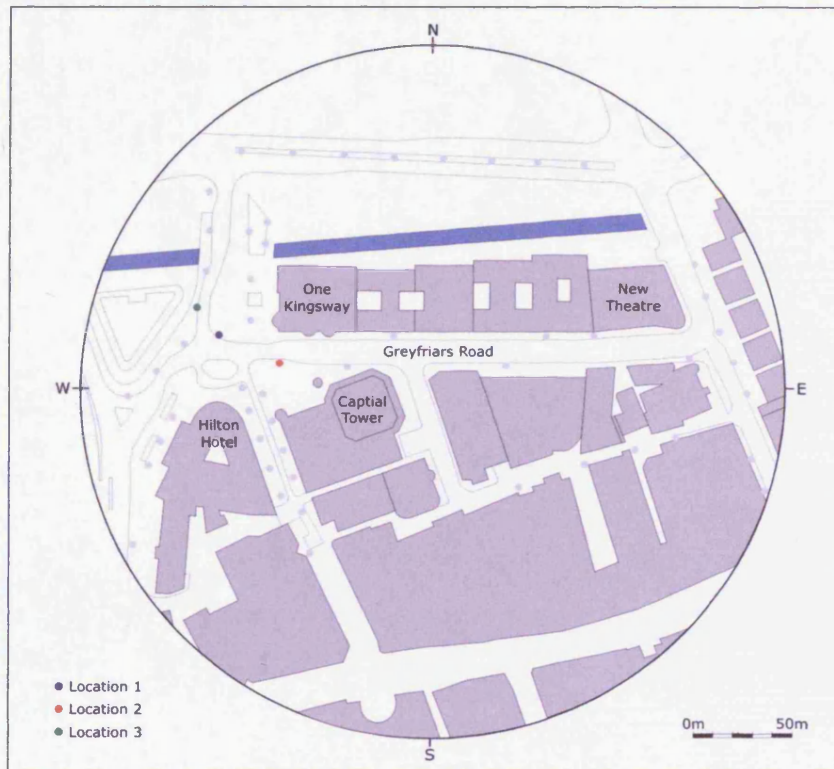

Figure 69: Street lights selected for monitoring

Data files for each station were manually downloaded to a laptop using an SC32A interface and Campbell PC208W software. This data were then imported to Microsoft Excel as comma-separated (.csv) files. The logger programme is included in Appendix F. Access to the monitoring stations was provided by a manned cherry-picker supplied by Cardiff Council street lighting department. The Council agreed to provide 4 no. access visits, allowing data to be collected for 3 month periods, given the constraints of logger memory and battery requirements. This enabled a total of 9 months' data to be collected from each station.

²⁹⁹ A pull out card version of this image can be found in Appendix G to aid with the results chapter

5.5.1 Data Parameters

The data collected by each monitoring station were as follows, with a 30 minute averaging period. This period was chosen because of the limitations in the size of the logger memory as well as the limited frequency of opportunities to access each station for downloading.

- Mean wind speed (m/s)
- Maximum gust speed (m/s)
- Mean wind direction
- Horizontal solar radiation (W/m^2)
- Ambient air temperature ($^{\circ}C$)
- Logger battery voltage (V)

In recent guidance for wind monitoring (published after the data were collected for this study), the European Wind Energy Association recommended that the following signals would typically be recorded for each sensor, with a 10 minute averaging period³⁰⁰:

- Mean wind speed (m/s)
- Maximum three second gust speed (m/s)
- True standard deviation of wind speed
- Mean wind direction
- Mean temperature ($^{\circ}C$)
- Logger battery voltage (V)

While these recommendations are guidance rather than accepted standards, the inclusion of standard deviation for each 10 minute period may, in future studies of this type, provide a higher resolution understanding of the wind regime. However, the 30 minute averaging period was considered to provide sufficient detail for this explorative study and allowed a direct comparison with climate data available from the WSA weather station.

³⁰⁰ <http://www.ewea.org> – last accessed May 2009

5.5.2 Physical Model (1:200 Scale)

A 1:200 scale physical model of the site was constructed from white card (figures 70 and 71). The scale was selected to be appropriate for the BLWT at the WSA. The model was mounted on a circular base with a diameter of 1.8m suitable for the turntable in the BLWT. Trees were made using wire wool in a wire mesh frame to simulate a level of porosity compared with solid objects.



Figure 70: 1:200 scale site model (the author is shown for scale)³⁰¹

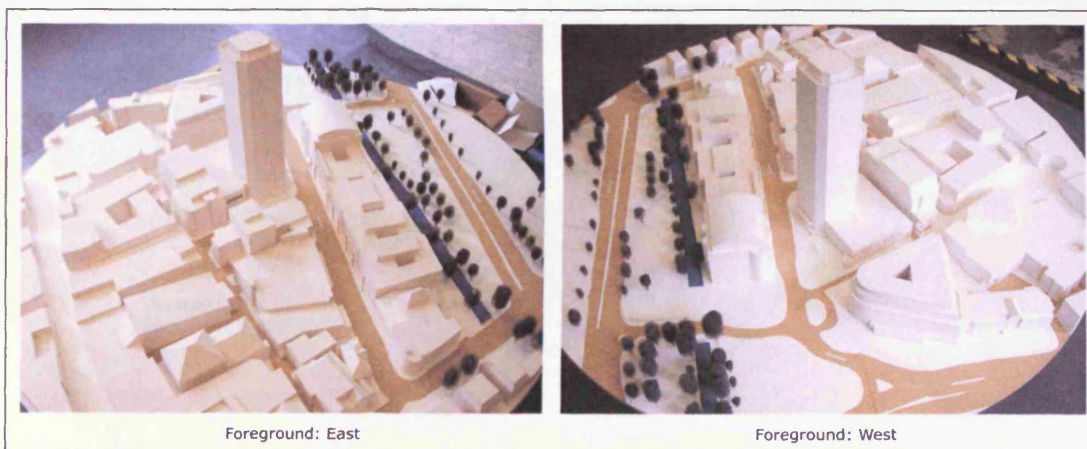

Figure 71: Top views of 1:200 scale site model

³⁰¹ Photograph provided by Ian Knight, WSA.

5.6 Wind Tunnel Tests

The wind tunnel at the WSA is a boundary layer wind tunnel (BLWT). The BLWT is of an open circuit design that draws air from and exhausts air to the same room (figure 72). The wind tunnel has a working cross section 2000mm wide by 1280mm high, with a turntable 1800mm wide for mounting models (figure 73). At the time of this study the overall length of the tunnel was 12m, with an upstream flow development fetch of 6m and a bell mouth entry area of 2.6m x 5.2m.

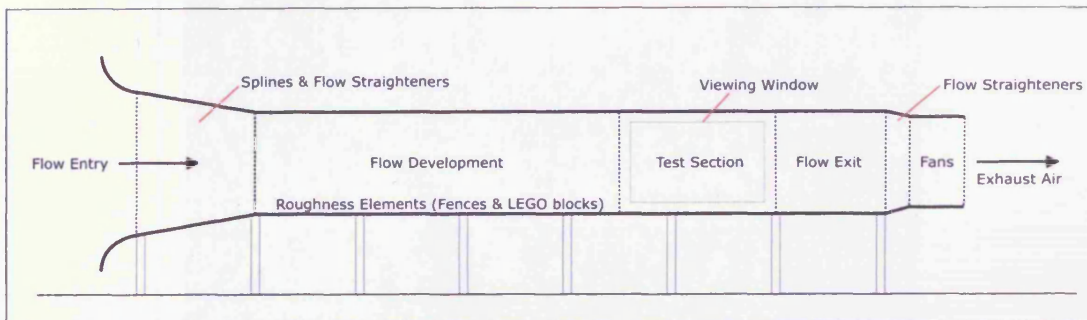

Figure 72: Schematic section of BLWT at the WSA

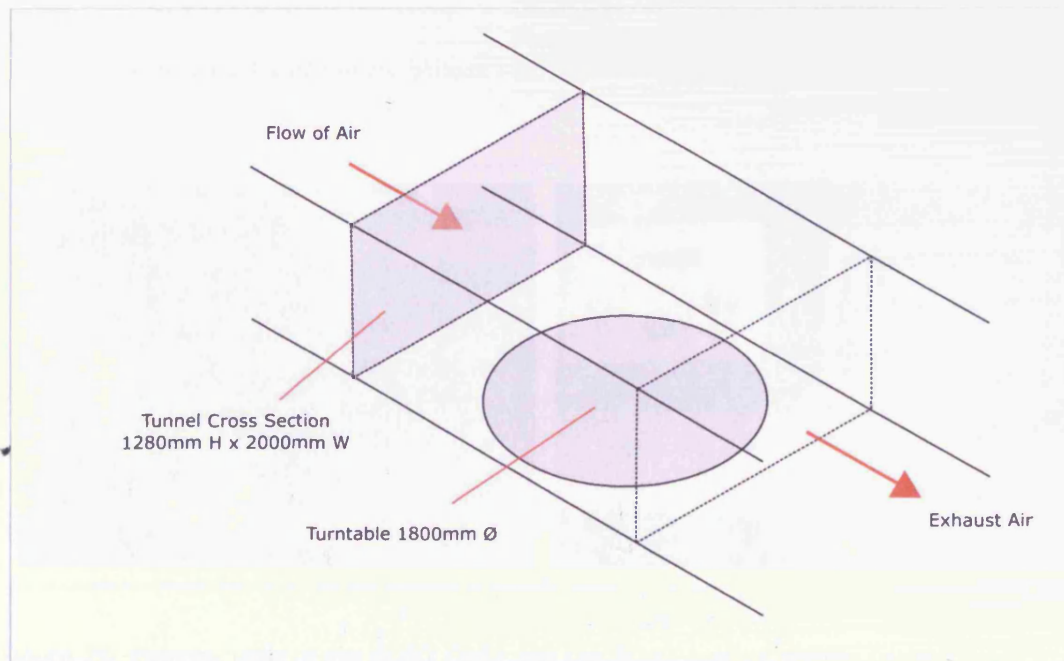

Figure 73: Wind tunnel dimensions at model turntable

The boundary layer was created using a combination of blockages, fences and surface roughness elements (Lego™ Duplo™ blocks) to produce a scale model of wind speed and turbulence (figure 74). This technique, reported by Pavageau and Schatzmann³⁰², was shown by Counihan to have a good correlation with field measurements and should therefore be considered an "adequate representation of a boundary layer"³⁰³.

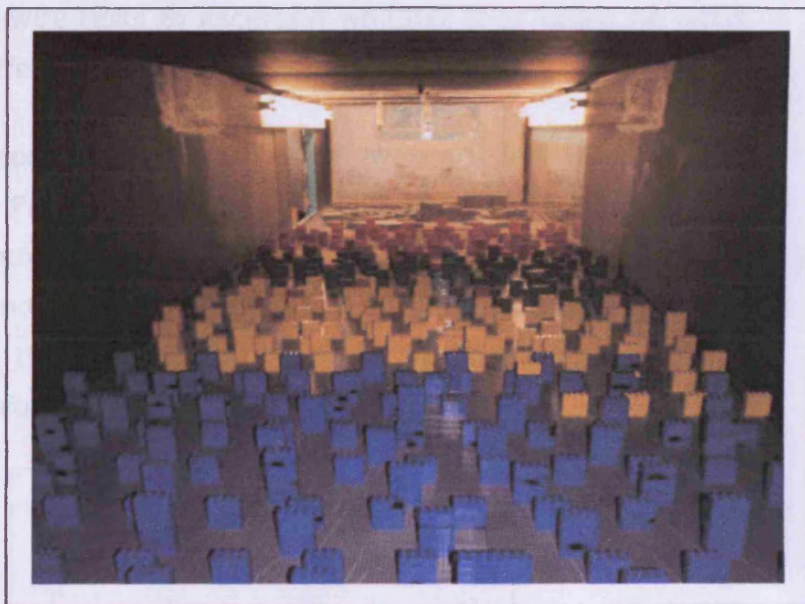

Figure 74: Interior view of the roughness field (looking towards the test section)³⁰⁴

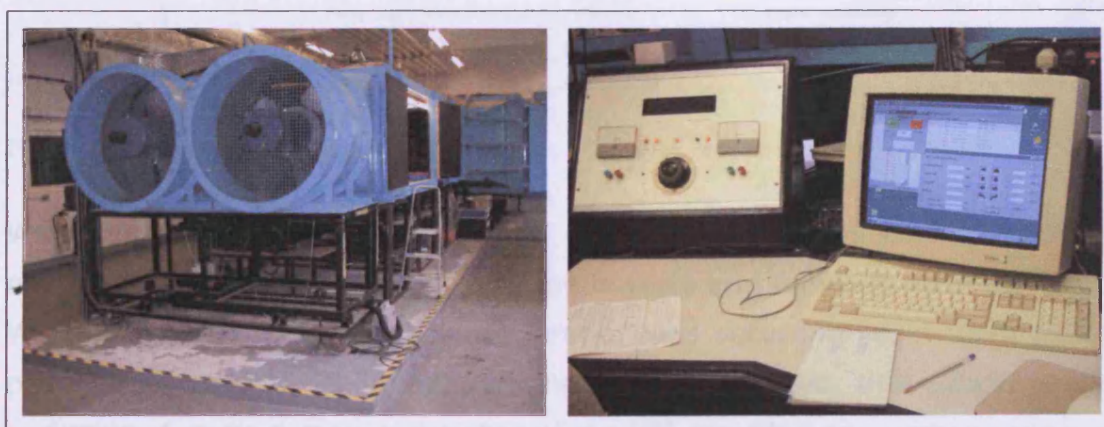

Figure 75: Exterior view of the BLWT (left) and the BLWT control station (right)

³⁰² Pavageau, M., Schatzmann, M., *Wind tunnel measurements of concentration fluctuations in an urban street canyon*, Atmospheric Environment, Vol. 33, 1999, pages 3961 - 3971

³⁰³ Counihan, J., *Simulation Of An Adiabatic Urban Boundary Layer In A Wind Tunnel*, Atmospheric Environment, Vol. 7, 1973, pages 673 - 689

³⁰⁴ Photograph provided by Dylan Dixon, WSA.

5.6.1 Scouring Tests

Using the 1:200 scale site model, a scouring test was undertaken for 8 wind directions (N, NE, E, SE, S, SW, W, NW). This test was used to examine wind effects at ground level, specifically areas where wind acceleration or shelter were present. The aim of these tests was to develop a broad understanding of the wind effects at the site. The results were later compared with the results of the hot-wire tests to ascertain whether they could be used as an indicator for wind effects at the 10m level.

For the scouring test, the model was seeded with fine grained semolina substrate. Figure 76 shows the scale used for the scouring test, where the coloured boxes represent those used on the contour plot. The wind tunnel settings and percentage acceleration / shelter are shown. WT setting 62 (100%) is the speed at which a flat surface (model base with all features removed) completely clears of the substrate.

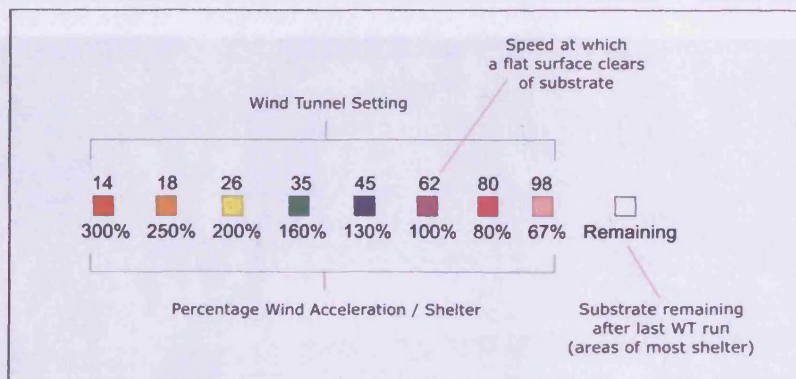

Figure 76: Scale used for scouring tests

With the model in place and seeded with substrate, runs of the WT were made at each setting (starting from the lowest) and for each wind direction. WT settings <62 indicated that acceleration was occurring (equivalent to the percentage shown) while WT settings >62 indicated that shelter was occurring. A camera mounted on top of the WT provided an overhead view as the substrate cleared, allowing the clearance at each setting to be recorded. Still images of each setting were then traced and the results overlaid to form a contour plot showing areas of acceleration and shelter. Figure 77 shows the model at various stages of the scouring process, recorded from the side viewing window. Results are presented in Chapter 6.



Figure 77: Scouring test in progress for wind direction: South (top = fully seeded model)

5.6.2 Hot-wire tests

For the 'hot-wire' tests 2 no. TSI 8460 windowless air velocity transducers (hot-wire anemometers) were used, one at high level (HI) and one at low level (LO) - for specification refer to Appendix F2. The HI probe provided a reference for WT 'free stream' while the LO probe measured the air speed at the model height. The wind speed for a given point was then calculated as a ratio of LO / HI. For the hot-wire tests WT runs were made at setting 98 (corresponding to a wind speed of approximately 10 m/s) in order to stabilise the turbulent effects around obstructions.

Prior to testing the model using the hot-wire probes, the probes were normalised by running the wind tunnel without the model present (figure 78). The vertical was checked for the LO probe and the probe was positioned at the monitoring height (50mm or 10m equivalent at 1:200 scale). Hot-wire measurements made close to the surface are typically within $\pm 5\%$ of the true values³⁰⁵. Crude tests with tubing attached to a pump indicated that the 'sweet spot' was approximately 3mm from the end of the needle.



Figure 78: Normalising the hot-wire probes

Points on the model corresponding to the 3 column locations at the case study site were tested for 8 wind directions (N, NE, E, SE, S, SW, W, NW) at 10m height (50mm at 1:200 scale). Following this, a further 60 no. points were selected on the physical scale model corresponding to potential street light locations. These points were then tested in the wind tunnel for 3 no. wind directions, W, NE & S. The points were selected to demonstrate a range of conditions (open aspect, closed aspect, canyon, etc). Measurements were taken at 1m, 5m and 10m for each point to explore where any correlation could be found with the results of the scouring tests. The results of the hot-wire tests are presented in Chapter 6.

³⁰⁵ Lubitz, W. D., White, B. R. *Atmospheric Boundary Layer Wind Tunnel Applications in Wind Turbine Siting*. Proceedings of World Wind Energy Conference, Beijing, China, Oct. 31 - Nov. 4, 2004.

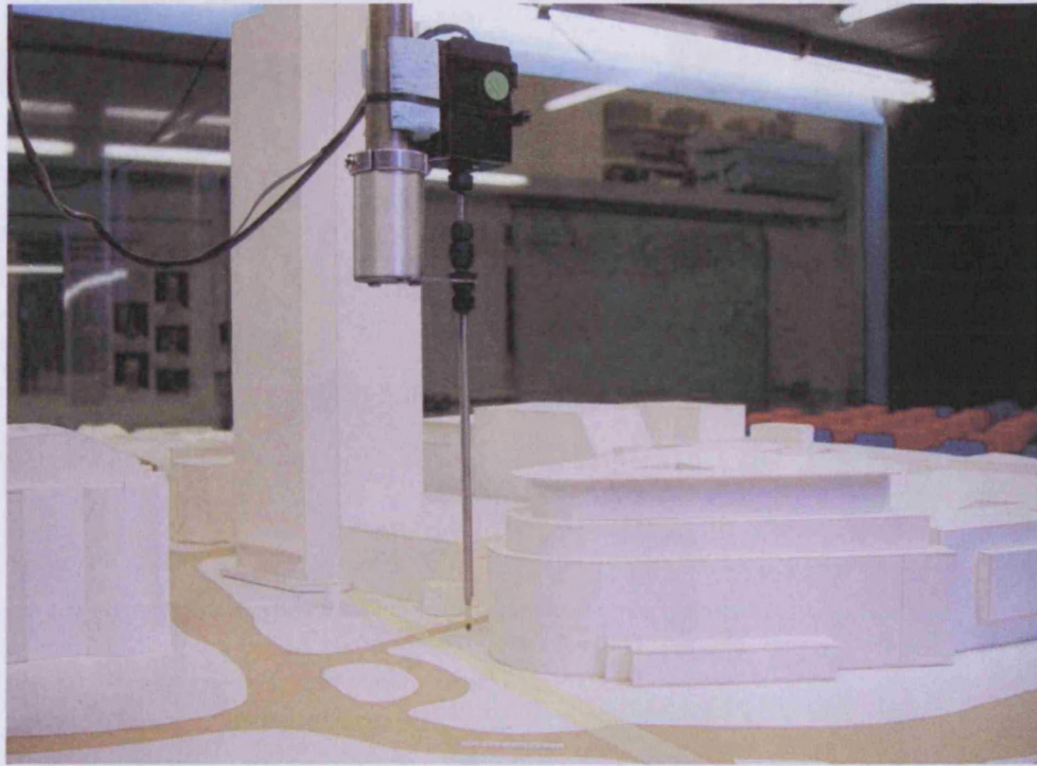

Figure 79: Hot-wire test for 1m height, wind direction: South (measurement points shown)

5.7 Summary

The case study location provides an example of a dense urban environment where street lighting is required. From estimates of surface roughness, numerical predictions and measured data from near to the site, as well as current wind turbine siting guidance, the wind regime at near ground level ($\leq 10\text{m}$) in the case study urban environment is expected to be characterised by low wind speeds ($< 4\text{ m/s}$). However, the surrounding urban geometry may produce localised areas of wind acceleration that would provide a greater resource to a small wind turbine, allowing it to contribute significantly to the energy balance of the hybrid street lighting system.

The literature review has established that the BLWT is the most accurate method of modelling the wind regime in a complex urban environment currently available and a geometrically accurate physical model of the site has been constructed. Through the use of scouring tests and hot-wire tests, a profile of the near ground wind regime for the case study location will be developed that may allow sites of potentially higher wind resource than the monitoring points to be identified.

Furthermore, the literature review has identified a numerical tool for estimating the energy yield from small wind turbines in urban locations (the CT Tool). The results from this tool will be compared with the monitored data from 3 locations at the case study site, together with the power curves of 12 small wind turbines, to establish whether the tool gives an accurate estimation of energy yield and to calculate the actual energy yield based on measured data.

CHAPTER 6 – RESULTS & DISCUSSION

6.0 Introduction

This chapter presents the results of the study. The results are divided into 2 main sections, the results of data monitoring and the results from wind tunnel testing.

The operational parameters of the standalone hybrid wind / PV street lighting system were described in Chapter 2. The system was designed with 3 days autonomy (i.e. it should function for 3 days with no renewable power input). The total number of days in the monitoring period was 271 days. Therefore, assuming that the lamps are on for 8 hours per day throughout the monitoring period, the total number of hours when the lamps would be on during this period would be $271 \times 8 \text{ hours} = 2168 \text{ hours}$. With either 2 no. 75W lamps or 1 no. 150W lamp, the street light therefore has a total energy load for this period of $150\text{W} \times 2168 \text{ hours} = 325200\text{Wh}$ (325.2kWh).

The monitored data for each location was combined with the power curves of the 12 no. turbine types to identify the energy yield from each turbine type at each location for running 3 day periods as well as total yield. Turbine capacity factors were also calculated for each turbine type at each location. In view of developments in low energy lighting technology, a further comparison was made that assumed that the 150W load could be reduced to 60W by using an LED luminaire rather than the SOX or HPI lamps. The total load for the monitoring period using this lamp type was again assessed against turbine energy yield as 3 day running totals.

The results of wind tunnel testing are also presented in this chapter. Wind shelter roses for the 3 column locations were produced from the results of the hot-wire testing and these were compared with actual wind direction data recorded by the WSA weather station to ascertain whether there was a correlation with the monitored wind direction data at the column locations. Further scouring and hot-wire tests were conducted for the prevailing wind directions for other areas of the site, where monitoring had not been possible, to ascertain whether there were any more advantageous locations.

6.1 Estimating Energy Yields Using the Carbon Trust Tool

This section compares the estimated yield of the turbines identified in Chapter 4, using the Carbon Trust Wind Yield Estimator Tool. For the purposes of this analysis the case study location is represented as 1 location (rather than the 3 individual monitoring points) because of the limited level of definition available with the tool. The tool is not intended to provide a definitive approximation of energy yield, rather a first order estimate, as the Carbon Trust guidance states:

*"It is important to understand that the tool's estimates are based on a simplified model of wind speeds and local physical conditions. The estimates may vary from conditions actually experienced in practice, depending on various local factors (e.g. sheltering caused by nearby ground features). The tool does not include data about such factors nor any functionality to model them in detail, and it may be appropriate to collect such data and undertake modelling separately. Also, the tool is not a substitute for local anemometry measurements, which, should the tool's estimates indicate that a site is attractive for wind energy generation, should be undertaken before a small turbine is installed"*³⁰⁶

As discussed in Chapter 4, the CT Tool represents the current 'state-of-the-art' for numerical methods of estimating energy yield from small wind turbines in urban environments. It was therefore considered appropriate to use this tool as the basis for comparison with monitored data from the case study location. The following sections present a sensitivity analysis of the CT Tool and the energy yields predicted using the tool for the 12 no. small wind turbines identified in Chapter 4.

Turbine power curves used in this analysis were derived from manufacturers' data (web links to which are provided in Appendix D).

³⁰⁶ Carbon Trust Wind Yield Estimation Tool – Terms and Conditions of Use
(www.carbontrust.co.uk/windpowerestimator/windpowerestimator/terms.aspx
- last accessed August 2009)

6.1.1 Sensitivity Analysis 1 – Canopy and Hub Height

An initial sensitivity analysis was shown in Chapter 5, by comparing the default canopy and roughness settings for the case study location and the WSA location. Having calculated the average canopy layer height to be 17.5m in both locations, this is now included for comparison (table 26). The hub height of the turbine at the case study location was set at 10m, while the hub height of the turbine at the WSA location was set at 27m, both equal with the data collection heights at the respective locations.

			Annual Mean Wind Speed (m/s)			
Site Character	Default Canopy Height	Default Weibull Shape (k)	Case Study Location CF10 3AQ	Calculated Weibull Scale (A)	WSA Location CF10 3NB	Calculated Weibull Scale (A)
Open countryside	0m	1.8	3.5	3.8981	4.0	4.5335
Woodland	19.5m	1.8	0.2	0.2732	3.7	4.1987
Low height and density, residential	6m	1.8	2.9	3.2537	4.1	4.6298
Low height and density, industrial	6m	1.8	2.9	3.2537	4.1	4.6298
Medium height and density, residential	9m	1.8	2.3	2.6122	4.0	4.5519
Medium height and density, industrial	9m	1.8	2.3	2.6122	4.0	4.5519
High height and density	12m	1.8	1.2	1.4015	3.9	4.3760
Very high height and density, cityscape	25m	1.8	0.5	0.5110	2.8	3.0960
Site Character	Actual Canopy Height	Default Weibull Shape (k)	Case Study Location CF10 3AQ	Calculated Weibull Scale (A)	WSA Location CF10 3NB	Calculated Weibull Scale (A)
High height and density	17.5m	1.8	0.7	0.7671	3.6	4.0632
Very high height and density, cityscape	17.5m	1.8	0.7	0.7469	3.6	4.0475

Table 26: Sensitivity analysis including calculated average canopy layer height

This analysis shows the effect of changing the canopy height and the hub height on the Weibull parameters (k) and (A), that are automatically set within the tool. The shape parameter (k) remains at its default setting of 1.8 (as discussed in Chapter 4).

6.1.2 Sensitivity Analysis 2 – Turbine Yield

A further sensitivity analysis was conducted using the power curve data for one of the wind turbine types (SW Windpower Air-X), to examine the effect of changes in input data to the tool (table 27). Default and modified canopy height settings are indicated.

Setting	Site Character	Canopy Height (m)	Annual Mean Wind Speed (m/s)	Annual Mean Power Generation (kWh)
Default	Open Countryside	0	3.5	167
Default	Woodland	19.5	0.2	0
Default	Low height and density, residential	6	2.9	88
Default	Low height and density, industrial	6	2.9	88
Default	Medium height and density, residential	9	2.3	35
Default	Medium height and density, industrial	9	2.3	35
Default	High height and density	12	1.2	0
Modified	High height and density	17.5	0.7	0
Default	Very high density, cityscape	25	0.5	0
Modified	Very high density, cityscape	17.5	0.7	0

Table 27: Sensitivity analysis – estimated energy yield from a selected wind turbine

The results of the sensitivity analysis show that the energy yield estimated by the tool is highly dependant on the input data (as would be expected), with a variation of 0 kWh to 167 kWh energy output for the same turbine depending on location and canopy height. Open countryside provided the best estimated energy yield, as would be expected from the various turbine siting guidance discussed in Chapter 4.

6.1.3 Estimated Yields Using Carbon Trust Tool

The next stage of the analysis was to input the power curve data for each of the 12 no. wind turbines into the tool and to estimate the energy yield for each turbine at the 2 locations (WSA location and case study location). For this analysis the canopy height at the case study location and the WSA location were both modified to 17.5m to reflect the actual canopy height. Similar to the sensitivity analysis, the hub height of the turbine at the case study location was set at 10m, while the hub height of the turbine at the WSA location was set at 27m (rather than 10m as in the previous comparison of data in Chapter 5). These are both equal to the data collection heights at the respective locations. Table 28 shows the estimated turbine energy yields produced by the tool, to the nearest kWh.

Wind Turbine Type	Location	Annual Mean Wind Speed (m/s)	Annual Mean Energy Generation (kWh)
Ampair: 100	WSA	3.6	70
	Site	0.7	0
Ampair: 300	WSA	3.6	114
	Site	0.7	0
Ampair: 600	WSA	3.6	595
	Site	0.7	0
Eclectic: D400	WSA	3.6	460
	Site	0.7	0
Marlec: Rutland 913	WSA	3.6	312
	Site	0.7	0
Marlec: Rutland 1803-2	WSA	3.6	265
	Site	0.7	0
Renewable Devices: Swift	WSA	3.6	794
	Site	0.7	0
SW Windpower: Air X	WSA	3.6	191
	Site	0.7	0
SW Windpower: Whisper 100	WSA	3.6	564
	Site	0.7	0
Windside: WS015	WSA	3.6	18
	Site	0.7	0
Windside: WS030B	WSA	3.6	42
	Site	0.7	0
Windside: WS2B	WSA	3.6	228
	Site	0.7	2

Table 28: Estimated energy yield for 12 no. wind turbine types at the 2 locations

According to the CT Tool analysis (table 28), the highest energy yield at the WSA location for the specified canopy height (17.5m) and hub height (27m) was achieved by the Renewable Devices Swift (794 kWh / year). The lowest energy yield was achieved by the Windside WS015 (18 kWh / year). For the case study location, with the specified canopy height (17.5m) and hub height (10m), only the Windside WS2B turbine produced any energy yield (2kWh / year), perhaps reflecting the very low estimated wind speed together with the low cut-in speed (2.0 m/s) of this turbine.

6.2 Results of Wind Data Monitoring for Case Study Location

The measured data from the 3 column locations at the case study location and data collected by the WSA weather station are compared in the following sections. The wind speed data are presented in tables and the wind direction data are presented as wind roses. The wind data presented are based on 30 minute averages (as described in section 5.5.1).

This analysis was made using the standard functions available in Microsoft Excel, including simple statistical analysis and graphing techniques. A more complex statistical analysis, was not considered necessary because the potential turbine energy output from the measured wind data was the focus of this work and not the wind data itself. Others, such as Brown et al³⁰⁷, have illustrated methods to undertake a more detailed analysis of wind data.

To aid in the interpretation of these results a pull out card indicating the monitoring station locations can be found in Appendix G.

³⁰⁷ Brown, H., Hailes, D., Rhodes, M., *Conclusions and empirical data from the first large scale public field trial of building-mounted micro-wind turbines*, EWEC, Marseilles, 16th - 19th March, 2009

6.2.1 Analysis and Comparison of Mean Wind Speed Data

Table 29 shows a summary of the monitored wind speed data from the 4 no. locations. In addition to the mean wind speeds, the maximum, minimum and standard deviation provide a simple description of the distribution.

	Total Monitoring Period			
	Mean m/s	SD	Max m/s	Min m/s
WSA Location	3.16	1.68	11.00	0.00
Location 1	2.07	1.15	10.81	0.11
Location 2	2.12	1.22	8.91	0.15
Location 3	2.05	1.68	9.97	0.09

Location 2 experiences the highest number of monthly mean and maximum wind speeds of all the column locations monitored (refer to figures in bold text).

	March				April			
	Mean m/s	SD	Max m/s	Min m/s	Mean m/s	SD	Max m/s	Min m/s
WSA Location	3.52	1.64	8.00	0.10	3.80	1.83	10.60	0.10
Location 1	2.09	0.88	4.86	0.23	2.40	1.17	4.86	0.22
Location 2	2.56	1.23	4.86	0.16	2.58	1.26	4.86	0.20
Location 3	1.83	0.80	4.86	0.17	2.34	1.20	4.86	0.14

	May				June			
	Mean m/s	SD	Max m/s	Min m/s	Mean m/s	SD	Max m/s	Min m/s
WSA Location	3.41	1.74	9.30	0.10	3.02	1.54	7.50	0.10
Location 1	2.58	1.38	6.94	0.26	2.08	1.09	6.12	0.29
Location 2	2.41	1.36	7.09	0.24	2.09	1.10	5.78	0.29
Location 3	2.44	1.25	6.18	0.16	2.06	1.02	5.73	0.14

	July				August			
	Mean m/s	SD	Max m/s	Min m/s	Mean m/s	SD	Max m/s	Min m/s
WSA Location	2.86	1.35	7.10	0.20	2.78	1.30	6.80	0.10
Location 1	1.97	0.95	5.34	0.33	1.80	0.89	5.27	0.31
Location 2	1.95	0.99	5.67	0.31	1.84	0.93	5.09	0.31
Location 3	1.97	0.95	5.34	0.19	1.90	0.94	5.10	0.13

	September				October			
	Mean m/s	SD	Max m/s	Min m/s	Mean m/s	SD	Max m/s	Min m/s
WSA Location	2.14	1.19	6.40	0.10	3.50	1.77	8.30	0.20
Location 1	1.48	0.91	5.26	0.21	1.91	1.00	6.31	0.11
Location 2	1.40	0.85	6.72	0.26	2.23	1.33	6.40	0.15
Location 3	1.48	0.92	4.64	0.12	2.07	1.23	6.01	0.14

	November				December			
	Mean m/s	SD	Max m/s	Min m/s	Mean m/s	SD	Max m/s	Min m/s
WSA Location	3.25	1.97	11.00	0.00	3.45	1.93	9.00	0.10
Location 1	2.25	1.80	10.81	0.17	2.17	0.97	4.94	0.30
Location 2	2.01	1.38	8.91	0.21	2.51	1.29	5.87	0.22
Location 3	2.20	1.73	9.97	0.09	2.12	1.11	5.98	0.17

Table 29: Comparison of measured wind speed data for the monitoring period (2003)

Figure 80 illustrates the cumulative monthly wind speed for each location as a proportion of the total wind speed for the monitoring period. The data for March and December was excluded from this graph due to the relatively low number of data measurements in these months. This graph shows that the windiest month for the column locations during the monitoring period was May, whereas the windiest month for the WSA station for the same period was April, suggesting that wind direction is also an important factor in determining the urban wind regime. Both the column locations and the WSA station are in agreement that the least windy month for the monitoring period was September.

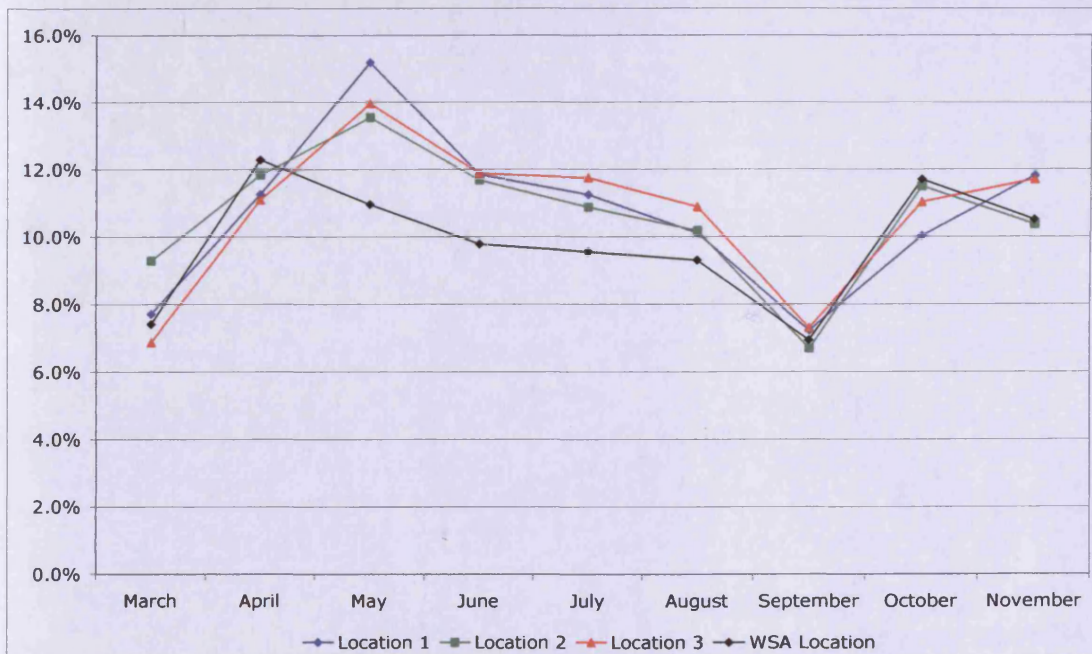

Figure 80: Monthly mean wind speeds as a percentage of total monitoring period

The number of data measurements together with an indication of missing data is provided in table 30 (overleaf). Where there were missing data values, these were disregarded in the statistical analyses. The number of missing data points was not considered significant to the overall findings of the study.

	March			April		
	No of half hour periods	Number of readings	Number of readings Missing	No of half hour periods	Number of readings	Number of readings missing
WSA Location	936	936	0	1440	1440	0
Location 1	936	936	0	1440	1186	254
Location 2	936	936	0	1440	1186	254
Location 3	936	936	0	1440	1186	254

	May			June		
	No of half hour periods	Number of readings	Number of readings Missing	No of half hour periods	Number of readings	Number of readings missing
WSA Location	1492	1488	4	1440	1440	0
Location 1	1492	1488	4	1440	1440	0
Location 2	1492	1488	4	1440	1439	1
Location 3	1492	1488	4	1440	1439	1

	July			August		
	No of half hour periods	Number of readings	Number of readings Missing	No of half hour periods	Number of readings	Number of readings missing
WSA Location	1488	1488	0	1488	1488	0
Location 1	1488	1488	0	1488	1425	63
Location 2	1488	1488	0	1488	1425	63
Location 3	1488	1488	0	1488	1426	62

	September			October		
	No of half hour periods	Number of readings	Number of readings Missing	No of half hour periods	Number of readings	Number of readings missing
WSA Location	1440	1440	0	1488	1488	0
Location 1	1440	1233	207	1488	1328	160
Location 2	1440	1233	207	1488	1329	159
Location 3	1440	1234	206	1488	1328	160

	November			December		
	No of half hour periods	Number of readings	Number of readings Missing	No of half hour periods	Number of readings	Number of readings missing
WSA Location	1440	1440	0	1488	1488	0
Location 1	1440	1330	110	1488	406	1082
Location 2	1440	1328	112	1488	406	1082
Location 3	1440	1329	111	1488	405	1083

Table 30: Number of data measurements and missing data for each location

The following figures provide a more detailed description of the wind speed distribution for each location during the monitoring period. The graphs are annotated to illustrate the relevant findings.

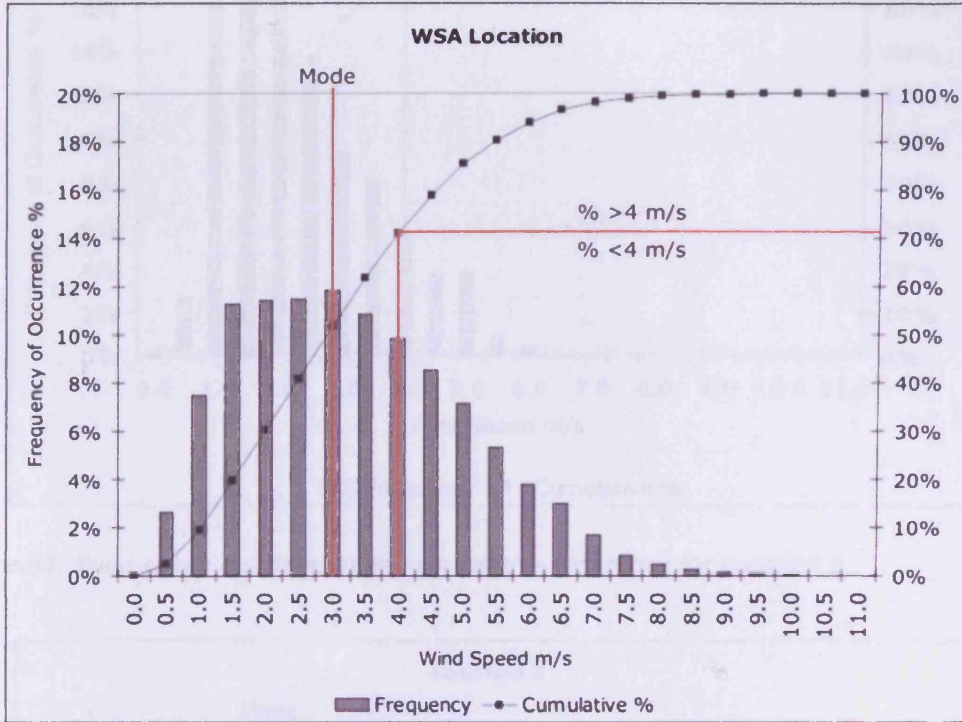

Figure 81: Wind speed distribution and cumulative frequency for WSA Location

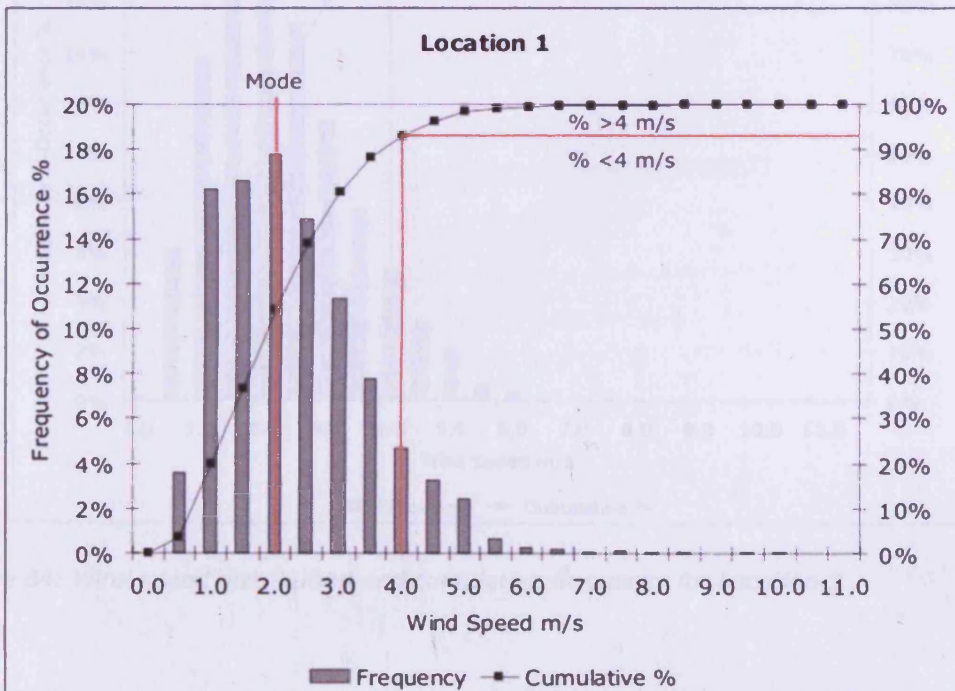

Figure 82: Wind speed distribution and cumulative frequency for Location 1

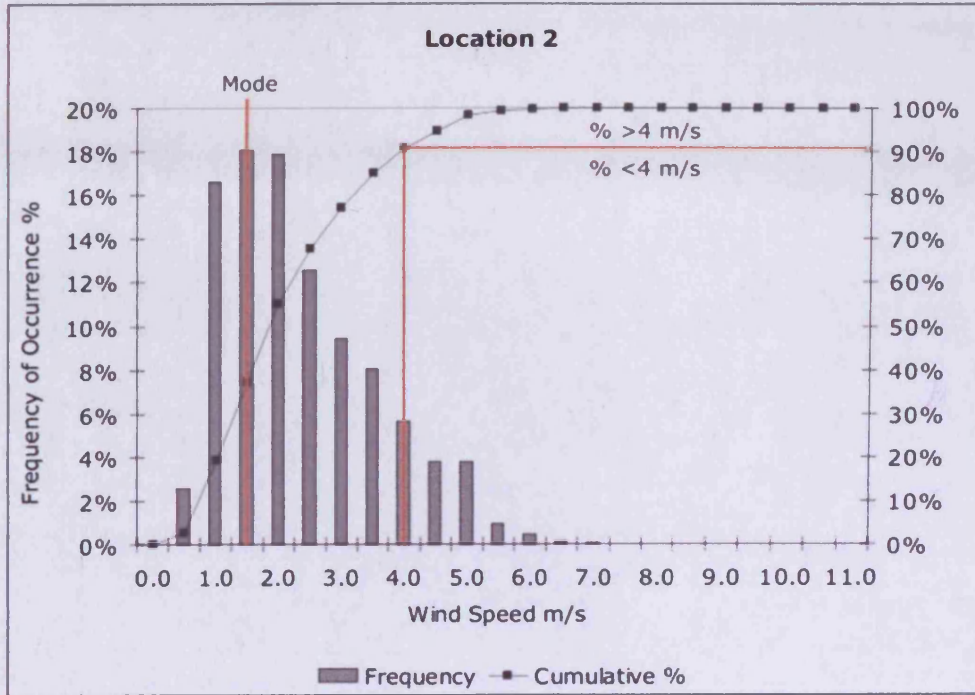

Figure 83: Wind speed distribution and cumulative frequency for Location 2

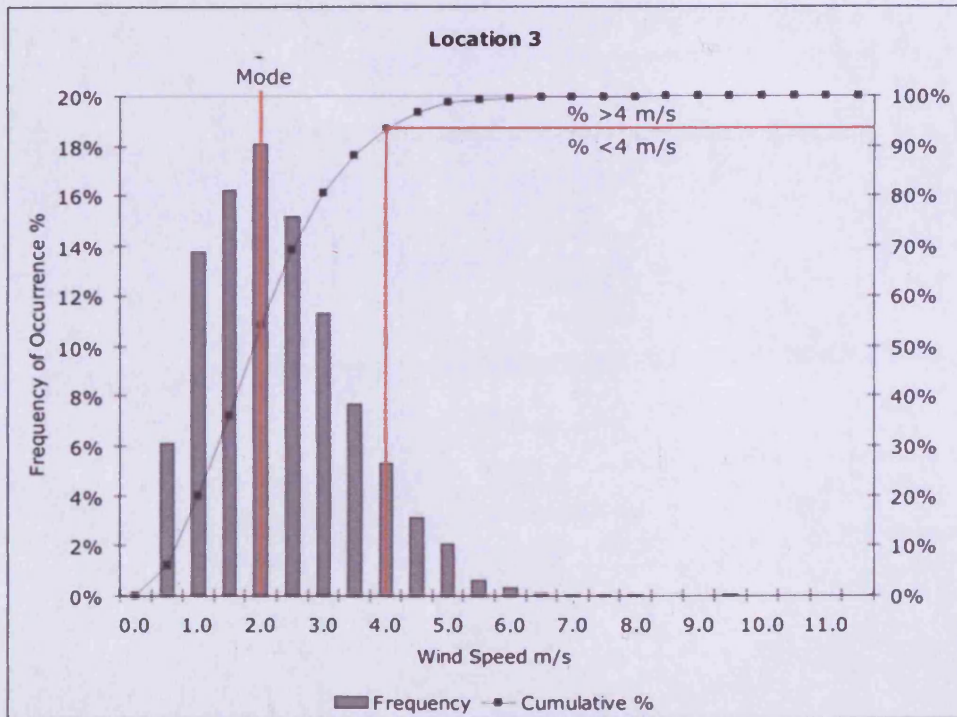

Figure 84: Wind speed distribution and cumulative frequency for Location 3

These distribution graphs show that the WSA location has a flatter wind speed distribution than the column locations, with a far greater frequency of wind speeds ≥ 4 m/s. The modal wind speed at the WSA is 3 m/s while that for column location 1 and 3 is 2 m/s and column location 2 is 1.5 m/s. However, despite having the lowest modal wind speed, column location 2 also has a higher proportion of wind speeds ≥ 4 m/s (9.23%) compared with the other 2 column locations (location 1 = 7.19% and location 3 = 6.49%).

6.2.2 Determining the Weibull Shape Factor (k)

The Weibull shape factor (k) commonly applied to wind data sets in the UK is $k=1.8$ (as is the case in the CT Tool analysis) and this is generally considered to provide a good fit with monitored wind data. However, as has been discussed in section 4.1.6, calculated k-values for specific sites in the UK have been shown to vary above and below this figure. If the incorrect k-value is used when estimating the energy yield from a wind turbine by combining a Weibull distribution and a turbine power curve then the estimated energy yield may also be significantly incorrect. The Weibull shape factor (k) for each of the monitored wind data sets was calculated using the Modified Maximum Likelihood Method (MMLM) proposed by Seguro and Lambert³⁰⁸ with an MS Excel spreadsheet developed at London South Bank University. Figures 85 – 88 show the fitted Weibull distribution for the monitoring period for the WSA location and the 3 no. column locations. The calculated monthly k-values and c-values (scale factor) for each of these locations, together with mean values for the monitoring period as a whole, are shown in table 31.

³⁰⁸ Seguro, J. V. & Lambert, T. W., *Modern estimation of the parameters of the Weibull wind speed distribution for wind energy analysis*, Journal of Wind Engineering and Industrial Aerodynamics, 85, 2000, pages 75-84

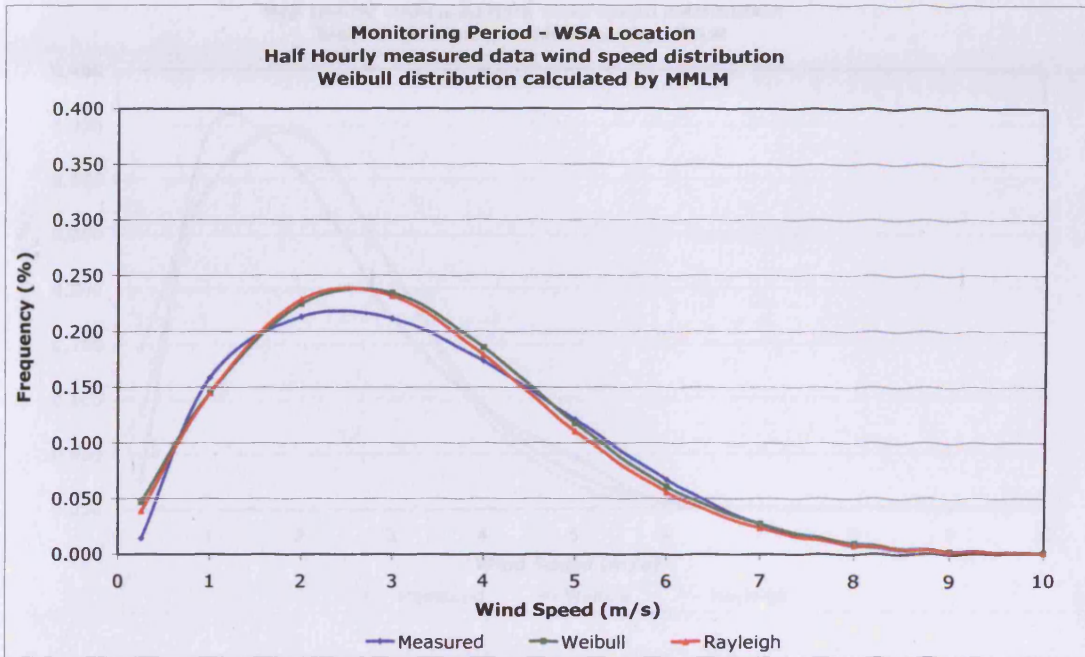

Figure 85: Fitted Weibull for WSA Location ($k=2.01, c=3.59$)

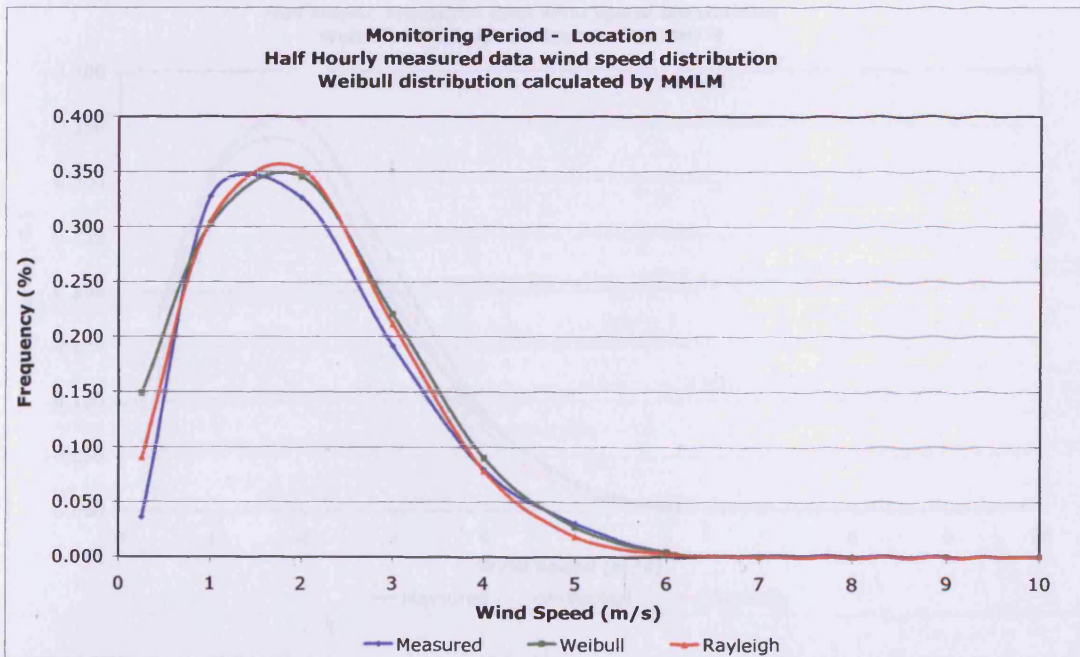

Figure 86: Fitted Weibull for Column Location 1 ($k=1.96, c=2.36$)

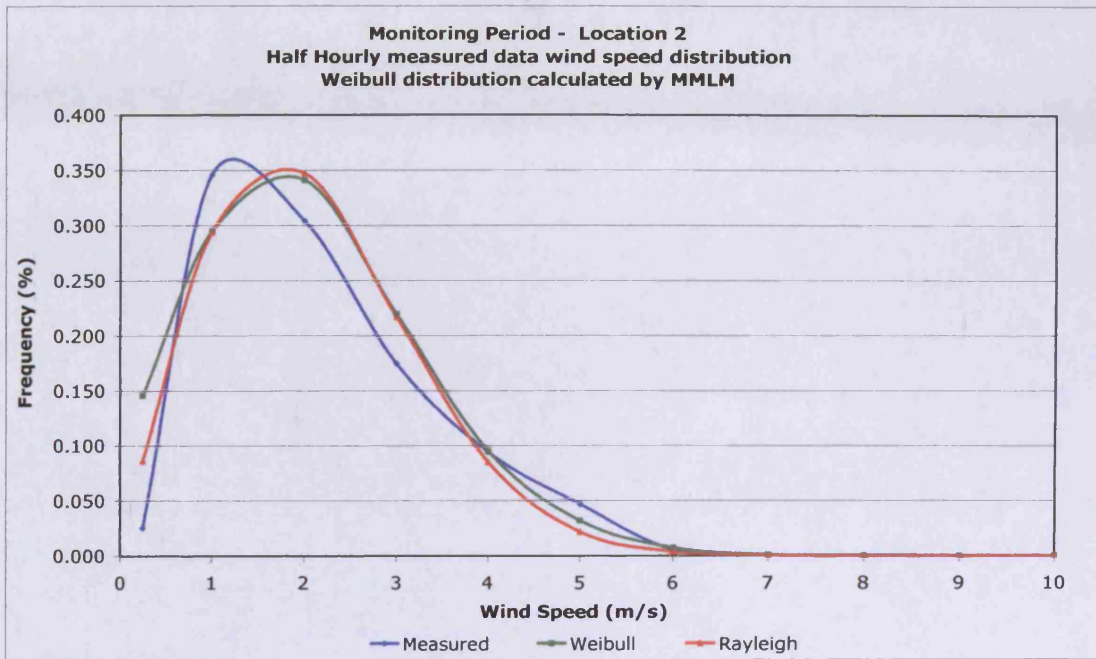

Figure 87: Fitted Weibull for Column Location 2 ($k=1.95$, $c=2.41$)

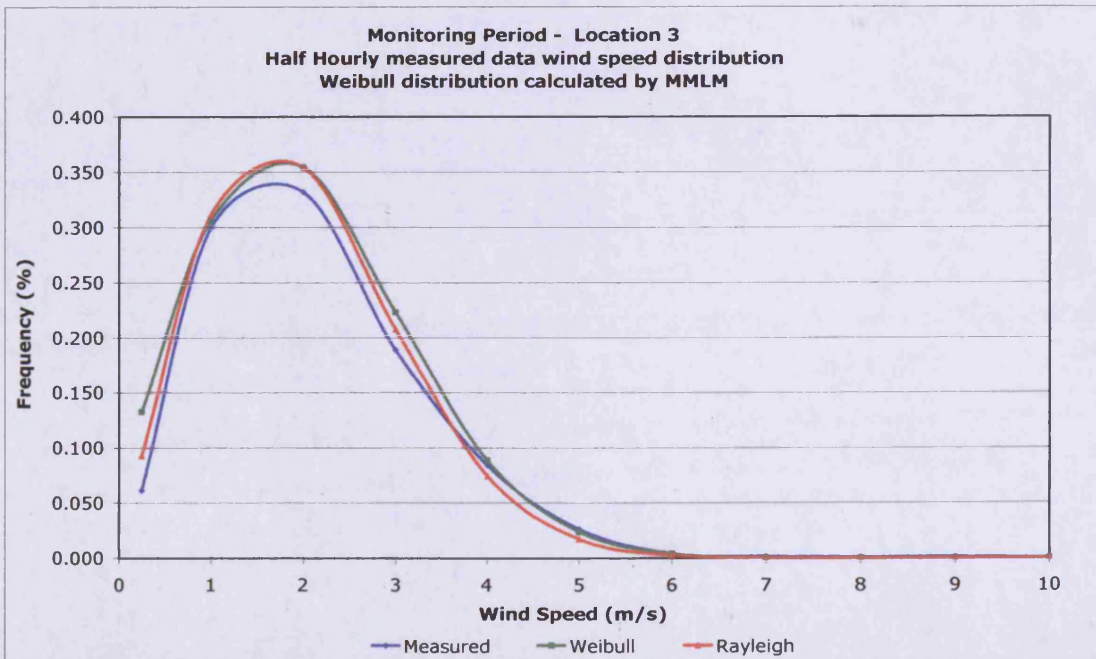

Figure 88: Fitted Weibull for Column Location 3 ($k=2.01$, $c=2.35$)

		Mar	Apr	May	Jun	Jul	Aug	Sep	Oct	Nov	Dec	Monitoring Period
WSA	k	2.37	2.25	2.14	2.17	2.35	2.39	2.03	2.15	1.78	1.94	2.01
	c	3.99	4.30	3.87	3.44	3.24	3.15	2.45	3.97	3.68	3.91	3.59
	mean (m/s)	3.52	3.80	3.41	3.02	2.86	2.78	2.14	3.50	3.25	3.45	3.17
Location 1	k	2.77	2.31	2.06	2.17	2.38	2.34	1.96	2.27	1.45	2.69	1.96
	c	2.36	2.73	2.94	2.37	2.24	2.05	1.71	2.20	2.52	2.47	2.36
	mean (m/s)	2.09	2.40	2.58	2.08	1.97	1.80	1.48	1.91	2.25	2.16	2.07
Location 2	k	2.36	2.28	1.96	2.14	2.20	2.28	2.00	1.93	1.68	2.20	1.95
	c	2.93	2.93	2.74	2.38	2.21	2.10	1.61	2.56	2.29	2.86	2.41
	mean (m/s)	2.58	2.58	2.41	2.09	1.95	1.85	1.40	2.23	2.01	2.51	2.12
Location 3	k	2.60	2.21	2.22	2.36	2.44	2.42	2.07	2.02	1.49	2.20	2.01
	c	2.07	2.66	2.78	2.35	2.25	2.18	1.73	2.40	2.48	2.42	2.35
	mean (m/s)	1.83	2.34	2.44	2.06	1.97	1.90	1.48	2.07	2.20	2.12	2.05

Table 31: Monthly calculated Weibull shape & scale factors for all locations

From table 31 it can be seen that the mean values for (k) for the monitoring period are relatively closely distributed ($k=1.95$ to $k=2.01$) and that these are themselves slightly higher than the value suggested by the Met Office of $k=1.8$. Indeed, the mean k-values for the WSA location and Location 3 ($k=2.01$) are very close to a Rayleigh distribution ($k=2$). However, observed on a monthly basis (k) varies more significantly from a minimum of $k=1.45$ to a maximum of $k=2.77$. The range for the monthly values of (k) and (c) during the monitoring period for the different locations was as follows:

Location	Distribution (k)	Range (k)	Distribution (c)	Range (c)
WSA	1.78 - 2.39	0.61	2.45 - 4.30	1.85
Location 1	1.45 - 2.77	1.32	1.71 - 2.94	1.23
Location 2	1.68 - 2.36	0.68	1.61 - 2.93	1.32
Location 3	1.49 - 2.60	1.11	1.73 - 2.78	1.05

Table 32: Distribution and range of Weibull shape & scale factors for all locations

From these data (table 32) it can be seen that the rank order of (k) and (c) values for the 4 no. locations are different. The measured ranges for (c) differ from those suggested by the CT Tool (section 6.1.1) where, using a (k) value of 1.8, for the WSA site $c=4.06$ and for the monitoring locations $c=0.7$.

It is suggested here that the findings from this analysis could be used to help to determine scaling factors for (k) for urban locations where the turbine hub height is below canopy level. Brown et al state that "*the use of scaling factors for the Weibull shape factor has the potential to improve wind speed predictions*"³⁰⁹. From the work undertaken here it is suggested that the c-value should be considered in future work in addition to the k-value, as this also contributes to the understanding of the wind distribution for a given site. However, further analysis of monitored wind data from other similar locations should be undertaken to provide a larger sample. Given the current very limited availability of this type of data, such an analysis is suggested as further work. The spreadsheet used for the calculations in this section is supplied on the appendix data CD with summary data for each location.

³⁰⁹ Brown, H., Hailes, D., Rhodes, M., *Warwick Wind Trials – Final Report*, Encraft (2009), page 33

6.2.3 Summary of Wind Speed Data Analysis

Mean wind speeds (for the monitoring period) recorded at the 3 no. monitoring locations were in the range 2.05 m/s – 2.12 m/s. Table 33 compares the monitored mean wind speed data for the WSA location and the column locations with the other data sources identified in Chapter 5.

Mean Wind Speed			
Data Source	<i>Measured Cardiff Area Data</i>		
Windfinder (Cardiff Airport)	4.51 m/s at 10m		
<i>Measured Locale Specific Data</i>			
WSA Weather Station	3.16 m/s at 27m		
Celik Average (Tal-y-bont)	2.66 m/s at 10m		
<i>Estimated Annual Mean Wind Speed for Locations</i>			
Data Source	Case Study Location	WSA Location	
NOABL Database	5.2 m/s for 10m	5.0 m/s for 25m	
NCIC Database	N/A	N/A	
EST	2.5 m/s for 10m	2.4 m/s for 10m*	
Carbon Trust (High H+D)	0.7 m/s for 10m	3.6 m/s for 27m	
<i>Monitored Annual Mean Wind Speed for Locations</i>			
Location	Mean	Max	Min
Column Location 1	2.07 m/s at 10m	10.81 m/s	0.11 m/s
Column Location 2	2.12 m/s at 10m	8.91 m/s	0.15 m/s
Column Location 3	2.05 m/s at 10m	9.97 m/s	0.09 m/s

* Modification of height not available

Table 33: Comparison of measured data with other data sources

Figure 89 presents the results of table 32 as a graph.

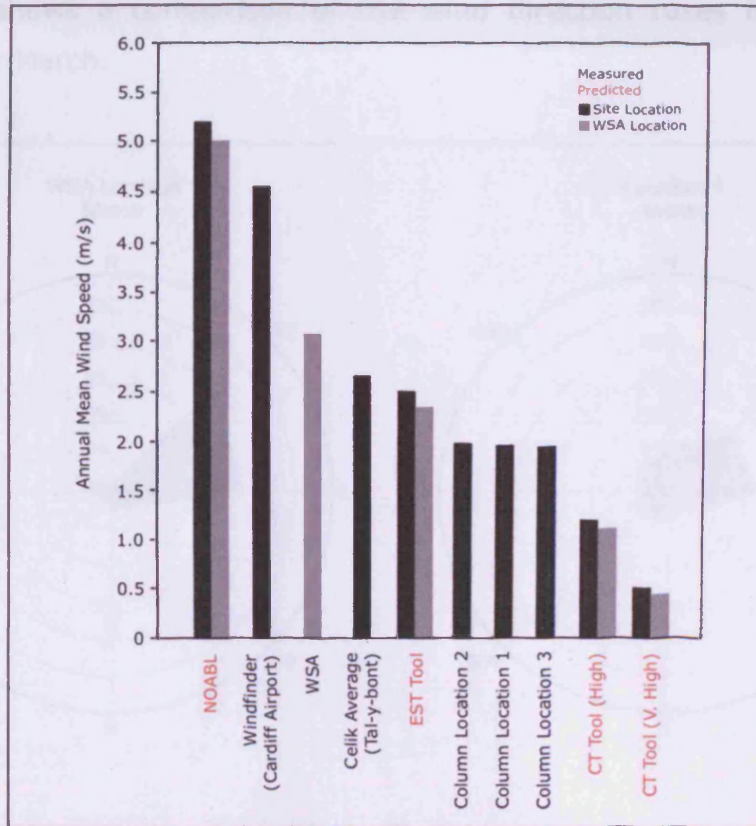

Figure 89: Comparison of monitored and estimated wind speeds

The monitored wind speeds at the column locations were significantly greater than the estimated wind speed from the CT Tool and were closest in comparison to the estimated wind speed from the EST Tool (2.5 m/s). The CT Tool gives a relatively close estimate of the wind speed measured at the WSA station at 27m. The NOABL database significantly over-estimated both.

From the wind speed analysis and the literature review, it was apparent that wind direction was also an important factor in the understanding of the urban wind regime. The following sections present a comparison of monitored wind direction data for the WSA location and the 3 no. column locations.

Figure 90: Comparison of Wind Direction for Locations of Interest

The prevailing wind direction recorded for Cardiff at the WSA station was SE. This is also shown in the data for column locations 1 and 2. However, column 2 shows a strong directional wind blowing wind direction of 4...

6.2.4 Analysis and Comparison of Mean Wind Direction Data

Figure 90 shows a comparison of the wind direction roses for the 4 no. locations for March.

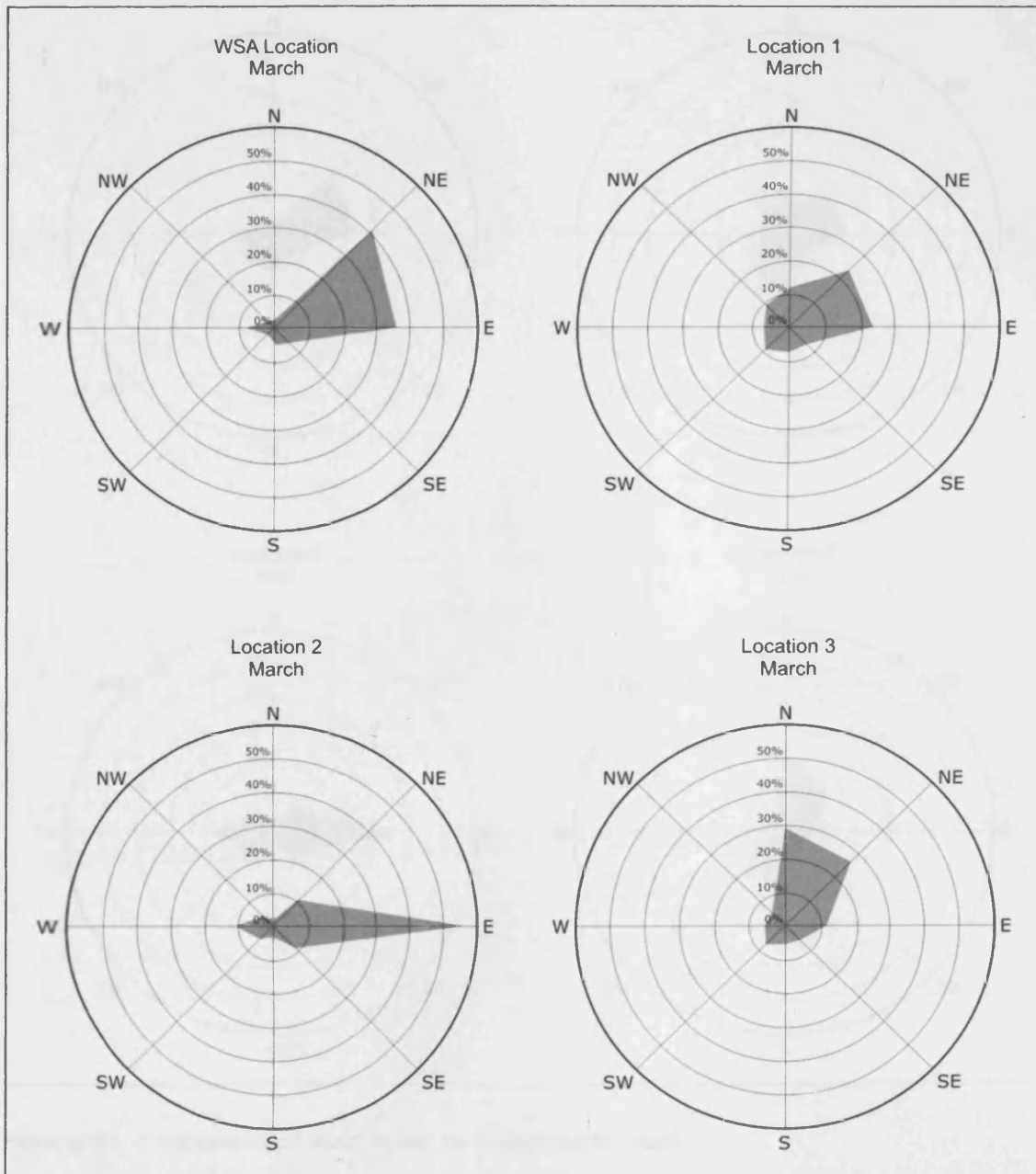

Figure 90: Comparison of Wind Roses for Locations for March

The prevailing wind direction recorded for March at the WSA station was NE. This is also shown in the data for column locations 1 and 3. However, location 2 shows a strong directionality with a prevailing wind direction of E.

Figure 91 shows a comparison of the wind direction roses for the 4 no. locations for April.

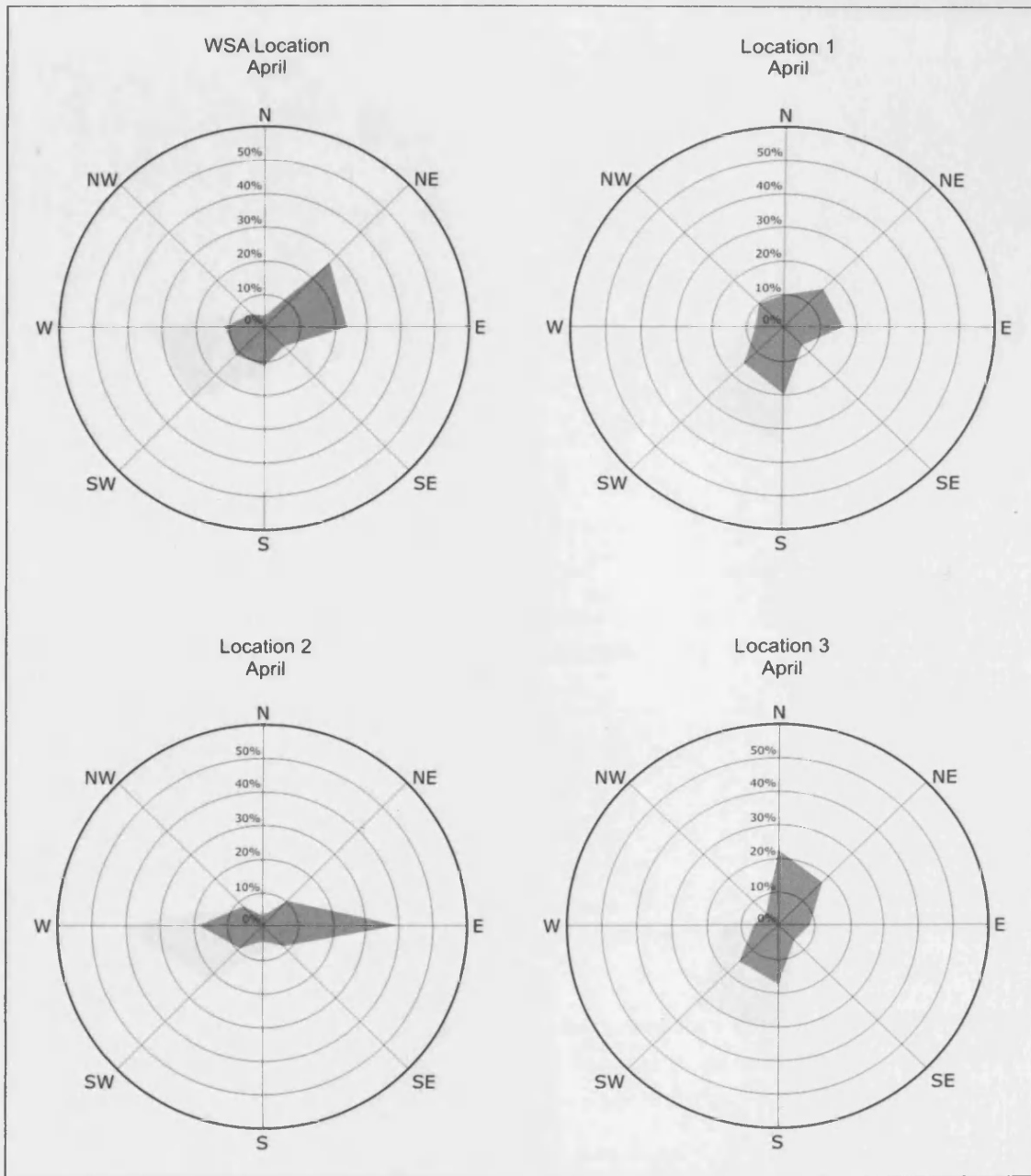

Figure 91: Comparison of Wind Roses for Locations for April

For April, the prevailing wind direction recorded by the WSA station was NE. Column location 1 was distributed between NE and S, while location 3 was distributed between N, NE and S. Column location 2 again shows a strong directionality, with E being the prevailing wind direction at this location.

SW is strong secondary direction.

Figure 92 shows a comparison of the wind direction roses for the 4 no. locations for May.

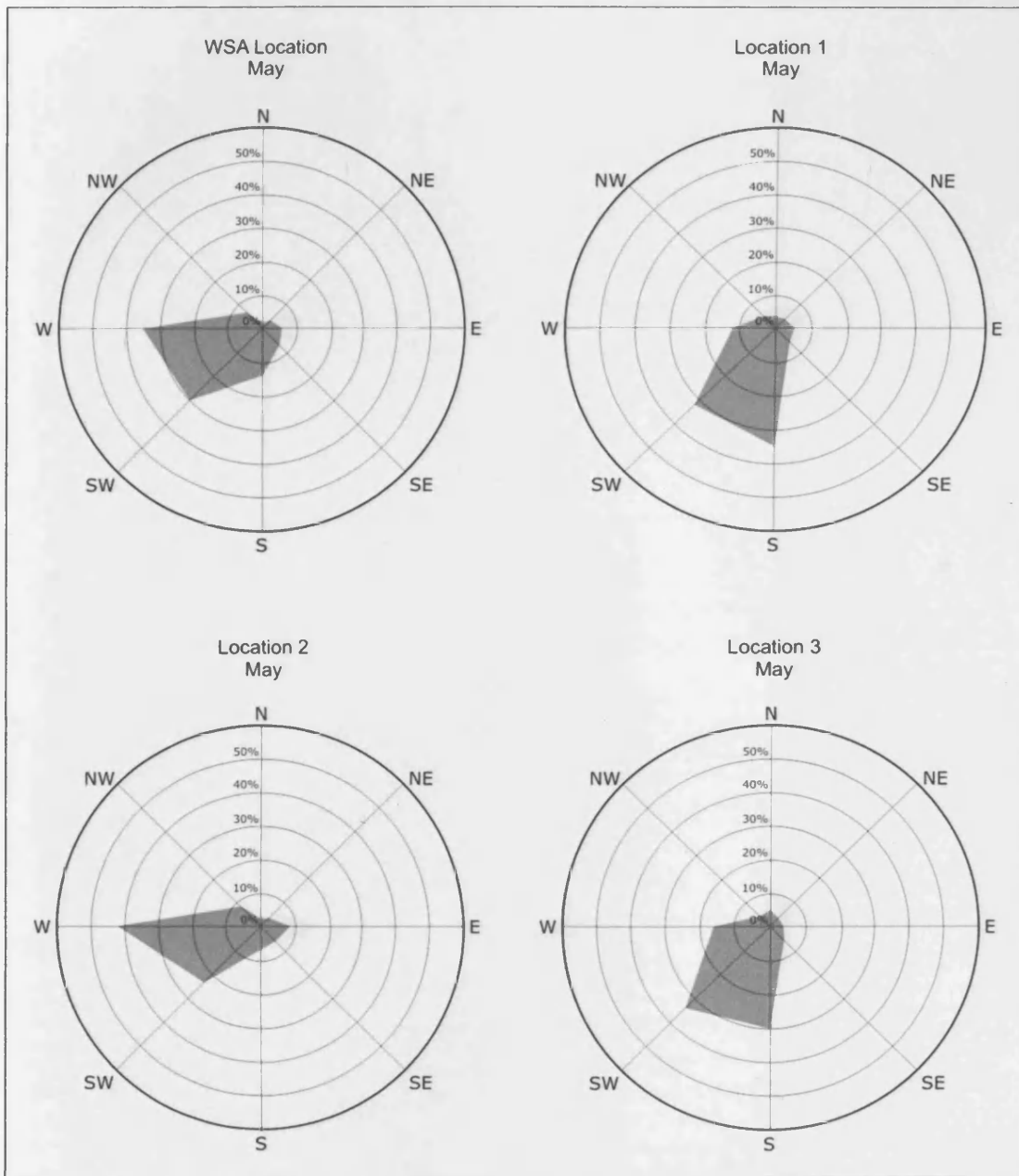

Figure 92: Comparison of Wind Roses for Locations for May

For May, the prevailing wind direction recorded by the WSA station was W with a strong secondary direction of SW. Column locations 1 and 3 show a more S and SW prevailing direction respectively. Column location 2 again shows a strong directionality, with W being the prevailing wind direction and SW a strong secondary direction.

Figure 93 shows a comparison of the wind direction roses for the 4 no. locations for June.

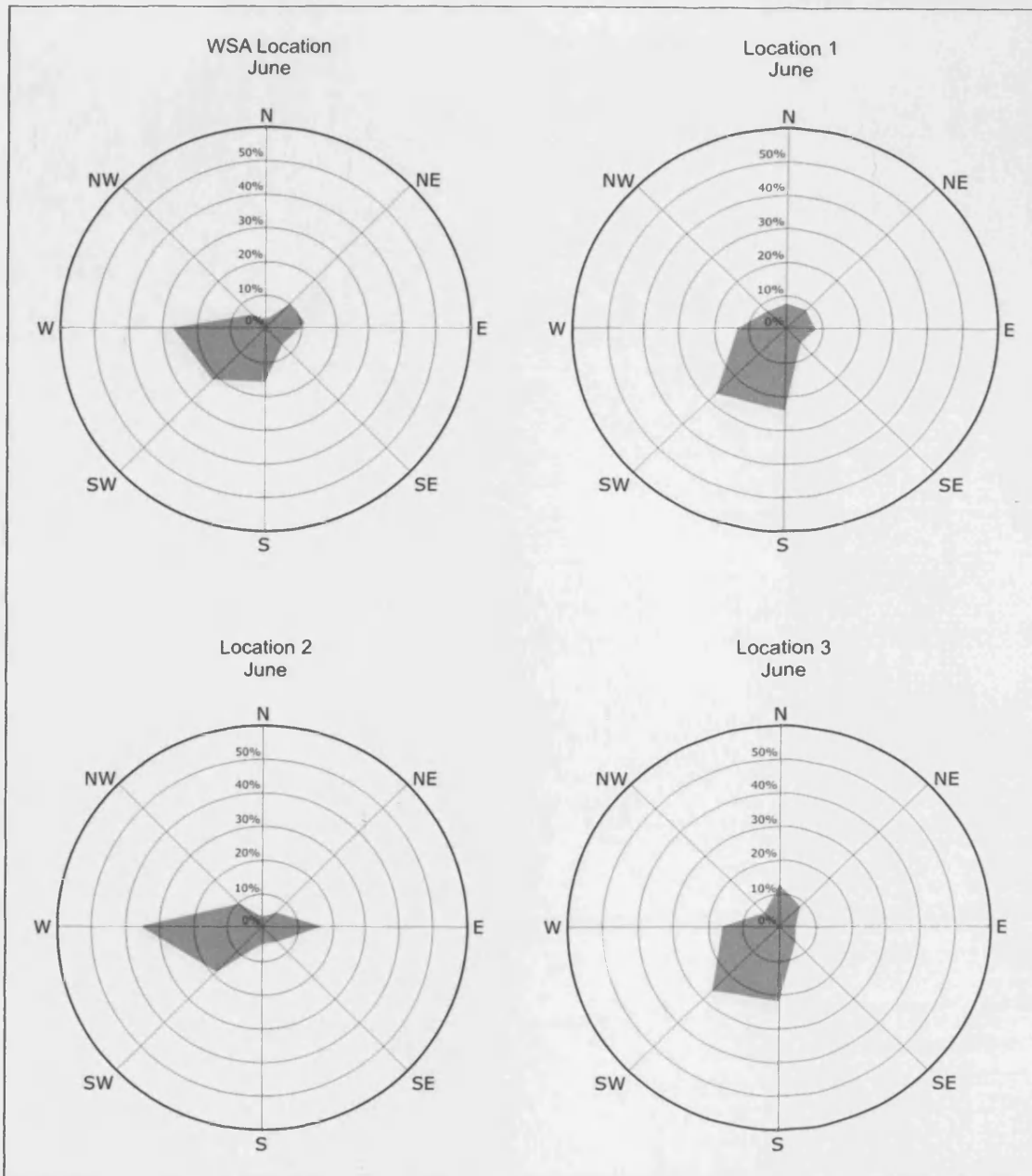

Figure 93: Comparison of Wind Roses for Locations for June

For June, the prevailing wind direction recorded by the WSA station was W with a strong secondary direction of SW. Column locations 1 and 3 both show a more SW prevailing direction than the WSA station. Column location 2 again shows a strong directionality, with W being the prevailing wind direction and SW the secondary direction.

Figure 94 shows a comparison of the wind direction roses for the 4 no. locations for July.

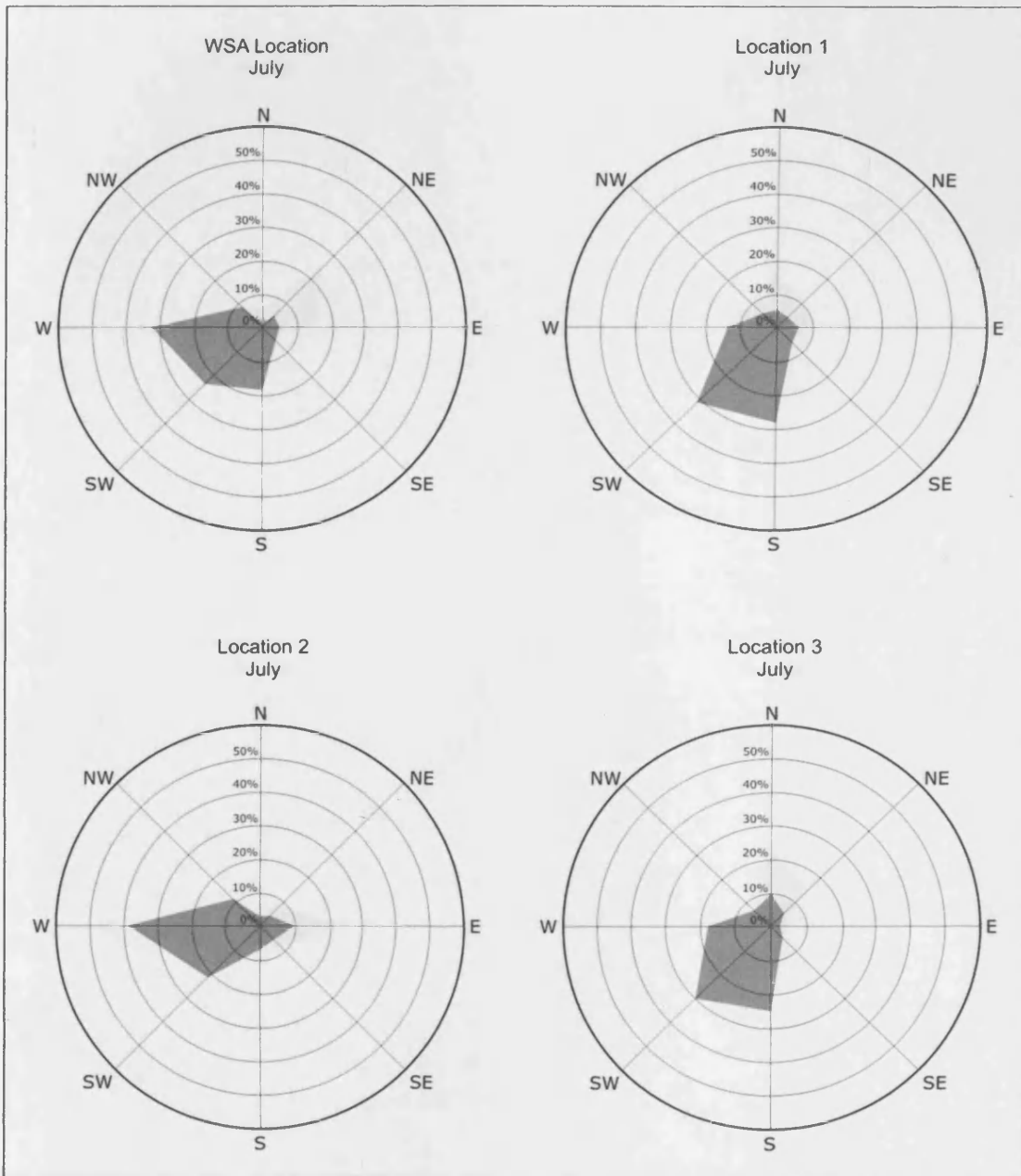

Figure 94: Comparison of Wind Roses for Locations for July

For July, the prevailing wind direction recorded by the WSA station was W with a strong secondary direction of SW. Column locations 1 and 3 both show a more SW prevailing direction than the WSA station. Column location 2 again shows a strong directionality, with W being the prevailing wind direction and SW a strong secondary direction.

Figure 95 shows a comparison of the wind direction roses for the 4 no. locations for August.

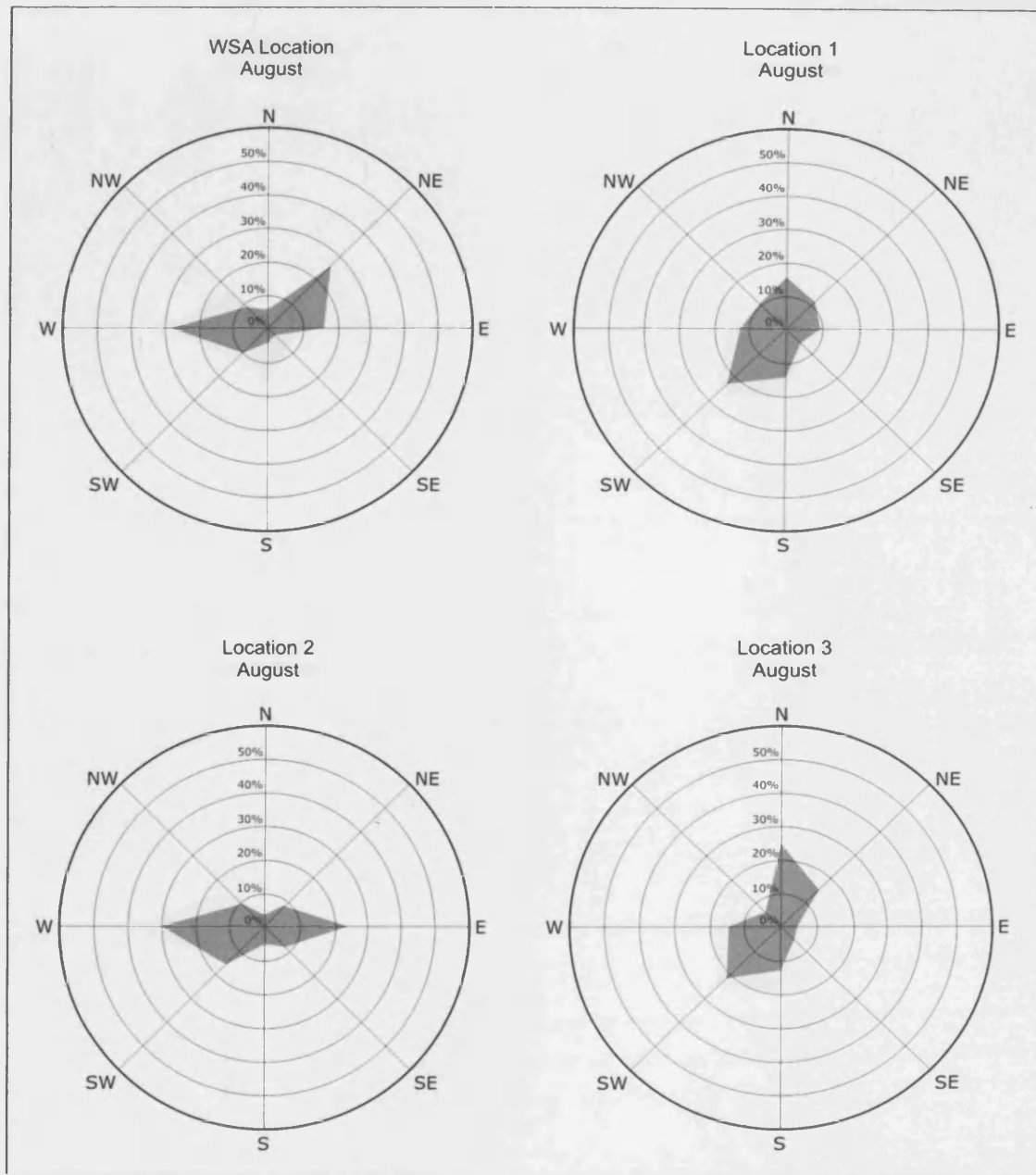

Figure 95: Comparison of Wind Roses for Locations for August

For August, the prevailing wind direction recorded by the WSA station was W with a strong secondary direction of NE. Column locations 1 and 3 both show a more N prevailing direction than the WSA station and both have a strong secondary direction of SW. Column location 2 again shows a strong directionality, with W being the prevailing wind direction and E a strong secondary direction.

Figure 96 shows a comparison of the wind direction roses for the 4 no. locations for September.

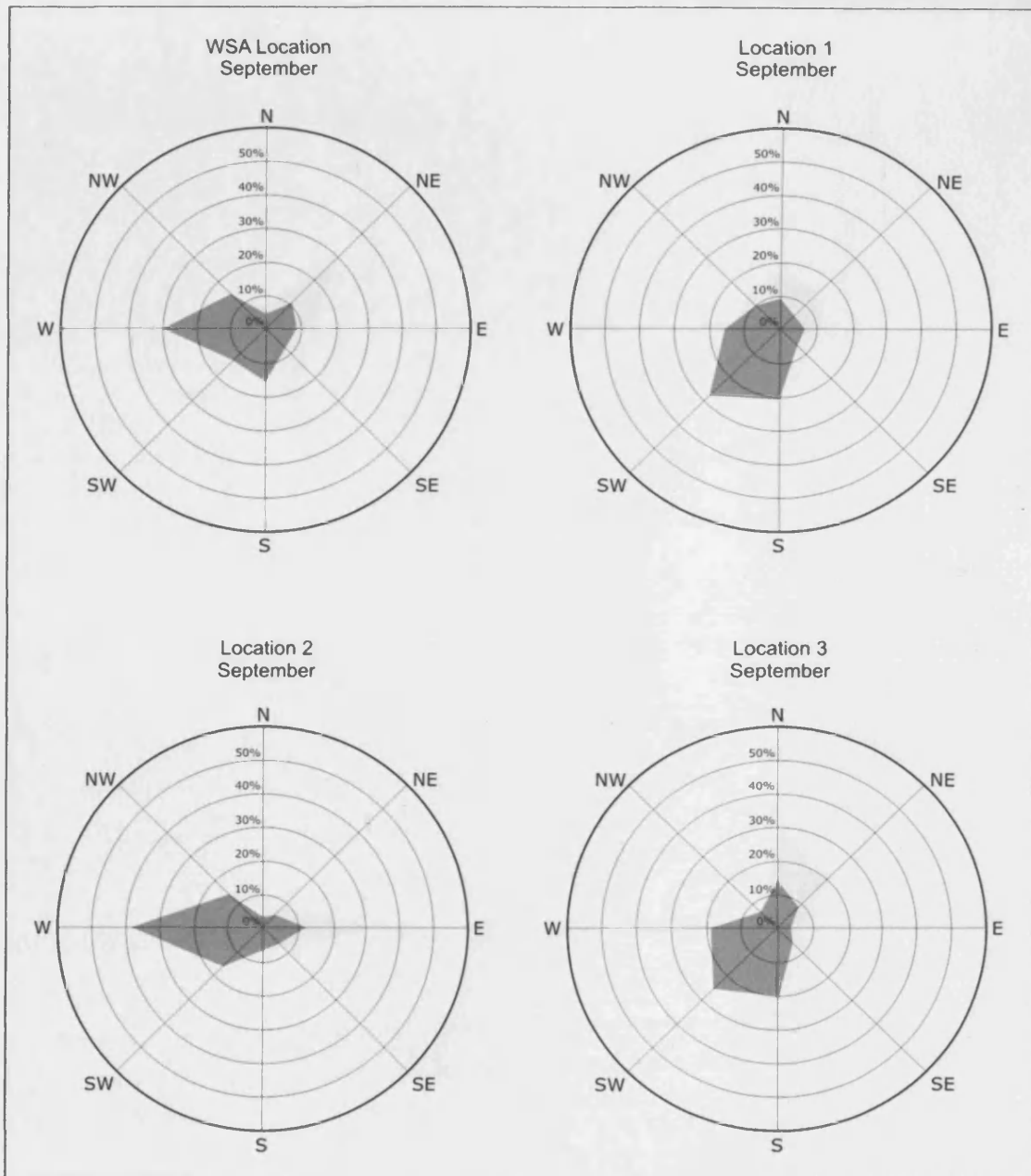

Figure 96: Comparison of Wind Roses for Locations for September

For September, the prevailing wind direction recorded by the WSA station was W with a strong secondary direction of S. Column locations 1 and 3 both show a more SW prevailing direction than the WSA station. Column location 2 again shows a strong directionality, with W being the prevailing wind direction and SW a strong secondary direction.

Figure 97 shows a comparison of the wind direction roses for the 4 no. locations for October.

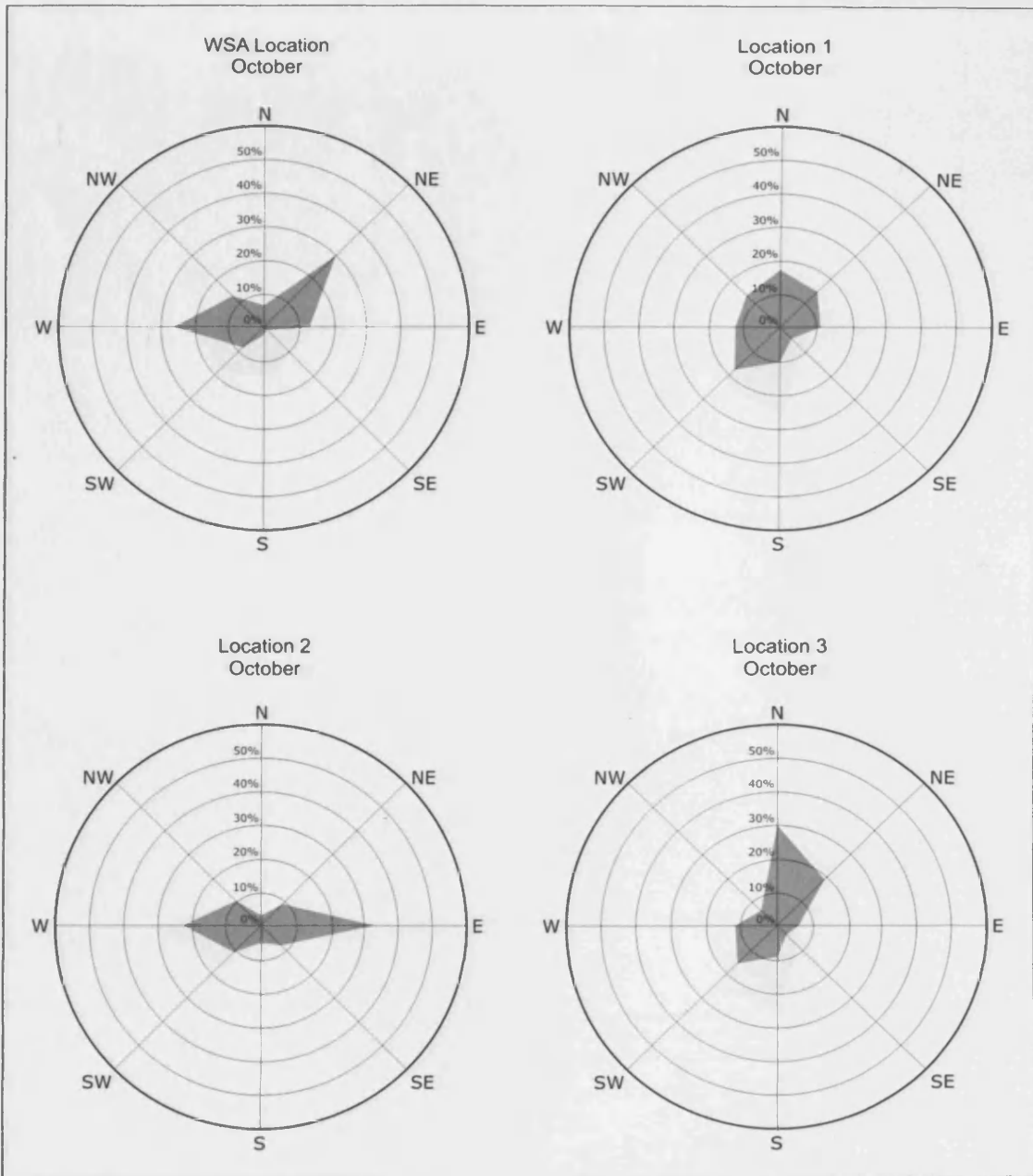

Figure 97: Comparison of Wind Roses for Locations for October

For October, the prevailing wind direction recorded by the WSA station was W with a strong secondary direction of SW. Column locations 1 and 3 both show a more SW prevailing direction than the WSA station. Column location 2 again shows a strong directionality, with E being the prevailing wind direction and W a strong secondary direction.

Figure 98 shows a comparison of the wind direction roses for the 4 no. locations for November.

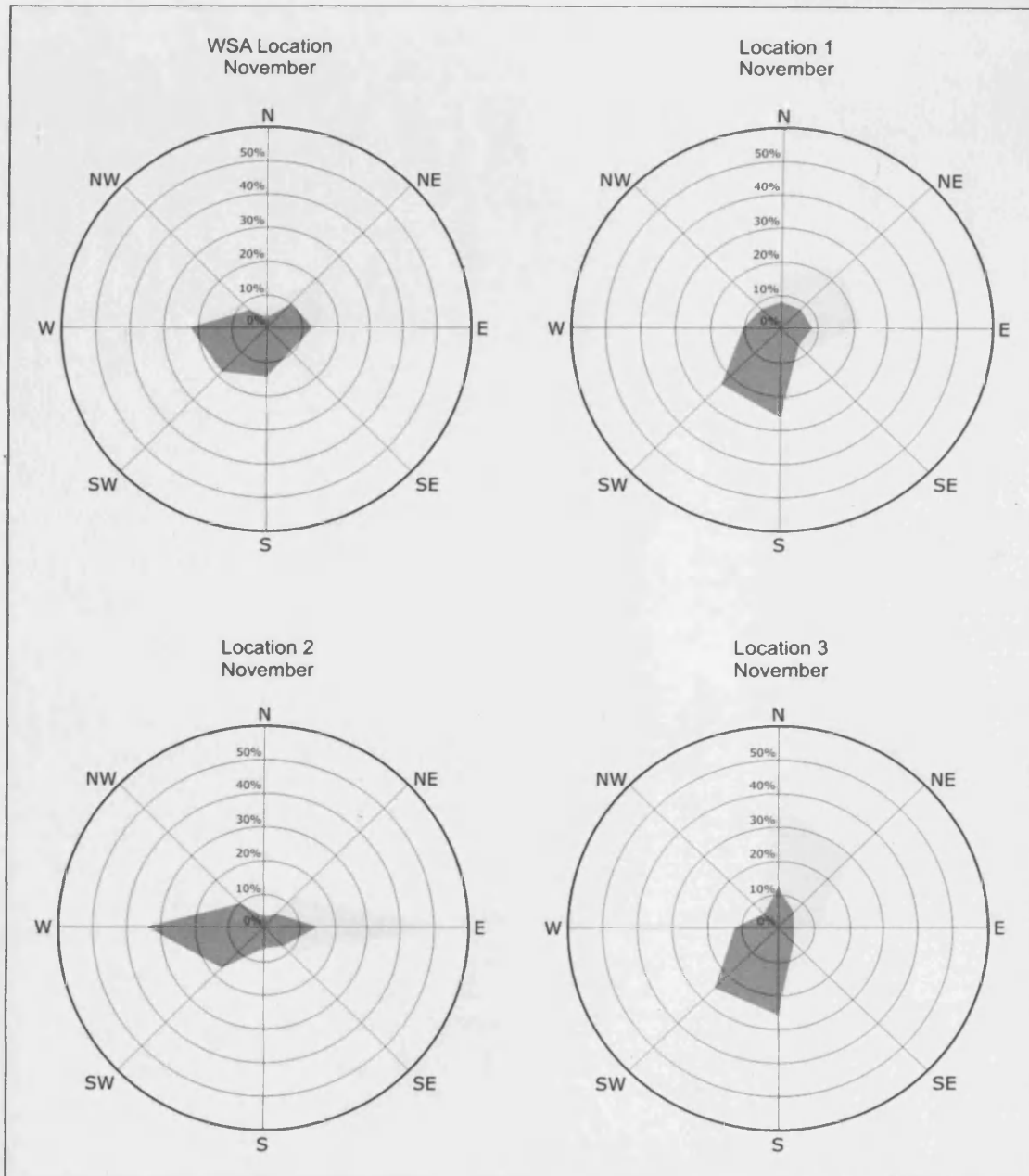

Figure 98: Comparison of Wind Roses for Locations for November

For November, the prevailing wind direction recorded by the WSA station was W with a secondary direction of SW. Column locations 1 and 3 both show a more S prevailing direction than the WSA station, with a secondary direction of SW. Column location 2 again shows a strong directionality, with W being the prevailing wind direction and SW a strong secondary direction.

Figure 99 shows a comparison of the wind direction roses for the 4 no. locations for December.

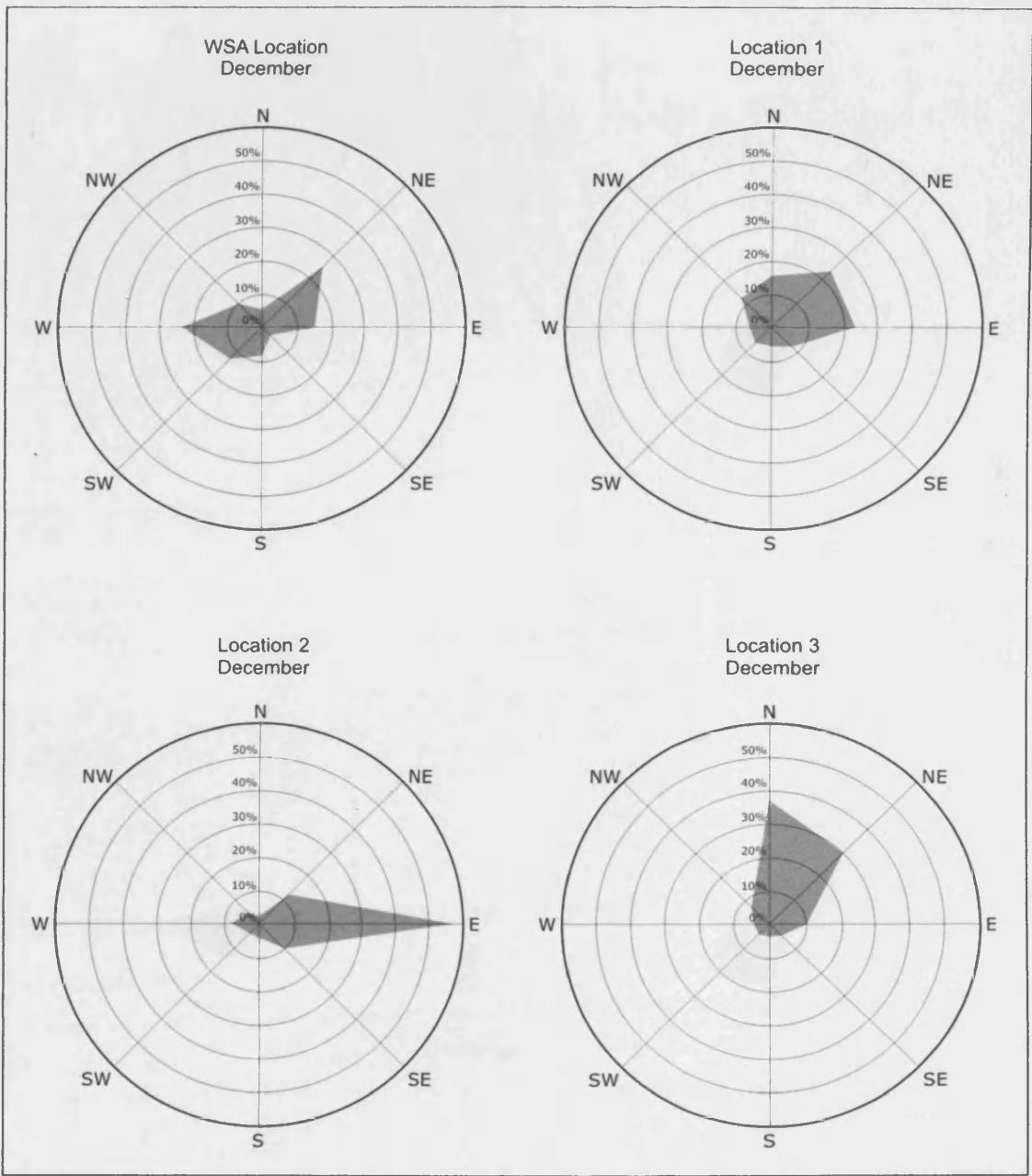

Figure 99: Comparison of Wind Roses for Locations for December

For December, the prevailing wind direction recorded by the WSA station was NE with a strong secondary direction of W. Column location 1 also showed a prevailing wind direction of NE with a secondary direction of E, while column 3 showed a more N prevailing direction than the WSA station. Column location 2 again shows a very strong directionality, with E being the prevailing wind direction.

Figure 100 shows a comparison of the annual wind direction roses for the 4 no. locations.

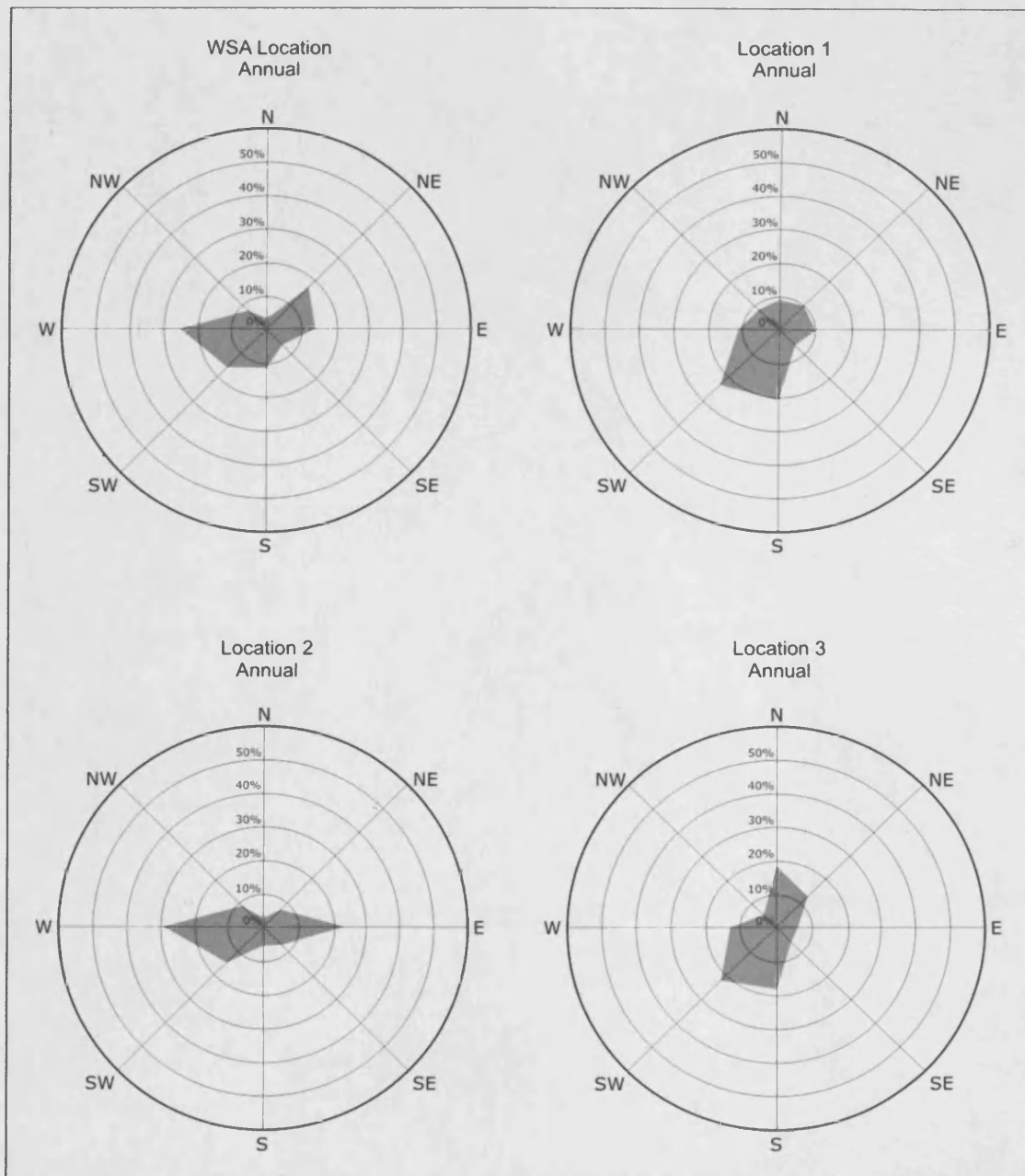

Figure 100: Annual wind direction roses from measured data

From the annual wind direction roses, the directionality of location 2 is apparent, with W being the prevailing wind direction and E being the strong secondary direction. Column locations 1 and 3 are generally more N / S orientated than either the WSA station or column 2. The WSA station shows a strong W prevailing wind direction with secondary directions of NE and SW.

6.2.5 Summary of Wind Direction Data Analysis

Wind direction data from the WSA weather station exhibit a prevailing W wind direction, with strong secondary NE and SW directions. The W direction is particularly apparent in May, June and July and the NE direction is particularly apparent in March, April and December. Column location 2 (mouth of the Greyfriars Road 'canyon') exhibits a strong W / E directionality in both the annual and the monthly wind direction data, which is not evident in the wind roses for the other locations. This could be evidence that the surrounding 'canyon' geometry is influencing the wind direction regime in this location and promoting a funnelling effect or parallel flow regime. Column locations 1 and 2 exhibit a more N / SW directionality compared with the WSA weather station, perhaps reflecting the more open (obstruction free) aspects in these directions for these locations (figure 101).

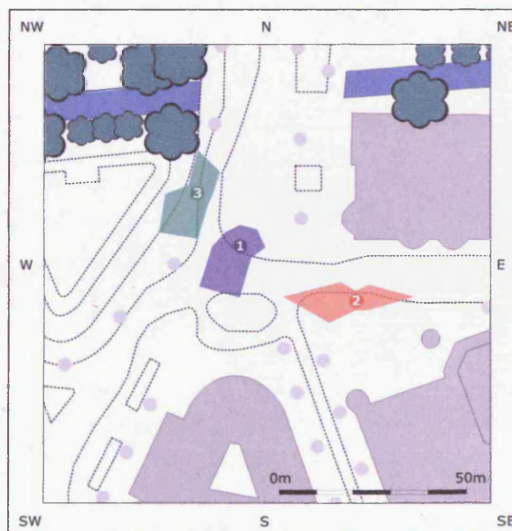

Figure 101: Qualitative comparison of wind roses for column locations

Others, such as Phillips et al³¹⁰, have suggested that site characteristics, including prevailing wind direction and, to an extent, obstacle shading, can be qualitatively assessed by the observation of wind roses, as has been attempted in this summary. Best et al have explored the possibility of using the MCP method (discussed in Chapter 4) to quantitatively estimate wind frequency distribution using wind roses to compare observed and predicted data, however the accuracy of the results was inconclusive³¹¹.

³¹⁰ Phillips, R. et al, *Micro-wind turbines in urban environments*, HIS BRE Press, 2007, page 16

³¹¹ Best, M. et al, *Small Scale Wind Technical Report*, Met Office, 2008, page 40

6.3 Estimating Energy Yields Using the Measured Data

In this section the potential energy yields available from the 12 no. turbines according to the measured data for the 3 no. column locations are calculated. In each case the percentage total energy load met by each turbine type is considered. For comparison, the potential energy resource is also calculated for the WSA location, where similar measured data were available.

The analysis in this section is to establish what percentage of the annual load requirement of the street lighting system can be met from the energy yields of the 12 no. turbine types.

6.3.1 Monitoring Period Energy Yield Totals

Table 34 shows the annual energy yield estimated for the site locations and the WSA location using the CT tool, together with the calculated annual energy yield from monitored data. The monitored data was simply extrapolated from 10 months to 12 months using an appropriate percentage factor for the number of missing days. The wind speed data collected at the WSA location for the months of January and February suggests that relatively high wind speeds were present in these months. Therefore, the figures shown in the table for the case study locations are likely to be an under-estimation because December and January are potentially windier months.

Turbine Type	CT Tool Site kWh/year	Location 1 kWh/year	Location 2 kWh/year	Location 3 kWh/year	CT Tool WSA kWh/year	WSA Location kWh/year
Ampair: 100	0	8.55	8.60	7.10	70	40.23
Ampair: 300	0	10.28	9.59	8.54	114	55.59
Ampair: 600	0	77.27	85.62	71.37	595	350.58
Eclectic: D400	0	96.20	109.12	92.30	460	330.66
Marlec: Rutland 1803-2	0	34.65	38.67	32.01	312	157.98
Marlec: Rutland 913	0	37.33	41.52	35.93	265	120.34
Renewable Devices: Swift	0	86.16	94.10	77.75	794	450.44
SW Windpower: Air X	0	19.65	21.66	17.51	191	117.61
SW Windpower: Whisper 100	0	73.65	86.34	68.26	564	356.00
Windside: WS015	0	1.91	2.16	1.69	18	9.95
Windside: WS030B	0	7.57	8.22	7.16	42	26.47
Windside: WS2B	2	62.82	61.83	61.21	228	152.80

Table 34: Comparison of annual energy yield estimations (kWh)

A further analysis between the calculated energy yields from the monitored data and the energy yields estimated by the CT Tool is presented in section 6.3.2, that examines the variance between the outputs.

6.3.2 Analysis of Yields Predicted During Monitoring Period

The following tables show the monitoring period energy yield totals for each of the 4 locations and the 12 turbine types. For each location the turbines are listed in order of energy output (kWh), while a ranking of capacity factor is also provided. The % power delivered is based upon a total load of 325.2 kWh for the monitoring period. The estimated energy yield was calculated using power curves derived from manufacturers' data for each turbine type. The WSA location is included in this analysis as a reference location (the WSA location itself would not be suitable for street lighting as it is on the roof of a building).

Turbine Type	Calculated (kWh) Monitoring Period	% Power Delivered Monitoring Period	Turbine Rated Energy Output	Total Capacity Monitoring Period	Capacity Factor Monitoring Period	CF Rank Order
Renewable Devices: Swift	334.43	102.84%	1500w	9756	3.43%	8
SW Windpower: Whisper 100	264.32	81.28%	900w	5853.6	4.52%	7
Ampair: 600	260.29	80.04%	600w	3902.4	6.67%	4
Eclectic: D400	245.51	75.49%	400w	2601.6	9.44%	2
Marlec: Rutland 1803-2	117.29	36.07%	340w	2211.36	5.30%	5
Windside: WS2B	113.45	34.89%	240w	1560.96	7.27%	3
Marlec: Rutland 913	89.35	27.48%	90w	585.36	15.26%	1
SW Windpower: Air X	87.32	26.85%	400w	2601.6	3.36%	9
Ampair: 300	41.27	12.69%	300w	1951.2	2.12%	11
Ampair: 100	29.87	9.19%	100w	650.4	4.59%	6
Windside: WS030B	19.65	6.04%	120w	780.48	2.52%	10
Windside: WS015	7.39	2.27%	120w	780.48	0.95%	12

Table 35: Energy yield totals for monitoring period – WSA Location

From table 35 the turbine predicted to produce the highest energy yield for the monitoring period is the Renewable Devices Swift (334.43kWh), that could more than meet the required load for the monitoring period. However, the capacity factor achieved by this turbine was relatively low (3.43%). Further analysis is provided later in this section for 3 day periods.

Table 36 shows a comparison of the calculated energy yield for the WSA location for the monitoring period with the predicted annual yield from the CT Tool (section 6.1.1). For the purposes of this analysis, the annual calculated energy yield was derived from the 271 day monitoring by simple extrapolation. It should be noted that this may have resulted in an under-estimation of the calculated annual energy yield because the mean wind speeds in January and February may be higher than those experienced during the monitoring period. However, it is not considered likely that this difference would fully explain the apparent over-estimation of energy yield by the CT Tool.

Turbine Type	Calculated Annual Yield (kWh)	CT Tool Predicted Annual Yield (kWh)	% Over-estimation by CT Tool
Renewable Devices: Swift	450	794	76%
SW Windpower: Whisper 100	356	564	58%
Ampair: 600	351	595	70%
Eclectic: D400	331	460	39%
Marlec: Rutland 1803-2	158	265	68%
Windside: WS2B	153	228	49%
Marlec: Rutland 913	120	312	160%
SW Windpower: Air X	118	191	62%
Ampair: 300	56	114	104%
Ampair: 100	40	70	75%
Windside: WS030B	26	42	62%
Windside: WS015	10	18	80%

Table 36: Comparison of energy yield from measured data with CT Tool prediction (WSA)

The over-estimation of energy yield by the CT Tool ranged from 39% (Eclectic D400) to 160% (Marlec Rutland 913). It should be noted that the CT Tool calculation is based on wind speed averages over a 30 year period from the NCIC database, while the monitoring period data represents the wind speeds experienced for 1 year. The significance of this is that the monitoring period data could be representative of a relatively calm year.

Turbine Type	Calculated (kWh) Monitoring Period	% Power Delivered Monitoring Period	Turbine Rated Energy Output	Total Capacity Monitoring Period	Capacity Factor Monitoring Period	CF Rank Order
Eclectic: D400	71.43	21.96%	400W	2601.6	2.75%	3
Renewable Devices: Swift	63.97	19.67%	1500W	9756	0.66%	9
Ampair: 600	57.37	17.64%	600W	3902.4	1.47%	4
SW Windpower: Whisper 100	54.68	16.81%	900W	5853.6	0.93%	7
Windside: WS2B	46.64	14.34%	240W	1560.96	2.99%	2
Marlec: Rutland 913	27.72	8.52%	90W	585.36	4.74%	1
Marlec: Rutland 1803-2	25.72	7.91%	340W	2211.36	1.16%	5
SW Windpower: Air X	14.59	4.49%	400W	2601.6	0.56%	10
Ampair: 300	7.64	2.35%	300W	1951.2	0.39%	11
Ampair: 100	6.35	1.95%	100W	650.4	0.98%	6
Windside: WS030B	5.62	1.73%	120W	780.48	0.72%	8
Windside: WS015	1.42	0.44%	120W	780.48	0.18%	12

Table 37: Energy yield totals for monitoring period – Location 1

From table 37 the turbine predicted to produce the highest energy yield for the monitoring period in location 1 is the Electric D400 (71.43kWh), which achieves 21.96% of the required load for the monitoring period at a capacity factor of 2.75%. Similar to the WSA location the turbine with the highest capacity factor for the monitoring period is the Marlec Rutland 913 (4.74%). The worst performing turbine according to this analysis is the Windside WS015, with both the lowest energy yield (1.42kWh) and the lowest capacity factor (0.18%).

Turbine Type	Calculated (kWh) Monitoring Period	% Power Delivered Monitoring Period	Turbine Rated Energy Output	Total Capacity Monitoring Period	Capacity Factor Monitoring Period	CF Rank Order
Eclectic: D400	81.02	24.91%	400w	2601.6	3.11%	2
Renewable Devices: Swift	69.86	21.48%	1500w	9756	0.72%	9
SW Windpower: Whisper 100	64.10	19.71%	900w	5853.6	1.10%	6
Ampair: 600	63.57	19.55%	600w	3902.4	1.63%	4
Windside: WS2B	45.91	14.12%	240w	1560.96	2.94%	3
Marlec: Rutland 913	30.83	9.48%	90w	585.36	5.27%	1
Marlec: Rutland 1803-2	28.71	8.83%	340w	2211.36	1.30%	5
SW Windpower: Air X	16.08	4.95%	400w	2601.6	0.62%	10
Ampair: 300	7.12	2.19%	300w	1951.2	0.36%	11
Ampair: 100	6.39	1.96%	100w	650.4	0.98%	7
Windside: WS030B	6.11	1.88%	120w	780.48	0.78%	8
Windside: WS015	1.60	0.49%	120w	780.48	0.21%	12

Table 38: Energy yield totals for monitoring period – Location 2

From table 38 the turbine predicted to produce the highest energy yield for the monitoring period in location 2 is again the Electric D400 (81.02kWh), which achieves 24.91% of the required load for the monitoring period at a capacity factor of 3.11%. Similar to the WSA location and location 1, the turbine with the highest capacity factor for the monitoring period is the Marlec Rutland 913 (5.27%). The worst performing turbine according to this analysis is again the Windside WS015, with both the lowest energy yield (1.60kWh) and the lowest capacity factor (0.21%).

Turbine Type	Calculated (kWh) Monitoring Period	% Power Delivered Monitoring Period	Turbine Rated Energy Output	Total Capacity Monitoring Period	Capacity Factor Monitoring Period	CF Rank Order
Eclectic: D400	68.53	21.07%	400w	2601.6	2.63%	3
RD: Swift	57.73	17.75%	1500w	9756	0.59%	9
Ampair: 600	52.99	16.29%	600w	3902.4	1.36%	4
SW: Whisper 100	50.68	15.58%	900w	5853.6	0.87%	6
Windside: WS2B	45.45	13.97%	240w	1560.96	2.91%	2
Marlec: Rutland 913	26.68	8.20%	90w	585.36	4.56%	1
Marlec: Rutland 1803-2	23.77	7.31%	340w	2211.36	1.07%	5
SW: Air X	13.00	4.00%	400w	2601.6	0.50%	10
Ampair: 300	6.34	1.95%	300w	1951.2	0.32%	11
Windside: WS030B	5.32	1.64%	120w	780.48	0.68%	8
Ampair: 100	5.27	1.62%	100w	650.4	0.81%	7
Windside: WS015	1.26	0.39%	120w	780.48	0.16%	12

Table 39: Energy yield totals for monitoring period – Location 3

From table 39 the turbine predicted to produce the highest energy yield for the monitoring period in location 3 is again the Electric D400 (68.53kWh), which achieves 21.07% of the required load for the monitoring period at a capacity factor of 2.63%. Similar to the WSA location, location 1 and location 2, the turbine with the highest capacity factor for the monitoring period is the Marlec Rutland 913 (4.56%). The worst performing turbine according to this analysis is again the Windside WS015, with both the lowest energy yield (1.26kWh) and the lowest capacity factor (0.16%).

A detailed comparison of calculated energy yields from the column location data with the CT Tool analysis is not necessary because the CT Tool predicted zero yield for 11 of the 12 turbine types. For the Windside WS2B, the annual energy yield predicted by the CT Tool was 2kWh while the extrapolated calculated annual energy yield for the 3 column locations ranges from 61kWh (location 3) to 63kWh (location 1). The highest extrapolated calculated annual energy yield was 109kWh (Eclectic D400 at location 2), representing an under-estimation by the CT Tool of 5500% (factor of 55).

By ranking the turbines by calculated energy yield for the monitoring period, 3 groupings can be identified, with some variation by location within each group. However, in general the 3 groupings remain consistent (table 40).

	Location 1	Location 2	Location 3	WSA Location
Good (>15%)	Eclectic: D400	Eclectic: D400	Eclectic: D400	RD: Swift
	RD: Swift	RD: Swift	RD: Swift	SW: Whisper 100
	Ampair: 600	SW: Whisper 100	Ampair: 600	Ampair: 600
	SW: Whisper 100	Ampair: 600	SW: Whisper 100	Eclectic: D400
Medium (5% -15%)	Windside: WS2B	Windside: WS2B	Windside: WS2B	Marlec: Rutland 1803-2
	Marlec: Rutland 913	Marlec: Rutland 913	Marlec: Rutland 913	Windside: WS2B
	Marlec: Rutland 1803-2	Marlec: Rutland 1803-2	Marlec: Rutland 1803-2	Marlec: Rutland 913
Poor (<5%)	Ampair: 300	Ampair: 300	Ampair: 300	Ampair: 300
	Ampair: 100	Ampair: 100	Windside: WS030B	SW: Air X
	SW: Air X	SW: Air X	SW: Air X	Ampair: 100
	Windside: WS030B	Windside: WS030B	Windside: WS030B	Windside: WS030B
	Windside: WS015	Windside: WS015	Windside: WS015	Windside: WS015

Table 40: Turbine ranking by energy yield for each location

Table 41 illustrates the contribution of each turbine type to the load calculated for the monitoring period, assuming a 150W lamp. The 4 turbine types in the top grouping of table 39 are shown to produce between 15.58% and 24.91% of the calculated load for the column locations and between 75.49% and 102.84% for the WSA location.

Location 1		Location 2		Location 3		WSA Location	
Key	% Energy Delivered Monitoring Period	Key	% Energy Delivered Monitoring Period	Key	% Energy Delivered Monitoring Period	Key	% Energy Delivered Monitoring Period
4	21.96%	4	24.91%	4	21.07%	7	102.84%
7	19.67%	7	21.48%	7	17.75%	9	81.28%
3	17.64%	9	19.71%	3	16.29%	3	80.04%
9	16.81%	3	19.55%	9	15.58%	4	75.49%
12	14.34%	12	14.12%	12	13.97%	5	36.07%
6	8.52%	6	9.48%	6	8.20%	12	34.89%
5	7.91%	5	8.83%	5	7.31%	6	27.48%
8	4.49%	8	4.95%	8	4.00%	8	26.85%
2	2.35%	2	2.19%	2	1.95%	2	12.69%
1	1.95%	1	1.96%	11	1.64%	1	9.19%
11	1.73%	11	1.88%	1	1.62%	11	6.04%
10	0.44%	10	0.49%	10	0.39%	10	2.27%

Key			
Ampair: 100	1	Renewable Devices: Swift	7
Ampair: 300	2	SW Windpower: Air X	8
Ampair: 600	3	SW Windpower: Whisper 100	9
Eclectic: D400	4	Windside: WS015	10
Marlec: Rutland 1803-2	5	Windside: WS030B	11
Marlec: Rutland 913	6	Windside: WS2B	12

Table 41: Contribution of turbines to load calculated for monitoring period (150W lamp)

Brown et al have found that capacity factors for small building mounted wind turbines in urban environments can be relatively low (<10%)³¹². With a range of between 0.16% and 5.27%, for the 3 column locations, the results of this analysis agree with these previous findings (table 42).

Location 1		Location 2		Location 3		WSA Location	
Key	Capacity Factor Monitoring Period	Key	Capacity Factor Monitoring Period	Key	Capacity Factor Monitoring Period	Key	Capacity Factor Monitoring Period
6	4.74%	6	5.27%	6	4.56%	6	15.26%
12	2.99%	4	3.11%	12	2.91%	4	9.44%
4	2.75%	12	2.94%	4	2.63%	12	7.27%
3	1.47%	3	1.63%	3	1.36%	3	6.67%
5	1.16%	5	1.30%	5	1.07%	5	5.30%
1	0.98%	9	1.10%	9	0.87%	1	4.59%
9	0.93%	1	0.98%	1	0.81%	9	4.52%
11	0.72%	11	0.78%	11	0.68%	8	3.36%
7	0.66%	7	0.72%	7	0.59%	7	3.43%
8	0.56%	8	0.62%	8	0.50%	11	2.52%
2	0.39%	2	0.36%	2	0.32%	2	2.12%
10	0.18%	10	0.21%	10	0.16%	10	0.95%

Key			
Ampair: 100	1	Renewable Devices: Swift	7
Ampair: 300	2	SW Windpower: Air X	8
Ampair: 600	3	SW Windpower: Whisper 100	9
Eclectic: D400	4	Windside: WS015	10
Marlec: Rutland 1803-2	5	Windside: WS030B	11
Marlec: Rutland 913	6	Windside: WS2B	12

Table 42: Turbine ranking by capacity factor for each location

³¹² Brown, H., Hailes, D., Rhodes, M., *Conclusions and empirical data from the first large scale public field trial of building-mounted micro-wind turbines*, EWEC, Marseilles, 16th - 19th March, 2009

Figure 102 indicates the relationship between energy yield and capacity factor for the 12 turbines and the 4 monitoring locations. The relationship is relatively scattered and a best fit line for each location indicates that there is a very limited relationship between energy yield rank and capacity factor, where between 23% and 34% (R^2) of the relationship can be explained by the best fit line (linear equation).

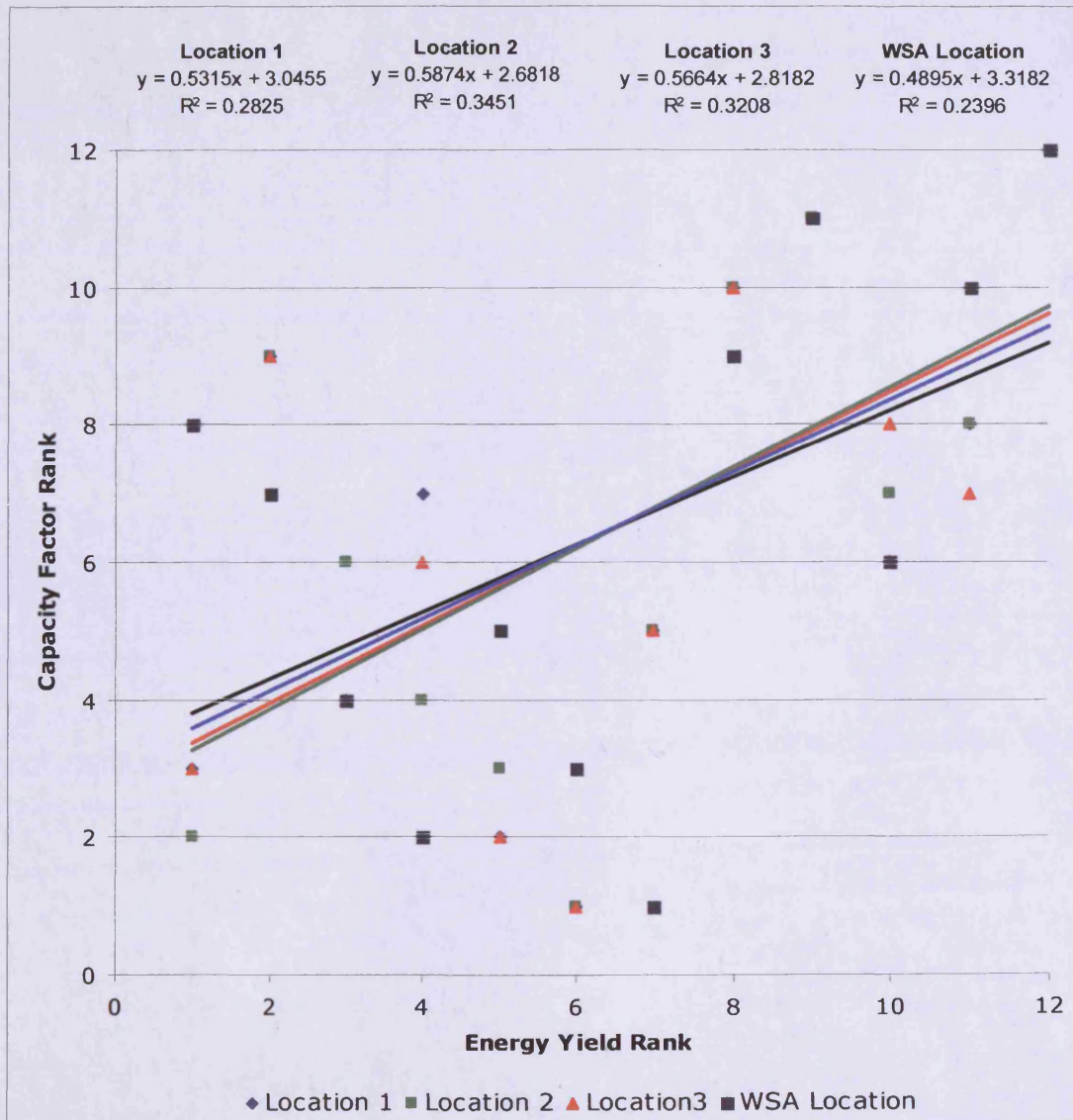

Figure 102: Relationship between energy yield rank and capacity factor

The following figures show the percentage load contribution made by each turbine type for periods of 3 days throughout the monitoring period. This is important because the hybrid street lighting system was designed to operate autonomously for periods of up to 3 days with no power generation. Figures 103 – 106 represent a 150W lamp load, while figures 107 – 110 represent a 60W lamp load, which is likely to be achievable in the near future with advances in low energy light sources.

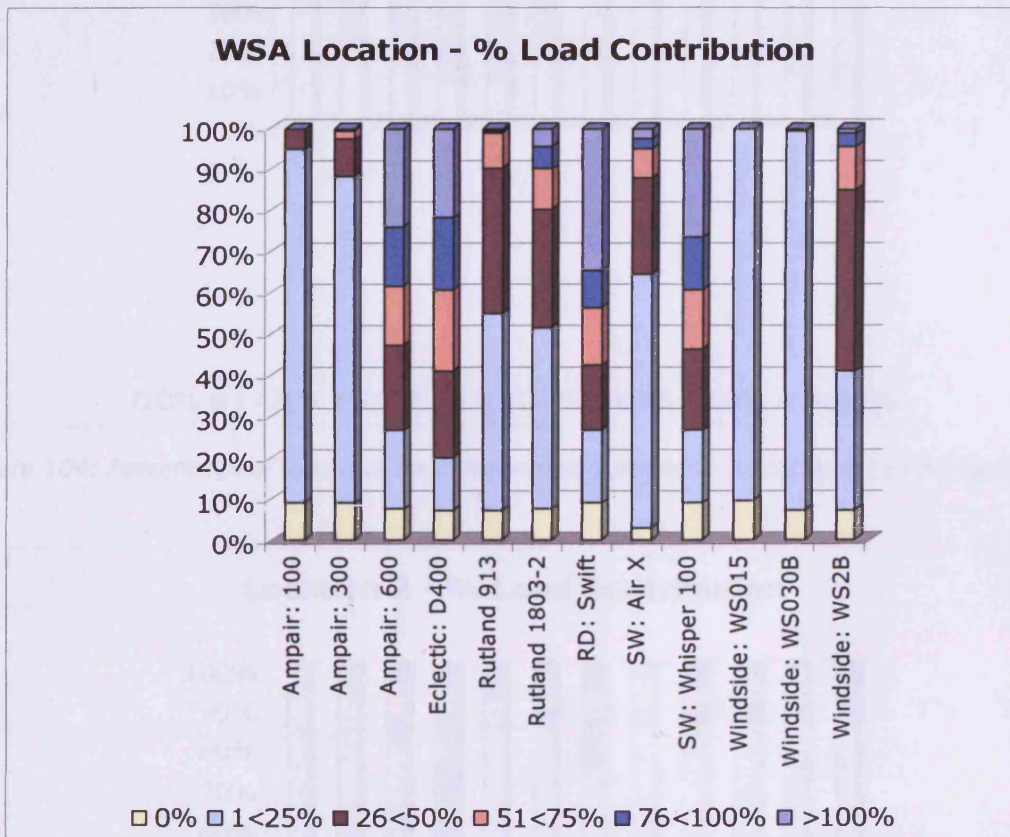

Figure 103: Percentage of load met for 3 day running periods (150W Lamp)

Figure 99 shows that for the WSA location, the RD Swift turbine meets 100% or more of the required load for 34.5% of the monitoring period. The following figures show the same analysis for each of the column locations.

Location 1 - % Load Contribution

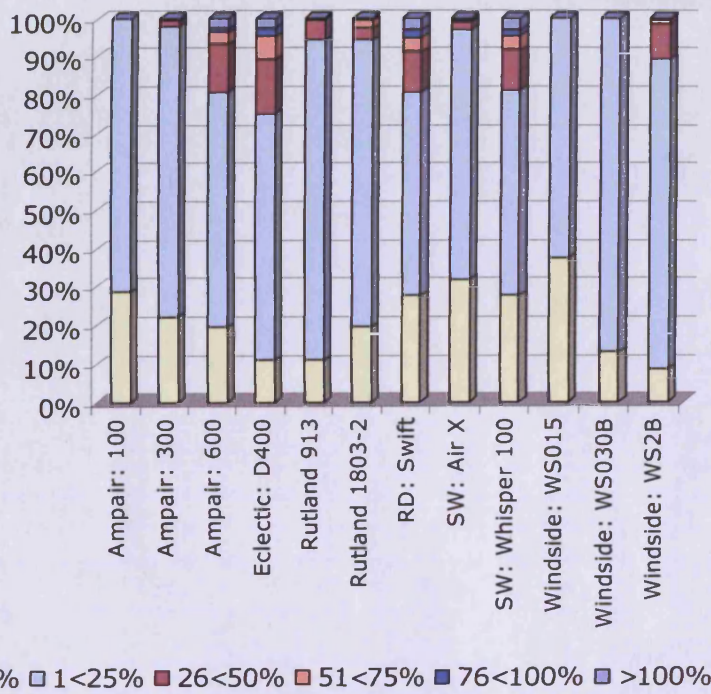

Figure 104: Percentage of load met for 3 day running periods – Location 1 (150W Lamp)

Location 2 - % Load Contribution

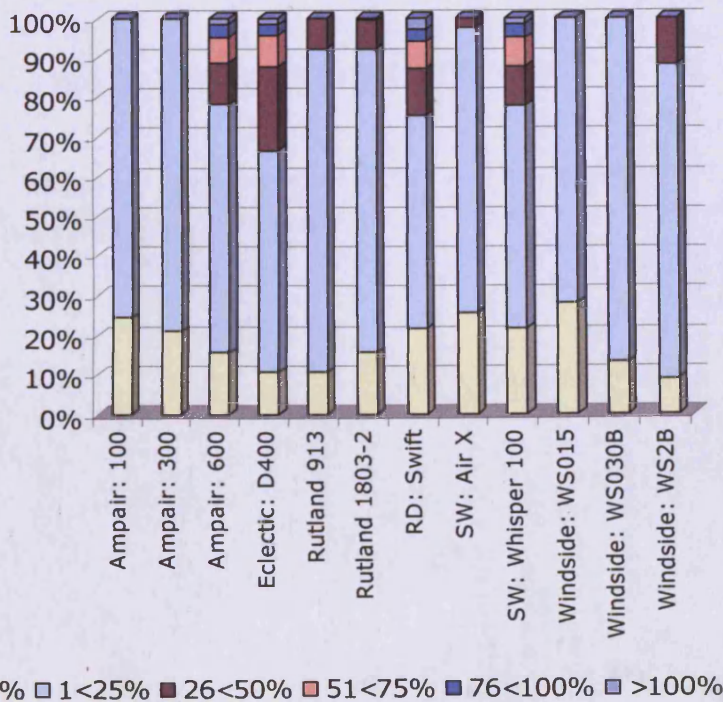

Figure 105: Percentage of load met for 3 day running periods – Location 2 (150W Lamp)

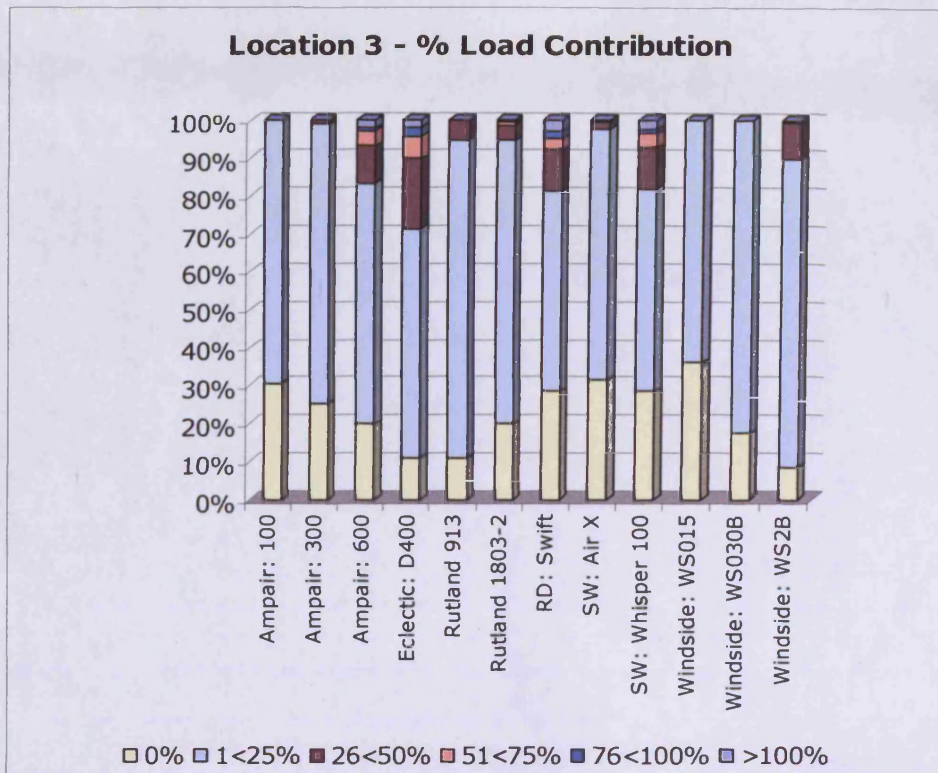

Figure 106: Percentage of load met for 3 day running periods – Location 3 (150W Lamp)

From the above analysis, it can be seen that all of the turbine types can contribute up to 25% towards the load for the majority of the time during the monitoring period. The Eclectic D400 turbine was shown to provide the highest yield for all 3 column locations from the energy yield analysis, and this turbine can contribute >25% towards the load for between 24.9% (location 1) and 33.4% (location 2) of the monitoring period. The Ampair 100, Windside WS015 and WS030B turbines never contribute >25% towards the load.

The following figures present the same analysis but for a 60W lamp load (for the reasons previously discussed). When the lamp load is reduced to 60W, the contribution of all the turbines towards meeting the load is obviously increased. Of particular interest is the Windside WS2B turbine, which has the lowest period of zero contribution in either analyses, reflecting the fact that this turbine has the lowest cut-in wind speed of any of the turbines listed (2.0 m/s). In low wind speed environments, turbines with lower cut-in speeds have the potential to generate power during a greater proportion of time. As loads decrease these lower levels of wind power generation become increasingly important.

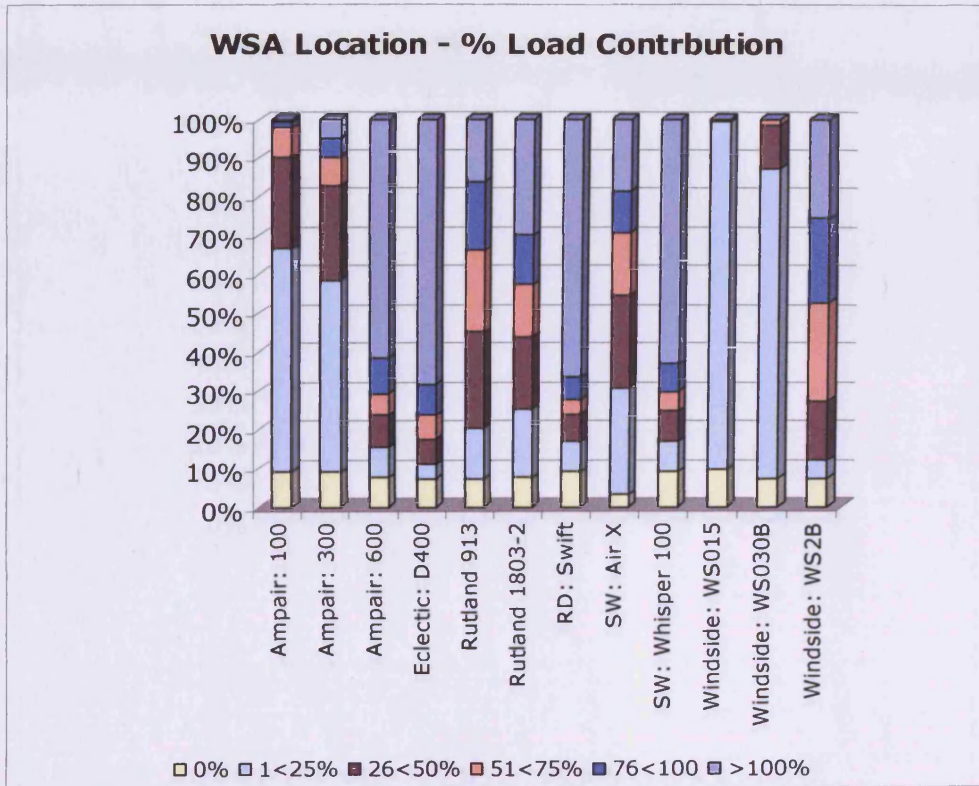

Figure 107: Percentage of load met for 3 day running periods – WSA Location (60W Lamp)

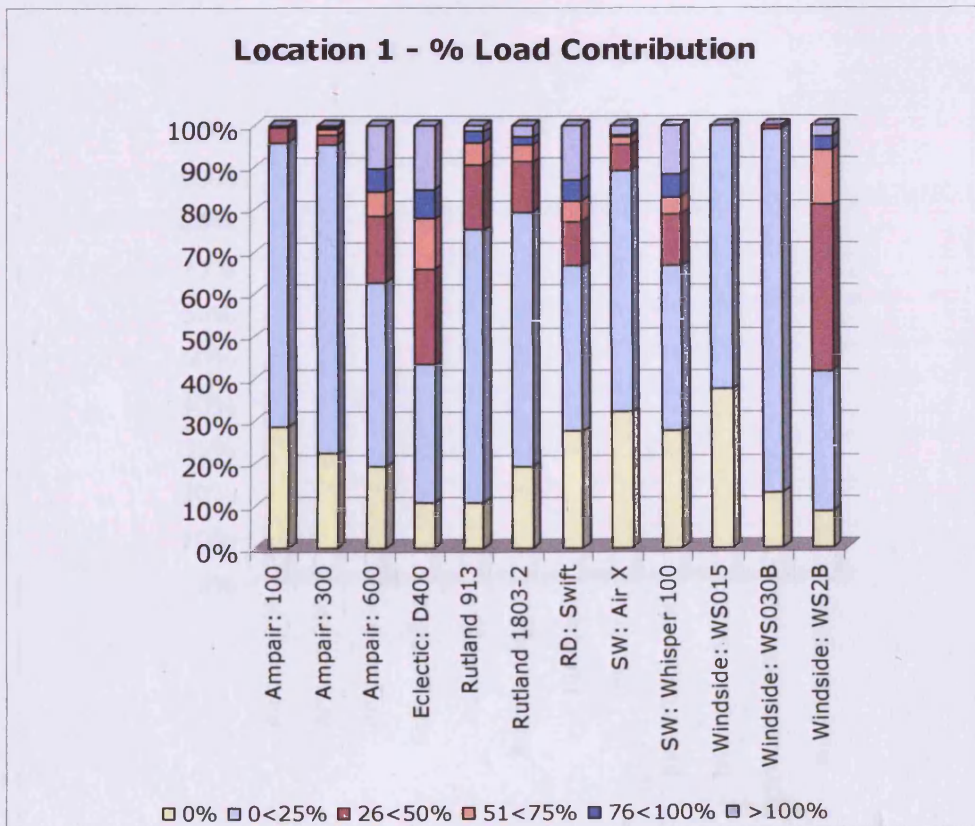

Figure 108: Percentage of load met for 3 day running periods – Location 1 (60W Lamp)

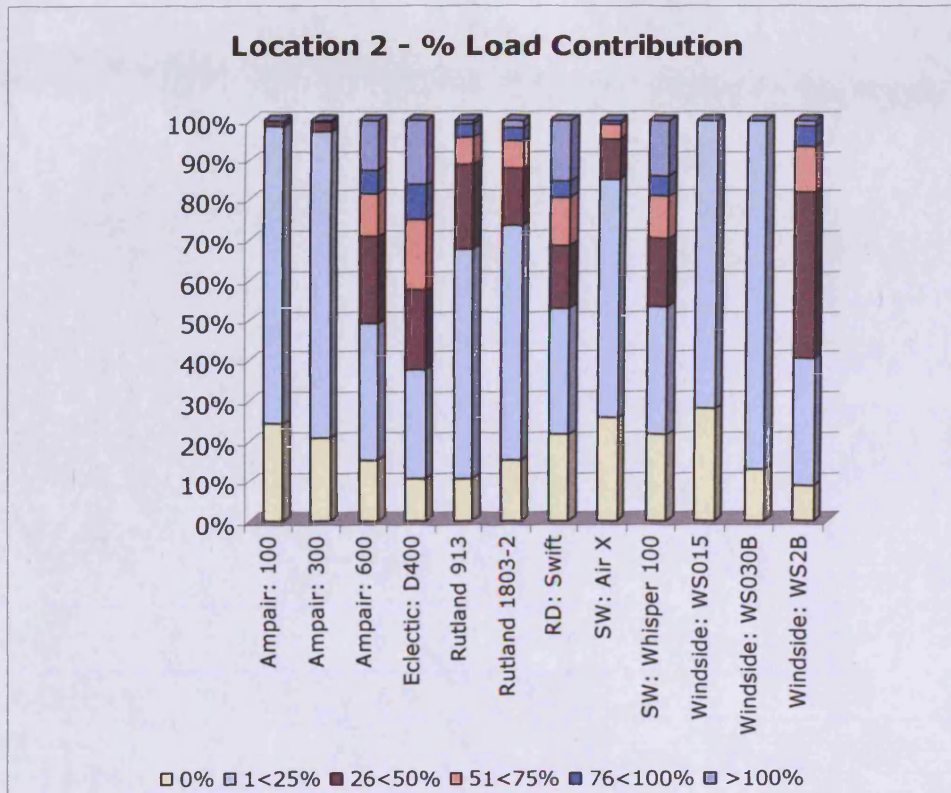

Figure 109: Percentage of load met for 3 day running periods – Location 2 (60W Lamp)

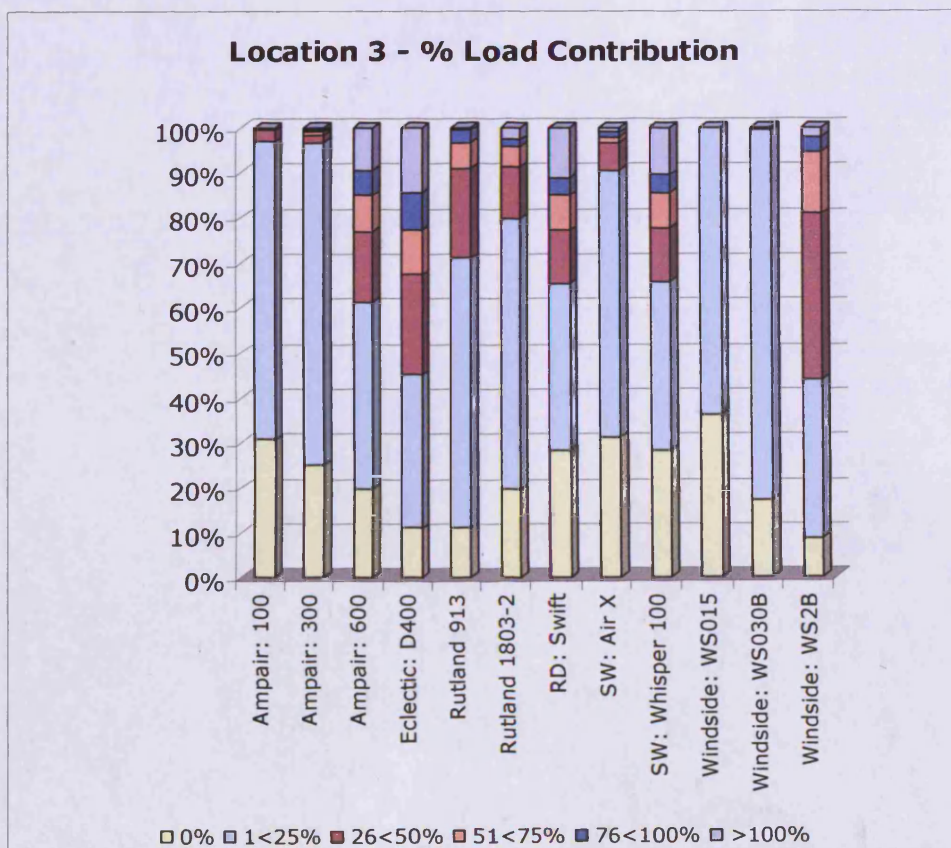

Figure 110: Percentage of load met for 3 day running periods – Location 3 (60W Lamp)

The hybrid street light has a limited battery store (304Ah) and there are periods when excess power is generated. In an urban environment, grid connection may be appropriate to avoid energy wastage. This would have the added advantages of providing an alternative source of power (i.e. the grid) during times when the renewable resource was insufficient to meet the load requirements and would also eliminate the need for a battery store. A net zero carbon energy source may still be achieved in this situation over an operating year.

The following figures (111 – 114 landscape) present the 3 day energy yield totals for all the turbine types for the monitoring period. The graphs are annotated to show the thresholds for the 150W lamp load and the 60W lamp load, with peaks exceeding these thresholds indicating times during the monitoring period when these loads were met or exceeded.

WSA Location - Load Contribution

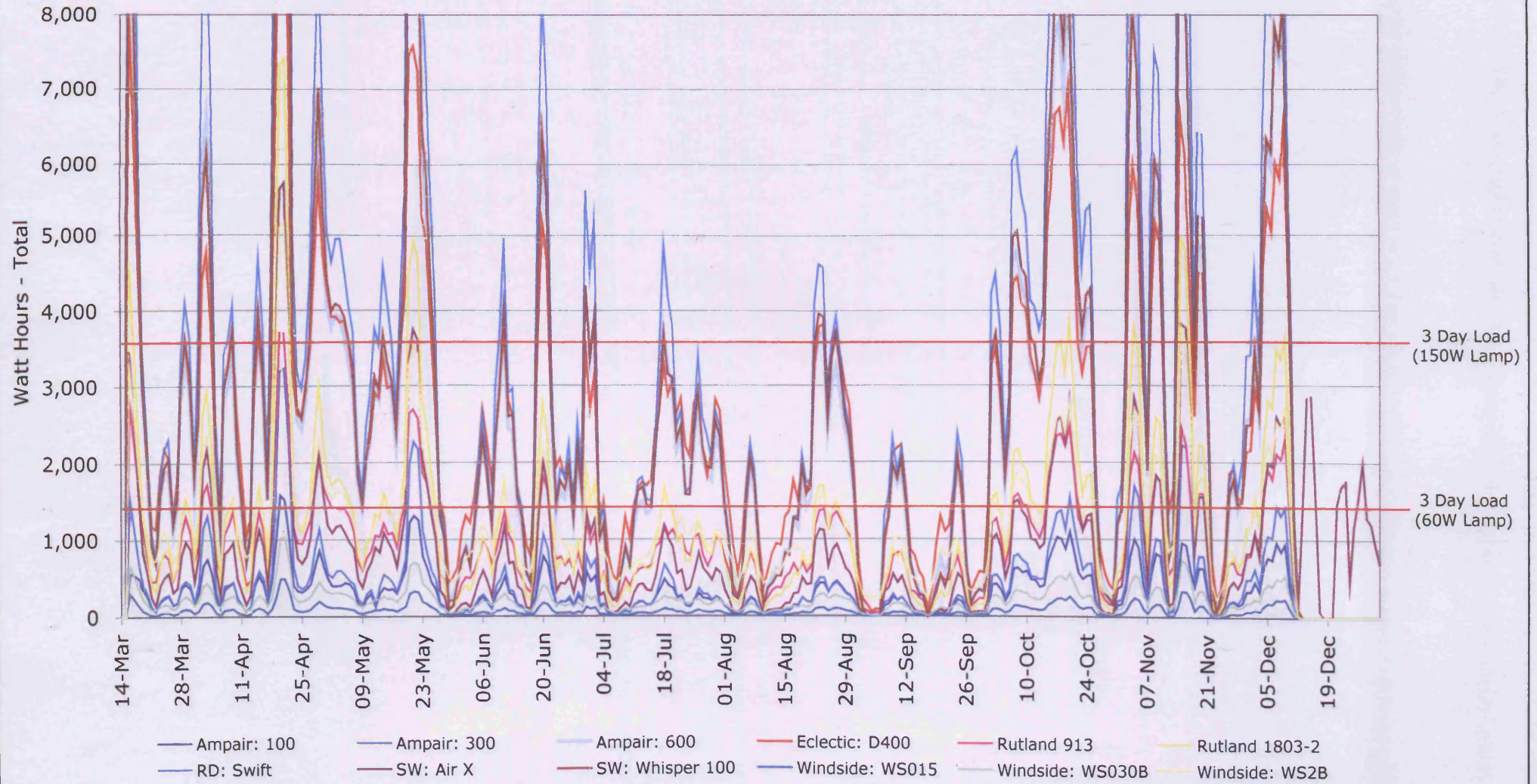

Figure 111: Turbine load contribution - WSA Location (for running 3 day periods)

Location 1 - Load Contribution

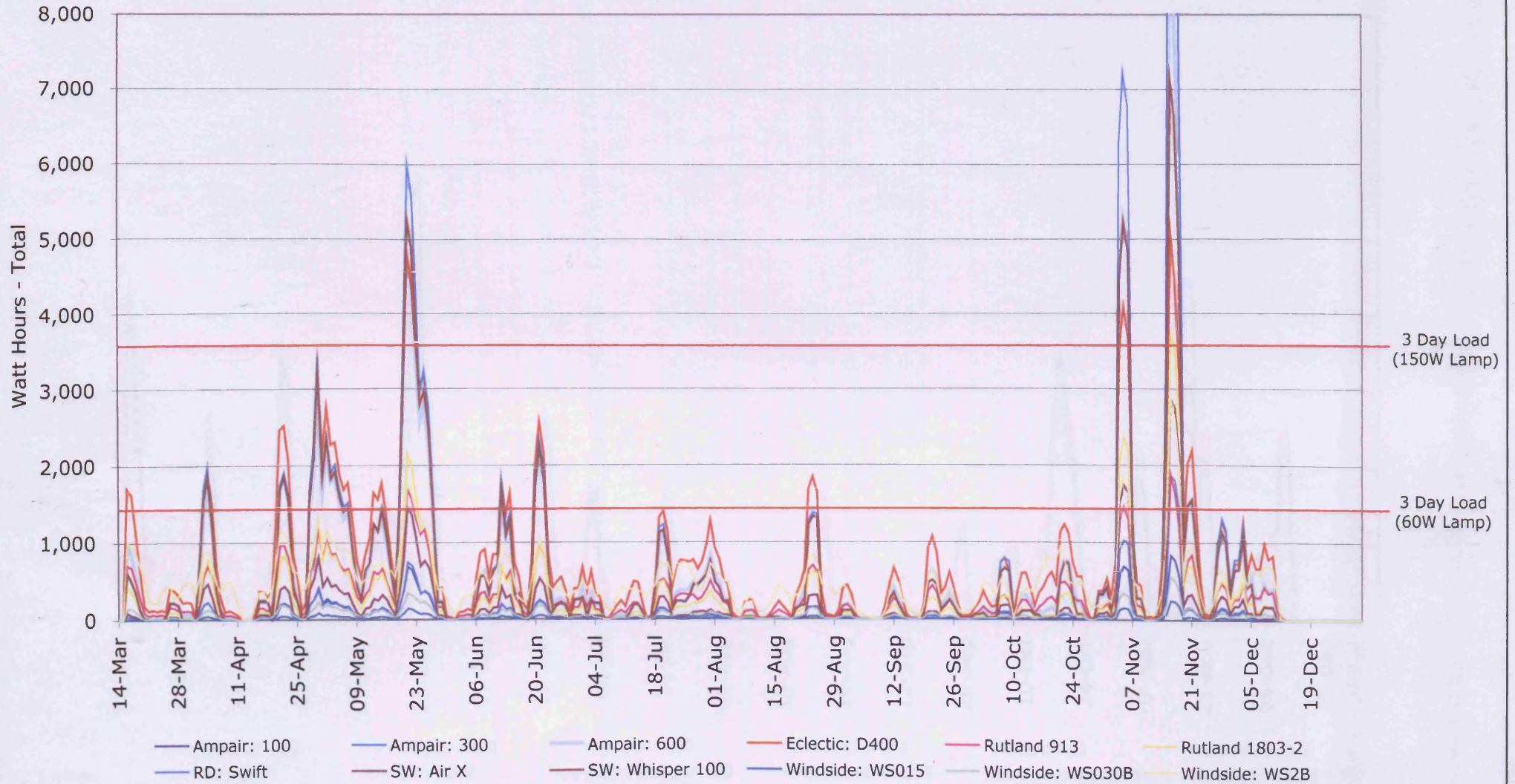

Figure 112: Turbine load contribution - Location 1 (for running 3 day periods)

Location 2 - Load Contribution

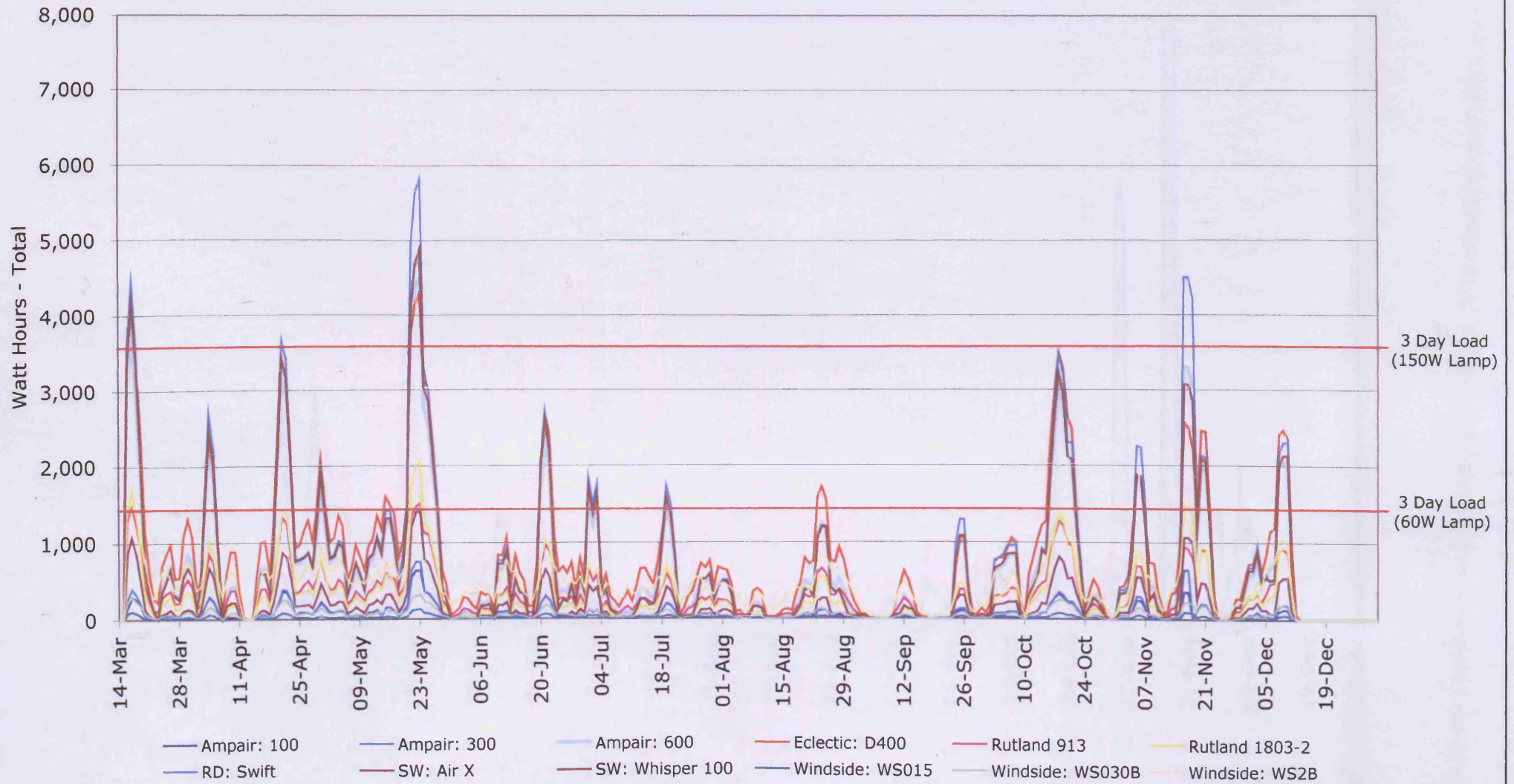

Figure 113: Turbine load contribution - Location 2 (for running 3 day periods)

Location 3 - Load Contribution

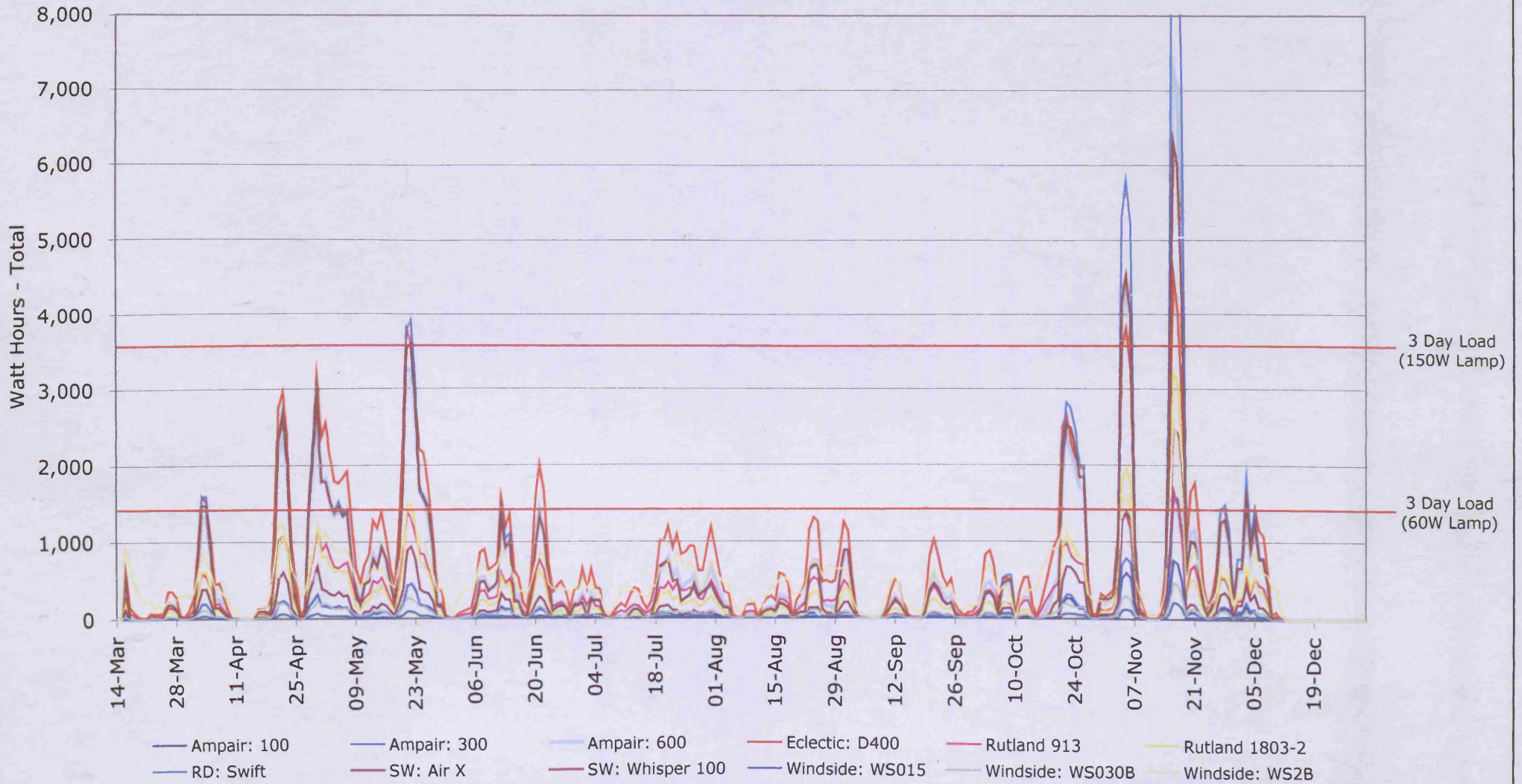

Figure 114: Turbine load contribution - Location 3 (for running 3 day periods)

6.3.3 Summary of Energy Yield Analysis

The results of the energy yield analysis have demonstrated the inadequacy of the CT Tool to estimate energy yield from small wind turbines at near ground level in urban environments. The predicted yield from the 3 column locations would be identical using the CT Tool as it is not possible to differentiate between sites at a micro-scale. Furthermore, while the tool over-estimated the energy yield for wind turbines mounted at the WSA location (27m), the results for the column locations (10m) suggested that 11 of the 12 turbine types would achieve zero energy yield. Through analysis of the monitored data for the column locations, it was found that all of the turbine types listed could contribute towards the load, indeed some significantly.

The reduction in load requirements, illustrated in this analysis, can be seen to be beneficial to the energy balance of the system, with more of the turbine types achieving a significant contribution towards the load. By reducing the load, the need for optimal siting becomes less critical, provided that there is sufficient wind resource available.

The optimal location of the points monitored was column location 2, which produced an increase in energy yield of between 16% and 28% compared with the other locations, across 10 of the 12 turbine types (table 43).

Turbine	Eclectic: D400	RD: Swift	Whisper 100	Ampair: 600	Rutland 913
Location 2 (kWh)	81.021	69.862	64.101	63.572	30.825
Location 1 (kWh)	71.428	63.968	54.682	57.371	27.717
Location 3 (kWh)	68.526	57.727	50.680	52.990	26.676
% Difference 2 : 3	18%	21%	26%	20%	16%

Turbine	Rutland 1803-2	SW: Air X	Ampair: 100	Windside: WS030B	Windside: WS015
Location 2 (kWh)	28.712	16.082	6.386	6.106	1.604
Location 1 (kWh)	25.723	14.590	6.352	5.621	1.419
Location 3 (kWh)	23.769	12.997	5.273	5.317	1.256
% Difference 2 : 3	21%	24%	21%	15%	28%

Turbine	Windside: WS2B	Ampair: 300
Location 1 (kWh)	46.644	7.636
Location 2 (kWh)	45.908	7.122
Location 3 (kWh)	45.445	6.339
% Difference 1 : 3	3%	20%

Table 43: Comparison of optimal column location with other column locations

6.4 Results from Wind Tunnel Testing

An analysis using the 1:200 scale model of the case study location was carried out using the BLWT to identify, in the first instance, whether or not the WT could correctly rank the column locations in terms of wind resource, compared with the monitored data. This work was carried out concurrently with the monitoring to limit the potential impact of any unintentional researcher bias in this comparison. From the monitored data, analysed in the previous section, it was apparent that column location 2 provided the greatest wind resource available to the small turbines listed in this study, followed respectively by column location 1 and column location 3. The results from the wind tunnel testing are presented in this section.

6.4.1 Hot-Wire Test Results for the 3 Column Locations

The procedure for the hot-wire tests is described in Chapter 5. For each column location height (10m) and each wind direction (N, NE, E, SE, S, SW, W, NW), 20 no. measurements were taken at 10 second intervals during the WT run. The results presented in table 44 are the average of these 20 measurements, to reduce the effect of WT turbulence on the probe ratio (LO : HI). The values shown indicate areas of wind shelter / acceleration at each column location and for each wind direction, based on the ratio between the scaled 10m column location height and a fixed reference point in the WT. Furthermore, a weighting scale based on the proportion of wind recorded for the 8 no. wind directions from the 10 year average annual wind rose for the Cardiff Airport weather station is shown in the table. This weighting, representing the local wind as unaffected by urban conurbation, was applied to the results for each column location to produce a weighted average.

	Wind Direction								Mean %	Weighted Mean %
	N	NE	E	SE	S	SW	W	NW		
Weighting	0.04	0.11	0.20	0.09	0.07	0.12	0.29	0.10		
	N%	NE%	E%	SE%	S%	SW%	W%	NW%		
Location 1	106.1	90.4	74.3	95.7	80.6	110.0	100.5	61.6	89.8	89.9
Location 2	85.5	89.2	134.7	117.2	75.5	47.6	94.6	88.0	91.5	96.3
Location 3	87.6	118.9	57.2	104.1	79.7	92.9	106.0	48.3	86.8	87.8

Table 44: % Shelter predicted for column locations from hot-wire tests

From the small sample of points tested (the 3 column locations) it appears that the WT can correctly rank the column locations in terms of potential wind resource across all wind directions, indicated by the mean shelter / acceleration proportion in table 44. This is also the case when the proportion of wind for each wind direction is weighted using the 10 year average annual wind rose for the Cardiff Airport weather station. The results of these tests are presented graphically as a series of shelter roses in figure 115 (overleaf).

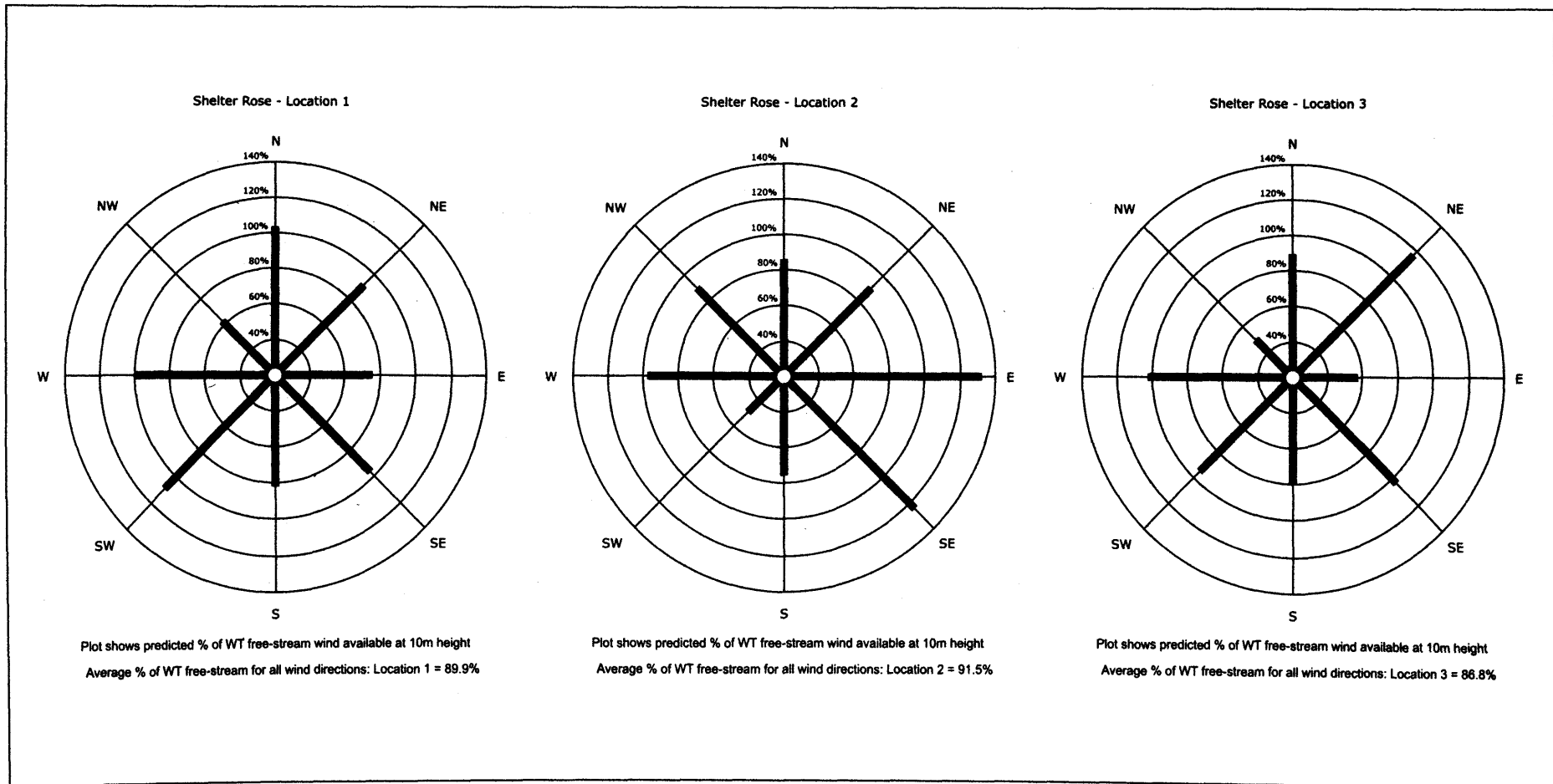

Figure 115: Wind shelter roses from WT hot-wire analysis

6.4.2 Use of BLWT to Identify Locations of Greater Wind Resource at 10m

Having correctly ranked the 3 column locations for which monitored data was collected, it was considered appropriate to use the BLWT for a more general assessment of the wider wind regime at the case study location. The aim of this assessment was to identify areas of potentially greater wind resource than the 3 column locations monitored that were also suitable for the deployment of hybrid street lights. Figure 116 shows the potential public realm areas of the site that are appropriate for street lighting columns according to the lighting standards (Chapter 2).

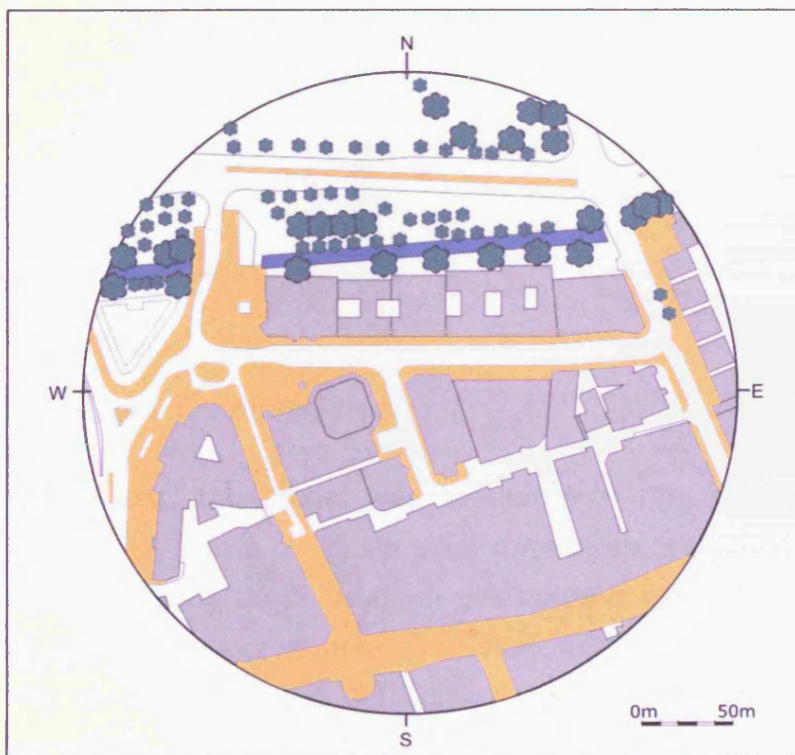

Figure 116: Areas of the public realm appropriate for locating street lighting columns

It was decided, as a relatively rapid method to assess the overall wind characteristics of the site, to use a scouring test as the initial test procedure. Areas of greatest variance in the wind regime identified through this testing method could then be further analysed through hot-wire testing. The results of the scouring and hot-wire tests are presented in the following sections.

6.4.3 Scouring Test Results

Using the 1:200 scale site model, a scouring test was undertaken for 8 wind directions (N, NE, E, SE, S, SW, W, NW). This test was used to examine wind effects at ground level, specifically areas where wind acceleration or shelter were present. The aim of these tests was to develop a broad understanding of the wind effects at the site. The results were later compared with the results of the hot-wire tests to see whether they could be used as an indicator for wind effects at the 10m level.

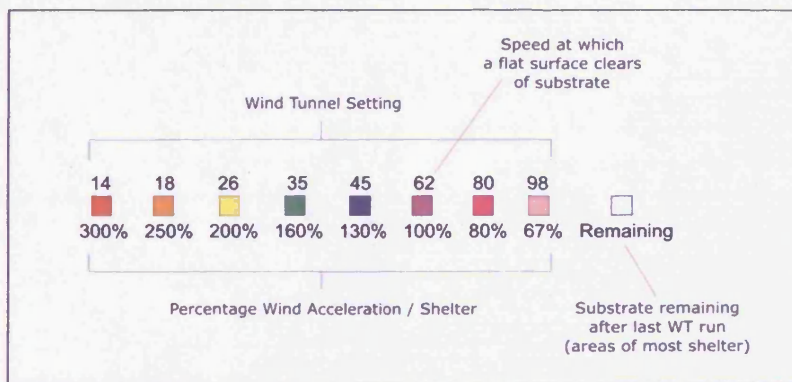
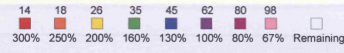

Figure 117: Scale used for scouring tests

For the scouring test, the model was seeded with fine grained semolina substrate. Figure 117 shows the scale used for the scouring test, where the coloured boxes represent those used on the contour plot. The wind tunnel settings and percentage acceleration / shelter are shown. WT setting 62 (100%) is the speed at which a flat surface (model base with all features removed) completely clears of the substrate. With the model in place and seeded with substrate, WT runs at each setting (starting from the lowest) were made for each wind direction. WT settings <62 indicated that acceleration was occurring (equivalent to the percentage shown) while WT settings >62 indicated that shelter was occurring. A camera mounted on top of the wind tunnel provided an overhead view as the substrate cleared, allowing the clearance at each setting to be recorded. Still images of each setting were then traced using software and the results overlaid to form a contour plot showing areas of acceleration and shelter. The results for each wind direction are presented overleaf.



Wind Direction: North



Wind Direction: North East



Wind Direction: East

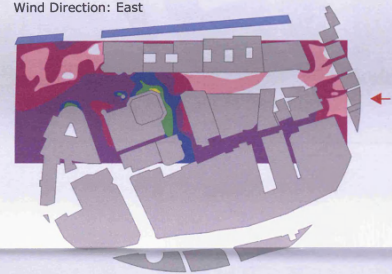

Wind Direction: South East



Wind Direction: South



Wind Direction: South West



Wind Direction: West



Wind Direction: North West

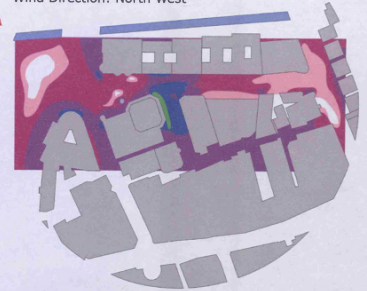

Figure 118: Results of coarse scouring tests for all wind directions

6.5 Results of Scouring and Hot-Wire Tests for Prevailing Wind Directions

The initial scouring tests showed significant changes in wind regime in the proximity of the tower with some areas of wind acceleration. Therefore points selected for the hot-wire analysis were mainly concentrated in this area in a 5m x 5m grid. Other points were spread along Greyfriars Road to investigate the sheltering effect indicated in this area from the scouring tests. The measurement points selected are shown in figure 119. Each point was measured at 1m, 5m and 10m heights and for West, North East and South wind directions. The results for each point are the average of 20 readings from the hot-wire probe, to reduce turbulence errors.

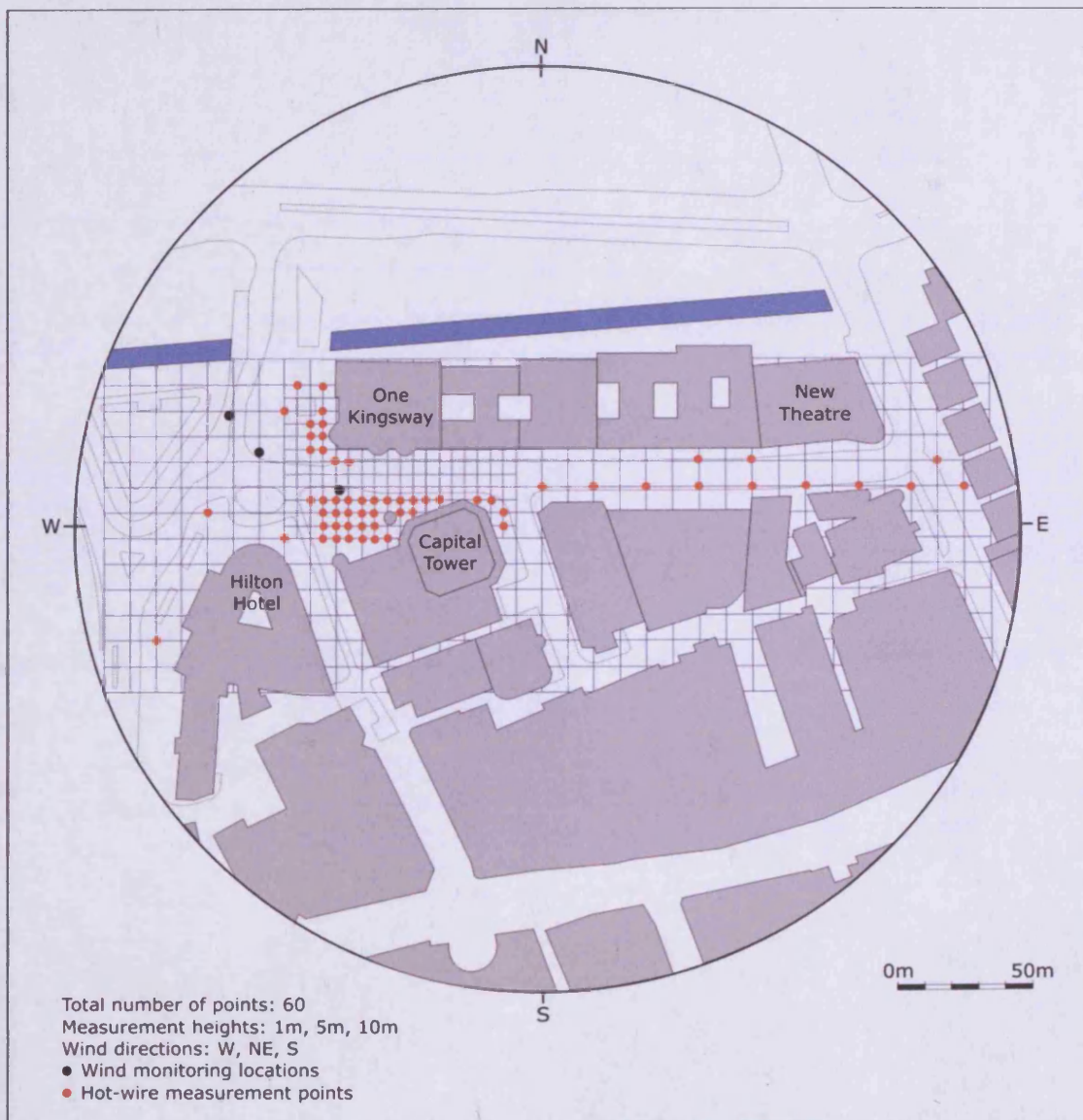

Figure 119: Hot-wire measurement points

6.5.1 Results of Wind Tunnel Tests for Wind Direction: West

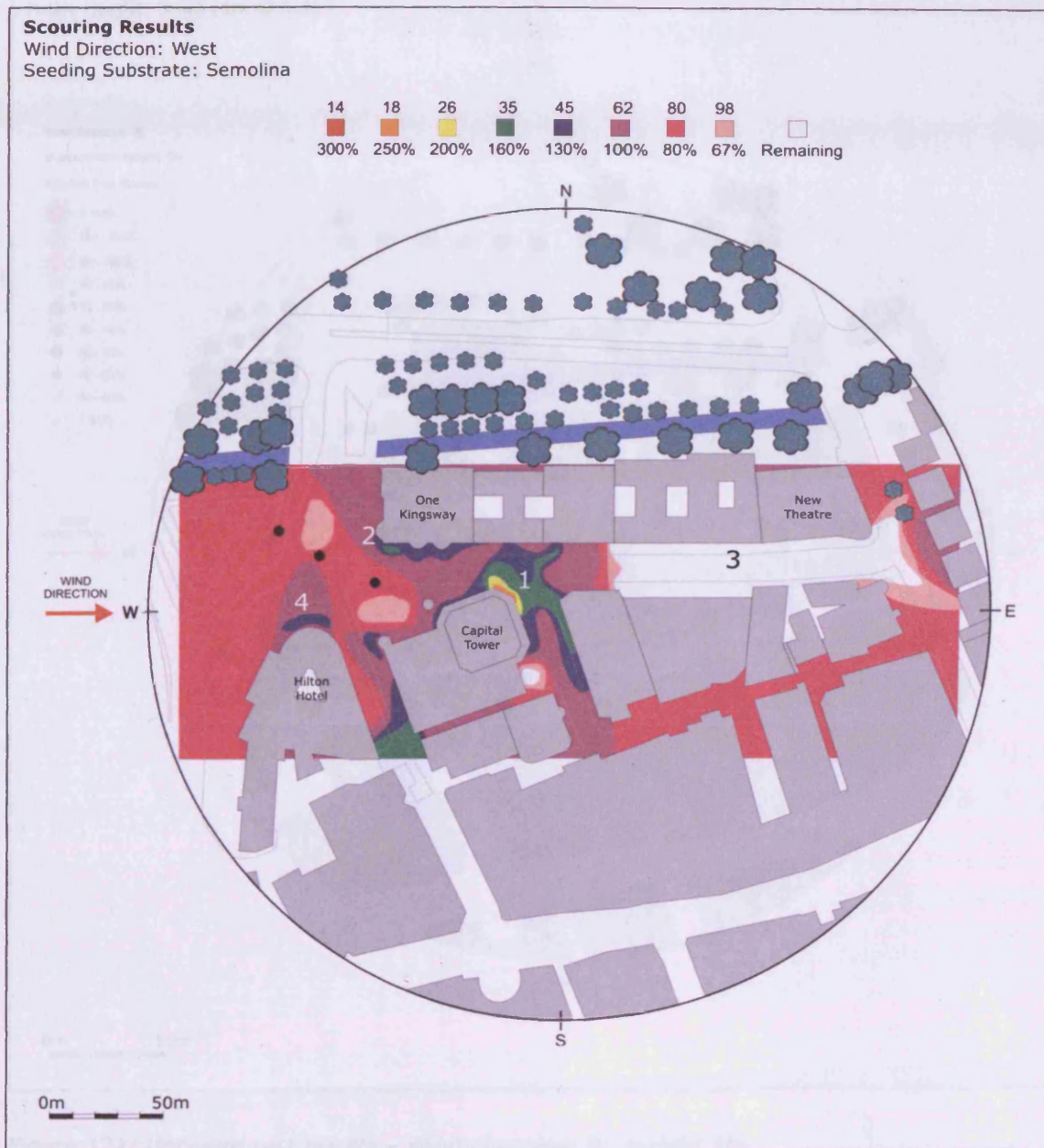

Figure 120: Scouring test results – Wind direction: W

- 1) Wind acceleration up to 250% occurs at ground level on the leeward (east) side of the tower. The effect is pronounced with a relatively large area directly to the east of this experiencing acceleration of between 130% and 160%.
- 2) The area directly to the west of the One Kingsway building receives 100% wind speed with acceleration of up to 160% in a localised area directly to the south west of the building.
- 3) The 'canyon' to the east section of Greyfriars Road is mostly very sheltered.
- 4) Acceleration of up to 130% occurs directly to the north of the Hilton Hotel.

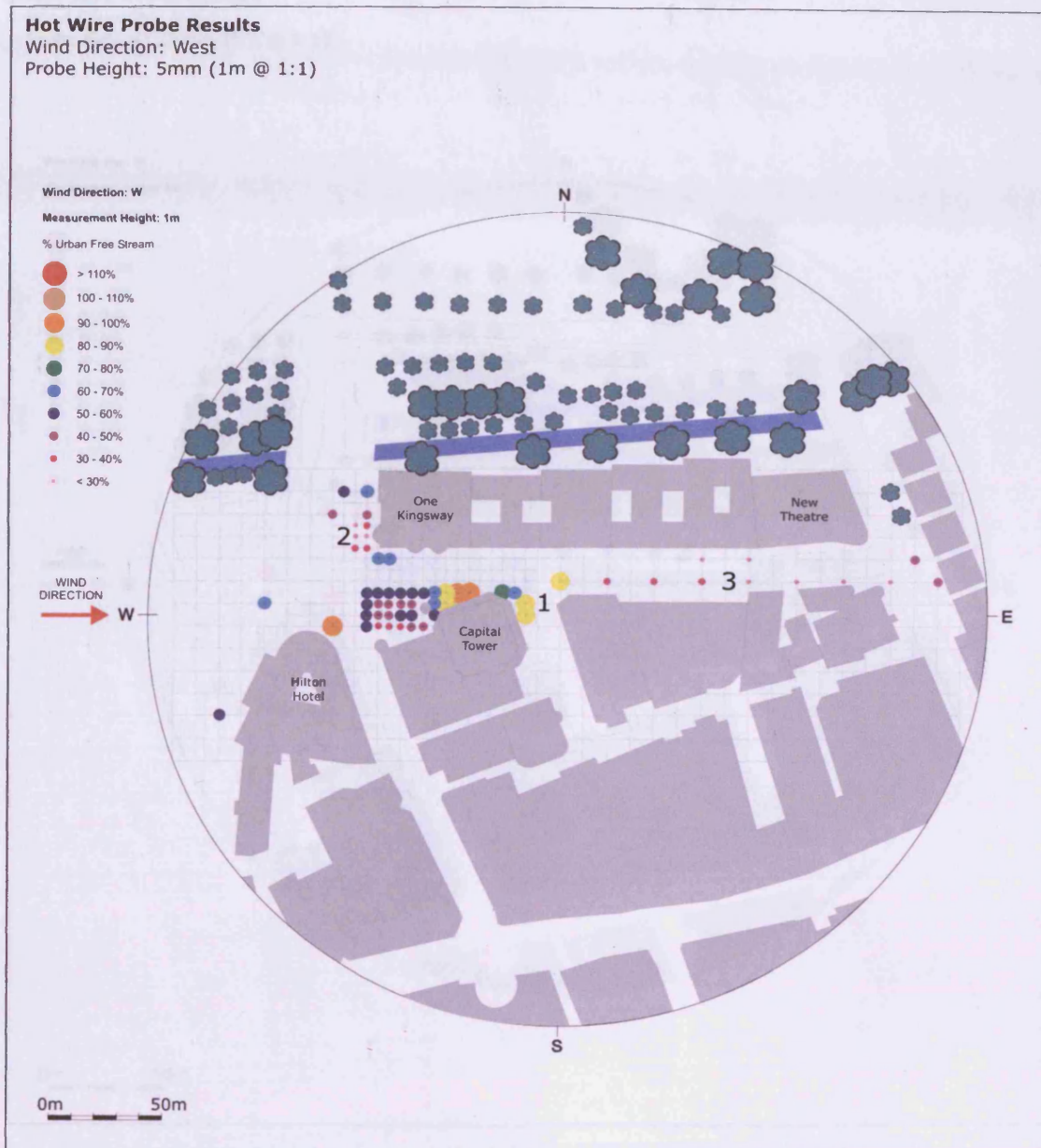

Figure 121: Hot-wire test results – Wind direction: W, Height 1m

- 1) The leeward (east) side of the tower is sheltered with between 70% and 90% urban free stream. The area directly to the west of the tower experiences wind speeds up to 100% urban free stream.
- 2) The area directly to the west of the One Kingsway building is sheltered with up to 50% urban free stream.
- 3) The 'canyon' to the east section of Greyfriars Road is mostly very sheltered.

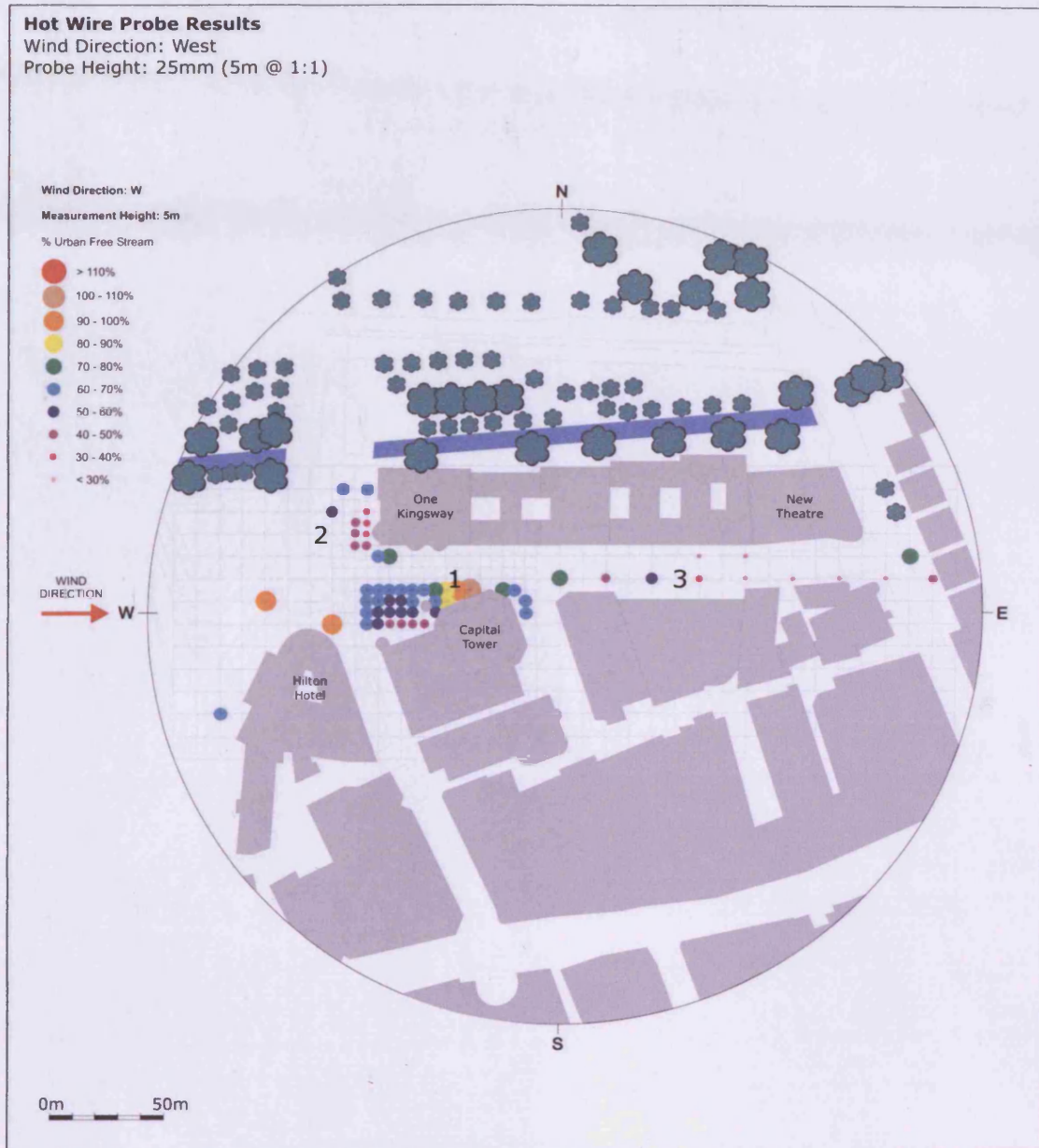

Figure 122: Hot-wire test results – Wind direction: W, Height 5m

- 1) The leeward (east) side of the tower is more sheltered than at the 1m level while the area at the base of the tower directly to the west experiences localised acceleration of up to 110%.
- 2) The area directly to the west of the One Kingsway building is slightly less sheltered than at the 1m level.
- 3) The 'canyon' to the east section of Greyfriars Road is slightly less sheltered than at the 1m level.

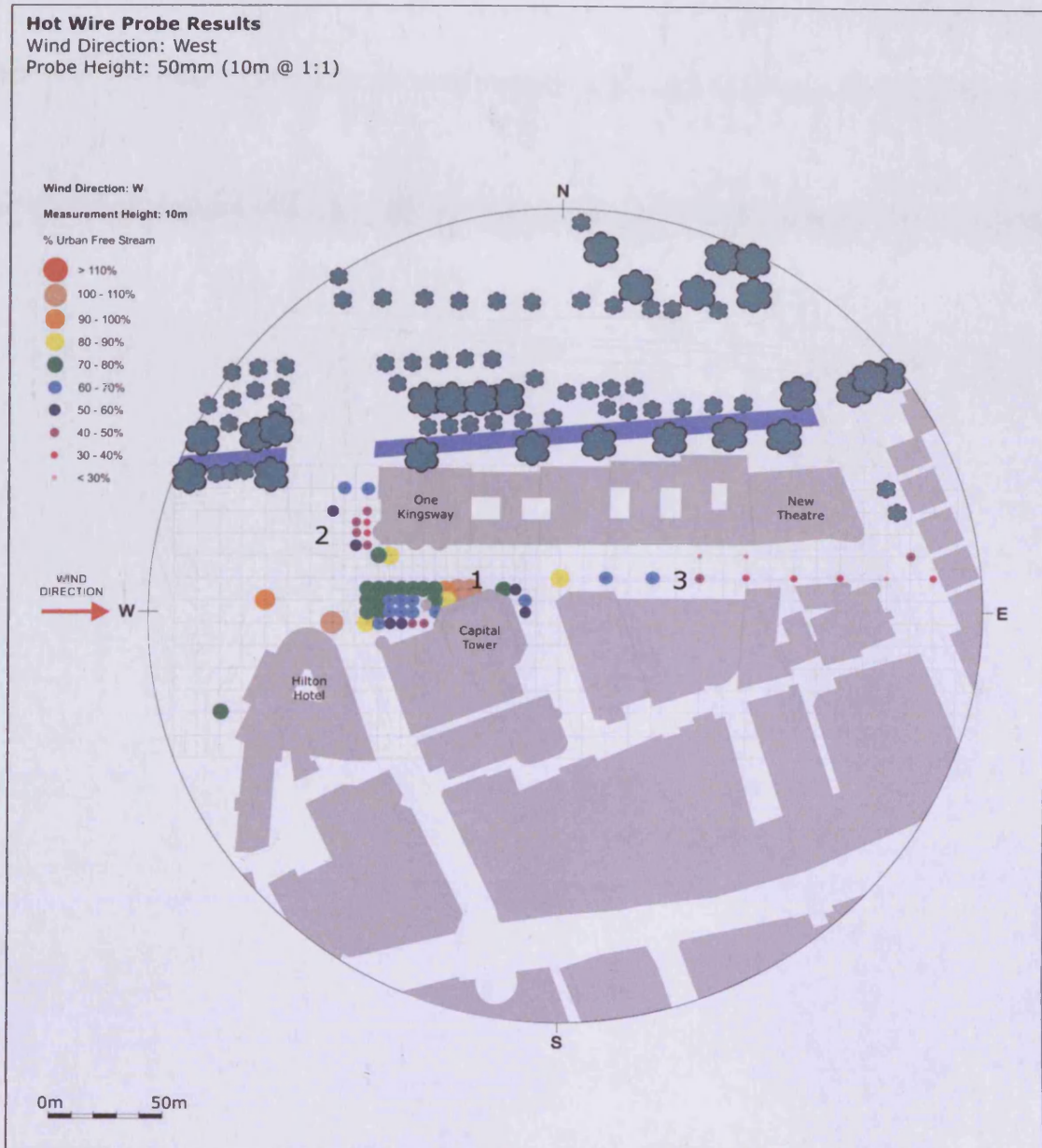

Figure 123: Hot-wire test results – Wind direction: W, Height 10m

- 1) The leeward (east) side of the tower is more sheltered than at the 1m level while the area at the base of the tower directly to the west experiences localised acceleration of up to 110% to a greater extent than at the 5m level.
- 2) The area directly to the west of the One Kingsway building is slightly less sheltered than at the 1m or 5m levels.
- 3) The 'canyon' to the east section of Greyfriars Road is slightly less sheltered than at the 5m level.

6.5.2 Summary for Wind Direction: West

There is a weak correlation between the results of the scouring test and the hot-wire tests. The 250% acceleration at the leeward (east) base of the tower shown in the scouring test is not present as acceleration in any of the hot-wire tests suggesting that the acceleration is largely accounted for by vertical component wind interacting with the ground plane. The area directly to the west of the base of the tower shows relatively little acceleration in the scouring test but more pronounced acceleration at the 5m and 10m levels. The area directly to the north of the Hilton Hotel experiences acceleration in both the scouring test and the 10m hot-wire test while the east section of Greyfriars Road experiences shelter according to all the tests.

It was expected that a 'canyon' effect may be present at the east section of Greyfriars Road for this wind direction, however this area remained largely sheltered in each test. This could be due to the fact that the hot-wire test locations are close to the edges of the street (in the zone where street lighting would most likely be situated) and friction from the building facades may slow wind speeds in these areas. There did appear to be a change in the sheltering effect with height with the 10m level hot-wire test showing the least sheltering of the 4 tests.

There some evidence of a 'blocking' effect at the extreme east end of Greyfriars Road where wind travelling along the street hits the buildings running perpendicular to the street. Although sheltered wind speeds are consistently higher in this location that for either the southerly or north-easterly tests, particularly at the 5m level.

6.5.3 Comparison of Results for Wind Direction: North East

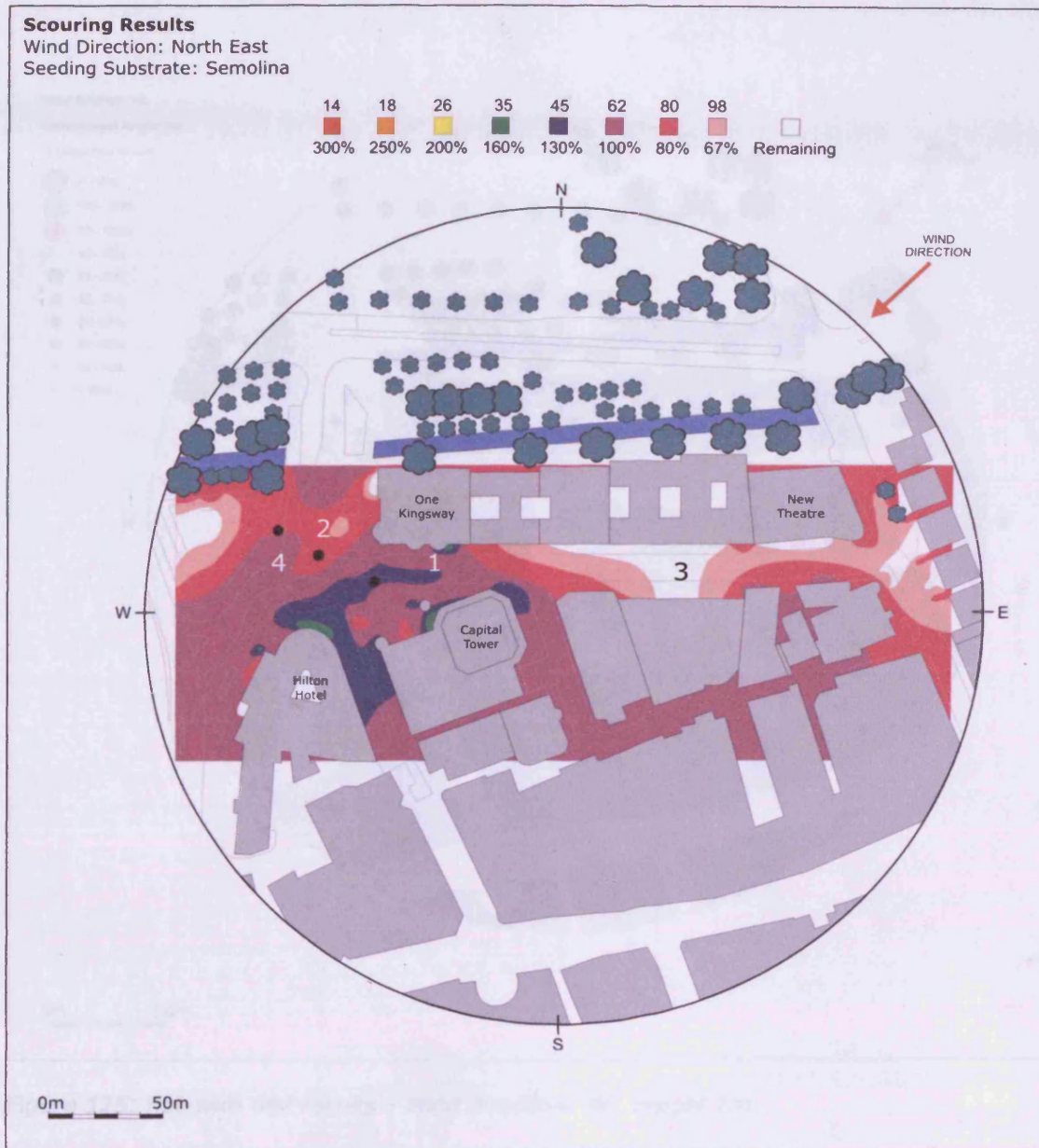

Figure 124: Scouring test results – Wind direction: NE

- 1) Wind is accelerated up to 160% in a localised area to the north of the tower.
- 2) The area directly to the west of the One Kingsway building is sheltered.
- 3) The 'canyon' to the east section of Greyfriars Road is largely sheltered.
- 4) The areas directly to the north and east of the Hilton Hotel experience accelerated wind. For a relatively large area directly to the east of the building this acceleration is up to 130%.

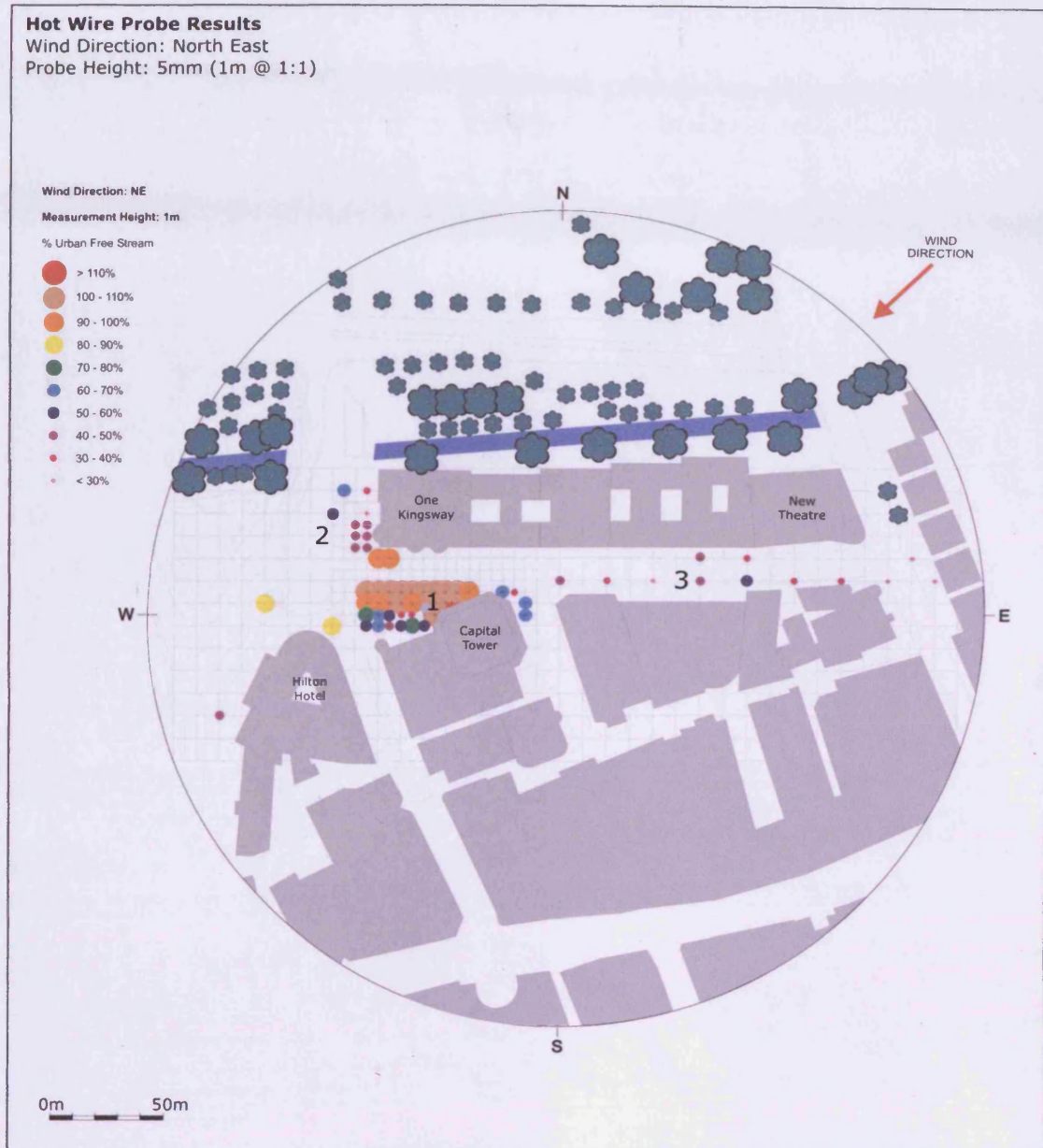

Figure 125: Hot-wire test results – Wind direction: NE, Height 1m

- 1) Wind acceleration occurs in the area directly to the north of the tower. Mostly this is up to 110% urban free stream but very close to the tower greater than 100% acceleration occurs.
- 2) The area directly to the west of the One Kingsway building is mostly sheltered with between 40% - 50% of urban free stream.
- 3) The 'canyon' to the east section of Greyfriars Road is largely sheltered.

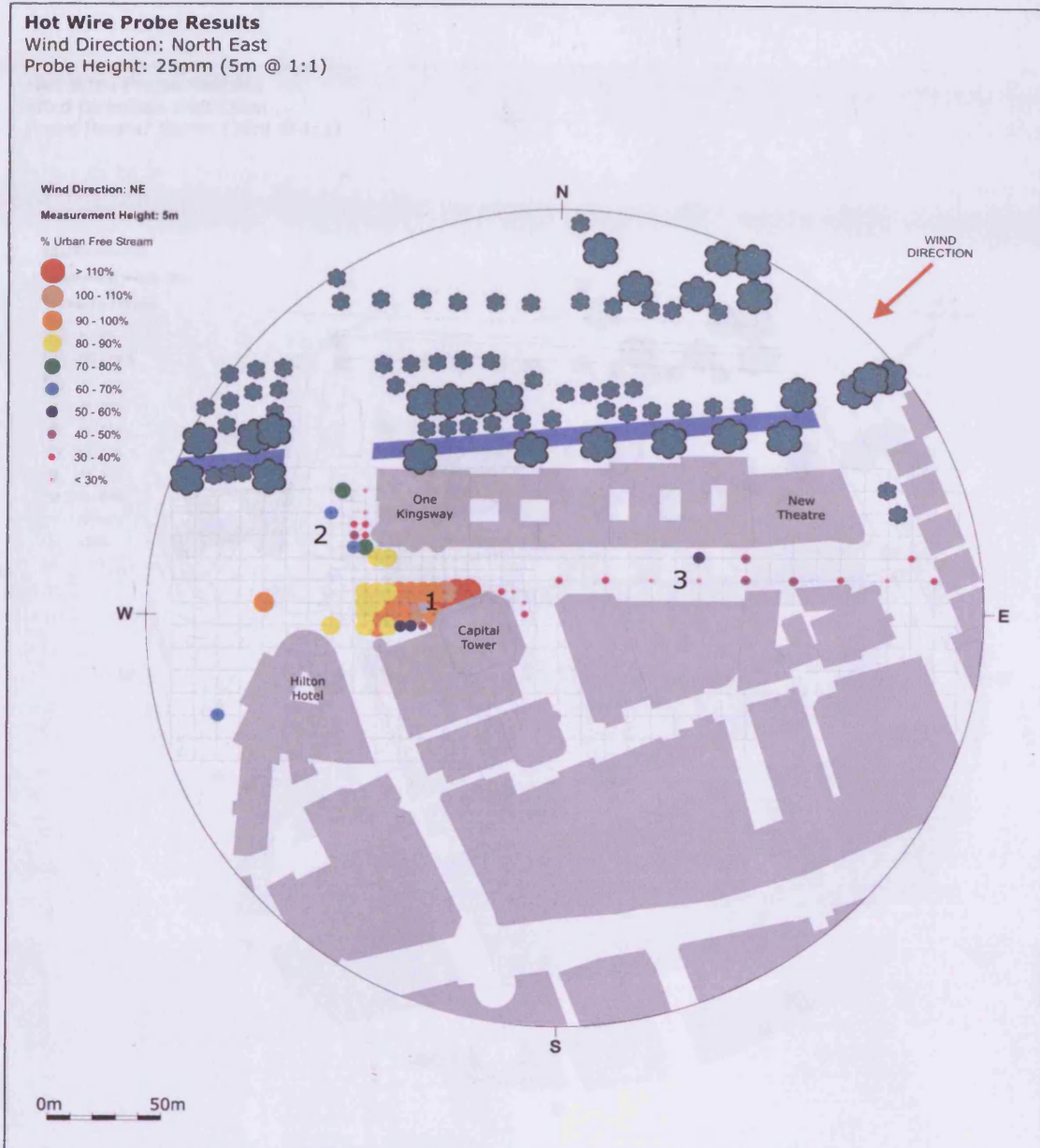

Figure 126: Hot-wire test results – Wind direction: NE, Height 5m

- 1) Wind acceleration of over 110% urban free stream occurs in the area directly north of the tower. The effect is localised and drops to between 80% and 100% within a small distance to the west.
- 2) The area directly to the west of the One Kingsway building is mostly sheltered with between 40% - 50% of urban free stream. The south west corner of the One Kingsway building experiences wind speeds between 70% and 90% urban free stream.
- 3) The 'canyon' to the east section of Greyfriars Road is largely sheltered.

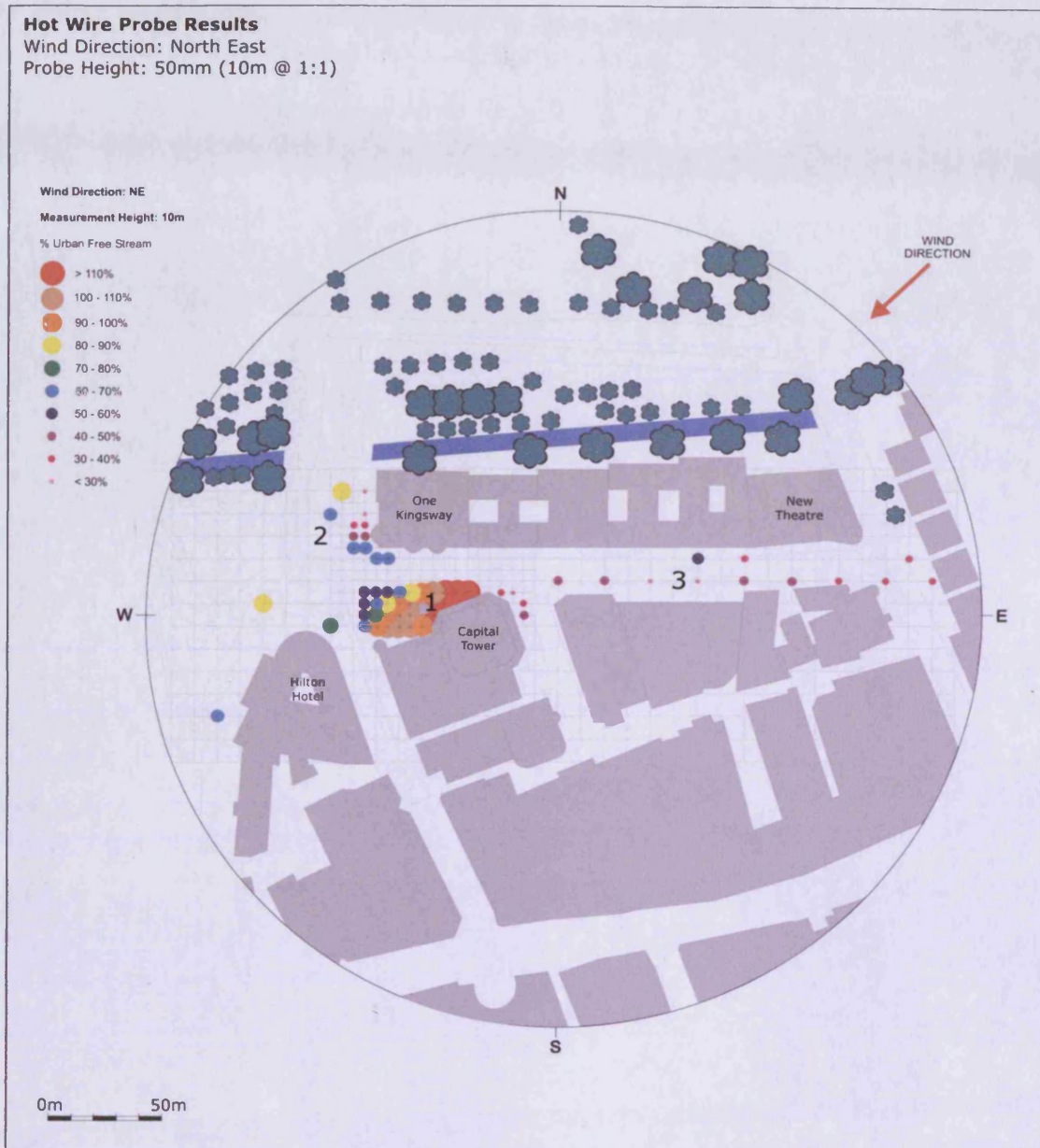

Figure 127: Hot-wire test results – Wind direction: NE, Height 10m

- 1) Wind acceleration of over 110% urban free stream occurs in the area directly north of the tower. The effect is marginally less localised than at the 5m level and drops to between 80% and 100% within a small distance to the west.
- 2) The area directly to the west of the One Kingsway building is mostly sheltered with between 40% - 50% of urban free stream. The south west corner of the One Kingsway Building is more sheltered than at the 5m level.
- 3) The 'canyon' to the east section of Greyfriars Road is largely sheltered.

6.5.4 Summary for Wind Direction: North East

There is some correlation between the results of the scouring test and the hot-wire tests notably with the sheltered area to the east end of Greyfriars Road and with the area of acceleration close to the base of the tower. However, the correlation does not appear to be as distinctive as with the southerly direction test.

Both the scouring test and the hot-wire tests indicate that the tower causes wind to be accelerated in the area close to its base and that this effect is more pronounced in the area directly to the north of the tower than for a southerly wind direction. The acceleration appears on the leeward (west) side of the tower and extends beyond the localised area at the base of the tower. Elsewhere sheltering occurs, particularly in the area to the east section of Greyfriars Road. This area possibly encounters a 'skimming' effect.

6.5.5 Comparison of Results for Wind Direction: South

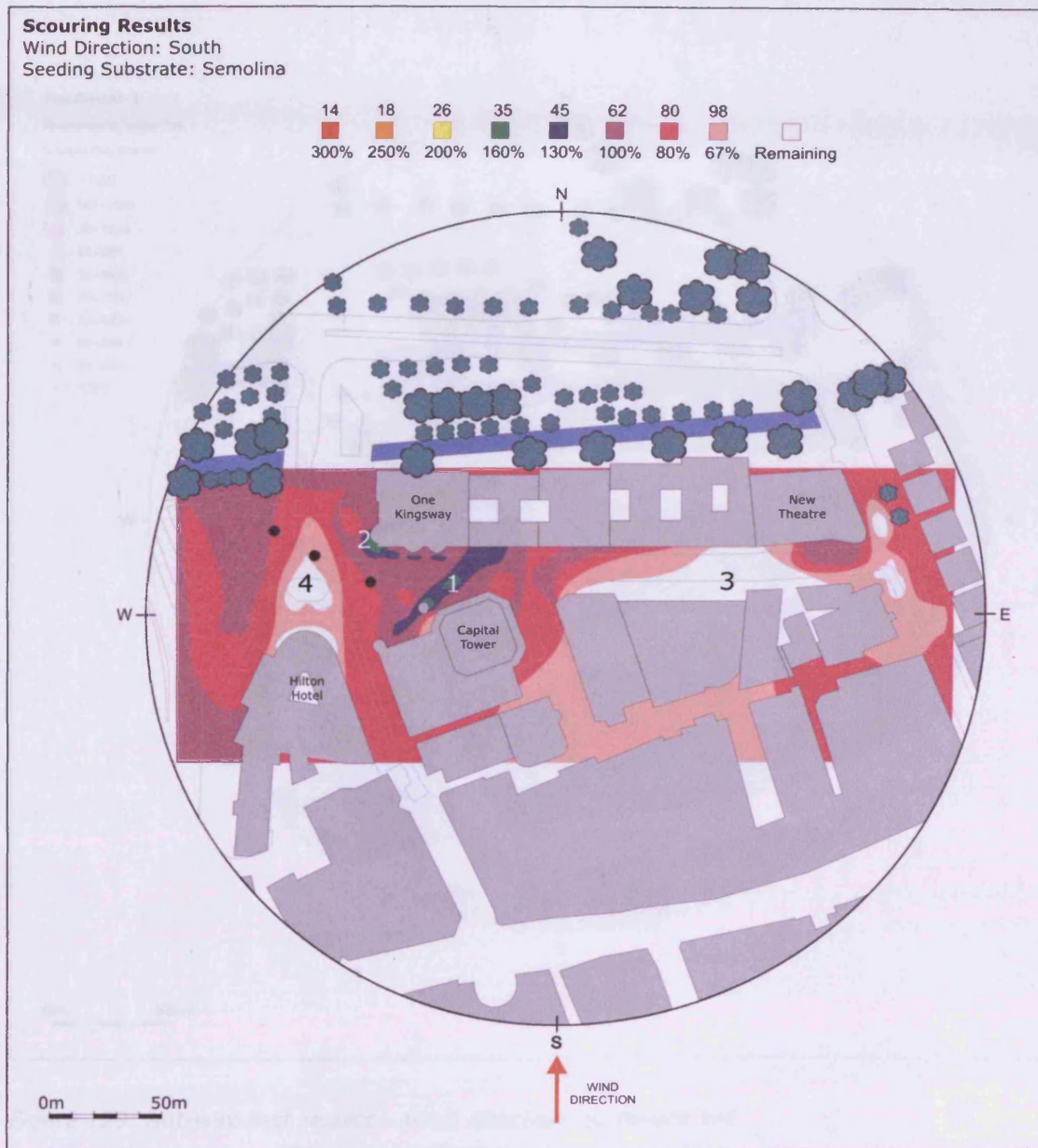

Figure 128: Scouring test results – Wind direction: S

- 1) Wind acceleration up to 160% occurs at ground level on the leeward (north) side of the tower.
- 2) Some wind acceleration is present at the south west corner of the One Kingsway building up to 160% in a localised area.
- 3) The 'canyon' to the east section of Greyfriars Road is mostly very sheltered.
- 4) The area on the leeward (north) side of the Hilton Hotel is sheltered.

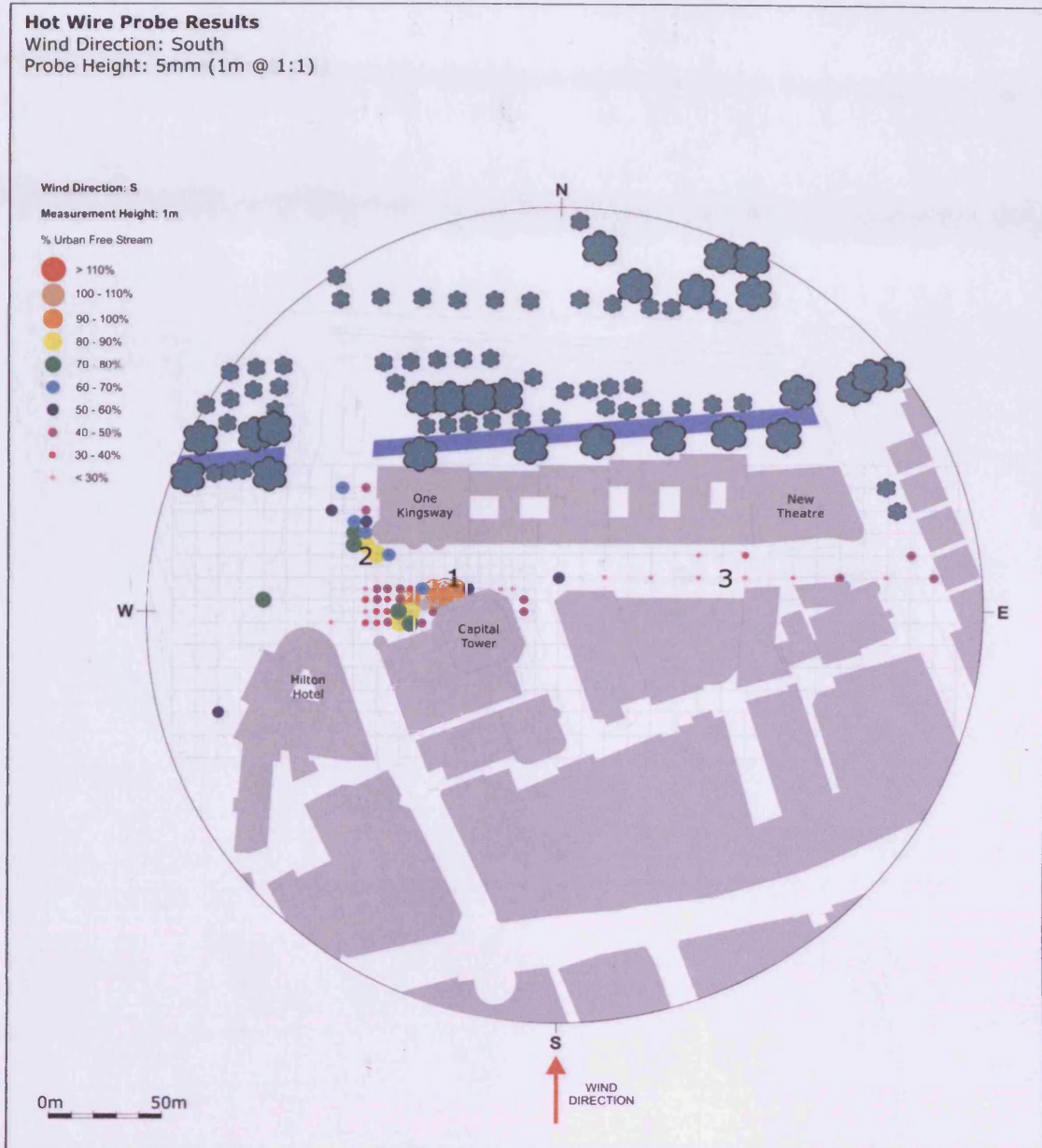

Figure 129: Hot-wire test results – Wind direction: S, Height 1m

- 1) Wind on the leeward (north) side of the tower is up to 100% urban free stream but no acceleration occurs.
- 2) Wind at the south west corner of the One Kingsway building is between 60% - 90% of urban free stream.
- 3) The 'canyon' to the east section of Greyfriars Road is mostly very sheltered.

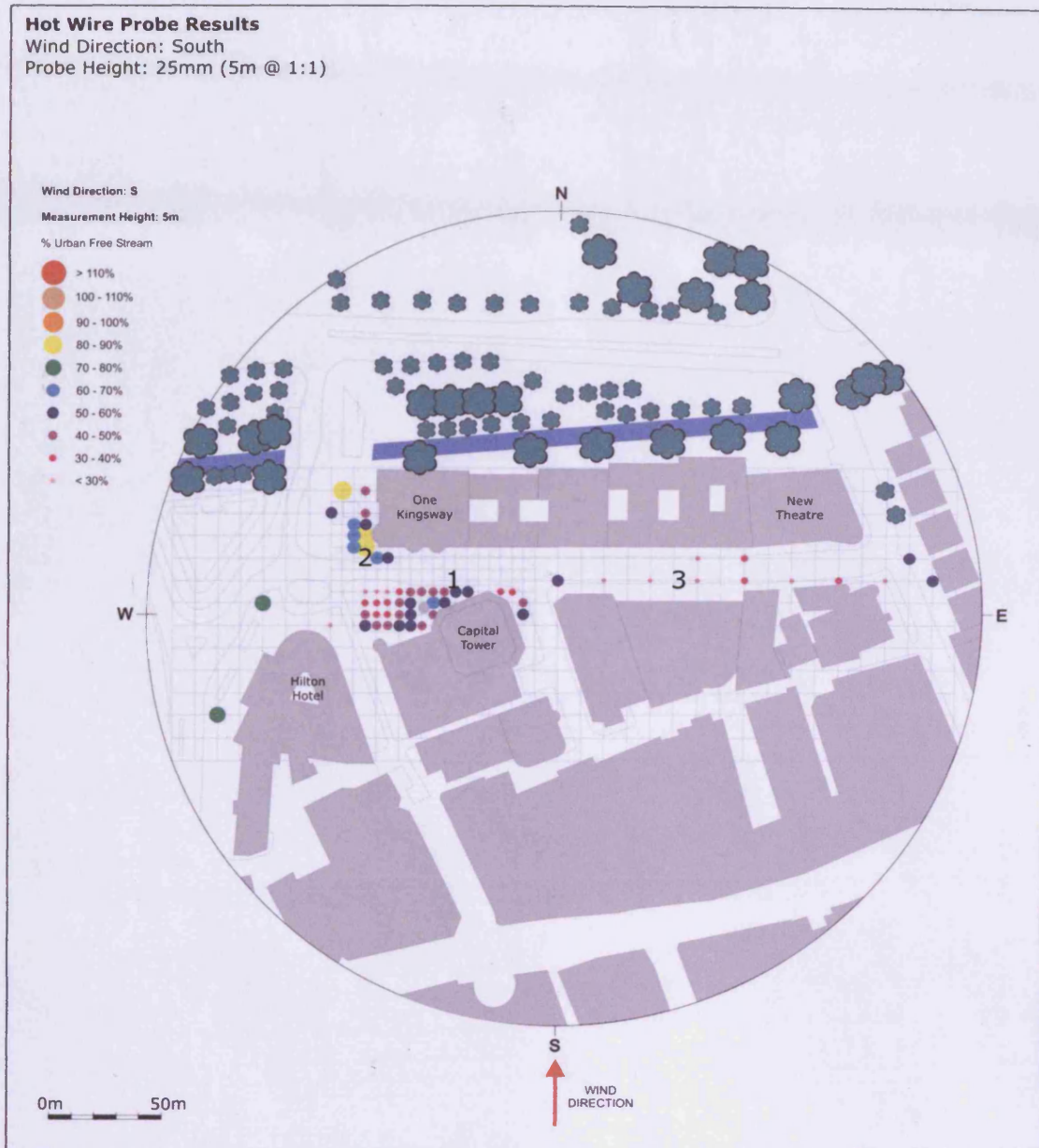

Figure 130: Hot-wire test results – Wind direction: S, Height 5m

- 1) Wind on the leeward (north) side of the tower is between 40% - 70% urban free stream but no acceleration occurs. Generally there is more sheltering in this area than at the 1m level.
- 2) Wind at the south west corner of the One Kingsway building is between 60% - 90% of urban free stream.
- 3) The 'canyon' to the east section of Greyfriars Road is largely sheltered.

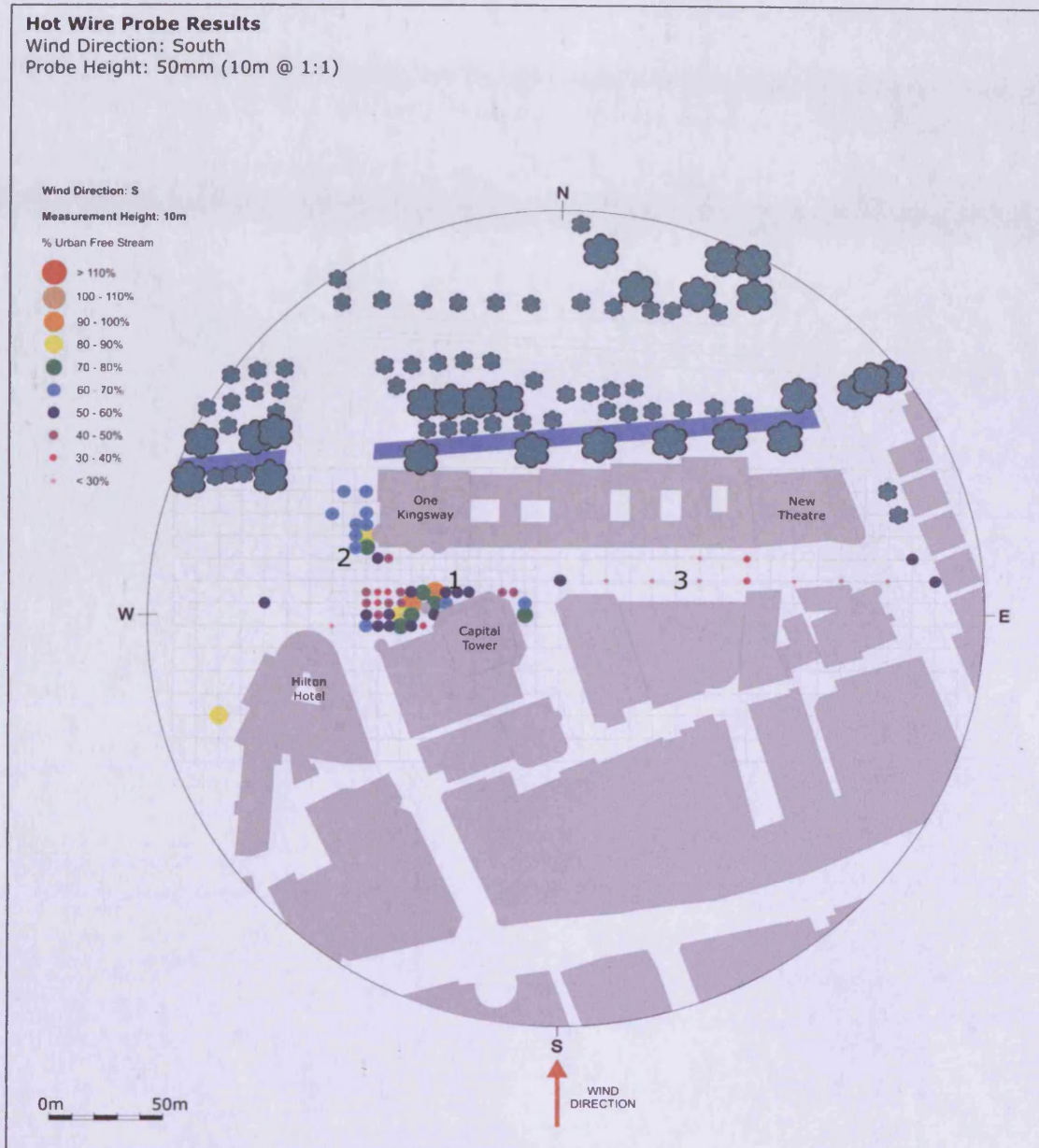

Figure 131: Hot-wire test results – Wind direction: S, Height 10m

- 1) Wind on the leeward (north) side of the tower is up to 100% urban free stream but no acceleration occurs. Generally there is less sheltering in this area than at the 5m level but more than at the 1m level.
- 2) Wind at the south west corner of the One Kingsway building is between 60% - 90% of urban free stream. The area directly to the west of the building is sheltered at up to 70% urban free stream.
- 3) The 'canyon' to the east section of Greyfriars Road is largely sheltered.

6.5.6 Summary for Wind Direction: South

The scouring test showed wind acceleration in certain areas that was not present in the hot-wire tests. This could be because the scouring tests are influenced by vertical component wind that is not detected by the hot-wire probes. Overall the hot-wire tests show a reasonable correlation with the scouring test with areas of strong wind and weaker wind being located in similar areas.

As expected the 'canyon' to the east section of Greyfriars Road remained sheltered for all measurement heights possibly indicating a 'skimming' effect. The tower appears to funnel wind towards its base. It is likely that recirculation accounts for the relatively high wind speeds in this area as wind is forced down the face of the tower (as a largely vertical component) and then hits the roofs and ground at its base. The effect appears to be strong on the leeward side of the tower which suggests that wind 'wraps' the tower and is forced downwards even on the opposite side to the prevailing wind direction.

6.6 Comparison with Current Small Turbine Siting Guidance

Current guidance for locating small wind turbines is discussed in Chapter 4 and the relevance of this guidance to the case study location is discussed in Chapter 5. The findings of this study indicate that some energy yield is achievable from small wind turbines located in an urban environment, even in areas that may not be selected based on current guidance. This reflects the fact that guidance for siting small wind turbines is focussed on optimal siting for grid-connected systems, as opposed to non-optimal siting that may be adequate for standalone systems, such as the hybrid street lighting system described.

6.7 Further Results and Considerations

The study identified further considerations relevant to the deployment of hybrid street lighting in urban locations. These are discussed in the following sections.

6.7.1 Heliodon Tests

The hot-wire tests identified areas of the site where the wind resource might be higher than for the column monitoring locations. These areas were largely concentrated around the north of the base of the Capital Tower building. It was expected that this area would be shaded from the sun for significant periods of the year and, therefore, may not be suitable for PV.

Whilst the focus of this study was the wind component of the hybrid street light, a rapid way to qualitatively assess the suitability of areas of the site for PV was to use the 1:200 scale WT model with the heliodon function of the artificial sky at the WSA, to perform a solar shading analysis. The process of conducting this analysis will not be described here although it is fairly simple. The results of solar shading analysis for December, March and June are presented in the following pages. In each photograph the location of column 1 is indicated by a red circle. Particularly evident from this analysis is the shadow caused by the by the Capital Tower building that would affect the output from the PV component of the hybrid street light.

6.7.2 Changes to the Urban Environment

Another factor that may have consequences for the deployment of hybrid street lights in urban environments is that urban environments are subject to a constant process of change, as buildings are altered or new buildings are built. It has been observed that since the case study monitoring was conducted, several of the buildings around the site have been altered, including the addition of 3 extra storeys to the height of the buildings along the north side of Greyfriars Road, effectively raising the average canopy height in this location. This study has found that urban form affects the wind regime at near ground level profoundly and so, such changes to the urban form are likely to have an impact on turbine energy yield.

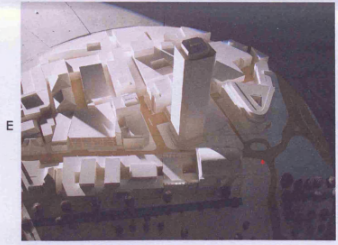

21ST DECEMBER - 09:00

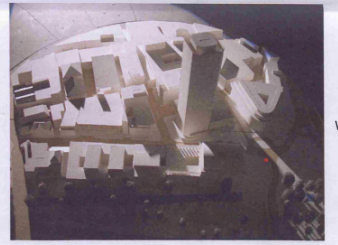

21ST DECEMBER - 10:00

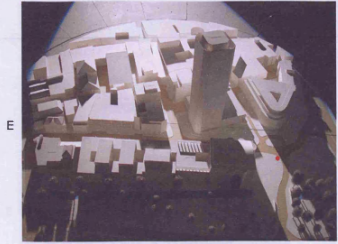

21ST DECEMBER - 11:00

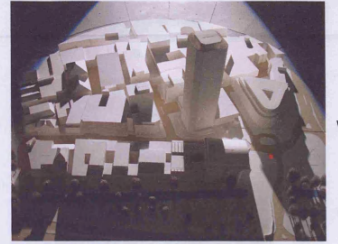

21ST DECEMBER - 12:00

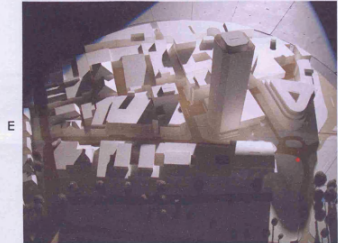

21ST DECEMBER - 13:00



21ST DECEMBER - 14:00

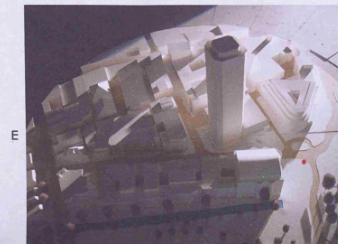

21ST DECEMBER - 15:00



21ST DECEMBER - 16:00



21ST DECEMBER - 17:00

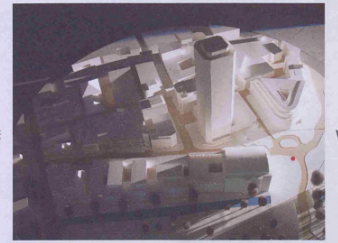

21ST DECEMBER - 18:00

Figure 132: Heliodon analysis for December

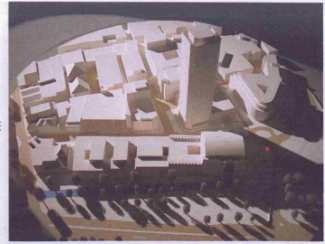

21ST MARCH - 09:00

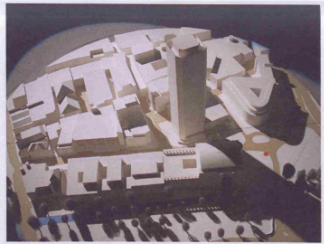

21ST MARCH - 10:00



21ST MARCH - 11:00



21ST MARCH - 12:00

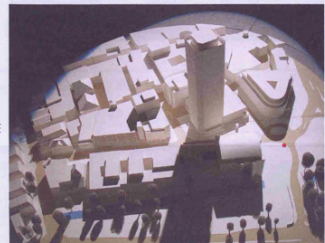

21ST MARCH - 13:00

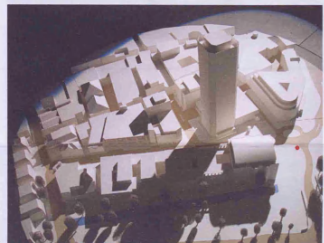

21ST MARCH - 14:00



21ST MARCH - 15:00

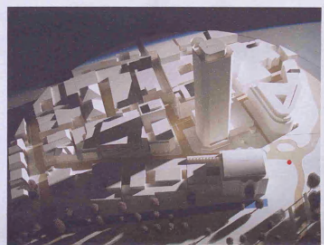

21ST MARCH - 16:00

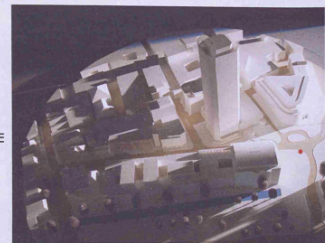

21ST MARCH - 17:00



21ST MARCH - 18:00

Figure 133: Heliodon analysis for March

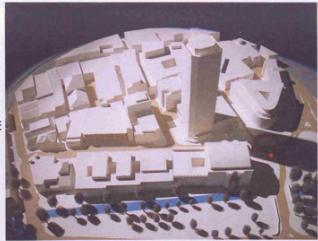

21ST JUNE - 09:00



21ST JUNE - 10:00

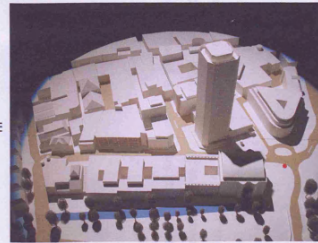

21ST JUNE - 11:00



21ST JUNE - 12:00



21ST JUNE - 13:00



21ST JUNE - 14:00



21ST JUNE - 15:00



21ST JUNE - 16:00

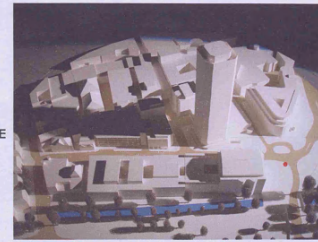

21ST JUNE - 17:00

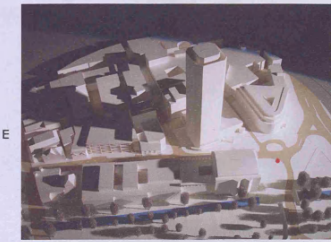

21ST JUNE - 18:00

Figure 134: Heliodon analysis for June

6.8 Summary

At a simple level it has been shown that the average wind speeds for the monitoring period can be ranked in the following order for the monitoring locations (table 45).

Location	Mean Wind Speed (m/s)	% of WSA Location	% of Column Location 2
Location 2	2.2	67.0	100.0
Location 1	2.1	65.5	97.7
Location 3	2.0	64.7	96.6
WSA Location	3.2	100	n/a

Table 45: Mean wind speed summary

This relationship is, however, only found for the long-term average wind speeds, reinforcing the need to monitor for a significant period of time to ensure that results are representative of the long-term wind regime. Calculation of energy yields from the monitored data suggests that for all but 2 of the turbines listed in this study, the order of energy yield magnitude for the 4 locations is the same, thus:

- WSA
- Column Location 2
- Column Location 1
- Column Location 3

The order of magnitude of variation in performance between the 3 column locations varies from 16% difference between a turbine located at column location 3 and the same turbine located at column location 1, through to a maximum of 28%.

Through analysis of the available wind power by orientation (using the formula described in Chapter 4 and a nominal area of 1m²), the variance between the locations can be more finely characterised (table 46).

	N%	NE%	E%	SE%	S%	SW%	W%	NW%
Monitored WSA	1.85	23.46	16.93	3.94	7.96	19.18	22.40	4.28
Monitored Location 1	4.92	6.50	6.87	4.53	40.52	24.91	7.38	4.36
Monitored Location 2	1.74	7.22	31.68	5.02	2.79	16.26	28.06	7.24
Monitored Location 3	14.73	10.05	2.95	3.33	31.58	25.38	8.73	3.25

Table 46: Measured proportion of wind power by direction

The figures in bold text in table 46 illustrate the wind direction that has the highest power available for each location. The figures in red indicate the wind directions selected for the hot-wire WT tests, that were chosen to reflect the prevailing wind directions recorded at the WSA station. What is evident from these calculations is that the E wind direction for location 2 contributes nearly one third of the available wind power for this location, while for column locations 1 and 3, the S wind direction is dominant in terms of wind power availability.

The WT results for column location 2 indicated a strong degree of acceleration (134%) present for the E wind directions, perhaps explaining why this location provided a greater wind resource (figure 135).

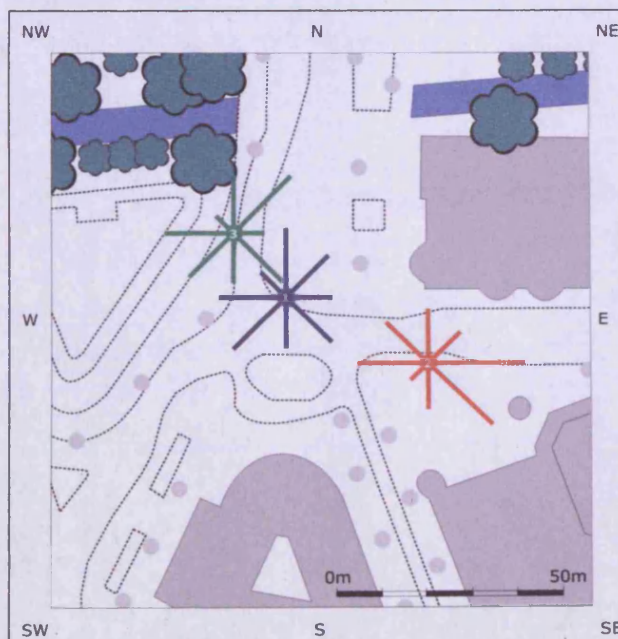

Figure 135: Qualitative comparison of shelter roses for column locations

	N%	NE%	E%	SE%	S%	SW%	W%	NW%	Average %	Average % for prevailing wind directions
Location 1	106.1	90.4	74.3	95.7	80.6	110.0	100.5	61.6	89.8	99.5
Location 2	85.5	89.2	134.7	117.2	75.5	47.6	94.6	88.0	91.5	78.6
Location 3	87.6	118.9	57.2	104.1	79.7	92.9	106.0	48.3	86.8	100.4

Table 47: % Shelter predicted from hot-wire tests with averages for prevailing wind

A further comparison can be made between the % shelter predicted through WT analysis (table 47) and the measured proportion of wind power by direction for each of the column locations (table 46). This is presented in table 48, where the values are normalised to column location 2 to enable comparison with that found to have the greatest potential energy yield. The interpretation of this table must therefore be carefully considered in this context with reference to tables 46 and 47. For example, for the easterly wind direction (the location with the highest acceleration for location 2 (134.7%)) the normalised shelter proportions for the other locations are relatively low (location 1=0.55 and location 3=0.42). Furthermore, the normalised wind proportions for this wind direction at the other locations are also low (location 1=0.22 and location 3=0.09) while for location 2 this is the direction with the highest measured wind proportion for the monitoring period (31.68%).

	N		NE		E		SE	
	WT Shelter	Measured Proportion	WT Shelter	Measured Proportion	WT Shelter	Measured Proportion	WT Shelter	Measured Proportion
Location 2	1 (85.5)	1 (1.74)	1 (89.2)	1 (7.22)	1 (134.7)	1 (31.68)	1 (117.2)	1 (5.02)
Location 1	1.24	2.83	1.01	0.90	0.55	0.22	0.82	0.90
Location 3	1.02	8.47	1.33	1.39	0.42	0.09	0.89	0.66
	S		SW		W		NW	
	WT Shelter	Measured Proportion	WT Shelter	Measured Proportion	WT Shelter	Measured Proportion	WT Shelter	Measured Proportion
Location 2	1 (75.5)	1 (2.79)	1 (47.6)	1 (16.26)	1 (94.6)	1 (28.06)	1 (88.0)	1 (7.24)
Location 1	1.07	14.52	2.31	1.53	1.06	0.26	0.70	0.60
Location 3	1.06	11.32	1.95	1.56	1.12	0.31	0.55	0.45

Table 48: Comparison of values from tables 46 and 47 normalised to Location 2

From tables 47 and 48, the following pertinent observations can be made:

- The order of prediction by the WT of the overall average follows the same pattern as that of the measured data, namely that location 2 provides the greatest wind resource, followed by location 1 and then location 3. This suggests that WT simulation may have the potential to be utilised in a combined methodology for identifying optimal hybrid street light locations, however, further research would be required to confirm this potential.
- Shelter is greater for location 2 than either location 1 or 3 for the 3 prevailing wind directions, however, this is compensated for by the acceleration experienced for the E wind direction at this location.
- Taking prevailing wind direction in isolation (W), the WT would not identify the enhanced wind resource available at location 2. This is also true if secondary wind directions (NE and S) are taken into consideration, suggesting that all wind directions should be measured to give an accurate representation of the wind resource for a given location.
- From table 48 it is apparent that when locations 1 and 3 have a normalised factor for either wind shelter or wind power proportion of <1 then the energy yield from wind for the given direction for a wind turbine at these locations would be less than for location 2.

Having identified from monitored data that column location 2 provided the greatest wind energy yield, it was possible to analyse the WT hot-wire results to identify other locations with a similarly enhanced wind resource. Ideally, hot-wire test results from the E wind direction would have been utilised, as this orientation provided the greatest proportion of wind power to this location (31.68%). As these data are not available, the hot-wire test results for the W prevailing wind direction were selected, as, from monitoring, this orientation provided the second highest proportion of wind power available to this location (28.06%). Of the 60 data points tested in the WT, 3 no. showed acceleration at the 10m level (figure 136) greater than that experienced at column location 2 (94.6%) and these areas were also identified through the 5m height test for this wind direction.

	Measurement Height		
	1 m	5 m	10 m
Point 25	99.6%	100.8%	107.8%
Point 24	98.9%	99.1%	101.9%
Point 3	93.7%	94.1%	104.3%

Table 48: Points identified by hot-wire tests for future study

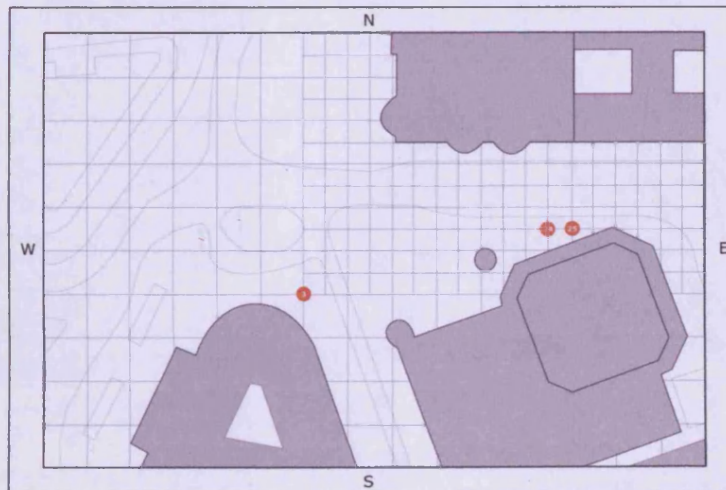

Figure 136: Points identified by hot-wire tests for future study

It is suggested that, in the absence of monitored data at the desired location and height, hot-wire probe tests exploring wind acceleration / shelter would be required for all wind directions, in order to inform any decision as to where to locate a hybrid street light. This decision should also be informed through qualitative interpretation of the urban built form, together with, as a minimum, a wind frequency direction rose for the locality.

CHAPTER 7 – CONCLUSIONS

7.1 Introduction - Review of Work Undertaken

Street lighting has been identified as a significant energy load (and hence source of carbon emissions) for some local authorities in the UK. Standalone hybrid renewable street lighting systems powered by small wind turbines and / or PV panels have been developed to help to reduce the amount of carbon emissions associated with street lighting in rural areas. For the wind component of these systems to work effectively in an urban environment it is necessary to quantify, at a micro-scale, what wind resources are available in these locations at typical street lighting column height (i.e. the potential hub height of a small wind turbine mounted on the column).

This study has considered the potential wind resource available for hybrid renewable energy street lighting systems in an urban environment. A literature review of street lighting standards, urban wind regime, siting guidance for small wind turbines and modelling methods was undertaken, together with a review of current policy development that may support and promote the wider use of such systems in urban locations.

A case study site was selected in Cardiff city centre that provided a range of building heights and urban layout typical of a UK city (i.e. a mixture of street canyons and more open spaces). Wind speed and wind direction data were collected, at 3 locations, for 10 months, at a 10m height, using research grade sensors mounted on existing street lighting columns. Data for these variables was also collected from the roof of a building close to the site to provide a reference. Furthermore, general area data from a number of sources including measured data and modelled data were compared. The data collected from the case study location were used to estimate the energy yields from 12 no. small wind turbines and the results were compared with those of an existing energy yield estimator tool for the same location.

To establish whether points with a greater wind resource than the locations monitored were present at the site, a physical modelling method was used to model the case study location and its surroundings. A 1:200 scale model of the site was constructed and tested in a boundary layer wind tunnel. Hot-wire probes were used to measure the wind speed at points on the model corresponding with those on the site. Then, further points were tested on the model to provide an analysis of the site for points where it had not been possible to deploy wind sensors.

It was found that the wind resource at 10m height in the urban environment, considered in this study would, in some instances, provide a sufficient resource to allow small wind turbines to contribute a significant proportion of the energy required by the hybrid street lighting system (between 25% for a 150W load and 62% for a 60W load for the best performing turbine). However, the annual performance of the turbines would typically be characterised by a low capacity factor (<5%). While some areas of wind acceleration caused by the built form were identified, these did not necessarily coincide with areas suitable for street lighting as identified in the street lighting standards, or for PV because of significant solar shading in these areas. As such, it is the recommendation of this study that hybrid street lighting systems are not located in dense urban areas with their current technology. An analysis was carried out examining the effect of reducing the lamp load of the hybrid street light and this showed that should a more energy efficient lamp, compliant with street lighting standards be developed, then the potential suitability of the hybrid street light for urban environments may be increased.

Further work should focus on the advances made in CFD modelling and low energy lighting since this study was undertaken. The potential of future urban developments to provide a better wind resource to these systems through design could also be examined.

7.2 Conclusions

The main aim of this study was to establish to what extent the wind component of a hybrid renewable energy street lighting system can be effective in an urban environment.

The objectives were as follows:

- To identify the demand for renewable energy in the context of street lighting.
- To establish an understanding of the technical and practical performance requirements of urban street lighting.
- To establish from existing literature factors influencing the urban wind regime.
- To describe the relationship between wind resource and power generation.
- To critically review current literature relating to the siting and energy output of small wind turbines.
- To undertake a case study analysis of an urban environment to characterise the available wind resource.
- To evaluate the potential power contribution for locations in the case study urban environment for a range of commercially available small wind turbines.

For clarity, the responses to these objectives are presented in the following separate sections with the main aim addressed in the final section.

7.2.1 Objective 1: *Identify the demand for renewable energy in the context of street lighting*

A review of the policy literature at different levels of governance was undertaken to establish the demand for renewable energy in the context of street lighting. Street lighting was also identified as a potentially significant energy load (and hence source of carbon emissions) for local authorities in the UK, based on the findings for Cardiff. Current policy at all administrative levels demonstrates an emphasis on increasing the use of renewable energy technology to reduce carbon emissions, as a potential contribution to the mitigation of global climate change. Furthermore, local authorities are willing to install renewable powered street lighting systems provided that they comply with the necessary street lighting standards.

7.2.2 Objective 2: *Establish an understanding of the technical and practical performance requirements of urban street lighting*

A review of the British and European standards for street lighting was carried out. The performance requirements of urban street lighting are well documented and subject to these standards. Currently, the load requirements of street lighting are relatively high due to the lamp technology available and the light output required. However, the load requirements may decrease through developments in emerging low energy lighting technologies such as LEDs. The street lighting standards define the performance required in terms of light output, hours of use, column position and height for a defined class of location. This effectively limits the scope for deployment in the urban environment.

Furthermore, informal meetings were conducted during the study, with the principal engineer at Cardiff Council street lighting department and with a street lighting column manufacturer, in which the practicalities associated with hybrid street lighting were discussed. The most significant finding from these discussions was that there was a necessary limitation on the turbine size deemed acceptable for mounting on a street lighting column, both for aesthetic and technical reasons.

7.2.3 Objective 3: *Establish from existing literature factors influencing the urban wind regime*

A literature review of the current understanding of wind regimes at different climatic scales was carried out to identify the factors influencing wind regime at different scales. Methods for calculating the effect of the large-scale wind regime on small-scale boundary level wind were described. It was found that the main factors influencing wind regime at the micro-scale (that found in the urban environment) were general surface roughness and urban form (obstructions), together with the modifying effect of these factors on the boundary layer (meso-scale) wind regime. A number of methods were identified to characterise the micro-scale wind regime, such as numerical calculation methods (for example, measure-correlate-predict), computational wind engineering analysis and boundary layer wind tunnel modelling. However, limitations were found in all of these methods.

7.2.4 Objective 4: *Describe the relationship between wind resource and power generation*

Estimation of the energy output of small wind turbines can be carried out using a number of established formulae that describe the power provided by the wind and the relationship between the turbine characteristics and this resource. The most common method to describe wind turbine performance is the power curve method, which describes the relationship between wind speed and energy output for a given turbine. While this method allows energy yield to be calculated from a wind speed distribution, there is some energy to suggest that the accuracy of the power curves provided by wind turbine manufacturers may be questionable. Furthermore, there is currently no mandatory standard method for the production of power curves. The use of an inaccurate power curve to calculate turbine energy yield may lead to an over-estimation of yield.

Currently, there is little empirical evidence concerning the performance of free standing (mast-mounted) small wind turbines in urban environments. However, recently, some results for building mounted turbines have been published that suggest that turbines located in urban environments may be characterised by low capacity factors and low energy yield.

7.2.5 Objective 5: *Critically review current literature relating to the siting and energy output of small wind turbines*

There is limited guidance relating to the location of small wind turbines in urban environments. Recent UK studies have focussed on building mounted turbines in urban environments, rather than free standing (mast-mounted) installations. Existing guidance does not, in general, provide detailed quantitative advice, rather 'rules of thumb' that are too simplistic to allow a detailed comparison of urban sites.

Yield estimation tools provide an improvement over the more general guidance, although these too are very limited in their current form. For example, urban locations can only currently be compared at a resolution of 1km², which is inadequate to inform the micro-siting of small turbines located in close proximity (within 30m), such as would be the case in a typical street lighting scheme. Much of the current guidance is focussed on optimal siting, assuming grid connection (i.e. the export of electricity for financial gain), and therefore has a preference for open rural sites. Furthermore, results from field trials suggest that small wind turbines typically perform worse in urban areas compared with rural areas. However, as discussed in this study, for standalone systems with a defined load requirement, non-optimal siting may be adequate to meet the required load.

7.2.6 Objective 6: *Undertake a case study analysis of an urban environment to characterise the available wind resource*

A case study urban environment was identified that served as an example of a typical urban environment found in UK cities. At this location 3 no. street lighting columns were identified that allowed wind data monitoring equipment to be installed. Monitoring was conducted for a period of 10 months. Furthermore, a reliable reference source of high resolution wind data was available in close proximity to the site ($\leq 500\text{m}$). A detailed survey of the site was carried out to establish the urban geometry and from this a 1:200 scale wind tunnel model was constructed. The wind regime at the site was simulated in the wind tunnel and hot-wire and scouring tests were employed to identify areas of wind acceleration and shelter caused by the surrounding urban form.

Sources of measured wind data available for the general area of the site were compared with sources of estimated wind data for the same location. Furthermore, an energy yield prediction tool was identified that allowed some of the site characteristics to be defined, and the results from this tool were compared with monitored data.

7.2.7 Objective 7: Evaluate the potential power contribution for locations in the case study urban environment for a range of commercially available small wind turbines

From a market review, 12 no. small wind turbines were identified that were considered suitable for mounting on street lighting columns, in terms of physical size and energy output, and that were available in the UK. The performance of these turbines was determined by manufacturers' power curve data (in the absence of other empirical performance data). An assessment was made using the monitored wind speed distribution data from the 3 column locations and the reference location, together with the power curves of the turbines, to estimate the energy yields. Furthermore, a comparison was made with an existing energy yield estimation tool using the same power curve data, which showed that the tool could not predict energy yield for turbines in the case study urban environment. The maximum yield estimated from the monitored data was 109.12kWh for a 400W turbine mounted at 10m, representing approximately 25% of the total annual load requirement for the hybrid street light described, assuming a 150W lamp. The impact of reducing the load requirement to a nominal 60W was that the same turbine could provide approximately 60% of the total annual load. This compared with a predicted energy yield of zero kWh per year for the same turbine at the same height, according to the results from the estimation tool, irrespective of load or specific location in the case study urban environment.

It was a finding of this study that wind direction, as represented by a wind frequency direction rose, could be qualitatively linked to urban form through observation. The prevailing wind direction measured at the column location closest to the mouth of the 'canyon' zone appeared to be strongly directional, as a result of the influence of the surrounding urban form. The east / west street configuration appeared to lead to a similar prevailing wind orientation and wind acceleration was evident in the easterly wind direction wind tunnel tests. This coincided with the highest potential wind resource of the 3 column locations monitored, suggesting that to predict wind resource for a specific urban location, monitored wind speed and direction data is required.

It is suggested that wind tunnel modelling has a role in the identification of optimal sites, through the identification of areas of acceleration / shelter, for this monitoring, but not as a substitute for it. The average proportion of acceleration for a range of wind directions, predicted by the wind tunnel, appeared to correlate with the monitored wind power availability at the 3 column locations, suggesting that the wind tunnel may be used to identify optimal locations for monitoring. However, using only the prevailing wind directions from a local monitoring site, the wind tunnel predictions did not correlate with the monitored data from the 3 column locations, suggesting that all wind directions should be simulated in the wind tunnel for a specific point.

7.2.8 Main Aim: *Establish to what extent the wind component of a hybrid renewable energy street lighting system can be effective in an urban environment*

This study has shown that small wind turbines can provide a useful contribution to the load requirements of a hybrid street lighting system when the system is located in an urban area. However, the performance of small turbines located in these areas are characterised by low capacity factors (<10%), and analysis of concurrent 3 day energy yields suggests that there are significant periods when none of the load requirements were met by the turbines identified over the monitoring period.

Existing turbine siting guidance is not focussed on free standing turbines in urban environments or on the concept of non-optimal siting. Rather, that which does exist is focussed on building mounted turbines and cannot effectively differentiate at the micro-scale at near ground level. Furthermore, current modelling tools have not been designed for small turbines in urban environments, rather large commercial wind farms in open terrain and so would require further refinement to account for the complexities of the urban form. A numerical energy yield estimation tool was identified that had been designed for small turbines in urban environments, however, this was found to be significantly inaccurate when compared with measured data.

More energy efficient lighting technology and the associated decrease in load requirements has a large impact on the effectiveness of small wind turbines to contribute to the energy balance of the hybrid street lighting system. At lower load requirements the amount of excess energy generated was increased and therefore there may be an opportunity for grid connection.

A number of wind data sources were found to be available, some of which could provide monthly mean wind speed and direction data and some of which could provide estimates of annual mean wind speed. However, taken in isolation, none of these sources could accurately represent the wind regime at near ground level ($\leq 10\text{m}$) in an urban environment. Through the use of relevant input data and a combination of monitored and simulated wind speed and direction analysis the techniques described in this study could be used to predict areas of the urban environment where the wind regime may be favourable for hybrid renewable energy street lighting systems.

7.3 Limitations and Recommendations for Further Study

The results presented in this study should be regarded as a first order estimate of the contribution that small wind turbines may achieve towards the overall energy balance of a hybrid wind / PV street lighting system in an urban environment.

7.3.1 Limitations

The following points are acknowledged as limitations to this study:

- The turbine power curves used for the analysis were those supplied by the respective turbine manufacturers and problems regarding the accuracy of these have been discussed. Results from other work (e.g. Encraft) suggest that these power curves may be reasonably accurate at low wind speeds but less so at higher wind speeds, leading to a possible over-estimation of energy yield. The impact of these inaccuracies on this study may not be significant because of the generally low wind speeds encountered at the monitoring locations.
- The energy yield calculations do not take into account turbulence that may reduce the energy output from turbines. No allowance was made for the yaw error of the turbines (inability of the turbine to directly follow changes in direction) and the mass of the turbines was not taken into account. Therefore, the energy yield results may be an over-estimation.
- The standard deviation of the wind speed was not recorded for the column monitoring locations or for the WSA weather station. The inclusion of this may have allowed a more detailed analysis and comparison of the wind distributions for each location.
- No allowance was made for the variation in permeability over time of the surrounding vegetation in the WT modelling. This variation would affect the roughness characteristics of the site, with the potential for higher wind speeds in the autumn and winter months when the trees were not in leaf.

7.3.2 Opportunities for Further Study

The following points identify potential opportunities for further study:

- A direct comparison between the monitored site data and the Met Office NCIC wind speed database should the latter data be made available.
- The results of the wind data analysis in this study could be compared with data from other urban below canopy wind turbine sites (should these become available) to establish a weighting for Weibull (k) factor values. This may potentially lead to improved energy yield estimation for wind turbines in urban below canopy locations when used in combination with the turbine power curve.
- Advances in low energy lighting may mean that the load requirements of the hybrid street light can be reduced. Further study could review existing lighting technologies to identify and evaluate potential low energy sources that can meet current street lighting standards.
- CWE is a rapidly developing field with advances in software (CFD tools) and in processing power. It is feasible that such modelling techniques may one day provide a comparable alternative to WT modelling for complex urban environments. Therefore, further work could explore the latest developments in CWE to ascertain whether the potential advantages of these techniques, in terms of time and cost, can be realised.
- The potential for new developments or changes to urban environments to be specifically designed to enhance the wind resource for small wind turbines could be the subject of further work.
- The effects of building-induced urban turbulence on the energy yields from the small wind turbines identified in this study could be further investigated.
- A whole life-cycle assessment of the hybrid street light could be made, in terms of embodied energy and associated carbon emissions, to ascertain the net carbon savings achieved by the system for different wind regimes.

GLOSSARY & ABBREVIATIONS

A	- Ampere or Amp
AC	- Alternating Current
Ah	- Amp-hour
Albedo	- Surface reflectivity integrated over hemisphere and wavelength
AMs	- Assembly Members
AWEA	- American Wind Energy Association
BIS	- Department for Business Innovation and Skills
BLWT	- Boundary Layer Wind Tunnel
BS	- British Standards
BSI	- British Standards Institute
BWEA	- British Wind Energy Association
Candela (cd)	- The measure of luminous intensity of a source in a given direction
CCTV	- Closed Circuit Television
CFD	- Computational Fluid Dynamics
CIE	- Commission Internationale de l'Éclairage
CO₂	- Carbon Dioxide
CRI	- Colour Rendering Index (on a scale of 0 – 100)
DC	- Direct Current
DECC	- Department of Energy and Climate Change
DEFRA	- Department for the Environment Food and Rural Affairs
DESH	- Department for the Environment, Sustainability and Housing
Efficacy	- The effectiveness of a light source in converting electrical energy to lumens of visible light (lumens per watt)
Energy	- Power x Time (measured in Wh)
ETSU	- Energy Technology Support Unit report
EWA	- European Wind Atlas
EWEA	- European Wind Energy Association
Fetch	- The area upwind of a site, over which the air has travelled
HAWT	- Horizontal Axis Wind Turbine
HID	- High Intensity Discharge
HPI	- A quartz metal halide light source (HID)
HPI-T	- A quartz metal halide light source with a tubular (T) fitting
Illuminance	- The luminous power incident per unit area of a surface
IESNA	- Illuminating Engineering Society of North America
ILE	- The Institution of Lighting Engineers
ISA	- International Standard Atmosphere

kW	- Kilowatt
kWh	- Kilowatt Hour
Lamp	- Artificial light source
LDPs	- Local Development Plans
LED	- Light Emitting Diode
Luminaire	- Complete lighting unit (lamp, reflector and housing)
Luminance	- The amount of light leaving a surface in a particular direction (candelas per unit surface area)
Lux (lx)	- Unit of illuminance (1 lux is equal to one lumen per square metre)
MfS	- Manual for Streets
MMLM	- Modified Maximum Likelihood Method
m/s	- Metres per second
NASEG	- National Assembly Sustainable Energy Group
NCIC	- National Climate Information Centre (a wind database)
NGOs	- Non-Governmental Organisations
NOABL	- UK wind speed database
OS	- Ordnance Survey
PCBM	- Phenyl C61 Butyric Acid Methyl Ester (used in polymer based PV)
Power	- Energy / Time (measured in W)
PPW	- Planning Policy Wales
PV	- Photovoltaic
QL	- A brand of induction lamp
Ra	- General colour index
Re	- Reynolds number - gives ratio of inertial forces to viscous forces
RES	- Renewable Energy Strategy
SON	- High pressure sodium light source
SON/T	- High pressure sodium light source with a tubular (T) fitting
SOX	- Low pressure sodium light source
SP	- Strategic Policy
STFC	- Science & Technology Facilities Council
TANs	- Technical Advice Notes
UNFCCC	- United Nations Framework Convention on Climate Change
V	- Volt
VAWT	- Vertical Axis Wind Turbine
W	- Watts
Wp	- Watts peak
WAG	- Welsh Assembly Government

BIBLIOGRAPHY

A

Achberger, C., Ekstrom, M. and Barring, L., *Estimation of local near-surface wind conditions – a comparison of WASP and regression based techniques*, *Meteorological Applications*, Volume 9, pages 211-221 (2002).

Aguilo, A. et al, *Computational Fluid Dynamic Modelling of wind speed enhancement through a building augmented wind concentration system*, Proceedings of the European wind energy conference & exhibition, London, 22–25 November (2004)

Ahmed T, Nishida K, Nakaoka M., *A novel stand-alone induction generator system for AC and DC power applications*, *IEEE Transactions on Industry Applications*, 43, pages 1465–1474 (2007)

Arnold S., et al, *Dispersion of Air Pollution & Penetration into the Local Environment – DAPPLE*, *Science of the Total Environment*, 332, pages 139-153 (2004)

Asimakopoulos, D., *Energy & Climate in the Urban Built Environment*, James & James (2001)

AWEA, *In the Public Interest - How and Why to Permit for Small Wind Systems*, AWEA, September (2008)

Ayotte, K.W., Xu, D. and Taylor, P.A., *The impact of turbulence closure schemes on the predictions of the mixed spectral finite-difference model for flow over topography*, *Boundary-Layer Meteorology*, 68, pages 1-33 (1994)

B

Bahaj, A.S., Myers L., James, P.A.B., *Urban energy generation: Influence of micro-wind turbine output on electricity consumption in buildings*, *Energy and Buildings*, 39, pages 154–165 (2007)

Barlow, J. F. and Belcher, S. E., *A wind tunnel model quantifying fluxes in the urban boundary layer*, *Boundary-Layer Meteorology*, 104, pages 131-150 (2002)

Barlow, J. F., Harman, I. N. and Belcher, S. E., *Scalar fluxes from urban street canyons. Part I. Laboratory simulations. Part II. Model*, *Boundary-Layer Meteorology*, 113, pages 369-410 (2004)

Barnard, J.C., *An evaluation of three models designed for siting wind turbines in areas of complex terrain*, *Solar Energy*, 46 (5) , pages 283-294 (1991)

Basumatary, H., Sreevalsan, E., Sasi, K.K., *Weibull parameter estimation: a comparison of different measures*, *Wind Engineering*, 29 (3), pages 309-315 (2005)

Belcher, S. E., Jerram, N. and Hunt, J. C. R., *Adjustment of a turbulent boundary layer to a canopy of roughness elements*, *Journal of Fluid Mechanics*, 488, pages 369-398 (2003)

Belcher, S.E., Xu, D.P. and Hunt, J.C.R., *The response of the turbulent boundary layer to arbitrarily distributed roughness changes*, *Quarterly Journal of the Royal Meteorological Society*, 116, pages 611-635 (1990)

Beljaars, A.C.M., Walmsley, J.L. and Taylor, P.A., *A mixed spectral finite-difference model for neutrally stratified boundary-layer flow over roughness changes flow over topography*, *Boundary Layer Meteorology*, 38, pages 273-303 (1987)

Best, M. J., *Representing urban areas within operational numerical weather prediction models*, *Boundary Layer Meteorology*, 114, pages 91-109 (2005)

Best, M. J. et al, *Small Scale Wind Technical Report*, Met Office (2008)

- Blackmore, P., *Micro-wind turbines on house roofs*, IP 4-08, BRE, May (2008)
- Brown, H., Hailes, D., Rhodes, M., *Warwick Wind Trials – Final Report*, Encraft (2009)
- BS 5489-1 Code of Practice for the Design of Road Lighting - Part 1 (2003)
- BS 5489-2 Code of Practice for the Design of Road Lighting - Part 2 (2003)
- BS 6399-2 Code of Practice for Wind Loads (1997)
- BS EN 12464 Lighting of Work Places – Outdoor Work Places (2002)
- BS EN 13201-1 Selection of Lighting Classes (2003)
- BS EN 13201-2 Performance Requirements (2003)
- BS EN 13201-3 Calculation of Performance (2003)
- BS EN 13201-4 Methods of Measuring Lighting Performance (2003)
- Building Research Establishment, *Requirements for contractors undertaking the supply, design, installation, set to work commissioning and handover of micro and small wind turbine systems*, Draft 3 of Report MIS 3003 (2007)
- Burch, S.F. and Ravenscroft, F., *Computer Modelling of the UK Wind Energy Resource: Overview Report*, ETSU WN7055 (1992)
- BWEA Small Wind Turbine Performance and Safety Standard*, BWEA, February (2008)

C

- Ca, V. T., Ashie, Y. and Asaeda, T., *A $k-\epsilon$ turbulence closure model for the atmospheric boundary layer including urban*, *Boundary Layer Meteorology*, 102, pages 459-490 (2002)
- Campbell et al, *Wind energy for the built environment (Project WEB)*, Proceedings of the European wind energy conference, Copenhagen, Denmark, July (2001)
- Cardiff Council, *Sustainability Appraisal*, March (2009)
- Carruthers, D.J., Holroyd, R.J., Hunt, J.C.R., Weng, W.-S., Robins, A.G., Apsley, D.D., Thomson, D.J. and Smith, F.B., *UK-ADMS: A new approach to modelling dispersion in the earth's atmospheric boundary layer*, *Journal of Wind Engineering and Industrial Aerodynamics*, 52, pages 139-153 (1994)
- Castro, I.P., Cowan, I.R. and Robins, A.G., *Simulations of flow and dispersion around buildings*, *Journal of Aerospace Engineering*, 12, pages 145-160 (1999)
- Celik, A.N., *A statistical analysis of wind power density based on the Weibull and Rayleigh models at the southern region of Turkey*, *Renewable Energy* 29, pages 593–604 (2003)
- Celik, A.N., *Energy output estimation for small-scale wind power generators using Weibull-representative wind data*, *Journal of Wind Engineering and Industrial Aerodynamics*, 91(5), pages 693–707 (2003)
- Chadee, J.C., Sharma, C., *Wind speed distributions: a new catalogue of defined models*, *Wind Engineering*, 25 (6), pages 319-337 (2001)
- Cheng, H. and Castro, I.P., *Near wall flow over urban-like roughness*, *Boundary-Layer Meteorology*, 104, pages 229-259 (2002)
- Clarke, P. et al, *Estimating the Wind Energy Resource*, Met Office (2008)

Coccal, O. & Belcher, S.E., *A canopy model of mean winds through urban areas*, Quarterly Journal of the Royal Meteorological Society, 130, pages 1349-1372 (2004)

Coccal, O. and Belcher, S. E., *Mean Winds through an Inhomogeneous Urban Canopy*, Boundary-Layer Meteorology, 115, pages 47-68 (2005)

Coccal, O., Thomas, T.G., Castro, I.P. and Belcher, S. E., *Mean flow and turbulence statistics over groups of urban-like cubical obstacles*, Boundary-Layer Meteorology, 121, pages 491-519 (2006)

Cook, N.J., "Discussion on modern estimation of the parameters of the Weibull wind speed distribution for wind speed energy analysis" by J.V. Seguro, T.W. Lambert, Journal of Wind Engineering and Industrial Aerodynamics, 89, pages 867-869 (2001)

Corbus D., Hansen A.C., Minnema J., *Effect of blade torsion on modeling results for the small wind research turbine (SWRT)*, Journal of Solar Energy Engineering, 128, 4, pages 481-486 (2006)

Counihan, J., *Simulation of an Adiabatic Urban Boundary Layer in a Wind Tunnel*, Atmospheric Environment, Volume 7, pages 673-689 (1973)

Counihan, J., Hunt, J.C.R. and Jackson, P.S., *Wakes behind two-dimensional surface obstacles in turbulent boundary layers*, Journal of Fluid Mechanics, 64, pages 529-563 (1974)

Cowan, I.R., Castro, I.P. and Robins, A.G., *Numerical considerations for simulations of flow and dispersion around buildings*, Journal of Wind Engineering and Industrial Aerodynamics, 67 & 68, pages 535-545 (1997)

D

Dalgliesh, W.A., Surry, D., *BLWT, CFD and HAM modelling vs. the real world: Bridging the gaps with full-scale measurements*, Journal of Wind Engineering and Industrial Aerodynamics, 91, pages 1651-1669 (2003)

Dalton G., Lockington D., Baldock T., *Case study feasibility analysis of renewable energy supply options for small to medium-sized tourist accommodations*, Renewable Energy, 34, pages 1134-1144 (2009)

Dannecker R.K.W., Grant, A.D., *Investigations of a building-integrated ducted wind turbine module*, Wind Energy, pages 53-71, May (2002)

Davenport, A.G., *Wind loads on structures*, Technical paper no. 88 of the Division of Building Research, Ottawa, March (1960)

Davidson, M.J., Mylne, K.R., Jones, C.D., Phillips, J.C., Perkins, R.J., Fung, J.C.H. and Hunt, J.C.R., *Plume dispersion through large groups of obstacles – a field investigation*, Atmospheric Environment, 29, pages 3245-3256 (1995)

Davidson, M.J., Snyder, W.H., Lawson, R.E. and Hunt, J.C.R., *Wind tunnel simulations of plume dispersion through groups of obstacles*, Atmospheric Environment, 30, pages 3715-3731 (1996)

Dayan, E., *Small scale, building integrated, wind power systems*, IP12/05, BRE, September (2005)

Deaves, D.M., Lines, I.G., *On the fitting of low mean windspeed data to the Weibull distribution*, Journal of Wind Engineering & Industrial Aerodynamics 66, 169-178 (1997)

De Broe A.M., Drouilhet S., Gevorgian V., *A peak power tracker for small wind turbines in battery charging applications*, IEEE Transactions on Energy Conversion, 14, pages 1630-1635 (1999)

Department of Energy and Climate Change, *The UK Renewable Energy Strategy*, The Stationery Office (2009)

Department for Strategic Planning and Environment, Public Realm Manual Consultation, Cardiff Council, March (2009)

Department of Energy and Climate Change, *The UK Renewable Energy Strategy*, The Stationery Office (2009)

Department of Trade and Industry, *Energy White Paper, Our Energy Future*, The Stationery Office (2003)

Department of Trade and Industry, *Energy White Paper: Meeting the Energy Challenge*, The Stationery Office (2007)

Department of Trade and Industry, *Fact Sheet 8: The UK Wind Resource*, The Stationery Office (2001)

Department for Transport, *Manual for Streets*, Thomas Telford Publishing (2007)

Dobre, A., Arnold, S.J., Smalley, R.J., Boddy, J.W.D., Barlow, J.F., Tomlin A.S. and Belcher, S.E., *Flow field measurements in the proximity of an urban intersection in London*, UK, Atmospheric Environment, 39, pages 4647-4657 (2005)

Dupont, S., Otte, T. L. And Ching, J. K. S., *Simulations of meteorological fields within and above urban and rural canopies with a mesoscale model*, Boundary-Layer Meteorology, 113, pages 111-158 (2004)

Dutton, A.G, et al, *The Feasibility of Building Mounted / Integrated Wind Turbines*, Science & Technology Facilities Council, May (2005)

E

Element Energy Ltd, *The growth potential for Micro-generation in England, Wales and Scotland*, BERR, June (2008)

Elizondo J, Martínez J, Probst O., *Experimental study of a small wind turbine for low- and medium-wind regimes*, International Journal of Energy Research, 33, pages 309-326 (2009)

Energy Savings Trust, Location, Location, Location - Domestic small-scale wind field trial report, EST, July (2009)

European Commission, *2001/77/EC: Renewables Directive*, September (2001)

European Commission, *2002/91/EC: Energy Performance of Buildings*, December (2002)

European Commission, *Renewable Energy Road Map*, January (2007)

F

Faure, X., Sabre, M., Palier, P., *Small wind turbines in urban environment: Qualification steps*, Proceedings of EWEC, Marseilles, 16th - 19th March (2009)

Ferziger J.H., *Approaches to turbulent flow computation: applications to flow over obstacles*, Journal of Wind Engineering and Industrial Aerodynamics, Volume 35, pages 1 - 19, (1990)

Finardi, S., Brusasca, G., Morselli, M.G., Trombetti, F. and Tampieri, F., *Boundary-layer flow over analytical two-dimensional hills: a systematic comparison of different models with wind tunnel data*, Boundary Layer Meteorology, 63, pages 259-291 (1993)

Fisher, B.E.A., Joffre, S., Kukkonen, J., Piringer, M., Rotach, M. and Schatzmann, M., *Meteorology Applied to Urban Air Pollution Problems*. Final Report of COST Action 715, Demetra Ltd Publishers, page 276 (2005)

G

Gailis, R.M. and Hill, A., *A wind-tunnel simulation of plume dispersion within a large array of obstacles*, *Boundary-Layer Meteorology*, 119, pages 289-338 (2006)

Gailis, R.M., Hill, A., Yee, E. and Hilderman, T., *Extension of a fluctuating plume model of tracer dispersion to a sheared boundary layer and to a large array of obstacles*, *Boundary Layer Meteorology*, 122, pages 577-607 (2007)

Gandemer, J., *Wind shelters*, *Journal of Industrial Aerodynamics*, 4, pages 371-389 (1979)

GARCIA, A. *et al.*, *Fitting probability distribution density functions: a case study*. *Solar Energy*, 62, pages 483-93 (1998)

Garratt, J. R., *The Internal Boundary Layer – A Review*, *Boundary-Layer Meteorology*, 50, pages 171-203 (1990)

Gipe, P. *Wind Energy Basics*, Chelsea Green Publishing, 1999

Gipe, P., *Wind Power: Renewable Energy for Home, Farm, and Business* (revised and expanded edition), Chelsea Green Publisher (2004)

Goode, K. & Belcher, S.E., *On the parameterisation of the effective roughness length for momentum transfer over heterogeneous terrain*, *Boundary-Layer Meteorology*, 93, pages 133-154 (1999)

Goulding et al, *Energy Conscious Design*, Batsford, London (1993)

Grant A, Johnstone C, Kelly N. *Urban wind energy conversion: the potential of ducted turbines*, *Renewable Energy*, 33, pages 1157-1163 (2008)

Grimmond, C.S.B. & Oke, T.R., *Aerodynamic properties of urban areas derived from analysis of surface form*, *Journal of Applied Meteorology*, 38, pages 1262-1292 (1999)

Grosso, M., *Urban Form and Renewable Energy Potential*, *Renewable Energy*, 15, pages 331-336 (1998)

Guo, X and Palutikof, JP, *Wind speed prediction methods in complex terrain with a low computing requirement*, Fifth Conference on Mountain Meteorology, June 25-29, 1990, Boulder, Colorado (1990)

H

Harman, I. N., Best, M. J. and Belcher, S. E., *Radiative exchange in an urban street canyon*, *Boundary Layer Meteorology*, 110, pages 301-316 (2004)

Harrison, G.P., Cradden, L.C., Chick, J.P., *Preliminary assessment of climate change impacts on the UK onshore wind energy resource*, Invited paper for Special Issue of 'Energy Sources' on Global Climate Change and Sustainable Energy Development (2007)

Heath, M.A., Walshe, J.D. and Watson S.J., *Estimating the potential yield of small building mounted wind turbines*, *Wind Energy*, 10, pages 271-287 (2007)

Hennessey, J.P., *A comparison of the Weibull and Rayleigh distributions for estimating wind power potential*. *Wind Engineering*, 2, pages 156-64 (1978)

HM Government, *The UK Renewable Energy Strategy*, The Stationery Office (2009)

Hosker, R.P., *Flow and diffusion near obstacles*, Atmospheric Science and Power Production, edited by D. Randerson, US Dept of Energy (1984)

Hu Hu, C., Wang, F., *Using a CFD approach for the study of street-level winds in a built-up area*, Building and Environment, Volume 40, pages 617 – 631 (2005)

Hulme M. & Barrow E., *Climates of the British Isles*, Routledge (1997)

Hunt, J.C.R., Abel, C.J., Peterka, J.A. and Woo H., *Kinematical studies of the flows around free or surface mounted obstacles; applying topology to flow visualisation*, Journal Fluid Mechanics, 86, pages 179-200 (1978)

Hunt, J.C.R., Richards, K.J. and Brighton, P.W.M., *Stably stratified flow over low hills*, Quarterly Journal of the Royal Meteorological Society, 114, pages 859-886 (1988)

Hunt, J.C.R., Leibovich, S. and Richards, K.J., *Turbulent shear flow over hills*, Quarterly Journal of the Royal Meteorological Society, 114, pages 1435-1470 (1988)

Hua, C. and Wang, F., *Using a CFD approach for the study of street-level winds in a built-up area*, Building and Environment, 40, pages 617–631 (2005)

I

ISO 2533:1975 International Standard Atmosphere

J

Jackson, P.S., Hunt J.C.R., *Turbulent Wind Flow Over a Low Hill*, Quarterly Journal of the Royal Meteorological Society, Vol. 101, Issue 430, pages 929 – 955 (1975)

James, P. M., *An objective classification method for Hess and Brezowsky Grosswetterlagen over Europe*, Theoretical and Applied Climatology, 88, pages 17-42 (2007)

Jamil, M. et al., *Wind power statistics and an evaluation of wind energy density*. Renewable Energy, 6 (5-6), pages 623-628 (1995)

Jardine, C., Lane, K., *Photovoltaics in the UK*, ECI, University of Oxford, February (2003)

Jensen, M., *The model-law for phenomena in natural wind*, Ingeniren, International Edition, Volume 2, No. 4 (1958)

Jensen, M., Franck, N., *Model-scale tests in turbulent wind Part II—Wind loads on buildings*, The Danish Technical Press, Copenhagen, page 169 (1965)

Johnson, G.T., Hunter, L.J., *Urban wind flows: wind tunnel and numerical simulations - a preliminary comparison*, Environmental Modelling & Software, 13, pages 279–286 (1998)

Jones, P.M., *The Urban Wind Velocity Profile*, Atmospheric Environment, Volume 5, pages 89-102 (1971)

K

Kastner-Klein, P., Plate, E.J., *Wind-tunnel study of concentration fields in street canyons*, Atmospheric Environment, 33, pages 3973-3979 (1999)

Kastner-Klein, P., Rotach, M.W., *Mean flow and turbulence characteristics in an urban roughness sub-layer*, Boundary Layer Meteorology, 111, pages 55-84 (2004)

Ketzel, M., Louka, P., Sahm, P., Guilloteau, E. and Sini, J.-F., *TRAPOS model comparison study*. Proceedings of the International Workshop on Quality Assurance of Microscale Meteorological Models, edited by M. Schatzmann and R. Britter, COST 732 report, European Science Foundation (2005)

King et al, *40% Efficient Metamorphic GaInP/GaInAs/Ge Multi-junction Solar Cells*, Applied Physics Letters, Volume 90, Issue 18, May (2007)

Kolhe M., Agbossou K., Hamelin J., Bose T.K., *Analytical model for predicting the performance of photovoltaic array coupled with a wind turbine in a stand-alone renewable energy system based on hydrogen*, Renewable Energy, 28, 5, pages 727–742 (2003)

Kondo, H., Genchi, Y., Kikegawa, Y., Ohashi, Y., Yoshikado, H. and Komiyama, H., *Development of a multi-layer urban canopy model for the analysis of energy consumption in a big city: Structure of the urban canopy model and its basic performance*, Boundary Layer Meteorology, 116, pages 395-421 (2005)

Krayenhoff, E. S. and Voogt, J. A., *A microscale three-dimensional urban energy balance model for studying surface temperatures*, Boundary-Layer Meteorology, 123, pages 433-461 (2007)

L

Lagorse, J., Paire, D., Miraoui, A., *Sizing optimization of a stand-alone street lighting system powered by a hybrid system using fuel cell, PV and battery*, Renewable Energy, 34, pages 683–691 (2009)

Landberg, L and Mortensen, NG, *A comparison of physical and statistical methods for estimating the wind resource at a site*, Proceedings of the Fifteenth BWEA Wind Energy Conference, Pitcher, K.F. (ed.), BWEA, London, pages 119-125 (1994)

Landberg, L., Myllerup, L., Rathmann, O., Petersen, E.L., Jorgensen, B.H., Badger, J. and Mortensen, N.G., *Wind resource estimation: an overview*, Wind Energy, Volume 6, pages 261-271 (2003)

Landberg, L, Watson, SJ, *Short-term prediction of local wind conditions*, Boundary Layer Meteorology, 70, pages 171-195 (1994)

Lemonsu, A., Masson, V., *Simulation Of A Summer Urban Breeze Over Paris*, Boundary-Layer Meteorology, 104, pages 463-490 (2002)

Little, A., *Potential Cost Reduction in PV Systems (ETSU S/P2/00320/REP)*, The Stationery Office, page 88 (2002)

Lubitz, W. D., White, B. R. *Atmospheric Boundary Layer Wind Tunnel Applications in Wind Turbine Siting*. Proceedings of World Wind Energy Conference, Beijing, China, Oct. 31 - Nov. 4 (2004)

Lun, I.Y.F., Lam, J.C., *A study of Weibull parameters using long-term wind observations*, Renewable Energy 20, pages 145-153 (2000)

Luo et al, *CIE Activity Report - Division 1: Vision and Colour*, January (2008)

Lyons, T.J., *Meso-scale contribution to available wind power potential*, Solar Energy, 42, pages 483-485 (1989)

M

Macdonald, R. W., *Modelling the Mean Velocity Profile in the Urban Canopy Layer*, Boundary-Layer Meteorology, 97, pages 25-45 (2000)

Macdonald, R.W., Griffiths, R.F. & Hall, D.J., *An improved method for the estimation of surface roughness of obstacle arrays*, Atmospheric Environment, 32, pages 1857-1864 (1998)

Martilli, A., *Numerical study of urban impact on boundary layer structure: sensitivity to wind speed, urban morphology, and rural soil moisture*, Journal of Applied Meteorology, 41, pages 1247-1266 (2002a)

Mascart, P., Noilhan, J., and HGiordani, H., *A modified parameterization of flux-profile relationship in the surface layer using different roughness length values for heat and momentum*, *Boundary-Layer Meteorology*, 72, pages 331-344 (1995)

Masson, V., *A physically-based scheme for the urban energy budget in atmospheric models*, *Boundary-Layer Meteorology*, 94, pages 357-397 (2000)

Matsushima T., Takagi S., Muroyama S., *Characteristics of a highly efficient propeller type small wind turbine with a diffuser*, *Renewable Energy*; 31, 9, pages 1343-1354 (2006)

Mayer et al, *Polymer Based Solar Cells*, *Materials Today*, Volume 10, Issue 11, pages 28-33, November (2007)

Mayer C., Bechly M.E., Hampsey M., Wood D.H., *The starting behaviour of a small horizontal-axis wind turbine*, *Renewable Energy*, 22, 1, pages 411-417 (2001)

Melbourne, W.H., Joubert, P.N., *Problems of wind flow at the base of tall buildings*, *Proceedings of the 3rd International Conference on Wind Effects on Buildings and Structures*, Tokyo, 6th - 9th September, pages 105 - 113 (1971)

Mengelkamp, H.-T., Kapitza, H., Pfluger, U., *Statistical-dynamical downscaling of wind climatologies*, *Journal of Wind Engineering and Industrial Aerodynamics*, 67-68, pages 449-457 (1997)

Meroney, R.N., Leitl, B.N., Rafailidis, S., Schatzmann, M., *Wind-tunnel and numerical modeling of flow and dispersion about several building shapes*, *Journal of Wind Engineering and Industrial Aerodynamics*, 81, pages 333-345 (1999)

Mirecki A., Roboam X., Richardeau F., *Architecture complexity and energy efficiency of small wind turbines*, *IEEE Transactions on Industrial Electronics*, 54, pages 660-670 (2007)

Mochida, A., Lun, I.Y.F., *Prediction of wind environment and thermal comfort at pedestrian level in urban area*, *Journal of Wind Engineering and Industrial Aerodynamics*, 96, pages 1498-1527 (2008)

Morrison, N.L. and Webster, H.N., *An assessment of turbulence profiles in rural and urban environments using local measurements and numerical weather prediction results*, *Boundary Layer Meteorology*, 115, pages 223-239 (2005)

Murakami, S., Ooka, R., Mochida, A., Yoshida, S., Kim, S., *CFD analysis of wind climate from human scale to urban scale*, *Journal of Wind Engineering and Industrial Aerodynamics*, 81, pages 57-81 (1999)

N

Nakamura, Y. and Oke, T.R., *Wind, temperature and stability conditions in an east-west orientated urban canyon*, *Atmospheric Environment*, 22, pages 2691-2700 (1988)

Neff et al, *Upstream and Lateral Wind Turbine Wake Effects on Nearby Wind Turbine Performance*, *Journal of Wind Engineering and Industrial Aerodynamics*, Volume 36, pages 1405 - 1414 (1990)

Nehrir M.H., LaMeres B.J., Venkataramanan G., Gerez V., Alvarado L.A., *An approach to evaluate the general performance of stand-alone wind/photovoltaic generating systems*, *IEEE Transactions on Energy Conversion*, 15, pages 433-439 (2000)

Nuh, D., *Hybrolight ETSU S/P2/00340/REP*, The Stationery Office (2002)

Nuh D., Rhodes, M., *Development of a Small Hybrid PV & Wind Street Lighting System Using a Specifically Designed Computational Sizing Tool*, Proceedings of the PV in Europe: From PV Technology to Energy Solutions Conference, Rome, WIP Renewable Energies (2002)

O

Office of the Deputy Prime Minister, *Companion Guide to Planning Policy Statement 22: Renewable Energy*, HMSO (2004)

Office for National Statistics, *Key Statistics for Urban Areas in England & Wales*, The Stationery Office, (2001)

Oke, T.R., *The distance between canopy and boundary layer urban heat island*, Atmosphere, Volume 14, No. 4, pages 268-277 (1976)

Oke, T.R., *Boundary layer climates*, 2nd edition, Routledge (1987)

Oke, T.R., *Street design and urban canopy layer climate*, Energy and Buildings, Volume 11, pages 103-113 (1988)

Oke, T.R., *Initial Guidance to Obtain Representative Meteorological Observations at Urban Sites*, IOM Report No.81, World Meteorological Organization, Geneva (2006)

Otte, T. L., Lacser, A., Dupont, S. and Ching, J. K. S., *Implementation of an urban canopy parameterisation in a meso-scale meteorological model*, Journal of Applied Meteorology, 43, pages 1648-1665 (2004)

P

Palomino, I., Martin, F., *A simple method for spatial interpolation of the wind in complex terrain*, Journal of Applied Meteorology, 34 (7), pages 678-693 (1995)

Palutikof, J.P., Guo, X. and Halliday, J.A., *Climate variability and the UK wind resource*, Journal of Wind Engineering and Industrial Aerodynamics, 39, pages 243-249 (1992)

Pasqualetti M.J., Gipe P., Richter R.W., *Wind Power in View*, Academic Press (2002)

Pavageau, M., Schatzmann, M., *Wind tunnel measurements of concentration fluctuations in an urban street canyon*, Atmospheric Environment, 33, pages 3961-3971 (1999)

Peacock, A.D. et al, *Micro wind turbines in the UK domestic sector*, Energy and Buildings, Volume 40, , pages 1324 - 1333 (2008)

Pearce, W., Baker, C.J., *Wind tunnel tests on the dispersion of vehicular pollutants in an urban area*, Journal of Wind Engineering and Industrial Aerodynamics, 80, pages 327-349 (1999)

Perera, M.D.A.E.S., *Shelter behind two-dimensional solid and porous fences*, Journal of Wind Engineering and Industrial Aerodynamics, 8, pages 93-104 (1981)

Phillips, R. et al, *Micro-wind turbines in urban environments*, HIS BRE Press (2007)

Phillips (manufacturer), *White Paper: Street Lighting*, June (2007)

Piggot, H., *Choosing Windpower*, Centre for Alternative Technology (2006)

Plate, E.J., Kiefer, H., *Wind loads in urban areas*, Journal of Wind Engineering and Industrial Aerodynamics, Volume 89 (2001)

Pribyl, J., *Roadway Lighting Report*, INDAL Group, December (2007)

Protogeropoulos, C. I., *Autonomous Wind / Solar Power Systems with Battery Storage*, PhD Thesis, UWCC (1992)

Q

R

Rafailidis, S., *Influence of building a real density and roof shape on the wind characteristics above a town*, *Boundary-Layer Meteorology*, 85, pages 255-271 (1997)

Riegler, H., *HAWT versus VAWT*, *REFocus*, July / August, pages 44 – 46 (2003)

Ricciardelli, F., Polimeno, S., *Some characteristics of the wind flow in the lower Urban Boundary Layer*, *Journal of Wind Engineering and Industrial Aerodynamics*, 94, pages 815–832 (2006)

Roedem et al, *National Energy Road Map: CIGS PV*, US Department of Energy, June (2007)

Rotach, M W, *On the influence of the urban roughness sublayer on turbulence and dispersion*, *Atmospheric Environment*, Volume 33, pages 4001-4008 (1999)

Roth M, *Review of atmospheric turbulence over cities*, *Quarterly Journal of the Royal Meteorological Society*, 126, pages 1941-1990 (2000)

Ruddock J., *House of Commons Written Answers*, Vol. 494, Part 95, 19th June (2009)

S

Sahin A.Z., Al-Garni A.Z., Al-Farayedhi A., *Analysis of a small horizontal axis wind turbine performance*, *International Journal of Energy Research*, 25, 6, pages 501–506 (2001)

Santamouris, M. *Energy & Climate in the Urban Built Environment*, James & James (2001)

Savelyev, S. A. and Taylor, P. A., *Notes on Internal Boundary-Layer Height Formula*, *Boundary-Layer Meteorology*, 101, pages 293-301 (2001)

Scharmer K. and Greif J., *European Solar Radiation Atlas*, Ecole des Mines de Paris (1999)

Schiller, S., Evans, J.M., *Training architects and planners to design with urban microclimates*, *Atmospheric Environment*, Volume 30, No. 3, pages 449-454 (1996)

Schmid, H.P., Cleugh, H.A., Grimmond, C.S.B. & Oke, T.R., *Spatial variability of energy fluxes in suburban terrain*, *Boundary-Layer Meteorology*, 54, pages 249-276 (1991)

Seguro, J.V., Lambert, T.W., *Modern estimation of the parameters of the Weibull wind speed distribution for wind energy analysis*, *Journal of Wind Engineering and Industrial Aerodynamics* 85, pages 75-84 (2000)

Sempreviva, Anna Maria, Larsen, S. E., Mortensen, N. G. and Troen, I., *Response of neutral boundary layers to changes of roughness*, *Boundary-Layer Meteorology*, 50, pages 205-225 (1990)

Shockley, W. & Queisser H.J., *Detailed Balance Limit of Efficiency of p-n Junction Solar Cells*, *Journal of Applied Physics*, 32, pages 510-519 (1961)

Sick F. and Erge T., *Photovoltaics in Buildings*, IEA (1996)

Shi J.H., Zhu X.J., Cao G.Y., *Design and techno-economical optimization for stand-alone hybrid power systems with multi-objective evolutionary algorithms*, *International Journal of Energy Research*, 31, pages 315–328 (2007)

Sinden, G., *Wind Power and the UK Wind Resource*, Environmental Change Institute, Oxford University (2005)

Sini, J.-F., Anquetin, S. and Mestayer, P.G., *Pollutant dispersion and thermal effects in urban street canyons*, *Atmospheric Environment*, 30, pages 2659-2677 (1996)

Solazzo, E., Di Sabatino, S. and Britter, R., *Modelling the flow within and above the urban canopy layer*, Proceedings of the 11th International Conference on Harmonisation within Atmospheric Dispersion Modelling for Regulatory Purposes, edited by D.J. Carruthers and C.A. McHugh, Cambridge Environmental Research Consultants (2007)

Stathopoulos T., Baskaran, B.A., *Computer simulation of wind environmental conditions around Buildings*, Engineering Structures, Volume 18, Issue 11, pages 876 – 885, (1996)

Stemmers, K. et al, *Assessing the Potential for Renewable Energy in Cities*, European Commission, July (2000)

Stevens M.J., Smulders P.T., *The estimation of the parameters of the Weibull wind speed distribution for wind energy utilization purposes*, Journal of Wind Engineering and Industrial Aerodynamics 3, pages 132-145 (1979)

Still, D., *Wind Energy 2000*, Professional Engineering Publishing (2000)

Strataridakis et al., *Cross-Correlation of Velocity Measurements for Wind Resource Assessment Over a Large Complex Terrain*, Proceedings of AIAA/ASME Wind Energy Symposium, NV, USA, (2000)

Syngellakis K., Traylor, H., *Urban Wind Resource Assessment in the UK*, European Commission, February (2007)

T

Taylor, G. J., Smith, D. *Wake Measurements Over Complex Terrain*, Proceedings of the 13th BWEA Conference: Wind Energy Conversion 1991, Swansea, UK, April 10th – 12th (1991)

Taylor, P.A., Mason, P.J. and Bradley, E.F., *Boundary-layer flow over low hills*, Boundary Layer Meteorology, 39, pages 107-132 (1987)

The Research Centre, *Cardiff Population Trends 1989 – 2004*, Cardiff Council (2004)

Troen, I. and Petersen, E., *European Wind Atlas*, Risø National Laboratory, Roskilde, Denmark (1989)

Troen, I., *A high resolution spectral model for flow in complex terrain*, Ninth Symposium on Turbulence and Diffusion, April 30 - May 3 1990, Roskilde, Denmark. Preprints, pages 417-420 (1990)

Twidell, J. A., Wier, A.D., *Renewable Energy Resources (2nd edition)*, Taylor & Francis (2006)

U

UKCIP02, *Climate Change Scenarios*, Tyndall & Hadley Centres for UKCIP (2001)

Uehara, K., Murakami, S., Oikawa, S., Wakamatsu, S., *Wind tunnel experiments on how thermal stratification affects flow in and above urban street canyons*, Atmospheric Environment, 34, pages 1553-1562 (2000)

V

Valenciaga F., Puleston P.F., *Supervisor control for a stand-alone hybrid generation system using wind and photovoltaic energy*, IEEE Transactions on Energy Conversion, 20, pages 398-405 (2005)

Van Kuik, G., *The Lanchester-Betz-Joukowski Limit*, Wind Energy, Vol. 10, Issue 3, May/June (2007)

W

- Wai R.J., Lin C.Y., Duan R.Y., Chang Y.R., *High-efficiency power conversion system for kilowatt-level stand-alone generation unit with low input voltage*. IEEE Transactions on Industrial Electronics, 55, pages 3702–3714 (2008)
- Walmsley, J.L., *Internal Boundary-Layer Height Formulae – A Comparison with Atmospheric Data*, Boundary-Layer Meteorology, 47, pages 251-262 (1989)
- Walmsley, J.L., Troen, I., Lalas, D.P. and Mason, P.J., *Surface-layer flow in complex terrain: comparison of models and full-scale observations*, Boundary Layer Meteorology, 52 (3), 259-281(1990)
- Wang C., Nehrir M.H., *Power management of a standalone wind/photovoltaic/fuel cell energy system*, IEEE Transactions on Energy Conversion, 23, pages 957–967 (2008)
- Wang F., Bai L., Fletcher J., Whiteford J., Cullen D., *The methodology for aerodynamic study on a small domestic wind turbine with scoop*, Journal of Wind Engineering and Industrial Aerodynamics; 96, pages 1–24 (2008)
- Wang F., Bai L., Fletcher J., Whiteford J., Cullen D., *Development of small domestic wind turbine with scoop and prediction of its annual power output*, Renewable Energy, 33, pages 1637–1651 (2008)
- Weibull, W., *A statistical distribution function of wide applicability*, Journal of Applied Mechanics, 18, 293-297 (1951)
- Weibull, W., *A statistical distribution function of wide applicability*, Journal of Applied Mechanics, Volume 18, pages 293 – 297 (1951)
- Welsh Assembly Government, *One Wales: A Progressive Agenda for the Government of Wales*, National Assembly for Wales June (2007)
- Welsh Assembly Government, *One Wales: One Planet*, National Assembly for Wales, November (2008)
- Welsh Assembly Government, *Planning Policy Wales*, National Assembly for Wales, March (2002)
- Welsh Assembly Government, *Technical Advice Note 8: Renewable Energy*, National Assembly for Wales, July (2005)
- Wieringa, J., *Roughness-dependent geographical interpolation of surface wind speed averages*, Quarterly Journal of the Royal Meteorological Society, 112, pages 867-889 (1986)
- Wilson, D.J., *Flow patterns over flat-roofed buildings and application to exhaust stack design*, ASHRAE, 85, pages 284-295 (1979)
- Wilson, J. D., *Numerical studies of flow through a windbreak*, Journal of Wind Engineering and Industrial Aerodynamics, 21, pages 119-154 (1985)
- Wilson, J.D., *On the choice of a windbreak porosity profile*, Boundary-Layer Meteorology, 38, pages 37-49 (1987)
- Wong, K. and Dirks, R., *Mesoscale Perturbations on Airflow in the Urban Mixing Layer*, Journal of Applied Meteorology, 17, pages 677-688 (1978)
- Wood, N. and Mason, P.J., *The pressure force induced by neutral, turbulent flow over hills*, Quarterly Journal of the Royal Meteorological Society, 119, pages 1233-1267 (1993)

Woods, J.C., Watson, S.J., *A new matrix method of predicting long-term wind roses with MCP*, Journal of Wind Engineering and Industrial Aerodynamics, 66 (2), pages 85-94 (1997)

Wright A, Wood D., *The starting and low wind speed behaviour of a small horizontal axis wind turbine*, Journal of Wind Engineering & Industrial Aerodynamics, 92, 14, pages 1265-1279 (2004)

X

Xie, X., Liu, C.-H., Leung, D.Y.C. and Leung, M.K.H., *Characteristics of air exchange in a street canyon with ground heating*, Atmospheric Environment, 40, pages 6396-6409 (2006)

Xu, D., Ayotte, K.W. and Taylor, P.A., *Development of a non-linear mixed spectral finite difference model for turbulent boundary layer flow over topography*, Boundary Layer Meteorology, 70, pages 341-367 (1994)

Y

Yang H., Zhou W., Lu L., Fang Z., *Optimal sizing method for stand-alone hybrid solar-wind system with LPSP technology by using genetic algorithm*, Solar Energy, 82, pages 354-367 (2008)

Yee, E., Gailis, R.M., Hill, A., Hilderman, T., and Kiel, D., *Comparison of wind-tunnel and water channel simulations of plume dispersion through a large array of obstacles with a scaled field experiment*, Boundary Layer Meteorology, 121, pages 389-432 (2007)

York et al, *Manual for Streets: Evidence and Research*, Transport Research Laboratory (2007)

Yu, W., Benoit, R., Girard, C., Glazer, A., Lemarquis, D., Salmon, J. R., Pinard, J.-P., *Wind Energy Simulation Toolkit (WEST): A Wind Mapping System for Use by the Wind Energy Industry*, Wind Engineering, 30, pages 15-33 (2006)

Z

Zaphiropoulos, Y., Dellaportas, P., Morfiadakis, E., Glinou, G., *Prediction of wind speed and direction at a potential site*, Wind Engineering, 23 (3), pages 167-175 (1999)

WEBSITES

Action Energy:	www.actionenergy.org.uk
American Wind Energy Association:	www.awea.org
Association of Electricity Producers:	www.aepuk.com
BBC News:	news.bbc.co.uk
British Wind Energy Association	www.bwea.com
Carbon Trust:	www.thecarbontrust.co.uk
Cardiff Council:	www.cardiff.gov.uk
CU Phosco:	www.cuphosco.com
DAPPLE:	www.dapple.org.uk
DECC:	www.decc.gov.uk
DEFRA:	www.defra.gov.uk
DTI:	www.dti.gov.uk
EERE:	www1.eere.energy.gov
Energy Information Administration:	www.eia.doe.gov
Energy Networks Association:	www.energynetworks.org
Energy Savings Trust:	www.est.org.uk
European Wind Energy Association	www.ewea.org
European Union:	europa.eu
Institute of Lighting Engineers:	www.ile.org.uk
International Solar Energy Society:	www.ises.org
Kyoto Protocol:	unfccc.int/Kyoto_protocol
Lamptech	www.lamptech.co.uk
Lighting Reality	www.lightingreality.co.uk
Marlec Turbines:	www.marlec.co.uk
Met Office:	www.metoffice.gov.uk
NASEG:	www.naseg.co.uk
North American Space Agency:	www.nasa.com
Office of the Deputy Prime Minister:	www.odpm.gov.uk
Ordnance Survey:	www.ordnancesurvey.co.uk
UNFCCC:	www.unfccc.int
Urbis Lighting	www.urbislighting.com
Welsh Assembly Government:	wales.gov.uk
Windfinder:	www.windfinder.com
Windworks:	www.wind-works.org

The web addresses for specific turbine manufacturers are provided in Appendix D.

APPENDICES – Data CD

The attached CD contains the appendices in Microsoft Word format together with data files in Microsoft Excel format and site photographs as jpeg images.



APPENDIX G - Pull-out Site Location Plan

A pull-out site location plan, showing the monitoring locations, is provided to aid in the interpretation of the results.

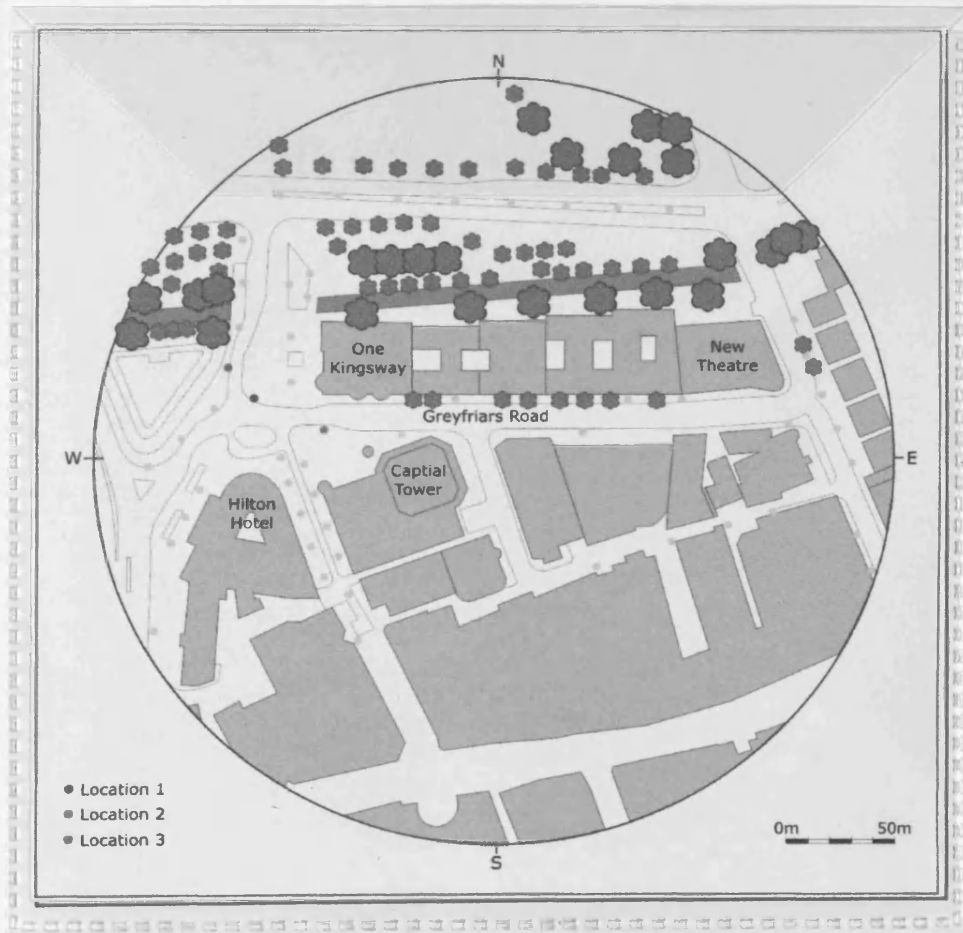

NOTES